

PROFESSIONAL AUDIO MIXING CONSOLE *PM1800*

SERVICE MANUAL

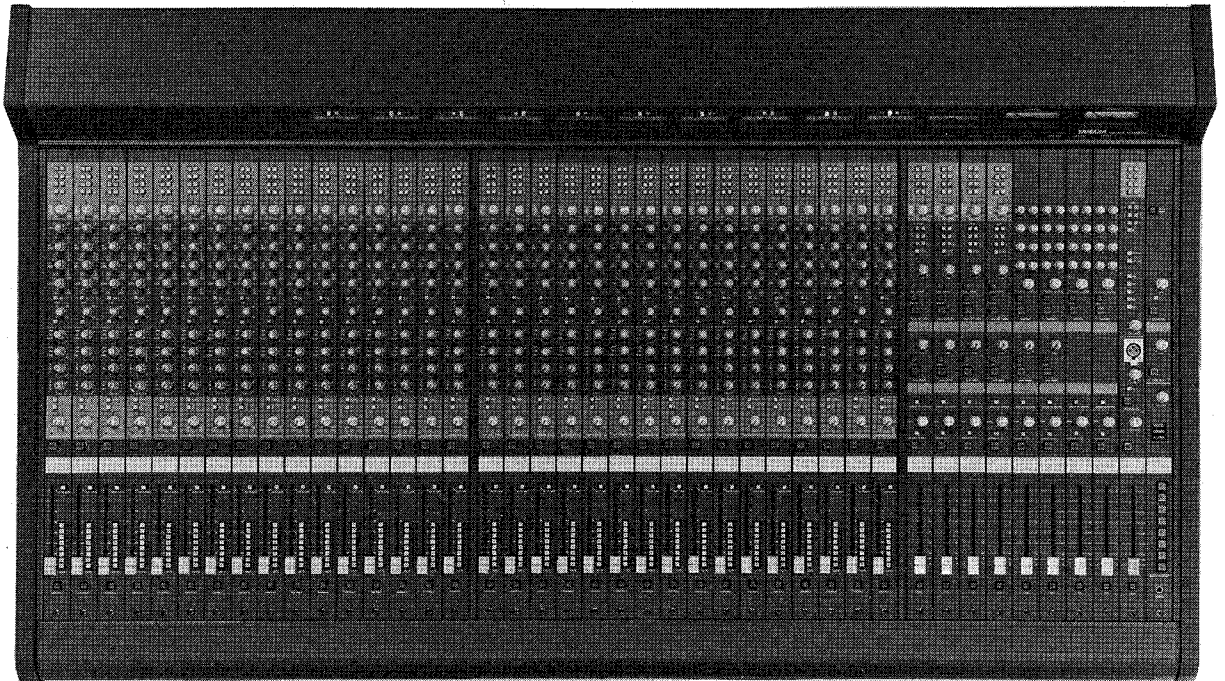

PM1800-40CH

006754

SINCE 1887



YAMAHA

NIPPON GAKKI CO., LTD. HAMAMATSU, JAPAN

2.2K-048 (P) Printed in Japan '87.7

■ CONTENTS

SPECIFICATIONS	2
1. GENERAL SPEC. & DIMENSION	
2. POWER SUPPLY SPEC. & DIMENSION	
3. INPUT CHARACTERISTICS	
4. OUTPUT CHARACTERISTICS	
5. BLOCK & GAIN STRUCTURE DIAGRAMS	
PANEL LAYOUT	12
OPTIONAL FUNCTIONS	18
METER LAMP REPLACEMENT	23
ADJUSTMENTS	24
CIRCUIT BOARDS	26
PARTS LIST	

IMPORTANT NOTICE

This manual has been provided for the use of authorized Yamaha Retailers and their service personnel. It has been assumed that basic service procedures inherent to the industry, and more specifically Yamaha Products, are already known and understood by the users, and have therefore not been restated.

WARNING: Failure to follow appropriate service and safety procedures when servicing this product may result in personal injury, destruction of expensive components and failure of the product to perform as specified. For these reasons, we advise all Yamaha product owners that all service required should be performed by an authorized Yamaha Retailer or the appointed service representative.

IMPORTANT: The presentation or sale of this manual to any individual or firm does not constitute authorization, certification, recognition of any applicable technical capabilities, or establish a principal-agent relationship of any form.

The data provided is believed to be accurate and applicable to the unit/s indicated on the cover. The research, engineering, and service departments of Yamaha are continually striving to improve Yamaha products. Modifications are, therefore, inevitable and changes in specification are subject to change without notice or obligation to retrofit. Should any discrepancy appear to exist, please contact the distributor's Service Division.

WARNING: Static discharges can destroy expensive components. Discharge any static electricity your body may have accumulated by grounding yourself to the ground buss in the unit (heavy gauge black wires connect to this buss).

IMPORTANT: Turn the unit OFF during disassembly and parts replacement. Recheck all work before you apply power to the unit.

■ SPECIFICATIONS

1 GENERAL SPECIFICATIONS

Total Harmonic Distortion

Less than 0.1%, 20 Hz - 20 kHz, at +14 dBm output into 600 ohms.

Frequency Response

+1, -3 dB, 20 Hz - 20 kHz, at +4 dBm output into 600 ohms.

Hum & Noise

(20 Hz - 20 kHz, *Rs = 150 ohms, Input Pad @0 dB, Input Sensitivity @-60 dB, except as noted)

- 128 dBm equivalent input noise
- 93 dBu residual output noise (balanced outputs)
- 74 dBu at GROUP OUT with Master fader at nominal level and all channel assign switches off
- 64 dBu (68 dB S/N) at GROUP OUT with Master fader and one channel fader at nominal level, and channel assigned to the group bus
- 82 dBu at STEREO OUT with Stereo Master fader at nominal level and all channel assign switches off
- 74 dBu (78 dB S/N) at STEREO OUT with Stereo Master fader and Group Master fader at nominal level, and one GROUP-TO-STEREO switch on
- 84 dBu at MATRIX OUT with MATRIX MASTER at nominal level and all matrix mix controls at maximum level, all GROUP-TO-MATRIX switches off
- 70 dBu (74 dB S/N) at MATRIX OUT with MATRIX MASTER at nominal level, one Matrix Mix control at maximum level, one channel fader at nominal level, and the corresponding assigned group fader at nominal level and GROUP-TO-MATRIX switch on
- 65 dBu at AUX OUT with Aux Master level control at nominal, all channel AUX mix controls at minimum level (Pre/Off/Post switches Off)
- 63 dBu (67 dB S/N) at AUX OUT with Aux Master level and one channel AUX mix control at nominal level (PRE/OFF/POST switch in PRE position)

Maximum Voltage Gain

- 84 dB CH IN to GROUP OUT
- 94 dB CH IN to STEREO OUT
- 94 dB CH IN to MATRIX OUT
- 94 dB CH IN to AUX OUT
- 74 dB CH IN to CUE OUT
- 20 dB AUX RTN to GROUP OUT
- 10 dB SUB IN to GROUP OUT
- 10 dB SUB IN to AUX OUT

Input Channel Gain Control

34 dB variation in gain stop-to-stop.

Input Channel Pad Switch

0, 20, 40 dB of attenuation.

Input Channel Equalization

15 dB maximum boost or cut in the each of four bands
HIGH: 1.6 kHz ~ 16 kHz (shelving)

HI-MID: 800 Hz ~ 8 kHz (peaking)
LO-MID: 160 Hz ~ 1.6 kHz (peaking)
LOW: 40 Hz ~ 400 Hz (shelving)

Input Channel High Pass Filter

12 dB/octave roll off below 20 Hz ~ 400 Hz (adjustable -3 dB point)

Crosstalk

-60 dB at 1 kHz

Oscillator/Noise Generator

Switchable sine wave at 100 Hz, 1 kHz, or 10 kHz (less than 1% T.H.D. at +4 dBu output level), or pink noise.

VU Meters

STEREO L & R: 2 large, illuminated meters with Peak LEDs. Other meters are smaller size without Peak LEDs. All meters calibrated for 0 VU = +4 dBu = 1.23 Vrms output; Peak LEDs turn on 10 dB before clipping

16 channel console:

Meters 1 - 4	GROUP/MATRIX/AUX
Meter 5	GROUP 5/CUE L/AUX 5
Meter 6	GROUP 6/CUE R/AUX 6
Meter 7	GROUP 7/OSC
Meter 8	GROUP 8
Meter 9	STEREO L
Meter 10	STEREO R

24, 32 or 40 channel consoles

Meters 1 - 4	GROUP/MATRIX
Meter 5	GROUP 5/AUX 1
Meter 6	GROUP 6/AUX 2
Meter 7	GROUP 7/AUX 3
Meter 8	GROUP 8/AUX 4
Meter 9	CUE L/AUX 5
Meter 10	CUE R/AUX 6
Meter 11	OSC
Meter 12	STEREO L
Meter 13	STEREO R

Signal/Clip indicators

2 LEDs built into each input module monitor levels in the module: CLIP (red) turns on when pre-EQ signal is 3 dB below clipping. EQ CLIP (red) turns on when post-EQ level is 3 dB below clipping.

Phantom Power

48 V DC is applied to electronically balanced inputs or optional transformer-isolated inputs (via 6.8 kohm current limiting/isolation resistors) for powering condenser microphones. May be turned on or off via rear-panel phantom master switch; when on, individual channels may be turned off via +48 V switch on each input module.

Options

IT1800 Input Transformers; may be installed in individual input modules. Changes actual input impedance from 3K ohms to 1K ohm.

OT1800 Set of 4 output transformers, or OT3000 Set of 8 output transformers in rack-mountable external

chassis with male and female XLR connectors on the front panel. Occupies 2 rack spaces (3-1/2" or 88 mm) in a 19" (480 mm) wide rack; 3-1/2" (88 mm) depth. May be used to isolate any PM1800 XLR outputs.

Miniature lamps on flexible supports to mate with 4-pin XLR sockets in console; 2 sockets for 16 CH, 3 sockets for 24 or 32 CH, 4 sockets for 40 CH console.

Dust cover

Power Requirements

Requires Yamaha PW1800 power supply; see specifications for that unit.

Console Dimensions

HEIGHT	12-7/8 inches (307 mm)
DEPTH	34 inches (865 mm)
WIDTH:	16 channel, 39-1/2 inches (1003 mm)
	24 channel, 50-3/4 inches (1290 mm)
	32 channel, 62-1/8 inches (1578 mm)
	40 channel, 73 inches (1854 mm)

Net Weight (excl. power supply)

<u>16 CH</u>	<u>24 CH</u>	<u>32 CH</u>	<u>40 CH</u>
125.7 lbs	161 lbs	194 lbs	224.9 lbs
57 kg	73 kg	88 kg	102 kg

NOTE:

0 dBu is referenced to 0.775 Vrms. 0 dBm is referenced to 1 milliwatt. Specifications are subject to change without notice or obligation.

* "Brick wall" 20 kHz bandwidth equivalent filter obtained by using 6 dB/octave low pass filter at 12.7 kHz.

PM1800

• DIMENSIONS

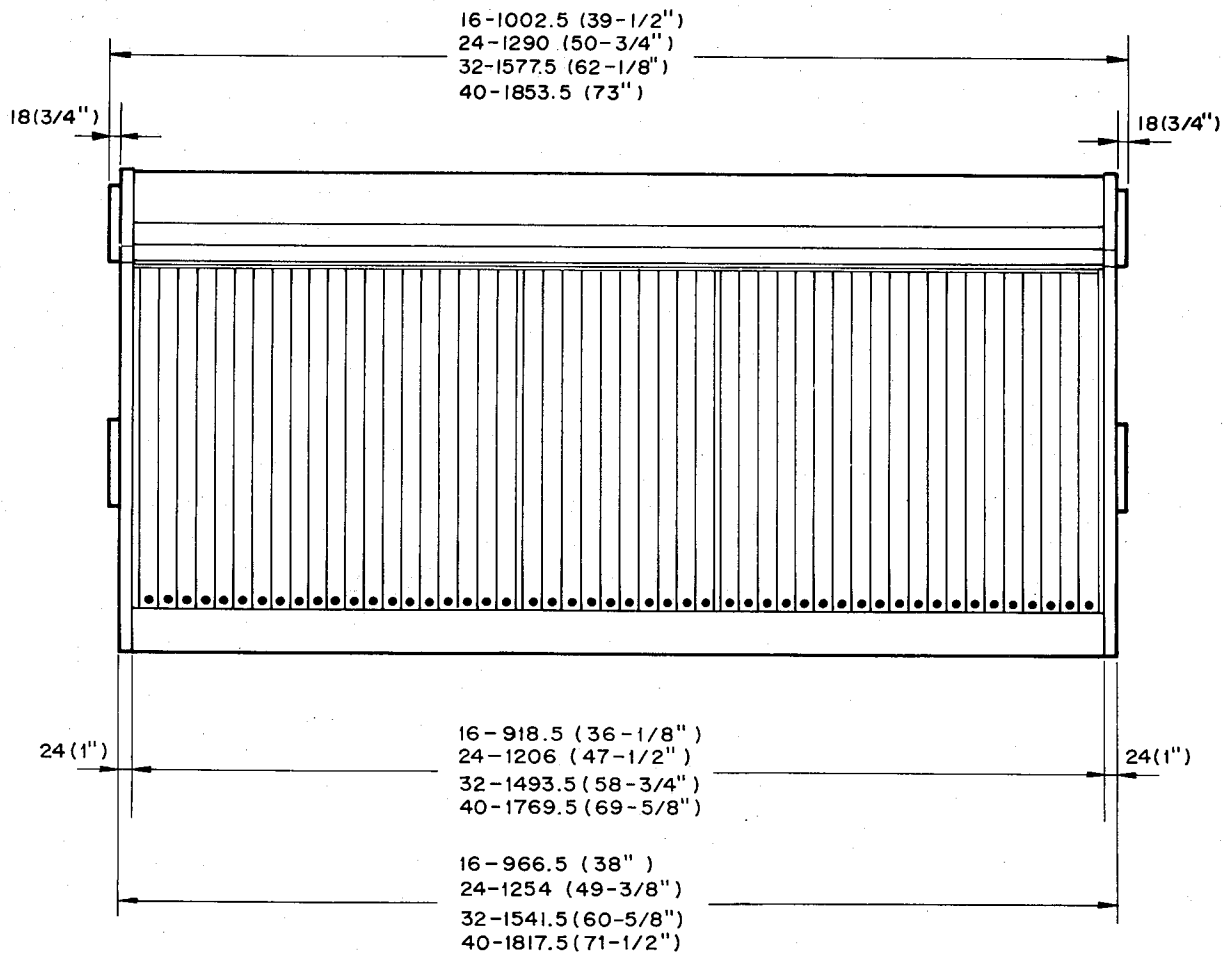
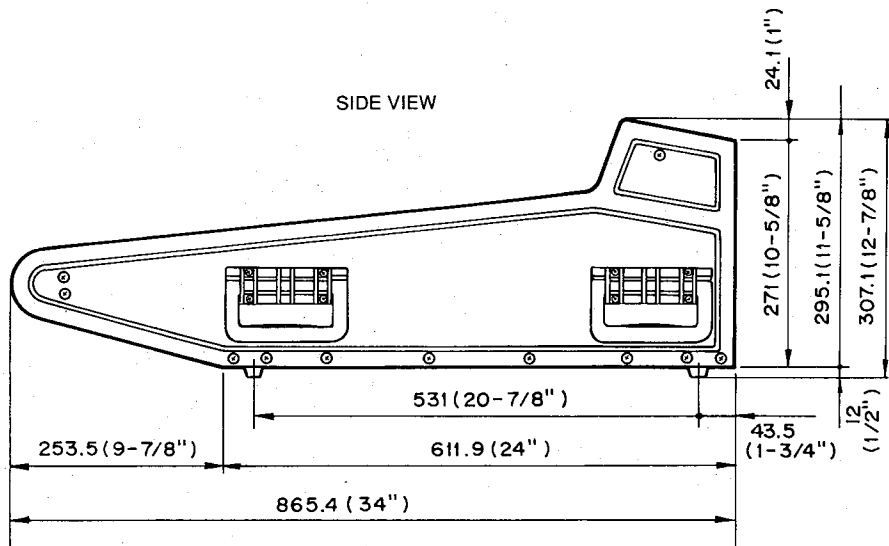

PM1800 DIMENSIONS

PM1800

2 POWER SUPPLY (PW1800) SPECIFICATIONS

Dimensions

- HEIGHT 5-1/4 inches (132 mm) (excluding rubber feet; add 7/16" (10.5 mm) for feet).
- DEPTH Overall, 16-7/8 inches (429.2 mm); Behind panel, 15- 1/2 inches (394 mm).
- WIDTH 18-7/8 inches (480 mm); for standard rack mounting.

Net Weight

35.3 pounds (16 kg).

Fuse

Primary fuse 7 amp, slo-blow.

AC Requirements

U.S.A./Canada models: 105 to 130 V, 50/60 Hz. General Export models: 220 or 240 V, $\pm 10\%$, 50/60 Hz.

Umbilical Cable

Multi-conductor cable with locking, multi-pin connector conveys power to the PM1800 console. Cable is approximately 10 feet (3.6 meters) long.

Cooling

Internal fan, pulls air through foam grille on front panel, exhausts via top and side vents.

NOTE:

Specifications are subject to change without notice or obligation.

PM1800

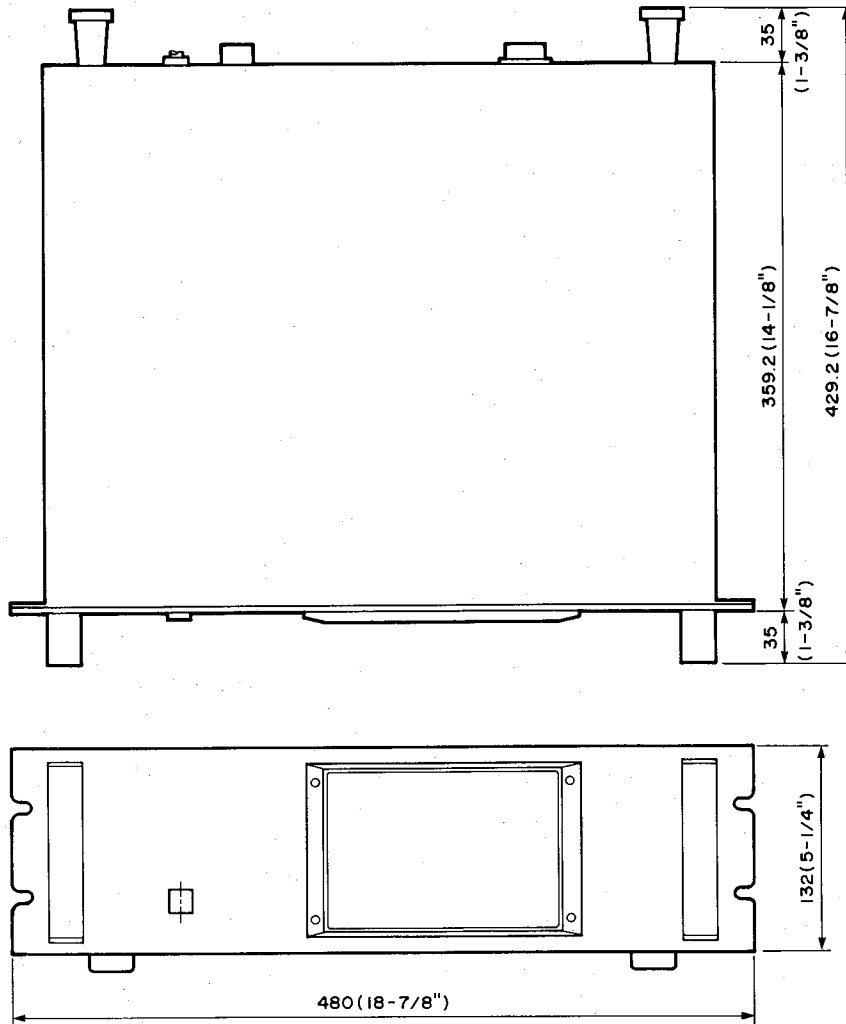

PW1800 DIMENSIONS

3 INPUT CHARACTERISTICS

CONNECTION	PAD	GAIN TRIM	ACTUAL LOAD IMPEDANCE	FOR USE WITH NOMINAL	INPUT LEVEL			CONNECTOR IN CONSOLE
					SENSITIVITY	NOMINAL	MAX. BEFORE CLIP	
CH INPUT, 1-16, 1-24, 1-32, or 1-40	0	-60	3K ohms if electronic balanced; 1K ohms if transformer balanced	50 ohm to 600 ohm mics and 600 ohm lines	-80 dBu (0.075 mV)	-60 dBu (0.75 mV)	-34 dBu (1.75 mV)	XLR-3-31 type
	0	-26			-46 dBu (3.88 mV)	-26 dBu (38.8 mV)	0 dBu (755 mV)	
	20	-26			-26 dBu (38.8 mV)	-6 dBu (388 mV)	+20 dBu (7.75 V)	
	40	-26			-6 dBu (388 mV)	+14 dBu (3.88 V)	+24 dBu (12.3 V)	
AUX RETURN, 1-4 (stereo)			10Kohms	600 ohm lines	-16 dBu (123 mV)	+4 dBu (1.23 V)	+24 dBu (12.3 V)	XLR-3-31 type
SUB IN: GROUP 1-8 AUX 1-6 CUE			10K ohms	600 ohm lines	-6 dBu (388 mV)	+4 dBu (1.23 V)	+24 dBu (12.3 V)	XLR-3-31
			10K ohms	600 ohm lines	-6 dBu (388 mV)	+4 dBu (1.23 V)	+24 dBu (12.3 V)	**
			47K ohms	600 ohm lines	-6 dBu (388 mV)	+4 dBu (1.23 V)	+24 dBu (12.3 V)	Phone jack (TRS)
TALKBACK IN	-50		3K ohms	50-600 ohm mics	-70 dBu (0.25 mV)	-50 dBu (2.45 mV)	-24 dBu (48.9 mV)	XLR-3-31 type
	+4		3K ohms	600 ohm lines	-16 dBu (123 mV)	+4 dBu (1.23 V)	+24 dBu (12.3 V)	
COMM IN	-50		3K ohms	50-250 ohm mics	-70 dBu (0.25 mV)	-50 dBu (2.45 mV)	-24 dBu (48.9 mV)	XLR-3-31 type
	+4		3K ohms	600 ohm lines	-16 dBu (123 mV)	+4 dBu (1.23 V)	+24 dBu (12.3 V)	
INSERT IN: CH1-16 thru 40 GROUP 1-8 AUX 1-6			10K ohms	600 ohm lines	-16 dBu (123 mV)	-6 dBu (388 mV)	+20 dBu (7.75 V)	Phone Jack (TRS)

NOTES: 1) Sensitivity is the lowest level that will produce an output of +4 dBu (1.23V), or the nominal output level, when the circuit is set to maximum gain.

2) All XLR connectors are electronically balanced, phone jacks are unbalanced (except as noted).

** Balanced TRS Phone Jack in 16 channel console, XLR-3-31 type in 24, 32 or 40 channel consoles.

4 OUTPUT CHARACTERISTICS

CONNECTION	ACTUAL SOURCE IMPEDANCE	FOR USE WITH NOMINAL	OUTPUT LEVEL		CONNECTOR IN CONSOLE
			NOMINAL	MAX. BEFORE CLIP	
GROUP OUT, 1-8	150 ohms	600 ohm lines	+4 dBu (1.23 V)	+24 dBu (12.3 V)	XLR-3-32 type
STEREO OUT, L-R	150 ohms	600 ohm lines	+4 dBu (1.23 V)	+24 dBu (12.3 V)	XLR-3-32 type
MATRIX OUT, 1-4	150 ohms	600 ohm lines	+4 dBu (1.23 V)	+24 dBu (12.3 V)	XLR-3-32 type
AUX OUT, 1-6	150 ohms	600 ohm lines	+4 dBu (1.23 V)	+24 dBu (12.3 V)	XLR-3-32 type
CUE OUT, L-R	150 ohms	600 ohm lines	+4 dBu (1.23 V)	+20 dBu (7.75 V)	Phone Jack (TRS)
OSC OUT	150 ohms	600 ohm lines	+4 dBu (1.23 V)	+24 dBu (12.3 V)	XLR-3-32 type
TALKBACK OUT	150 ohms	600 ohm lines	+4 dBu (1.23 V)	+24 dBu (12.3 V)	XLR-3-32 type
INSERT OUT (1-16, 1-24, 1-32 or 1-40)	600 ohms	10K ohm lines	-6 dBu (388 mV)	+20 dBu (7.75 V)	Phone Jack
GROUP 1-8, AUX 1-6	600 ohms	10K ohm lines	-6 dBu (388 mV)	+20 dBu (7.75 V)	Phone Jack
PHONES OUT	15 ohms	8 ohm phones	75 mW	150 mW	Phone Jack (TRS)
		40 ohm phones	65 mW	130 mW	(Stereo Wired)

NOTES: 1) All XLR connectors are electronically balanced. Phones jacks outputs are unbalanced.

5. BLOCK & GAIN STRUCTURE DIAGRAMS

PM1800

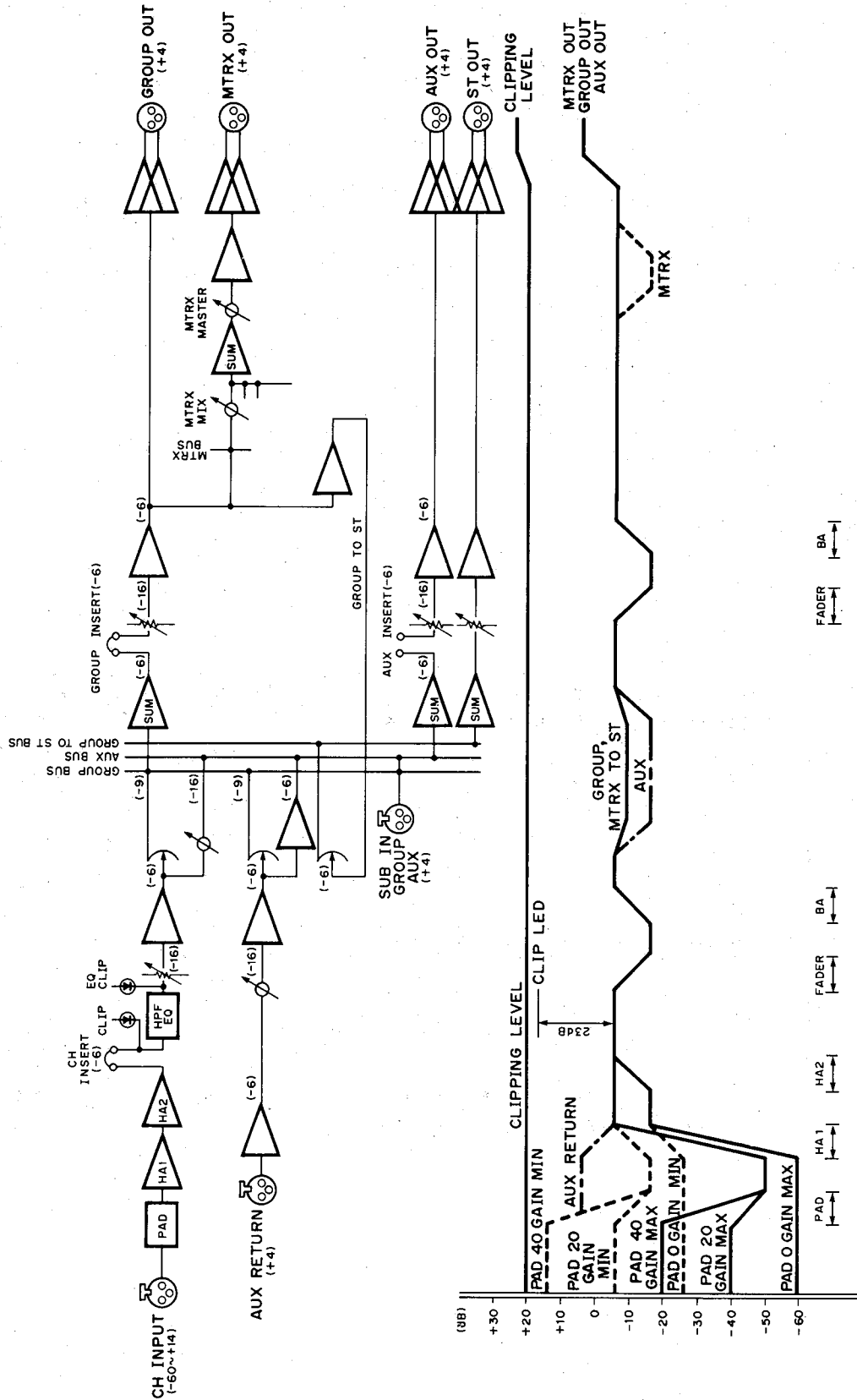

PM1800 GAIN STRUCTURE

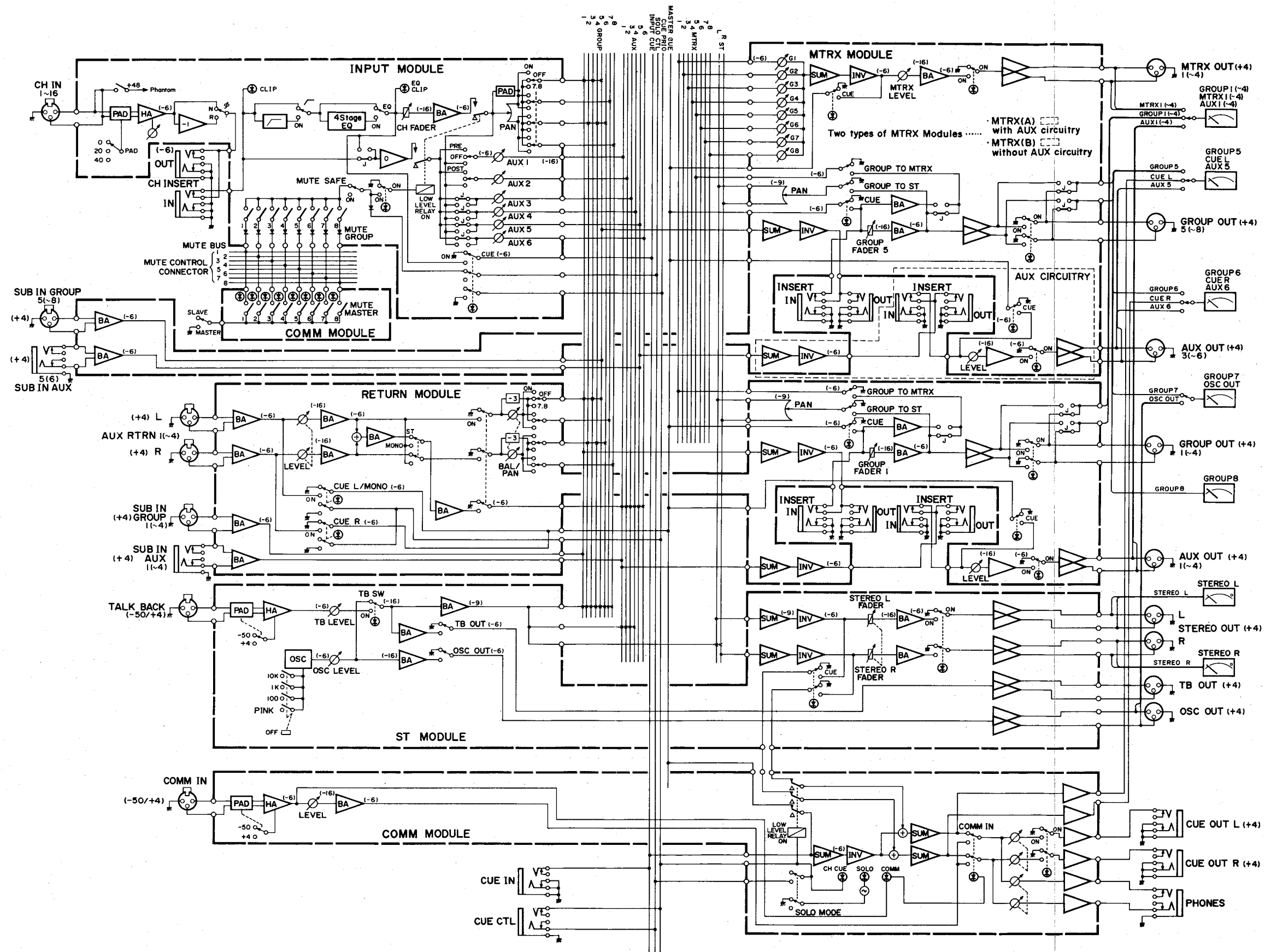

SIGNAL FLOW for PM1800-16 (BLOCK DIAGRAM)

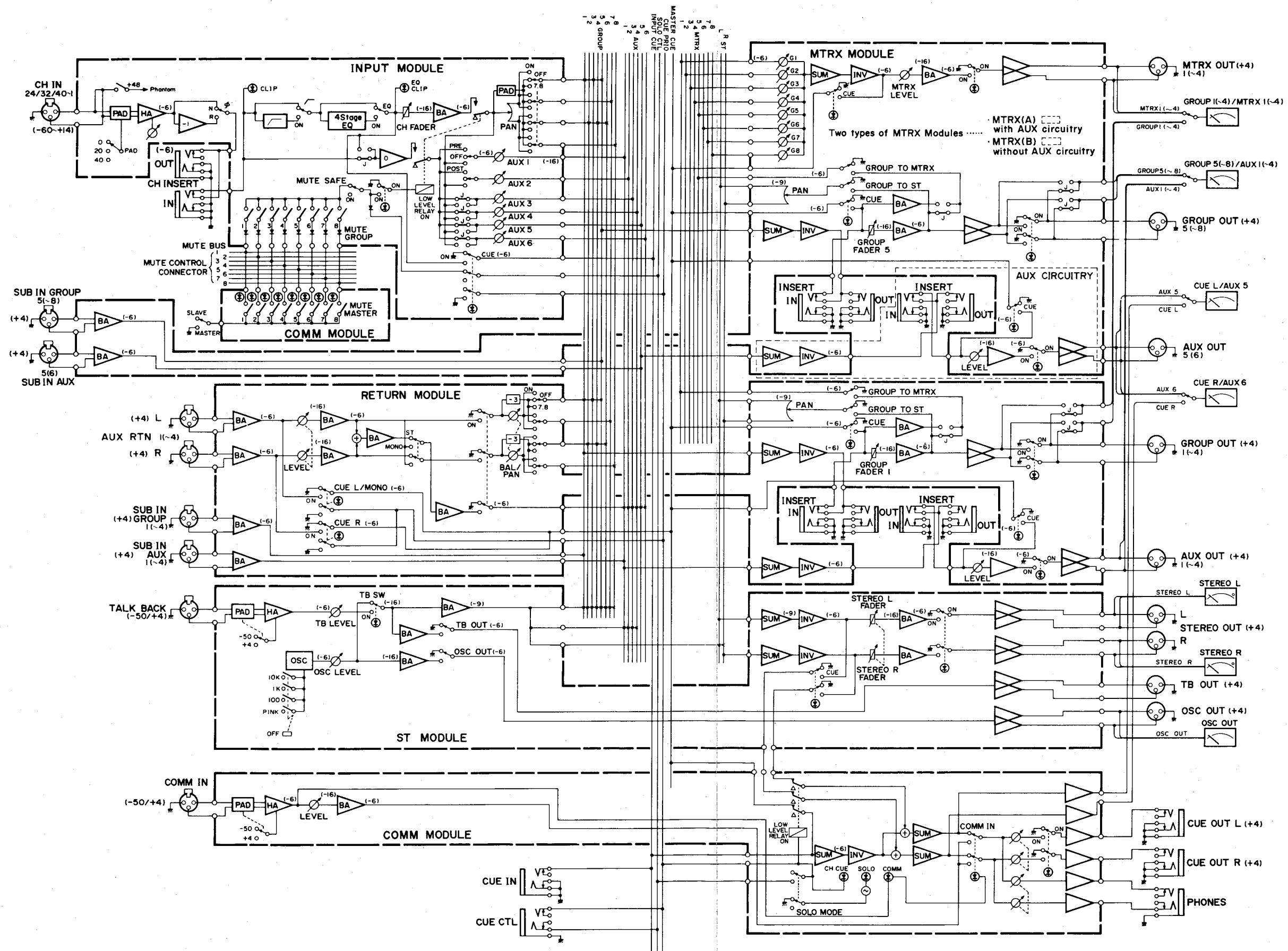

SIGNAL FLOW for PM1800 24, 32, 40C (BLOCK DIAGRAM)

PM1800

■ PANEL LAYOUT

● FRONT PANEL

PM1800 INPUT MODULE (IP1800)

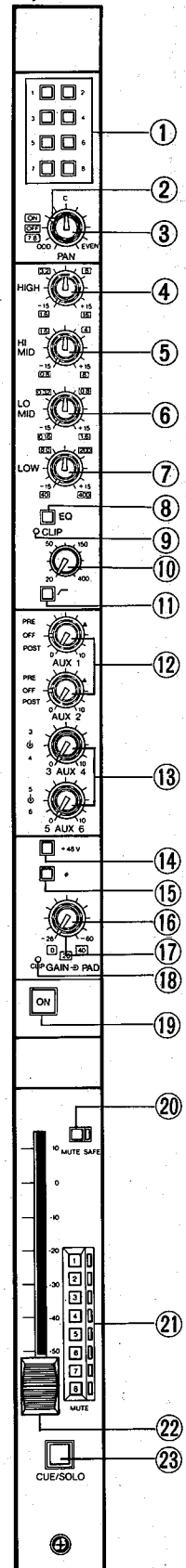

PM1800 GROUP 1 MODULE (RT1800)
TYPICAL OF 1-4

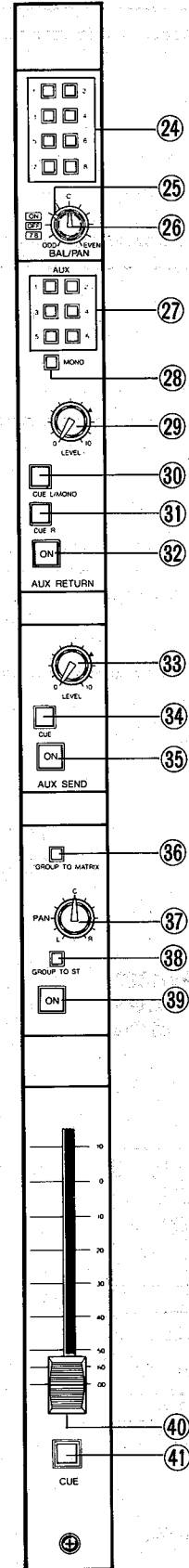

PM1800 GROUP 5 MODULE (MT1800A), TYPICAL OF 5 & 6;
PM1800 GROUP 7 MODULE (MT1800B), TYPICAL OF 7 & 8

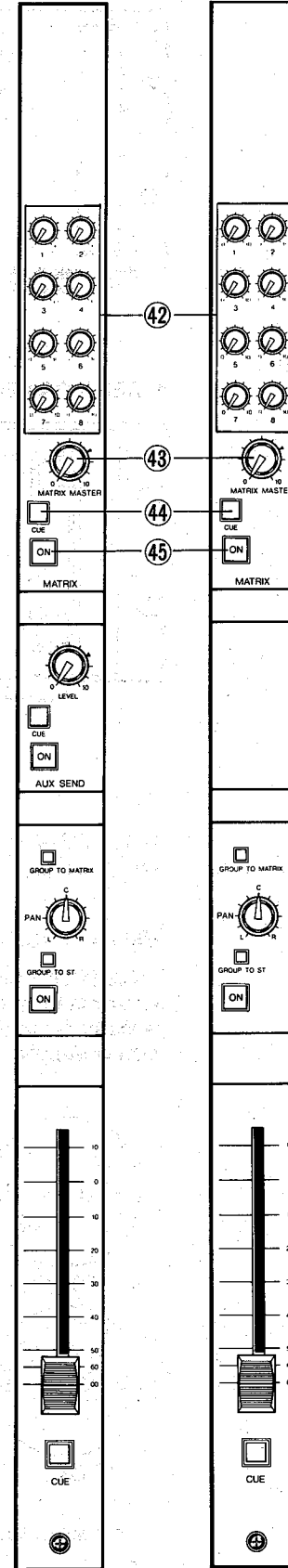

PM1800 STEREO MODULE (ST1800)

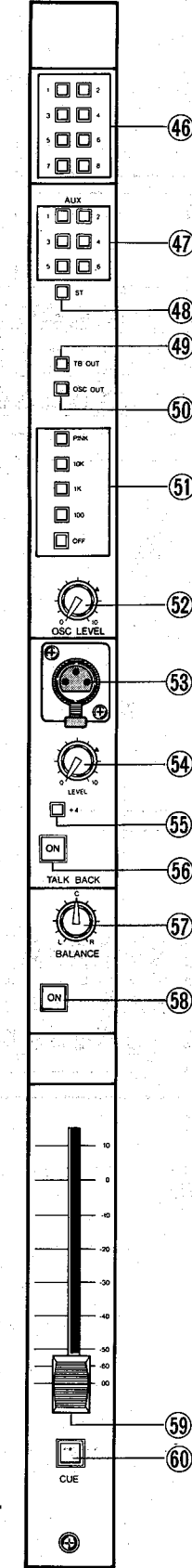

PM1800 COMM MODULE (COM1800)

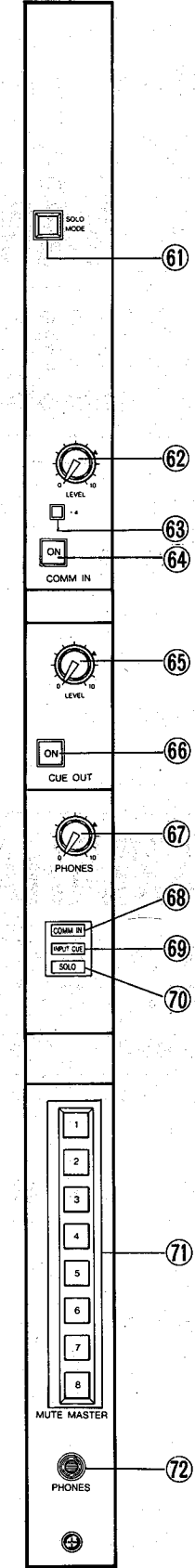

1. 1 2 3 4 5 6 7 8 (Assign)
2. ON/OFF/7-8 (Switch)
3. PAN (Pot)
4. HIGH
1.6~16kHz
+~-15dB
5. HIGH-MID
0.8~8kHz
+15~-15dB
6. LOW-MID
0.16~1.6kHz
+15~-15dB
7. LOW
40~400kHz
+15~-15dB
8. EQ (In/Out switch)
9. EQ CLIP
10. 20~400Hz (H.P. filter)
11. (H.P. filter In/Out switch)
12. AUX1, AUX2
(Send Level & Pre/off/Post Switches)
13. AUX3/4, AUX5/6 (Send Level)
14. +48V
15. ϕ (Phase)
16. GAIN
17. PAD (0, 20, 40)
18. CLIP
19. ON (Channel On)
20. MUTE SAFE
21. FADER
22. MUTE (Assign 1-8)
23. CUE/SOLO
24. 1 2 3 4 5 6 7 8 (Group Assign)
25. ON/OFF/7-8 (Switch)
26. BAL/PAN
27. AUX 1-6 (Assign)
28. MONO
29. LEVEL
30. CUE L/MONO
31. CUE R
32. ON (Aux Return On)
33. LEVEL
34. CUE (Aux Send Cue)
35. ON (Auxiliary On)
36. GROUP-TO-MATRIX
37. PAN
38. GROUP-TO-ST
39. ON (Group On)
40. (Group Out Fader)
41. CUE (Group Cue)
42. 1 2 3 4 5 6 7 8 (Matrix Mix Level Controls)
43. MATRIX MASTER
44. CUE (Matrix Cue)
45. ON (Matrix On)
46. 1 2 3 4 5 6 7 8 (Group Mixing Bus Assign)
47. AUX 1-6 (Assign)
48. ST (Stereo)
49. TB OUT
50. OSC OUT
51. PINK 10K 1K 100 OFF
52. OSC LEVEL
53. (TB INPUT)
54. LEVEL (TB Input)
55. +4 (Line Pad)
57. BALANCE
56. TALKBACK ON
58. ON (Stereo Out ON)
59. (Stereo Fader)
60. CUE (Stereo Cue)
61. SOLO MODE
62. LEVEL (COMM IN Level)
63. +4 (Line Pad)
64. ON (COMM IN ON)
65. LEVEL (Cue Out)
66. ON (CUE ON)
67. PHONES (Level control)
68. COMM IN
69. INPUT CUE
70. SOLO
71. MUTE MASTER 1-8
72. PHONES

● METER & REAR PANEL LAYOUT

● PM1800-16 METER BRIDGE.

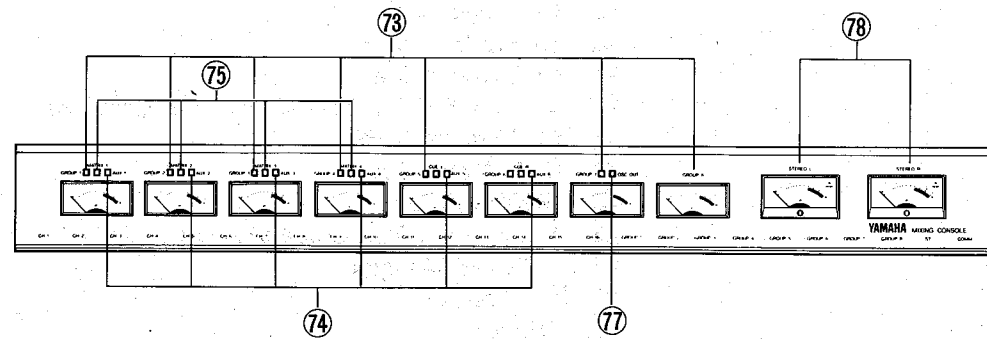

● PM1800-24 METER BRIDGE. (TYPICAL OF 24, 32 AND 40 CHANNEL CONSOLES)

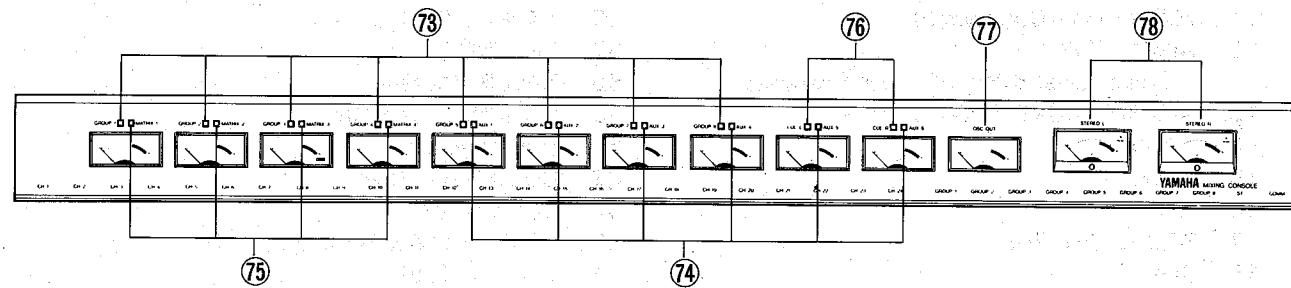

- 73. GROUP 1-8
- 74. AUX 1-6
- 75. MATRIX 1-4
- 76. CUE L & R
- 77. OSC OUT
- 78. STEREO (L & R)
- 79. INPUT (1-16, 1-24, 1-32 or 1-40)
- 80. GROUP SUB IN (1-8)
- 81. AUX SUB IN (1-6)
- 82. AUX RETURN (1 through 4, L/MONO and R)
- 83. CUE CONTROL (CUE IN, CUE CONTROL)
- 84. GROUP INSERT OUT (1-8)
- 85. GROUP INSERT IN (1-8)
- 86. AUX INSERT OUT (1-6)
- 87. AUX INSERT IN (1-6)
- 88. INPUT CHANNEL INSERT OUT (1-16, 1-24, 1-32 or 1-40)
- 89. INPUT CHANNEL INSERT IN (1-16, 1-24, 1-32 or 1-40)
- 90. AUX SEND (1-6)
- 91. GROUP OUT (1-8)
- 92. MATRIX OUT (1-4)
- 93. TB OUT
- 94. OSC OUT
- 95. CUE OUT (L, R)
- 96. STEREO OUT (L, R)
- 97. COMM IN
- 98. DC POWER IN

99. MUTE CONTROL

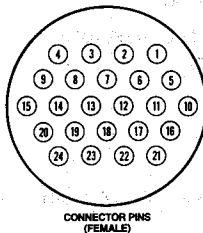

PIN#	FUNCTION	PIN#	FUNCTION
1	NC	13	MUTE BUS 3
2	NC	14	MUTE BUS 4
3	NC	15	MUTE BUS 5
4	NC	16	MUTE BUS 6
5	NC	17	MUTE BUS 7
6	NC	18	MUTE BUS 8
7	NC	19	GND
8	NC	20	GND
9	NC	21	GND
10	NC	22	NC
11	MUTE BUS 1	23	NC
12	MUTE BUS 1	24	NC

● MUTE CONNECTOR PIN ASSIGNMENTS

● PM1800 REAR PANEL

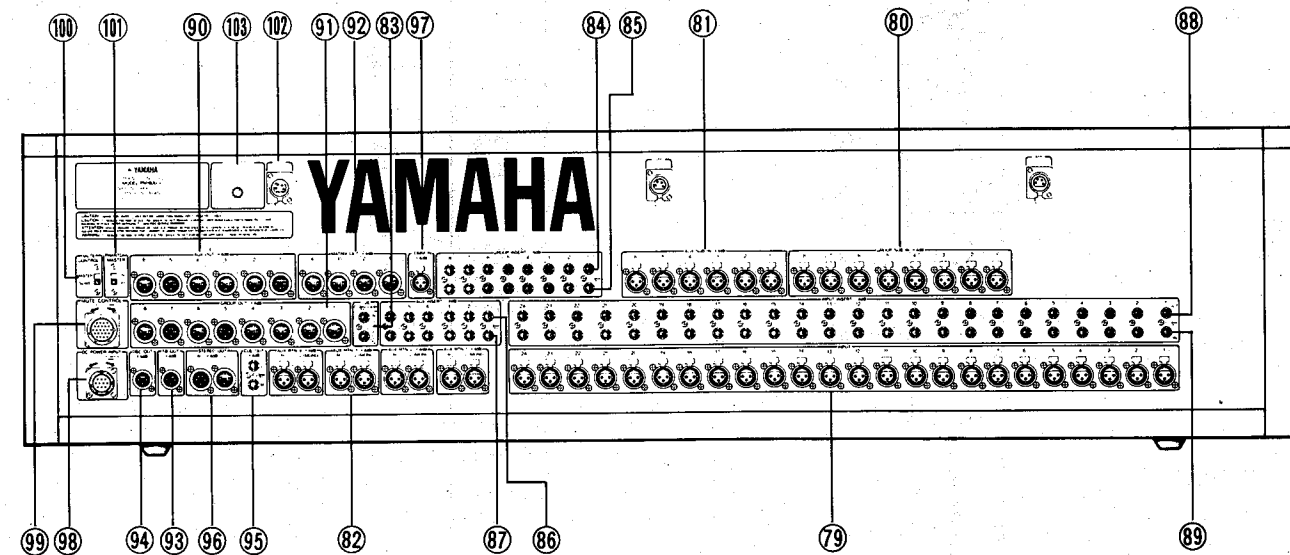
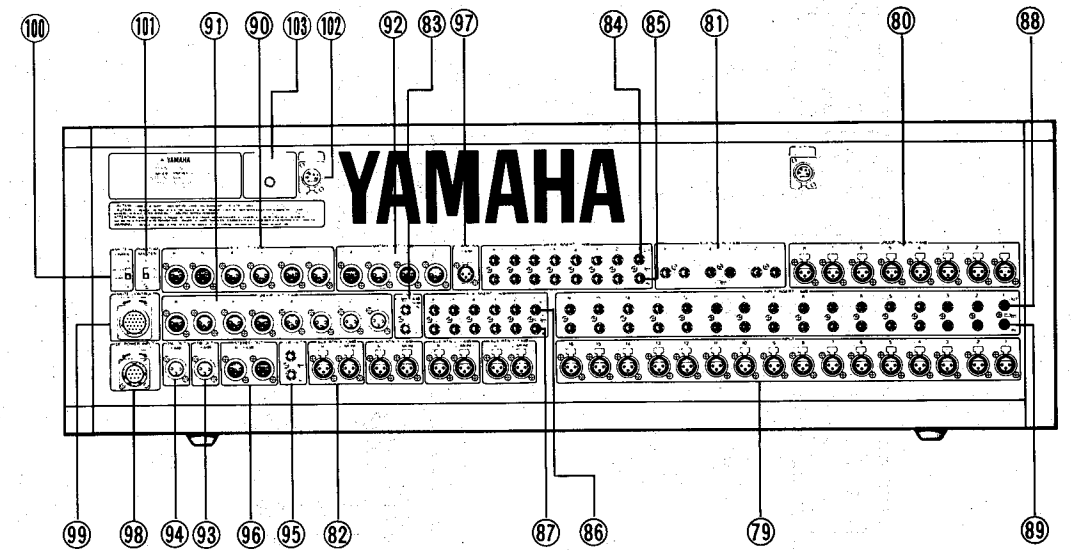

- 100. MUTE SLAVE/MASTER
- 101. PHANTOM POWER MASTER
- 102. (Lamp Sockets)
- 103. LAMP DIMMER

PM1800

● PW1800 PANEL LAYOUT

● FRONT PANEL

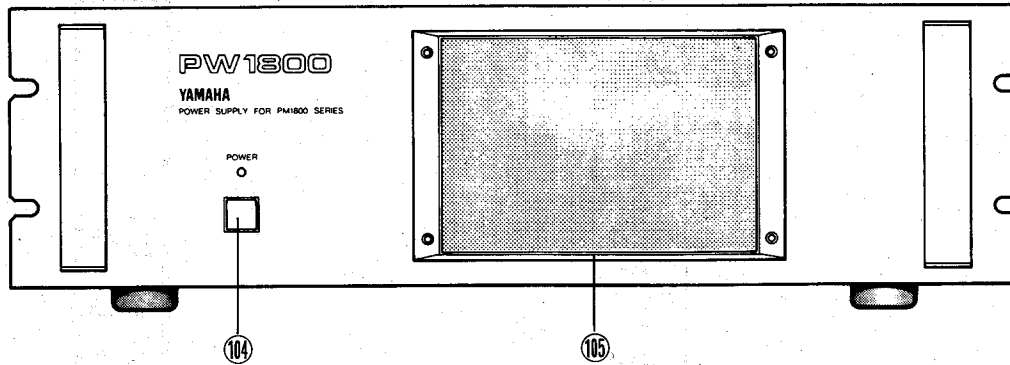

● REAR PANEL

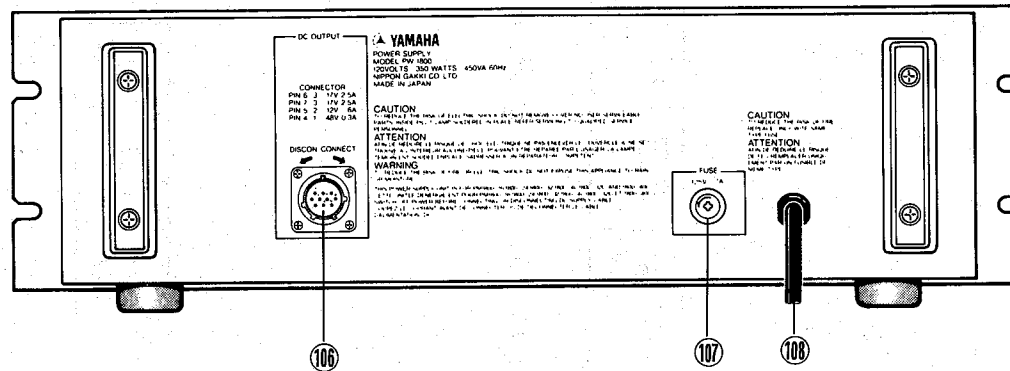

- 104. POWER (On/Off)
- 105. (Grille)

- 107. FUSES
- 108. (Power Cord)

106. (Umbilical Connector)

CAUTION: Always make certain that the PW1800 power is turned OFF prior to connecting or disconnecting the umbilical cable at the console or at the power supply.

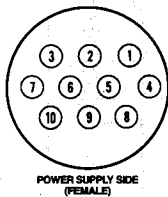
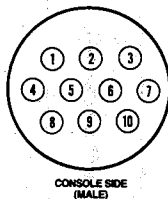

PIN#	FUNCTION
1	E (+48V)
2	E (+12V)
3	E (\pm 17V)
4	+48V
5	+12V
6	+17V
7	-17V
8	GND
9	DETECT A
10	DETECT B

PW1800 UMBILICAL CONNECTOR PIN ASSIGNMENTS.

■ OPTIONAL FUNCTIONS

The PM1800 is factory wired to suit what Yamaha engineers believe to be the greatest number of applications. Yamaha recognizes, however, that there are certain functions which must be altered for certain specific applications. In designing the PM1800, a number of optional functions have been built in, and can be selected by moving jumper wires within certain modules.

WARNING:

- 1) Lethal voltages are present inside the power supply, and the AC line cord and solsole umbilical cord should be disconnected prior to opening the console.
- 2) We at Yamaha additionally caution you never to open the console and remove or install a module for the purpose of inspection, replacement or changing the internal jumpers unless the power has first been turned off. If a module is removed or installed with power on, the circuitry may be damaged.

1 REMOVING AND INSTALLING A MODULE

The modules in the PM1800 are designed for easy removal.

1. Turn the Power OFF first, before removing or installing a module.
2. Remove the screws which secure the meter bridge to the console, and tilt the bridge back to expose the tops of the modules ①.
3. Remove the Philips head screws at the top and bottom of the module, but do not yet attempt to lift the module out ②.
4. Disconnect the three ribbon connectors from the rear edge of the module to be removed. Input modules have two ribbon connectors (30 pin & 10 pin), and one molex low-profile connector. Other modules have two ribbon connectors and one or two cable connectors ③.
5. Pull up gently on one or more control knobs, and as you feel the module connectors release, slide the module forward toward the front of the console slightly ④.
6. Now lift the module the rest of the way out of the console.
7. Installation of a module should be done by reversing the order of this procedure. Work slowly to make sure that edge connectors mate properly.

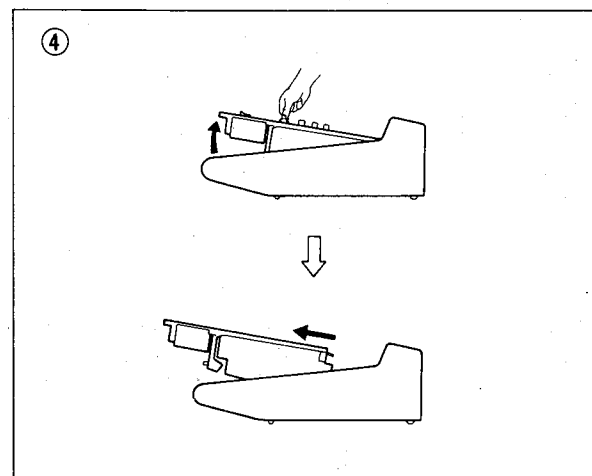
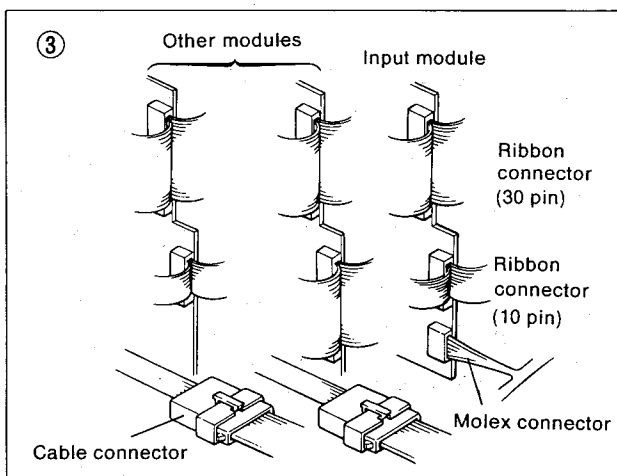
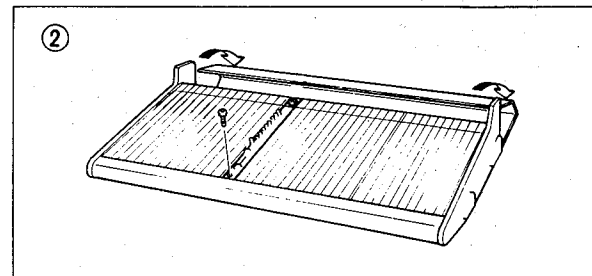
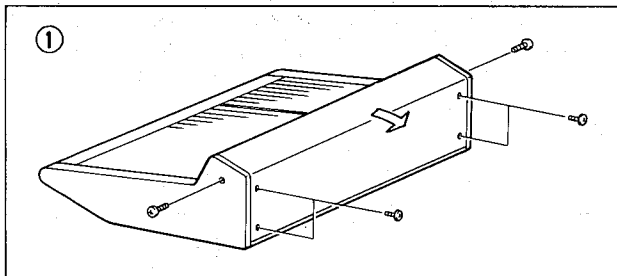

FIGURE 1. REMOVAL OF MODULE FROM PM1800.

2 INPUT CHANNEL AUX 3 THROUGH 6 SENDS: PRE OR POST FADER

As shipped, the console is wired so that the AUX 3, AUX 4, AUX 5 and AUX 6 send controls in each input module derive signal ahead of the fader, equalizer and high pass filter. If desired, individual sends can be al-

tered, by moving an internal jumper, so they are derived after the fader, EQ and filter.

Note that the factory "Pre" position supplied can be altered to be post EQ & filter, but still pre fader, as described in Section 3.

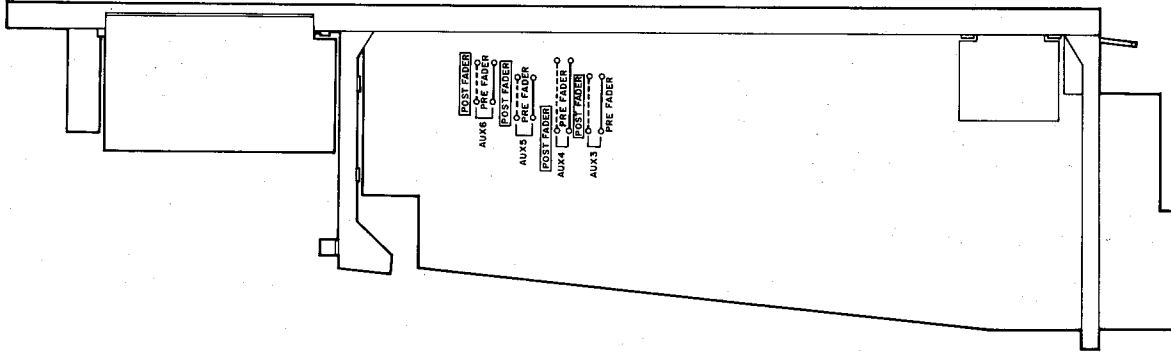

FIGURE 2. INTERNAL JUMPER WIRING FOR PRE OR POST FADER (& EQ) SENDS ON AUX 3 THROUGH AUX 6

3 INPUT CHANNEL AUX SEND PRE POSITION: PRE FADER & EQ OR PRE FADER/POST EQ

A jumper wire in each input module permits all six auxiliary sends to be altered. As shipped, the console is wired so that if front-panel PRE/OFF/POST switch on the AUX 1 or AUX 2 send is set to PRE position, the aux send is derived ahead of the fader, equalizer and high pass filter. This is useful for stage monitor work, for example, where the channel EQ for the house may not be desired for the monitors. On the other hand, suppose that one aux mix is used for a pre-fader effects send. In this case, it may be desirable to apply channel

EQ and HP filter effects to the send, yet the POST position would also cause the channel fader to affect the send. To solve the problem, the jumper can be moved so that the PRE position remains pre-fader, but is taken after the EQ and HP filter.

Note that, as factory wired, the AUX 3, AUX 4, AUX 5 and AUX 6 sends are also pre-fader and pre-EQ. If you move this jumper, it will also change those four sends so they are pre-Fader, Post EQ. (It has no effect, however, if you alter the individual jumpers on AUX 3, 4, 5 or 6 to make them Post-Fader & EQ sends).

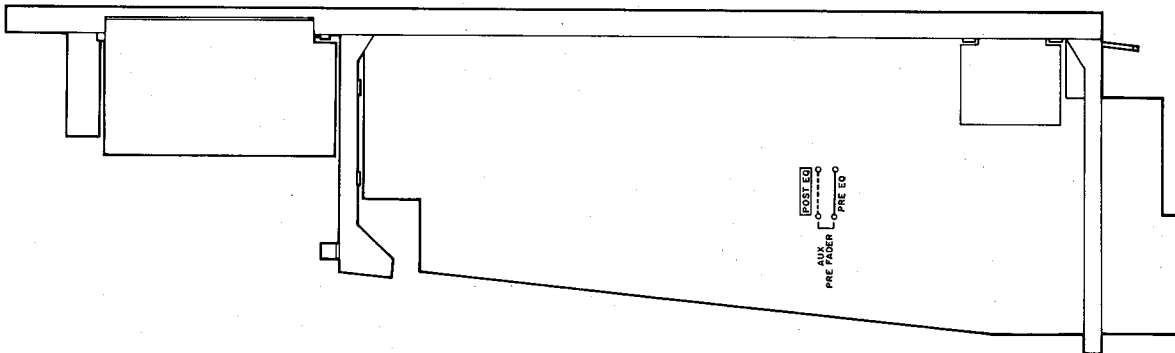

FIGURE 3. INTERNAL JUMPER WIRING FOR PRE-EQ AND POST-EQ AUX SENDS (WHEN AUX 1 OR AUX 2 PRE/OFF/POST SWITCH IS SET TO "PRE," OR AUX 3 THROUGH 6 JUMPERS ARE IN FACTORY-WIRED "PRE" POSITION).

4 GROUP-TO-MATRIX: ASSIGNED PRE OR POST GROUP MASTER FADER

A jumper wire in each master module permits the eight group sends to the mix matrix to be altered. As shipped, the console is preset so that when the GROUP-TO-MATRIX switch is on, the matrix is fed signal after the Group Master Fader (but before the GROUP ON/off switch). The internal jumper in each of these modules can be repositioned so that the matrix is fed before the Group Master Fader.

In the factory preset configuration, the matrix follows the group mix. If one group, for example, is used for vocals, another for keyboards, etc., then all vocals going to all matrix outputs can be adjusted with one Group Master Fader... all Keyboards going to all matrix outputs can be adjusted with another Group Master Fader, etc. Suppose, however, that you plan to feed a stereo

house mix from the eight subgroups, yet you need as many as eight additional mono or five stereo mixes.

The mix matrix alone allows for only one stereo and two mono mixes, or a total of two stereo mixes. A greater number of mixes can be obtained by selecting the alternate (pre-Group Master Fader) jumper positions. In that case, you can assign the Group Outputs to the stereo bus via the ST switch [38] and the adjacent PAN pot [37]; the Group Master Faders will serve as submasters for this stereo mix, and the Stereo Master Fader will control the mixed output. At the same time, the matrix controls on each master module will provide an 8:1 mix of the same groups; that matrix channel's #1 - #8 mix controls will serve as submasters, and the MATRIX MASTER will control the mixed output. In this way, you can obtain one stereo and four mono mixes, three stereo mixes, or some combination thereof all with independent submaster and master controls.

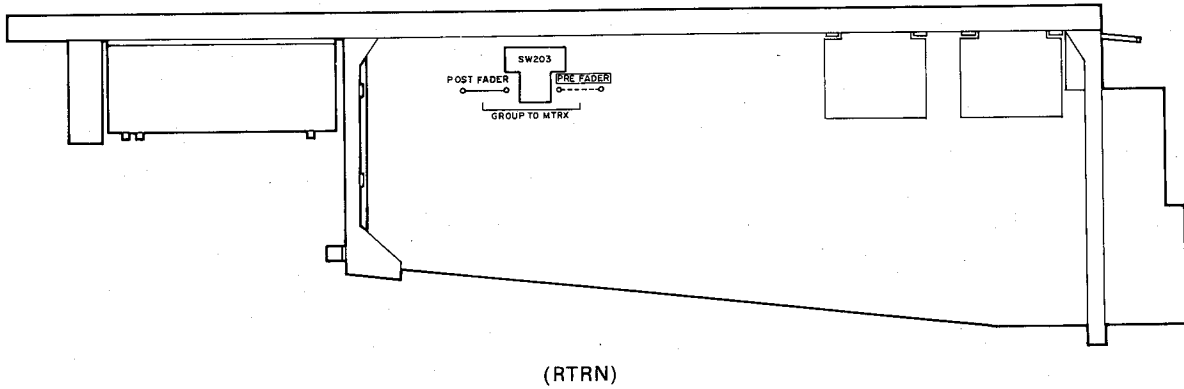

FIGURE 4-A. INTERNAL JUMPER WIRING FOR PRE- AND POST- GROUP MASTER FADER FEEDS TO MIX MATRIX.

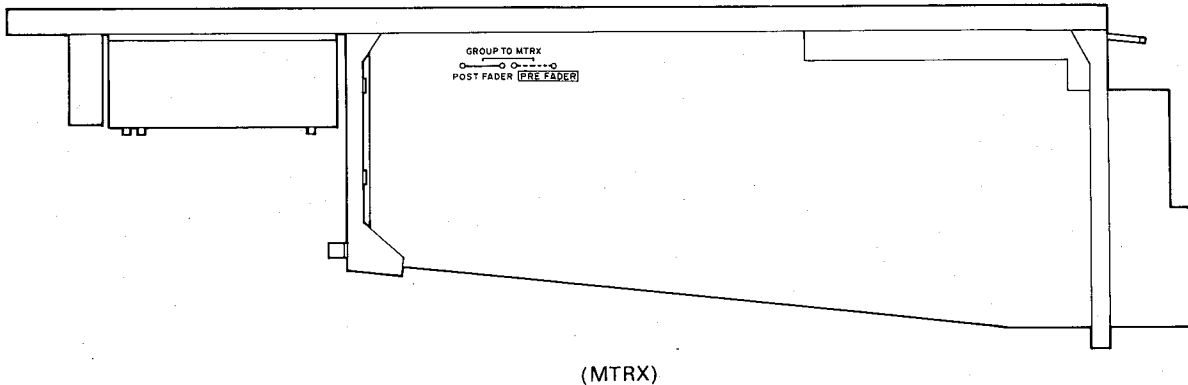
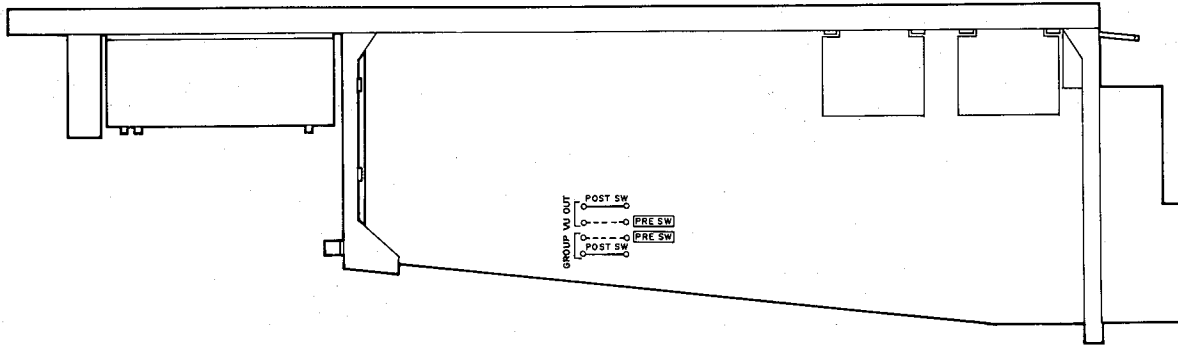

FIGURE 4-B.

5 METER FUNCTION IN "GROUP" POSITION: PRE OR POST GROUP ON/OFF SWITCH

There are eight VU meters which can be switched to monitor the GROUP output levels. Specifically, as factory wired, these meters normally monitor the Group output after the Group Master Faders and On/Off

switches. Thus, if a Group Output is switched off, there will be no meter deflection. In some cases, you may wish to preview group levels before turning on the output. An internal jumper on each group module permits you to do this.



(RTRN)

FIGURE 5-A. INTERNAL JUMPER WIRING FOR GROUP METERING BEFORE OR AFTER THE GROUP ON/OFF SWITCH.

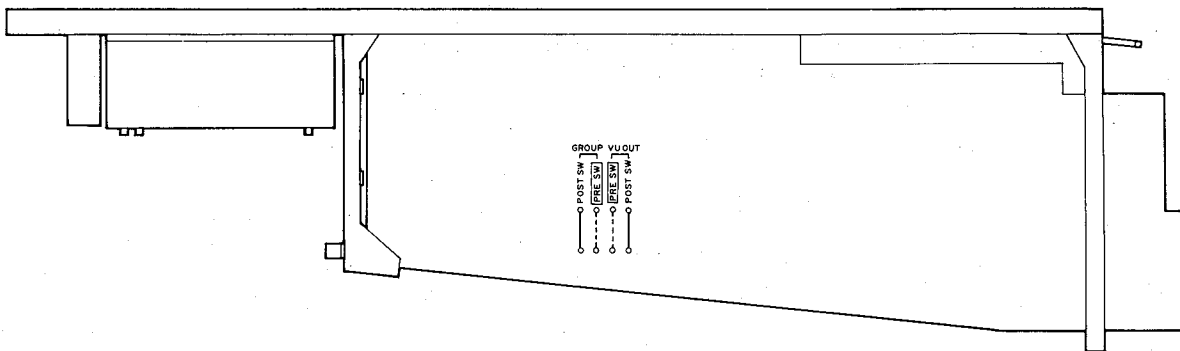

(MTRX)

FIGURE 5-B.

PM1800

6 INSTALLATION OF OPTIONAL INPUT TRANSFORMERS

The PM1800 standard input module is equipped with a balanced, differential input preamplifier for the XLR connector. That preamp, along with some circuitry for the resistive attenuation pads, is located on a small printed circuit board that "piggy back" mounts to the module's main circuit board. Refer to Figure 6.

An optional transformer balancing option may be installed by a Yamaha PM1800 dealer or a qualified electronic service technician. The modification kit contains a replacement circuit board for the original differential preamplifier, and a separate input transformer. In order to install the kit, the following steps must be performed.

1. Shut off the power to the console.
2. Remove any input module(s) to be converted from the console mainframe.
3. Hold the module with the fader to the left, and lay the module on its side, controls facing away from you.
4. Remove the "IN1 4/4" board.
5. Install the new board (that comes wired to the transformer) in place of the "IN1 4/4" board.
6. Install the transformer by securing its bracket to the lower left edge of the module frame with the screw provided. Dress the cable that joins the transformer and its circuit board neatly. You may wish to tie it to the board so that after the module is reinstalled, the cable does not become pinched between modules or between the module and mainframe. Refer to Figure 6.
7. Reinstall the input module into the mainframe.

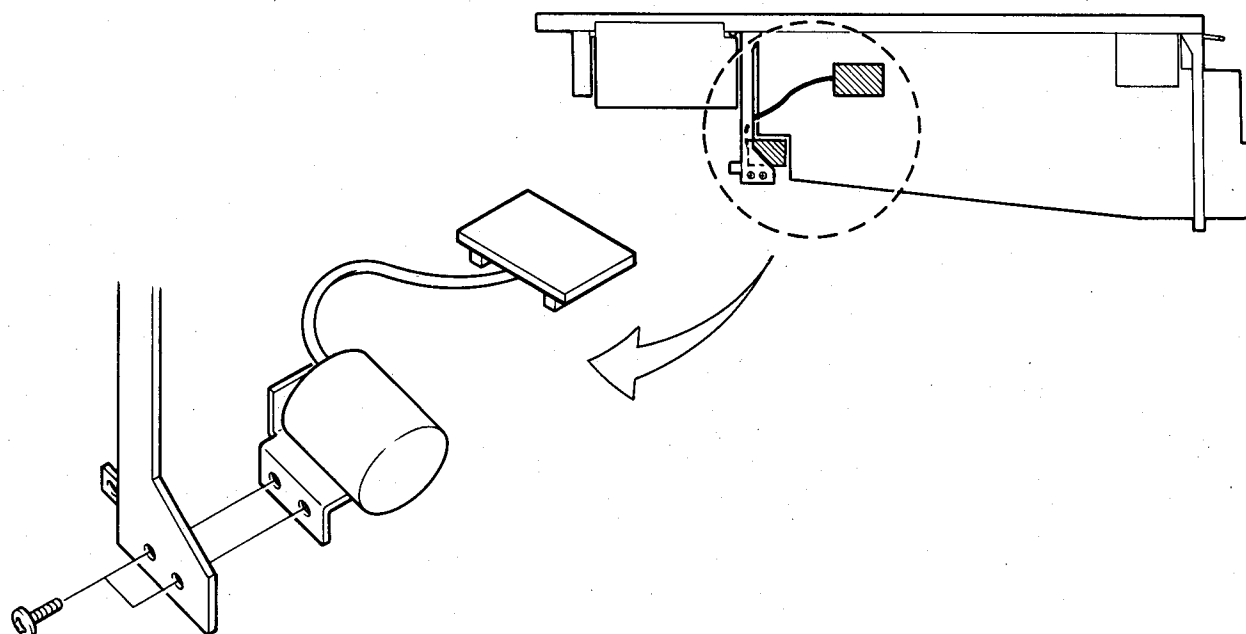

FIGURE 6. OPTIONAL INPUT TRANSFORMER INSTALLATION. (IT1800)

7 HINTS ON CIRCUITRY FOR REMOTE CONTROL OF THE MUTE GROUPS

The MUTE CONTROL connector on the PM1800 rear panel is provided primarily so that two consoles may be linked, and just one console's MUTE MASTER switches will affect both console's input channels. However, it is possible to create an independent controller so that this function can be remoted from the console. One possible application would be the creation of a limited automation system. Yamaha does not offer detailed instructions for this type of remote control. However, we do present here information which will allow a competent technician to do the job.

In order to mute a group, simply ground the conductor corresponding to that group. Naturally, the console's MUTE MASTER/SLAVE switch must be set to the SLAVE position in order for the corresponding remote control to take effect. The MUTE connections not only permit remote muting by an external switching system, they also permit two PM1800 consoles, or a PM1800 and PM3000 to be interconnected so that one console's master mute switches can control both console's muting functions.

■ METER LAMP REPLACEMENT

Two lamps illuminate the face of each VU meter.
 To change a meter lamp, first open the meter bridge. This is done by removing 2 screws from the side and four screws from the rear panel behind the meter ①. The bridge is hinged on the rear panel, and can be swung open for access to the meters ②.

Each replacement lamp (Yamaha part number 75570) comes with a connector affixed to pigtail leads from the lamp ③. Withdraw the old lamp from the rear, pulling it out of its retaining grommet in the meter face, and unplug the connector from the rear of the meter assembly ④. Insert the new lamp in its place, and secure the connector.

PM1800

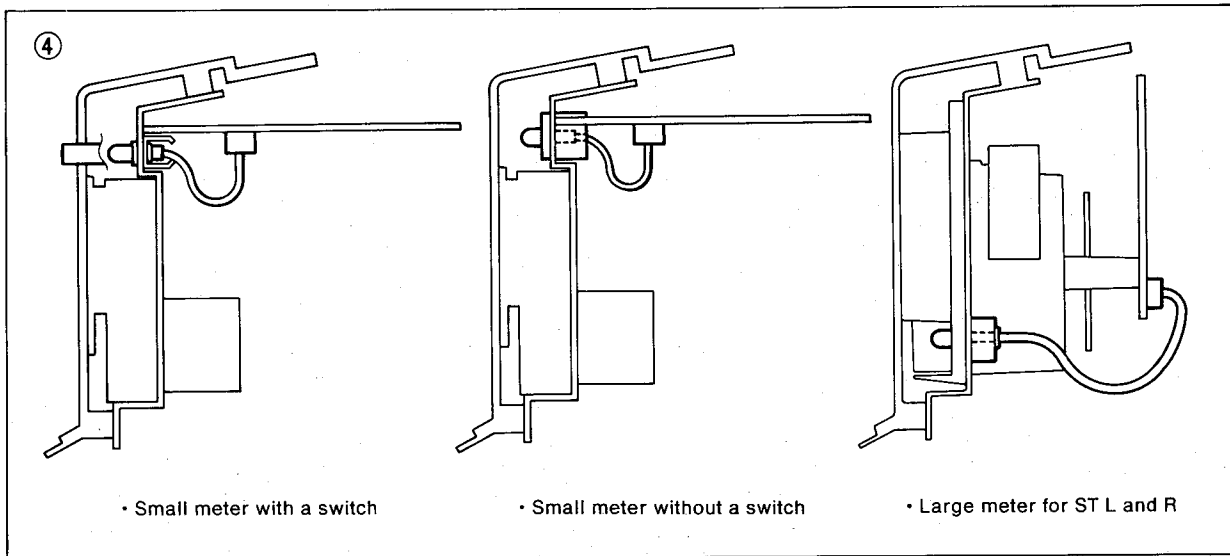
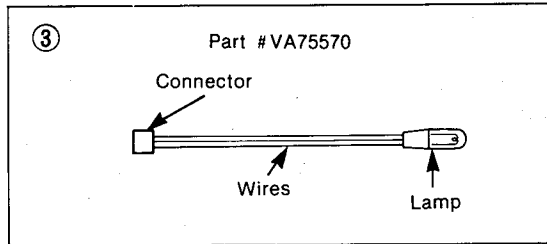
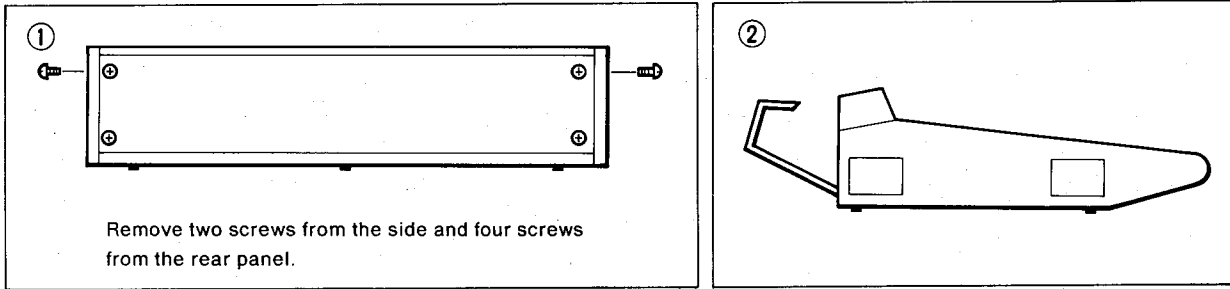

REPLACEMENT OF VU METER LAMPS.

■ ADJUSTMENTS

All adjustments have been made at factory. Normally, an adjustment would be required after a repair has been made to the circuit where the adjustment potentiometer is located.

NOTE: Unless specified, all switches are off and controls at minimum. In order to carry out the following adjustments, module extension cables are required. Refer to the corresponding circuit board for adjustment locations.

	Adjustment	Control/Switch setting	Procedure
VU calibration	STEREO L/R	Set the oscillator to 1 kHz operation. Adjust the oscillator output level for +4 dBm. Select the right position switch of its meters.	Adjust VR1 on the MT1 circuit board for 0 ± 0.1 VU.
	Other VU meters		Adjust VR21s on the MT2A/2B/2C/2D/2E circuit boards for 0 ± 0.1 VU.

	Adjustment	Equipment required	Mesure at	Procedure
PW1800 Power supply	+17 V power supply	DC voltmeter	DC output connector pin #6 - #3	Adjust VR101 on the DC1 circuit board for $+17.3 \pm 0.5$ V
	-17 V power supply	DC voltmeter	DC output connector pin #7 - #3	Adjust VR101 on the DC1 circuit board for $+17.3 \pm 0.5$ V
	+12 V power supply	DC voltmeter	DC output connector pin #5 - #2	Adjust VR102 on the DC2 circuit board for $+12 \pm 0.5$ V

Notes)

- (1) PW1800 adjustments should be performed with the PM1800 connected to the PW1800.
- (2) 0 dBu is referenced to 0.775 VRMS. Where the circuit is capable of 600-ohm termination, this would be equivalent to 0 dBm.
- (3) Module extension cables

5P	MX000130
30P	MX000140

■ CIRCUIT BOARDS

● IN1 Circuit Board

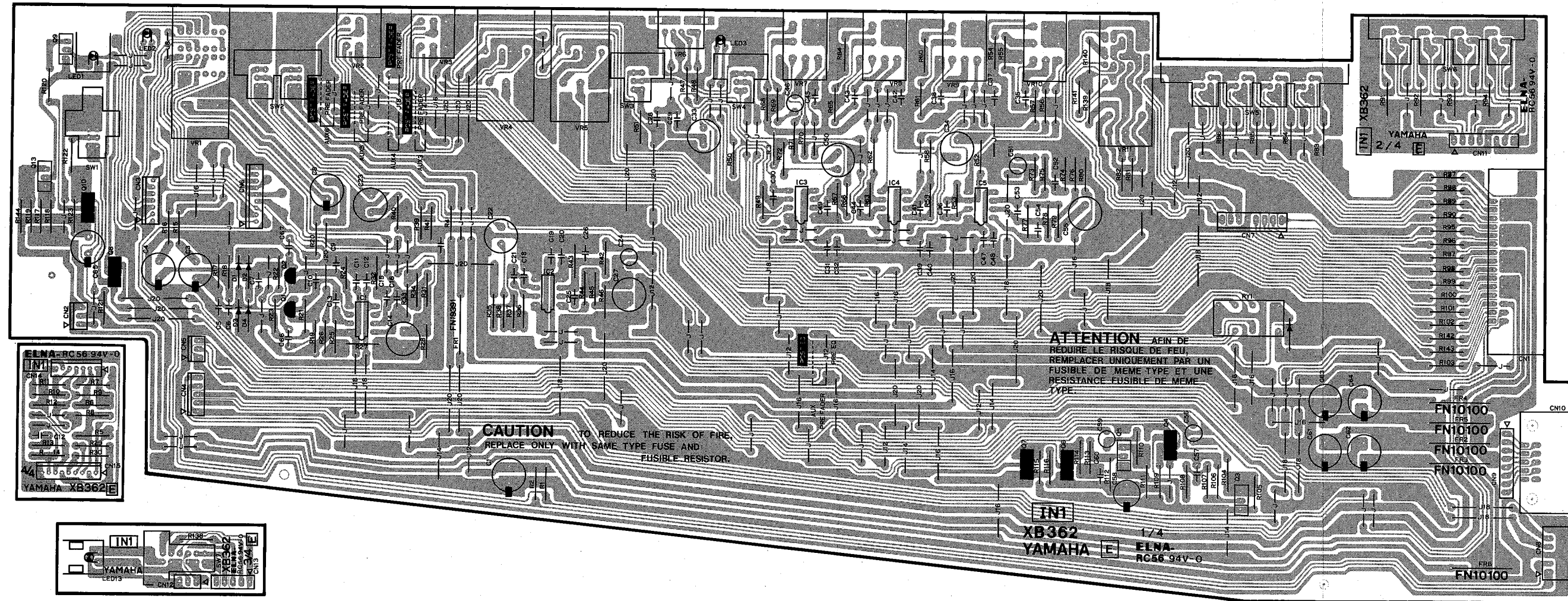

< Components side >

IN1 Circuit Board

Circuit Board:

IC 1~5:

4, 6~8, 10:

Q 1, 2:

3, 5, 9, 11~13:

D 1~4, 6~13:

5:

LED 2, 3:

Marked:

FR 1:

2~6:

XB362C0

NJM4560ED (IG040000) OP AMP.

2SA937 Q, R, S

2SA970 GR, BL

2SC2021 Q, R, S

1SS176

1SR35-100A

LN222RP RE

Metal Oxide Resistor

Fuse Resistor 390Ω 25mA

Fuse Resistor 10Ω 220mA

VR 1:

2, 3:

4, 5:

6:

7~10:

11:

SW 1:

2:

3, 4:

5, 6:

7:

RY 1:

SRBU23 RD10K (VC041000) with SW

A20K PK12 (VC294500)

SRBU13 A20K (VC040900) with SW

RK12K122 (VC042200)

RK12 (VC042800)

SRBU22 AC2K (VC040800) with SW

(VA257900)

(VC039900)

(VA258000)

(VA258900)

(VA258300)

Relay DC RY12W

• IN2 Circuit Board

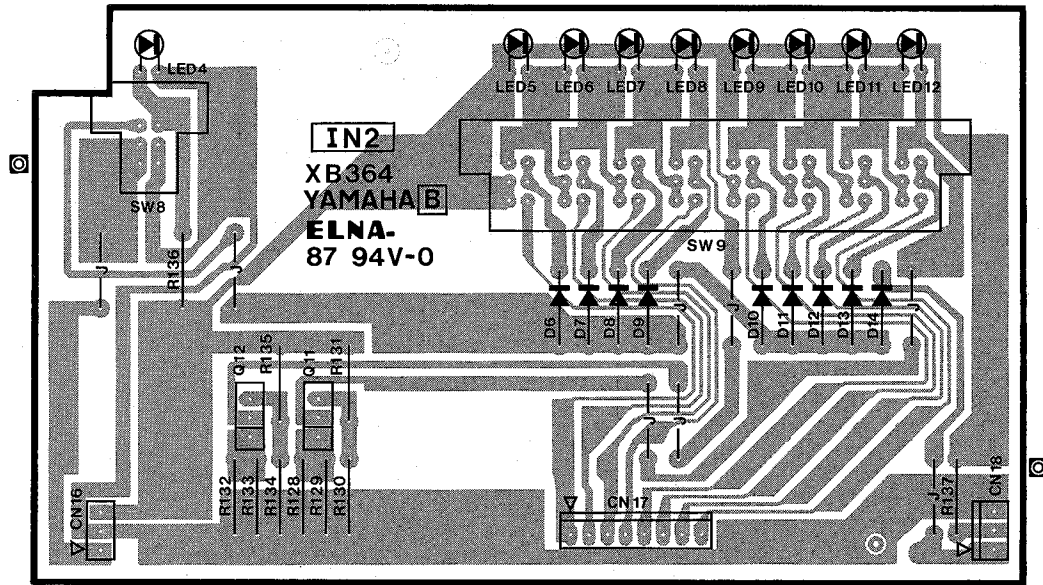

< Components side >

IN2 Circuit Board

Circuit Board:

Q 11, 12:

D 6~14:

LED 4:

5~12:

SW 8:

9:

XB364B0

2SC2021 Q, R, S

1SS176

LN242RP RE

LN442YP YE

(VA258000)

(VA258400)

PM1800

• ST1 Circuit Board

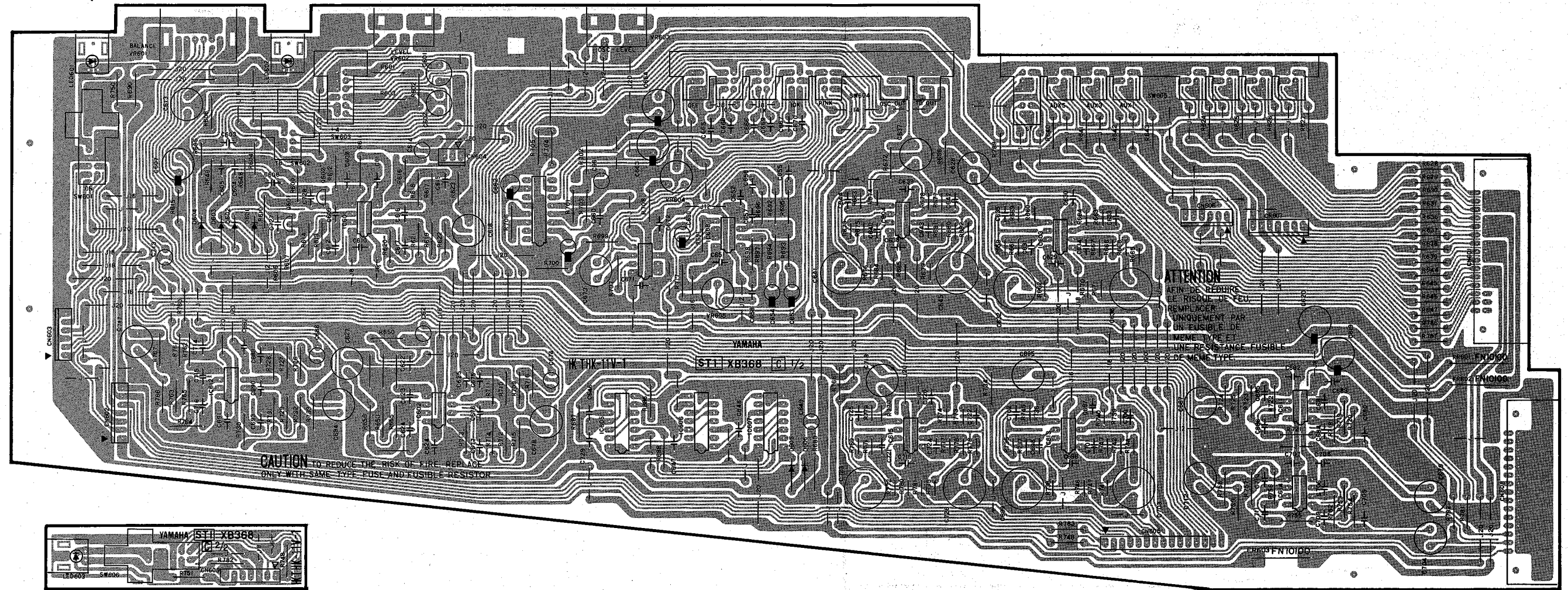

< Components side >

ST1 Circuit Board

Circuit Board:

IC 601, 602, 608,
603, 604, 613, 615:

605:

606, 607:

609, 612:

610:

611, 614:

Q 601, 602:

D 601~606:

Marked:

FR 601~603:

XB368C0

NJM4556 (IG042500) OP AMP.

TC4030BP (IG001790) XOR

TC4006BP (IG001680) SREG

NJM4560ED (IG040000) OP AMP.

XR-2206CP (XA243001) Generator

NJM2041DD (IG069200) OP AMP.

2SA970 GR, BL

1SS176

Metal Oxide Resistor

Fuse Resistor 10Ω 1/2W

VR 601:

602, 603:

604~605:

Marked:

Marked:

SW 601, 603:

602:

604:

605:

606:

RK16K122 (VC042700)

A10KΩ RK12K112 (VC042500)

R10KΩ 3P RHE (VA788000)

Semiconductive Cera. Cap.

0.01 μF 25V

Polypropylene Cap.

(VA258100)

(VA258000)

(VC040300)

(VC040200)

(VA258300)

3NA-VC08640 \triangle : ST1

3NA-VC08650 \triangle : ST2

● ST2 Circuit Board

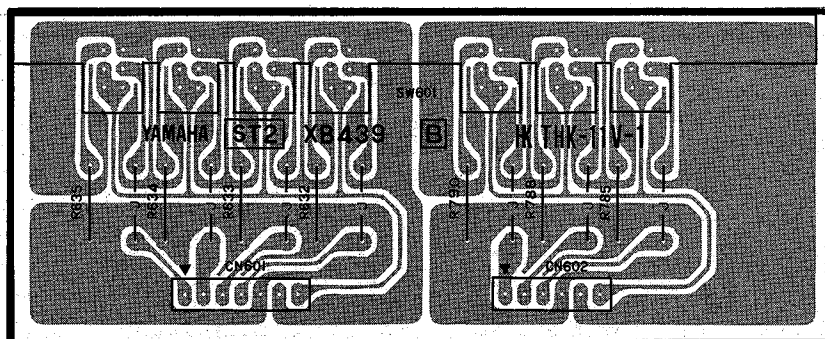

< Components side >

ST2 Circuit Board

Circuit Board:

Marked:

SW 607:

XB439B0

Metal Oxide Resistor

(VC294400)

• RTRN1 (RT1-1, 2, 3, 4) Circuit Board

PM1800

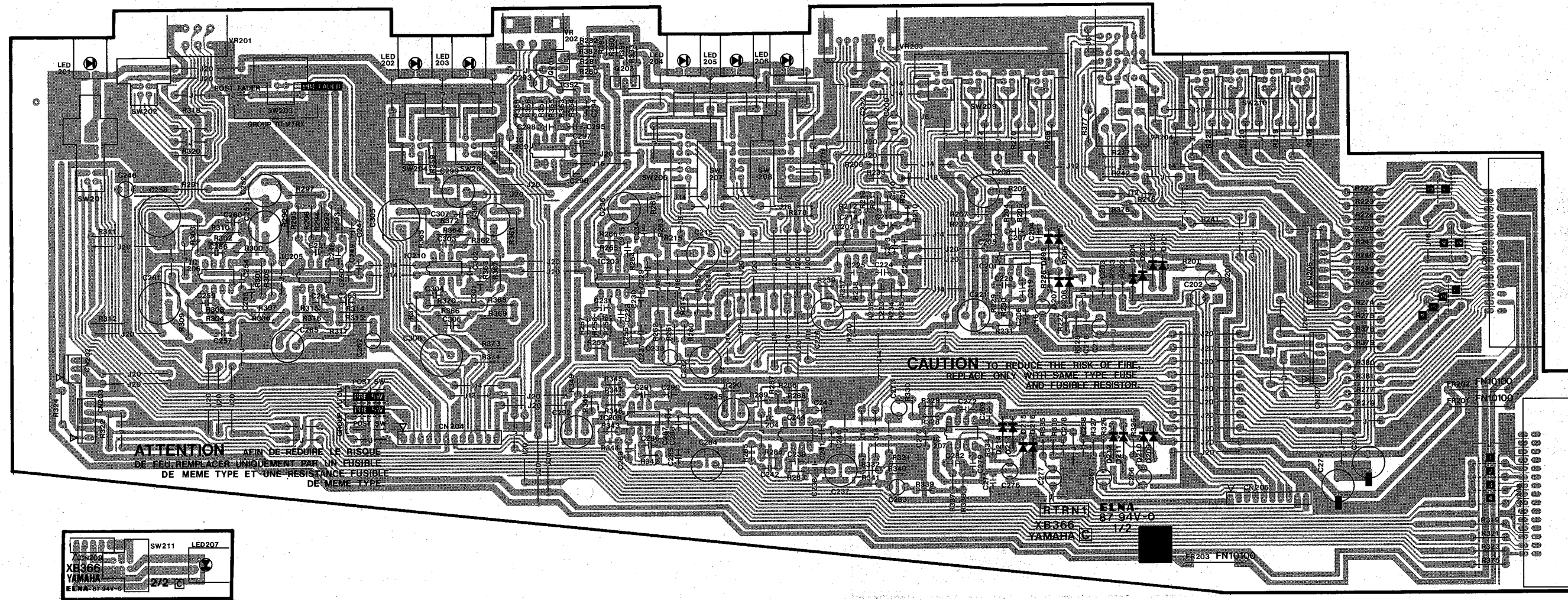

< Components side >

RTRN1 (RT1-1, 2, 3, 4) Circuit Board

Circuit Board:	XB366C0		
IC 201~203, 205,			
207, 209:	NJM4560ED (IG040000) OP AMP.	VR 201:	AC20K K12210 (VD357000)
204, 208:	NJM2041DD (IG069200) OP AMP.	202:	A10KΩ RK12K112 (VC042500)
206, 210:	NJM4556 (IG042500) OP AMP.	203:	A10KΩ RK16K11B (VC042600)
Q 201, 202:	2SC2021 Q, R, S	204:	SRBU22 AC2K (VC040800) with SW
D 201~206:	1SS176	SW 201, 206~208:	(VA258100)
Marked:	Metal Oxide Resistor	202~205:	(VA258000)
FR 201~203:	Fuse Resistor 10Ω 1/2W	209, 210:	(VA258900)
		211:	(VC040500)

● RTRN 2 Circuit Board

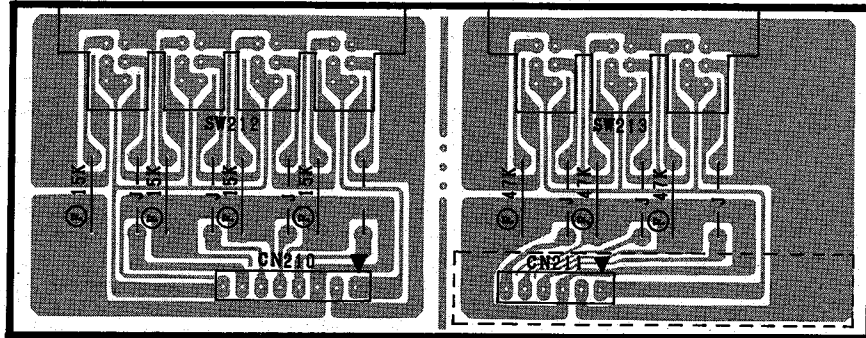

< Components side >

RTRN 2 Circuit Board

Circuit Board:

Marked:

SW 212:

213:

XB498B0

Metal Oxide Resistor

(VA258900)

(VA294300)

• MTRX (MTRX-1, 2, 3, 4) Circuit Board

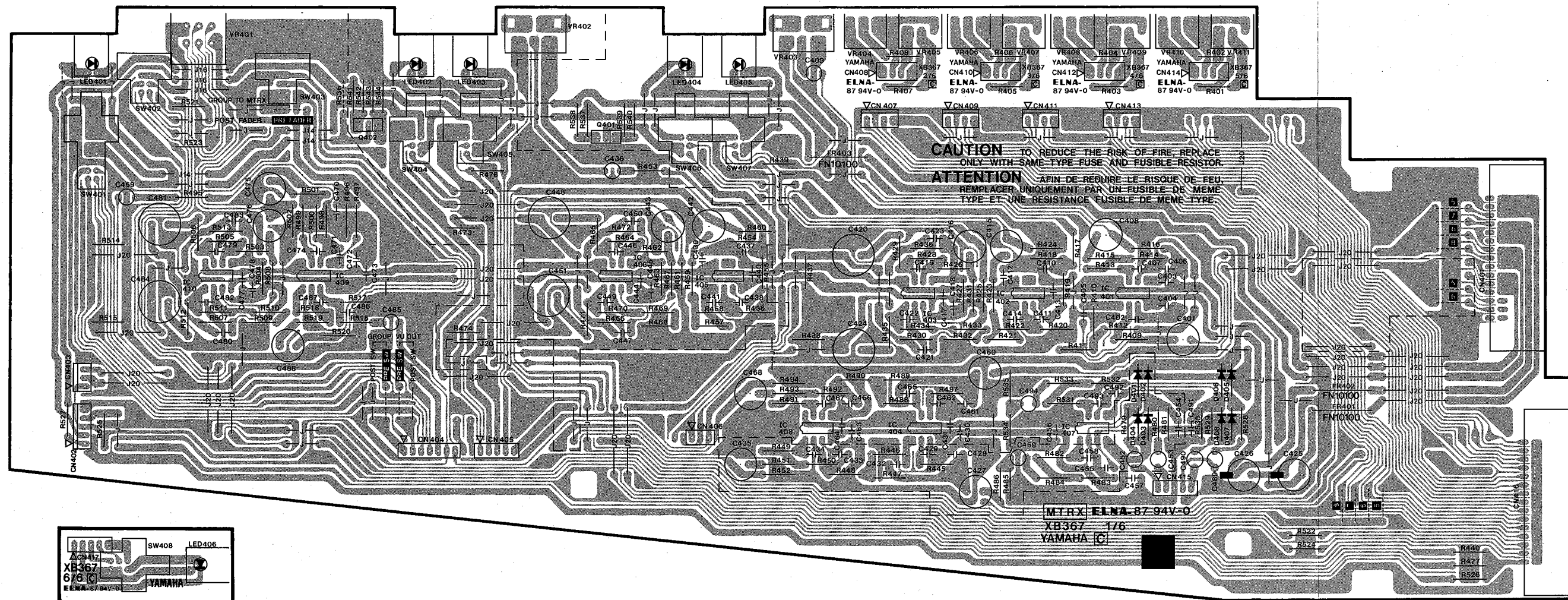

PM1800

< Components side >

MTRX (MTRX-1, 2, 3, 4) Circuit Board

Circuit Board:	XB367C0
IC 401, 404, 408:	NJM2041DD (IG069200) OP AMP.
402, 405, 407, 409:	NJM4560ED (IG040000) OP AMP.
403, 406, 410:	NJM4556 (IG042500) OP AMP.
Q 401, 402:	2SC2021 Q, R, S
D 401~408:	1SS176
Marked:	Metal Oxide Resistor
FR 401~403:	Fuse Resistor 10Ω 1/2W
VR 401:	A, C 20KΩ (VD357000)
402, 403:	A10KΩ RK12K112 (VC042500)
404~411:	A20KΩ RK12 (VC042400)
SW 401:	(VA258100)
402~407:	(VA258000)
408:	(VC040500)

• COM1 Circuit Board

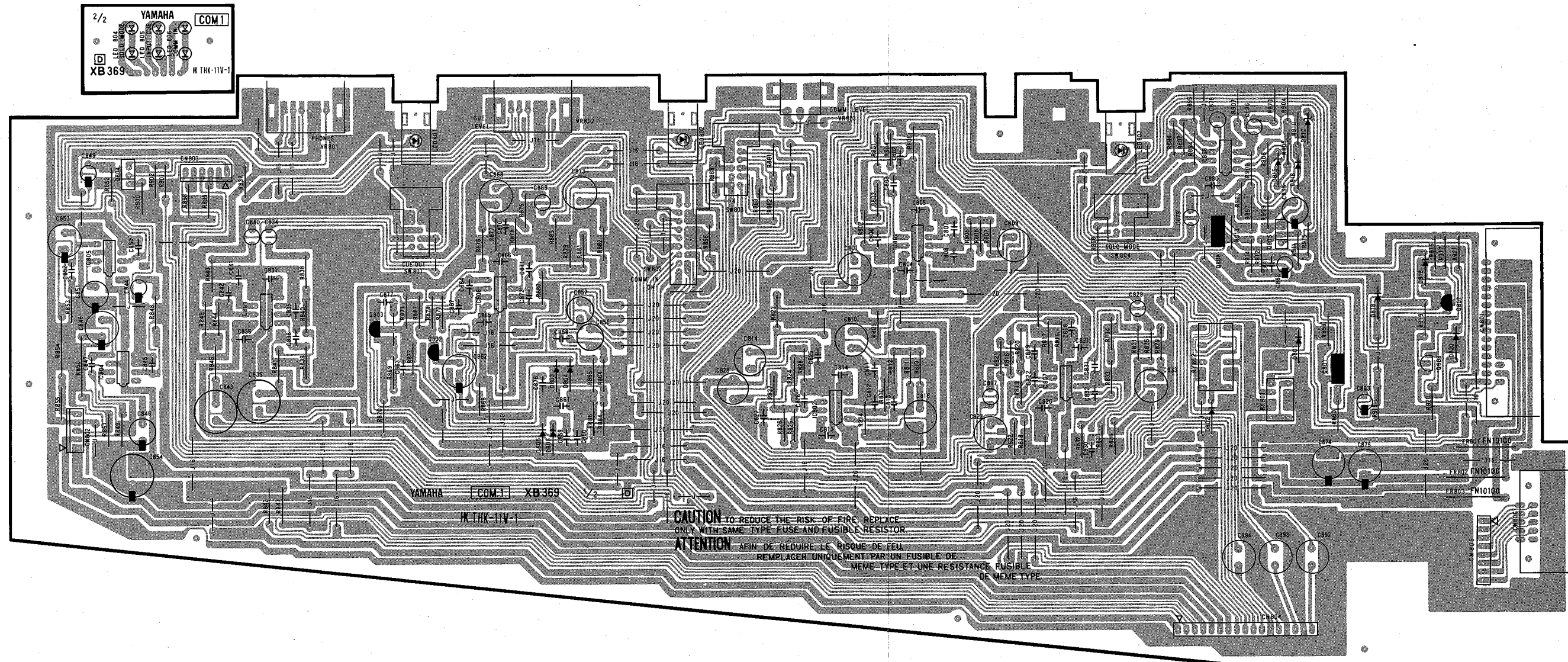

< Components side >

COM1 Circuit Board

Circuit Board:

IC 801:

802, 803, 806, 807:

804, 805:

808:

Q 801, 806:

802, 803:

804, 805:

807:

808:

D 801, 802:

803~806, 816,

818~820:

815:

817:

Marked:

XB369D0

NJM2041DD (IG069200) OP AMP.

NJM4560ED (IG040000) OP AMP.

NJM386D (IG056600) 0.5W 1CH

NJM4558DV (IG001390) OP AMP.

2SA937 Q, R, S

2SA970 GR, BL

2SC2021 Q, R, S

2SA999 E, F

2SC2320 E, F

1SR35-100A

1SS176

Zener Diode RD5.6EB3

Zener Diode RD6.2EB2

Metal Oxide Resistor

FR 801~803:

VR 801, 802:

803:

SW 801, 803:

802:

804:

RY 801:

802:

LED 804:

805:

806:

Fuse Resistor 10Ω 1/2W

A10KΩ RK16K12B (VC042600)

A10KΩ RK12K112 (VC042500)

(VA258100)

(VC811300)

(VC040500)

DC SY-12

DC RY12W

LN0202RP2

LN0202YP4

LN0202GP3

• COM2 Circuit Board

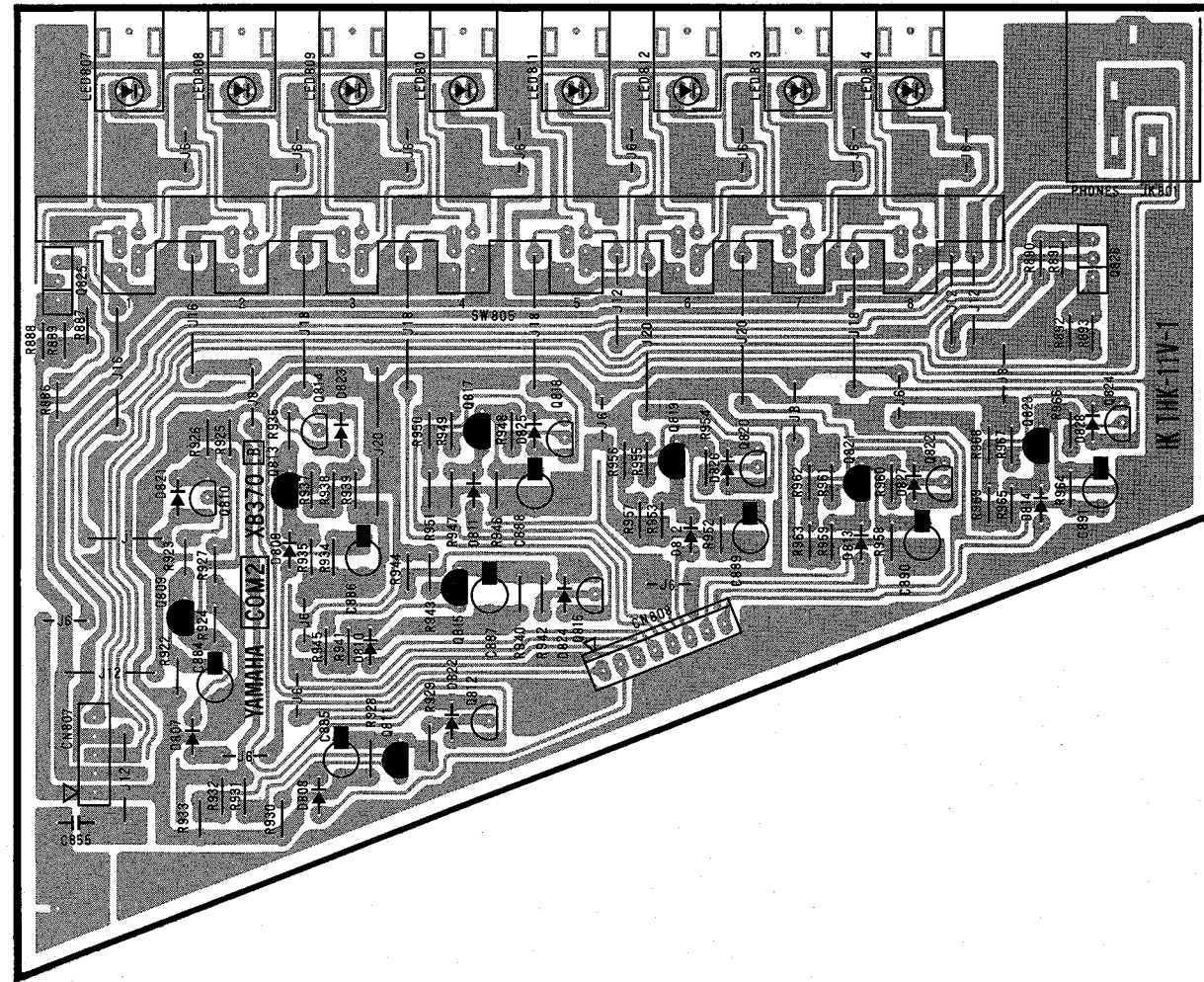

< Components side >

COM2 Circuit Board

Circuit Board:

Q 809, 811, 813, 815,
817, 819, 821, 823:
810, 812, 814, 816,
818, 820, 822, 824:
826:

D 807~814, 821~828:

SW 805:

JK 801:

XB370B0

2SA999 E, F

2SC2320 E, F

2SC2021 Q, R, S

1SS176

(VC040400)

JL3A X-G4631 Phone Jack

• MT1 Circuit Board

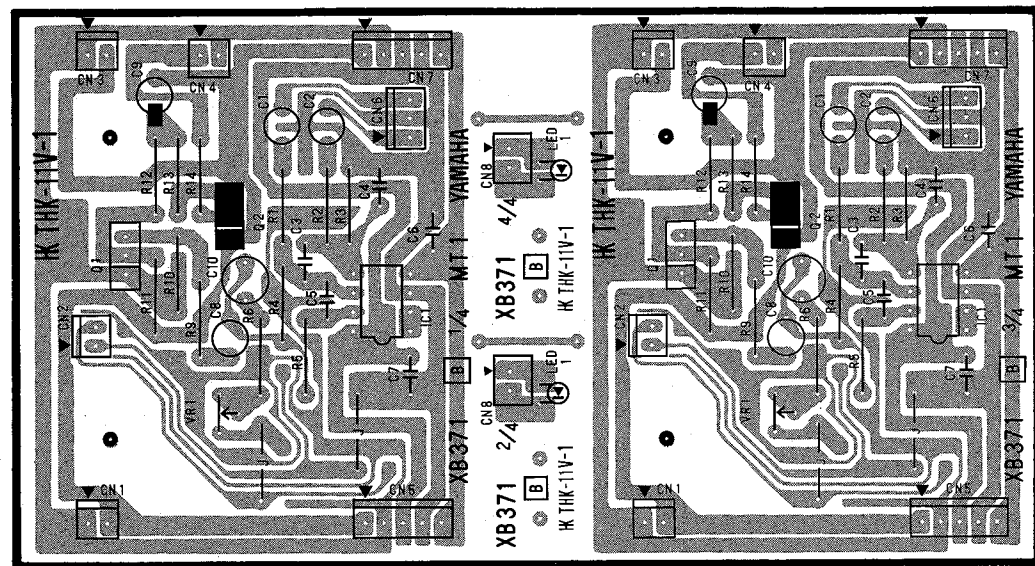

< Components side >

MT1 Circuit Board

Circuit Board: XB371B0
 IC 1: NJM4558DY (IG028400) OP AMP.
 Q 1: 2SC2021 Q, R, S
 2: 2SA937 Q, R, S
 LED 1: LN222RP RE
 VR 1: B1K RHE 3P

• MT2 (A~E) Circuit Board

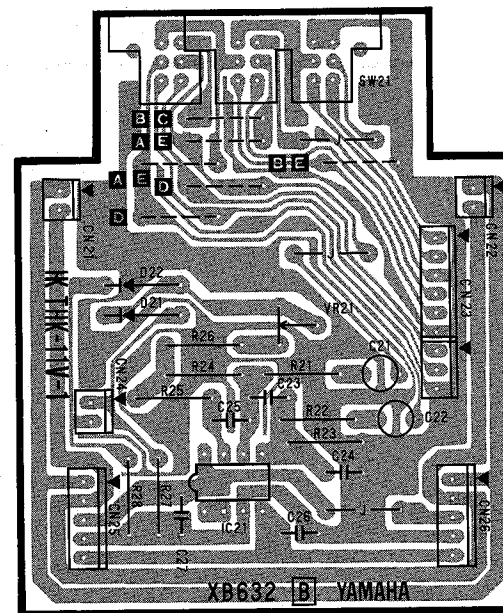

< Components side >

MT2 (A~E) Circuit Board

Circuit Board: XB632B0
 IC 21: NJM4558DY (IG028400) OP AMP.
 D 21, 22: OA95
 VR 21: B470Ω 3P RHE0A
 SW 21: (VC040600) MT2A, E
 (VC040700) MT2B, C
 No Use MT2D

- MT1 : 3NA-VC08720 \triangle
- MT2A : 3NA-VC08730 \triangle
- MT2B : 3NA-VC08740 \triangle
- MT2C : 3NA-VC08750 \triangle
- MT2D : 3NA-VC08850 \triangle
- MT2E : 3NA-VC08860 \triangle

• METER Wiring (24, 32, 40 Channel)

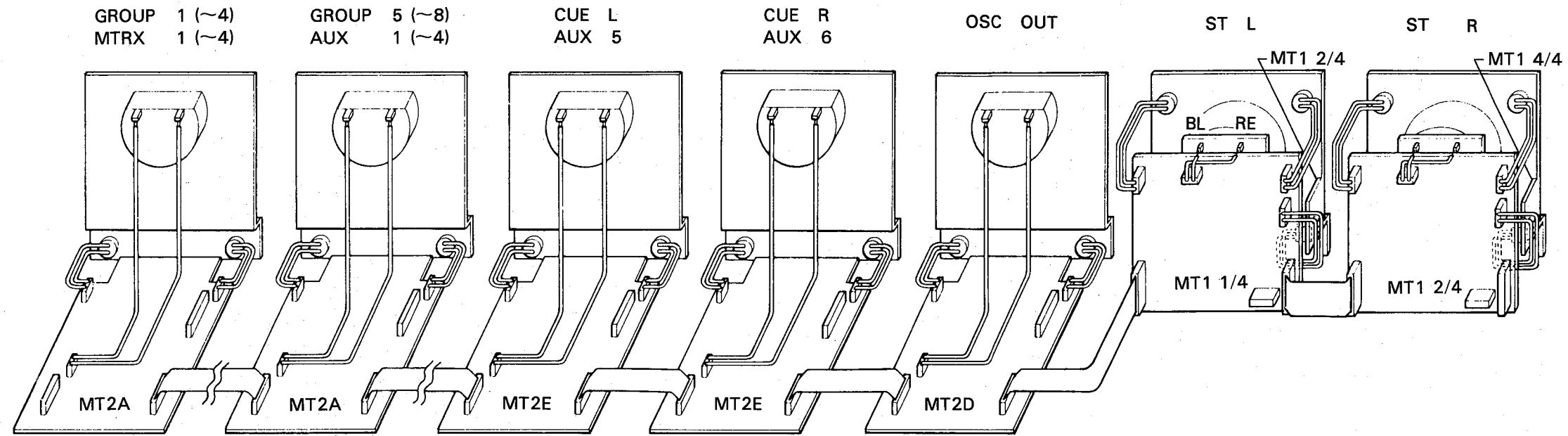

• METER Wiring (16 Channel)

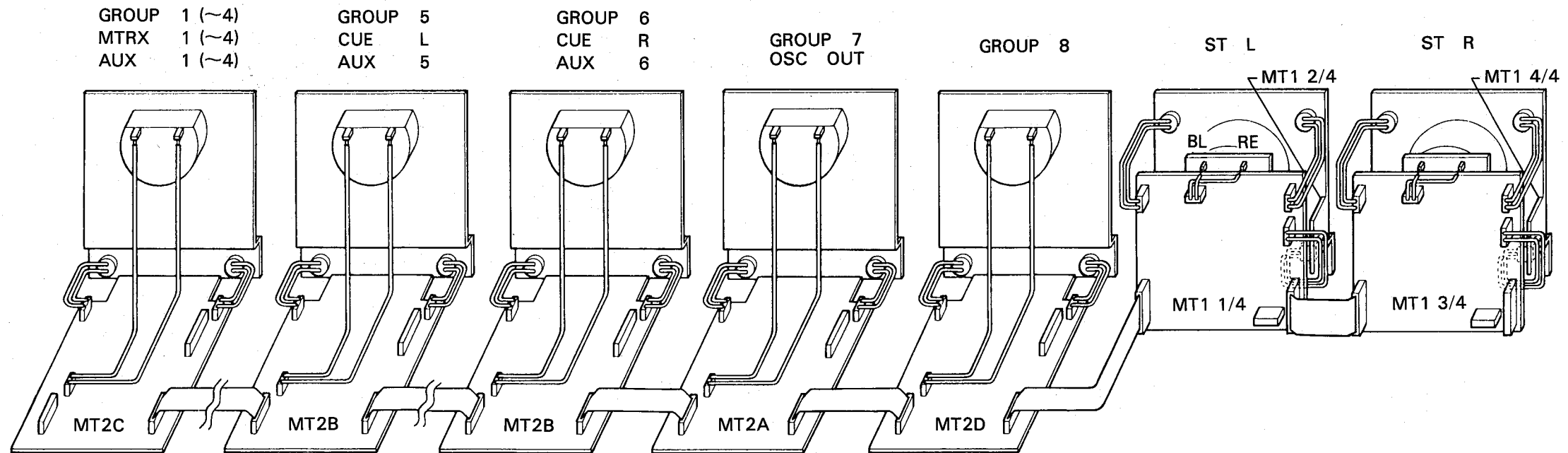

PM1800

• CO Circuit Board

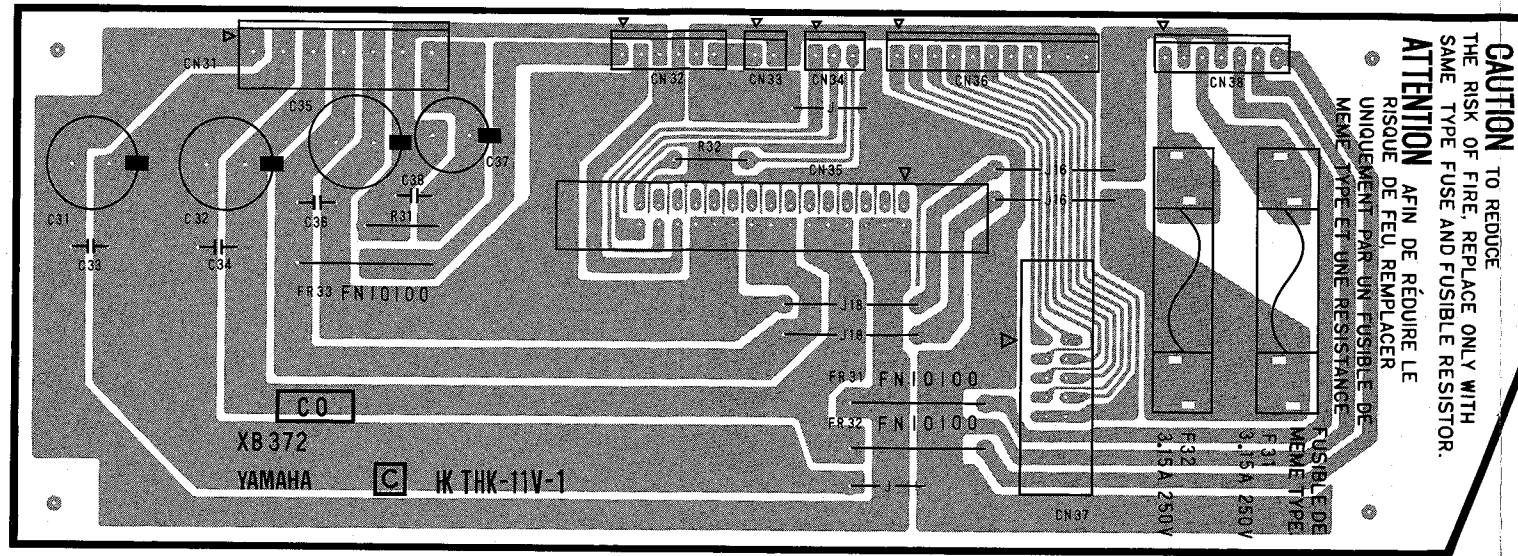

< Components side >

• CUE Circuit Board

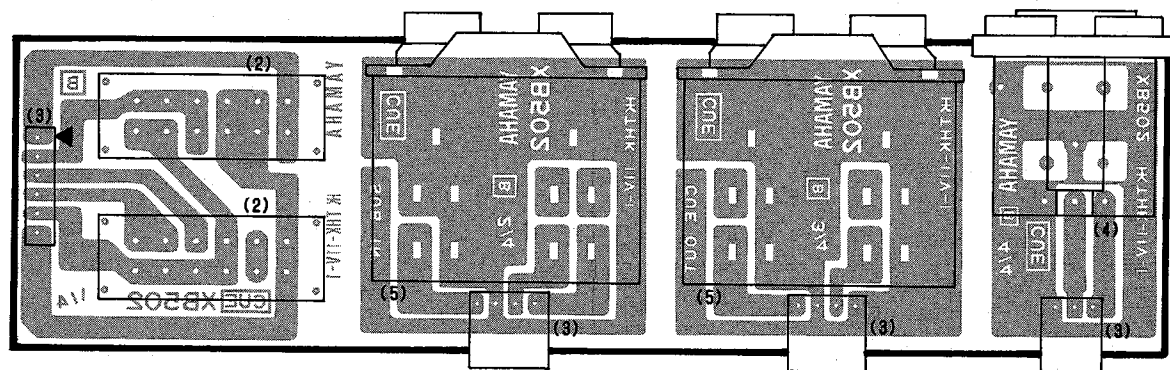

< Components side >

CO Circuit Board

Circuit Board:
Marked:
FR 31~33:
F 31, 32:
3NA-VC08870

XB372C0
Metal Oxide Resistor 47KΩ
Fuse Resistor 10Ω 1/2
T3.15A 250V

CUE Circuit Board

Circuit Board:
Switch:
Phone Jack:
Connector:
3NA-VC08710

XB502C0
(KA400760)
2P HLJ2335 Stereo
XLB-3-3

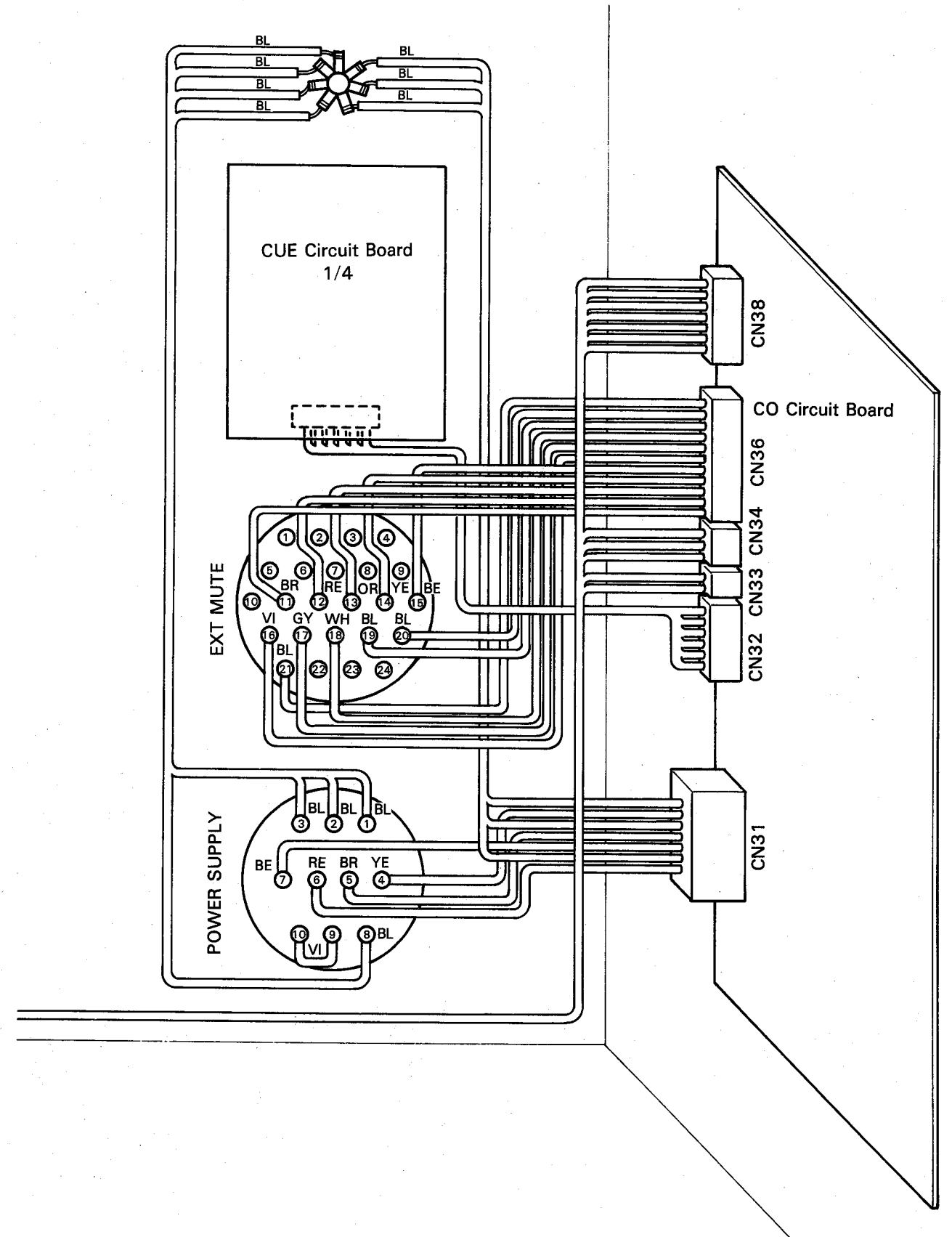

• INJ Circuit Board

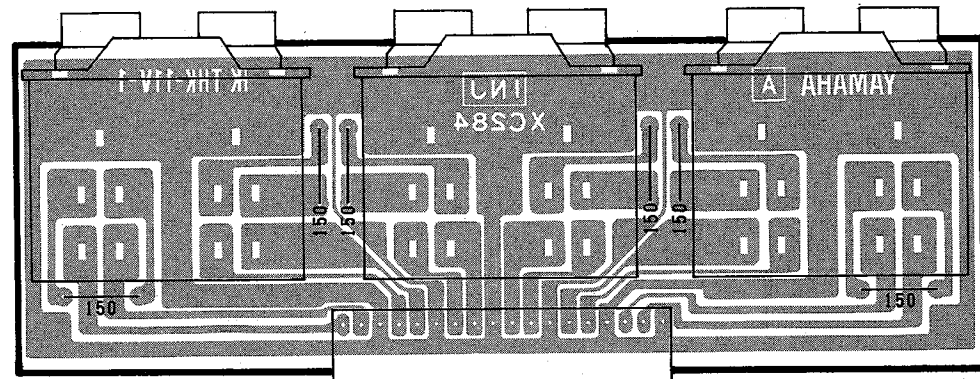

< Components side >

INJ Circuit Board

Circuit Board:
Phone Jack:

XC284A0 16ch
2P HLJ2335

• AC Circuit Board

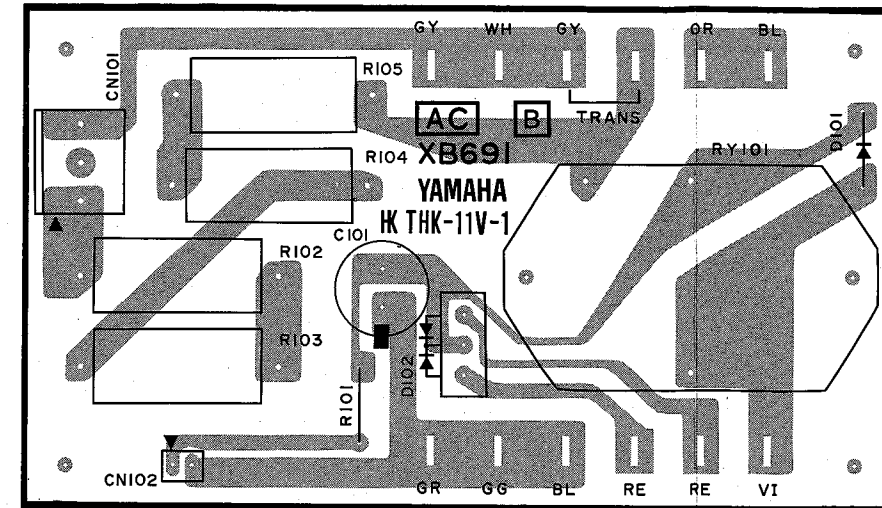

< Components side >

AC Circuit Board

Circuit Board:
D 101:
102:
R 102~105:

RY 101:

XB691B0
1SR35-100A
1D2C1 2A 200V
150Ω 5W J Spec.
180Ω 5W U, C Spec.
560Ω 5W H Spec.
DC12V AR62217

• JK Circuit Board

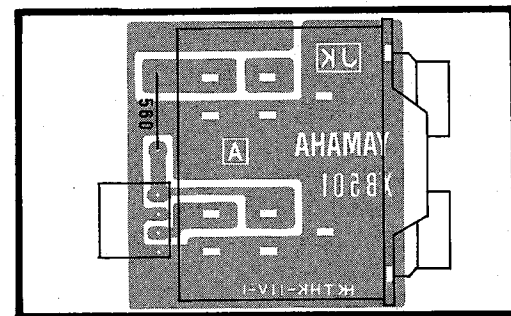

< Components side >

JK Circuit Board

Circuit Board:
Phone Jack:

XB501A0
2P HLJ2335 Stereo

- 3NA-VC95980 :INJ
- 3NA-VC08700 :JK
- 3NA-VC17120 :AC-J
- 3NA-VC17150 :AC-U, C
- 3NA-VC17160 :AC-H

• DC1 Circuit Board

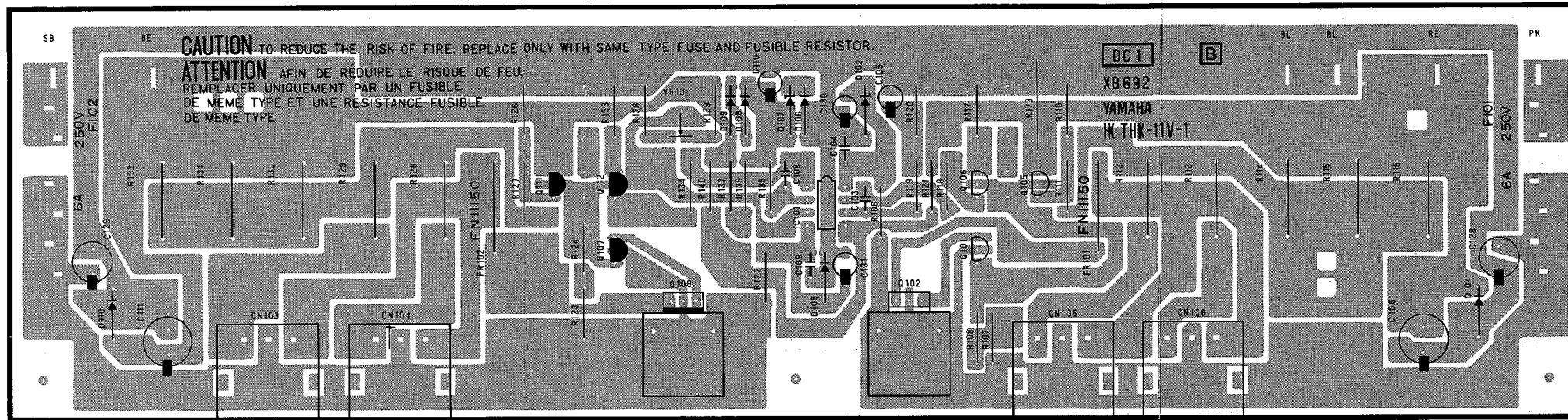

< Components side >

• DC2 Circuit Board

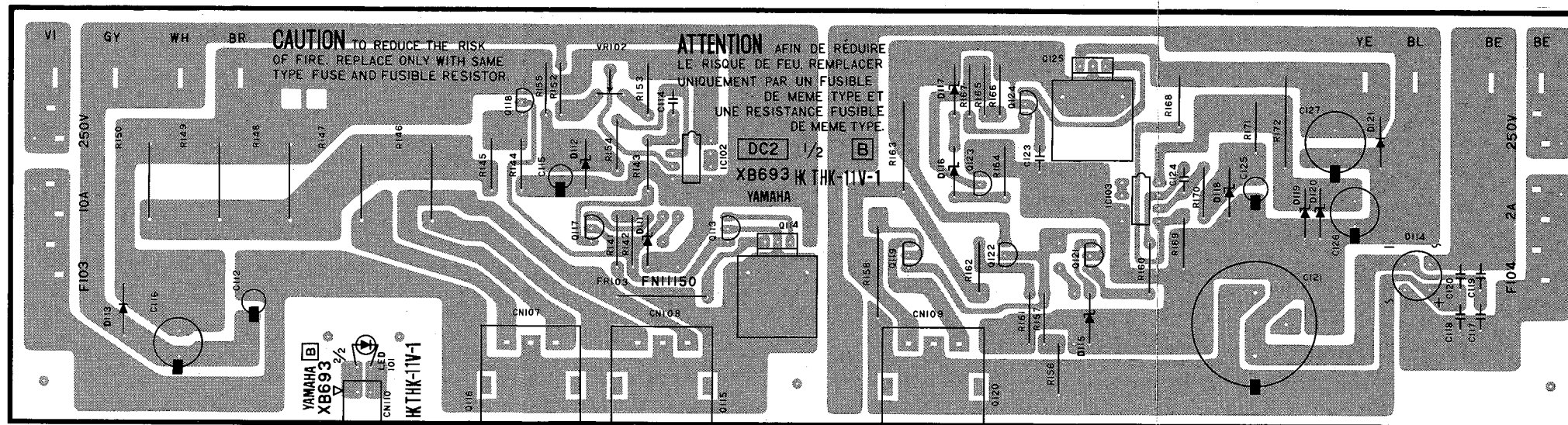

< Components side >

DC1 Circuit Board

Circuit Board:	XB692B0
IC 101:	NJM4558DV (IG001390) OP AMP.
Q 101, 106:	2SC2320 E, F
102:	2SD526 O, Y
105:	2SC1509 R
107, 112:	2SA999 E, F
108:	2SB596 O, Y
111:	2SA777 R
D 103, 105:	RD16EB3
104, 110:	1SR35-100A
106, 108, 109:	1SS176
107:	RD6.2EB2
Resistor	
Marked:	Metal Oxide Resistor
Marked:	Wire Wound Resistor
FR 101, 102:	Fuse Resistor
VR 101:	B2.2KΩ RHA0QJ3
F 101, 102:	T6A 250V J Spec. T6A 250V U, C Spec. T6.3A 250V H Spec.

DC2 Circuit Board

Circuit Board:	XB693C0
IC 102, 103:	NJM4558DV (IG001390)
Q 113:	2SC2320 E, F
122:	2SD667 C, D
114, 125:	2SD526 O, Y
117, 119, 121, 123, 12:	2SC2240 GR, BL
118:	2SC1509 R
D 111, 112, 115, 118:	RD5.6EB2
113, 121:	1SR35-100A
114:	1G4B1 1.5A 400V
116:	RD27EB3
117:	RD33EB2
119, 120:	RD24EB2
LED 101:	LN222RP RE J, U, C Spec LN322GP GR H Spec.
Marked:	Metal Oxide Resistor
FR 103:	Fuse Resistor 15Ω 1W
VR 102:	B2.2K RHA0QJ3
F 104:	T2A 250V J (KB000350) J Spec. T2A 250V U (KB001240) U, C Spec. T2A 250V S (KB000750) H Spec. 10A 250V J (KB001490) J Spec. 10A 250V U (KB001390) U, C, H Spec.

DC1-J:	3NA-VC17170	①
DC1-U, C:	3NA-VC17180	①
DC1-H:	3NA-VC17190	①
DC2-J:	3NA-17200	②
DC2-U, C:	3NA-17210	②
DC2-H:	3NA-17220	②

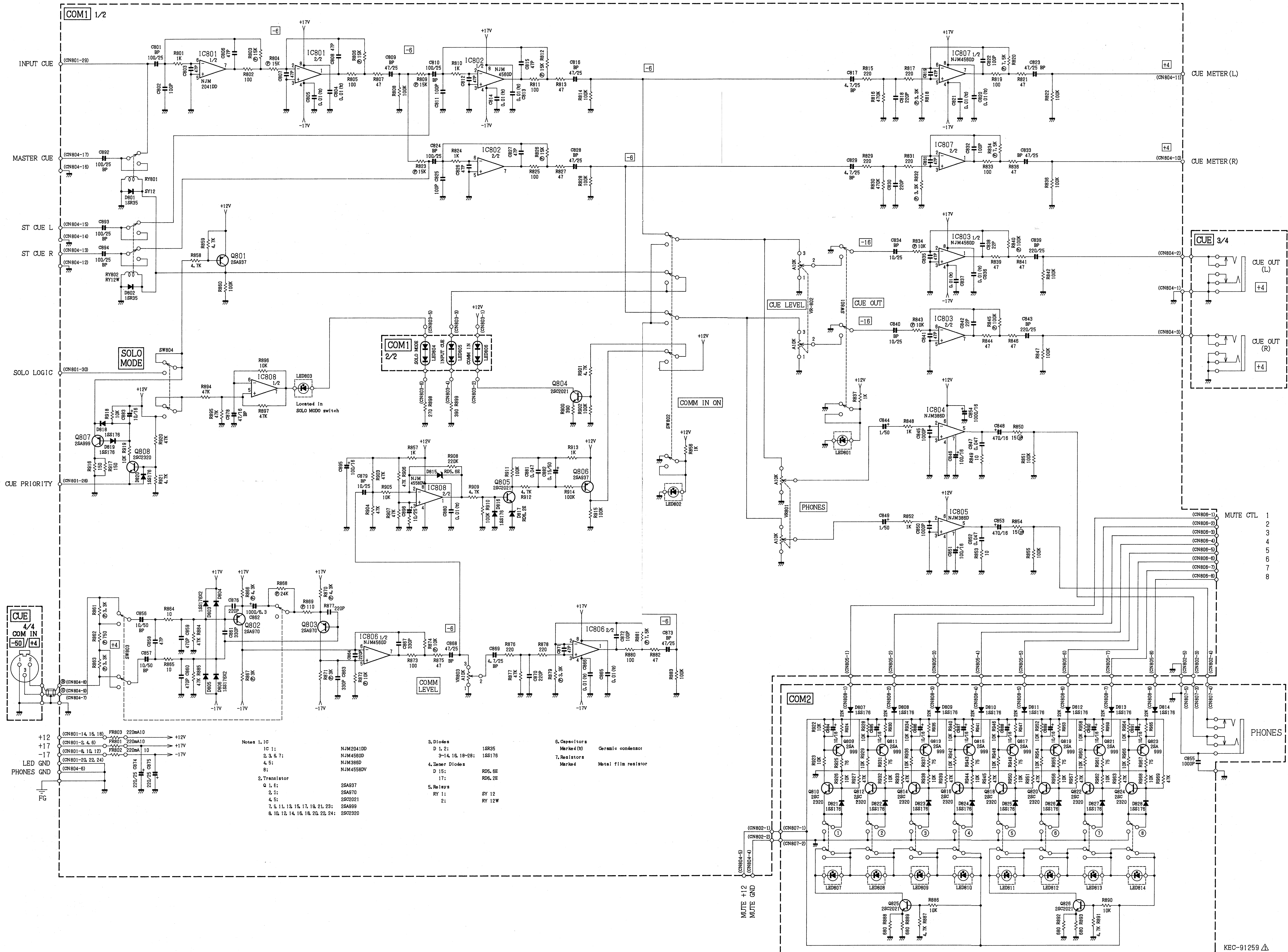

- Notes 1. IC
- 1C 1: NJM2041DD
 - 2, 3, & 7: NJM4560D
 - 4, 5: NJM388D
 - 8: NJM4558DV
2. Transistor
- Q 1, 6: 2SA937
 - 2: 2SA970
 - 4, 5: 2SC2021
 - 7, 8, 11, 13, 15, 17, 19, 21, 23: 2SA989
 - 6, 10, 12, 14, 16, 18, 20, 22, 24: 2SC2320
3. Diodes
- D 1, 2: 1SR35
 - 3-14, 16, 19-28: 1SS176
4. Zener Diodes
- D 15: RD5.6E
 - 17: RD6.2E
5. Relays
- RY 1: SY 12
 - 2: RY 12W
6. Capacitors
- Marked (C): Ceramic capacitor
7. Resistors
- Marked: Metal film resistor

KEC-91259 Δ

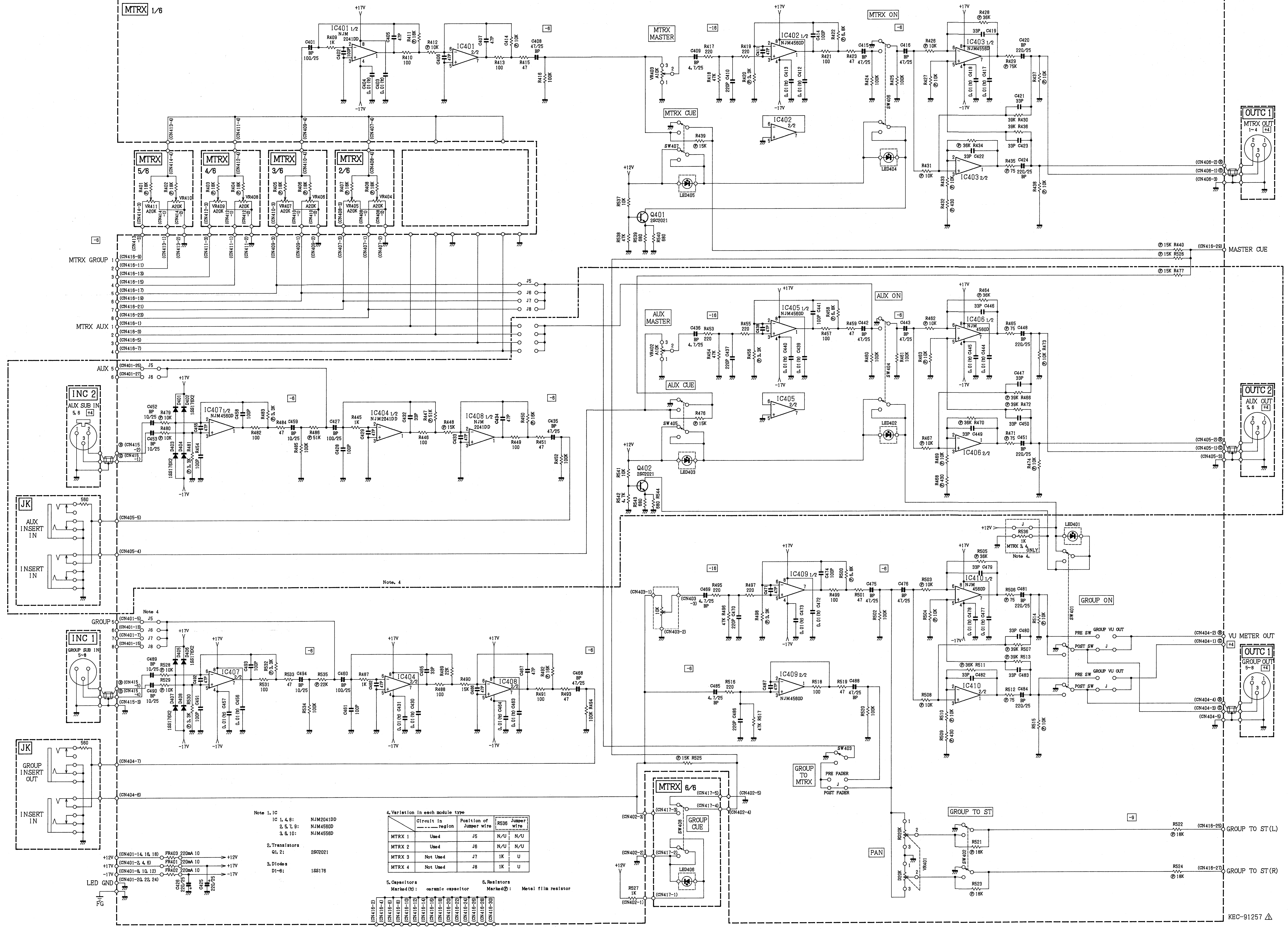

Note 1. IC
 IC 1, 4, 8: NJM2041DD
 2, 5, 7, 9: NJM4558D
 3, 6, 10: NJM4558D

2. Transistors
 Q1, 2: 2SC2021
 3. Diodes
 D1-6: 1SS176

4. Variation in each module type

Module	Circuit in region	Position of Jumper wire	R536 Jumper wire
MTRX 1	Used	J5	N/U
MTRX 2	Used	J6	N/U
MTRX 3	Not Used	J7	1K U
MTRX 4	Not Used	J8	1K U

5. Capacitors
 Marked (C): ceramic capacitor
 Marked (R): Metal film resistor

PM1800 INPUT CIRCUIT DIAGRAM (総回路図)

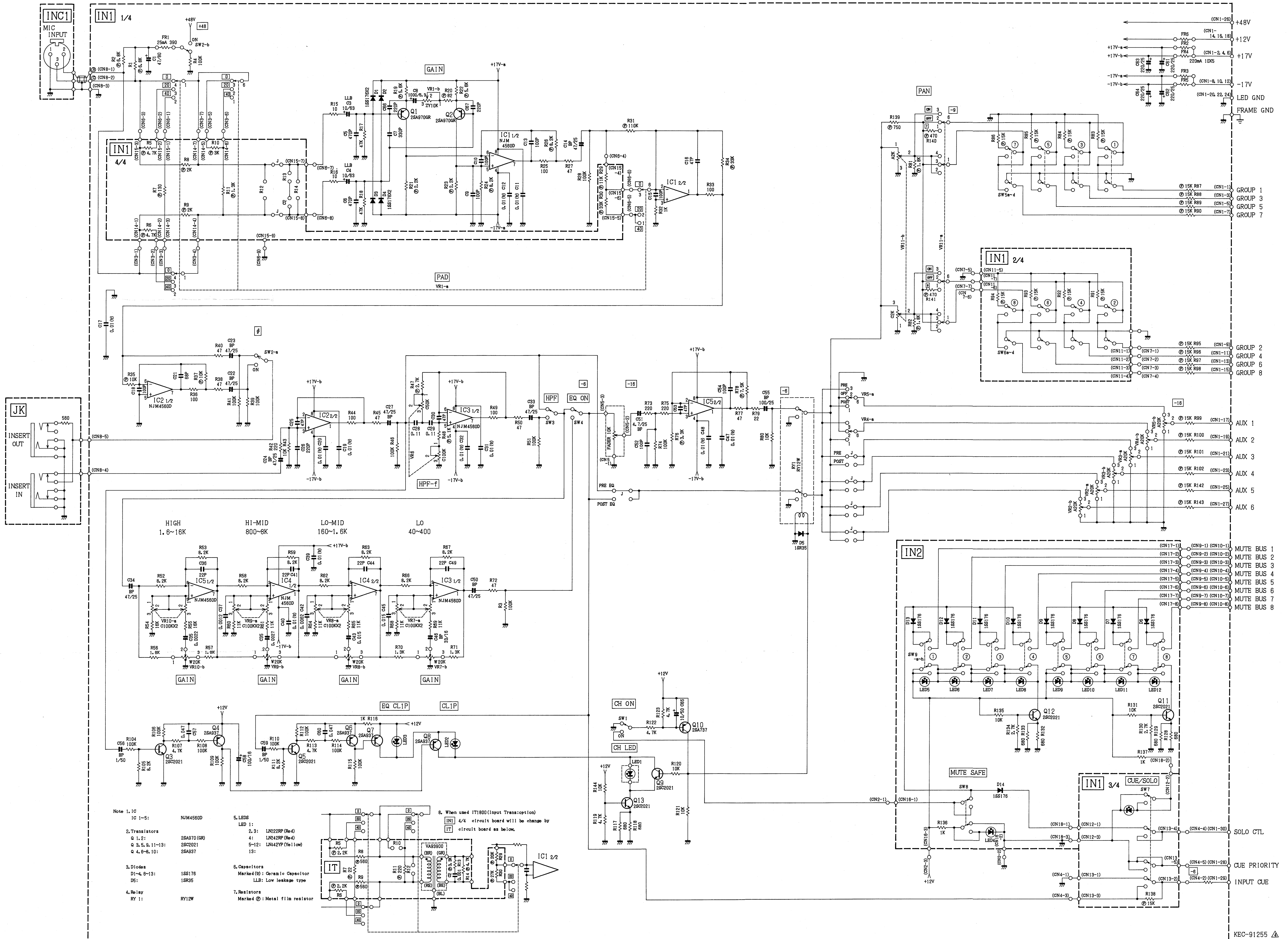

- Note 1. IC
 IC 1-5: NJM4560D
 2. Transistors
 Q 1, 2: 2SA970 (GR)
 Q 3, 5, 9, 11-13: 2SC2021
 Q 4, 6-8, 10: 2SA937
 3. Diodes
 D1-4, 9-13: 1SS176
 D5: 1SR35
 4. Relay
 RY 1: RY12W
 5. LEDs
 LED 1: LN222RP (Red)
 2, 3: LN242RP (Red)
 4: LN242YP (Yellow)
 13:
 6. Capacitors
 Marked (t): Ceramic Capacitor
 LLB: Low leakage type
 7. Resistors
 Marked (t): Metal film resistor

8. When used IT1800 (Input Transpaction)
 [INI] 1/4 circuit board will be change by
 [IT] circuit board as below.

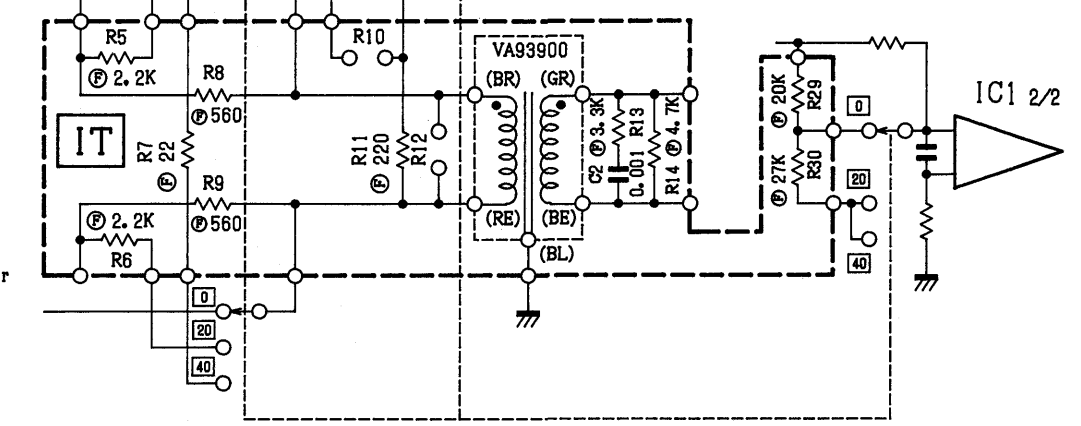

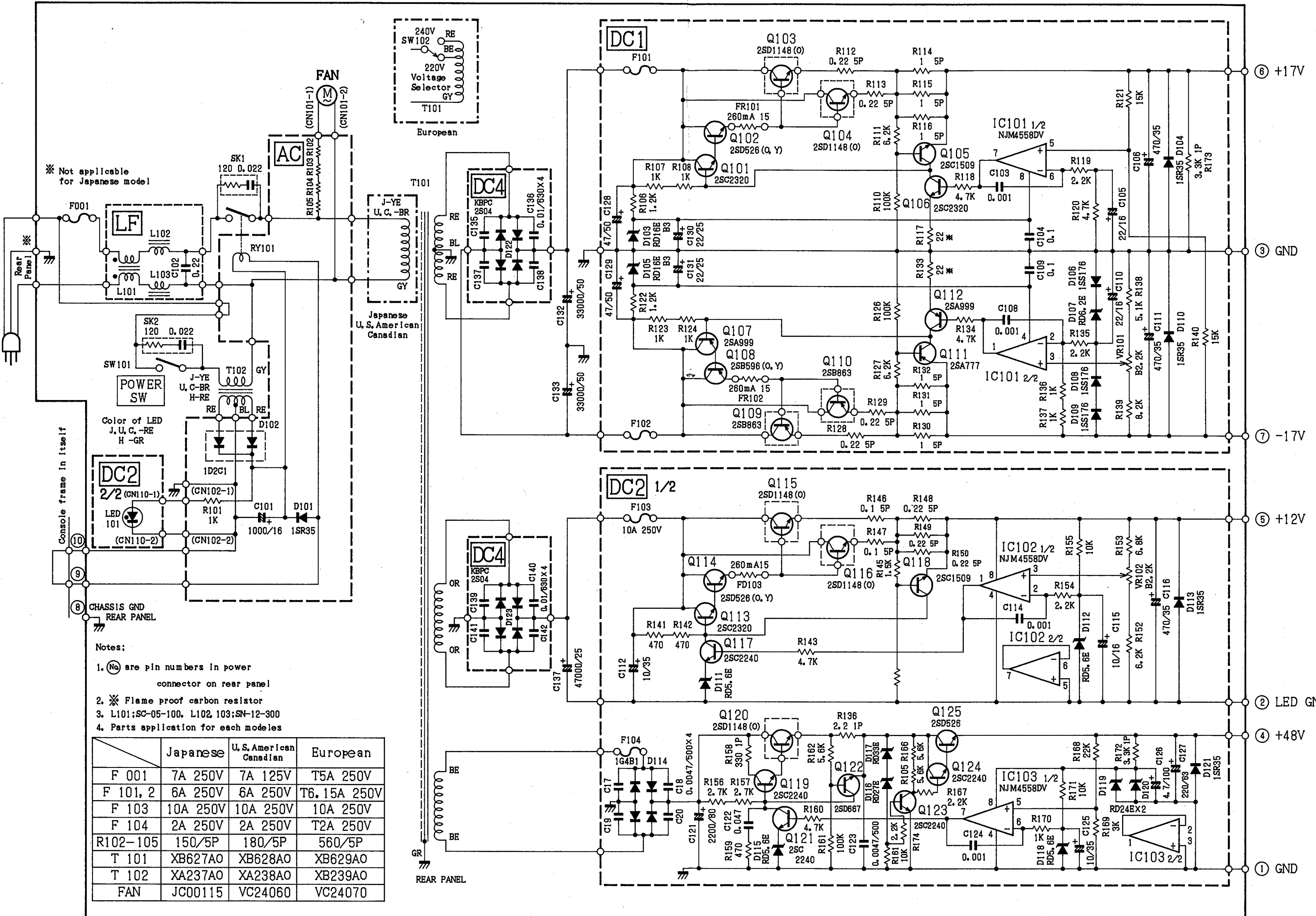

* Not applicable for Japanese model

Console frame in itself

- Notes:
1. (No) are pin numbers in power connector on rear panel
 2. * Flame proof carbon resistor
 3. L101;SC-05-100, L102 103;SN-12-300
 4. Parts application for each models

	Japanese	U.S. American Canadian	European
F 001	7A 250V	7A 125V	T5A 250V
F 101, 2	6A 250V	6A 250V	T6.15A 250V
F 103	10A 250V	10A 250V	10A 250V
F 104	2A 250V	2A 250V	T2A 250V
R102-105	150/5P	180/5P	560/5P
T 101	XB627AO	XB628AO	XB629AO
T 102	XA237AO	XA238AO	XB239AO
FAN	JC00115	VC24060	VC24070