

AMT3000

Low Power AM Broadcast Radio Transmitter Kit

Assembly and Operating Instructions



Copyright © 2003, 2004 by **SSTRAN**. All Rights Reserved.
web: www.sstran.com
e-mail: info@sstran.com

Revision R2
PCB 3000-04-1
July, 2004

TABLE OF CONTENTS

1	Getting Organized	3
	Inventory and Organize Your Parts	3
	Tools You Will Need	3
2	Parts List	5
3	Circuit Board Component Locations	8
4	Tips on Inserting and Soldering Components	9
	Inserting Components	9
	Soldering	9
	Temporary "Tack Soldering"	10
5	Step-by-Step Assembly Instructions	10
	Fixed Resistors	10
	Rear Panel Jacks	10
	Variable Resistors	11
	Resistor Network	11
	Surface Mount IC	11
	IC Sockets	11
	DIP Switches	12
	Rectifiers and Diodes	12
	+5V Voltage Regulator and Transistors	12
	Coils and Chokes	13
	Capacitors	13
	Disc and Multilayer Ceramic Capacitors	13
	Electrolytic Capacitors	14
	Jumper Strip Headers	14
	Ceramic Trimmer Capacitor	14
	Quartz Crystal	14
	+15 Volt Regulator and Heat Sink	15
	LED Power Indicator Lamp	15
	Insert 16-Pin ICs Into DIP Sockets	15
	Jumper Plug Installation	16
	Antenna and Ground Wires	16
6	Final Checks	16
7	Power On Check	16
8	RF Tuning	17
	Setting the Frequency	17
	Setting the RF Output Tuning Range	17
	Peaking the RF Output	17
9	Audio Adjustments	17
	Front Panel Control Functions	17
	Gain Control	17
	Modulation Control	17
	Compression Control	17
	Audio Adjustment Procedure	17
10	Board Jumper Options	18
	A Word About AC Building Wiring Interference Problems	18
	Jumper Plug S1: Audio Source RF Isolation	18
	Jumper Plugs S2 and S3: AC Adapter RF Isolation	18
	Jumper Plug S6: Treble Boost	18
	Jumper Plug S7: Meter Resistor Bypass	18
11	Mounting the Board in the Enclosure	19
12	Final Installation	19
	FCC Antenna Rules	19
	Antenna Location	19
	Ground	20
	Check Tuning	20

	Finish Assembling Enclosure	20
13	Troubleshooting	20
14	Theory of Operation	21
	Oscillator and Frequency Synthesizer Section	21
	RF Power Output Section	21
	Preamplifier and Compressor/Limiter Section	22
	Modulator Section	23
	Power Supply Section	23
15	Warranty, Return and Service Policy	23
	Warranty	23
	Returns	24
	Service	24
	How to Contact SSTRAN	24
16	About FCC Part 15 Regulations	24
17	Component Identification	25
18	Color Code Charts	27
19	Synthesizer Frequency Selection Chart	28
	S4 Switch Settings For 10 kHz Channel-Spacing Models	28
	S4 Switch Settings For 9 kHz Channel-Spacing Models	31
20	RF Output Tuning Range Selection	34
	S5 Frequency Range Switch Settings for 3 Meter Antenna	34
	Frequency Range Graph for 3 Meter Antenna	35
21	Specifications	36
22	Circuit Diagram	37

1 Getting Organized

This manual provides step-by-step assembly instructions to help you complete your kit with the least possible chance for error. Keeping your parts, tools and work area organized will further reduce the chance for error and keep you from getting frustrated looking for a part or tool.

Inventory and Organize Your Parts

Unpack your kit carefully and check each part against the parts list in section 2. Refer to section 17, "Component Identification", for help with identifying parts. During your inventory, check the box next to each part in the parts list.

Some parts, such as resistors and ceramic capacitors, are marked only with color codes or numeric codes. Other parts, such as transistors, voltage regulators and integrated circuits are marked with part numbers. A generic part number shown in the parts list may not correspond exactly with what you see on a component. However, the generic part will appear as part of a sometimes longer component part number. For example, a 74HC40103 (generic part number) integrated circuit may be marked as CD74HC40103E. The generic number is embedded in the actual part number along with varying prefixes and suffixes which may be ignored.

If there is a missing or damaged part, e-mail SSTRAN at ssstran@ssstran.com, and we will send you a replacement. Describe the part completely in your e-mail. Include Reference Designator, Value, Part Marking, and Description from the parts list. Also include your name, shipping address and date of original order.

Tools You Will Need

You will need a few inexpensive tools to assemble your kit:

- a low-wattage (15 - 25 watt) pencil-type soldering iron with a small diameter tip
- small gauge electronic solder, .032" (.81 mm) or smaller diameter flux-core for use in electronic assembly
- small long-nose pliers
- flush-cutting "nippy" wire cutters
- wire insulation stripping tool (a sharp knife is an acceptable substitute)

- solder removal tool
- small screwdriver with an approximately .1" (2.5mm) wide blade
- No. 1 Phillips screwdriver

If you don't have one or more of these tools you can purchase them at your local Radio Shack store or from a mail-order electronics supplier such as www.mouser.com or www.digikey.com. Here are some examples from the Radio Shack on-line catalog on the web at www.radioshack.com.



Radio Shack catalog #: 64-2051. "15-Watt with Grounded Tip. Good choice for integrated circuit work." (It is very important that your soldering iron have a small diameter tip like this one).



Radio Shack catalog #: 64-005: "Standard 60/40 formula rosin core solder. .032", 2.5 oz."



Radio Shack catalog #: 64-2033. "Long-Nose 4-3/4" Mini Pliers"



Radio Shack catalog #: 64-1833. "Flush-cutting nippy cutters fit tight places and lets you trim leads close to PC boards. Spring action."



Radio Shack catalog #: 64-2129. "Adjustable Wire Stripper/Cutter"



Catalog #: 64-1963. "6-Piece Precision Screwdriver Set"



Radio Shack catalog #: 64-2098. "Vacuum Desoldering Tool"

2 Parts List

Refer to section 17, "Component Identification", for help with parts identification. Refer to section 18, "Color Code Charts", for instructions on how to read resistor and RF choke color codes.

Reference Designator	Qty	Value	Part Marking	Description
Fixed Resistors and Resistor Network				
<input type="checkbox"/> R8	1	22 ohms	red-red-black	1/4w carbon film resistor
<input type="checkbox"/> R3	1	100 ohms	brown-black-brown	1/4w carbon film resistor
<input type="checkbox"/> R25, R28, R29	3	220 ohms	red-red-brown	1/4w carbon film resistor
<input type="checkbox"/> R7	1	510 ohms	green-brown-brown	1/4w carbon film resistor
<input type="checkbox"/> R18	1	820 ohms	gray-red-brown	1/4w carbon film resistor
<input type="checkbox"/> R12, R21, R31	3	1K ohms	brown-black-red	1/4w carbon film resistor
<input type="checkbox"/> R17	1	1.5K ohms	brown-green-red	1/4w carbon film resistor
<input type="checkbox"/> R27	1	1.8K ohms	brown-gray-red	1/4w carbon film resistor
<input type="checkbox"/> R4	1	2.7k ohms	red-violet-red	1/4w carbon film resistor
<input type="checkbox"/> R23, R30	2	4.7K ohms	yellow-violet-red	1/4w carbon film resistor
<input type="checkbox"/> R10	1	6.8K ohms	blue-gray-red	1/4w carbon film resistor
<input type="checkbox"/> R6	1	8.2K ohms	gray-red-red	1/4w carbon film resistor
<input type="checkbox"/> R19, R22, R32	3	10K ohms	brown-black-orange	1/4w carbon film resistor
<input type="checkbox"/> R16	1	15K ohms	brown-green-orange	1/4w carbon film resistor
<input type="checkbox"/> R5	1	27K ohms	red-violet-orange	1/4w carbon film resistor
<input type="checkbox"/> R33	1	30K ohms	orange-black-orange	1/4w carbon film resistor
<input type="checkbox"/> R1, R2, R9	3	47k ohms	yellow-violet-orange	1/4w carbon film resistor
<input type="checkbox"/> R26	1	100K ohms	brown-black-yellow	1/4w carbon film resistor
<input type="checkbox"/> R14	1	220K ohms	red-red-yellow	1/4w carbon film resistor
<input type="checkbox"/> R11, R15, R20	3	1M ohms	brown-black-green	1/4w carbon film resistor
<input type="checkbox"/> R13	1	10K ohms	10A103GA	10K ohms x 9, 10 Pin Common Bus Resistor Network.
Jacks, Plug, Variable Resistors and Variable Trimmer Capacitor				
<input type="checkbox"/> J1	1			RCA phono jack r/a pcb white
<input type="checkbox"/> J2	1			RCA phono jack r/a pcb red
<input type="checkbox"/> J3	1			Power jack pcb 2.1mm
<input type="checkbox"/> J4	1			RCA phono jack r/a pcb yellow
<input type="checkbox"/> P4	1			RCA phono plug w/yellow band
<input type="checkbox"/> R34, R36	2	100K ohms	B100K	PC Mount Black Shaft Variable Resistor
<input type="checkbox"/> R35	1	50K ohms	B50K	PC Mount Black Shaft Variable Resistor
<input type="checkbox"/> C5	1	12-100pF	black paint dot	Black, 12-100pF, 7MM Trimmer Capacitor
Fixed Capacitors				
<input type="checkbox"/> C12, C13	2	33pF	33	Ceramic
<input type="checkbox"/> C30	1	180pF	181	Ceramic
<input type="checkbox"/> C15, C27	2	200pF	201	Ceramic

Reference Designator	Qty	Value	Part Marking	Description
<input type="checkbox"/> C23	1	820pF	821	Ceramic
<input type="checkbox"/> C17	1	1000pF	102	Ceramic
<input type="checkbox"/> C14, C16	2	.01uf	.01 or 103	Ceramic Multi-Layer
<input type="checkbox"/> C1, C2, C3, C6, C7, C8, C9, C10, C11, C22, C28, C31, C100, C101, C102, C103	16	.1uF	.1 or 104	Ceramic Multi-Layer
<input type="checkbox"/> C18	1	4.7uF	4.7uF	Electrolytic,
<input type="checkbox"/> C20, C24, C25, C26, C29	5	10uF	10uF	Electrolytic
<input type="checkbox"/> C32	1	100uF	100uF	Electrolytic
<input type="checkbox"/> C4	1	470uF	470uF	Electrolytic
Coils and Chokes				
<input type="checkbox"/> L1, L2, L3	3	1000 uH	1000 uH	RFI Suppression Coil (large)
<input type="checkbox"/> L4	1	56 uH	green-blue-black	Epoxy Coated Choke
<input type="checkbox"/> L5	1	82 uH	gray-red-black	Epoxy Coated Choke
<input type="checkbox"/> L6	1	180 uH	brown-gray-brown	Epoxy Coated Choke
<input type="checkbox"/> L7	1	470 uH	yellow-violet-brown	Epoxy Coated Choke
<input type="checkbox"/> L8	1	1000 uH	brown-black-red	Epoxy Coated Choke
Diodes, Transistors, Voltage Regulators and Quartz Crystal				
<input type="checkbox"/> D1, D2, D3, D4	4	1.0A, 100V	1N4002	Silicon rectifier, 1N4002GP DO-204AL 1.0A 100V
<input type="checkbox"/> D5, D6	2		Red with black end band	Silicon diode, 1N914A DO-35
<input type="checkbox"/> D7	1			T-1 LED lamp green 2.2v 10ma 32 mcd
<input type="checkbox"/> Q1	1		2N3906	2N3906 TO-92 PNP Transistor
<input type="checkbox"/> Q2, Q3, Q4, Q5	4		PN2222A	PN2222A TO-92 NPN Transistor
<input type="checkbox"/> U1	1		L7815	L7815 TO-220 +15V 1A VREG
<input type="checkbox"/> U4	1		L78L05	L78L05 TO-92 +5V 0.1A VREG
<input type="checkbox"/> X1	1		4.000000 (Used in models AMT3000 and AMT3000-SM)	HC-49U Microprocessor Crystal 4.0 MHZ 20pF
	1		3.6000 (Used in models AMT3000-9K and AMT3000-9KSM)	HC-49U Microprocessor Crystal 3.6 MHZ 20pF
Integrated Circuits, DIP Switches and 16-Pin IC Sockets				
<input type="checkbox"/> U2	1		74HC4060	74HC4060 14-Stage Ripple Binary Counter, 16-pin DIP
<input type="checkbox"/> U3, U5	2		74HC40103	74HC40103 8-bit synchronous binary down counter, 16-pin DIP
<input type="checkbox"/> U6	1		SSM2166S	SSM2166S Microphone Preamplifier with Variable Compression & Noise Gating, 16-pin SOIC surface mount
<input type="checkbox"/> U7	1		74HC4046	74HC4046 Phase-Locked Loop, 16-pin DIP
<input type="checkbox"/> IC sockets for U2, U3, U5, U6	4			DIP SOCKET, 16 PIN

Reference Designator	Qty	Value	Part Marking	Description
<input type="checkbox"/> S4	1			8 Pos DIP switch, extended actuator
<input type="checkbox"/> S5	1			4 Pos DIP switch, extended actuator
Miscellaneous				
<input type="checkbox"/> S1, S2, S3, S6, S7 (jumper headers)	5			.230 8PIN STR .100" Pin Strip Headers. Supplied as a 5-pair strip to be cut per assembly instructions.
<input type="checkbox"/> S1, S2, S3, S6, S7 (jumper plugs)	5			2-POS. JUMPER OPEN BLACK
<input type="checkbox"/> PC Board	1		3000-02	5" x 3.9" printed circuit board
<input type="checkbox"/> Control Knobs	3			BLACK .50"D X .61"H Plastic Knob
<input type="checkbox"/> Enclosure bottom section	1			ENCLOSURE BOTTOM 6.08X4.26X.375, BONE
<input type="checkbox"/> Enclosure top section	1			ENCLOSURE TOP 6.08X4.26X1.175, BONE
<input type="checkbox"/> Enclosure front panel	1			ENCLOSURE FRONT 5.75X1.311, BLACK
<input type="checkbox"/> Enclosure rear panel	1			ENCLOSURE REAR 5.75X1.311, BLACK
<input type="checkbox"/> Enclosure Screws	2			Pan Head Phillips Screw Type B, #4 X 3/4"
<input type="checkbox"/> Enclosure feet	4			Plastic self-adhesive protective feet.
<input type="checkbox"/> PC Board Mounting Screws	4			Pan Head Phillips Screw Type B, #4 X 1/4"
<input type="checkbox"/> Heat Sink	1			HEAT SINK, TO-220/126/127 low profile 0.750L x 0.750W x 0.375H
<input type="checkbox"/> Heat Sink Mounting Screw	1			Pan Head Phillips Machine Screw, #6-32 X 1/4"
<input type="checkbox"/> Heat Sink Mounting Lock Washer	1			Spring Lock Washer, #6
<input type="checkbox"/> Heat Sink Mounting Nut	1			Machine Screw Nut, #6-32
<input type="checkbox"/> Antenna Wire	1			White wire, 22AWG, 7/30 stranded, PVC, 118 in. (2.99 m)
<input type="checkbox"/> Ground Wire	1			Black wire, 22AWG, 7/30 stranded, PVC, 6 ft. (183 cm)
<input type="checkbox"/> AC Adapter	1		18VAC 500MA	18VAC 500MA 2.1MM F AC Adapter

3 Circuit Board Component Locations

The top of the circuit board is screen printed with component outlines and component reference designators to assist you with finding where to insert parts and which way to orient certain parts that must be inserted in a specific direction. The reference designator numbers begin at the top left corner of the board and increment from left to right across the board roughly along each row of components. The references then continue to increment at the left in the next row of components. The highest numbered references are at the bottom right corner. This is a guideline only, since the components are not always in well defined rows.

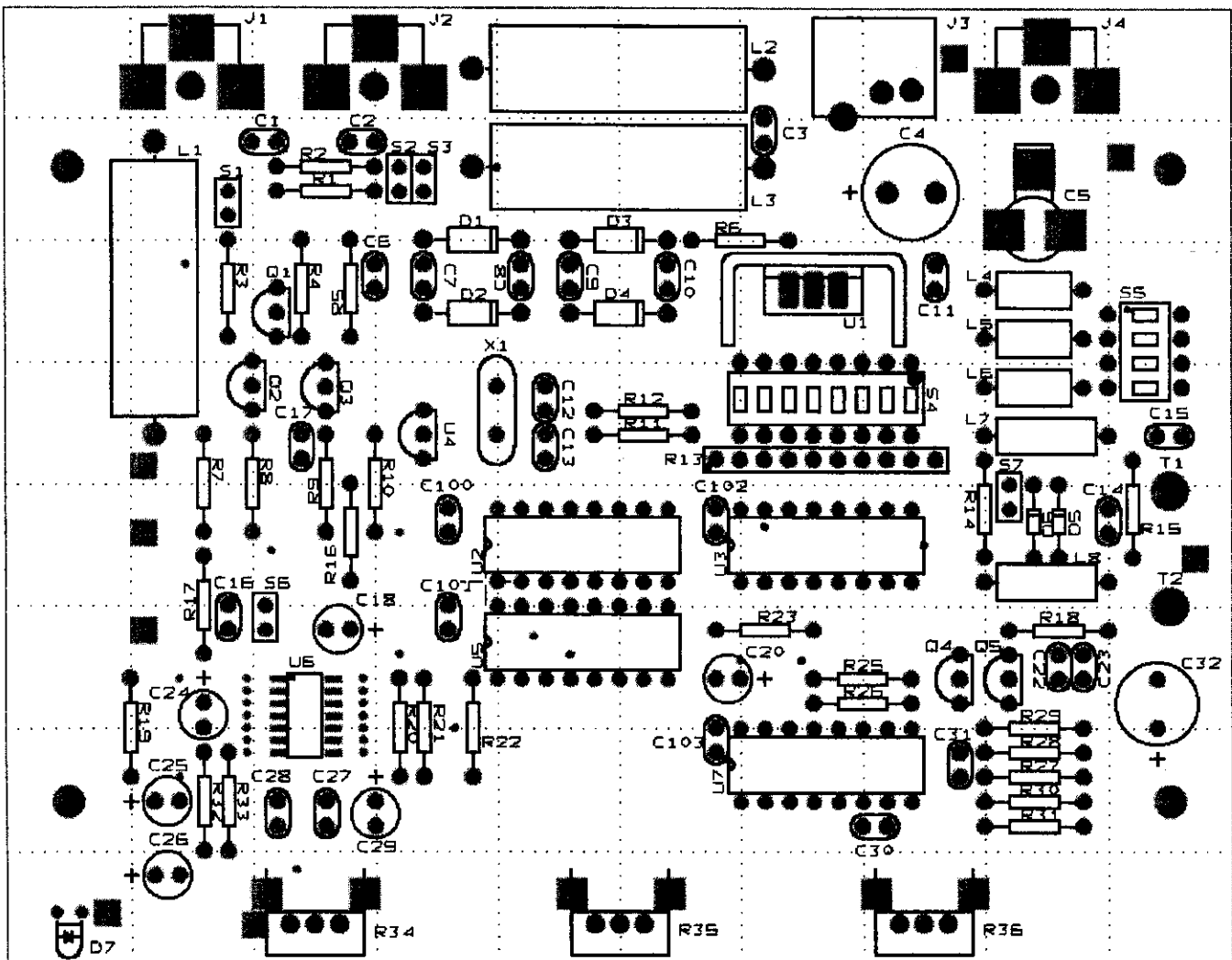

4 Tips on Inserting and Soldering Components

Inserting Components

Except as noted later for transistors, all components should be mounted flush with the surface board.

All axial lead components such as resistors, chokes, and diodes require the leads to be bent at right angles. Bend the leads to match the hole spacing for each component. Leads can be bent by hand or with pliers.

All other components such as capacitors, switches, IC sockets, controls and jacks, have radial leads or pins that do not require bending other than to straighten or align leads to fit the hole spacing.

Never force a component into the board. If a component doesn't go in easily, remove it and re-bend the leads until they match the board hole pattern.

After inserting each component that has wire leads, bend the leads outward slightly at the bottom surface of the board to hold the component flush with the board while you apply solder.

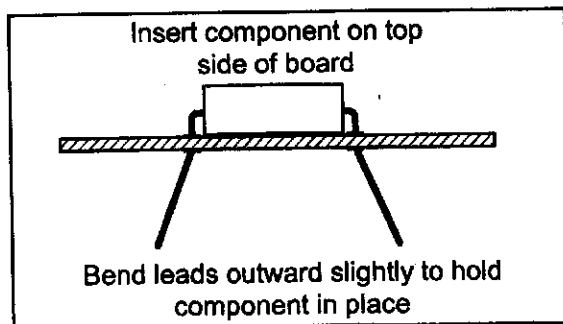

Soldering

All soldering is done on the bottom side of the board. Assembly will go faster if you insert several components before you turn the board over for soldering.

Before soldering, be sure the iron is hot. This may take up to 5 minutes for some irons. Clean the soldering iron tip by wiping it on a damp cloth or sponge. Tin the tip by melting a small amount of solder over the surface of the tip. The tip should always be shiny before soldering. It will get dull with oxidation after a few minutes. When this happens, wipe and tin the tip again.

A component lead is soldered correctly when solder flows onto both the lead and the board pad, and forms a small,

shiny mound over the pad. This creates a good electrical connection. A poor solder connection will cause failure of your kit to operate properly. All components used in this kit are highly reliable. If the kit doesn't work properly, the cause is very likely to be a bad solder connection.

To solder a connection place the soldering iron tip so that it contacts the board pad and the lead at the same time.

Feed the solder by touching the end of the solder to the soldering iron tip and pad simultaneously. Stop feeding solder when it looks like enough has melted to form a mound over the pad. Let the solder flow around the lead and into the hole before removing the soldering iron. If the solder doesn't melt and flow within 2 or 3 seconds, you probably need to re-clean and re-tin the tip. Never heat a connection for more than 5 seconds at a time or you could damage the component or the board.

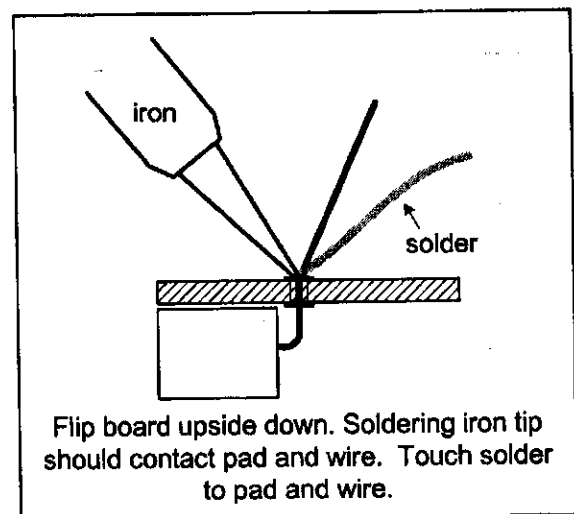

If a soldered connection doesn't look good, clean and tin the soldering iron tip again and reheat the connection while applying a little more solder if necessary.

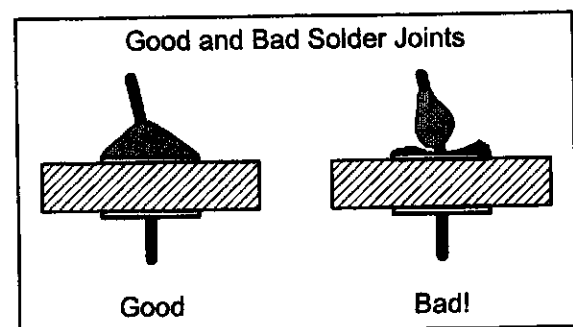

If you accidentally apply too much solder or bridge two nearby pads on the board, use your solder removal tool to remove the excess solder. Then, re-apply solder if necessary until the connection looks good.

After soldering, cut any wire leads just above the solder mound using nipper wire cutters. Components that mount with lugs (controls and jacks) or pins (IC sockets and DIP switches) do not require the leads to be cut after soldering.

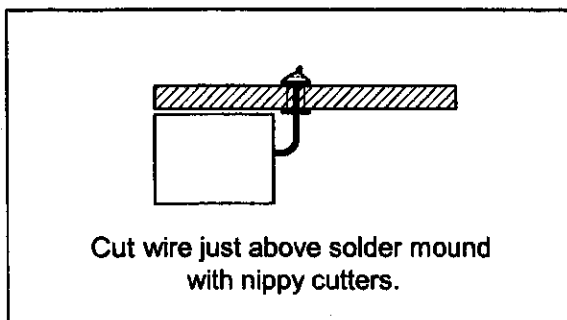

Temporary "Tack Soldering"

At several places in the assembly instructions we refer to the term "tack solder". This is a technique for holding a part in place before you apply solder properly. To tack solder a lead or pin to its board pad, clean and tin your iron and then apply addition solder to the tip until a small ball forms. Immediately touch the tip to the wire and pad to get some solder flow. This is only temporary. After you solder the other leads or pins on the component, go back and re-solder the tacked pads.

5 Step-by-Step Assembly Instructions

Fixed Resistors

All resistors are 1/4 Watt. Only the first three color bands are shown below. You may ignore the fourth tolerance band color.

- R8 22 ohms (red-red-black)
- R3 100 ohms (brown-black-brown)
- R25 220 ohms (red-red-brown)
- R28 220 ohms (red-red-brown)
- R29 220 ohms (red-red-brown)
- R7 510 ohms (green-brown-brown)
- R18 820 ohms (gray-red-brown)
- R12 1K ohms (brown-black-red)
- R21 1K ohms (brown-black-red)

- R31 1K ohms (brown-black-red)
- R17 1.5K ohms (brown-green-red)
- R27 1.8K ohms (brown-gray-red)
- R4 2.7k ohms (red-violet-red)
- R23 4.7K ohms (yellow-violet-red)
- R30 4.7K ohms (yellow-violet-red)
- R10 6.8K ohms (blue-gray-red)
- R6 8.2K ohms (gray-red-red)
- R19 10K ohms (brown-black-orange)
- R22 10K ohms (brown-black-orange)
- R32 10K ohms (brown-black-orange)
- R16 15K ohms (brown-green-orange)
- R5 27K ohms (red-violet-orange)
- R33 30K ohms (orange-black-orange)
- R1 47k ohms (yellow-violet-orange)
- R2 47k ohms (yellow-violet-orange)
- R9 47k ohms (yellow-violet-orange)
- R26 100K ohms (brown-black-yellow)
- R14 220K ohms (red-red-yellow)
- R11 1M ohms (brown-black-green)
- R15 1M ohms (brown-black-green)
- R20 1M ohms (brown-black-green)
- R24 No component. Leave this location empty.

Rear Panel Jacks

Important: All jacks must be seated squarely in place against the board before soldering to ensure proper alignment with the holes in the enclosure rear panel. The RCA jacks will snap into the board holes, holding them in place adequately for soldering. You may need to bend the three outer tabs slightly outward from the center to get proper snap-in action. The power jack (J3) does not snap in. You can press it against the board with a finger while tack soldering several pins to hold it in place. When soldering all jacks, flow plenty of solder until all holes are completely filled for mechanical stability.

- J1 RCA phono jack with white insulator
- J2 RCA phono jack with red insulator
- J3 Power jack

A note about antenna jack (J4): FCC rule 15.203, "Antenna Requirement", prohibits manufacturers from incorporating a readily available connector for the antenna. To comply with this rule, we must instruct you to permanently attach the antenna wire by soldering it to the circuit board. If you as the builder choose to install an antenna/ground jack on the board, the kit will then be considered to be modified by the user as regards FCC compliance and SSTRAN cannot be responsible. Instructions for attaching the antenna and ground wires appear later in this manual at the end of the step-by-step assembly instructions.

Variable Resistors

Important: like the jacks above, the variable resistors (R34, R35 and R36) must be seated squarely in place against the board before soldering so they will align properly with the holes in the enclosure front panel. They will snap into the board holes, holding them in place adequately for soldering. You may need to bend the side tabs slightly inward to get them to snap in properly.

- R34 100K ohms (marked B100K)
- R35 50K ohms (marked B50K)
- R36 100K ohms (marked B100K)

Resistor Network

Important: orient the resistor network SIP package so the dot marking pin-1 on the package is aligned with the dot on the board outline.

- R13 10K ohms x 9, 10-Pin SIP Common Bus Resistor Network (marked 10A103GA)

Surface Mount IC

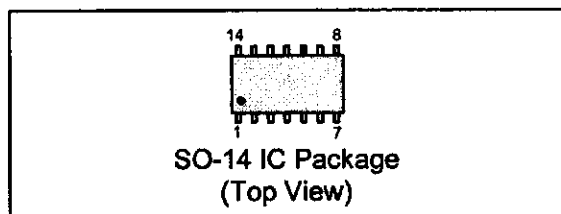

Important: ICs are static sensitive. Touch a grounded surface to discharge any static electricity from your body before handling the ICs. Avoid shuffling your feet or

sliding around on a chair while handling the ICs. If you move around, touch a grounded surface again.

Soldering the surface mount IC (U6) requires some extra care. Just take a little more time on this one, it really isn't hard to do. If you have trouble seeing close up, you may want to use a magnifying eye loop or a pair of inexpensive high-magnification reading glasses available from drug or variety stores. Be sure your soldering iron tip is clean and tinned, then melt a small amount of solder (not a big glob!) on the tip in preparation for tack soldering.

1. Position the IC on the board, over the outline for U6, so the dot marking lead 1 on the IC is oriented over the dot on the board outline. Slide it around until you are satisfied that the IC leads are over the pads on the board. Hold in place with a finger.
2. Tack solder one corner lead by touching the iron to the lead and pad until you get some solder flow.
3. Recheck alignment of the remaining leads. Reposition the IC slightly if necessary to get alignment. Then tack solder the lead on the diagonally opposite corner from the one you just did. The IC is now firmly in place.
4. Solder the remaining leads normally. Because so little solder is required on each lead, it works well to apply a small amount of solder to the tip and then touch the tip to a lead and pad. Repeat this for each lead. *
5. Go back to your original corner leads and ensure they are soldered properly.

* If you accidentally bridge two adjacent leads with solder, don't panic! It's no big deal. Clean and tin your soldering iron tip and wipe off excess solder. Now touch the tip to the solder between the bridged leads and slide the tip outward to wipe the bridged solder away from the leads. If this doesn't work, use your vacuum de-soldering tool to suck away the solder bridge and then reflow the leads if necessary.

- U6 SSM2166S Microphone Preamplifier, 16-pin SOIC surface mount.

IC Sockets

Important: Orient each socket such that the semicircular notch on one end of the socket is over the notch on one end of the board outline. If you mistakenly orient a socket the wrong way, it will still work. Don't bother trying to remove it. Just be careful later when inserting the IC to orient it according to the board outline and not the reversed socket.

Before inserting, visually check that all pins are straight. Don't force the socket into the board holes. If you feel resistance, straighten any pins that aren't aligned properly. Seat the socket against the board. While holding the socket in place with a finger, tack solder 2 diagonally opposite end pins on the bottom side of the board. Solder the remaining pins and properly solder the previously tack-soldered end pins.

- U2 16-pin DIP socket.
- U3 16-pin DIP socket.
- U5 16-pin DIP socket.
- U7 16-pin DIP socket.

DIP Switches

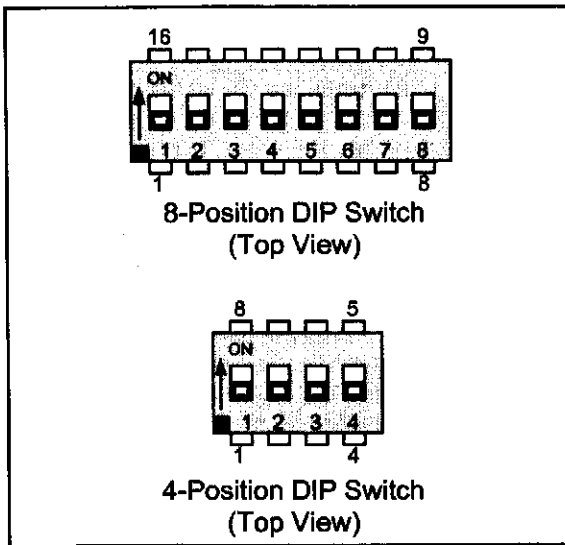

Important: Orient each switch package such that the pin-corner is over the dot on the board outline.

Before inserting, visually check that all pins are straight. Don't force the switch into the board holes. If you feel resistance, straighten any pins that aren't aligned properly. Seat the switch against the board. While holding the switch in place with a finger, tack solder 2 diagonally opposite end pins on the bottom side of the board. Solder the remaining pins. Then properly solder the previously tack-soldered end pins.

- S4 8 position DIP switch
- S5 4 position DIP switch

Rectifiers and Diodes

Important: Orient rectifiers and diodes so the band on one end of the component is over the line on one end of the board outline.

Bend leads 90 degrees at the component ends to match the board hole spacing before inserting.

- D1 1N4002 silicon rectifier.
- D2 1N4002 silicon rectifier.
- D3 1N4002 silicon rectifier.
- D4 1N4002 silicon rectifier.
- D5 1N914A silicon diode
- D6 1N914A silicon diode

+5V Voltage Regulator and Transistors

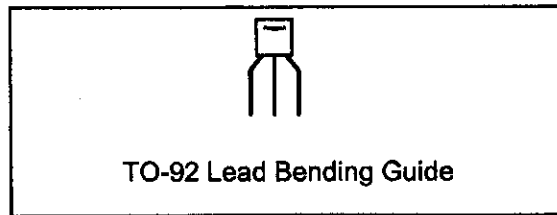

Important: All transistors and the +5V voltage regulator have the same TO-92 package style. Because they all look alike, carefully check the part markings before insertion to get them all in the right places. Orient each component to match the board outline. Beginning at the body of the component, bend the two outer leads outward as shown in the illustration. After bending the outer leads, you should be able to insert the component until the bottom of the plastic body is about 1/8 in. or less from the board. Don't force it down. Remove and re-form the outer leads if necessary.

- U4 L78L05 TO-92 +5V 0.1A VREG
- Q1 2N3906 TO-92 PNP transistor
- Q2 PN2222A TO-92 NPN transistor
- Q3 PN2222A TO-92 NPN transistor
- Q4 PN2222A TO-92 NPN transistor
- Q5 PN2222A TO-92 NPN transistor

Coils and Chokes

There are two types of inductors used in this kit: large RFI suppression coils and small epoxy coated chokes. The epoxy coated chokes look similar to resistors and use the same color code as resistors. They have various diameters, but all are larger than the diameter of a resistor. If you are not sure whether a device is a resistor or a choke, measure its resistance with a meter. All chokes will measure less than 15 ohms. The DC resistance of a choke is a measurement of the resistance of the wire coil and has no relation to its inductance value. The measured DC resistance of a choke will not correspond to a resistor color code interpretation.

Only the first three color bands are shown below. You may ignore the fourth tolerance band color.

- L1 1000 uH RFI Suppression Coil (marked 1000uH)
- L2 1000 uH RFI Suppression Coil (marked 1000uH)
- L3 1000 uH RFI Suppression Coil (marked 1000uH)
- L4 56 uH (green-blue-black)
- L5 82 uH (gray-red-black)
- L6 180 uH (brown-gray-brown)
- L7 470 uH (yellow-violet-brown)
- L8 1000 uH (brown-black-red)

Capacitors

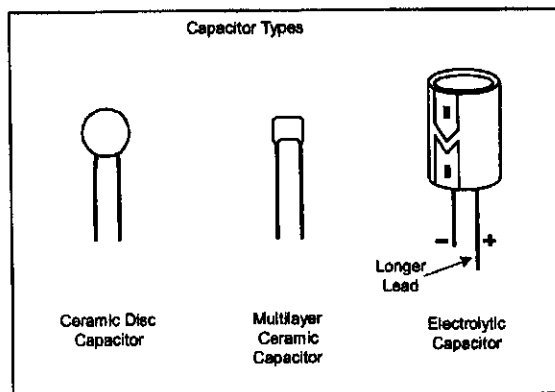

Disc and Multilayer Ceramic Capacitors

The number shown in parenthesis is the value code marked on the device.

- C12 33 pF (33) ceramic
- C13 33 pF (33) ceramic
- C30 180 pF (181) ceramic
- C15 200 pF (201) ceramic
- C27 200 pF (201) ceramic
- C23 820 pF (821) ceramic
- C17 1000 pF (102) ceramic
- C14 .01 uF (103 or .01) ceramic multi-layer
- C16 .01 uF (103 or .01) ceramic multi-layer
- C1 .1 uF (104 or .1) ceramic multi-layer
- C2 .1 uF (104 or .1) ceramic multi-layer
- C3 .1 uF (104 or .1) ceramic multi-layer
- C6 .1 uF (104 or .1) ceramic multi-layer
- C7 .1 uF (104 or .1) ceramic multi-layer
- C8 .1 uF (104 or .1) ceramic multi-layer
- C9 .1 uF (104 or .1) ceramic multi-layer
- C10 .1 uF (104 or .1) ceramic multi-layer
- C11 .1 uF (104 or .1) ceramic multi-layer
- C22 .1 uF (104 or .1) ceramic multi-layer
- C28 .1 uF (104 or .1) ceramic multi-layer
- C31 .1 uF (104 or .1) ceramic multi-layer
- C100 .1 uF (104 or .1) ceramic multi-layer
- C101 .1 uF (104 or .1) ceramic multi-layer
- C102 .1 uF (104 or .1) ceramic multi-layer
- C103 .1 uF (104 or .1) ceramic multi-layer

Electrolytic Capacitors

Important: Electrolytic capacitors are polarized and must be inserted in the proper direction. The negative (-) lead is on the side with the vertical stripe. The positive (+) lead is opposite the stripe and is longer. Always insert the + lead into the hole marked with a "+" next to the board outline.

The number shown in parenthesis is the value marked on the device.

- C18 4.7 uF (4.7uF) electrolytic
- C20 10 uF (10uF) electrolytic
- C24 10 uF (10uF) electrolytic
- C25 10 uF (10uF) electrolytic
- C26 10 uF (10uF) electrolytic
- C29 10 uF (10uF) electrolytic
- C32 100 uF (100uF) electrolytic
- C4 470 uF (470uF) electrolytic
- C21 No component. Leave this location empty.

Jumper Strip Headers

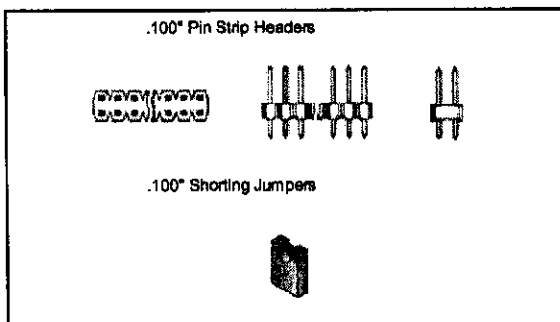

The jumper headers are supplied as one strip containing five pairs of jumper headers. You will need to cut this strip into four pieces: three single-pair headers and one double-pair header. Lay the strip on its side on a flat surface. Place the blade of a sharp utility knife in the first groove separating the jumper header pairs. Apply downward pressure until the strip snaps at the groove. Now you have one single-pair header and one 4-pair header. Repeat this procedure two more times to get two more single-pair headers and a double-pair header (total of 3 single-pair headers and one double-pair header). Insert the short leads into the board. The long leads are the right length to receive the shorting plugs (installed later).

- S1 Single-pair jumper header.
- S2 and S3 Double-pair jumper header.
- S6 Single-pair jumper header.
- S7 Single-pair jumper header.

Ceramic Trimmer Capacitor

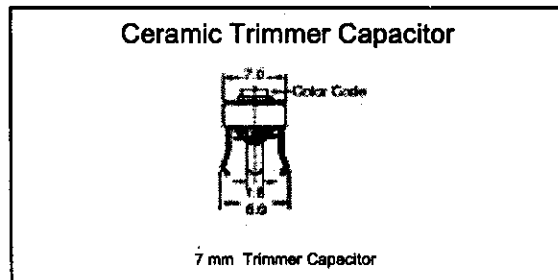

Match the shape of the trimmer capacitor to the board outline for C5. The trimmer will snap into the holes, holding it in place for soldering.

- C5 12 - 100 pF 7 mm, ceramic trimmer capacitor

Quartz Crystal

- X1 HC-49U Microprocessor Crystal (4.000) for models AMT3000 and AMT3000-SM
- OR
- X1 HC-49U Microprocessor Crystal (3.600) for models AMT3000-9K and AMT3000-9KSM

+15 Volt Regulator and Heat Sink

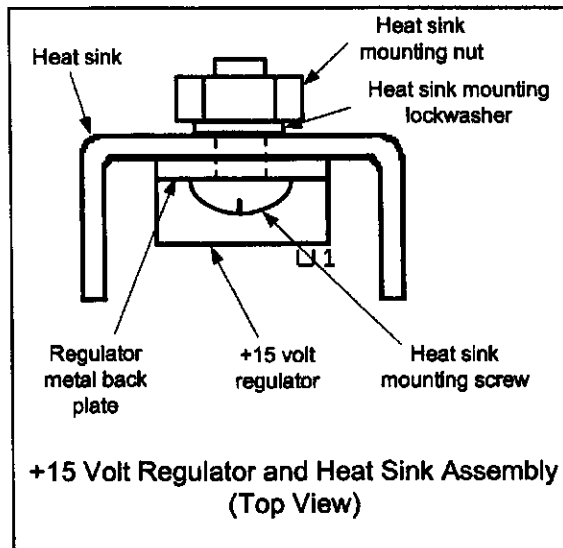

Insert the +15 volt regulator at location U1, oriented such that the metal back plate on the regulator faces the rear edge of the board. Solder the regulator in place.

U1 L7815 TO-220 +15V 1A VREG (L7815)

Following the illustration, mount the heat sink on the regulator. The heat sink must be oriented such that the mounting hole in the heat sink is toward the top. In this position, the bottom of the regulator will be close to the board. Insert the mounting screw through the regulator and then through the heat sink. Install the lock washer and nut, and tighten.

- Heat Sink.
- Heat sink mounting screw (#6-32 X 1/4").
- Heat sink mounting lock washer (#6).
- Heat sink mounting nut (#6-32).

LED Power Indicator Lamp

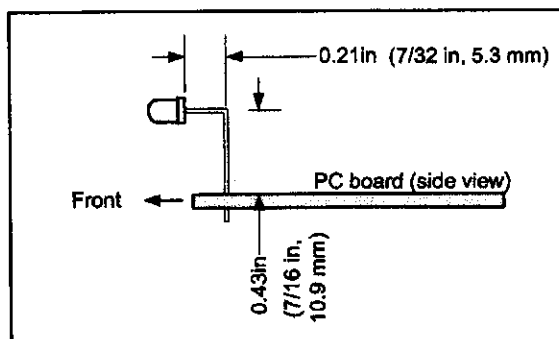

To allow the LED lamp to properly engage the front panel hole, the leads must be bent as shown. The illustration above is printed actual size so you may use it as a template. Hold the LED horizontally with the shorter (cathode) lead facing you. Bend both leads downward at a right angle at a point .21" (7/32", 5.3 mm) from the LED body. Insert the leads into the board at location D7 with the longer lead on the "arrow" side and the shorter lead on the "line" side of the D7 "arrow-line" board outline. Slide the LED up or down in the holes until you measure .43" (7/16", 10.9 mm) from the top of the board to the bend in the leads. Tack solder one lead on the top side of the board. Re-check the height measurement and then solder the other lead and reflow solder to the tacked lead.

D7 Green LED lamp

Insert 16-Pin ICs Into DIP Sockets

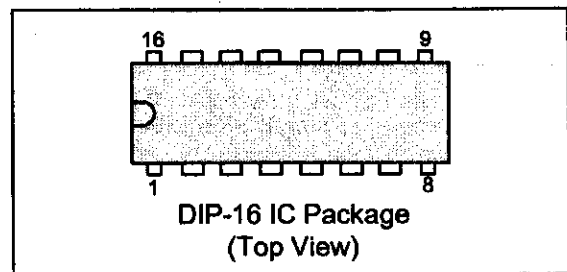

Important: ICs are static sensitive. Before handling ICs you should be sure to discharge any static electricity from your body by touching a grounded metal surface. Avoid shuffling your feet or sliding around on a chair while handling the ICs. Touch that grounded surface frequently while working with the ICs.

The ICs must be mounted in their sockets in one direction only or they may be damaged when power is applied. The ICs are keyed with a notch in the top of one end or a dimple in the top corner of one end. Align the keyed end with the notched end of the socket (which will also be the notched end on the board component outline if the socket was installed properly).

Before inserting the ICs into their sockets you must first bend the leads on each side slightly inward to engage the socket pins properly. This can be done neatly by laying the IC on its side on a flat surface and pressing downward lightly on the IC body until the bottom leads start to bend slightly. This will keep all leads in a straight line. Do this to each side equally. Straighten any misaligned pins with your fingers or small pliers. Trial fit the IC into its socket. Re-bend any pins that are still out of alignment. When you are satisfied that all pins are aligned, press the IC as far as it will go down into the socket using firm, equal pressure on both ends. If it won't go, one or more pins may not be aligned. Remove the IC and re-bend any

pins as necessary. You can remove an IC from its socket by alternately prying each end slightly with a small screwdriver until it is free.

- U2 74HC4060 14-Stage Ripple Binary Counter, 16-pin DIP (74HC4060)
- U3 74HC40103 8-bit synchronous binary down counter, 16-pin DIP (74HC40103)
- U5 74HC40103 8-bit synchronous binary down counter, 16-pin DIP (74HC40103)
- U7 74HC4046 Phase-Locked Loop, 16-pin DIP (74HC4046)

Jumper Plug Installation

Initially install the five jumper header plugs according to the following steps. You can change the options later, but this will get you going. A jumper plug may be installed in either the shorted or open position. A plug is in the shorted position when it is plugged onto both header pins. It is in the open position when only one terminal is plugged onto one pin of the header. This provides a convenient place to store the jumper plug for possible later use in the shorted position.

- S1 Install in shorted position.
- S2 Install in shorted position.
- S3 Install in shorted position.
- S6 Install in open position.
- S7 Install in open position.

Antenna and Ground Wires

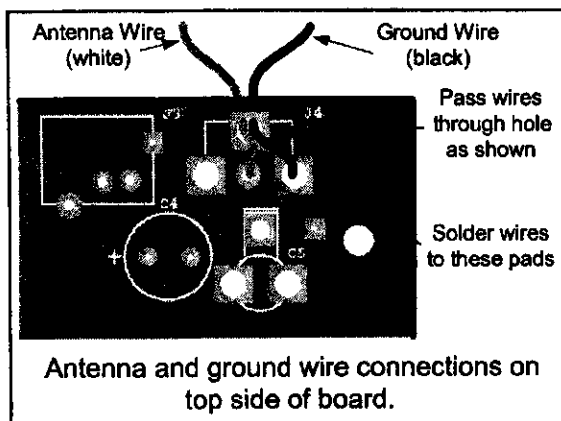

Using wire strippers or a sharp knife, remove about 1/8" (3.2mm) of insulation from one end of the white antenna wire and one end of the black ground wire, being careful not to nick or cut any of the wire strands. Pass the wires up from the bottom side of the board through the hole shown in the illustration. This will provide strain relief. Then on the top side, insert the stripped ends of the wires into the holes shown in the illustration. Solder the stripped ends of the wires into the holes.

- Antenna Wire White, 118 in.
- Ground Wire Black, 72 in.

Congratulations! Your board is now fully assembled.

6 Final Checks

Your board is now fully assembled. Take a little time now to visually check your work. Here are some final inspection steps.

- Are all step-by-step assembly instructions checked in this manual?
- Are all electrolytic capacitors, diodes, transistors, voltage regulators and ICs installed in the proper direction?
- Visually inspect the board with a magnifying glass. Look at every pad on the bottom of the board systematically from one corner to the opposite diagonal corner. Look for: unsoldered or poorly soldered connections, wires not clipped properly, solder bridges between adjacent pads, and wires that may be bent over and touching a nearby pad.

7 Power On Check

Place the assembled circuit board on an insulated surface such as a wooden table top or a sheet of cardboard, plastic or heavy paper.

Plug the AC adapter cord into the power jack (J3).

For initial testing, just string the antenna and ground wires out away from the board. The ground wire doesn't need to be connected to ground for initial testing.

Connect an audio source such as a CD or cassette player to the audio input jacks, J1 and J2.

Plug the AC adapter into a 120 volt outlet. The green LED power indicator should light up.

Follow the procedures in section 8, "RF Tuning" and section 9, "Audio Adjustments" to verify the unit is operational.

8 RF Tuning

Setting the Frequency

Find a clear frequency on a nearby AM radio receiver between 530 kHz and 1700 kHz. Try to choose a clear frequency at the high end of the band. The antenna operates more efficiently at higher frequencies. Find your desired frequency in the chart in section 19, "Synthesizer Frequency Selection Chart", of this manual. Set the 8-position frequency selection DIP switch (S4) according to the chart. Use a small screwdriver to slide each of the eight switches to the specified on or off position.

Setting the RF Output Tuning Range

Set the tuning range that includes your desired frequency on the 4-position DIP switch (S5) according to the chart in section 20, "RF Output Tuning Range Selection", of this manual. Use a small screwdriver to slide each of the four switches to the specified on or off position.

Peaking the RF Output

Locate the meter test point holes labeled T1 and T2 on the right side of your circuit board. Insert the positive (red) probe from your meter into T1. Insert the negative (black) probe into T2. The meter mode and range switches should be initially set to measure voltages as high as about 15 VDC. The meter must be a 10 megohm/volt or higher analog or digital meter to give a good reading. Turn the transmitter Gain control fully counterclockwise. Use a small screwdriver to adjust the trimmer capacitor, C5, through its entire range (one full turn) until you observe a voltage peak. Usually you will see two voltage peaks as you rotate one full turn. Either peak may be chosen. Set the trimmer at the high point of the peak. Note this voltage reading. Next try setting the output tuning range switch, S5, to the next lower or higher range and re-tune the trimmer capacitor. Repeat until you find the S5 switch setting that give the highest voltage peak. If you are using a digital meter, peak by adjusting the trimmer slightly and waiting for a stable reading. Repeat until you are satisfied with the peak. Don't try to get a precise peak down to the last digit! A reading within a volt or two of peak is satisfactory.

9 Audio Adjustments

Front Panel Control Functions

Gain Control

The gain control varies the audio level feeding the SSM2166 preamplifier stage and serves to compensate for a wide range of possible audio input levels. Rotating the control clockwise increases the gain.

Modulation Control

The modulation control sets the limiting level of the compressor/limiter. Rotating the control clockwise increases the limiting level, which in turn, increases the maximum amplitude of the audio to the modulation stage, increasing the modulation percentage.

Compression Control

The compression control varies the audio compression over a range between 1:1 (no compression) and 5:1 (maximum compression). Rotating the control clockwise increases compression.

Audio Adjustment Procedure

Initially set the three front panel controls as follows: *Gain* control fully clockwise, *Modulation* and *Compression* controls fully counterclockwise. Connect an audio source playing music that has a fairly constant volume range. Listen on a nearby radio. Follow these steps:

Rotate the *Modulation* control clockwise until the received signal begins to distort due to over-modulation. Back off from this point until the distortion goes away. This is approximately the 100% modulation point. Rotate the *Gain* control counterclockwise until you reach a point where the volume just begins to decrease. At this point limiting will only occur on audio peaks. The *Compression* control may be set in any position according to your preferences. A good way to observe the effect of the Compression control is to play a classical music CD with very quiet and very loud portions. As the Compression control is rotated clockwise you will notice that the volume of the quiet and loud portions begin to be the same.

Don't confuse over-modulation distortion with distortion that may be caused by your receiver being overloaded by the strong RF signal from the transmitter. If necessary, move the receiver farther away or reorient it to reduce the signal being picked up by it's antenna.

Your audio source level may not be high enough if you can't reach the distortion point in step 2 with both the Gain and Modulation controls in their maximum clockwise positions and the Compression control in the full counterclockwise position. You can compensate for

lower level inputs by increasing the Compression. This will boost the audio signal, but you may get more compression than you desire, depending on your tastes.

10 Board Jumper Options

The four jumper headers labeled S1, S2, S3 and S6 on the circuit board provide grounding options and a treble boost option. Jumper header S7 should always remain open.

A Word About AC Building Wiring Interference Problems

RF isolation of the transmitter ground from the AC building wiring may be of benefit if you experience hum induced on the transmitted signal due to interaction of the transmitted RF field and the AC building wiring. The RFI suppression coils (L1, L2 and L3) may optionally be inserted in series with the ground paths to an AC powered audio source device (L1) and to the AC wiring through the AC wall adapter (L2 and L3). With all three coils enabled (not shorted by jumper plugs), you must connect the transmitter black ground wire to an earth ground or the transmitter will not function properly.

In general it is better to operate without RF ground isolation. Your transmitter range will generally be farther without RF ground isolation. Before you use the isolation options to reduce possible hum, thoroughly check your audio source connection for hum problems. Hum on the audio signal is usually caused by a break in the shield connection in the audio cable or in an audio connector.

Jumper Plug S1: Audio Source RF Isolation

Jumper S1 allows you to optionally connect the transmitter ground directly to the audio input cable ground (S1 jumper in shorted position) or to insert L1 in series with the ground side of the two audio jacks (S1 jumper in open position).

If you choose the isolation option (S1 jumper open) you may not experience much difference unless you also choose the open positions for S2 and S3. Otherwise there is still a ground path to the AC wiring through the AC adapter. Also with S1 in the open position you may need to connect the black transmitter ground wire to a good earth ground point. You will need to re-peak the trimmer capacitor, C5, each time to change the S1 option.

Jumper Plugs S2 and S3: AC Adapter RF Isolation

Jumpers S2 and S3 allow you to optionally isolate the transmitter from the RF ground path through the AC adapter transformer to the building wiring. With jumpers S2 and S3 removed, the RFI suppression coils, L2 and L3

are placed in series with the two wires from the AC adapter. You will need to re-peak the trimmer capacitor, C5, each time to change the S2 and S3 options.

Jumper Plug S6: Treble Boost

Installing jumper plug S6 in the shorted position will add about 8 dB of treble boost to the audio with the midpoint of the boost curve at 2 kHz. Installing S6 in the open position will result in a flat audio response.

Since treble boost is introduced after the SSM2166 compressor/limiter, you will probably need to readjust the modulation control counterclockwise somewhat to prevent over-modulation distortion at the higher audio frequencies.

Jumper Plug S7: Meter Resistor Bypass

This jumper header must always remain open. This jumper is provided as a convenience for shorting across resistor R14 when the transmitter is modified for driving the low impedance SSTRAN base-loaded vertical antenna. Plans for building this antenna and instructions for modifying the AMT3000 are published on the sstran.com web site.

11 Mounting the Board in the Enclosure

First locate all enclosure parts:

- Plastic enclosure bottom section (.375" high)
- Plastic enclosure top section (1.1" high)
- Black plastic front and rear panels
- Four #4 X 1/4" thread forming screws
- Two #4 X 3/4" thread forming screws
- Four self-adhesive enclosure feet.
- Three control knobs

Mount the printed circuit board and assemble the enclosure using the following steps:

1. Separate the four self-adhesive enclosure feet with scissors or a sharp knife. Peel off the backing paper and attach the feet to the bottom of the enclosure near the four corners.
2. Slide the front panel down into the slot on one of the wide sides of the bottom enclosure section (the enclosure is symmetrical with respect to front and rear, it doesn't matter which wide side you pick).
3. Lay the board down on the bottom enclosure section and slide it forward so that the control shafts protrude through the front panel holes.
4. Lift the rear of the board slightly and hold the black plastic rear panel over the jacks while sliding the rear panel down into the slot at the rear of the bottom enclosure section.
5. Reposition the board so the four mounting screw holes in the board align with the four plastic screw bosses on the bottom enclosure section. Check that the power indicator LED is engaged into the hole in the front panel. You may need to bend the LED leads slightly to properly position the LED in the front panel hole.
6. Secure the board to the bottom enclosure section with four #4 X 1/4" thread forming screws. Tighten the screws only to the point where there is no longer any movement of the board.
7. Mount the three control knobs on the front-panel control shafts. To mount a knob, loosen the set screw with a small-blade screwdriver, slide the knob onto the shaft as far as it will go without contacting the panel and then tighten the set screw lightly against the control shaft to hold the knob in place.

Leave the top enclosure section off for now to allow access for re-tuning after you move the transmitter to its final location.

12 Final Installation

The location of your transmitter will affect its range. Generally the higher the better, However, its range is adequate to cover a whole house no matter where it is located, even in a basement. Because it draws so little AC power, you may elect to place it out of the way on a shelf or in a closet and leave it powered on continuously. Once you set the tuning and audio controls properly, your transmitter will not require further adjustment. You may use extra long audio cables (up to 25 ft) to feed the transmitter if it is located remotely from the audio source. Cables longer than 25 ft. may attenuate higher audio frequencies due to the additional capacitance of the cables. If you use longer cables, you may be able to compensate for audio high frequency loss by enabling the transmitter treble boost option or by boosting the treble at the audio source.

FCC Antenna Rules

When installing your transmitter, keep in mind the FCC rule that governs antenna and ground lengths. Rule 15.219 states: "The total length of the transmission line, antenna and ground lead (if used) shall not exceed 3 meters." Your transmitter does not have a transmission line, so you only need to be concerned with the total length of the white antenna wire and the black ground wire (if used). This total length is not to exceed 3 meters. You may need to cut the wires that are supplied in order to comply with this requirement.

Antenna Location

For best range the white antenna wire should be strung as vertically as possible and should be positioned away from grounded metal objects and electrical wiring. Secure the antenna wire as needed to keep it from moving around to prevent tuning variations.

Ground

A good, low impedance ground is required for best range. Just as a transmitter will not work without an antenna, it likewise will not work without a ground. A "ground" is simply any path from the transmitter circuit ground to earth ground that provides a low RF impedance. The AMT3000 has been designed to provide a low RF impedance path to ground through the AC adapter and your building wiring. Additionally, when you connect the transmitter via audio cables to an AC powered audio source, there is likely to be a low RF impedance through the audio cable outer shields and then through the building wiring connected to the audio source device. These "built in" ground paths will provide good performance in many cases, but variations in building wiring and transmitter location may require you to ground the transmitter directly to a separate earth ground. You should experiment by connecting the AMT3000 black ground wire to whatever ground sources are available at your transmitter location until you find the optimum arrangement. You can try connecting the ground wire to the center screw on a wall outlet, a copper water pipe, a copper heating pipe, or possibly a forced air heating register if your ductwork provides a continuous conductive path back to the furnace ground. Also one or more interconnected grounding rods driven into the earth will work well. Grounding rods are available at electrical supply stores. Also a very good ground can be established by burying bare copper wires so they fan out in a radial pattern from a center common point connected to the transmitter ground wire.

Refer back to section 10, "Board Jumper Options" for the optional ground isolation jumper settings. You can experiment with different jumper options and ground wire connections if you are not satisfied with the "default" shorted position of jumpers S1, S2 and S3.

Check Tuning

Whenever you change the antenna position or ground connection you will need to re-peak the RF output. Generally, all that is required is to readjust the trimmer capacitor, C5, but in some cases, you may need to set the 4-position DIP switch S5 to the next higher or lower tuning range to get the highest voltage peak on your meter.

Finish Assembling Enclosure

1. Orient the top enclosure section with respect to the bottom section so that the tabs and slots on the sides will engage properly (the top mates with the bottom only one way).
2. Slip the top enclosure section down over the front and rear panels so that the panels engage the slots in the front and rear of the top enclosure section.
3. Secure the top enclosure section to the bottom enclosure sections using two #4 X 3/4" thread forming screws inserted through the two holes on the bottom side of the enclosure. Tighten only to the point where there is no longer any play between the enclosure sections. These two screws may be removed at any time to access the circuit board for frequency changes or re-tuning if the location of the transmitter or antenna is changed.

13 Troubleshooting

If your transmitter does not work, the cause is most likely one of the following:

- Unsoldered or poorly soldered connections.
- Solder shorts across adjacent pads
- Components mounted in the wrong locations
- Polarized components mounted in the wrong orientation
- Misinterpretation or mistakes made when setting DIP switches.

Start troubleshooting by carefully inspecting all the solder connections. Look for unsoldered connections and solder bridges across adjacent pads. While inspecting, keep your soldering iron plugged in and ready. If you see any connection that looks the least bit suspect, re-solder it just to be sure.

Check the installation of all parts for proper location and orientation. Check the 16-pin ICs for any pins that may have been bent while plugging them into their sockets.

In the unlikely event of a component failure, you will need some knowledge of electronic troubleshooting methods and an understanding of how the transmitter operates. Refer to section 14, "Theory of Operation" and to section 22, "Circuit Diagram" to learn how the transmitter works.

Start by checking the voltages at the power pin of all IC's with a meter. Also check the voltages marked on the schematic around the transistors in the modulator and RF output stages.

You can home in on a problem by first determining whether it is in the RF or the Audio section of your transmitter. If you can receive the carrier at the frequency you have selected, but there is no audio, then the problem is in the audio sections. If you can't receive the carrier at all, then the problem is in the synthesizer or RF output stage.

Use of an oscilloscope to trace back to the failing area will make troubleshooting much easier.

If you are really stuck, or don't want to spend the time fixing it, refer to section 15, "Warranty, Return and Service Policy" for information on our repair service.

14 Theory of Operation

This section presents a description of the operation of the AMT3000. Referring to the circuit diagram in section 22 will aid in understanding the description.

The AMT3000 has five major functional sections: (1) Oscillator and Frequency Synthesizer, (2) RF Power Output, (3) Preamplifier and Compressor/Limiter (4), Modulator and (5) Power Supply.

Oscillator and Frequency Synthesizer Section

IC U2 serves as both a crystal oscillator and a frequency divider. The oscillator produces a 4 MHz signal whose frequency is determined by the 4.000 MHz Quartz Crystal (X1). The oscillator output is then divided by 16 to produce a 250 kHz square wave at U2 pin 7. IC U5 further divides the 250 kHz output of U2 by 25 to produce a constant 10 kHz reference signal at U5 pin 14.

ICs U7 and U3 work together as a programmable frequency multiplier. The 10 kHz reference signal is multiplied by the integer value selected by dip switch (S4) to produce the final AM band output frequency in 10 kHz increments. U7 is a phase locked loop (PLL), containing a phase comparator and a voltage controlled oscillator (VCO). The VCO is set to operate in the AM broadcast band range by capacitor C30 and resistor R23. The VCO output at U7 pin 4 feeds the U3 CP (clock) input, U3 pin 1. IC U3 counts down by one on every clock. When the counter reaches zero, it automatically parallel loads from the 8 input pins (P7-P0). Each input pin, P7-P0, is high (logic 1) or low (logic 0) when its switch is open or closed respectively. U3 output pin 14 pulses low for one clock while the count equals zero, producing a waveform that has a frequency equal to the VCO frequency divided by $n+1$ where n is the binary value of S4. The divided VCO frequency is connected back to the PLL phase comparator CMP IN input, U7 pin 3. The phase comparator PH CMP II output, U7 pin 13, produces high-level pulses when the divided VCO frequency is lower than the 10 kHz reference frequency, U7 pin 14 (SIGNAL IN), and produces low-level pulses when the divided VCO frequency is higher than 10 kHz. When the two frequencies are equal, the PH CMP II output of U7 goes to a high impedance state and the PLL is in the locked state.

Resistors R26 and R25 and capacitor C20 form a low-pass filter to smooth the pulses from the PH CMP II output pin resulting in a DC voltage which is connected to U7 input pin 9 (VCO IN) to control the VCO frequency. The average value of VCO IN will rise or fall, raising or lowering the VCO frequency, until the SIGNAL IN and CMP IN frequencies and phases are identical at which point the PLL becomes locked. This voltage is held by capacitor C20 while the PH CMP II output is in the high impedance state. Any drifting of the VCO frequency causes PH CMP II to pulse high or low as required until the frequency is corrected.

Complete descriptions of the 74HC-series ICs used in the AMT3000 are provided in datasheets available in downloadable PDF form from various manufacturer's websites. You can find the datasheet for a particular part by searching the web for "74HCxxxx datasheet".

RF Power Output Section

The design of the RF power output stage of the AMT3000 is an important contributor to its overall modulation quality. The output stage operates in class C mode, which simply means that the output transistor switches fully on and fully off at the RF carrier frequency rate. This results in higher efficiency than output stages that operate in the linear region. Modulation is applied to the output stage by varying the on-state emitter current to the output transistor at the input audio rate.

Output transistors Q4 and Q5 are connected to form a differential pair switching circuit. The VCO OUT signal from U7 pin 4 is applied to the base of Q4 through C31 and R27. Q4 is driven into saturation (on-state) when VCO OUT is high and to cutoff (off-state) when VCO OUT is low. Due to the biasing and common emitter connection of Q4 and Q5, when Q4 switches on, Q5 switches off, and vice versa. The current, determined by Q2, flows through either Q4 when VCO OUT is high or through Q5 when VCO OUT is low.

The transmitter RF output is taken from the collector of Q5, through DC blocking capacitor C22, to the pi-network tuning and antenna matching circuit. Because Q5 switches fully on and fully off at the RF rate, the Q5 collector current switches between zero and the instantaneous audio-rate current determined by modulation transistor Q2. The instantaneous modulation current determines the amplitude of the RF output signal, thus achieving amplitude modulation. For a 100% modulated carrier, Q5 collector current will vary at the audio rate from zero at full negative modulation to twice the unmodulated current at full positive modulation. RF choke L8 allows DC current to flow to Q5 but blocks the RF output from being shorted to the +15 volt supply. Resistor R18 across L8 limits the voltage swing across L8 to maintain a good modulated RF envelope for poorly tuned or very short antennas. It has little effect when a normal 2 - 3 meter long antenna is used and the output network is tuned properly.

The pi-network antenna matching circuit, consisting of C23, L4-L7 and tuning capacitor C5, is designed to transform the low impedance at the collector of Q5 to the high impedance of a short (3 meter) antenna. The resonant frequency is determined by the switch-selectable combined inductance of L4, L5, L6 and L7, and the total capacitance of C23 in series with the parallel combination of tuning capacitor C5 and the antenna capacitance. Switch S5 allows selectively shorting each of the four inductors, yielding 15 inductance values ranging from 56 uH minimum to 788 uH maximum. The variable tuning capacitor, C5, allows resonant peaking over a range of frequencies for each selected inductance value. The frequency range graph in section 20 shows the approximate tuning range for each setting of switch S5. The ranges are designed to overlap significantly to assure coverage of all frequencies. For any given frequency S4 should be set for the maximum inductance that still covers the desired frequency of operation. This minimizes the capacitance of C5 that is required for resonance resulting in more power being delivered to the antenna.

Preamplifier and Compressor/Limiter Section

IC U6 provides the functions of audio amplification and variable audio compression and limiting. Audio input signals connected to J1 and J2 are isolated from each other by R1 and R2 and summed across the GAIN control (R34). Even though the AMT3000 is monophonic, two inputs are provided for properly mixing stereo audio sources. A mono source may be connected to either J1 or J2. The GAIN control allows attenuating very high level input signals to prevent overloading the preamplifier input. The mixed audio signal is applied through C28 to U6 pin 7 (+ AUDIO IN). C27 is an RF bypass capacitor to prevent stray transmitter RF from being coupled into the high impedance U6 input. The gain of the U6 preamplifier stage is set at 12 dB by resistors R32 and R33. Capacitor C24 couples the preamplifier output to the Voltage Controlled Amplifier (VCA) input. The VCA is where the compression and limiting functions occur. Resistor R19 sets the VCA gain at 16 dB. The output of the VCA appears on U6 pin 13 (OUTPUT) and feeds the transmitter modulation stage. The COMPRESSION control, variable resistor R36, controls the audio compression ratio. R36 may be adjusted to set compression anywhere between a minimum 1:1 dB ratio (no compression) to a maximum 5:1 dB ratio. Audio compression reduces the dynamic range of the audio source, which in turn allows maintaining a higher average modulation level. The MODULATION control, variable resistor R35, controls the limiter function "rotation point". Any audio peaks above the selected rotation point are compressed at a very high 15:1 dB ratio, independently of the setting of the COMPRESSION control. This prevents the output of the VCA from significantly exceeding the rotation point amplitude. R35 is normally adjusted so the rotation point is just below the 100% modulation point. This prevents over-modulation distortion and allows a high average modulation level.

A complete description of the SSM2166 is provided in the datasheet available in downloadable PDF form at the Analog Devices website, which may be found by searching the web for "SSM2166 datasheet".

RFI suppression coil L1 connects between the outer ground terminals of J1 and J2 and the transmitter circuit ground. Jumper S1 allows L1 to be switched in or out of the ground path. With S1 in the open position L1 blocks RF from flowing through the audio cable shields back through the ground of the audio source device to the power lines. With jumpers S1, S2 and S3 (S2 and S3 are described below in the power supply section) all in the open position the transmitter circuit ground is completely RF isolated from paths to the power lines through the audio cables and the AC power adapter.

Modulator Section

The audio output signal from U6 pin 13 is coupled to the base of Q3 through C18, R17 and R16. Treble boost capacitor, C16, can be optionally connected in parallel with R16 by shorting jumper S6 to emphasize audio high frequencies. Emphasis occurs because the impedance of C16 is much lower than the resistance of R16 at higher audio frequencies. Lower frequencies are attenuated by R16, while higher frequencies are bypassed around R16 through C16.

Q3 and Q2 are configured as a Darlington amplifier which has high input impedance and high current gain. Since the SSM2166 (U6) is designed to drive a minimum load impedance of 5 K ohms, the bias resistors for Q3 and Q2 have been selected to present a load greater than 5 K ohms to U6 while at the same time keeping the values low enough to swamp out DC current gain variations in Q3 and Q2. This is important for keeping the input power to the RF output section as close to 100 mW as practicable. Transistor Q2 determines the current drawn by the RF output stage. With no audio input, Q2 is biased such that the input power to the RF output stage is 100 mW. The Q2 collector current varies linearly with an applied audio signal causing the RF output stage to be amplitude modulated. Transistor Q1 supplies a current of several milliamps to the collector of Q2 in parallel with the current flowing from the RF output transistors. 100% negative modulation occurs when Q2 collector current drops to the level of the current supplied by Q1. At this point, no current flows from the RF output transistors, but Q1 still supplies current to Q2. Without the small current supplied by Q1, Q2 would need to go to complete cutoff at negative modulation peaks causing some distortion near cutoff.

Power Supply Section

The power supply section consists of an RF filter section, a bridge rectifier, a +15 volt voltage regulator (U1) and a +5 volt voltage regulator (U4).

The wall transformer supplies 18 volt RMS AC power to the AMT3000 at the power jack (J3). Inductors L3 and L4 can optionally be included in the path or not by opening or shorting jumpers S2 and S3. With the jumpers in the open position L2 and L3 prevent transmitter RF from being coupled back to the AC power lines to help alleviate hum problems that are sometimes encountered due to interaction of the AC power lines with transmitter RF coupled to the power lines through the wall transformer. For most installations jumpers S2 and S3 can be kept in the shorted position to take advantage of the additional ground path provided by the AC lines.

The full wave bridge rectifier, consisting of diodes D1, D2, D3 and D4, converts the AC input to pulsating DC, which is then smoothed by filter capacitor C4. Each diode is bypassed with a .1 uF capacitor to assure a low RF impedance across the diode when the diode is in the non-conductive reverse-biased portion of the AC cycle. This prevents possible 120 Hz hum modulation that can be induced when the RF impedance to earth ground through the power lines varies with the on/off state of the diodes. Voltage regulator U1 supplies regulated +15 volts to the RF output and modulation stages. It also feeds voltage regulator U4, which provides regulated voltage at +5 volts for powering the ICs.

The 18 volt RMS input voltage level is conservatively high enough to assure that the ripple troughs of the smoothed DC at the input to the +15 volt regulator are well above the minimum value specified for the 7815 regulator to assure full regulation. This conservatively high DC regulator input voltage causes U1 to run too hot to touch without the small heat sink supplied. Since U1 does not get hot enough to exceed its maximum rating without the heat sink, the usual procedure of applying silicone heat sink compound is not necessary. Firmly bolting the heat sink to U1 is sufficient to dissipate enough heat to allow U1 to be touched without the danger of skin burns.

15 Warranty, Return and Service Policy

Warranty

SSTRAN guarantees that all AMT3000 kit parts listed in section 2, "Parts List", of this manual will be included in your kit and are not damaged at the time the kit is shipped. A part is damaged if it is physically broken, cracked or crushed. Parts with bent wire leads or pins that can be straightened and aligned are not considered to be damaged. If a part is missing from your kit or a part is damaged, we will replace it at no charge. If your kit has been severely damaged during shipment, it is your responsibility to report the damage to the shipper and arrange a settlement with the shipper. If minor shipping damage occurs, we will replace the damaged parts free of charge. If you damage a part during kit assembly, we will replace it for a reasonable charge. You may request a replacement part by sending an e-mail to support@sstran.com. Be sure to include your name, shipping address, the date when you ordered your kit, a description of the damage, and the complete description of the part as shown in the parts list. We will reply promptly with price and ordering instructions.

Returns

If for any reason you are not satisfied with your AMT3000 kit, you may return it for a full refund within 30 days provided that the returned kit has all parts in their original condition. We cannot accept returns of kits that have been partially or completely assembled.

Service

For a flat fee of \$30.00 plus shipping, we will repair and test your assembled kit. You may send us your completed kit via pre-paid shipping. We will evaluate the condition of your assembled kit, replace defective parts, test it for proper operation and return it to you. If our evaluation indicates that the assembled kit is not repairable, we will return it to you and refund the \$30.00 repair fee.

How to Contact SSTRAN

Send an e-mail to: support@sstran.com.

If you prefer to contact us by mail, send your request to:

Customer Service
SSTRAN
3053 Griffith Rd.
Norristown, PA 19403

16 About FCC Part 15 Regulations

For users in the United States it is important that you be aware of the FCC rules applying to the use of unlicensed low-power transmitters. You can access the rules at: <http://www.fcc.gov/oet/info/rules/>. If this link becomes outdated, you can find the information by searching the web for "fcc part 15 rules".

The FCC rules exist to prevent harmful interference to other electrical devices such as radio receivers, telephones and sensitive electronic equipment. It is your responsibility to take precautions to ensure that your transmitter does not cause harmful interference. If you use your transmitter responsibly, you are not likely to experience any problems with the FCC. Always select the clearest frequency available in your area. This will reduce the likelihood that you will interfere with a licensed station that other people within your transmitter's range may be receiving. Do not broadcast offensive material that may result in complaints to the FCC. If the FCC does investigate a complaint, they will usually just request that you change your operation to remove the cause of the complaint. This may just involve switching to a different frequency or reducing your signal level by changing your antenna configuration. You must comply with FCC directives. FCC part 15.5 applies to this situation.

Most of the rules in part 15 do not apply to operation of low-power AM transmitters. Part 15 regulates the operation of all sorts of intentional and unintentional radiators. There are, however, some important paragraphs that you should read to gain an understanding of the applicable rules:

- 15.5 General conditions of operation.
- 15.35 Measurement detector functions and bandwidths.
- 15.203 Antenna requirement.
- 15.205 Restricted bands of operation.
- 15.209 Radiated emission limits; general requirements.
- 15.215 Additional provisions to the general radiated emission limitations.
- 15.219 Operation in the band 510-1705 kHz.

Rule 15.219 is particularly important for legal operation of the AMT3000. The AMT3000 input power to the final RF stage is designed to be 100 milliwatts. As long as you do not exceed the 3 meter limit for the total length of the antenna and ground lead wires, your transmitter will be compliant.

17 Component Identification

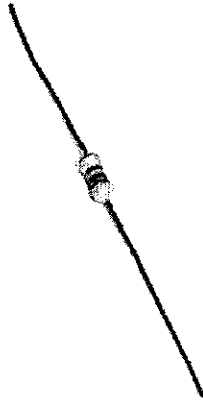

Fixed 1/4 Watt Resistor

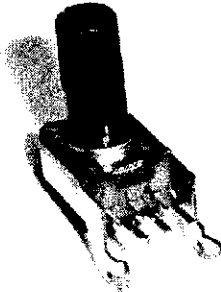

Variable Resistor

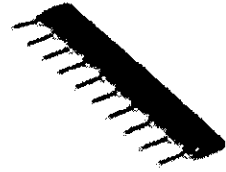

Resistor SIP Pack

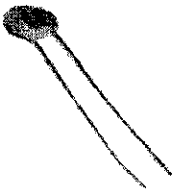

Ceramic Disc Capacitor

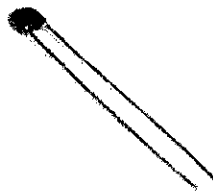

Multi-Layer Ceramic Capacitor

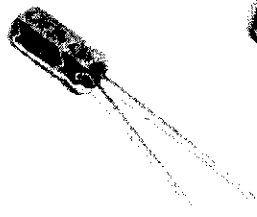

Small Electrolytic Capacitor

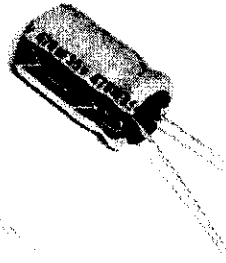

Large Electrolytic Capacitor



Ceramic Trimmer Capacitor

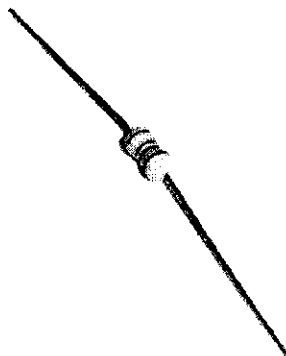

Epoxy Coated Choke

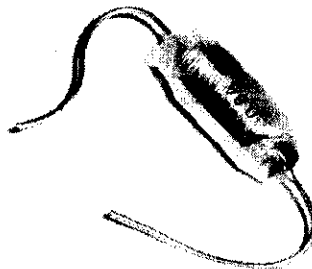

RFI Suppression Coil

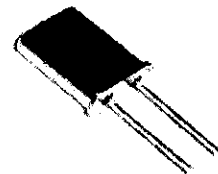

Quartz Crystal

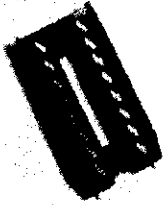

16 Pin DIP Socket



Power Jack



RCA Phono Jack

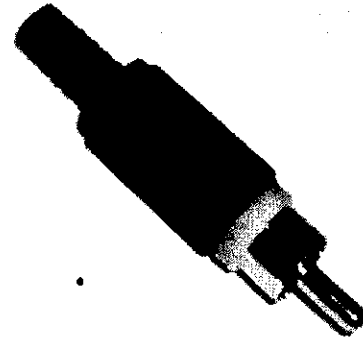

RCA Phono Plug



Silicon Rectifier



Silicon Diode



Green LED Lamp



TO-92 Transistor or Voltage Reg



TO-220 Voltage Reg



SSM2166 Surface Mount IC



16-Pin DIP IC

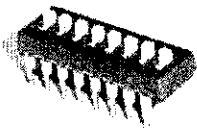

8-Position DIP Switch



4-Position DIP Switch



Header Strip



Header Jumper

18 Color Code Charts

Resistor Color Code

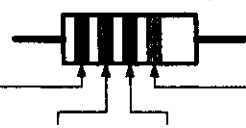

COLOR	1st DIGIT	2nd DIGIT	MULTIPLIER	TOLERANCE
BLACK	0	0	1	
BROWN	1	1	10	
RED	2	2	100	
ORANGE	3	3	1,000	
YELLOW	4	4	10,000	
GREEN	5	5	100,000	
BLUE	6	6	1,000,000	
VIOLET	7	7	10,000,000	
GRAY	8	8	100,000,000	
WHITE	9	9	1,000,000,000	
GOLD			.1	+ - 5 %
SILVER			.01	+ - 10 %
(no band)				+ - 20 %

Nominal Resistance (Ohms)

RF Choke Color Code

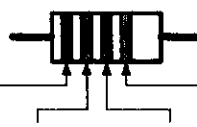

COLOR	1st DIGIT	2nd DIGIT	MULTIPLIER	TOLERANCE
BLACK	0	0	1	
BROWN	1	1	10	+ - 1 %
RED	2	2	100	+ - 2 %
ORANGE	3	3	1,000	
YELLOW	4	4		
GREEN	5	5		
BLUE	6	6		
VIOLET	7	7		
GRAY	8	8		
WHITE	9	9		+ - 2.5 %
GOLD			.1	+ - 5 %
SILVER			.01	+ - 10 %
(no band)				+ - 20 %

Nominal Inductance (uH)

19 Synthesizer Frequency Selection Chart

S4 Switch Settings For 10 kHz Channel-Spacing Models

Kit models AMT3000 and AMT3000-SM use a 4.000 MHz quartz crystal, which produces a 10 kHz PLL reference frequency. The resulting frequency spacing between successive S4 switch settings is 10 kHz. Use the following chart to find the S4 switch setting for your desired frequency in increments of 10 kHz.

Frequency kHz	S4 Setting							
	1	2	3	4	5	6	7	8
530	ON↑	ON↑	OFF↓	ON↑	OFF↓	OFF↓	ON↑	ON↑
540	OFF↓	ON↑	OFF↓	ON↑	OFF↓	OFF↓	ON↑	ON↑
550	ON↑	OFF↓	OFF↓	ON↑	OFF↓	OFF↓	ON↑	ON↑
560	OFF↓	OFF↓	OFF↓	ON↑	OFF↓	OFF↓	ON↑	ON↑
570	ON↑	ON↑	ON↑	OFF↓	OFF↓	OFF↓	ON↑	ON↑
580	OFF↓	ON↑	ON↑	OFF↓	OFF↓	OFF↓	ON↑	ON↑
590	ON↑	OFF↓	ON↑	OFF↓	OFF↓	OFF↓	ON↑	ON↑
600	OFF↓	OFF↓	ON↑	OFF↓	OFF↓	OFF↓	ON↑	ON↑
610	ON↑	ON↑	OFF↓	OFF↓	OFF↓	OFF↓	ON↑	ON↑
620	OFF↓	ON↑	OFF↓	OFF↓	OFF↓	OFF↓	ON↑	ON↑
630	ON↑	OFF↓	OFF↓	OFF↓	OFF↓	OFF↓	ON↑	ON↑
640	OFF↓	OFF↓	OFF↓	OFF↓	OFF↓	OFF↓	ON↑	ON↑
650	ON↑	ON↑	ON↑	ON↑	ON↑	ON↑	OFF↓	ON↑
660	OFF↓	ON↑	ON↑	ON↑	ON↑	ON↑	OFF↓	ON↑
670	ON↑	OFF↓	ON↑	ON↑	ON↑	ON↑	OFF↓	ON↑
680	OFF↓	OFF↓	ON↑	ON↑	ON↑	ON↑	OFF↓	ON↑
690	ON↑	ON↑	OFF↓	ON↑	ON↑	ON↑	OFF↓	ON↑
700	OFF↓	ON↑	OFF↓	ON↑	ON↑	ON↑	OFF↓	ON↑
710	ON↑	OFF↓	OFF↓	ON↑	ON↑	ON↑	OFF↓	ON↑
720	OFF↓	OFF↓	OFF↓	ON↑	ON↑	ON↑	OFF↓	ON↑
730	ON↑	ON↑	ON↑	OFF↓	ON↑	ON↑	OFF↓	ON↑
740	OFF↓	ON↑	ON↑	OFF↓	ON↑	ON↑	OFF↓	ON↑
750	ON↑	OFF↓	ON↑	OFF↓	ON↑	ON↑	OFF↓	ON↑
760	OFF↓	OFF↓	ON↑	OFF↓	ON↑	ON↑	OFF↓	ON↑
770	ON↑	ON↑	OFF↓	OFF↓	ON↑	ON↑	OFF↓	ON↑
780	OFF↓	ON↑	OFF↓	OFF↓	ON↑	ON↑	OFF↓	ON↑
790	ON↑	OFF↓	OFF↓	OFF↓	ON↑	ON↑	OFF↓	ON↑
800	OFF↓	OFF↓	OFF↓	OFF↓	ON↑	ON↑	OFF↓	ON↑
810	ON↑	ON↑	ON↑	ON↑	OFF↓	ON↑	OFF↓	ON↑
820	OFF↓	ON↑	ON↑	ON↑	OFF↓	ON↑	OFF↓	ON↑
830	ON↑	OFF↓	ON↑	ON↑	OFF↓	ON↑	OFF↓	ON↑
840	OFF↓	OFF↓	ON↑	ON↑	OFF↓	ON↑	OFF↓	ON↑
850	ON↑	ON↑	OFF↓	ON↑	OFF↓	ON↑	OFF↓	ON↑
860	OFF↓	ON↑	OFF↓	ON↑	OFF↓	ON↑	OFF↓	ON↑
870	ON↑	OFF↓	OFF↓	ON↑	OFF↓	ON↑	OFF↓	ON↑
880	OFF↓	OFF↓	OFF↓	ON↑	OFF↓	ON↑	OFF↓	ON↑

Frequency kHz	S4 Setting							
	1	2	3	4	5	6	7	8
890	ON↑	ON↑	ON↑	OFF↓	OFF↓	ON↑	OFF↓	ON↑
900	OFF↓	ON↑	ON↑	OFF↓	OFF↓	ON↑	OFF↓	ON↑
910	ON↑	OFF↓	ON↑	OFF↓	OFF↓	ON↑	OFF↓	ON↑
920	OFF↓	OFF↓	ON↑	OFF↓	OFF↓	ON↑	OFF↓	ON↑
930	ON↑	ON↑	OFF↓	OFF↓	OFF↓	ON↑	OFF↓	ON↑
940	OFF↓	ON↑	OFF↓	OFF↓	OFF↓	ON↑	OFF↓	ON↑
950	ON↑	OFF↓	OFF↓	OFF↓	OFF↓	ON↑	OFF↓	ON↑
960	OFF↓	OFF↓	OFF↓	OFF↓	OFF↓	ON↑	OFF↓	ON↑
970	ON↑	ON↑	ON↑	ON↑	ON↑	OFF↓	OFF↓	ON↑
980	OFF↓	ON↑	ON↑	ON↑	ON↑	OFF↓	OFF↓	ON↑
990	ON↑	OFF↓	ON↑	ON↑	ON↑	OFF↓	OFF↓	ON↑
1000	OFF↓	OFF↓	ON↑	ON↑	ON↑	OFF↓	OFF↓	ON↑
1010	ON↑	ON↑	OFF↓	ON↑	ON↑	OFF↓	OFF↓	ON↑
1020	OFF↓	ON↑	OFF↓	ON↑	ON↑	OFF↓	OFF↓	ON↑
1030	ON↑	OFF↓	OFF↓	ON↑	ON↑	OFF↓	OFF↓	ON↑
1040	OFF↓	OFF↓	OFF↓	ON↑	ON↑	OFF↓	OFF↓	ON↑
1050	ON↑	ON↑	ON↑	OFF↓	ON↑	OFF↓	OFF↓	ON↑
1060	OFF↓	ON↑	ON↑	OFF↓	ON↑	OFF↓	OFF↓	ON↑
1070	ON↑	OFF↓	ON↑	OFF↓	ON↑	OFF↓	OFF↓	ON↑
1080	OFF↓	OFF↓	ON↑	OFF↓	ON↑	OFF↓	OFF↓	ON↑
1090	ON↑	ON↑	OFF↓	OFF↓	ON↑	OFF↓	OFF↓	ON↑
1100	OFF↓	ON↑	OFF↓	OFF↓	ON↑	OFF↓	OFF↓	ON↑
1110	ON↑	OFF↓	OFF↓	OFF↓	ON↑	OFF↓	OFF↓	ON↑
1120	OFF↓	OFF↓	OFF↓	OFF↓	ON↑	OFF↓	OFF↓	ON↑
1130	ON↑	ON↑	ON↑	ON↑	OFF↓	OFF↓	OFF↓	ON↑
1140	OFF↓	ON↑	ON↑	ON↑	OFF↓	OFF↓	OFF↓	ON↑
1150	ON↑	OFF↓	ON↑	ON↑	OFF↓	OFF↓	OFF↓	ON↑
1160	OFF↓	OFF↓	ON↑	ON↑	OFF↓	OFF↓	OFF↓	ON↑
1170	ON↑	ON↑	OFF↓	ON↑	OFF↓	OFF↓	OFF↓	ON↑
1180	OFF↓	ON↑	OFF↓	ON↑	OFF↓	OFF↓	OFF↓	ON↑
1190	ON↑	OFF↓	OFF↓	ON↑	OFF↓	OFF↓	OFF↓	ON↑
1200	OFF↓	OFF↓	OFF↓	ON↑	OFF↓	OFF↓	OFF↓	ON↑
1210	ON↑	ON↑	ON↑	OFF↓	OFF↓	OFF↓	OFF↓	ON↑
1220	OFF↓	ON↑	ON↑	OFF↓	OFF↓	OFF↓	OFF↓	ON↑
1230	ON↑	OFF↓	ON↑	OFF↓	OFF↓	OFF↓	OFF↓	ON↑
1240	OFF↓	OFF↓	ON↑	OFF↓	OFF↓	OFF↓	OFF↓	ON↑
1250	ON↑	ON↑	OFF↓	OFF↓	OFF↓	OFF↓	OFF↓	ON↑
1260	OFF↓	ON↑	OFF↓	OFF↓	OFF↓	OFF↓	OFF↓	ON↑
1270	ON↑	OFF↓	OFF↓	OFF↓	OFF↓	OFF↓	OFF↓	ON↑
1280	OFF↓	OFF↓	OFF↓	OFF↓	OFF↓	OFF↓	OFF↓	ON↑
1290	ON↑	ON↑	ON↑	ON↑	ON↑	ON↑	ON↑	OFF↓
1300	OFF↓	ON↑	ON↑	ON↑	ON↑	ON↑	ON↑	OFF↓
1310	ON↑	OFF↓	ON↑	ON↑	ON↑	ON↑	ON↑	OFF↓
1320	OFF↓	OFF↓	ON↑	ON↑	ON↑	ON↑	ON↑	OFF↓
1330	ON↑	ON↑	OFF↓	ON↑	ON↑	ON↑	ON↑	OFF↓

Frequency kHz	S4 Setting							
	1	2	3	4	5	6	7	8
1340	OFF↓	ON↑	OFF↓	ON↑	ON↑	ON↑	ON↑	OFF↓
1350	ON↑	OFF↓	OFF↓	ON↑	ON↑	ON↑	ON↑	OFF↓
1360	OFF↓	OFF↓	OFF↓	ON↑	ON↑	ON↑	ON↑	OFF↓
1370	ON↑	ON↑	ON↑	OFF↓	ON↑	ON↑	ON↑	OFF↓
1380	OFF↓	ON↑	ON↑	OFF↓	ON↑	ON↑	ON↑	OFF↓
1390	ON↑	OFF↓	ON↑	OFF↓	ON↑	ON↑	ON↑	OFF↓
1400	OFF↓	OFF↓	ON↑	OFF↓	ON↑	ON↑	ON↑	OFF↓
1410	ON↑	ON↑	OFF↓	OFF↓	ON↑	ON↑	ON↑	OFF↓
1420	OFF↓	ON↑	OFF↓	OFF↓	ON↑	ON↑	ON↑	OFF↓
1430	ON↑	OFF↓	OFF↓	OFF↓	ON↑	ON↑	ON↑	OFF↓
1440	OFF↓	OFF↓	OFF↓	OFF↓	ON↑	ON↑	ON↑	OFF↓
1450	ON↑	ON↑	ON↑	ON↑	OFF↓	ON↑	ON↑	OFF↓
1460	OFF↓	ON↑	ON↑	ON↑	OFF↓	ON↑	ON↑	OFF↓
1470	ON↑	OFF↓	ON↑	ON↑	OFF↓	ON↑	ON↑	OFF↓
1480	OFF↓	OFF↓	ON↑	ON↑	OFF↓	ON↑	ON↑	OFF↓
1490	ON↑	ON↑	OFF↓	ON↑	OFF↓	ON↑	ON↑	OFF↓
1500	OFF↓	ON↑	OFF↓	ON↑	OFF↓	ON↑	ON↑	OFF↓
1510	ON↑	OFF↓	OFF↓	ON↑	OFF↓	ON↑	ON↑	OFF↓
1520	OFF↓	OFF↓	OFF↓	ON↑	OFF↓	ON↑	ON↑	OFF↓
1530	ON↑	ON↑	ON↑	OFF↓	OFF↓	ON↑	ON↑	OFF↓
1540	OFF↓	ON↑	ON↑	OFF↓	OFF↓	ON↑	ON↑	OFF↓
1550	ON↑	OFF↓	ON↑	OFF↓	OFF↓	ON↑	ON↑	OFF↓
1560	OFF↓	OFF↓	ON↑	OFF↓	OFF↓	ON↑	ON↑	OFF↓
1570	ON↑	ON↑	OFF↓	OFF↓	OFF↓	ON↑	ON↑	OFF↓
1580	OFF↓	ON↑	OFF↓	OFF↓	OFF↓	ON↑	ON↑	OFF↓
1590	ON↑	OFF↓	OFF↓	OFF↓	OFF↓	ON↑	ON↑	OFF↓
1600	OFF↓	OFF↓	OFF↓	OFF↓	OFF↓	ON↑	ON↑	OFF↓
1610	ON↑	ON↑	ON↑	ON↑	ON↑	OFF↓	ON↑	OFF↓
1620	OFF↓	ON↑	ON↑	ON↑	ON↑	OFF↓	ON↑	OFF↓
1630	ON↑	OFF↓	ON↑	ON↑	ON↑	OFF↓	ON↑	OFF↓
1640	OFF↓	OFF↓	ON↑	ON↑	ON↑	OFF↓	ON↑	OFF↓
1650	ON↑	ON↑	OFF↓	ON↑	ON↑	OFF↓	ON↑	OFF↓
1660	OFF↓	ON↑	OFF↓	ON↑	ON↑	OFF↓	ON↑	OFF↓
1670	ON↑	OFF↓	OFF↓	ON↑	ON↑	OFF↓	ON↑	OFF↓
1680	OFF↓	OFF↓	OFF↓	ON↑	ON↑	OFF↓	ON↑	OFF↓
1690	ON↑	ON↑	ON↑	OFF↓	ON↑	OFF↓	ON↑	OFF↓
1700	OFF↓	ON↑	ON↑	OFF↓	ON↑	OFF↓	ON↑	OFF↓

S4 Switch Settings For 9 kHz Channel-Spacing Models

Kit models AMT3000-9K and AMT3000-9KSM use a 3.600 MHz quartz crystal, which results in a 9 kHz PLL reference frequency. The resulting frequency spacing between successive S4 switch settings is 9 kHz. Use the following chart to find the S4 switch setting for your desired frequency in increments of 9 kHz.

Frequency kHz	S4 Setting							
	8	7	6	5	4	3	2	1
522	ON ↑	ON ↑	OFF ↓	OFF ↓	OFF ↓	ON ↑	ON ↑	OFF ↓
531	ON ↑	ON ↑	OFF ↓	OFF ↓	OFF ↓	ON ↑	OFF ↓	ON ↑
540	ON ↑	ON ↑	OFF ↓	OFF ↓	OFF ↓	ON ↑	OFF ↓	OFF ↓
549	ON ↑	ON ↑	OFF ↓	OFF ↓	OFF ↓	OFF ↓	ON ↑	ON ↑
558	ON ↑	ON ↑	OFF ↓	OFF ↓	OFF ↓	OFF ↓	ON ↑	OFF ↓
567	ON ↑	ON ↑	OFF ↓	OFF ↓	OFF ↓	OFF ↓	OFF ↓	ON ↑
576	ON ↑	ON ↑	OFF ↓	OFF ↓	OFF ↓	OFF ↓	OFF ↓	OFF ↓
585	ON ↑	OFF ↓	ON ↑	ON ↑	ON ↑	ON ↑	ON ↑	ON ↑
594	ON ↑	OFF ↓	ON ↑	ON ↑	ON ↑	ON ↑	ON ↑	OFF ↓
603	ON ↑	OFF ↓	ON ↑	ON ↑	ON ↑	ON ↑	OFF ↓	ON ↑
612	ON ↑	OFF ↓	ON ↑	ON ↑	ON ↑	ON ↑	OFF ↓	OFF ↓
621	ON ↑	OFF ↓	ON ↑	ON ↑	ON ↑	OFF ↓	ON ↑	ON ↑
630	ON ↑	OFF ↓	ON ↑	ON ↑	ON ↑	OFF ↓	ON ↑	OFF ↓
639	ON ↑	OFF ↓	ON ↑	ON ↑	ON ↑	OFF ↓	OFF ↓	ON ↑
648	ON ↑	OFF ↓	ON ↑	ON ↑	ON ↑	OFF ↓	OFF ↓	OFF ↓
657	ON ↑	OFF ↓	ON ↑	ON ↑	OFF ↓	ON ↑	ON ↑	ON ↑
666	ON ↑	OFF ↓	ON ↑	ON ↑	OFF ↓	ON ↑	ON ↑	OFF ↓
675	ON ↑	OFF ↓	ON ↑	ON ↑	OFF ↓	ON ↑	OFF ↓	ON ↑
684	ON ↑	OFF ↓	ON ↑	ON ↑	OFF ↓	ON ↑	OFF ↓	OFF ↓
693	ON ↑	OFF ↓	ON ↑	ON ↑	OFF ↓	OFF ↓	ON ↑	ON ↑
702	ON ↑	OFF ↓	ON ↑	ON ↑	OFF ↓	OFF ↓	ON ↑	OFF ↓
711	ON ↑	OFF ↓	ON ↑	ON ↑	OFF ↓	OFF ↓	OFF ↓	ON ↑
720	ON ↑	OFF ↓	ON ↑	ON ↑	OFF ↓	OFF ↓	OFF ↓	OFF ↓
729	ON ↑	OFF ↓	ON ↑	OFF ↓	ON ↑	ON ↑	ON ↑	ON ↑
738	ON ↑	OFF ↓	ON ↑	OFF ↓	ON ↑	ON ↑	ON ↑	OFF ↓
747	ON ↑	OFF ↓	ON ↑	OFF ↓	ON ↑	ON ↑	OFF ↓	ON ↑
756	ON ↑	OFF ↓	ON ↑	OFF ↓	ON ↑	ON ↑	OFF ↓	OFF ↓
765	ON ↑	OFF ↓	ON ↑	OFF ↓	ON ↑	OFF ↓	ON ↑	ON ↑
774	ON ↑	OFF ↓	ON ↑	OFF ↓	ON ↑	OFF ↓	ON ↑	OFF ↓
783	ON ↑	OFF ↓	ON ↑	OFF ↓	ON ↑	OFF ↓	OFF ↓	ON ↑
792	ON ↑	OFF ↓	ON ↑	OFF ↓	ON ↑	OFF ↓	OFF ↓	OFF ↓
801	ON ↑	OFF ↓	ON ↑	OFF ↓	OFF ↓	ON ↑	ON ↑	ON ↑
810	ON ↑	OFF ↓	ON ↑	OFF ↓	OFF ↓	ON ↑	ON ↑	OFF ↓
819	ON ↑	OFF ↓	ON ↑	OFF ↓	OFF ↓	ON ↑	OFF ↓	ON ↑
828	ON ↑	OFF ↓	ON ↑	OFF ↓	OFF ↓	ON ↑	OFF ↓	OFF ↓
837	ON ↑	OFF ↓	ON ↑	OFF ↓	OFF ↓	OFF ↓	ON ↑	ON ↑
846	ON ↑	OFF ↓	ON ↑	OFF ↓	OFF ↓	OFF ↓	ON ↑	OFF ↓
855	ON ↑	OFF ↓	ON ↑	OFF ↓	OFF ↓	OFF ↓	OFF ↓	ON ↑
864	ON ↑	OFF ↓	ON ↑	OFF ↓	OFF ↓	OFF ↓	OFF ↓	OFF ↓
873	ON ↑	OFF ↓	OFF ↓	ON ↑	ON ↑	ON ↑	ON ↑	ON ↑
882	ON ↑	OFF ↓	OFF ↓	ON ↑	ON ↑	ON ↑	ON ↑	OFF ↓
891	ON ↑	OFF ↓	OFF ↓	ON ↑	ON ↑	ON ↑	OFF ↓	ON ↑
900	ON ↑	OFF ↓	OFF ↓	ON ↑	ON ↑	ON ↑	OFF ↓	OFF ↓
909	ON ↑	OFF ↓	OFF ↓	ON ↑	ON ↑	OFF ↓	ON ↑	ON ↑
918	ON ↑	OFF ↓	OFF ↓	ON ↑	ON ↑	OFF ↓	ON ↑	OFF ↓
927	ON ↑	OFF ↓	OFF ↓	ON ↑	ON ↑	OFF ↓	OFF ↓	ON ↑

Frequency kHz	S4 Setting							
	8	7	6	5	4	3	2	1
936	ON ↑	OFF ↓	OFF ↓	ON ↑	ON ↑	OFF ↓	OFF ↓	OFF ↓
945	ON ↑	OFF ↓	OFF ↓	ON ↑	OFF ↓	ON ↑	ON ↑	ON ↑
954	ON ↑	OFF ↓	OFF ↓	ON ↑	OFF ↓	ON ↑	ON ↑	OFF ↓
963	ON ↑	OFF ↓	OFF ↓	ON ↑	OFF ↓	ON ↑	OFF ↓	ON ↑
972	ON ↑	OFF ↓	OFF ↓	ON ↑	OFF ↓	ON ↑	OFF ↓	OFF ↓
981	ON ↑	OFF ↓	OFF ↓	ON ↑	OFF ↓	OFF ↓	ON ↑	ON ↑
990	ON ↑	OFF ↓	OFF ↓	ON ↑	OFF ↓	OFF ↓	ON ↑	OFF ↓
999	ON ↑	OFF ↓	OFF ↓	ON ↑	OFF ↓	OFF ↓	OFF ↓	ON ↑
1008	ON ↑	OFF ↓	OFF ↓	ON ↑	OFF ↓	OFF ↓	OFF ↓	OFF ↓
1017	ON ↑	OFF ↓	OFF ↓	OFF ↓	ON ↑	ON ↑	ON ↑	ON ↑
1026	ON ↑	OFF ↓	OFF ↓	OFF ↓	ON ↑	ON ↑	ON ↑	OFF ↓
1035	ON ↑	OFF ↓	OFF ↓	OFF ↓	ON ↑	ON ↑	OFF ↓	ON ↑
1044	ON ↑	OFF ↓	OFF ↓	OFF ↓	ON ↑	ON ↑	OFF ↓	OFF ↓
1053	ON ↑	OFF ↓	OFF ↓	OFF ↓	ON ↑	OFF ↓	ON ↑	ON ↑
1062	ON ↑	OFF ↓	OFF ↓	OFF ↓	ON ↑	OFF ↓	ON ↑	OFF ↓
1071	ON ↑	OFF ↓	OFF ↓	OFF ↓	ON ↑	OFF ↓	OFF ↓	ON ↑
1080	ON ↑	OFF ↓	OFF ↓	OFF ↓	ON ↑	OFF ↓	OFF ↓	OFF ↓
1089	ON ↑	OFF ↓	OFF ↓	OFF ↓	OFF ↓	ON ↑	ON ↑	ON ↑
1098	ON ↑	OFF ↓	OFF ↓	OFF ↓	OFF ↓	ON ↑	ON ↑	OFF ↓
1107	ON ↑	OFF ↓	OFF ↓	OFF ↓	OFF ↓	ON ↑	OFF ↓	ON ↑
1116	ON ↑	OFF ↓	OFF ↓	OFF ↓	OFF ↓	ON ↑	OFF ↓	OFF ↓
1125	ON ↑	OFF ↓	OFF ↓	OFF ↓	OFF ↓	OFF ↓	ON ↑	ON ↑
1134	ON ↑	OFF ↓	OFF ↓	OFF ↓	OFF ↓	OFF ↓	ON ↑	OFF ↓
1143	ON ↑	OFF ↓	OFF ↓	OFF ↓	OFF ↓	OFF ↓	OFF ↓	ON ↑
1152	ON ↑	OFF ↓	OFF ↓	OFF ↓	OFF ↓	OFF ↓	OFF ↓	OFF ↓
1161	OFF ↓	ON ↑	ON ↑	ON ↑	ON ↑	ON ↑	ON ↑	ON ↑
1170	OFF ↓	ON ↑	ON ↑	ON ↑	ON ↑	ON ↑	ON ↑	OFF ↓
1179	OFF ↓	ON ↑	ON ↑	ON ↑	ON ↑	ON ↑	OFF ↓	ON ↑
1188	OFF ↓	ON ↑	ON ↑	ON ↑	ON ↑	ON ↑	OFF ↓	OFF ↓
1197	OFF ↓	ON ↑	ON ↑	ON ↑	ON ↑	OFF ↓	ON ↑	ON ↑
1206	OFF ↓	ON ↑	ON ↑	ON ↑	ON ↑	OFF ↓	ON ↑	OFF ↓
1215	OFF ↓	ON ↑	ON ↑	ON ↑	ON ↑	OFF ↓	OFF ↓	ON ↑
1224	OFF ↓	ON ↑	ON ↑	ON ↑	ON ↑	OFF ↓	OFF ↓	OFF ↓
1233	OFF ↓	ON ↑	ON ↑	ON ↑	OFF ↓	ON ↑	ON ↑	ON ↑
1242	OFF ↓	ON ↑	ON ↑	ON ↑	OFF ↓	ON ↑	ON ↑	OFF ↓
1251	OFF ↓	ON ↑	ON ↑	ON ↑	OFF ↓	ON ↑	OFF ↓	ON ↑
1260	OFF ↓	ON ↑	ON ↑	ON ↑	OFF ↓	ON ↑	OFF ↓	OFF ↓
1269	OFF ↓	ON ↑	ON ↑	ON ↑	OFF ↓	OFF ↓	ON ↑	ON ↑
1278	OFF ↓	ON ↑	ON ↑	ON ↑	OFF ↓	OFF ↓	ON ↑	OFF ↓
1287	OFF ↓	ON ↑	ON ↑	ON ↑	OFF ↓	OFF ↓	OFF ↓	ON ↑
1296	OFF ↓	ON ↑	ON ↑	ON ↑	OFF ↓	OFF ↓	OFF ↓	OFF ↓
1305	OFF ↓	ON ↑	ON ↑	OFF ↓	ON ↑	ON ↑	ON ↑	ON ↑
1314	OFF ↓	ON ↑	ON ↑	OFF ↓	ON ↑	ON ↑	ON ↑	OFF ↓
1323	OFF ↓	ON ↑	ON ↑	OFF ↓	ON ↑	ON ↑	OFF ↓	ON ↑
1332	OFF ↓	ON ↑	ON ↑	OFF ↓	ON ↑	ON ↑	OFF ↓	OFF ↓
1341	OFF ↓	ON ↑	ON ↑	OFF ↓	ON ↑	OFF ↓	ON ↑	ON ↑
1350	OFF ↓	ON ↑	ON ↑	OFF ↓	ON ↑	OFF ↓	ON ↑	OFF ↓
1359	OFF ↓	ON ↑	ON ↑	OFF ↓	ON ↑	OFF ↓	OFF ↓	ON ↑
1368	OFF ↓	ON ↑	ON ↑	OFF ↓	ON ↑	OFF ↓	OFF ↓	OFF ↓
1377	OFF ↓	ON ↑	ON ↑	OFF ↓	OFF ↓	ON ↑	ON ↑	ON ↑
1386	OFF ↓	ON ↑	ON ↑	OFF ↓	OFF ↓	ON ↑	ON ↑	OFF ↓
1395	OFF ↓	ON ↑	ON ↑	OFF ↓	OFF ↓	ON ↑	OFF ↓	ON ↑
1404	OFF ↓	ON ↑	ON ↑	OFF ↓	OFF ↓	ON ↑	OFF ↓	OFF ↓
1413	OFF ↓	ON ↑	ON ↑	OFF ↓	OFF ↓	OFF ↓	ON ↑	ON ↑
1422	OFF ↓	ON ↑	ON ↑	OFF ↓	OFF ↓	OFF ↓	ON ↑	OFF ↓
1431	OFF ↓	ON ↑	ON ↑	OFF ↓	OFF ↓	OFF ↓	OFF ↓	ON ↑

Frequency kHz	S4 Setting							
	8	7	6	5	4	3	2	1
1440	OFF ↓	ON ↑	ON ↑	OFF ↓	OFF ↓	OFF ↓	OFF ↓	OFF ↓
1449	OFF ↓	ON ↑	OFF ↓	ON ↑	ON ↑	ON ↑	ON ↑	ON ↑
1458	OFF ↓	ON ↑	OFF ↓	ON ↑	ON ↑	ON ↑	ON ↑	OFF ↓
1467	OFF ↓	ON ↑	OFF ↓	ON ↑	ON ↑	ON ↑	OFF ↓	ON ↑
1476	OFF ↓	ON ↑	OFF ↓	ON ↑	ON ↑	ON ↑	OFF ↓	OFF ↓
1485	OFF ↓	ON ↑	OFF ↓	ON ↑	ON ↑	OFF ↓	ON ↑	ON ↑
1494	OFF ↓	ON ↑	OFF ↓	ON ↑	ON ↑	OFF ↓	ON ↑	OFF ↓
1503	OFF ↓	ON ↑	OFF ↓	ON ↑	ON ↑	OFF ↓	OFF ↓	ON ↑
1512	OFF ↓	ON ↑	OFF ↓	ON ↑	ON ↑	OFF ↓	OFF ↓	OFF ↓
1521	OFF ↓	ON ↑	OFF ↓	ON ↑	OFF ↓	ON ↑	ON ↑	ON ↑
1530	OFF ↓	ON ↑	OFF ↓	ON ↑	OFF ↓	ON ↑	ON ↑	OFF ↓
1539	OFF ↓	ON ↑	OFF ↓	ON ↑	OFF ↓	ON ↑	OFF ↓	ON ↑
1548	OFF ↓	ON ↑	OFF ↓	ON ↑	OFF ↓	ON ↑	OFF ↓	OFF ↓
1557	OFF ↓	ON ↑	OFF ↓	ON ↑	OFF ↓	OFF ↓	ON ↑	ON ↑
1566	OFF ↓	ON ↑	OFF ↓	ON ↑	OFF ↓	OFF ↓	ON ↑	OFF ↓
1575	OFF ↓	ON ↑	OFF ↓	ON ↑	OFF ↓	OFF ↓	OFF ↓	ON ↑
1584	OFF ↓	ON ↑	OFF ↓	ON ↑	OFF ↓	OFF ↓	OFF ↓	OFF ↓
1593	OFF ↓	ON ↑	OFF ↓	OFF ↓	ON ↑	ON ↑	ON ↑	ON ↑
1602	OFF ↓	ON ↑	OFF ↓	OFF ↓	ON ↑	ON ↑	ON ↑	OFF ↓
1611	OFF ↓	ON ↑	OFF ↓	OFF ↓	ON ↑	ON ↑	OFF ↓	ON ↑
1620	OFF ↓	ON ↑	OFF ↓	OFF ↓	ON ↑	ON ↑	OFF ↓	OFF ↓
1629	OFF ↓	ON ↑	OFF ↓	OFF ↓	ON ↑	OFF ↓	ON ↑	ON ↑
1638	OFF ↓	ON ↑	OFF ↓	OFF ↓	ON ↑	OFF ↓	ON ↑	OFF ↓
1647	OFF ↓	ON ↑	OFF ↓	OFF ↓	ON ↑	OFF ↓	OFF ↓	ON ↑
1656	OFF ↓	ON ↑	OFF ↓	OFF ↓	ON ↑	OFF ↓	OFF ↓	OFF ↓
1665	OFF ↓	ON ↑	OFF ↓	OFF ↓	OFF ↓	ON ↑	ON ↑	ON ↑
1674	OFF ↓	ON ↑	OFF ↓	OFF ↓	OFF ↓	ON ↑	ON ↑	OFF ↓
1683	OFF ↓	ON ↑	OFF ↓	OFF ↓	OFF ↓	ON ↑	OFF ↓	ON ↑
1692	OFF ↓	ON ↑	OFF ↓	OFF ↓	OFF ↓	ON ↑	OFF ↓	OFF ↓
1701	OFF ↓	ON ↑	OFF ↓	OFF ↓	OFF ↓	OFF ↓	ON ↑	ON ↑
1710	OFF ↓	ON ↑	OFF ↓	OFF ↓	OFF ↓	OFF ↓	ON ↑	OFF ↓

20 RF Output Tuning Range Selection

The frequency range column gives approximate minimum and maximum resonant frequencies over the tuning range of trimmer capacitor (C5) for a typical antenna capacitance of 50 pF. If the desired frequency falls within more than one range, pick the lowest range (highest inductance) that includes the desired frequency. This will achieve resonance with the lowest C5 capacitance. A lower value of C5 capacitance will couple more power to the antenna. If you can't get a resonant peak with your chosen S5 setting, try the next higher or lower range setting.

Frequency Range (kHz)	S5 Setting				Inductance (uH)
	1	2	3	4	
1,797 - 2,523	OFF↓	ON↑	ON↑	ON↑	56
1,485 - 2,085	ON↑	OFF↓	ON↑	ON↑	82
1,145 - 1,607	OFF↓	OFF↓	ON↑	ON↑	138
1,003 - 1,407	ON↑	ON↑	OFF↓	ON↑	180
876 - 1,229	OFF↓	ON↑	OFF↓	ON↑	236
831 - 1,166	ON↑	OFF↓	OFF↓	ON↑	262
754 - 1,059	OFF↓	OFF↓	OFF↓	ON↑	318
620 - 871	ON↑	ON↑	ON↑	OFF↓	470
586 - 823	OFF↓	ON↑	ON↑	OFF↓	526
572 - 803	ON↑	OFF↓	ON↑	OFF↓	552
545 - 766	OFF↓	OFF↓	ON↑	OFF↓	608
528 - 740	ON↑	ON↑	OFF↓	OFF↓	650
506 - 710	OFF↓	ON↑	OFF↓	OFF↓	706
497 - 698	ON↑	OFF↓	OFF↓	OFF↓	732
479 - 672	OFF↓	OFF↓	OFF↓	OFF↓	788

S5 Frequency Range Switch Settings for 3 Meter Antenna

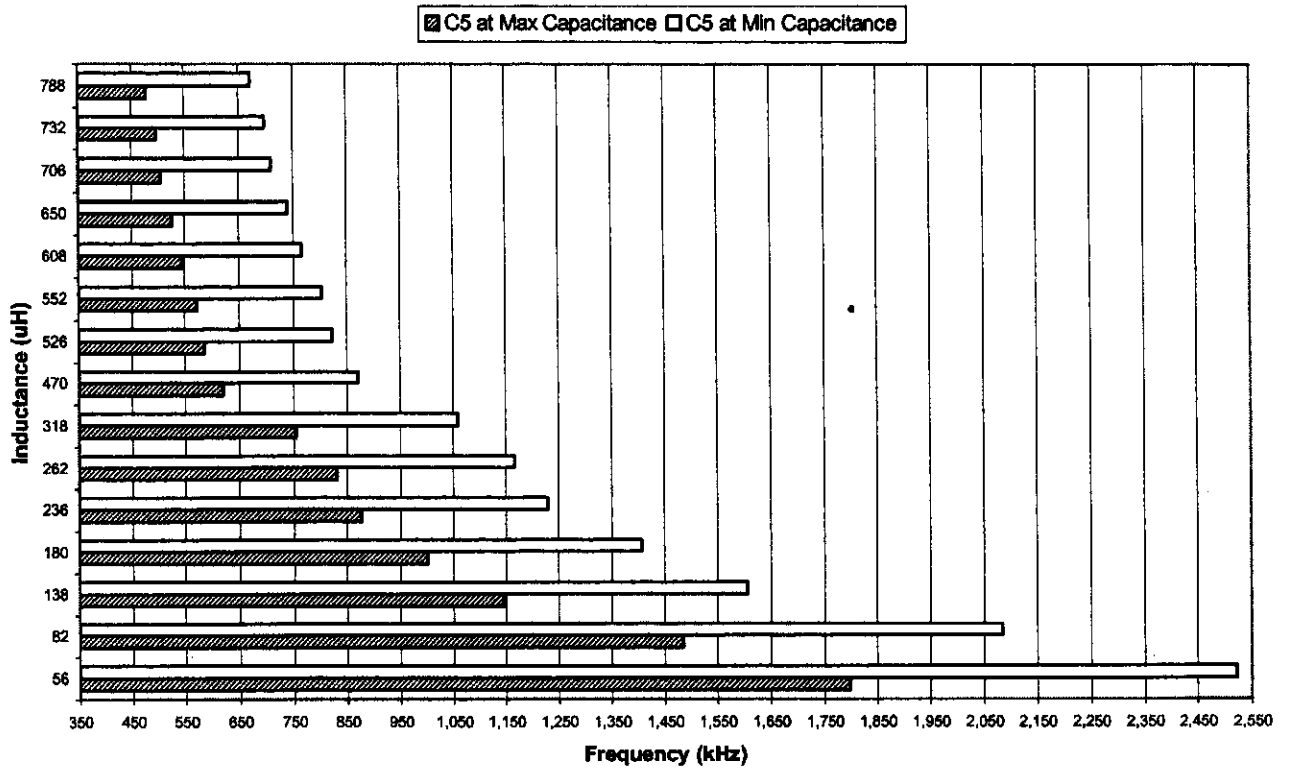

Frequency Range Graph for 3 Meter Antenna

21 Specifications

Frequency Coverage:	Models AMT3000 and AMT3000-SM: 530 to 1700 kHz in 10 kHz steps. Models AMT3000-9K and AMT3000-9KSM: 522 to 1710 kHz in 9 kHz steps.
Frequency Selection Method:	8-position DIP switch
Frequency Tolerance @ 25°C:	±.003%
Modulation Type:	Amplitude Modulation (AM)
Maximum Modulation Level:	100%
Power Input to Final RF Stage:	100 mW
Antenna:	118" wire (supplied with kit)
Antenna Matching:	Tunable pi-network. Matches high impedance antenna to low-impedance RF output stage.
Output Tuning:	4-position DIP switch selects inductance combination, adjustable ceramic trimmer capacitor peaks resonance.
RF Output Metering:	Test points on circuit board provide DC voltage to user-supplied 10 megohm/volt voltmeter. Measured voltage is maximum at resonance.
RF Grounding Options:	Jumper plug options for including/excluding RF isolation inductors in power supply and audio source ground paths.
Audio Response:	20 Hz to 20 kHz ±1 dB
Audio Treble Boost:	+8 dB, boost midpoint at 2 kHz. Jumper plug option.
Audio Distortion:	Less than 0.5% THD through audio stages.
Minimum Audio Input Level:	200 mV RMS for 100% modulation (input gain control at max).
Audio Compression:	Compression ratio adjustable from 1:1 to 5:1. Attack time less than 1 ms. Medium release time suitable for both voice and music.
Audio Limiting:	Adjustable threshold. 15:1 compression above threshold.
Front Panel Controls:	Audio input GAIN, MODULATION level, COMPRESSION ratio.
Rear Panel Jacks:	2 RCA audio in jacks, RCA antenna/ground jack, 2.1 mm power input jack.
Power Consumption:	120 VAC, 2 watts
Circuit Board:	5"W x 3.9"D x .062"H FR4, two layers, 1 oz. copper, top and bottom solder masks, top silkscreen.
Enclosure:	6.1"W x 4.2"D x 1.5"H ABS plastic. Drilled and labeled front and rear panels.

22 Circuit Diagram

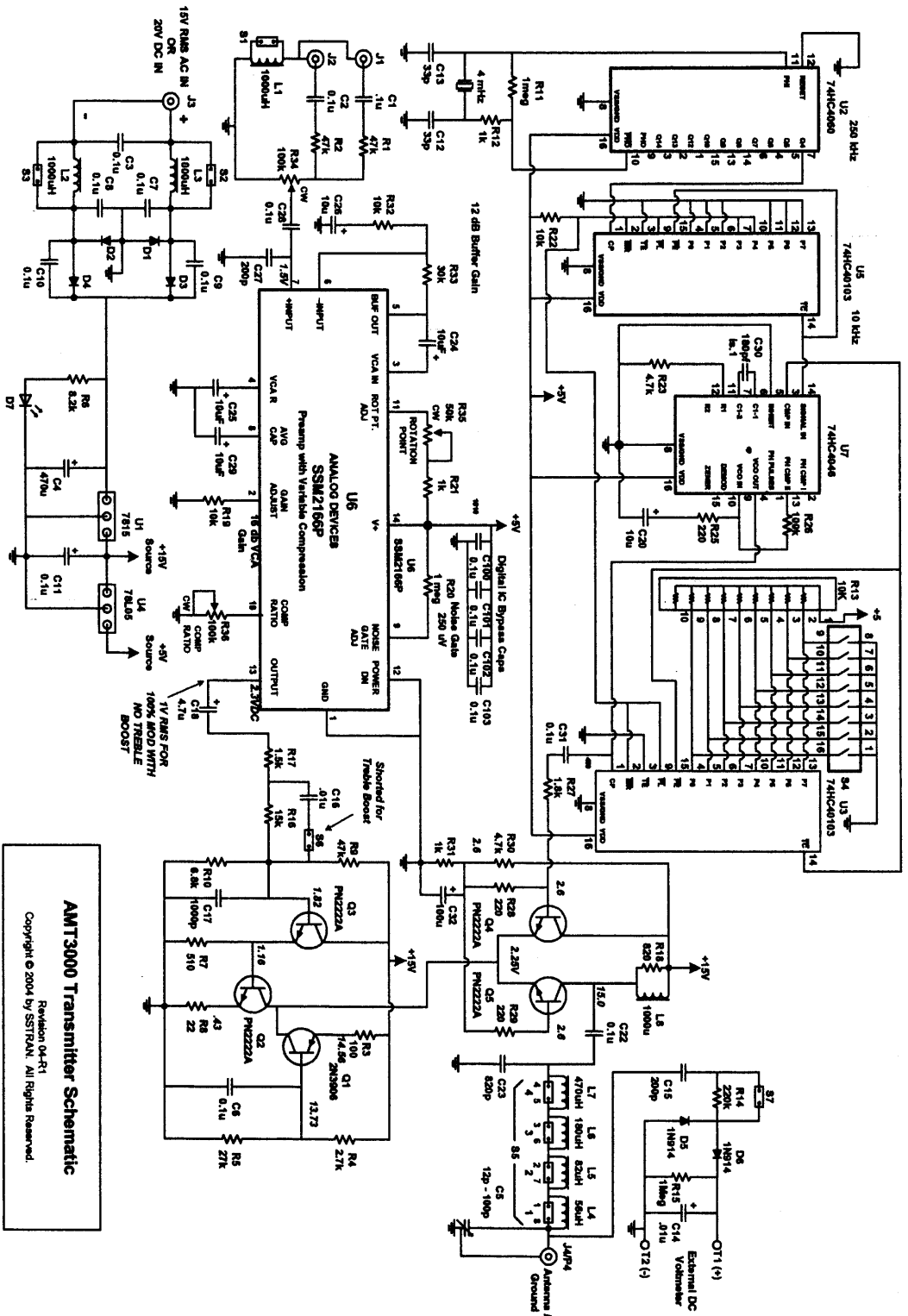

AMT3000 Transmitter Schematic
 Revision 04-R1
 Copyright © 2004 by SSTW, All Rights Reserved.