

SERVICE MANUAL **Alpage**

STEREO CASSETTE DECK **AC-300**

— REVISED —

This Service Manual is applicable to manufacture's
Serial Numbers after 10710001.

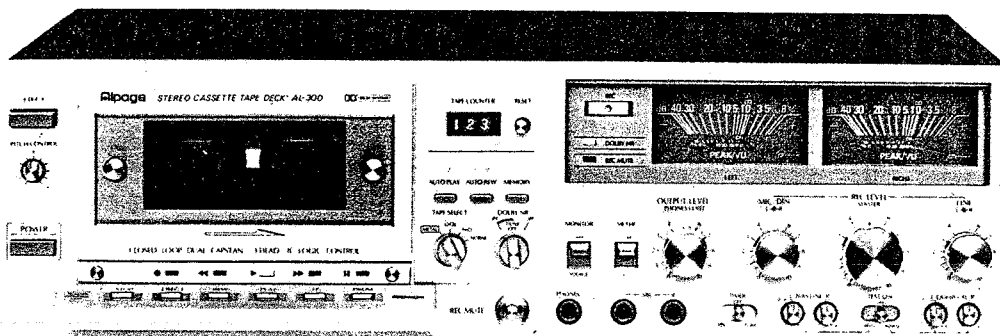

ALPINE ELECTRONICS INC.

Contents

Specifications	2
Parts Location and Disassembly Instructions	3 to 5
Adjustment Procedures	6 to 10
Adjustment Locations	11
Replacement of Mechanical Parts	12
Trouble Shooting Guide	13 to 15
Block Diagram	16
Parts Layout on P.C. Boards	17 to 28
Wiring Diagram (1/2)	29 to 30
Wiring Diagram (2/2) (For Multi Voltage Model)	31 to 32
Wiring Diagram (2/2) (For Single Voltage Model)	33 to 34
Schematic Diagram (1/2)	35 to 36
Schematic Diagram (1/2) Voltage Chart	37
Schematic Diagram (2/2) Voltage Chart	38 to 42
Schematic Diagram (2/2)	43 to 44
Electrical Parts List	45 to 61
Packing Assembly Parts List	62
Packing Method View	62
Exploded View (Cabinet)	63 to 64
Cabinet Assembly Parts List	65 to 66
Exploded View (Cassette Deck)	67 to 68
Cassette Deck Assembly Parts List	69 to 70
Semi-Conductor Lead Identifications	71 to 72

Specifications

Type	4-track, 2 channel stereo cassette deck, front loading vertical type
Power Source	AC 110/127/220/240V, 50/60 Hz (For multi-voltage model) AC120V, 60 Hz (For single voltage model)
Power Consumption	40W Max.
Tape Speed	4.76 cm/sec. \pm 1.5%
Wow & Flutter	0.06% Max. (JIS WRMS playback) 0.19% Max. (DIN WRMS Rec/Play)
FF/REW Time	75 sec. max. (C-60)
Frequency Response	30 Hz to 19 kHz (CrO ₂ /FeCr/Metal) 30 Hz to 17 kHz (Norm)
Rec/Play Head	Ferrite core record and playback combination head
Erase Head	Double gap ferrite core
Take Up Torque	40 gcm (30 – 60 gcm)
Signal to Noise Ratio	56 dB (Dolby*NR OFF, Metal) 64 dB (Dolby NR ON, Metal)
Distortion	2% max. (Metal)
Input Sensitivity	Mic: 0.3mV, Line: 100mV, Din (For multi-voltage model): 0.1mV/K ohm
Output	Line: 1000 mV, Headphone: 100mV
Load Impedance	Line: 100K ohm, Headphone: 8 ohm
Semiconductors Used	6 IC's, 118 Transistors, 17 FETs, 90 Diodes, 3 Zener Diodes, (For multi-voltage model) 6 IC's, 115 Transistors, 15 FETs, 88 Diodes, 3 Zener Diodes (For single voltage model)
Dimensions	435 (W) x 120 (H) x 300 (D) mm
Weight	8.7 kg

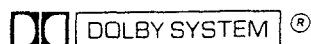

* Noise reduction system manufactured under licence from Dolby Laboratories Licensing Corporation.
"Dolby" and the double-D symbol are trademarks of Dolby Laboratories Licensing Corporation.

Parts Locations and Disassembly Instructions

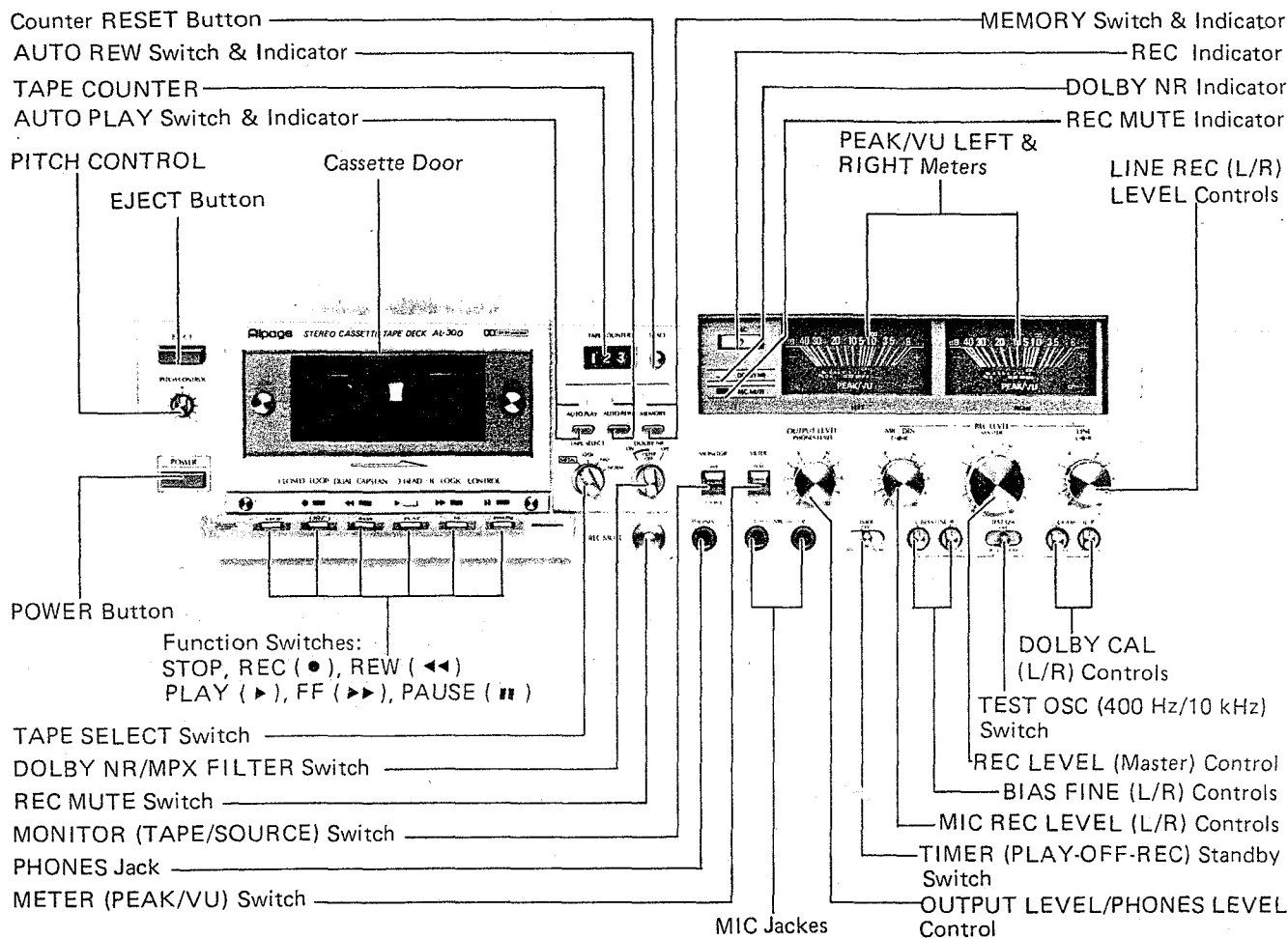

Figure 1

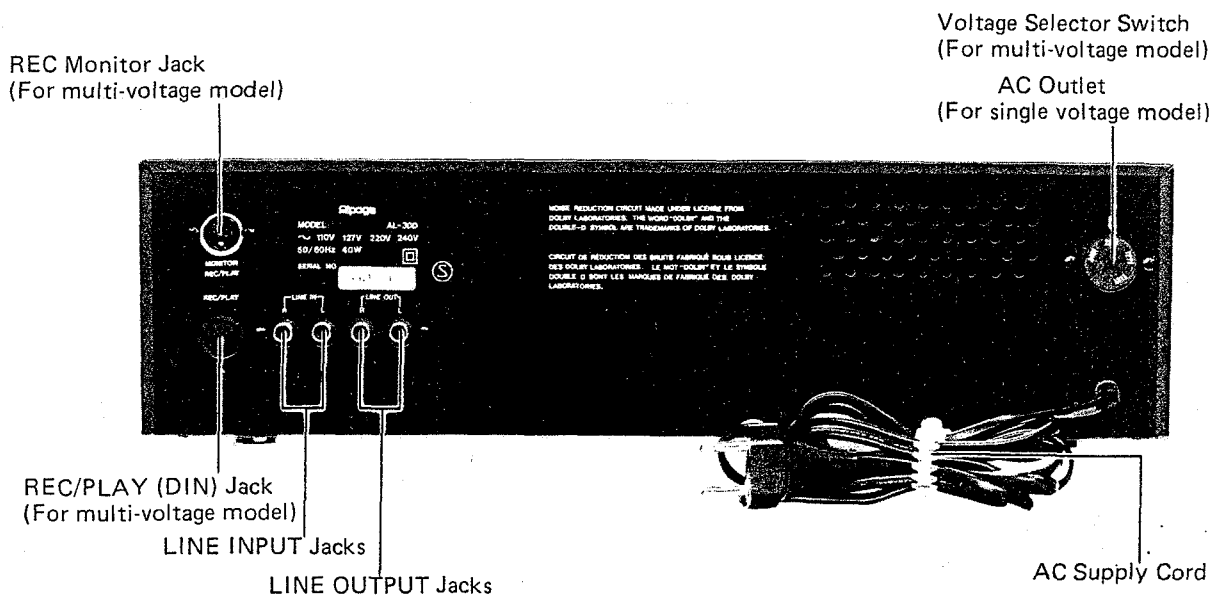

Figure 2

1. Removal of Top Cover

- (1) Remove six screws marked "o" as shown in Figure 3 and 4.
- (2) Lift up the top cover in the direction of the arrow as shown in Figure 4.

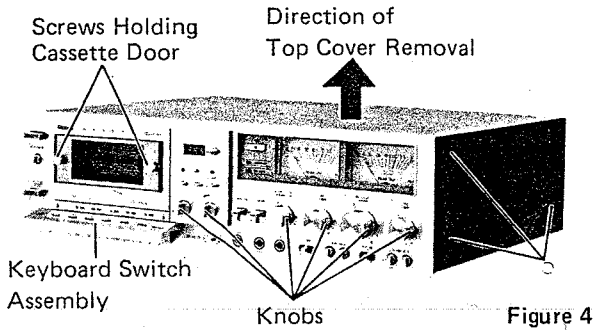

Figure 4

2. Removal of Front Panel

- (1) After removing the top cover, pull out the keyboard switch assembly and eight knobs as shown in Figure 4.
- (2) Remove two screws holding the cassette door and door frame as shown in Figure 4, and then remove them.
- (3) Remove ten screws marked "※" from the top and bottom sides of the front panel as shown in Figures 5 and 6.
- (4) Carefully disconnect lead wires from keyboard indicator and memory indicator P.C. Boards, and pull out the front panel in the direction of the arrow as shown in Figure 5.
- (5) After removing the front panel, remove four screws marked "△" as shown in Figure 7, and remove memory indicator and keyboard indicator P.C. Board.

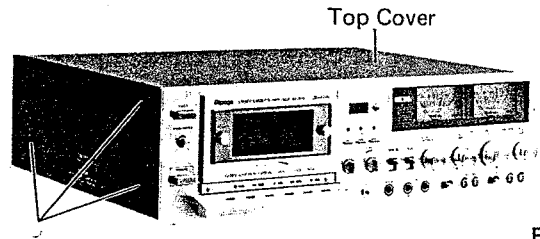

Figure 3

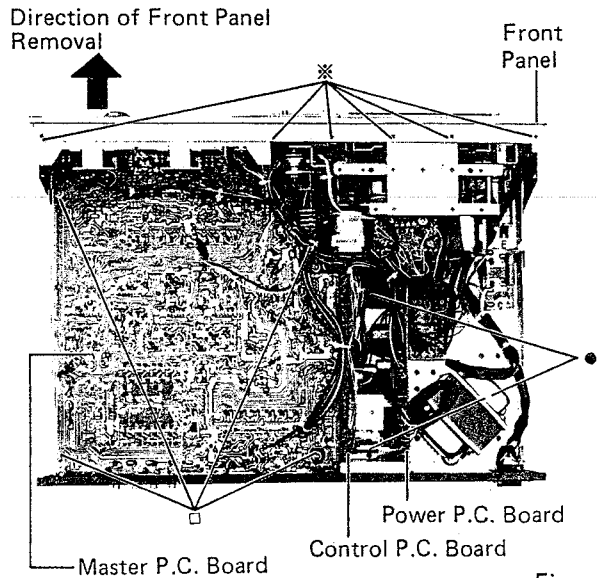

Figure 5

3. Removal of Control P.C. Board & Power P.C. Board

- (1) Remove two screws marked "●" as shown in Figure 5.
- (2) Remove four screws marked "■" as shown in Figure 8.
- (3) Disconnect all wires from the control P.C. Board and power P.C. Board.
- (4) The P.C. Boards can be completely removed from the chassis.

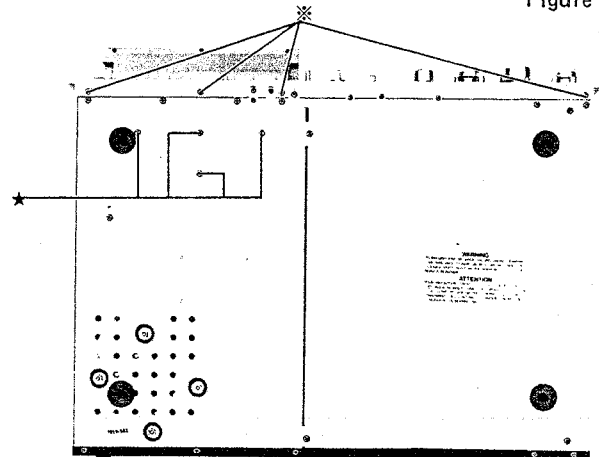

Figure 6

4. Removal of Cassette Deck

- (1) Remove four screws marked "★" as shown in Figure 6.
- (2) Disconnect all wires from the cassetted deck.
- (3) The cassette deck with deck P.C. Board and auto shut off P.C. Board can be completely removed from the chassis.

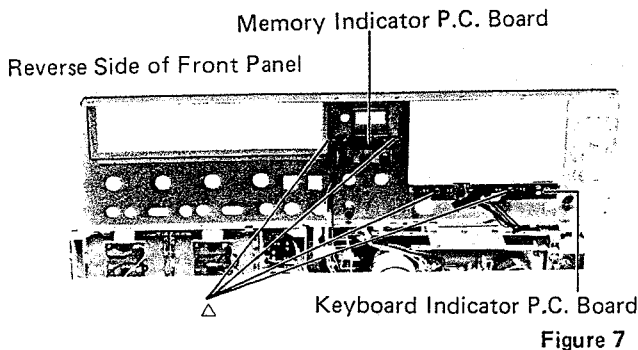

Figure 7

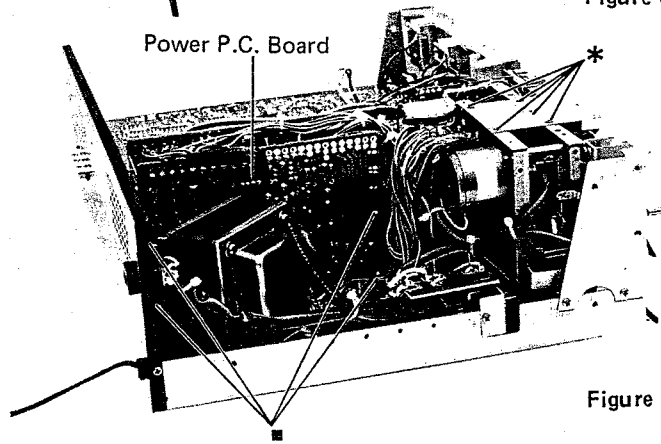

Figure 8

5. Removal of Meter Frame Assembly

- (1) Remove two screws marked "☆" from the side bracket (R) as shown in Figure 9.
- (2) Disconnect all wires from the meter frame assembly.
- (3) The meter frame assembly with lamp P.C. Board and LED P.C. Board can be completely removed from the chassis.

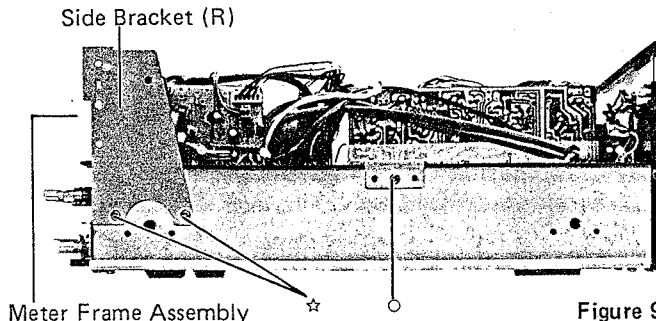

Figure 9

6. Removal of Master P.C. Board

- (1) Remove four screws marked "□" as shown in Figure 5.
- (2) Remove four screws marked "○" as shown in Figures 9 and 10.
- (3) Pull out two rivets holding the line-in/line out jacks as shown in Figure 11.
- (4) Disconnect all wires from the P.C. Board.
- (5) Master P.C. Board can be completely removed from the chassis.

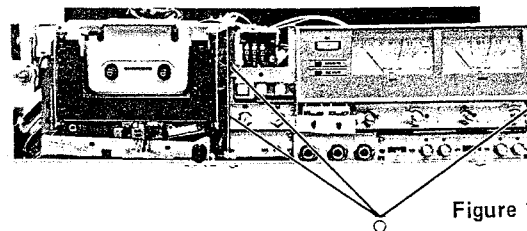

Figure 10

7. Removal of Sub Belt, Motor Belt, and Flywheels

- (1) Remove five screws marked "*" as shown in Figure 8.
- (2) Remove four screws marked "☆" as shown in Figure 12 and remove head solenoid.
- (3) Remove shaft that is holding solenoid lever as shown in Figure 12.
- (4) Remove four screws marked "*" from the sub chassis as shown in Figure 12.
- (5) The sub chassis can be completely removed from the cassette deck chassis, and then remove the sub belt or motor belt.

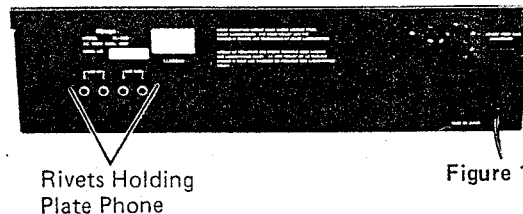

Figure 11

8. Removal of Counter Belt

- (1) Remove one "C" washer and two screws marked "#" as shown in Figure 13.
- (2) Lay down the support chassis in the direction of the arrow as shown in Figure 13.
- (3) Remove the counter belt.

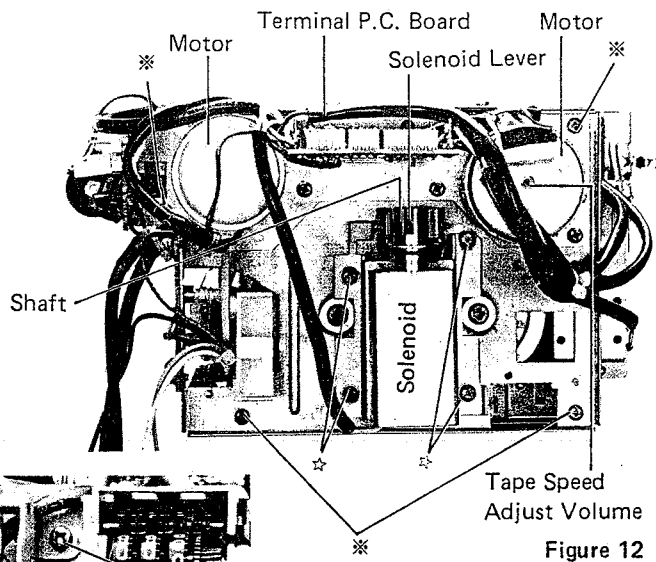

Figure 12

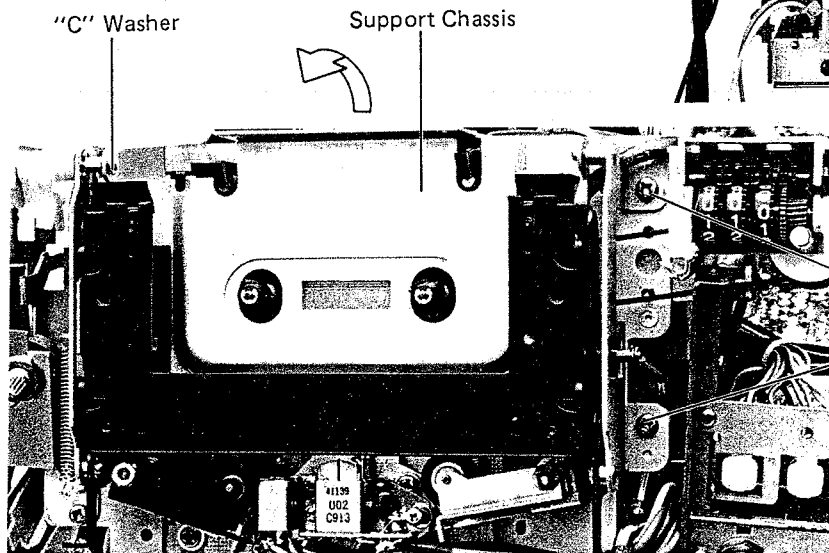

Figure 13

Adjustment Procedures

I. Rec/Play Combination Head Adjustment (Procedure for exchange the head.)

1. Adjustment of Head Height, Tilt Angle and Azimuth

Refer to "4-(2)-14), Rec/Play Combination Head <AL-80>" in FL Cassette Deck Mechanism of ALpage Technical News.

2. Head's Peculiarity Reparation Adjustment (C401, 402)

(1) Conneciton

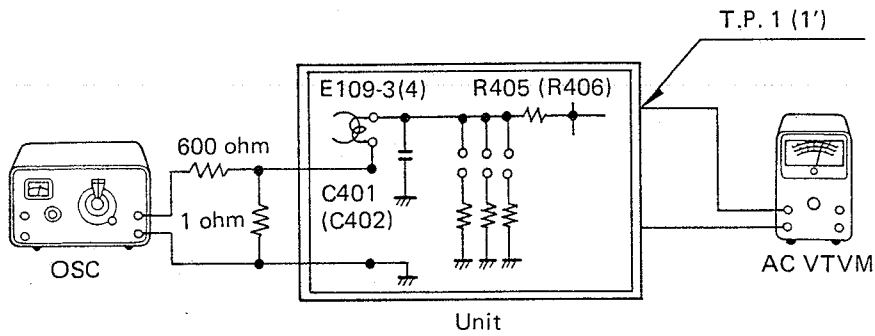

Figure 14

Connect the resistors (1 ohm) to the ground side (BLK) of playback head wires (YEL, RED) and connect other sides, of resistors to the ground.

Connect the oscillator to both sides of the resistor. (Figure 15)

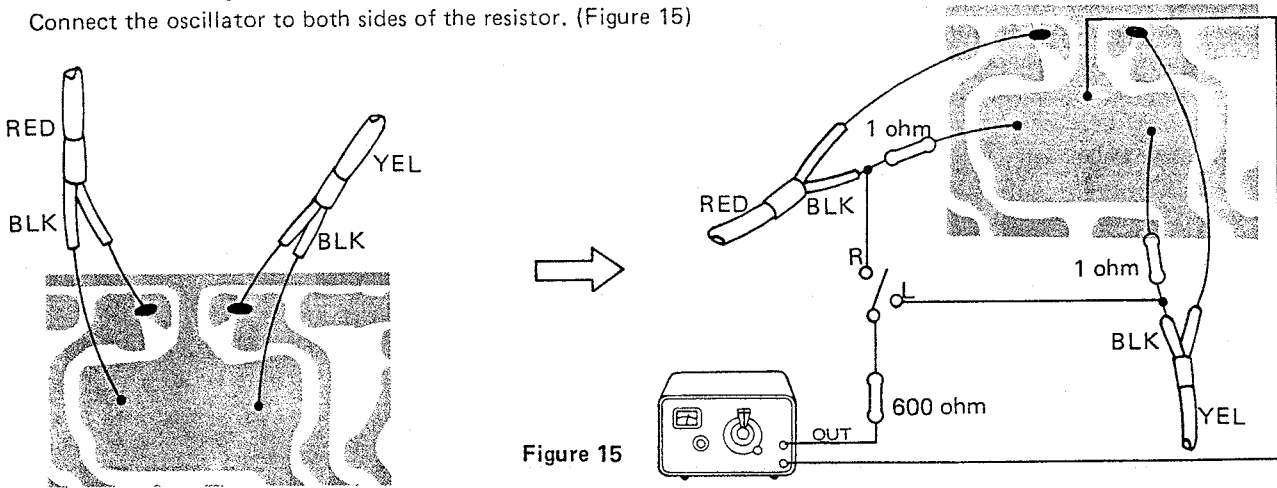

Figure 15

- (2) Set the OSC frequency to 200 Hz and adjust for 1V (0 dBV) at T.P.1 (1') by OSC output controller.
 - (3) Increase the OSC frequency seeing the Volt meter and confirm the value of the volt meter as shown in Figure 16. Choose the capacitor (C401, 402) that the peak point become to 24 kHz as shown in Figure 15.
- Note: C401 and C402 are not always the same capacitance.

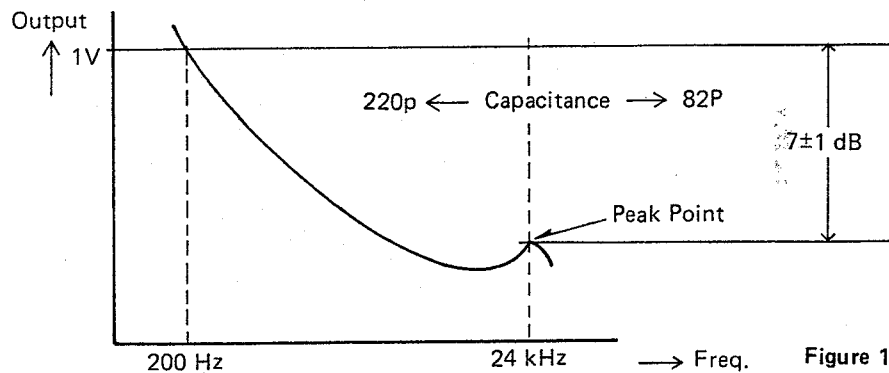

Figure 16

II. Frequency Response Adjustment

1. Measuring Equipment

- | | |
|-------------------------|----------------------|
| (1) Frequency Generator | (3) Oscilloscope |
| (2) AC Volt Meter | (4) Distortion Meter |

2. Test Tapes

- | | |
|----------------------------------|------------------------|
| (1) AC-711 (TDK) | METAL |
| (2) AC-512 (TDK) | CrO ₂ |
| (3) CS-30 (SONY) | FeCr |
| (4) AC-222 (TDK) or AC-223 (TDK) | NORMAL |

3. Connection

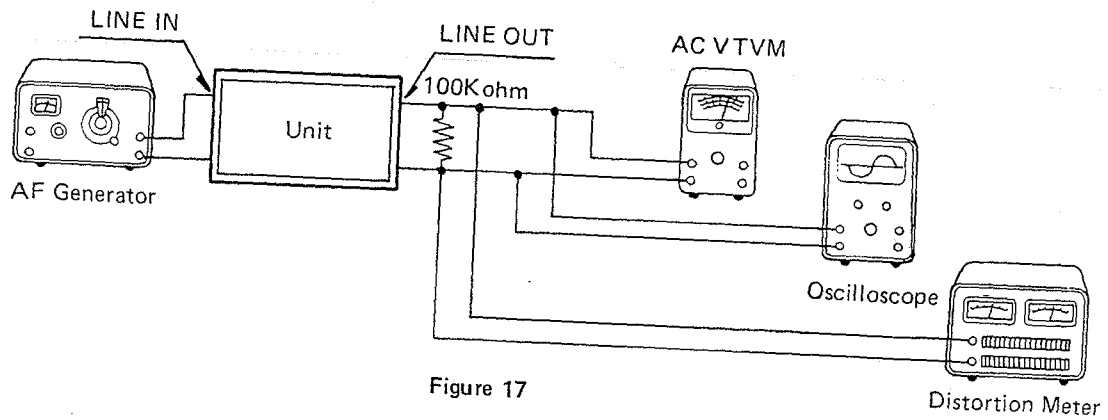

Figure 17

4. Function Set

- | | |
|--------------|--------------|
| DOLBY NR | OFF |
| Bias Fine VR | Center |

- | | |
|---------------|--------------|
| Pitch Control | Center |
| Dolby CAL. VR | Center |

5. Procedure

(1) Metal

- 1) Set test tape AC-711 into cassette compartment.
- 2) Set tape select switch at METAL position.
- 3) Set monitor switch at SOURCE position.
- 4) Set output volume at max. position and MIC volume at min. position and master recording volume at max. position.
- 5) Set oscillator frequency at 400 Hz
- 6) Adjust the value of voltage meter to be 1V (0 dB) by line volume.
- 7) Set output of oscillator down to -25 dB level and output of volt meter as well.
(In case of no level selector in oscillator, adjust volt meter to -25 dB level by master volume)
- 8) Set monitor switch at TAPE position.
- 9) Push both record and play buttons and memorize the value of volt meter during recording.
- 10) Change oscillator frequency to 10 kHz and adjust the level of volt meter to the same level checked at No. 9 by VR115 and VR116 for bias adjustment.
- 11) Then, change oscillator frequency to 20 kHz and adjust the level of volt meter to the same level at No. 9 by L113 and L114. (Peaking Coil)

Note: * In case that the level at 20 kHz is more than that of 400 Hz, turn peaking coil counterclockwise so that the level becomes the nearest possible level as measured under No. 9.

* In case that the level at 20kHz is less than that of 400 Hz, turn peaking coil clock wise so that the level becomes the nearest possible level as measured under No. 9.

* 400 Hz = 10 kHz \leq 20 kHz \rightarrow 0 + 1 dB: OK

- 12) In case that 20 kHz level is still less than that of 400 Hz as measured under No. 11, add Mylar capacitors C907 and C908 with dipping solder on point B (B').
- 13) Repeat gain as measured under No. 10 so that the levels at 400 Hz, 10kHz, and 20 kHz can be equal.
- 14) In case of the same level at 400 Hz/10 kHz/20 kHz as measured under No. 12 or No. 13, set test OSC at 400 Hz position and adjust level meter of left and right channels to be OVU by volume of Dolby CAL.
- 15) Set test OSC at 10 kHz position and check each level meter to be OVU \pm 0.5VU.

- 16) Check left channel level meter to be less than -1VU by bias fine -L volume turning clockwise (+) and level meter to be more than + 1VU by turning counterclockwise (-).
- 17) Check bias fine -R volume as well as measured under No. 16.
- 18) In case that level meter indicates always (-) side or fails in indicating more than + 1VU as measured under No. 16 and 17, return to No. 12 and add mylar capacitor 0.0022 μ F or 0.0039 μ F on C221 or C222 in parallel from the bottom side of P.C. Board and repeat adjustment under No. 10.
- 19) If OK under No. 18, check the distortion.

(2) CrO₂

- 1) Set test tape AC-512 into cassette compartment.
- 2) Set tape select switch at CrO₂ position and bias fine and Dolby CAL. volume at center position.
- 3) Do the same adjustment of No. 3 to No. 9 under Metal.
- 4) Change frequency of OSC to 10 kHz and adjust the level of volt meter to the same level as measured under No. 3 by VR131 and VR132 for bias adjustment.
- 5) Then, change frequency of OSC to 20 kHz and adjust the level of Volt Meter to the same level as measured under No.3 by L103 and L104.
- 6) In case that 20 kHz level is less than that of 400 Hz and 10 kHz, add mylar capacitors C901 and C902 with dipping solder on point C (C').
- 7) Do the same adjustment No. 13 to No. 19 under Metal.

(3) FeCr

- 1) Set test tape CS-30 into cassette compartment.
- 2) Set Tape Select switch at FeCr position and bias fine and Dolby CAL. volume at center position.
- 3) Do the same adjustment from No. 3 to No. 9 under Metal.
- 4) Change frequency of OSC to 10 KHz and adjust the level of volt meter to the same level as measured under No. 3 by VR119, 120 for bias adjustment.
- 5) Then, change frequency of OSC to 20 KHz and adjust the level of volt meter to the same level as measured under No. 3 by L105 and L106.
- 6) In case that 20 KHz level is less than that of 400 Hz and 10 KHz, add mylar capacitors C903 and C904 with dipping solder on point D (D').
- 7) Do the same adjustment from No. 13 to No. 19 under Metal.

(4) Nomal

- 1) Set test tape AC-222 or AC-223 into cassette component.
- 2) Set tape select switch at NORM position and bias fine and Dolby CAL. volume at center position.
- 3) Do the same adjustment from No. 3 to No. 9 under Metal.
- 4) Change frequency of OSC to 10 kHz and adjust the level of volt meter to the same level as measured under No. 3 by VR117 and VR118 for bias adjustment.
- 5) Then change frequency of OSC to 20 kHz and adjust the level of volt meter to the same level as measured under No. 3 by L107 and L108.
- 6) In case that 20 kHz level is less than that of 400 Hz and 10 kHz, add mylar capacitors C905 and C906 with dipping solder on point E (E').
- 7) Do the some adjustment from No. 13 to No. 19 under Metal.

(5) Level Calibration

- 1) Set test tape AC-512 into cassette compartment.
- 2) Set tape select switch CrO₂ position.
- 3) Do the same adjustment from No. 3 to No. 9 under Metal.
- 4) Adjust the same level at No. 7 and No. 9 under Metal by VR113, 114 for rec. level adjustment.

3. Electrical Adjustment

To properly test, adjust and repair Alpage AL-300 Cassette Decks the equipment listed below are needed.

- (1) AC Volt meter.
- (2) Dual trace oscilloscope.
- (3) Audio Generator
- (4) Frequency counter.
- (5) DC Volt meter.

Test Tapes

- (1) MTT-111 Wow/Flutter (-10 dB, 3kHz)
- (2) MTT-150 or VTT-666 Dolby Level (200 nwb/m)

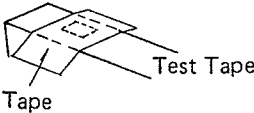
STEP	DESCRIPTION	MODE	ADJUST POINT	CHECK POINT	CONNECTION INSTRUCTION	REMARKS
1	Tape Speed Adjustment	A RECORD Tape Select : Norm. Monitor : Tape NR: Off	E204 (Motor Inside) Adjust VR, See Figure 12)	T.P. 2 T.P. 2'	Figure 19	(1) Test Tape: MTT-111 (Anti-Rec Hole should be covered with tape.)  Tape Test Tape (2) Bias OSC should be cut off. (Refer to Note 2.) (3) Adjust for 3,000 Hz.
		B PLAY Tape Select : Norm. Monitor : Tape NR: Off	VR129	T.P. 2 T.P. 2'	Figure 19	(1) Test Tape: MTT-111 (2) Adjust for 3,000 Hz. (3) Pitch control VR (VR130) should be positioned at click point.
2	Playback Level Adjustment	PLAY Tape Select : Norm. Monitor : Tape NR: Off	VR123 VR124	T.P. 2 T.P. 2'	Figure 18	(1) Test Tape MTT-150 (2) Adjust for 580mV.
3	DC Balance Adjustment	RECORD Monitor : Source	VR133 VR134	T.P. 3 T.P. 3'	Figure 21	(1) Line Input: Nor (2) Adjust for 10 V.
4	Line Reference Level Adjustment	STOP Tape Select : Norm. Monitor : Tape NR: Off	VR101 VR103	T.P. 4 T.P. 4'	Figure 20	(1) Line Input Signal: 400 Hz, 500 mV. (2) Adjust for 580 mV.
5	Monitor Level Adjustment	STOP Tape Select : Norm. Monitor : Source NR: Off	VR121 VR122	T.P. 2 T.P. 2'	Figure 20	(1) Line Input Signal: 400 Hz, 500 mV. (2) Adjust for 580 mV.
6	Level Meter Gain Adjustment	STOP Tape Select : Norm. Monitor : Source NR: Off	VR125 VR126	T.P. 5 T.P. 5'	Figure 20	(1) Line Input Signal: 400 Hz, 500 mV. (2) Adjust for 1V.
	Level Meter 0 dB Adjustment	STOP Tape Select : Norm. Monitor : Source NR: Off	VR127 VR128	Level Meter	Figure 20	(1) Line Input Signal: 400 Hz, 500 mV (2) Adjust for 0 dB. (<input type="checkbox"/> Marked point) on Level Meter.

STEP	DESCRIPTION	MODE	ADJUST POINT	CHECK POINT	CONNECTION INSTRUCTION	REMARKS
7	Test OSC Level Adjustment 400 Hz	STOP Tape Select : Norm. Monitor : Source NR: Off Test OSC : 400 Hz	VR109 VR110	Level Meter		Adjust for 0 dB (<input type="checkbox"/> Marked point) on Level Meter.
	Test OSC Level Adjustment	STOP Tape Select : Norm. Monitor : Source NR: Off Test OSC : 10 kHz	VR111 VR112	Level Meter		Adjust for 0 dB (<input type="checkbox"/> Marked point) on Level Meter.
8	Frequency Response Adjustment	See Step II. Frequency Response Adjustment.				

- Note: 1. For adjustment, set the pitch control volume, bias fine volume and Dolby calibration volume to the mechanical center position.
 2. Bias cut: Ground the base of Q138 (Point A in adjustment Location)
 3. Refer to adjustment procedures of AL-80 in Alpage Technical News (FL Series Cassette Deck Mechanism) for head azimuth, height, and tilt angle.

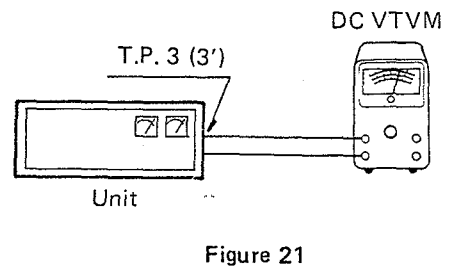
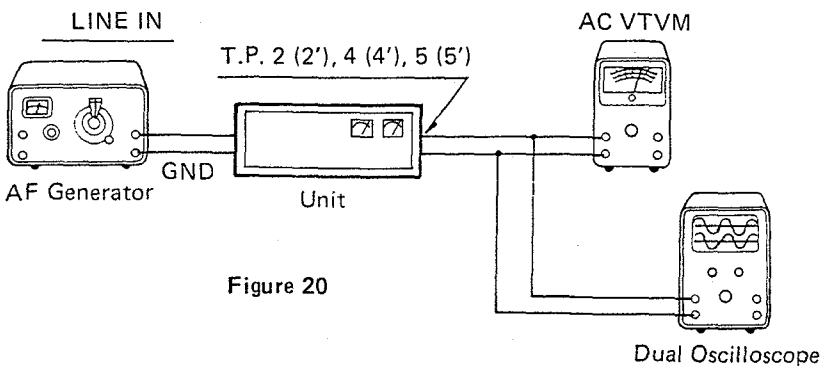
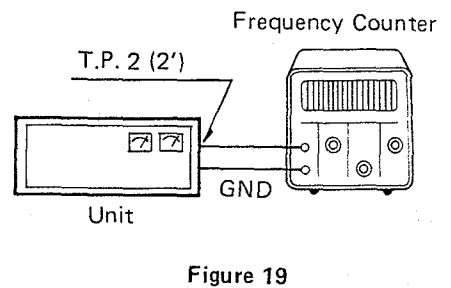
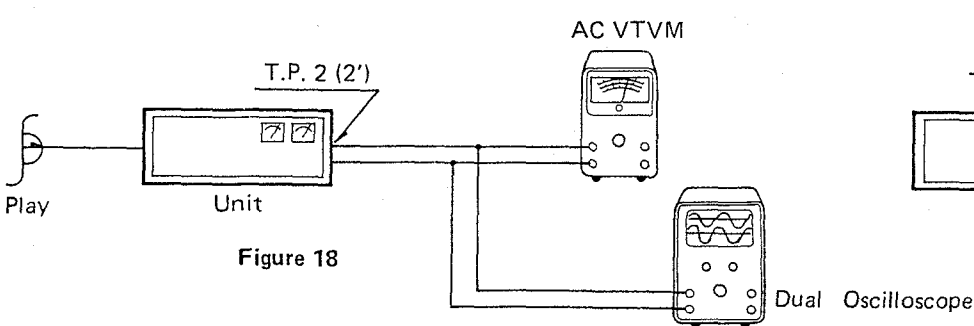

Adjustment Location

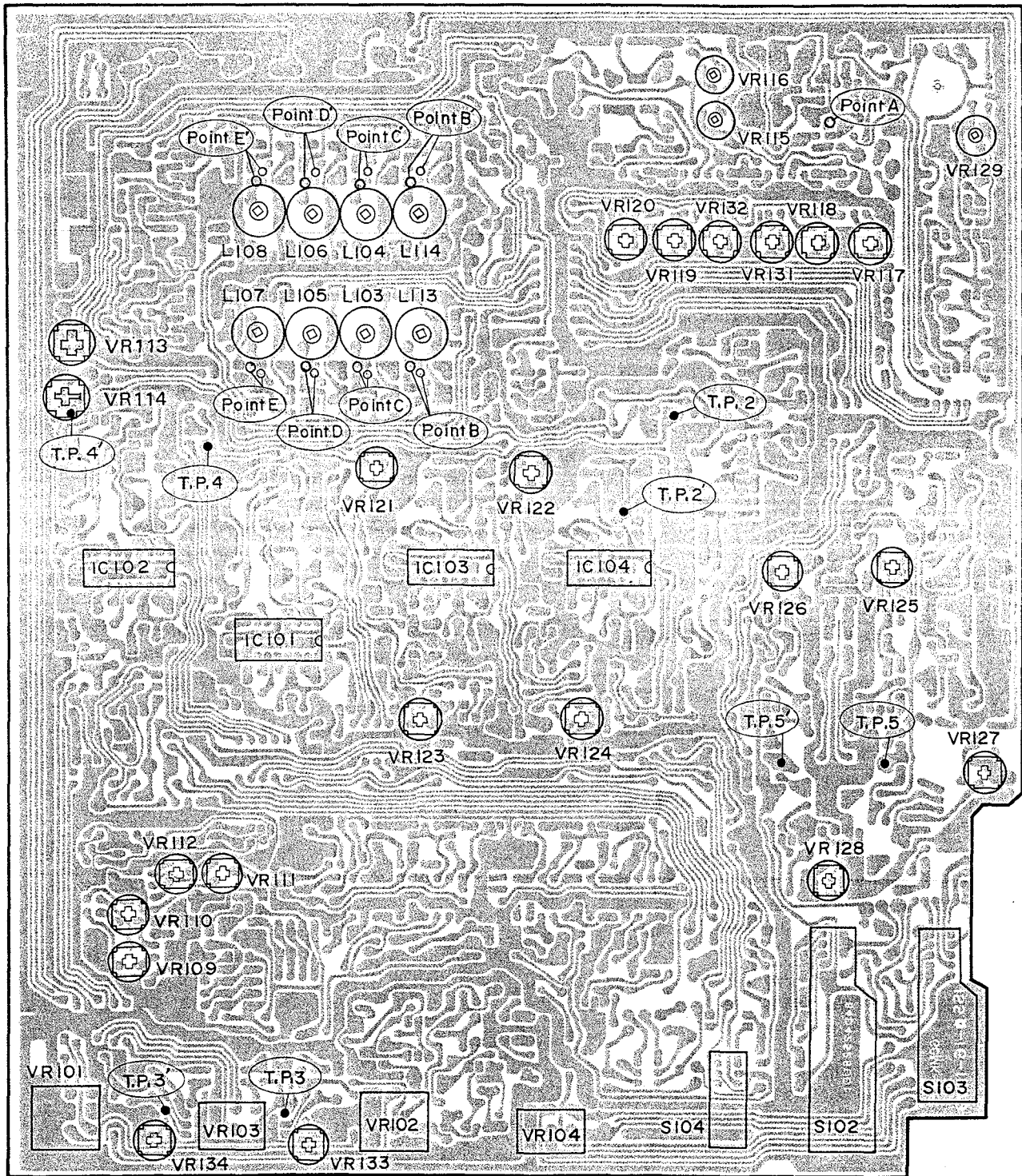

R/P Master P.C. Board

Replacement of Mechanical Parts

1. Replacement of Cassette Deck

- (1) Remove the top cover. (Refer to page 4 for removal.)
- (2) Remove the front panel. (Refer to (1) through (4) under front panel removal on page 4.)
- (3) Remove control P.C. Board and power P.C. Board. (Refer to page 4 for removal.)
- (4) Remove the cassette deck. (Refer to page 4 for removal.)

2. Replacement of Head

- (1) Remove two screws marked "A" and "B" to remove the erase head as shown in Figure 22.
- (2) Remove two screws marked "C" and "D", to remove the R/P head with the P.C. Board as shown in Figure 22.
- (3) After replacement with the good heads, assemble them in the opposite way to the disassembly. After assembling, adjust the head azimuth, tilt angle and the height with the test tape. (Refer to page 6 for adjustment.)

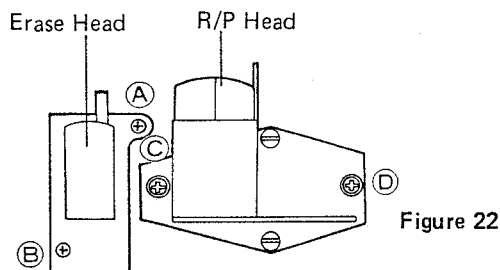

3. Replacement of Sub Belt, Motor Belt, and Right and Left Flywheels.

- (1) Remove the sub belt and the motor belt, and right and left flywheels can be easily removed. (refer to page 5 for removal of the sub belt and the motor belt.)
- (2) After replacement with the good belts and the flywheels, clean the belt with isopropyl alcohol and assemble them in the opposite way to the disassembly.
- (3) After assembling, confirm tape speed and wow/flutter with the test tape (MTT-111).

4. Replacement of Motor

- (1) Remove three screws marked "A", "B", and "C" and four wires of white, orange, blue, and yellow from terminal P.C. Board to remove the motor marked "1" as shown in Figure 23.
- (2) Remove three screws marked "D", "E", and "F" and two wires of red and black from terminal P.C. Board to remove the motor marked "2" as shown in Figure 23.
- (3) After replacement with the good motor, assemble

them in the opposite way to the disassembly.

- (4) After assembling, confirm tape speed and wow/flutter with the test tape (MTT-111).

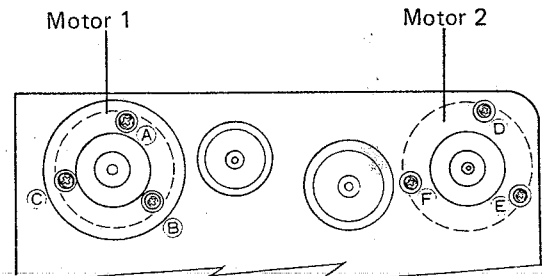

Figure 23

5. Replacement of Counter Belt

- (1) Refer to page 5 for removal.
- (2) After replacement with good belt, clean it with isopropyl alcohol and assemble it in the opposite way to the disassembly.

6. Replacement of Pinch Roller

- (1) Remove two nuts marked "A" and "B" and two washers marked "A" and "B" to remove the pinch roller assembly as shown in Figure 24.
- (2) Remove "C" washer to remove the pinch roller marked "2" as shown in Figure 24.
- (3) After replacement with good pinch roller assembly, clean the pinch roller with isopropyl alcohol and assemble it in the opposite way to the disassembly.
- (4) After assembling, confirm tape speed and wow/flutter with the test tape (MTT-111).

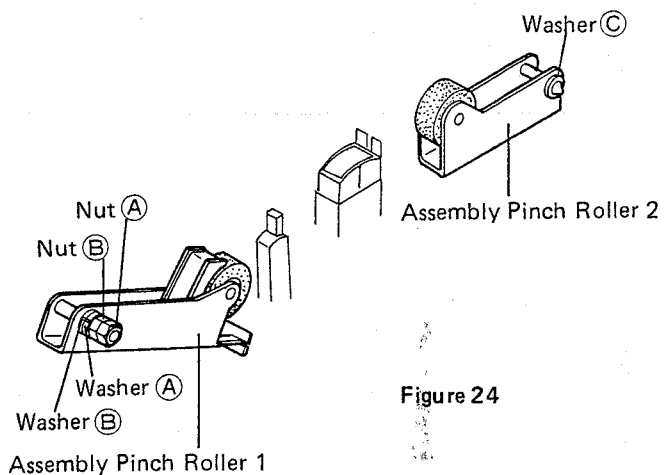

Figure 24

Trouble Shooting Guide

Sumptom	Possible Cause
No power	<ol style="list-style-type: none"> 1. Defective power switch 2. Defective DC supply block 3. Defective power connections
No power to motor	<ol style="list-style-type: none"> 1. Defective motor 2. Defective servo 3. Defective start switch
Distorted sound	<ol style="list-style-type: none"> 1. Record/Play head dirty 2. Defective cassette tape 3. Record/Play head magnetized 4. Record/Play head defective
High frequency deteriorated	<ol style="list-style-type: none"> 1. Playback Azimuth improperly adjusted 2. Record/Play head dirty 3. Record/Play head magnetized 4. Excessive Wow/Flutter 5. Incorrect tape travel 6. Record/Play head defective 7. Cassette tape defective
Excessive Wow/Flutter	<ol style="list-style-type: none"> 1. Flywheel assembly defective 2. Motor defective 3. Defective Servo 4. Drive belt defective 5. Pinch roller assembly defective 6. Slippage between tape and pinch roller 7. Idler pulley defective 8. No clearance between flywheel and thrust screw 9. Tape counter defective 10. Excessive back-tension 11. Improper tape-up torque 12. Defective tape cassette
Signal to noise ratio deteriorated	<ol style="list-style-type: none"> 1. Record/Play head magnetized 2. Record/Play head dirty 3. Record/Play head defective 4. Output amplifier defective 5. Cassette tape defective
Loss of channel separation	<ol style="list-style-type: none"> 1. Improper tape travel 2. Record/Play head defective
Level variations	<ol style="list-style-type: none"> 1. Record/Play head dirty 2. Record/Play head defective 3. Record/Play head misaligned 4. Cassette tape defective
Improper tape travel	<ol style="list-style-type: none"> 1. Pinch roller misaligned 2. Weak pinch roller pressure 3. Capstan defective 4. Pinch roller defective 5. Record/Play head misadjusted

Symptom	Possible Cause
Tape speed to fast/slow	<ol style="list-style-type: none"> 1. Defective cassette tape 2. Defective motor 3. Defective servo
Tape does not move	<ol style="list-style-type: none"> 1. Defective cassette tape 2. Defective motor 3. Defective servo 4. Drive belt off 5. Reel hub defective 6. Pinch roller not contacting capstan 7. Defective power connections 8. Cassette loaded incorrectly 9. Drive belt out of place
Drive belt out of place	<ol style="list-style-type: none"> 1. Idler pulley misaligned 2. Motor misaligned 3. Drive belt defective 4. Excessive clearance between flywheel and flywheel holder
Does not record	<ol style="list-style-type: none"> 1. Record/Play head defective 2. Record/Play head dirty 3. Record amp defective 4. Defective record interlock switch 5. Cassette has safety tabs removed 6. Broken head wire 7. Bias oscillator defective 8. Input jack defective 9. Defective mute switch
Does not playback	<ol style="list-style-type: none"> 1. Record/Play head dirty 2. Record/Play head defective 3. Defective playback amplifier 4. Defective output buffer amplifier 5. Defective tape output jack 6. Defective mute switch 7. Defective Dolby circuit 8. Wire between Record/Play head and playback amplifier broken 9. Improper tape travel 10. Defective preamp output jack
Does not erase	<ol style="list-style-type: none"> 1. Defective erase head 2. Erase head dirty 3. Bias oscillator defective 4. Broken wire on head
Auto shut off does not work at end of tape	<ol style="list-style-type: none"> 1. Auto-shut off detector defective 2. Auto-shut off driver defective 3. Solenoid driver defective 4. Defective Deck button 5. Wire between solenoid and driver is broken 6. Solenoid incorrectly adjusted

Symptom	Possible Cause
Auto shut off activates before tape end (Memory Switch off)	<ol style="list-style-type: none"> 1. Auto-shut off detector defective 2. Auto-shut off driver defective 3. Defective counter 4. Defective counter belt 5. Cassette tape defective

CHECKS TO BE PREFORMED AFTER REPAIR

Part Replaced	Check
Motor	<ol style="list-style-type: none"> 1. Tape speed 2. Wow/Flutter 3. Drive belt position
Drive belt	<ol style="list-style-type: none"> 1. Belt position 2. Tape speed 3. Wow/Flutter
Record/Play head	<ol style="list-style-type: none"> 1. Inclination of Record/Play head 2. Azimuth/height 3. Tape travel 4. Playback output 5. Playback frequency response 6. Signal to noise ratio 7. Record/Play response
Flywheel	<ol style="list-style-type: none"> 1. Clearance between flywheel and thrust screw 2. Tape travel 3. Azimuth/height 4. Tape speed
Pinch roller	<ol style="list-style-type: none"> 1. Tape travel 2. Tape speed 3. Azimuth/height 4. Wow/Flutter
Tape counter	<ol style="list-style-type: none"> 1. Tape speed 2. Auto-shut off 3. Counter 4. Wow/Flutter
Reel Hub	<ol style="list-style-type: none"> 1. Torque check 2. Tape speed 3. Wow/Flutter

Block Diagram

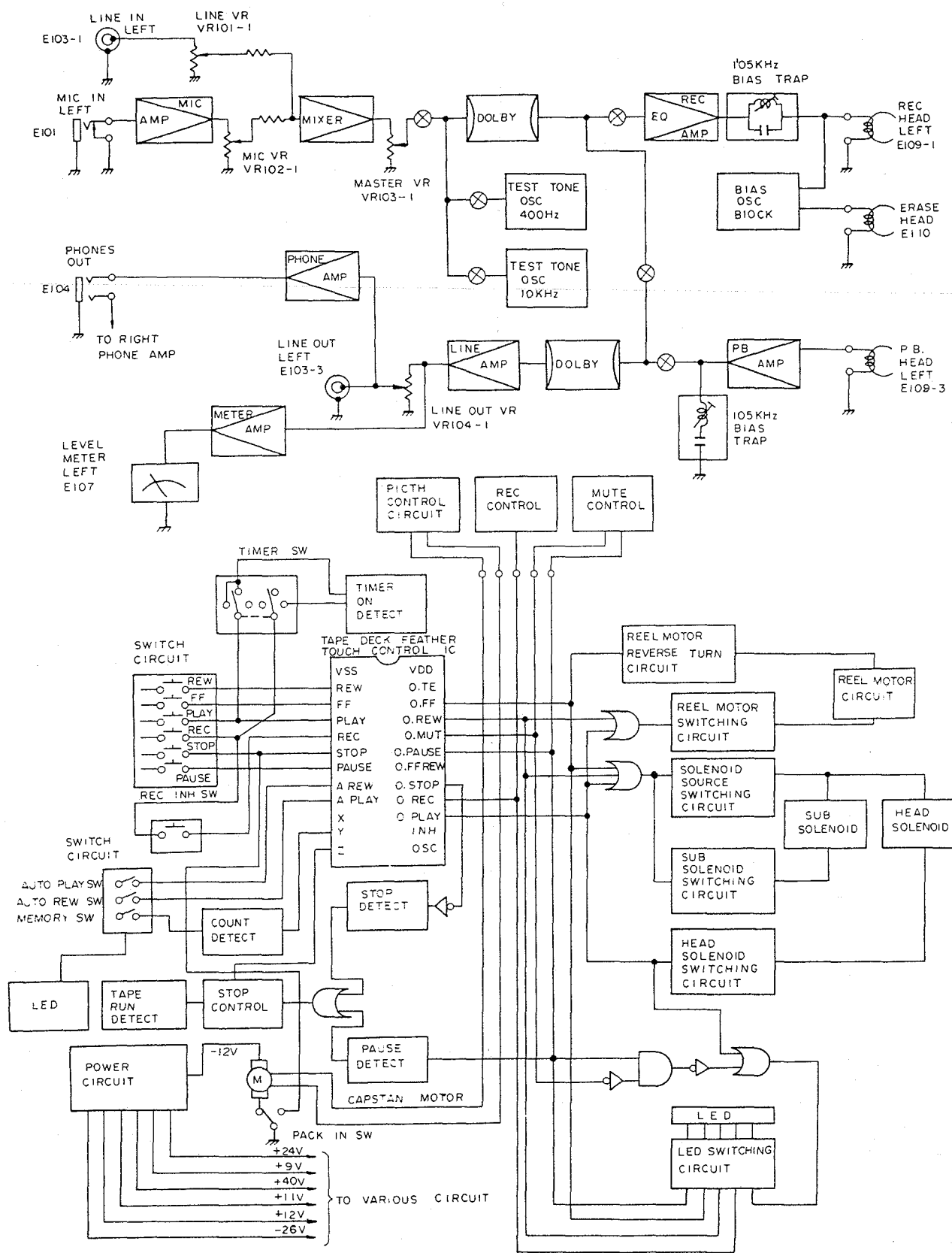

Parts Layout on P.C. Boards

Keyboard P.C. Board

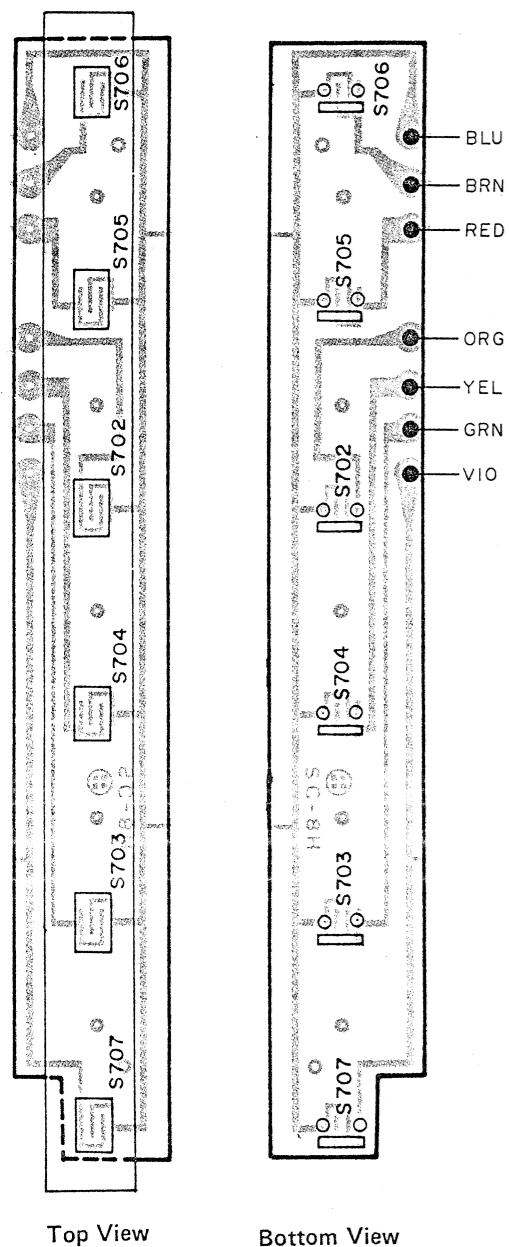

Keyboard Indicator P.C. Board

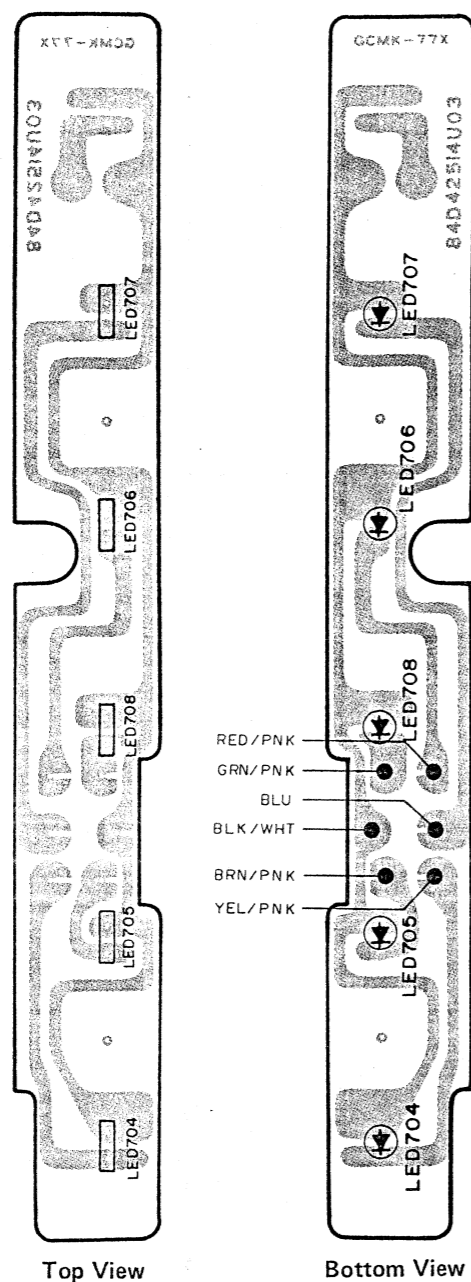

Timer Switch P.C. Board

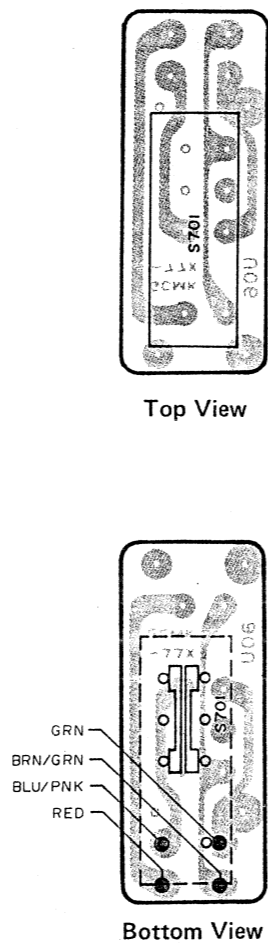

Shut Off P.C. Board

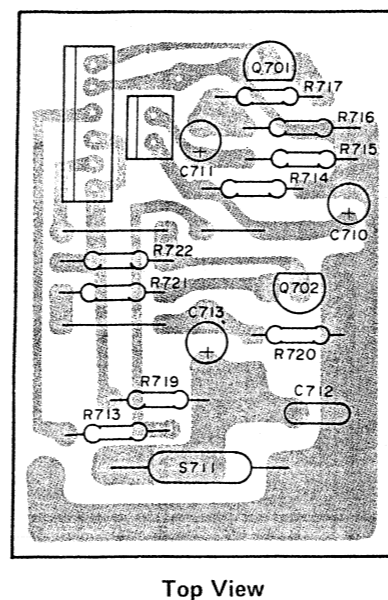

NO.	MEMORY SW. OFF		
	A	REW	OFF
STATE	E	C	B
STOP	GND	OV	OV
STOP	0.00	8.97	0.00
REW	0.01	8.75	0.01
PLAY	0.01	0.75	0.01
PLAY	0.01	8.97	0.01
PAUSE	0.01	8.97	0.01
REC	0.01	8.75	0.01
PLAY/PAUSE	0.01	8.97	0.01
F. F.	0.01	8.75	0.01
PAUSE	0.01	8.97	0.01

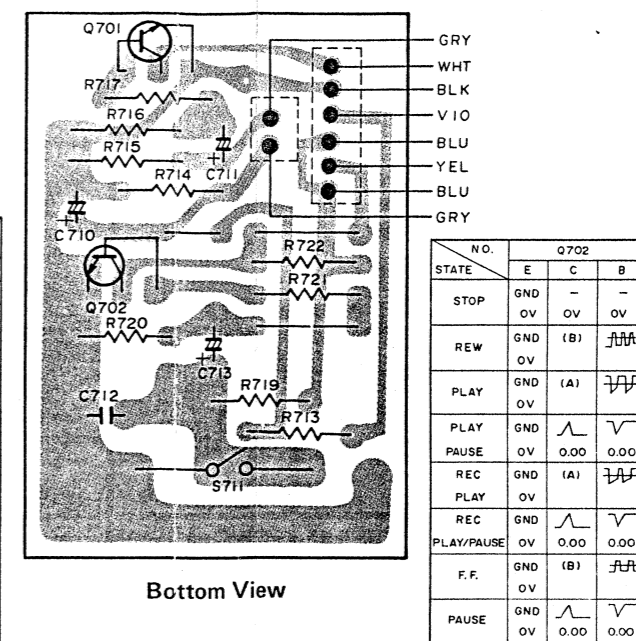

Meter Lamp P.C. Board

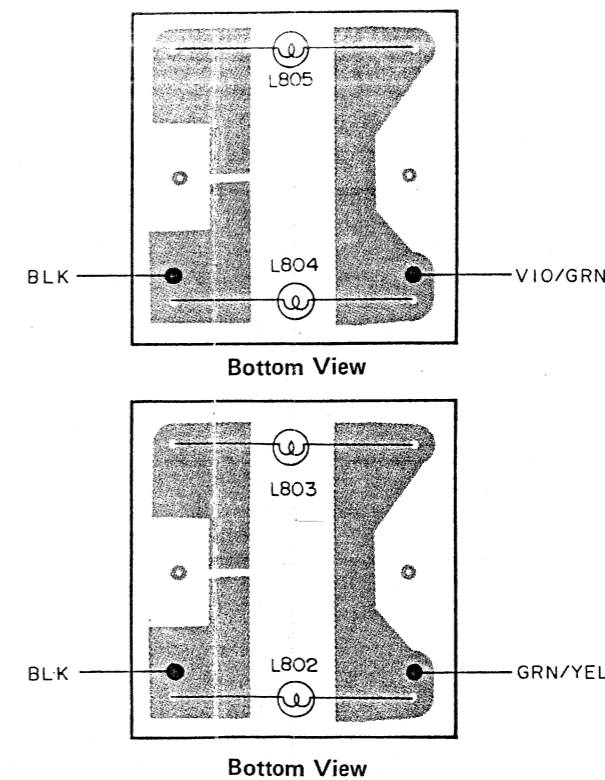
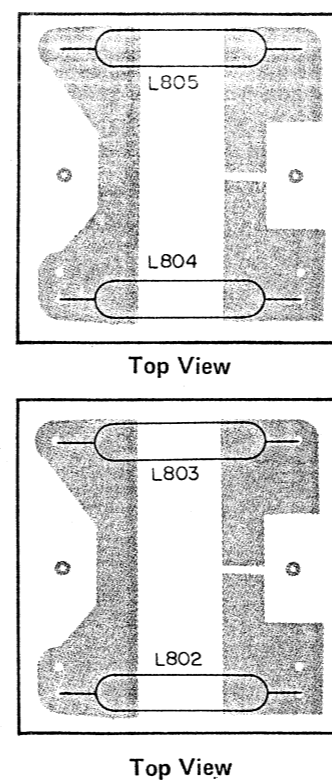

Power Switch P.C. Board (For single voltage model only)

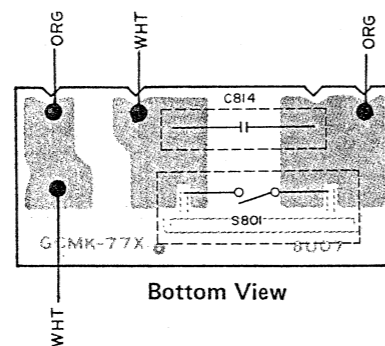
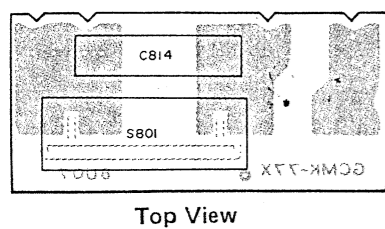

Control P.C. Board

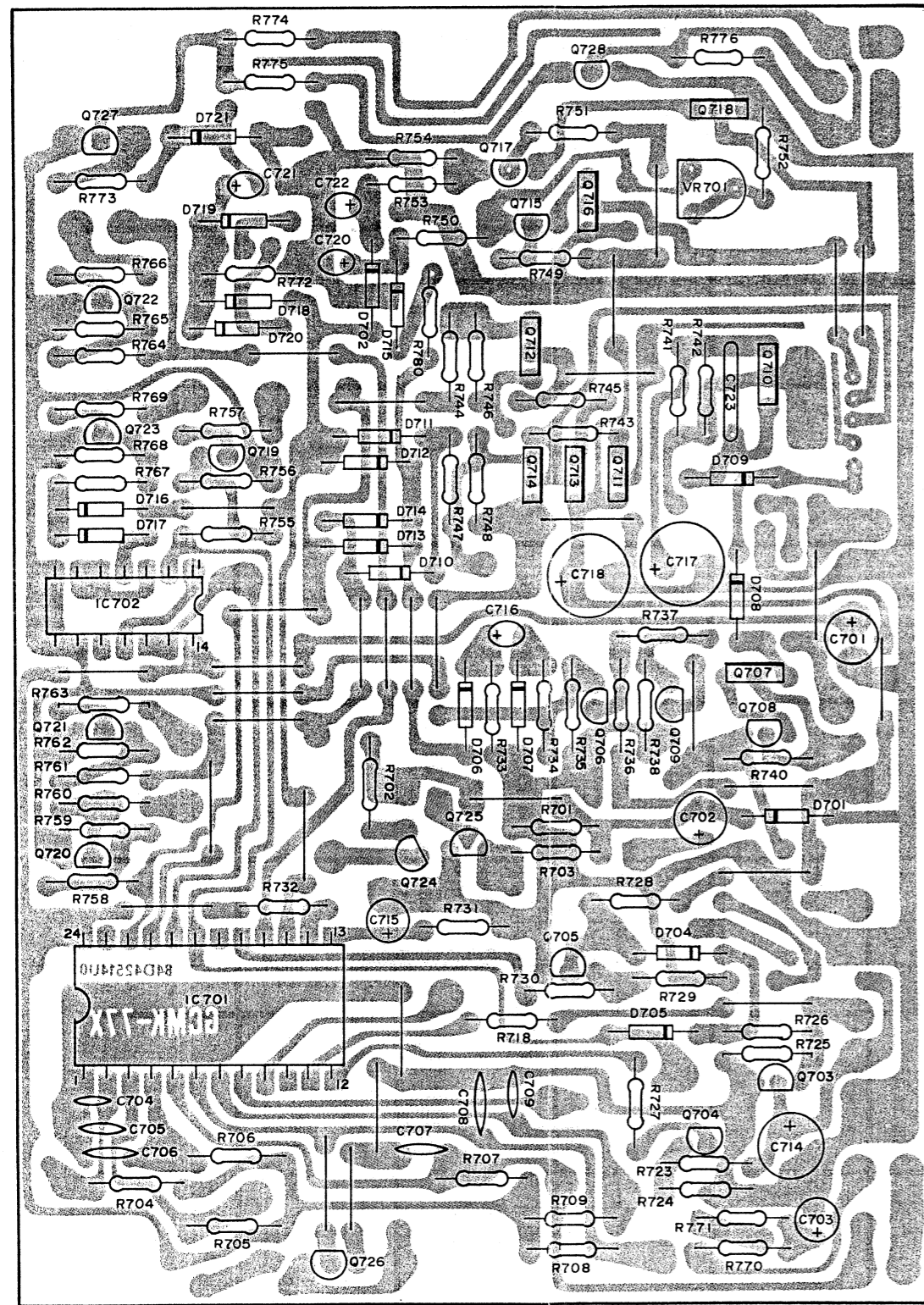

Top View

Memory Indicator P.C. Board

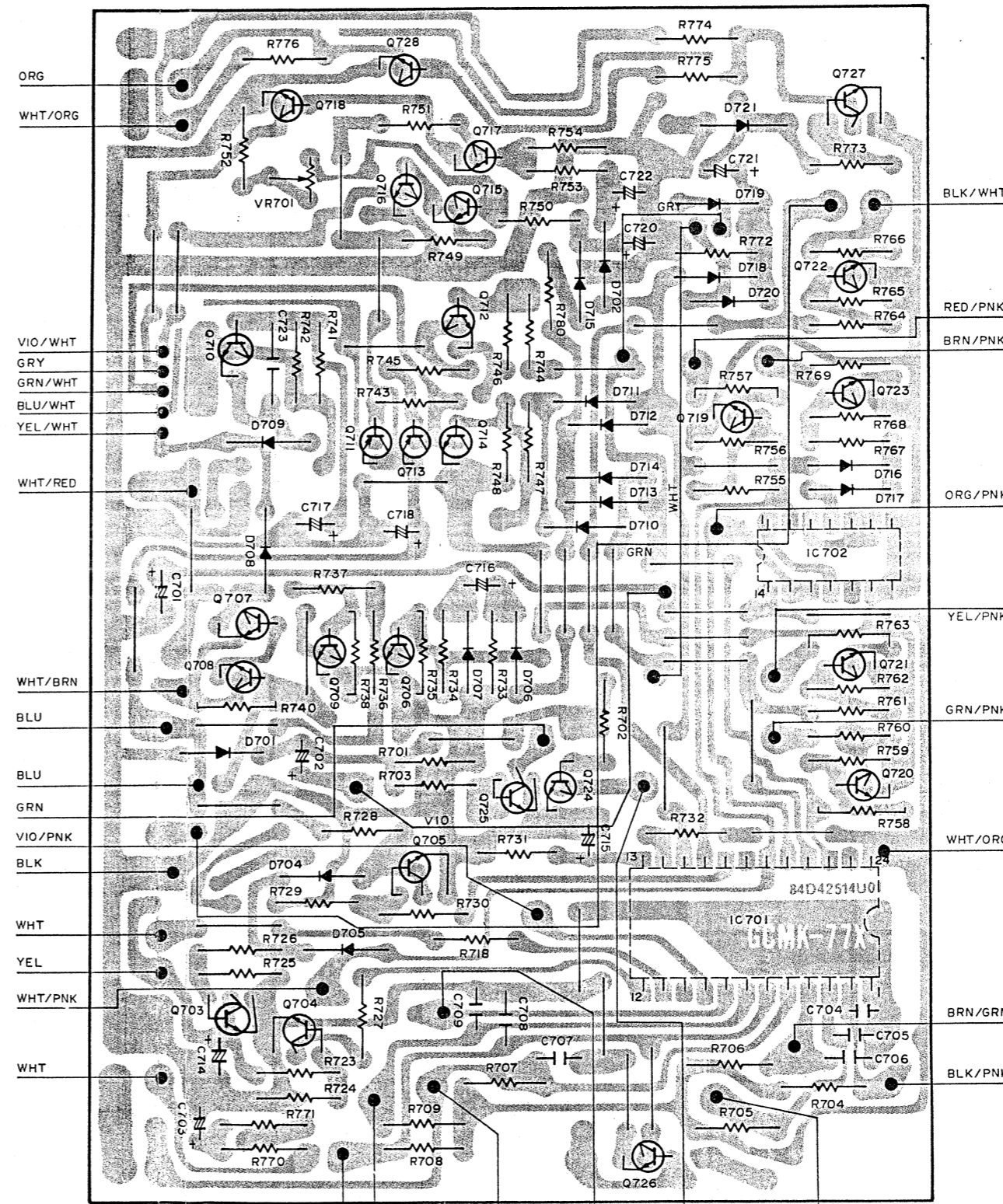

Bottom View

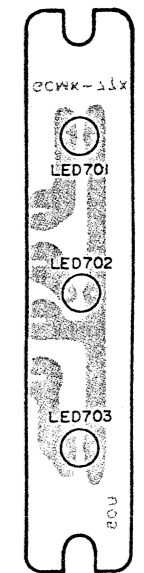

Top View

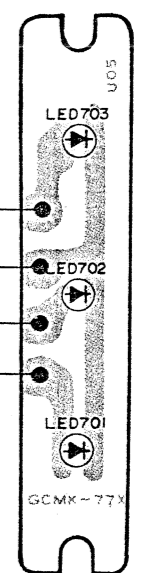

Bottom View

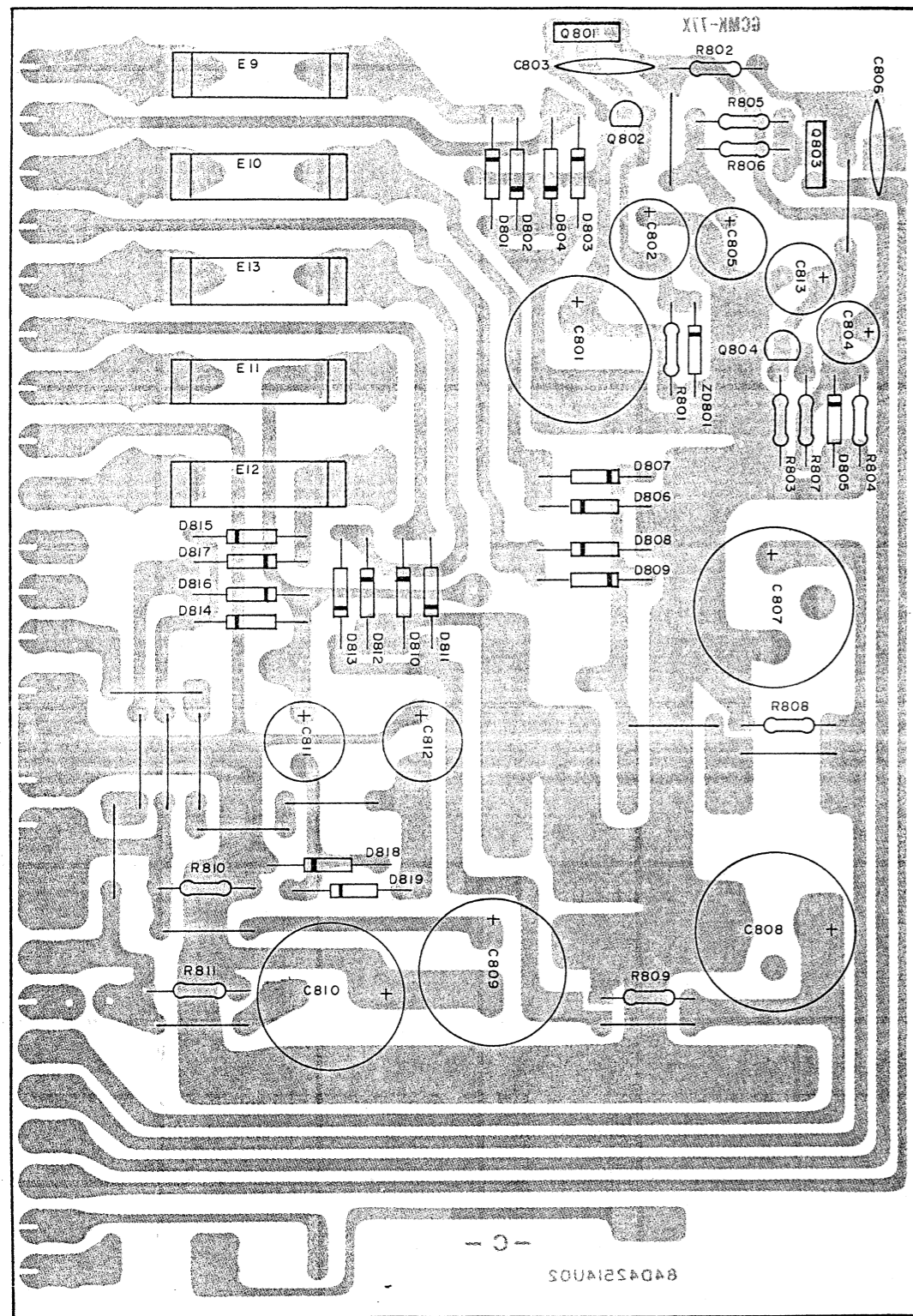

Top View

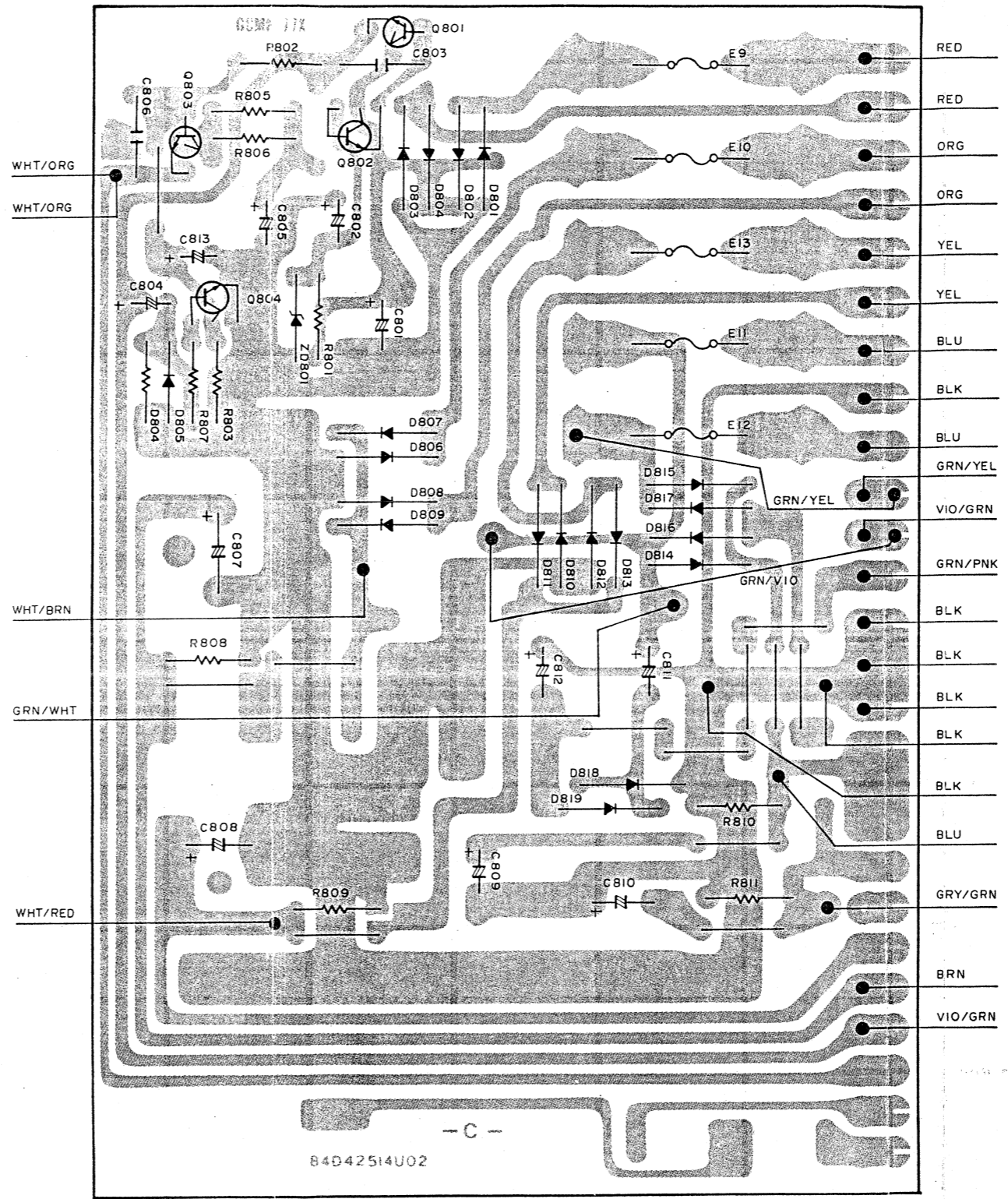

Bottom View

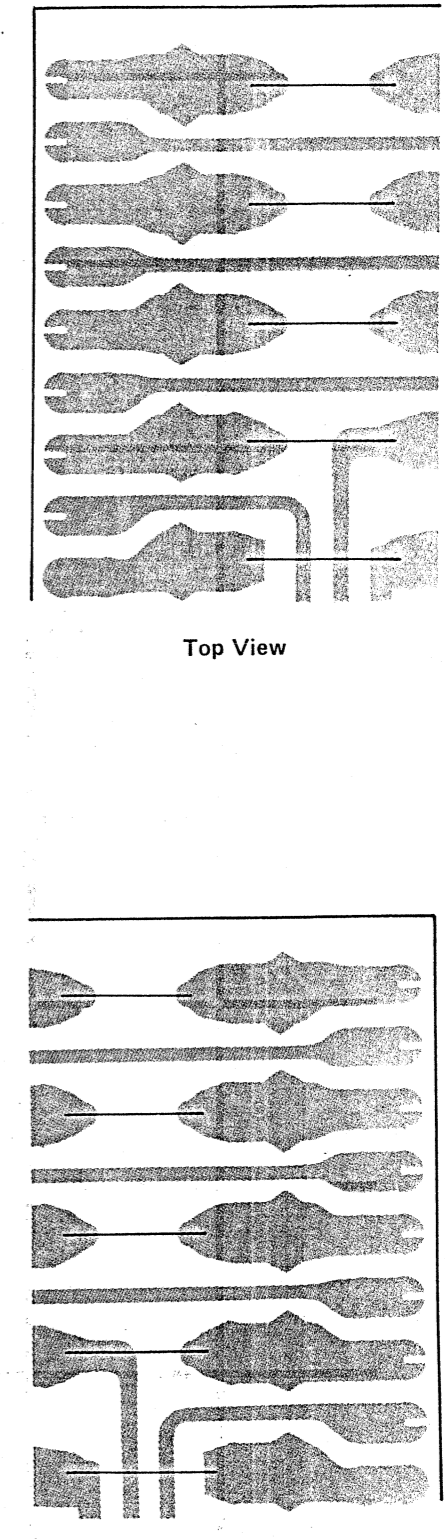

Top View

Bottom View

R/P Master P.C. Board

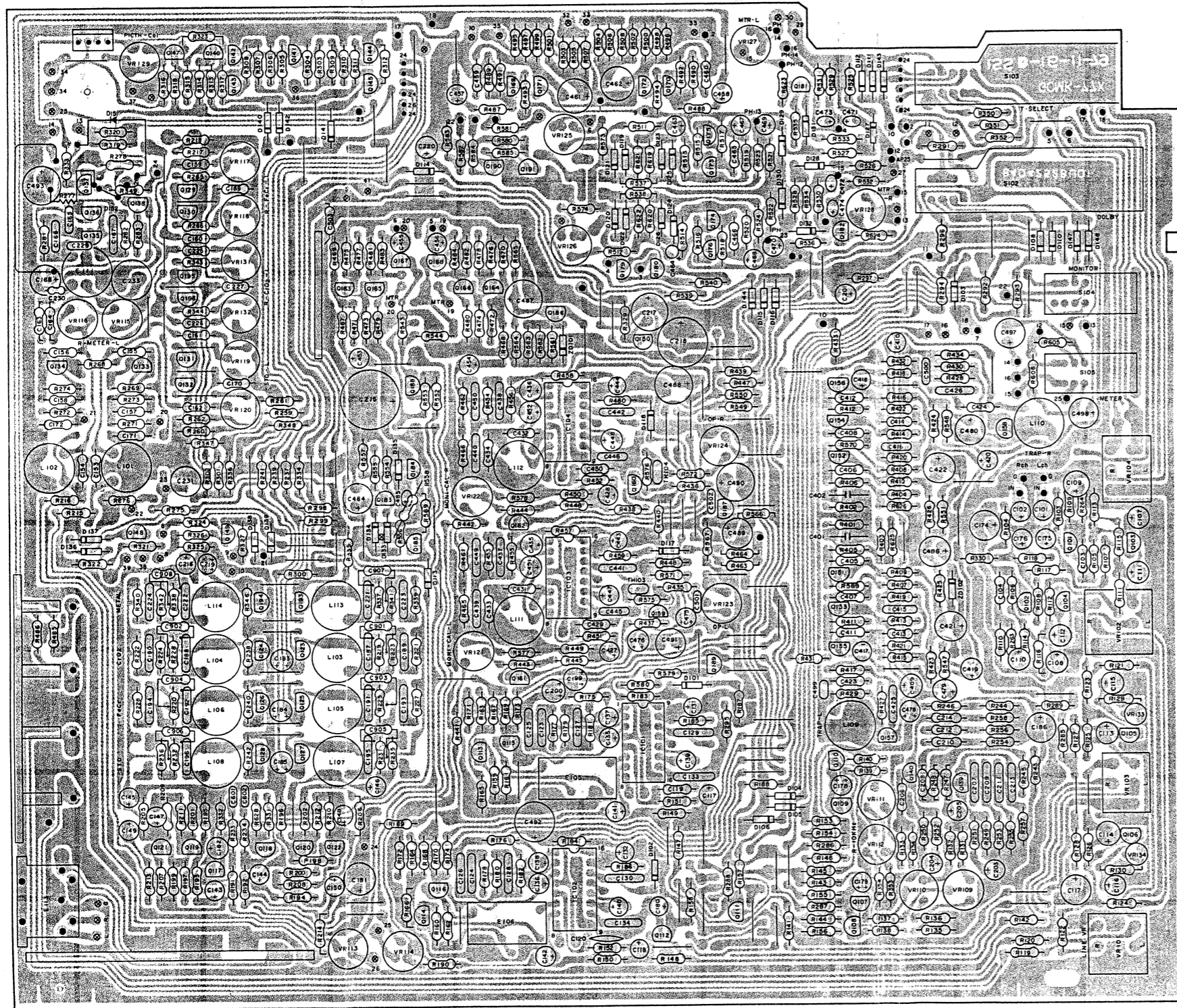

Top View

Jacks P.C. Board

(For multi-voltage model)

(For single voltage model)

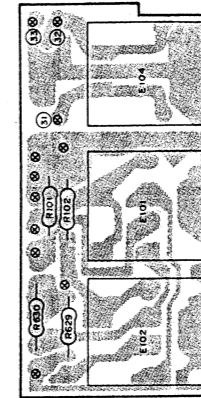

Top View

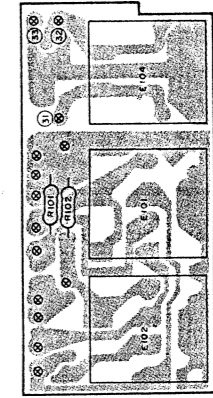

Top View

Tone Switch P.C. Board

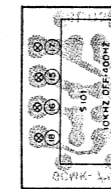

Top View

Dolby Cal P.C. Board

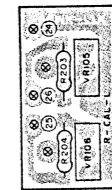

Top View

LED P.C. Board

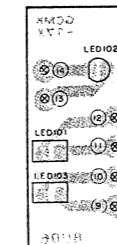

Top View

Bias Fine P.C. Board

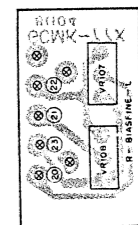

Top View

Jacks P.C. Board

(For single voltage model)

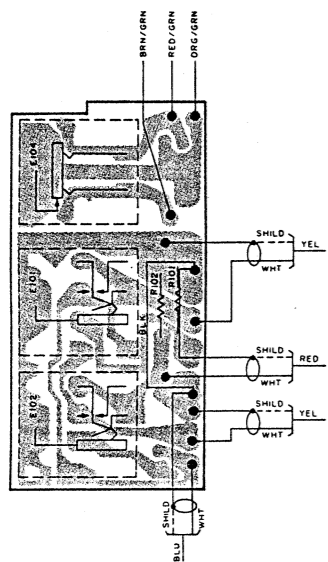

Bottom View

(For multi-voltage model)

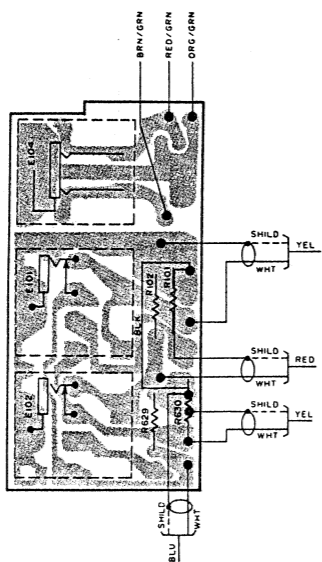

Bottom View

R/P Master P.C. Board

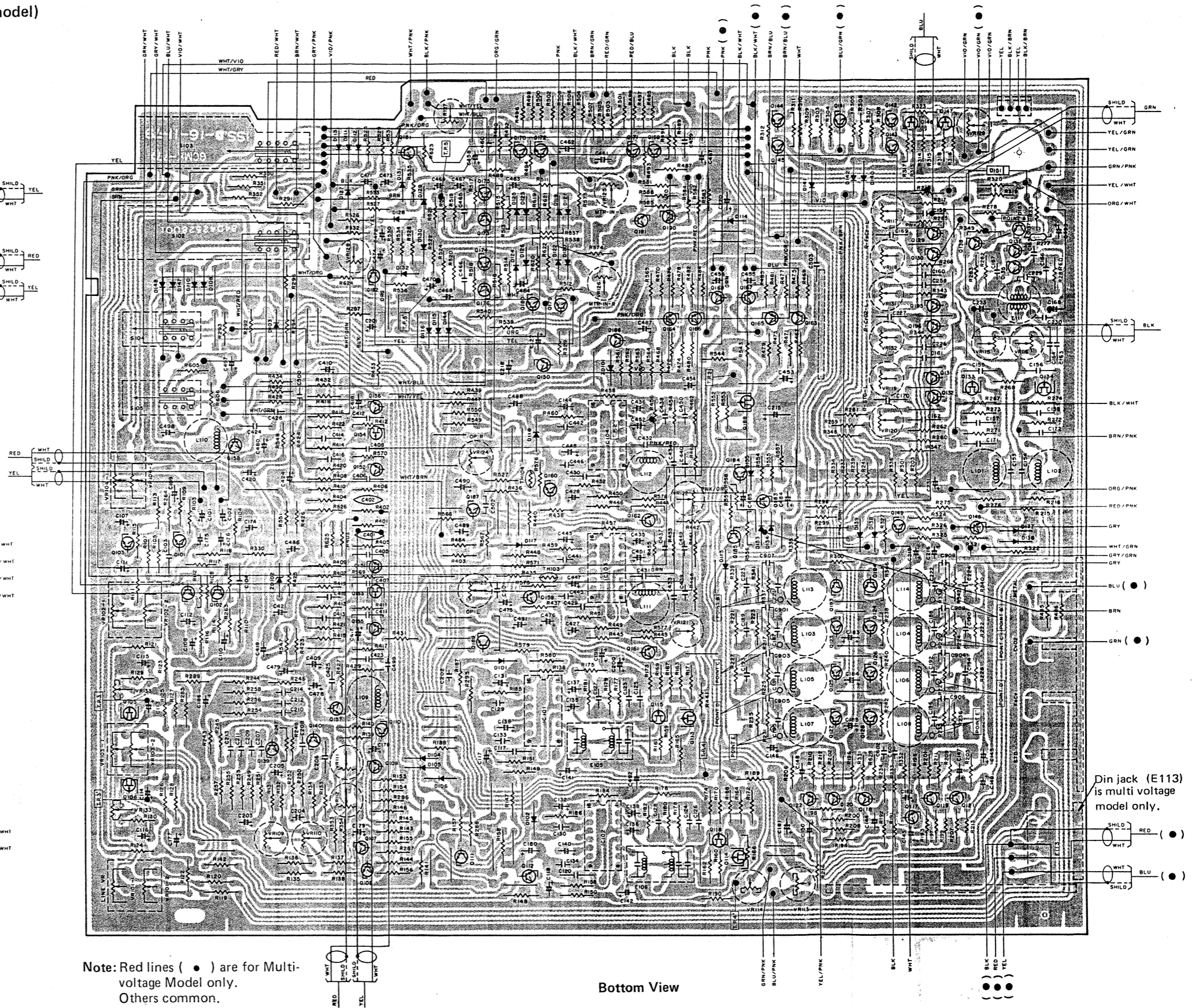

Bottom View

Dolby Cal. P.C. Board

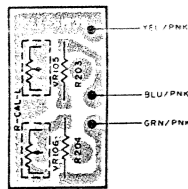

Bottom View

Tone Switch P.C. Board

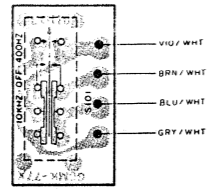

Bottom View

Bias Fine P.C. Board

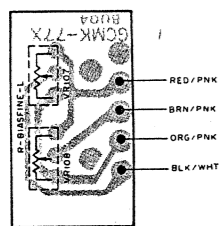

Bottom View

LED P.C. Board

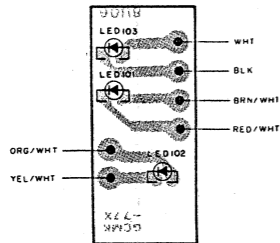

Bottom View

Terminal P.C. Board (1/2)

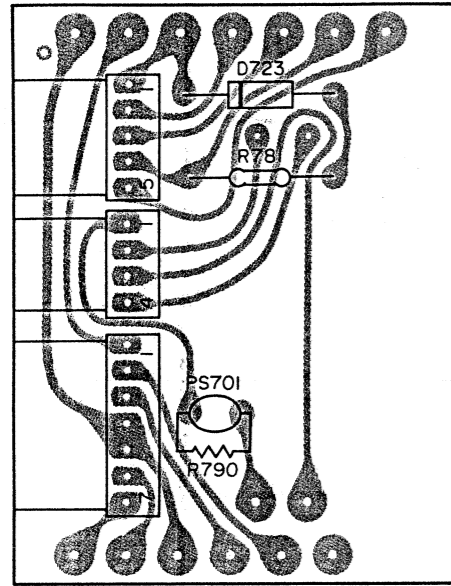

Top View

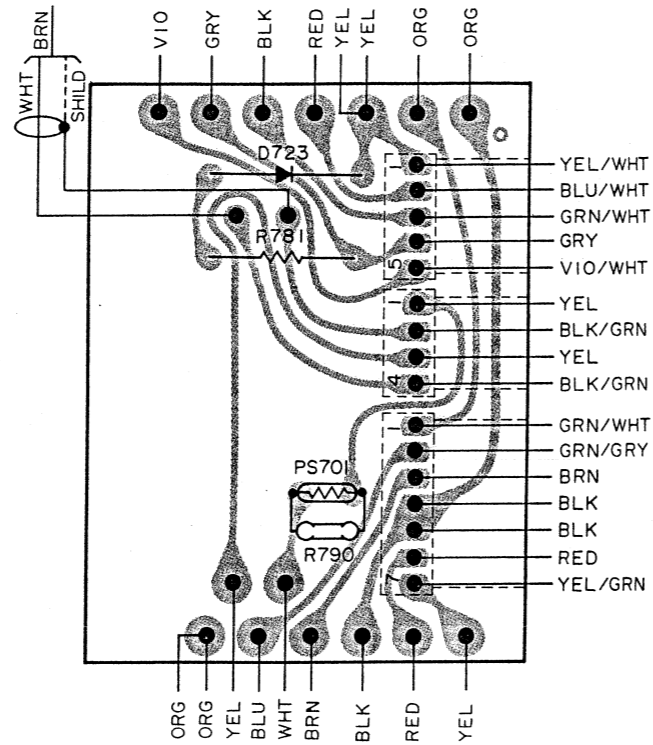

Bottom View

Terminal P.C. Board (2/2)

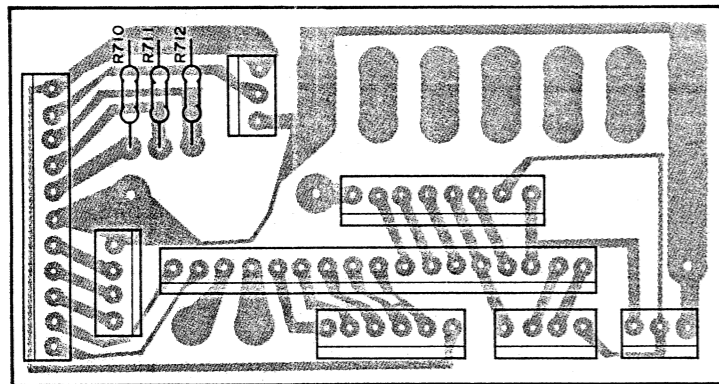

Top View

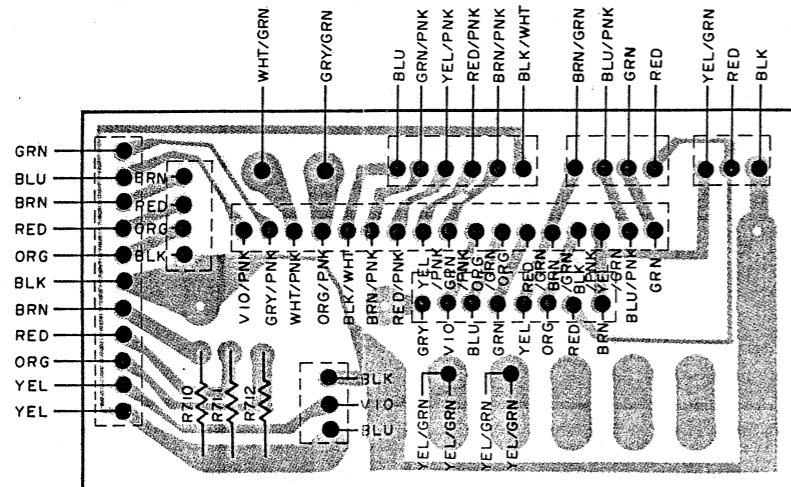

Bottom View

Head Combi P.C. Board

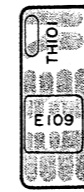

Top View

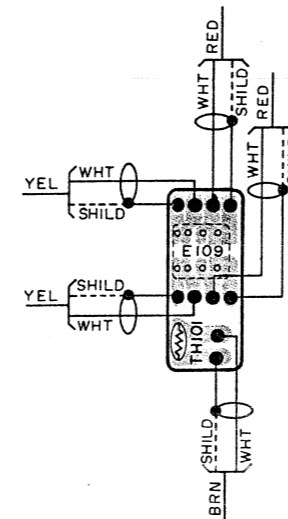

Bottom View

Rec Mute P.C. Board

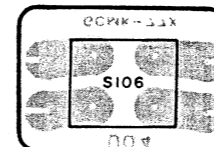

Top View

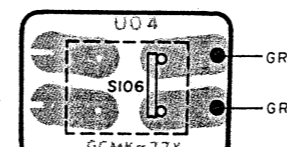

Bottom View

Din Switch P.C. Board (For multi-voltage model only)

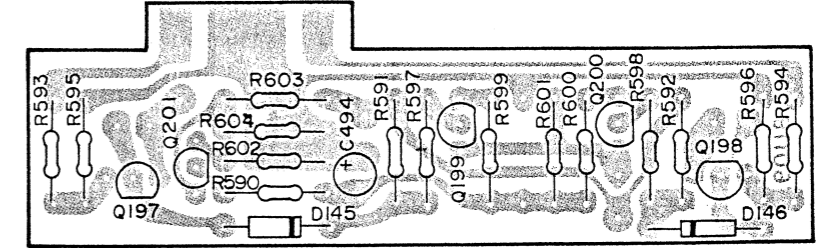

Top View

Q197		Q201	
S	0.00V 0.00V	E	0.00V 2.13V
D	0.00V 0.00V	C	-23.57V 2.12V
G	0.00V -19.5V	B	0.00V 1.47V

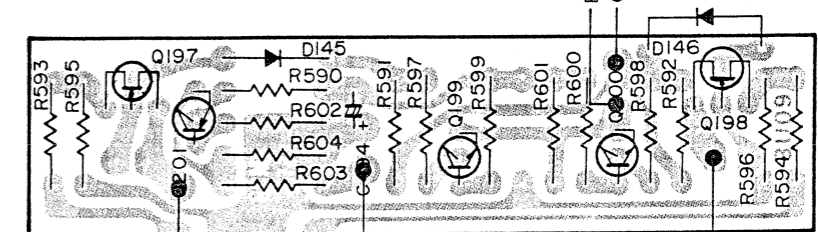

Bottom View

Q199		Q200	
E	-24.25V -24.08V	E	-24.25V -24.02V
C	20.03V -24.06V	C	-24.12V 20.04V
B	-24.26V -23.51V	B	-24.13V -23.45V

Level Gain Adjustment P.C. Board

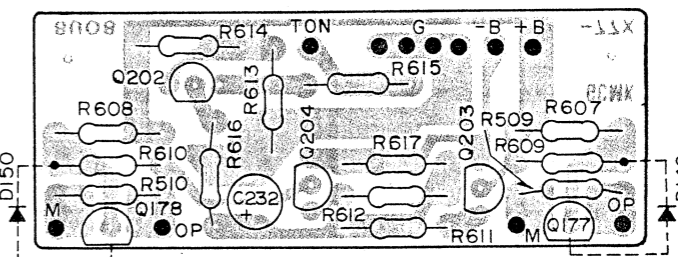

Top View

Q177		Q178	
S	0.00V 0.02V	S	0.00V 0.00V
D	0.00V 0.00V	D	0.00V 0.01V
G	-19.73V -19.64V	G	-20.14V -19.8V

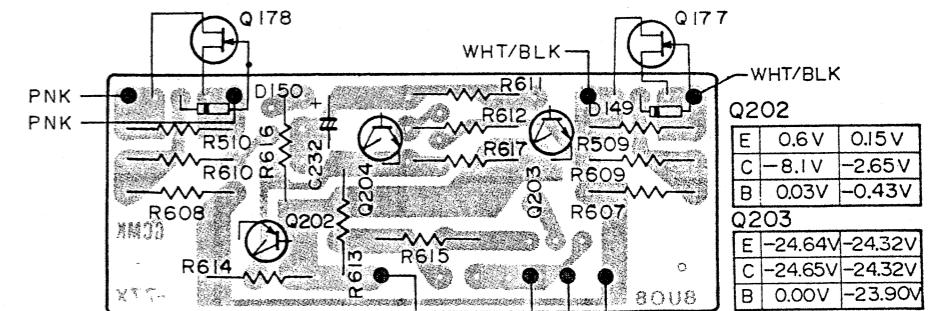

Bottom View

Q202		Q203		Q204	
E	0.6V 0.15V	E	-24.64V -24.32V	E	-24.62V -24.24V
C	-8.1V -2.65V	C	-24.65V -24.32V	C	-24.65V -24.27V
B	0.03V -0.43V	B	0.00V -23.90V	B	-24.05V -23.78V

Wiring Diagram (1/2)

(For Single Voltage Model)

(For multi-voltage model)

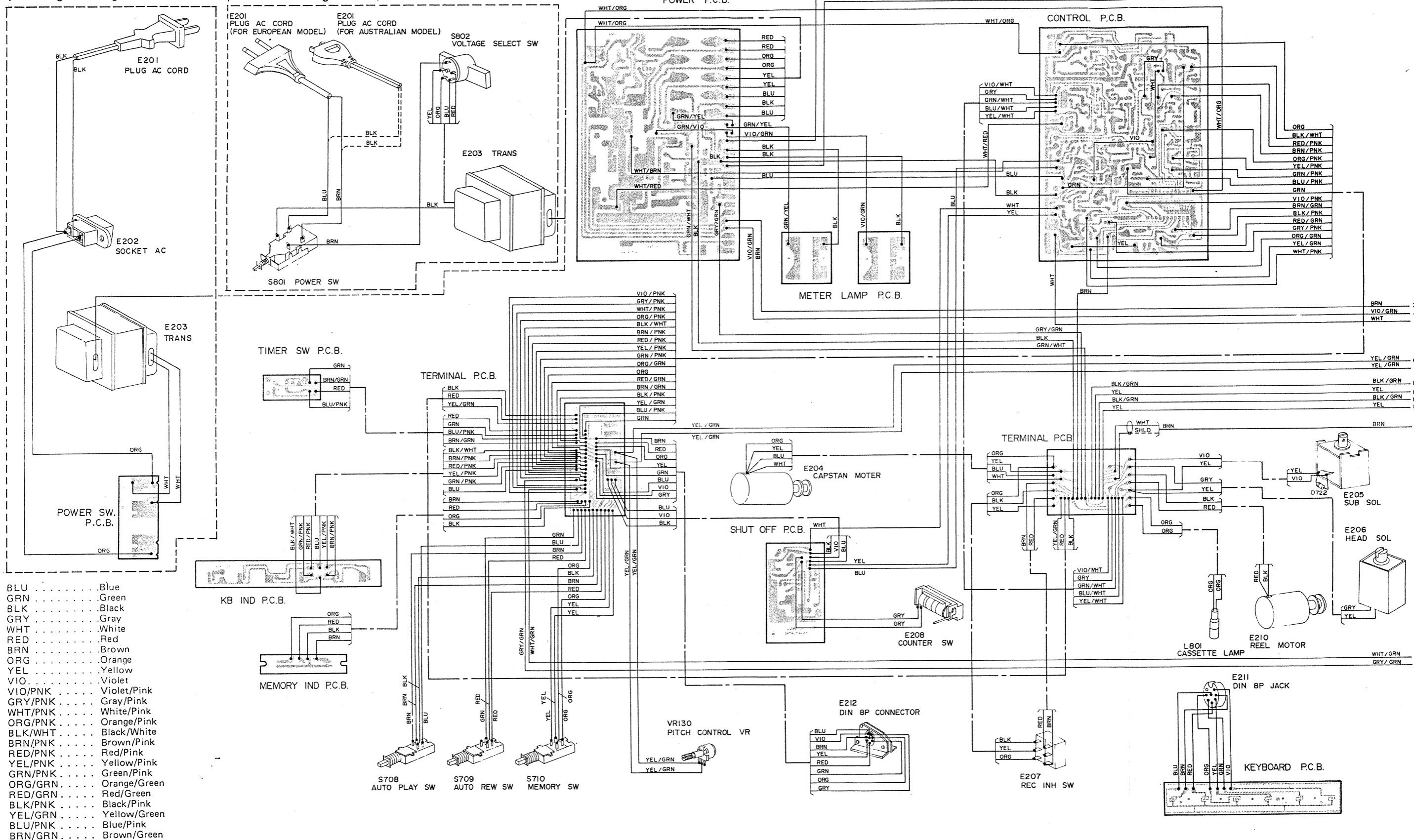

Wiring Diagram (2/2) (For single-voltage model)

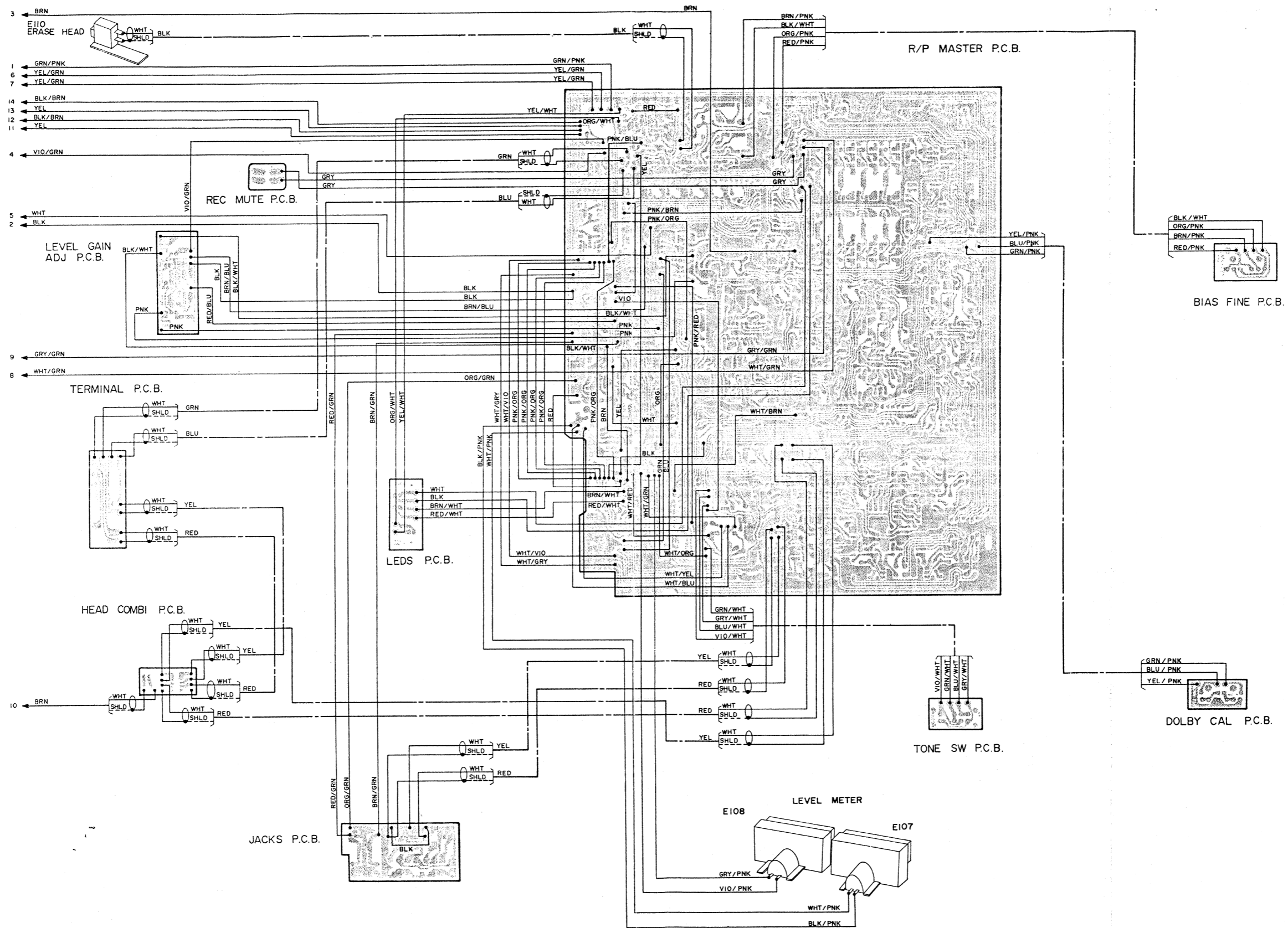

Schematic Diagram (1/2)

NOTES:

1. All resistance values are in ohms. K = 1,000
2. All capacitance values are in microfarads. P = $\frac{1}{1,000,000}$

For multi voltage model

(For single voltage model)

Semi-Conductors

IC101 to 104	NE645N
ZD101	RD5.1EB
ZD102	12A-2L
D101 to 106, D142 to D146, 108, D110 to 132, D135 to 140	MA150
D141, 147, 148	1N4003
D133, 134, 149, 150, 151	1S1955
Q101, 102, 151, 152	2SC2263
Q103, 104, 155, 156	2SC1327 or 2SC2263
Q105, 106, 153, 154	2SK128
Q113, 116, 133, 134, Q146, 147, 188, 177, 178	2SK127
Q121, 122, 165, 166, 183	2SA564 or 2SB641 or 2SB642
Q167, 168	2SD889
Q202	2SA733
Q145, 150	2SA777
Q143, 185	2SA921
Q135, 136, 138, 171, Q172, 186	2SC1788 or 2SD638
Q129 to 132, 195, 196, Q138, 140	2SC1890
Q203, 204	2SC1684
All other Transistors	2SC1684 or 2SD638

(For multi-voltage model only)

Semi-Conductors

IC101 to 104	NE645N
ZD101	RD5.1EB
ZD102	12A-2L
D101 to 106, D142 to D146, 108, D110 to 132, D135 to 140	MA150
D141, 147, 148	1N4003
D133, 134, 149, 150, 151	1S1955
Q101, 102, 151, 152	2SC2263
Q103, 104, 155, 156	2SC1327 or 2SC2263
Q105, 106, 153, 154	2SK128
Q113, 116, 133, 134, Q146, 147, 188, 177, 178	2SK127
Q121, 122, 165, 166, Q183, 201	2SA564 or 2SB641 or 2SB642
Q167, 168	2SD889
Q202	2SA733
Q145, 150	2SA777
Q143, 185	2SA921
Q135, 136, 138, 171, Q172, 186	2SC1788 or 2SD638
Q129 to 132, 195, 196, Q138, 140	2SC1890
Q203, 204	2SC1684
All other Transistors	2SC1684 or 2SD638

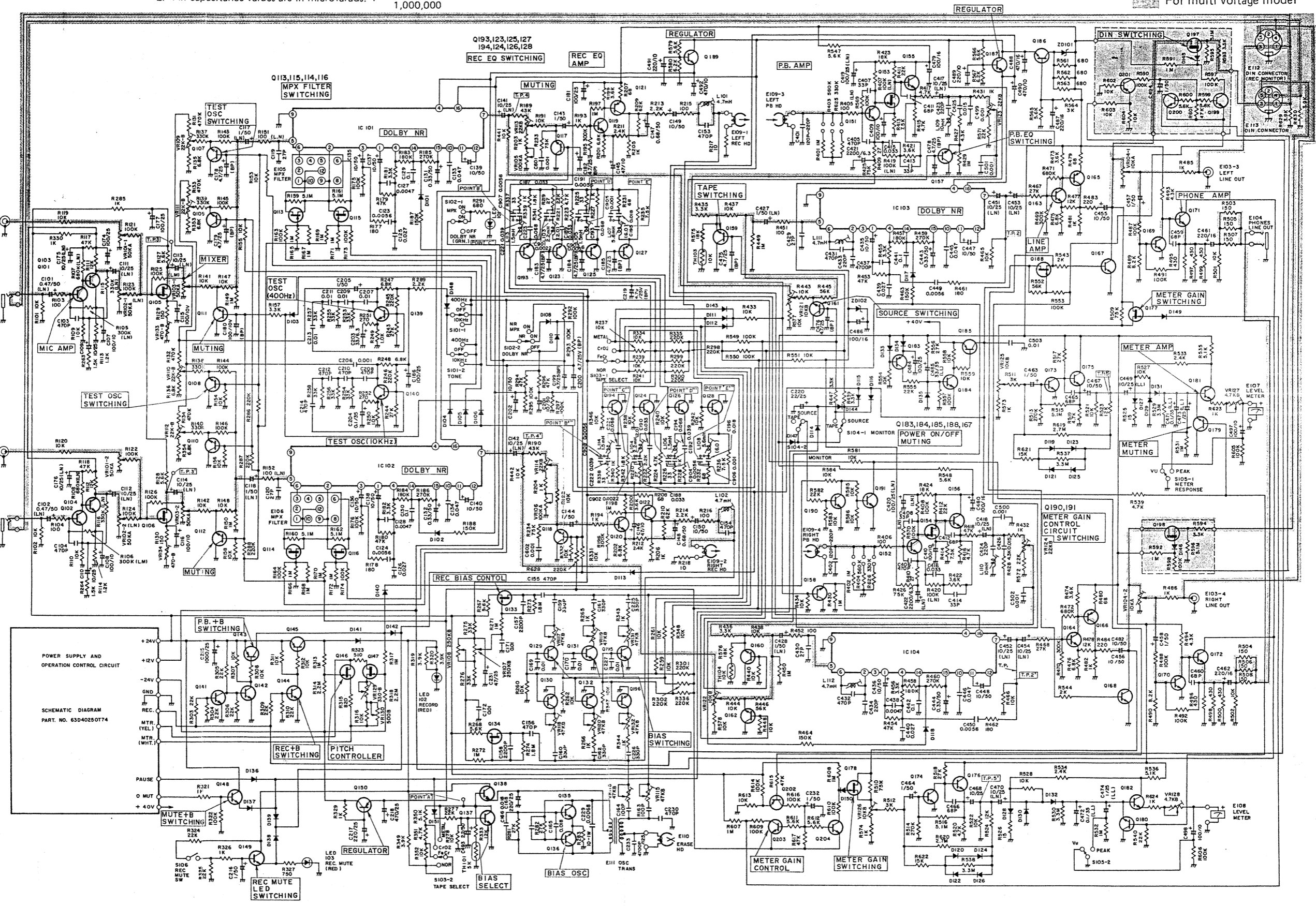

Schematic Diagram (1/2) Voltage Chart

Transistors

		Emitter	Collector	Base
Q101	P	0.07	1.54	0.58
	R	0.07	1.53	0.58
Q102	P	0.07	1.54	0.58
	R	0.07	1.53	0.58
Q103	P	0.93	8.14	1.54
	R	0.93	8.40	1.53
Q104	P	0.93	8.14	1.54
	R	0.93	8.40	1.53
Q107	P	0.00	0.00	0.69
	R	0.00	0.00	0.69
Q108	P	0.00	0.00	0.69
	R	0.00	0.00	0.69
Q109	P	0.00	0.00	0.70
	R	0.00	0.00	0.70
Q110	P	0.00	0.00	0.70
	R	0.00	0.00	0.70
Q111	P	0.00	0.00	0.82
	R	—	—	-0.98
Q112	P	0.00	0.00	0.82
	R	—	—	-0.98
Q117	P	0.00	0.00	0.69
	R	0.00	0.00	-0.98
Q119	P	4.02	20.73	4.51
	R	4.03	20.76	4.52
Q121	P	21.39	12.68	20.72
	R	21.43	12.70	20.76
Q123	P	0.00	-1.08	-1.07
	R	0.00	-1.07	-1.06
Q124	P	0.00	-1.08	-1.07
	R	0.00	-1.07	-1.06
Q125	P	0.00	0.00	-1.08
	R	0.00	0.00	-1.07
Q126	P	0.00	0.00	-1.08
	R	0.00	0.00	-1.07
Q127	P	0.00	0.00	+0.70
	R	0.00	0.00	0.70
Q128	P	0.00	0.00	+0.70
	R	0.00	0.00	0.70
Q129	P	-0.00	+0.01	0.72
	R	+0.00	+0.01	0.72
Q130	P	-0.00	+0.01	0.72
	R	+0.00	+0.01	0.72
Q131	P	-0.00	0.00	-1.06
	R	+0.00	8.04	-1.07
Q132	P	-0.00	0.00	-1.06
	R	+0.00	8.04	-1.07
Q135	P	-0.00	0.00	0.00
	R	0.41	8.86	-0.77
Q136	P	-0.00	0.00	0.00
	R	0.42	8.86	-0.87
Q137	P	-0.00	-0.00	-0.26
	R	+0.00	+9.42	-0.26
Q138	P	-0.00	-0.00	+0.00
	R	8.84	+21.54	9.39
Q139	P	—	—	—
	R	1.13	8.63	1.76
Q140	P	—	—	—
	R	1.13	8.63	1.76

P: Play Mode R: Record Mode

Transistors

		Emitter	Collector	Base
Q190	P	0.00	11.07	0.00
	R	-0.00	-0.00	-0.00
Q191	P	0.00	0.00	0.68
	R	-0.08	-0.47	-0.01

P: Play Mode R: Record Mode

FET's







		Source	Drain	Gate
Q105	P	0.35	5.85	0.00
	R	0.35	6.02	0.00
Q106	P	0.35	5.85	0.00
	R	0.35	6.02	0.00
Q113	P	6.44	6.44	6.93
	R	6.48	6.48	6.77
Q114	P	6.44	6.44	6.93
	R	6.48	6.48	6.97
Q115	P	6.45	6.45	11.92
	R	4.26	6.48	-11.64
Q116	P	6.45	6.45	11.92
	R	4.26	6.48	-11.64
Q133	P	—	—	—
	R	14.05	21.84	12.46
Q134	P	—	—	—
	R	14.05	21.84	12.46
Q146	P	-12.75	-12.75	-20.71
	R	-12.92	-12.90	-12.44
Q147	P	-12.83	-12.83	-12.25
	R	-12.71	-12.71	-20.37
Q153	P	1.97	6.40	1.25
	R	1.98	6.39	1.26
Q188	P	+0.00	-3.57	-11.04
	R	-0.08	-3.57	-11.08



















IC's

		IC101	IC102	IC103	IC104
1	P	11.99	6.34	11.96	6.35
	R	12.04	6.36	12.03	6.40
2	P	9.73	6.46	9.75	6.47
	R	9.76	6.48	9.82	6.52
3	P	9.98	6.91	10.01	6.95
	R	10.02	6.93	10.08	7.00
4	P	0.00	6.29	0.00	6.37
	R	0.00	6.30	0.00	6.36
5	P	6.34	6.27	6.34	6.28
	R	6.36	6.28	6.39	6.33
6	P	6.27	6.48	6.39	6.47
	R	6.29	6.48	6.43	6.52
7	P	6.34	5.85	6.35	5.67
	R	6.37	5.86	6.40	5.72
8	P	—	—	—	—
	R	—	—	—	—
9	P	0.00	—	0.00	—
	R	0.00	—	0.00	0.00
10	P	5.85	6.34	5.67	6.35
	R	5.86	6.37	5.72	6.40
11	P	6.48	6.27	6.47	6.39
	R	6.48	6.29	6.52	6.43
12	P	6.27	6.34	6.28	6.34
	R	6.28	6.36	6.33	6.39
13	P	—	—	—	—
	R	—	—	—	—
14	P	6.91	9.98	6.95	10.01
	R	6.93	10.02	7.00	10.08
15	P	6.46	9.73	6.47	9.75
	R	6.48	9.76	6.52	9.82
16	P	6.34	11.99	6.35	11.96
	R	6.36	12.04	6.40	12.03

Schematic Diagram (2/2) Voltage Chart

1. Control P.C.Board
● IC701 (TC9121)

PIN No. STATE	VSS	REW	FF	PLAY	REC	STOP	PAUSE	A. REW	A. PLAY	X	Y	Z	OSC	INH	O. PLAY	O. REC		
	1	2	3	4	5	6	7	8	9	10	11	12	13	14	15	16		
STOP	GND 0.00	H 8.98	H 8.98	H 8.98	H 8.98	L 0.01	H 8.98	H 8.95	H 8.95	H 8.95	H 8.95	H 8.96	(B)	H 8.95	L 0.00	L 0.02		
REW	GND 0.00	L 0.02	H 8.98	H 8.98	H 8.98	H 8.98	H 8.98	H 8.95	H 8.95	H 8.95		(A)	(B)	H 8.95	L 0.00	L 0.02		
PLAY	GND 0.00	H 8.98	H 8.98	L 0.03	H 8.98	H 8.98	H 8.98	H 8.95	H 8.95	H 8.95		(A)	(B)	H 8.95	 H(8.14)	L 0.02		
PLAY PAUSE	GND 0.00	H 8.98	H 8.98	H 8.98	H 8.98	H 9.98	H 8.98	H 8.95	H 8.95	H 8.95		H 8.96	(B)	H 8.95	 L	L 0.02		
REC PLAY	GND 0.00	H 8.98	H 8.98	H 8.98	L 0.01	H 8.98	H 8.98	H 8.95	H 8.95	H 8.95		(A)	(B)	H 8.05	 H	 H(8.14)		
REC PLAY/PAUSE	GND 0.00	H 8.98	H 8.98	H 8.98	H 8.98	H 8.98	L 0.02	H 8.95	H 8.95	H 8.95		H 8.96	(B)	H 8.95	 L	 H(8.14)		
F.F.	GND 0.00	H 8.98	L 0.02	H 8.98	H 8.98	H 8.98	H 8.98	H 8.95	H 8.95	H 8.95		(A)	(B)	H 8.95		L 0.02		
PAUSE	GND 0.00	H 8.98	H 8.98	H 8.98	H 8.98	H 8.98	L 0.01	H 8.95	H 8.95	H 8.95		H 8.96	(B)	H 8.95		L 0.02		
								A. REW SW.ON L	A. PLAY SW.ON L									Occurs at Tape End

O. STOP	O. FF,REW	O. PAUSE	O. MUTE	O. REW	O. FF	O. TE	VDD
17	18	19	20	21	22	23	24
L 0.00	L 0.00	L 0.00	H 9.00	L 0.00	L 0.00	H 8.54	
 H(8.24)	 H(8.38)	L 0.00	H 9.00	 H(8.14)	L 0.00	H 8.37	9.01
 H(8.24)	L 0.00	L 0.00	 L(0.00)	L 0.00	L 0.00	H 8.35	9.01
 H(8.24)	L 0.00	 H(8.33)	 L	L 0.00	L 0.00	H 8.48	9.01
 H(8.24)	L 0.00	L 0.00	 L	L 0.00	L 0.00	H 8.31	9.01
 H(8.24)	L 0.00	 H(8.23)	 L	L 0.00	L 0.00	H 8.43	9.01
 H(8.24)	 H(8.38)	L 0.00	H 9.00	L 0.00	 H(8.10)	H 8.35	9.01
 H(8.24)	L 0.00	 H(8.23)	H 9.00	L 0.00	L 0.00	H 8.50	9.01

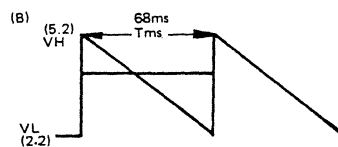
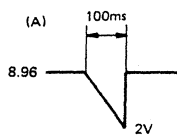

● IC702 (MC14011)

STATE	PIN No.									
	1	2	3	4	5	6	7	11	12	
STOP	L 0.00	L 0.00	H 8.97	L 0.00	H 8.97	H 8.97	GND 0.00	L 0.00	H 8.93	
REW	L 0.01	L 0.01	H 8.82	L 0.01	H 8.82	H 8.82	0.01	L 0.01	H 8.75	
PLAY	H(8.80)	L 0.36	H 8.80	L 0.01	H 8.80	H 8.80	0.01	H(8.80)	L(0.00)	
PLAY PAUSE	H(8.93)	H(8.23)	L(0.00)	H(8.85)	L(0.00)	L(0.00)	0.00	H(8.93)	L(0.00)	
REC PLAY	H(8.75)	L -0.36	H 8.76	L 0.01	H 8.76	H 8.76	0.01	H(8.75)	L(0.00)	
REC PLAY/PAUSE	H(8.88)	H(8.18)	L(0.00)	H(8.79)	L(0.00)	L(0.00)	0.00	H(8.88)	L(0.00)	
F.F.	L 0.01	L 0.01	H 8.81	L 0.01	H 8.81	H 8.81	0.01	L 0.01	H 8.74	
PAUSE	L 0.00	L 0.00	H 8.96	L 0.00	H 8.96	H 8.96	0.00	L 0.00	H 8.96	

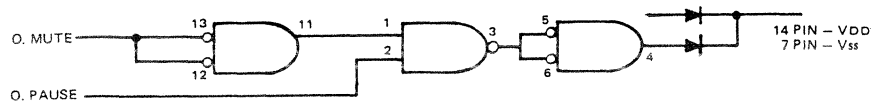

● When PAUSE ON at PLAY/REC PLAY

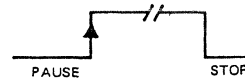

● Head & Sub Solenoids

No.	Q706			Q707			Q708			Q709			Q710		
	E	C	B	E	C	B	E	C	B	E	C	B	E	C	B
STOP	GND 0.00	H 7.26	L 0.06	(40V) 1.70	L 35.28	L 0.02	(40V) 0.00	L 0.02	L 0.02	GND 0.00	L 0.02	0.73	H 14.02	(11V) 14.45	H 14.40
REW	GND 0.00	(B)	(A)	(F)	(J)	(E)	(E)	(J)	(D)	GND 0.00	(D)	(C)	11.98	-12.75	12.70
PLAY	GND 0.00	(B)	(A)	(F)	(J)	(E)	(E)	(J)	(D)	GND 0.00	(D)	(C)	10.50	-11.60	-
PLAY PAUSE	GND 0.00	H 7.26	L 0.06	(40V) 1.70	L 0.02	L 0.00	(40V) 0.00	L 0.02	L 0.02	GND 0.00	L 0.02	0.73	-H	-H	-H
REC PLAY	GND 0.00	(B)	(A)	(F)	(J)	(E)	(E)	(J)	(D)	GND 0.00	(D)	(C)	-0.50	-11.67	-
REC PLAY/PAUSE	GND 0.00	H 7.26	L 0.06	(40V) 1.70	L 0.02	L 0.00	(40V) 0.00	L 0.02	L 0.02	GND 0.00	L 0.02	0.73	-H	-H	-H
F.F.	GND 0.00	(B)	(A)	(F)	(J)	(E)	(E)	(J)	(D)	GND 0.00	(D)	(C)	-12.00	-12.75	-
PAUSE	GND 0.00	H 7.26	L 0.06	(40V) 1.70	L 0.02	L 0.00	(40V) 0.00	L 0.02	L 0.02	GND 0.00	L 0.02	0.73	H 14.02	H 14.45	H

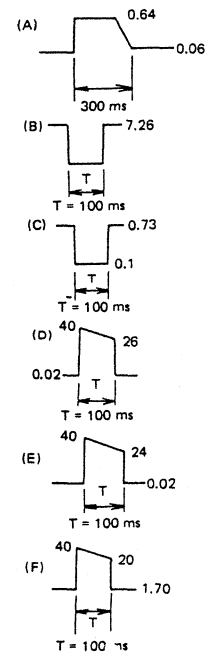

● Sub Solenoid Driver

No. STATE	Q715			Q716			Q717			Q718		
	E	C	B	E	C	B	E	C	B	E	C	B
STOP	L 0.00	H 13.95	L 0.00	GND 0.00	H 14.76	L 0.00	L 0.00	H 13.82	L 0.00	GND 0.00	H 14.42	L 0.00
REW	(J)	(F)	(E)	GND 0.00	(K)	(J)	L 0.00	H 13.82	L 0.00	GND 0.00	H 14.42	L 0.00
PLAY	(J)	(F)	(E)	GND 0.00	(K)	(J)	(N)	(M)	(L)	GND 0.00	(P)	(N)
PLAY PAUSE	0.86-L	0.95-H	1.52-L	GND 0.00	0.95-H	0.86-L	0.86-O	0.93-H	1.57-O	GND 0.00	0.22-H	0.86-O
REC PLAY	(J)	(F)	(E)	GND 0.00	(K)	(J)	(N)	(M)	(L)	GND 0.00	(P)	(N)
REC PLAY/PAUSE	0.86-L	0.75-H	1.52-L	GND 0.00	0.95-H	0.86-L	0.86-O	0.93-H	1.57-O	GND 0.00	0.22-H	0.86-O
F.F.	(J)	(F)	(E)	GND 0.00	(K)	(J)	(L)	H 13.82	L 0.00	GND 0.00	H 14.42	L 0.00
PAUSE	L 0.00	H 13.95	L 0.00	GND 0.00	H 14.76	L 0.00	L 0.00	H 13.82	L 0.00	GND 0.00	H 14.42	L 0.00

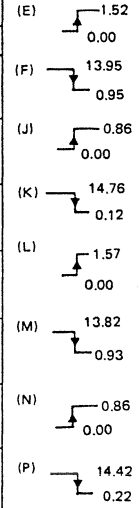

No. STATE	Q711			Q712			Q713			Q714		
	E	C	B	E	C	B	E	C	B	E	C	B
STOP	13.36	12.91	12.94	GND 0.00	13.10	L 0.00	13.60	13.10	13.10	GND 0.00	H 12.87	L 0.00
REW	12.62	12.65	11.88	GND 0.01	12.05	L 0.02	12.75	0.1	12.70	GND 0.00	0.12	0.82
PLAY	12.52	12.52	11.80	GND 0.01	12.50	L 0.02	12.70	0.08	12.68	GND 0.00	0.08	0.81
PLAY PAUSE	13.36	12.91	12.94	GND 0.01	13.04	L 0.01	13.55	-H	13.08	GND 0.00	-H	-L
REC PLAY	12.52	12.52	11.80	GND 0.01	12.58	L 0.01	12.70	0.08	12.60	GND 0.00	-L	-0.80
REC PLAY/PAUSE	13.36	12.91	12.94	GND 0.01	13.04	L 0.01	13.55	-H	13.08	GND 0.00	-H	-L
F.F.	12.43	-0.08	12.40	GND 0.01	-0.10	-0.82	12.75	12.78	11.89	GND 0.00	H	L 0.00
PAUSE	13.36	12.91	12.94	GND 0.01	13.04	L 0.01	13.60	13.10	13.08	GND 0.00	H	L 0.00

• LED

STATE \ No.	PAUSE			F/F			REW			REC			PLAY			Q726		
	Q719			Q720			Q721			Q722			Q723			E	C	B
	E	C	B	E	C	B	E	C	B	E	C	B	E	C	B	E	C	B
STOP	GND 0.00	H 11.16	L 0.00	GND 0.00	H 11.16	L 0.00	GND 0.00	H 11.16	L 0.00	GND 0.00	H 11.16	L 0.00	GND 0.00	H 11.16	L 0.00	0.00	0.01 9.02	-3.89
REW	GND 0.00	H 11.16	L 0.00	GND 0.00	H 11.16	L 0.00	GND 0.00	H 0.01	L 0.67	GND 0.00	H 11.16	L 0.00	GND 0.00	H 11.16	L 0.00			
PLAY	GND 0.00	H 11.16	L 0.00	GND 0.00	H 11.16	L 0.00	GND 0.00	H 11.16	L 0.00	GND 0.00	H 11.16	L 0.00	GND 0.00	H L(0.02)	L 0.67			
PLAY PAUSE	GND 0.00	H L(0.09)	L 0.72	GND 0.00	H 11.16	L 0.00	GND 0.00	H 11.16	L 0.00	GND 0.00	H 11.16	L 0.00	GND 0.00	H L(0.02)	L 0.66			
REC PLAY	GND 0.00	H 11.16	L 0.00	GND 0.00	H 11.16	L 0.00	GND 0.00	H 11.16	L 0.00	GND 0.00	H L(0.02)	L 0.67	GND 0.00	H L(0.02)	L 0.66			
REC PLAY/PAUSE	GND 0.00	H L(0.09)	L 0.72	GND 0.00	H 11.16	L 0.00	GND 0.00	H 11.16	L 0.00	GND 0.00	H 0.67	L 0.00	GND 0.00	H L(0.02)	L 0.67			
F.F.	GND 0.00	H 11.16	L 0.00	GND 0.00	H 0.11	L 0.67	GND 0.00	H 11.16	L 0.00	GND 0.00	H 11.16	L 0.00	GND 0.00	H 11.16	L 0.00			
PAUSE	GND 0.00	H L(0.09)	L 0.72	GND 0.00	H 11.16	L 0.00	GND 0.00	H 11.16	L 0.00	GND 0.00	H 11.16	L 0.00	GND 0.00	H 11.16	L 0.00			

2. Switch Panel Timing

STATE \ No.	Q727			Q728		
	E	C	B	E	C	B
	STOP	GND 0.00	H 4.83	L 0.00	GND 0.00	L 0.01
REW	GND 0.00	(B)	(A)	GND 0.00	(D)	(C)
PLAY	GND 0.00	(B)	(A)	GND 0.00	(D)	(C)
PLAY PAUSE	GND 0.00	H 4.83	L 0.00	GND 0.00	L 0.01	0.66
REC PLAY	GND 0.00	(B)	(A)	GND 0.00	(D)	(C)
REC PLAY/PAUSE	GND 0.00	H 4.83	L 0.00	GND 0.00	L 0.01	0.66
F.F.	GND 0.00	(B)	(A)	GND 0.00	(D)	(C)
PAUSE	GND 0.00	H 4.83	L 0.00	GND 0.00	L 0.01	0.66

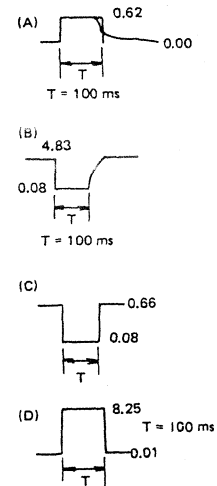

3. Power P.C.Board

STATE \ No.	Q801			Q802			Q803			Q804		
	E	C	B	E	C	B	E	C	B	E	C	B
STOP	22.00	38VO-P 36.54	22.54	22.54	38VO-P 36.54	23.18	9.02	(20.72) 21.26	9.61	GND 0.00	9.61	9.61
REW	21.98	37VO-P 35.6	22.54	22.54	37VO-P 35.6	23.17	8.84	14.47	9.48	0.01	9.48	9.47
PLAY	21.98	36VO-P 34.88	22.52	22.52	36VO-P 34.88	23.15	8.82	14.15	9.46	0.02	9.46	9.46
PLAY PAUSE	21.98	36VO-P 34.88	22.52	22.52	36VO-P 34.88	23.15	8.96	18.88	9.46	0.02	9.46	9.46
REC PLAY	21.98	36VO-P 34.88	22.52	22.52	36VO-P 34.88	23.15	8.79	12.30	9.46	0.02	9.46	9.42
REC PLAY/PAUSE	21.98	36VO-P 34.88	22.52	22.52	36VO-P 34.88		8.90	16.53	9.46	0.02	9.46	9.42
F.F.	21.98	37VO-P 35.45	22.53	22.53	37VO-P 35.45	23.17	8.84	13.88	9.47	0.01	9.47	9.42
PAUSE	21.98	37VO-P 35.45	22.53	22.53	37VO-P 35.45		8.97	19.40	9.47	0.01	9.47	9.42

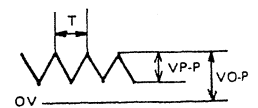

4. Shut off & Control P.C.Board

No.	Q702		
	E	C	B
STOP	GND QV	- QV	- QV
REW	GND QV	(B)	
PLAY	GND QV	(A)	
PLAY PAUSE	GND QV	 0.00	 0.00
REC PLAY	GND QV	(A)	
REC PLAY/PAUSE	GND QV	 0.00	 0.00
F.F.	GND QV	(B)	
PAUSE	GND QV	 0.00	 0.00

No.	Q703			Q704			Q705		
	E	C	B	E	C	B	E	C	B
STOP	GND QV	- QV	- 0.67V	GND 0.00	H 9.00	- 0.00	GND 0.00	- 9.50	- 0.00
REW	GND 0.00	(B)	 0.00	GND 0.00	H 8.78	(B)	GND 0.00	 0.03	 0.65
PLAY	GND 0.00	(A)	 0.00	GND 0.00	H 8.78	(A)	GND 0.00	 0.3	 0.65
PLAY PAUSE	GND 0.00	 0.00	 L-0.67	GND 0.00	H 9.00		GND 0.00	 0.03	 0.65
REC PLAY	GND 0.00	(A)	 L-0.67	GND 0.00	H 8.78	(A)	GND 0.00	 0.03	 0.65
REC PLAY/PAUSE	GND 0.00	 0.00	 L-0.67	GND 0.00	H 9.00		GND 0.00	 0.03	 0.65
F.F.	GND 0.00	(B)	 0.00	GND 0.00	H 8.78	(B)	GND 0.00	 0.03	 0.65
PAUSE	GND 0.00	 0.00	 0.67	GND 0.00	H 9.00	- 0.00	GND 0.00	 0.63	 0.65

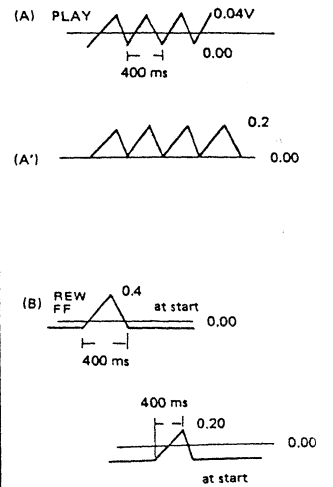

No.	MEMORY SW. OFF		
	A PLAY OFF		
	A REW OFF		
STATE	E	C	B
STOP	GND 0.00	- 8.97	- 0.00
REW	0.01	8.75	0.01
PLAY	0.01	0.75	0.01
PLAY PAUSE	0.01	8.97	0.01
REC PLAY	0.01	8.75	0.01
REC PLAY/PAUSE	0.01	8.97	0.01
F.F.	0.01	8.75	0.01
PAUSE	0.01	8.97	0.01

No.	POWER ON					
	Q724			Q725		
	E	C	B	E	C	B
STOP	GND 0.00	-	0.61	GND 0.00	-	0.61
REW						
PLAY						
PLAY PAUSE						
REC PLAY						
REC PLAY/PAUSE						
F.F.						
PAUSE						

Schematic Diagram (2/2)

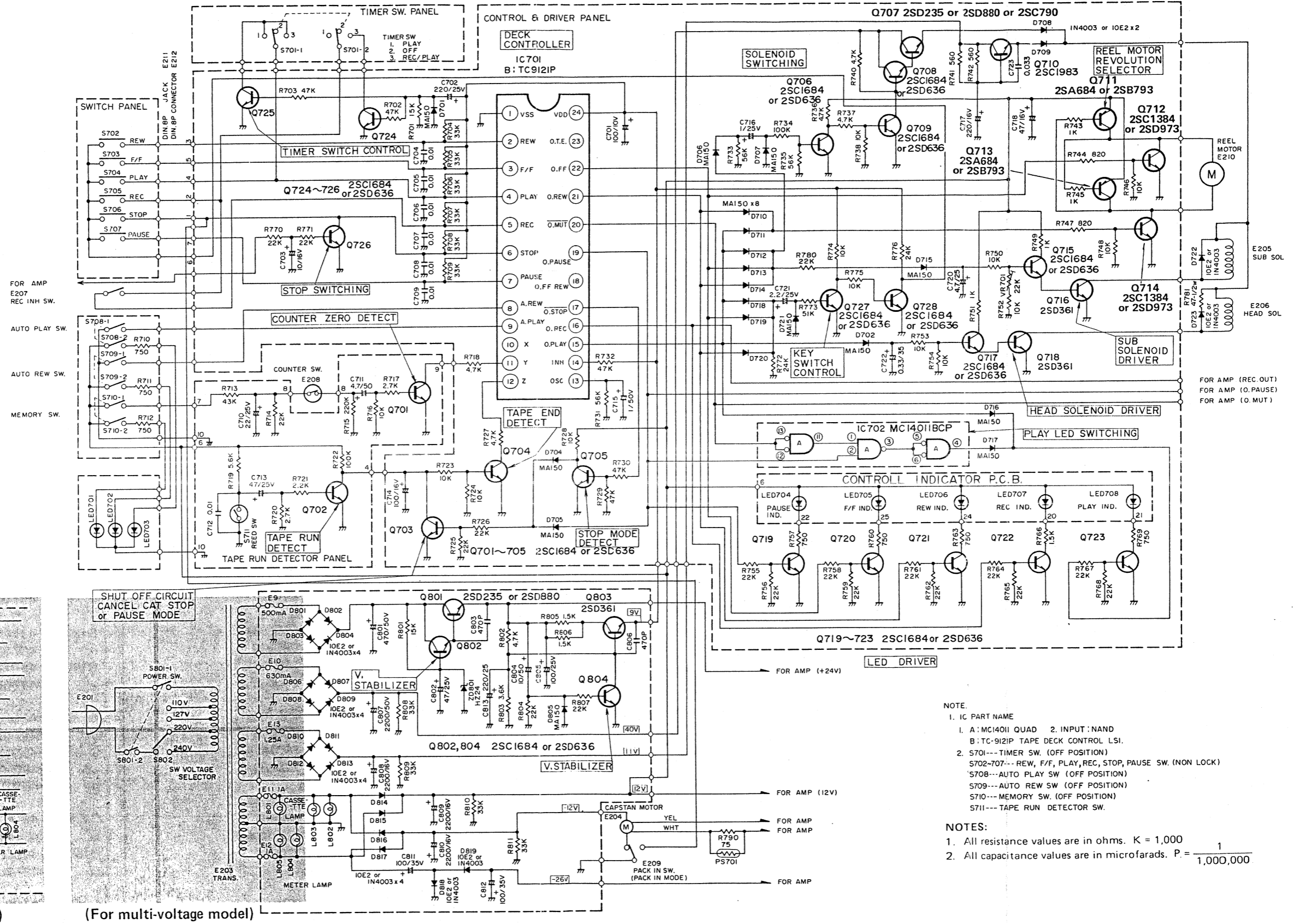

NOTE:
 1. IC PART NAME
 A: MC14011 QUAD 2. INPUT: NAND
 B: TC-912IP TAPE DECK CONTROL LSI.
 2. S701---TIMER SW. (OFF POSITION)
 S702-707---REW, F/F, PLAY, REC, STOP, PAUSE SW. (NON LOCK)
 S708---AUTO PLAY SW. (OFF POSITION)
 S709---AUTO REW SW. (OFF POSITION)
 S710---MEMORY SW. (OFF POSITION)
 S711---TAPE RUN DETECTOR SW.

NOTES:
 1. All resistance values are in ohms. K = 1,000
 2. All capacitance values are in microfarads. P. = $\frac{1}{1,000,000}$

Electrical Parts List

Resistors (All resistors are carbon film, 1/4W, ±5% unless otherwise noted.)
uF = microfarads, pF = picofarads

Symbol No.	Part No.	Description
Master P.C. Board		
IC's		
IC101	51T40114T01	NE645N
IC102	51T40114T01	NE645N
IC103	51T40114T01	NE645N
IC104	51T40114T01	NE645N
Transistors		
Q101	48T41195U04	2SC2263-U
or	48T41195U03	2SC2263-T
Q102	48T41195U04	2SC2263-U
or	48T41195U03	2SC2263-T
Q103	48T40021U03	2SC1327-U
or	48T41195U04	2SC2263-U
Q104	48T40021U03	2SC1327-U
or	48T41195U04	2SC2263-U
Q105	48T42539U01	2SK128-Q
or	48T42539U02	2SK128-R
Q106	48T42539U01	2SK128-Q
or	48T42539U02	2SK128-R
Q107	48T42943U01	2SC1684
or	48T40627U04	2SD636
Q108	48T42943U01	2SC1684
or	48T40627U04	2SD636
Q109	48T42943U01	2SC1684
or	48T40627U04	2SD636
Q110	48T42943U01	2SC1684
or	48T40627U04	2SD636
Q111	48T42943U01	2SC1684
or	48T40627U04	2SD636
Q112	48T42943U01	2SC1684
or	48T40627U04	2SD636
Q113	48T42538U02	2SK127
Q114	48T42538U02	2SK127
Q115	48T42538U02	2SK127
Q116	48T42538U02	2SK127
Q117	48T42943U01	2SC1684
or	48T40627U04	2SD636

Symbol No.	Part No.	Description
Q118	48T42943U01	2SC1684
or	48T40627U04	2SD636
Q119	48T42943U01	2SC1684
or	48T40627U04	2SD636
Q120	48T42943U01	2SC1684
or	48T40627U04	2SD636
Q121	48T42940U01	2SA564
or	48T40591U04	2SB641-R
or	48T51336F03	2SB642-R
Q122	48T42940U01	2SA564
or	48T40591U04	2SB641-R
or	48T51336F03	2SB642-R
Q123	48T42943U01	2SC1684
or	48T40627U04	2SD636
Q124	48T42943U01	2SC1684
or	48T40627U04	2SD636
Q125	48T42943U01	2SC1684
or	48T40627U04	2SD636
Q126	48T42943U01	2SC1684
or	48T40627U04	2SD636
Q127	48T42943U01	2SC1684
or	48T40627U04	2SD636
Q128	48T42943U01	2SC1684
or	48T40627U04	2SD636
Q129	48T43394P01	2SC1890
Q130	48T43394P01	2SC1890
Q131	48T43394P01	2SC1890
Q132	48T43394P01	2SC1890
Q133	48T42538U02	2SK127
Q134	48T42538U02	2SK127
Q135	48T42942U01	2SC1788-Q
or	48T42455F01	2SD638-R
Q136	48T42942U01	2SC1788-Q
or	48T42455F01	2SD638-R
Q137	48T42943U01	2SC1684
or	48T40627U04	2SD636
Q138	48T42942U01	2SC1788-Q
or	48T42455F01	2SD638-R
Q139	48T43394P01	2SC1890
Q140	48T43394P01	2SC1890
Q141	48T42943U01	2SC1684
or	48T40627U04	2SD636
Q142	48T42943U01	2SC1684
or	48T40627U04	2SD636

Symbol No.	Part No.	Description
Q143	48T42941U01	2SA921-S
or	48T42941U02	2SA921-T
Q144	48T42943U01	2SC1684
or	48T40627U04	2SD636
Q145	48T41197U04	2SA777-S
or	48T41197U03	2SA777-R
Q146	48T42538U02	2SK127
Q147	48T42538U02	2SK127
Q148	48T42943U01	2SC1684
or	48T40627U04	2SD636
Q149	48T42943U01	2SC1684
or	48T40627U04	2SD636
Q150	48T41197U04	2SA777-S
or	48T41197U03	2SA777-R
Q151	48T41195U03	2SC2263-T
or	48T41195U04	2SC2263-U
Q152	48T41195U03	2SC2263-T
or	48T41195U04	2SC2263-U
Q153	48T42539U01	2SK128
or	48T42539U02	2SK128
Q154	48T42539U01	2SK128
or	48T42539U02	2SK128
Q155	48T40021U03	2SC1327-U
or	48T41195U04	2SC2263-U
Q156	48T40021U03	2SC1327-U
or	48T41195U04	2SC2263-U
Q157	48T42943U01	2SC1684
or	48T40627U04	2SD636
Q158	48T42943U01	2SC1684
or	48T40627U04	2SD636
Q159	48T42943U01	2SC1684
or	48T40627U04	2SD636
Q160	48T42943U01	2SC1684
or	48T40627U04	2SD636
Q161	48T42943U01	2SC1684
or	48T40627U04	2SD636
Q162	48T42943U01	2SC1684
or	48T40627U04	2SD636
Q163	48T42943U01	2SC1684
or	48T40627U04	2SD636-R
Q164	48T42943U01	2SC1684
or	48T40627U04	2SD636-R

Symbol No.	Part No.	Description
Q165	48T42940U01	2SA564
or	48T40591U04	2SB641-R
or	48T51336F03	2SB642-R
Q166	48T42940U01	2SA564
or	48T40591U04	2SB641-R
or	48T51336F03	2SB642-R
Q167	48T41702F04	2SD889
Q168	48T41702F04	2SD889
Q169	48T42943U01	2SC1684
or	48T40627U04	2SD636-R
Q170	48T42943U01	2SC1684
or	48T40627U04	2SD636-R
Q171	48T42942U01	2SC1788-Q
or	48T42455F01	2SD638-R
Q172	48T42942U01	2SC1788-Q
or	48T42455F01	2SD638-R
Q173	48T42943U01	2SC1684
or	48T40627U04	2SD636-R
Q174	48T42943U01	2SC1684
or	48T40627U04	2SD636-R
Q175	48T42943U01	2SC1684
or	48T40627U04	2SD636-R
Q176	48T42943U01	2SC1684
or	48T40627U04	2SD636-R
Q179	48T42943U01	2SC1684
or	48T40627U04	2SD636-R
Q180	48T42943U01	2SC1684
or	48T40627U04	2SD636-R
Q181	48T42943U01	2SC1684
or	48T40627U04	2SD636-R
Q182	48T42943U01	2SC1684
or	48T40627U04	2SD636-R
Q183	48T42940U01	2SA564
or	48T40591U04	2SB641-R
or	48T51336F03	2SB642-R
Q184	48T42943U01	2SC1684
or	48T40627U04	2SD636-R
Q185	48T42941U01	2SA921-S
or	48T42941U02	2SA921-T
Q186	48T42942U01	2SC1788-Q
or	48T42455F01	2SD638-R
Q187	48T42943U01	2SC1684
or	48T40627U04	2SD636-R

Symbol No.	Part No.	Description
Q188	48T42538U07	2SK127
Q189	48T42943U01	2SC1684
or	48T40627U04	2SD636-R
Q190	48T42943U01	2SC1684
or	48T40627U04	2SD636-R
Q191	48T42943U01	2SC1684
or	48T40627U04	2SD636-R
Q193	48T42943U01	2SC1684
or	48T40627U04	2SD636-R
Q194	48T42943U01	2SC1684
or	48T40627U04	2SD636-R
Q195	48T43394P01	2SC1890
Q196	48T43394P01	2SC1890
● Q197	48T42538U02	2SK127
● Q198	48T42538U02	2SK127
● Q199	48T42943U01	2SC1684
● or	48T40627U04	2SD636-R
● Q200	48T42943U01	2SC1684
● or	48T40627U04	2SD636-R
● Q201	48T42940U01	2SA564
● or	48T40591U04	2SB641-R
● or	48T51336F03	2SB642-R
Diodes		
D101	48T51582F01	MA150
D102	48T51582F01	MA150
D103	48T51582F01	MA150
D104	48T51582F01	MA150
D105	48T51582F01	MA150
D106	48T51582F01	MA150
D108	48T51582F01	MA150
D110	48T51582F01	MA150
D111	48T51582F01	MA150
D112	48T51582F01	MA150
D113	48T51582F01	MA150
D114	48T51582F01	MA150
D115	48T51582F01	MA150
D116	48T51582F01	MA150
D117	48T51582F01	MA150
D118	48T51582F01	MA150
D119	48T51582F01	MA150
D120	48T51582F01	MA150
D121	48T51582F01	MA150
D122	48T51582F01	MA150

Symbol No.	Part No.	Description
D123	48T51582F01	MA150
D124	48T51582F01	MA150
D125	48T51582F01	MA150
D126	48T51582F01	MA150
D127	48T51582F01	MA150
D128	48T51582F01	MA150
D129	48T51582F01	MA150
D130	48T51582F01	MA150
D131	48T51582F01	MA150
D132	48T51582F01	MA150
D133	48S134816	1S1555
D134	48S134816	1S1555
D135	48T51582F01	MA150
D136	48T51582F01	MA150
D137	48T51582F01	MA150
D138	48T51582F01	MA150
D139	48T51582F01	MA150
D140	48T51582F01	MA150
D141	48T40477U01	IN4003
D142	48T51582F01	MA150
D143	48T51582F01	MA150
D144	48T51582F01	MA150
● D145	48T51582F01	MA150
● D146	48T51582F01	MA150
D147	48T40477U01	IN4003
D148	48T40477U01	IN4003
D151	48S134816	1S1555
ZD101	48S41873J11	Zener RD5.1E
ZD102	48T40059U38	Zener 12A-2L
or	48T40059U39	Zener 12A-3L
Coils		
L101	24T51803F01	Trap 4.7mH
L102	24T51803F01	Trap 4.7mH
L103	24S41199U05	2.2mH
L104	24S41199U05	2.2mH
L105	24S41199U03	1.5mH
L106	24S41199U03	1.5mH
L107	24S41199U10	5.6mH
L108	24S41199U10	5.6mH
L109	24T51803F02	Trap 10mH
L110	24T51803F02	Trap 10mH
L111	24T51803F01	Trap 4.7mH
L112	24T51803F01	Trap 4.7mH
L113	24S41199U03	1.5mH
L114	24S41199U03	1.5mH

●: For multi-voltage model only ■: For single voltage model only Others: Common

Symbol No.	Part No.	Description	
Transformer, Filters & Jack			
E105	51T42537U01	Filter, MPX	
E106	51T42537U01	Filter, MPX	
E111	25T41701F01	Transformer, OSC	
● E113	9T40584T01	Jack, DIN	
Switches			
S102	40T42529U01	Rotary Slide (Dolby NR)	
S103	40T44472U01	Rotary (Tape Select)	
S104	40T42542U01	Lever (Monitor)	
S105	40T42542U01	Lever (Meter)	
Capacitors			
C101	23T40475U04	Electrolytic	0.47 uF/50V
C102	23T40475U04	Electrolytic	0.47 uF/50V
C103	8S44505P45	Ceramic	470 pF
C104	8S44505P45	Ceramic	470 pF
C107	23S41198U33	Electrolytic	100 uF/10V
C108	23S41198U33	Electrolytic	100 uF/10V
C109	23T40475U15	Electrolytic	10 uF/25V
C110	23T40475U15	Electrolytic	10 uF/25V
C111	23T40475U15	Electrolytic	10 uF/25V
C112	23T40475U15	Electrolytic	10 uF/25V
C113	23T40475U15	Electrolytic	10 uF/10V
C114	23T40475U15	Electrolytic	10 uF/25V
C115	23S41198U33	Electrolytic	100 uF/10V
C116	23S41198U33	Electrolytic	100 uF/10V
C117	23T40475U05	Electrolytic	1 uF/50V
C118	23T40475U05	Electrolytic	1 uF/50V
C119	8S44505P23	Ceramic	27 pF
C120	8S44505P23	Ceramic	27 pF
C123	8S44503P10	Mylar	0.0056 uF
C124	8S44503P10	Mylar	0.0056 uF
C125	8T50579F06	T.F.	0.027 uF/50V
C126	8T50579F06	T.F.	0.027 uF/50V
C127	8S44503P09	Mylar	0.0047 uF
C128	8S44593P09	Mylar	0.0047 uF
C129	8T50579F13	T.F.	0.1 uF
C130	8T50579F13	T.F.	0.1 uF
C131	23C42909J04	Electrolytic	0.33 uF/50V
C132	23C42909J04	Electrolytic	0.33 uF/50V
C133	8T50579F09	T.F.	0.047 uF
C134	8T50579F09	T.F.	0.047 uF

Symbol No.	Part No.	Description	
C135	23S41198U12	Electrolytic	10 uF/50V
C136	23S41198U12	Electrolytic	10 uF/50V
C137	23S41198U12	Electrolytic	10 uF/50V
C138	23S41198U12	Electrolytic	10 uF/50V
C139	23S41198U12	Electrolytic	10 uF/50V
C140	23S41198U12	Electrolytic	10 uF/50V
C141	23T40475U15	Electrolytic	10 uF/25V
C142	23T40475U15	Electrolytic	10 uF/25V
C143	23S41198U03	Electrolytic	1 uF/50V
C144	23S41198U03	Electrolytic	1 uF/50V
C145	23S41198U26	Electrolytic	47 uF/10V
C146	23S41198U26	Electrolytic	47 uF/10V
C147	23C42909J05	Electrolytic	0.68 uF/50V
C148	23C42909J05	Electrolytic	0.68 uF/50V
C149	23S41198U12	Electrolytic	10 uF/50V
C150	23S41198U12	Electrolytic	10 uF/50V
C153	8S44505P45	Ceramic	470 pF
C154	8S44505P45	Ceramic	470 pF
C155	8S44505P45	Ceramic	470 pF
C156	8S44505P45	Ceramic	470 pF
C157	8S44505P53	Ceramic	2200 pF
C158	8S44505P53	Ceramic	2200 pF
C159	8S44505P43	Ceramic	330 pF
C160	8S44505P43	Ceramic	330 pF
C161	8S44505P43	Ceramic	330 pF
C162	8S44505P43	Ceramic	330 pF
C163	8S44505P37	Ceramic	100 pF
C164	8S44505P37	Ceramic	100 pF
C165	8T50579F04	T.F.	0.018 uF/50V
C166	8T50579F04	T.F.	0.018 uF/50V
C167	8T50579F04	T.F.	0.018 uF/50V
C168	23S41198U42	Electrolytic	220 uF/25V
C169	8S44505P61	Ceramic	0.01 uF
C170	8S44505P61	Ceramic	0.01 uF
C171	8S44505P61	Ceramic	0.01 uF
C172	8S44505P61	Ceramic	0.01 uF
C174	23S41198U35	Electrolytic	100 uF/25V
C175	23T40475U15	Electrolytic	10 uF/25V
C176	23T40475U15	Electrolytic	10 uF/25V
C177	23S41198U35	Electrolytic	100 uF/25V
C178	23S41192U17	Electrolytic	4.7 uF/25V
C179	23S41192U17	Electrolytic	4.7 uF/25V
C180	23S41192U68	Electrolytic	100 uF/10V
C181	23S41198U35	Electrolytic	100 uF/25V
C182	23S41192U17	Electrolytic	4.7 uF/25V

●: For multi-voltage model only ■: For single voltage model only Others: Common

Symbol No.	Part No.	Description
C183	23S41192U17	Electrolytic 4.7 uF/25V
C184	23S41192U17	Electrolytic 4.7 uF/25V
C185	23S41192U17	Electrolytic 4.7 uF/25V
C186	23S41198U35	Electrolytic 100 uF/25V
C187	8T50579F07	T.F. 0.033 uF
C188	8T50579F07	T.F. 0.033 uF
C189	8T50579F07	T.F. 0.033 uF
C190	8T50579F07	T.F. 0.033 uF
C191	8T50579F08	T.F. 0.039 uF/25V
C192	8T50579F08	T.F. 0.039 uF/25V
C193	8T50579F11	T.F. 0.068 uF
C194	8T50579F11	T.F. 0.068 uF
C195	8T50579F04	T.F. 0.018 uF
C196	8T50579F04	T.F. 0.018 uF
C199	23S41192U17	Electrolytic 4.7 uF/25V
C200	23S41192U17	Electrolytic 4.7 uF/25V
C201	23S41198U12	Electrolytic 10 uF/50V
C202	23S41198U12	Electrolytic 10 uF/50V
C203	23S41059P33	Tantalum 33 uF/6.3V
C204	23S41059P01	Tantalum 0.1 uF/35V
C205	23S41198U03	Electrolytic 1 uF/50V
C206	8S44505P49	Ceramic 1000 pF
C207	8T50579F01	T.F. 0.01 uF
C208	8T44481F05	Polypropylene 470 pF
C209	8T50579F01	T.F. 0.01 uF
C210	8T44481F05	Polypropylene 470 pF
C211	8T50579F01	T.F. 0.01 uF
C212	8T44481F05	Polypropylene 470 pF
C213	8T50579F01	T.F. 0.01 uF
C214	8T44481F05	Ceramic 470 pF
C215	23S41198U65	Electrolytic 1000 uF/25V
C216	23S41198U03	Electrolytic 1 uF/50V
C217	23S41198U42	Electrolytic 220 uF/25V
C218	23S41198U57	Electrolytic 470 uF/25V
C219	23S41192U17	Electrolytic 4.7 uF/25V
C220	23S41192U43	Electrolytic 22 uF/25V
C221	8T50579F08	T.F. 0.039 uF/50V
C222	8T50579F08	T.F. 0.039 uF/50V
C223	8T50579F11	T.F. 0.068 uF
C224	8T50579F11	T.F. 0.068 uF
C225	8S44505P43	Ceramic 330 pF
C226	8S44505P43	Ceramic 330 pF
C227	8S44505P61	Ceramic 0.01 uF
C229	8T44481F33	Polypropylene 0.0068 uF/50V
C230	8T44481F05	Polypropylene 470 pF

Symbol No.	Part No.	Description
C231	23S41198U28	Electrolytic 47 uF/25V
C233	8T44504P01	Polypropylene 4700 pF/125V
C401	21C41701J74	Ceramic 82 pF
or	21C41701J57	Ceramic 100 pF
or	21C41701J88	Ceramic 120 pF
or	21C41701J89	Ceramic 150 pF
or	21C41701J90	Ceramic 180 pF
or	21C41701J78	Ceramic 200 pF
or	21C41701J91	Ceramic 220 pF
C402	21C41701J74	Ceramic 82 pF
or	21C41701J57	Ceramic 100 pF
or	21C41701J88	Ceramic 120 pF
or	21C41701J89	Ceramic 150 pF
or	21C41701J90	Ceramic 180 pF
or	21C41701J78	Ceramic 200 pF
or	21C41701J91	Ceramic 220 pF
C405	8S44505P45	Ceramic 470 pF
C406	8S44505P45	Ceramic 470 pF
C407	8S44505P25	Ceramic 33 pF
C408	8S44505P25	Ceramic 33 pF
C409	23S41198U33	Electrolytic 100 uF/10V
C410	23S41198U33	Electrolytic 100 uF/10V
C411	8S44505P33	Ceramic 68 pF/50V
C412	8S44505P33	Ceramic 68 pF/50V
C413	8S44505P25	Ceramic 33 pF
C414	8S44505P25	Ceramic 33 pF
C415	8T50579F01	T.F. 0.033 uF/50V
C416	8T50579F01	T.F. 0.033 uF/50V
C417	23T40475U15	Electrolytic 10 uF/25V
C418	23T40475U15	Electrolytic 10 uF/25V
C419	23T40475U31	Electrolytic 100 uF/25V
C420	23T40475U31	Electrolytic 100 uF/25V
C421	23S41198U69	Electrolytic 2200 uF/6.3V
C422	23S41198U69	Electrolytic 2200 uF/6.3V
C423	8S44505P41	Ceramic 220 pF
C424	8S44505P41	Ceramic 220 pF
C425	8T50579F03	T.F. 0.015 uF/50V
C426	8T50579F03	T.F. 0.015 uF/50V
C427	23T40475U05	Electrolytic 1 uF/50V
C428	23T40475U05	Electrolytic 1 uF/50V
C429	8S44505P23	Ceramic 27 pF
C430	8S44505P23	Ceramic 27 pF
C431	8S44505P45	Ceramic 470 pF
C432	8S44505P45	Ceramic 470 pF
C433	8S44505P41	Ceramic 220 pF
C434	8S44505P41	Ceramic 220 pF

Symbol No.	Part No.	Description
C435	23S41198U12	Electrolytic 10 uF/50V
C436	23S41198U12	Electrolytic 10 uF/50V
C437	8S44503P09	Mylar 0.0047 uF
C438	8S44503P09	Mylar 0.0047 uF
C439	8T50579F06	T.F. 0.027 uF/50V
C440	8T50579F06	T.F. 0.027 uF/50V
C441	8T50579F13	T.F. 0.1 uF
C442	8T50579F13	T.F. 0.1 uF
C443	23C42909J04	Electrolytic 0.33 uF/50V
C444	23C42909J04	Electrolytic 0.33 uF/50V
C445	8T50579F09	T.F. 0.047 uF
C446	8T50579F09	T.F. 0.047 uF
C447	23S41198U12	Electrolytic 10 uF/50V
C448	23S41198U12	Electrolytic 10 uF/50V
C449	8S44503P10	Mylar 0.0056 uF
C450	8S44503P10	Mylar 0.0056 uF
C451	23T40475U15	Electrolytic 10 uF/25V
C452	23T40475U15	Electrolytic 10 uF/25V
C453	23T40475U15	Electrolytic 10 uF/25V
C454	23T40475U15	Electrolytic 10 uF/25V
C455	23S41198U12	Electrolytic 10 uF/50V
C456	23S41198U12	Electrolytic 10 uF/50V
C457	23S41198U03	Electrolytic 1 uF/50V
C458	23S41198U03	Electrolytic 1 uF/50V
C459	8S44505P33	Ceramic 68 pF/50V
C460	8S44505P33	Ceramic 68 pF/50V
C461	23S41198U41	Electrolytic 220 uF/16V
C462	23S41198U41	Electrolytic 220 uF/16V
C463	23S41198U03	Electrolytic 1 uF/50V
C464	23S41198U03	Electrolytic 1 uF/50V
C465	8S44505P33	Ceramic 68 pF/50V
C466	8S44505P33	Ceramic 68 pF/50V
C467	23S41198U12	Electrolytic 10 uF/50V
C468	23S41198U12	Electrolytic 10 uF/50V
C469	23T40475U15	Electrolytic 10 uF/25V
C470	23T40475U15	Electrolytic 10 uF/25V
C471	23S41059P01	Tantalum 0.1 uF/35V
C472	23S41059P01	Tantalum 0.1 uF/35V
C473	23S41059P07	Tantalum 1 uF/25V
C474	23S41059P07	Tantalum 1 uF/25V
C475	23S41192U17	Electrolytic 4.7 uF/25V
C476	23S41192U17	Electrolytic 4.7 uF/25V
C478	23S41192U17	Electrolytic 4.7 uF/25V
C479	23S41198U34	Electrolytic 100 uF/16V
C480	23S41198U34	Electrolytic 100 uF/16V

Symbol No.	Part No.	Description
C484	23S41198U35	Electrolytic 100 uF/25V
C485	23T44501P24	Electrolytic 33 uF/35V
C486	23S41198U34	Electrolytic 100 uF/16V
C487	23S41198U41	Electrolytic 220 uF/16V
C488	23S41198U56	Electrolytic 470 uF/16V
C489	23S41198U40	Electrolytic 220 uF/10V
C490	23S41198U55	Electrolytic 470 uF/10V
C491	23S41198U40	Electrolytic 220 uF/10V
C492	23S41198U55	Electrolytic 470 uF/10V
C493	23T40475U07	Electrolytic 22 uF/50V
● C494	23S41198U03	Electrolytic 1 uF/50V
C497	23S41198U33	Electrolytic 100 uF/10V
C498	23S41198U33	Electrolytic 100 uF/10V
C499	8C44833J01	Mylar 0.001 uF
C500	8C44833J01	Mylar 0.001 uF
C501	8C44833J01	Mylar 0.001 uF
C502	8C44833J01	Mylar 0.001 uF
C503	8S44505P61	Ceramic 10000 pF
C601	8S44503P01	Mylar 0.001 uF
C602	8S44503P01	Mylar 0.001 uF
C901	8S44503P05	Mylar 0.0022 uF
C902	8S44503P05	Mylar 0.0022 uF
C903	8S44503P10	Mylar 0.0056 uF
C904	8S44503P10	Mylar 0.0056 uF
C905	8S44503P01	Mylar 0.001 uF
C906	8S44503P01	Mylar 0.001 uF
C907	8S44503P10	Mylar 0.0056 uF
C908	8S44503P10	Mylar 0.0056 uF
Resistors		
R103	6S44593P41	100 ohm
R104	6S44593P41	100 ohm
R105	6S40106T25	300K ohm
R106	6S40106T25	300K ohm
R107	6S40106T34	680K ohm
R108	6S40106T34	680K ohm
R109	6S44593P89	10K ohm
R110	6S44593P89	10K ohm
R111	6S44593P91	12K ohm
R112	6S44593P91	12K ohm

●: For multi-voltage model only ■: For single voltage model only Others: Common

Symbol No.	Part No.	Description
R113	6S44593P67	1.2K ohm
R114	6S44593P67	1.2K ohm
R115	6S40106T26	330K ohm
R116	6S40106T26	330K ohm
R117	6S44594P06	47K ohm
R118	6S44594P06	47K ohm
R119	6S40150T89	10K ohm
R120	6S40150T89	10K ohm
R121	6S44594P14	100K ohm
R122	6S40151T14	100K ohm
R123	6S40106T14	100K ohm
R124	6S40106T14	100K ohm
R125	6S40106T14	100K ohm
R126	6S40106T14	100K ohm
R127	6S44593P83	5.6K ohm
R128	6S44593P83	5.6K ohm
R129	6S44593P35	56 ohm
R130	6S44593P35	56 ohm
R131	6S44594P30	470K ohm
R132	6S44594P30	470K ohm
R133	6S44594P30	470K ohm
R134	6S44594P30	470K ohm
R135	6S44593P85	6.8K ohm
R136	6S44593P85	6.8K ohm
R137	6S40106T26	330K ohm
R138	6S40106T26	330K ohm
R139	6S40106T26	330K ohm
R140	6S40106T26	330K ohm
R141	6S44593P89	10K ohm
R142	6S44593P89	10K ohm
R143	6S44594P14	100K ohm
R144	6S44594P14	100K ohm
R145	6S44594P14	100K ohm
R146	6S44594P14	100K ohm
R147	6S44593P89	10K ohm
R148	6S44593P89	10K ohm
R149	6S44594P38	1M ohm
R150	6S44594P38	1M ohm
R151	6S44593P41	100 ohm
R152	6S44593P41	100 ohm
R153	6S44593P89	10K ohm
R154	6S44593P89	10K ohm
R155	6S44593P89	10K ohm
R156	6S44593P89	10K ohm
R157	6S44593P77	3.3K ohm

Symbol No.	Part No.	Description
R158	6S44593P89	10K ohm
R159	6S44594P55	5.1M ohm
R160	6S44594P55	5.1M ohm
R161	6S44594P55	5.1M ohm
R162	6S44594P55	5.1M ohm
R163	6S44594P14	100K ohm
R164	6S44594P14	100K ohm
R165	6S44594P38	1M ohm
R166	6S44594P38	1M ohm
R167	6S44594P38	1M ohm
R168	6S44594P38	1M ohm
R169	6S44594P38	1M ohm
R170	6S44594P38	1M ohm
R171	6S44594P38	1M ohm
R172	6S44594P38	1M ohm
R173	6S44594P14	100K ohm
R174	6S44594P14	100K ohm
R175	6S44594P14	100K ohm
R176	6S44594P14	100K ohm
R177	6S44593P47	180 ohm
R178	6S44593P47	180 ohm
R179	6S44594P06	47K ohm
R180	6S44594P06	47K ohm
R181	6S44593P77	3.3K ohm
R182	6S44593P77	3.3K ohm
R183	6S44594P20	180K ohm
R184	6S44594P20	180K ohm
R185	6S44594P24	270K ohm
R186	6S44594P24	270K ohm
R187	6S44594P18	150K ohm
R188	6S44594P18	150K ohm
R189	6S44594P05	43K ohm
R190	6S44594P05	43K ohm
R191	6S44593P89	10K ohm
R192	6S44593P89	10K ohm
R193	6S44593P65	1K ohm
R194	6S44593P65	1K ohm
R195	6S40106T25	300K ohm
R196	6S40106T25	300K ohm
R197	6S44594P38	1M ohm
R198	6S44594P38	1M ohm
R199	6S44593P78	3.6K ohm
R200	6S44593P78	3.6K ohm
R201	6S44593P85	6.8K ohm
R202	6S44593P85	6.8K ohm

Symbol No.	Part No.	Description
R205	6S44593P65	1K ohm
R206	6S44593P65	1K ohm
R207	6S44593P37	68 ohm
R208	6S44593P37	68 ohm
R209	6S44594P09	62K ohm
R210	6S44594P09	62K ohm
R211	6S44593P74	2.4K ohm
R212	6S44593P74	2.4K ohm
R213	6S44593P73	2.2K ohm
R214	6S44593P73	2.2K ohm
R215	6S44593P41	100 ohm
R216	6S44593P41	100 ohm
R217	6S44593P17	10 ohm
R218	6S44593P17	10 ohm
R219	6S44593P27	27 ohm
R220	6S44593P27	27 ohm
R221	6S44593P73	2.2K ohm
R222	6S44593P73	2.2K ohm
R223	6S44593P81	4.7K ohm
R224	6S44593P81	4.7K ohm
R225	6S44593P29	33 ohm
R226	6S44593P29	33 ohm
R227	6S44593P65	1K ohm
R228	6S44593P65	1K ohm
R231	6S44593P37	68 ohm
R232	6S44593P37	68 ohm
R233	6S44594P11	75K ohm
R234	6S44594P11	75K ohm
R235	6S44593P86	7.5K ohm
R236	6S44593P86	7.5K ohm
R237	6S44593P89	10K ohm
R238	6S44593P89	10K ohm
R239	6S44593P89	10K ohm
R240	6S44593P89	10K ohm
R241	6S44593P89	10K ohm
R242	6S44593P89	10K ohm
R243	6S44593P99	27K ohm
R244	6S44593P99	27K ohm
R245	6S44594P22	220K ohm
R246	6S44594P22	220K ohm
R247	6S44593P85	6.8K ohm
R248	6S44593P85	6.8K ohm
R249	6S44593P65	1K ohm
R250	6S44593P65	1K ohm
R251	6S44593P51	270 ohm

Symbol No.	Part No.	Description
R252	6S44593P51	270 ohm
R253	6S44594P02	33K ohm
R254	6S44594P02	33K ohm
R255	6S44594P02	33K ohm
R256	6S44594P02	33K ohm
R257	6S44594P02	33K ohm
R258	6S44594P02	33K ohm
R259	6S44593P89	10K ohm
R260	6S44593P89	10K ohm
R261	6S44593P89	10K ohm
R262	6S44593P89	10K ohm
R263	6S44593P69	1.5K ohm
R264	6S44593P69	1.5K ohm
R265	6S44593P65	1K ohm
R266	6S44593P65	1K ohm
R267	6S44593P83	5.6K ohm
R268	6S44593P83	5.6K ohm
R271	6S44594P38	1M ohm
R272	6S44594P38	1M ohm
R273	6S44594P44	1.8M ohm
R274	6S44594P44	1.8M ohm
R275	6S44593P77	3.3K ohm
R276	6S44594P02	33K ohm
R277	6S40150T97	22K ohm
R278	6S44593P89	10K ohm
R281	6S44593P99	27K ohm
R282	6S44593P99	27K ohm
R283	6C44652G26	Metal Film 10 ohm 1W
R285	6S44593P65	1K ohm
R286	6S44594P22	220K ohm
R287	6S44594P22	220K ohm
R288	6S44594P22	220K ohm
R289	6S44593P73	2.2K ohm
R291	6S44593P61	680 ohm
R292	6S44594P14	100K ohm
R293	6S44594P14	100K ohm
R294	6S44594P06	47K ohm
R295	6S44594P14	100K ohm
R296	6S44594P06	47K ohm
R297	6S44594P14	100K ohm
R298	6S44594P22	220K ohm
R299	6S44594P22	220K ohm
R300	6S44594P22	220K ohm
R301	6S44594P22	220K ohm
R302	6S44594P22	220K ohm

Symbol No.	Part No.	Description
R303	6S44593P97	22K ohm
R304	6S44593P97	22K ohm
R305	6S44593P97	22K ohm
R306	6S44593P97	22K ohm
R307	6S44593P89	10K ohm
R308	6S44593P89	10K ohm
R309	6S44593P97	22K ohm
R310	6S44593P97	22K ohm
R311	6S44593P89	10K ohm
R312	6S44593P89	10K ohm
R313	6S44594P38	1M ohm
R314	6S44594P46	2.2M ohm
R315	6S44593P63	820 ohm
R316	6S44593P89	10K ohm
R317	6S44594P38	1M ohm
R318	6S44594P46	2.2M ohm
R319	6S44593P79	3.9K ohm
R320	6S44593P79	3.9K ohm
R321	6S44593P65	1K ohm
R322	6S44594P14	100K ohm
R323	6S44593P58	510 ohm
R324	6S44593P97	22K ohm
R325	6S44593P97	22K ohm
R326	6S44593P65	1K ohm
R327	6S44593P62	750 ohm
R329	6S44593P65	1K ohm
R330	6S44593P65	1K ohm
R331	6S44593P89	10K ohm
R332	6S44593P89	10K ohm
R333	6S44593P91	12K ohm
R334	6S44593P89	10K ohm
R335	6S44594P22	220K ohm
R336	6S44594P22	220K ohm
R337	6S44593P29	33 ohm
R338	6S44593P29	33 ohm
R339	6S44593P65	1K ohm
R340	6S44593P65	1K ohm
R341	6S44593P71	1.8K ohm
R342	6S44593P71	1.8K ohm
R343	6S44593P65	1K ohm
R344	6S44593P65	1K ohm
R346	6S44593P89	10K ohm
R347	6S44593P89	10K ohm
R348	6S44593P89	10K ohm
R349	6S44593P79	3.9K ohm

Symbol No.	Part No.	Description
R350	6S44593P82	5.1K ohm
R351	6S44593P81	4.7K ohm
R352	6S44593P89	10K ohm
R353	6S44593P85	6.8K ohm
R354	6S44593P85	6.8K ohm
R401	6S40106T38	1M ohm
R402	6S40106T38	1M ohm
R403	6S40106T32	560K ohm
R404	6S40106T32	560K ohm
R405	6S44593P41	100 ohm
R406	6S44593P41	100 ohm
R407	6S40106T14	100K ohm
R408	6S40106T14	100K ohm
R409	6S44593P27	27 ohm
R410	6S44593P27	27 ohm
R411	6S44593P97	22K ohm
R412	6S44593P97	22K ohm
R413	6S44593P86	7.5K ohm
R414	6S44593P86	7.5K ohm
R415	6S44593P81	4.7K ohm
R416	6S44593P81	4.7K ohm
R417	6S44593P81	4.7K ohm
R418	6S44593P81	4.7K ohm
R419	6S40106T14	100K ohm
R420	6S40106T14	100K ohm
R421	6S44593P78	3.6K ohm
R422	6S44593P78	3.6K ohm
R423	6S44593P95	18K ohm
R424	6S44593P95	18K ohm
R425	6S44594P11	75K ohm
R426	6S44594P11	75K ohm
R427	6S44593P80	4.3K ohm
R428	6S44593P80	4.3K ohm
R429	6S44594P38	1M ohm
R430	6S44594P38	1M ohm
R431	6S44593P65	1K ohm
R432	6S44593P65	1K ohm
R433	6S44593P89	10K ohm
R434	6S44593P89	10K ohm
R435	6S44593P77	3.3K ohm
R436	6S44593P77	3.3K ohm
R437	6S44593P89	10K ohm
R438	6S44593P89	10K ohm
R439	6S44593P77	3.3K ohm
R440	6S44593P89	10K ohm

Symbol No.	Part No.	Description
R441	6S44593P89	10K ohm
R442	6S44593P89	10K ohm
R443	6S44593P89	10K ohm
R444	6S44593P89	10K ohm
R445	6S44594P08	56K ohm
R446	6S44594P08	56K ohm
R447	6S44593P77	3.3K ohm
R448	6S44593P89	10K ohm
R449	6S44594P38	1M ohm
R450	6S44594P38	1M ohm
R451	6S44593P41	100 ohm
R452	6S44593P41	100 ohm
R453	6S44594P06	47K ohm
R454	6S44594P06	47K ohm
R455	6S44593P77	3.3K ohm
R456	6S44593P77	3.3K ohm
R457	6S44594P20	180K ohm
R458	6S44594P20	180K ohm
R459	6S44594P24	270K ohm
R460	6S44594P24	270K ohm
R461	6S44593P47	180 ohm
R462	6S44593P47	180 ohm
R463	6S44594P18	150K ohm
R464	6S44594P18	150K ohm
R465	6S44593P89	10K ohm
R466	6S44593P89	10K ohm
R467	6S44593P99	27K ohm
R468	6S44593P99	27K ohm
R469	6S40106T25	300K ohm
R470	6S40106T25	300K ohm
R471	6S40106T34	680K ohm
R472	6S40106T34	680K ohm
R473	6S44593P78	3.6K ohm
R474	6S44593P78	3.6K ohm
R475	6S44593P85	6.8K ohm
R476	6S44593P85	6.8K ohm
R477	6S44593P91	12K ohm
R478	6S44593P91	12K ohm
R479	6S44593P37	68 ohm
R480	6S44593P37	68 ohm
R481	6S44593P65	1K ohm
R482	6S44593P65	1K ohm
R483	6S44593P49	220 ohm
R484	6S44593P49	220 ohm
R485	6S44593P65	1K ohm

Symbol No.	Part No.	Description
R486	6S44593P65	1K ohm
R487	6S44594P14	100K ohm
R488	6S44594P14	100K ohm
R489	6S44593P87	8.2K ohm
R490	6S44593P87	8.2K ohm
R491	6S44594P14	100K ohm
R492	6S44594P14	100K ohm
R493	6S44593P80	4.3K ohm
R494	6S44593P80	4.3K ohm
R495	6S40150T56	430 ohm
R496	6S40150T56	430 ohm
R497	6S40150T56	430 ohm
R498	6S40150T56	430 ohm
R499	6S40150T56	430 ohm
R500	6S40150T56	430 ohm
R501	6S40150T89	10K ohm
R502	6S40150T89	10K ohm
R503	6S40150T45	150 ohm
R504	6S40150T45	150 ohm
R505	6S40150T45	150 ohm
R506	6S40150T45	150 ohm
R507	6S40150T45	150 ohm
R508	6S40150T45	150 ohm
R511	6S44593P76	3K ohm
R512	6S44593P76	3K ohm
R513	6S44594P24	270K ohm
R514	6S44594P24	270K ohm
R515	6S44594P55	5.1M ohm
R516	6S44594P55	5.1M ohm
R517	6S44593P99	27K ohm
R518	6S44593P99	27K ohm
R519	6S44593P81	4.7K ohm
R520	6S44593P81	4.7K ohm
R521	6S44593P89	10K ohm
R522	6S44593P89	10K ohm
R523	6S44593P91	12K ohm
R524	6S44593P91	12K ohm
R525	6S44593P21	15 ohm
R526	6S44593P21	15 ohm
R527	6S44593P89	10K ohm
R528	6S44593P89	10K ohm
R529	6S44594P30	3.3M ohm
R530	6S44594P30	3.3M ohm
R531	6S44594P38	1M ohm
R532	6S44594P38	1M ohm

Symbol No.	Part No.	Description
R533	6S44593P74	2.4K ohm
R534	6S44593P74	2.4K ohm
R535	6S44593P82	5.1K ohm
R536	6S44593P82	5.1K ohm
R537	6S40151T50	3.3M ohm
R538	6S40151T50	3.3M ohm
R539	6S44593P81	4.7K ohm
R540	6S44593P97	22K ohm
R543	6S44593P72	2K ohm
R544	6S44593P72	2K ohm
R547	6S44593P83	5.6K ohm
R548	6S44593P83	5.6K ohm
R549	6S44594P14	100K ohm
R550	6S44594P14	100K ohm
R551	6S44593P89	10K ohm
R552	6S44594P08	56K ohm
R553	6S44594P14	100K ohm
R554	6S44593P89	10K ohm
R555	6S44593P97	22K ohm
R556	6S44593P99	27K ohm
R557	6S44594P14	100K ohm
R558	6S40150T89	10K ohm
R559	6S44593P89	10K ohm
R561	6S44593P61	680 ohm
R562	6S44593P61	680 ohm
R563	6S44593P61	680 ohm
R564	6S44593P76	3K ohm
R565	6S44593P83	5.6K ohm
R566	6S44593P83	5.6K ohm
R567	6S44593P84	6.2K ohm
R569	6S40106T14	100K ohm
R570	6S40106T14	100K ohm
R571	6S44593P97	22K ohm
R572	6S44593P97	22K ohm
R573	6S44593P65	1K ohm
R574	6S44593P65	1K ohm
R575	6S44593P95	18K ohm
R576	6S44593P95	18K ohm
R577	6S44593P89	10K ohm
R578	6S44593P89	10K ohm
R579	6S44593P83	5.6K ohm
R580	6S44593P84	6.2K ohm
R581	6S44593P89	10K ohm
R582	6S44593P97	22K ohm
R583	6S44593P89	10K ohm

Symbol No.	Part No.	Description
R584	6S44593P89	10K ohm
R585	6S44593P89	10K ohm
R586	6S44593P89	10K ohm
R590	6S44594P14	100K ohm
R591	6S44594P38	1M ohm
R592	6S44594P38	1M ohm
R593	6S44593P77	3.3K ohm
R594	6S44593P77	3.3K ohm
R595	6S44594P55	5.1M ohm
R596	6S44594P55	5.1M ohm
R597	6S44594P14	100K ohm
R598	6S44594P14	100K ohm
R599	6S44593P83	5.6K ohm
R600	6S44593P83	5.6K ohm
R601	6S44594P06	47K ohm
R602	6S44593P89	10K ohm
R603	6S44593P89	10K ohm
R604	6S44593P89	10K ohm
R605	6S44594P14	100K ohm
R606	6S44594P14	100K ohm
R619	6S44594P48	2.7M ohm
R620	6S44594P48	2.7M ohm
R620	6S44594P48	2.7M ohm
R621	6S44593P93	15K ohm
R622	6S44593P93	15k ohm
R623	6S44593P65	1K ohm
R624	6S44593P65	1K ohm
R625	6S40106T26	330K ohm
R626	6S40106T26	330K ohm
R628	6S44594P22	220K ohm
VR101	18T42531U01	Rotary 50KA [Rec. Level (Line)]
VR102	18T42531U01	Rotary 50KA [Rec. Level (Mic/DIN)]
VR103	18T42532U01	Rotary 50KA [Rec. Level (Master)]
VR104	18T42532U02	Rotary 10KA (Output Level)
VR109	18C41732G08	Variable 22K ohm-B
VR110	18C41732G08	Variable 22K ohm-B
VR111	18C41732G08	Variable 22K ohm-B
VR112	18C41732G08	Variable 22K ohm-B
VR113	18T45040F15	Variable 22K ohm
VR114	18T45040F15	Variable 22K ohm

●: For multi-voltage model only ■: For single voltage model only Others: Common

Symbol No.	Part No.	Description
VR115	18C41732G09	Variable 47K ohm
VR116	18C41732G09	Variable 47K ohm
VR117	18C41732G09	Variable 47K ohm
VR118	18C41732G09	Variable 47K ohm
VR119	18C41732G09	Variable 47K ohm
VR120	18C41732G09	Variable 47K ohm
VR121	18C41732G06	Variable 10K ohm-B
VR122	18C41732G06	Variable 10K ohm-B
VR123	18C41732G08	Variable 22K ohm-B
VR124	18C41732G08	Variable 22K ohm-B
VR125	18C41732G06	Variable 10K ohm-B
VR126	18C41732G06	Variable 10K ohm-B
VR127	18C41732G03	Variable 4.7K ohm-B
VR128	18C41732G03	Variable 4.7K ohm-B
VR129	18C41732G14	Variable 330 ohm-B
VR131	18C41732G09	Variable 47K ohm
VR132	18C41732G09	Variable 47K ohm
VR133	18T45040F05	Variable 470 ohm-B
VR134	18T45040F05	Variable 470 ohm-B
TH103	48S42931U34	Thermister 10K ohm
TH104	48S42931U34	Thermister 10K ohm
Level Gain Adjustment P.C. Board		
Transistors		
Q177 or Q178 or Q202	48T42538U01 48T42538U02 48T42538U01 48T42538U02 48T40081T03	2SK127-Q 2SK127-R 2SK127-Q 2SK127-R 2SA733 (P)
Q203 Q204	48T42943U01 48T42943U01	2SC1684-R 2SC1684-R
Diodes & Capacitors		
D149 D150 C232	48S134816 48S134816 23D44333G01	1S1555 1S1555 Electrolytic 1 uF/50V

Symbol No.	Part No.	Description
Resistors		
R509	6S40151T11	75K ohm
R510	6S40151T11	75K ohm
R607	6S40151T38	1M ohm
R608	6S40151T38	1M ohm
R609	6S40151T14	100K ohm
R610	6S40151T14	100K ohm
R611	6S40150T83	5.6K ohm
R612	6S40150T83	5.6K ohm
R613	6S40150T89	10K ohm
R614	6S40151T14	100K ohm
R615	6S40151T06	47K ohm
R616	6S40151T14	100K ohm
R617	6S40151T06	47K ohm
Shut-off P.C. Board		
Transistors		
Q701 or or or	48T42943U01 48T42943U02 48T40627U05 48T40627U04	2SC1684-R 2SC1684-S 2SD636-S 2SD636-R
Q702 or or or	48T42943U01 48T42943U02 48T40627U05 48T40627U04	2SC1684-R 2SC1684-S 2SD636-S 2SD636-R
Capacitors & Switch		
C710 C711 C712 C713 S111	23S41198U15 23S41198U09 8S44503P13 23S41198U28 40T40641U02	Electrolytic 22 uF/25V Electrolytic 4.7 uF/50V Mylar 0.01 uF Electrolytic 47 uF/25V Reed Switch
Resistors		
R713 R714 R715 R716 R717	6S44594P05 6S44593P97 6S44594P22 6S44593P89 6S44593P75	43K ohm 22K ohm 220K ohm 10K ohm 2.7K ohm
R719 R720 R721 R722	6S44593P83 6S44593P75 6S44593P73 6S44594P14	5.6K ohm 2.7K ohm 2.2K ohm 100K ohm

Symbol No.	Part No.	Description
Control P.C. Board		
IC's		
IC701 IC702	51T40471U01 51T40242T01	TC-9121P MC14011BCP
Transistors		
Q703 or or or	48T42943U01 48T42943U02 48T40627U05 48T40627U04	2SC1684-R 2SC1684-S 2SD636-S 2SD636-R
Q704 or or or	48T42943U01 48T42943U02 48T40627U05 48T40627U04	2SC1684-R 2SC1684-S 2SD636-S 2SD636-R
Q705 or or or	48T42943U01 48T42943U02 48T40627U05 48T40627U04	2SC1684-R 2SC1684-S 2SD636-R 2SD636-R
Q706 or or or	48T42943U01 48T42943U02 48T40627U05 48T40627U04	2SC1684-R 2SC1684-S 2SD636-S 2SD636-R
Q707 or or	48T44653P01 48S40662G05 48T42620F03	2SC790-Y 2SD235-Y 2SD880
Q708 or or or	48T42943U01 48T42943U02 48T40627U05 48T40627U04	2SC1684-R 2SC1684-S 2SD636-S 2SD636-R
Q709 or or or	48T42943U01 48T42943U02 48T40627U05 48T40627U04	2SC1684-R 2SC1684-S 2SD636-S 2SD636-R
Q710 Q711 or Q712 or	48T40469U01 48T52548F01 48T52547F01 48T52546F01 48T52549F01	2SC1983 2SA684NC-S 2SB793A-S 2SC1384NC-S 2SD973A-S
Q713 or Q714 or	48T52548F01 48T52547F01 48T52546F01 48T52549F01	2SA684NC-S 2SB793A-S 2SC1384NC-S 2SD973A-S

Symbol No.	Part No.	Description
Q715 or or or	48T42943U01 48T42943U02 48T40627U05 48T40627U04	2SC1684-R 2SC1684-S 2SD636-S 2SD636-R
Q716 or or or	48T42516U03 48T42516U04 48T42516U05 48T42516U06	2SD361-D1 2SD361-D2 2SD361-E1 2SD361-E2
Q717 or or or	48T42943U01 48T42943U02 48T40627U05 48T40627U04	2SC1684-R 2SC1684-S 2SD636-S 2SD636-R
Q718 or or or	48T42516U03 48T42516U04 48T42516U05 48T42516U06	2SD361-D1 2SD361-D2 2SD361-E1 2SD361-E2
Q719 or or or	48T42943U01 48T42943U02 48T40627U05 48T40627U04	2SC1684-R 2SC1684-S 2SD636-S 2SD636-R
Q720 or or or	48T42943U01 48T42943U02 48T40627U05 48T40627U04	2SC1684-R 2SC1684-S 2SD636-S 2SD636-R
Q721 or or or	48T42943U01 48T42943U02 48T40627U05 48T40627U04	2SC1684-R 2SC1684-S 2SD636-S 2SD636-R
Q722 or or or	48T42943U01 48T42943U02 48T40627U05 48T40627U04	2SC1684-R 2SC1684-S 2SD636-S 2SD636-R
Q723 or or or	48T42943U01 48T42943U02 48T40627U05 48T40627U04	2SC1684-R 2SC1684-S 2SD636-S 2SD636-R
Q724 or or or	48T42943U01 48T42943U02 48T40627U05 48T40627U04	2SC1684-R 2SC1684-S 2SD636-S 2SD636-R
Q725 or or or	48T42943U01 48T42943U02 48T40627U05 48T40627U04	2SC1684-R 2SC1684-S 2SD636-S 2SD636-R

Symbol No.	Part No.	Description
D814 or D815 or	48C40235G02 48T40477U01 48C40235G02 48T40477U01	10E2 1N4003 10E2 1N4003
D816 or D817 or	48C40235G02 48T40477U01 48C40235G02 48T40477U01	10E2 1N4003 10E2 1N4003
D818 or D819 or	48C40235G02 48T40477U01 48C40235G02 48T40477U01	10E2 1N4003 10E2 1N4003
ZD801 or	48T40150U85 48T40150U86	Zener HZ24-1 Zener HZ24-2
Fuses		
● E9 ● E10 ● E11 ● E12 ● E13	65T42077U13 65T42077U14 65T42077U16 65T42077U16 65T42077U17	Semko (500mA) Semko (630mA) Semko (1A) Semko (1A) Semko (1.25A)
Capacitors		
C801 C802 C803 C804 C805	23S41198U59 23S41198U28 8S44505P45 23S41198U12 23S41198U35	Electrolytic 470 uF/50V Electrolytic 47 uF/25V Ceramic 470 pF Electrolytic 10 uF/50V Electrolytic 100 uF/25V
C806 C807 C808 C809 C810	8S44505P45 23T40429U03 23S41198U71 23S41198U71 23S41198U71	Ceramic 470 pF Electrolytic 2200 uF/50V Electrolytic 2200 uF/16V Electrolytic 2200 uF/16V Electrolytic 2200 uF/16V
C811 C812 C813	23S41198U36 23S41198U36 23S41198U35	Electrolytic 100 uF/35V Electrolytic 100 uF/35V Electrolytic 100 uF/25V

Symbol No.	Part No.	Description
Resistors		
R801 R802 R803 R804 R805	6S44593P93 6S44593P81 6S44593P78 6S44593P97 6S44593P69	15K ohm 4.7K ohm 3.6K ohm 22K ohm 1.5K ohm
R806 R807 R808 R809 R810 R811	6S44593P69 6S44593P97 6S44594P02 6S44594P02 6S44594P02 6S44594P02	1.5K ohm 22K ohm 33K ohm 33K ohm 33K ohm 33K ohm
Deck P.C. Board		
Posistor & Diode		
PS701 D723	48T40412F01 48C40235G01	PTH63U470M 10E1
Resistors		
R781 R790	6D40801G31 6S40107T38	47 ohm 1/2W 75 ohm
Miscellaneous Parts		
D722 E101 or E102 or E103 E104 or E107 E108 E109 E110 ● E112 ○ E201 △ ■	48C40235G01 9T43887U01 9T42868F04 9T43887U01 9T42868F04 9B44393P01 9T41183U01 9T42868F02 72T43118U01 72T43118U01 88T41139U02 88T44524U01 9B40429G01 28T50179F01 28T45338F01 28T40916U01	Diode 10E1 Jack, Mic Jack, Mic Jack, Mic Jack, Mic Plate, Phone Jack, Headphone Jack, Headphone Meter, Level Meter, Level Head, R/P Combination Head, Erase Socket, DIN (Rec. Monitor) Plug, AC Cord Plug, AC Cord Plug, AC Cord

●: For multi-voltage model only [○: General foreign model, △: Australian model],
 ■: For single voltage model only [North American model] Others: Common

Symbol No.	Part No.	Description
■ E202	9T42881U01	AC Outlet
● E203	25T44530U01	Transformer, Power
■	25T42450U01	Transformer, Power
E204	59T42144U01	Motor DC
E205	1T42119U01	Assembly, Solenoid
or	1T42754U01	Assembly, Solenoid
E206	1T43963F01	Assembly, Solenoid
E207	40T45648F01	Switch, Micro
E209	40T45648F01	Switch, Micro
E210	59T42145U01	Motor, DC
E211	1T42517U01	Assembly, Connector (Keyboard)
E212	1T50916F01	Assembly, DIN Sicket 8p (Keyboard)
L801	65C42544U03	Lamp, Pilot
L802	65T40367F01	Lamp
L803	65T40367F01	Lamp
L804	65T40367F01	Lamp
L805	65T40367F01	Lamp
LED701	48T40585F01	LED (Grn) (Memory)
LED702	48T40585F01	LED (Grn) (AUTO Rew)
LED703	48T40585F01	LED (Grn) (AUTO Play)
LED704	48T40058F01	LED (Grn) (Pause)
LED705	48T40058F01	LED (Grn) (FF)
LED706	48T40058F01	LED (Grn) (Rew)
LED707	48T40059F01	LED (Red) (Rec)
LED708	48T40058F01	LED (Grn) (Play)
LED101	48T42674U01	LED (Grn) (Dolby NR)
LED102	48T43092U01	LED (Red) (Rec)
LED103	48T42674U02	LED (Red) (Rec Mute)
R101	6S44593P89	Resistor, Carbon Film 10K ohm
R102	6S44593P89	Resistor, Carbon Film 10K ohm
R203	6S44593P65	Resistor, Carbon Film 1K ohm
R204	6S44593P65	Resistor, Carbon Film 1K ohm
R629	6S44593P79	Resistor, Carbon Film 3.9K ohm
R630	6S44593P79	Resistor, Carbon Film 3.9K ohm
R710	6S44593P62	Resistor, Carbon Film 750 ohm
R711	6S44593P62	Resistor, Carbon Film 750 ohm
R712	6S44593P62	Resistors, Carbon Film 750 ohm

Symbol No.	Part No.	Description
S101	40T42530U01	Switch, Slide (Test OSC)
S106	40T42520U01	Switch, Push (Rec. Mute)
S701	40T42522U01	Switch, Timer
S702	40T42521U01	Switch, Keyboard (Rew. FF. Play, Rec. Pause) (This switch consists of Cabinet assembly parts symbol No. (37) and (38))
?		
S707		
S708	40T42521U01	Switch, Push (Auto Play/Rew, Memory)
S709		
S710		
● S801	40B41998P02	Switch, Power
■	40T43485U01	Switch, Power
● S802	40T40705T01	Switch, Voltage Select
TH101	48S42931U33	Thermistor, 5.0K ohm
VR105	18T42534U02	Volume, Rotary (Rec. CAL)
VR106	18T42534U02	Volume, Rotary (Rec. CAL)
VR107	18T42534U01	Volume, Rotary 250 (Bias Fine)
VR108	18T42534U01	Volume, Rotary 250 (Bias Fine)
VR130	18T42535U01	Volume, Rotary 500B (Pitch Control)
■ C814	8C42962P07	Capacitor Metal 0.01 uF/125V

●: For multi-voltage model only ■: For single voltage model only Others: Common

Packing Assembly Parts List

Symbol No.	Part No.	Description
401	56D41118J27	Pad, Bulk Packing
402	1V43100U78	Assembly, Pamphlet
402-1	1V44200J30	Assembly, Kit
402-1-1	28C42374J02	Cord Output
402-1-2	56B40230G16	Sack, Polyethylene
402-2	56B40230G14	Sack, Polyethylene
402-3	68P44360P87	Manual, Owners
402-4	30T42882U01	Cord, DIN
402-5	75A44469P01	Tip, Head Cleaning
403	56C41187F02	Tray, Packing
404	56B40442T03	Packing, Front Frame
405	56A41224F01	Tray, Packing
406	56C41187F01	Tray, Packing
● 407	56C42357F02	Carton, Packing
■ 408	56C42357F01	Carton, Packing
408	15A41885U01	Cover, Door

Symbol No.	Part No.	Description
Labels		
	54B42124G02	Label, Date Code (Bottom Chassis)
	54B42124G01	Label, Serial No. (Rear Cover)
○	54B42541F07	Label, Safety (Rear Cover)
△	54A50155F01	Label, AS (Carton, Packing)
■	54A41728P01	Label, Caution
■	54B43264P01	Label, Warning
■	54A44553G01	Label, CSA.

●: For multi-voltage model only [○: General foreign model, △: Australian model],
 ■: For single voltage model only [North American model] Others: Common

Packing Method View

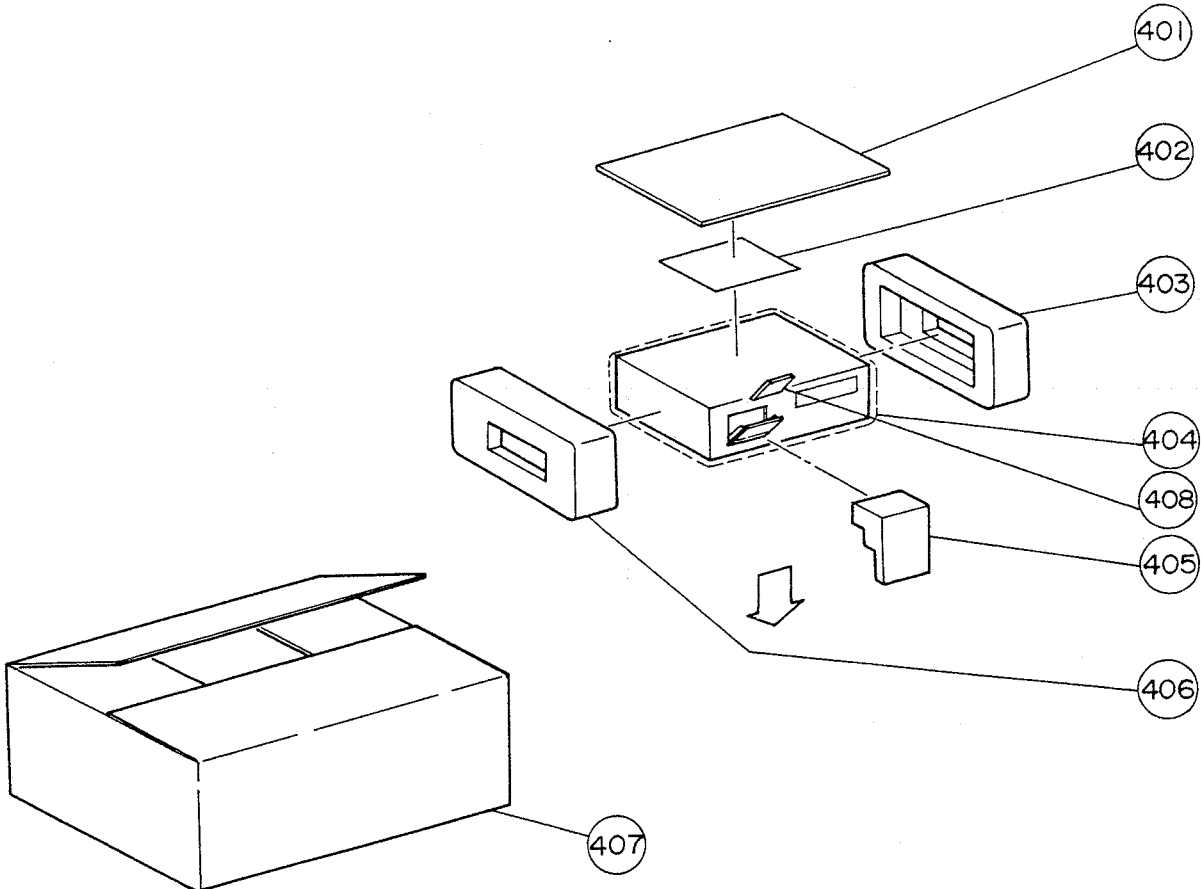

Exploded View (Cabinet)

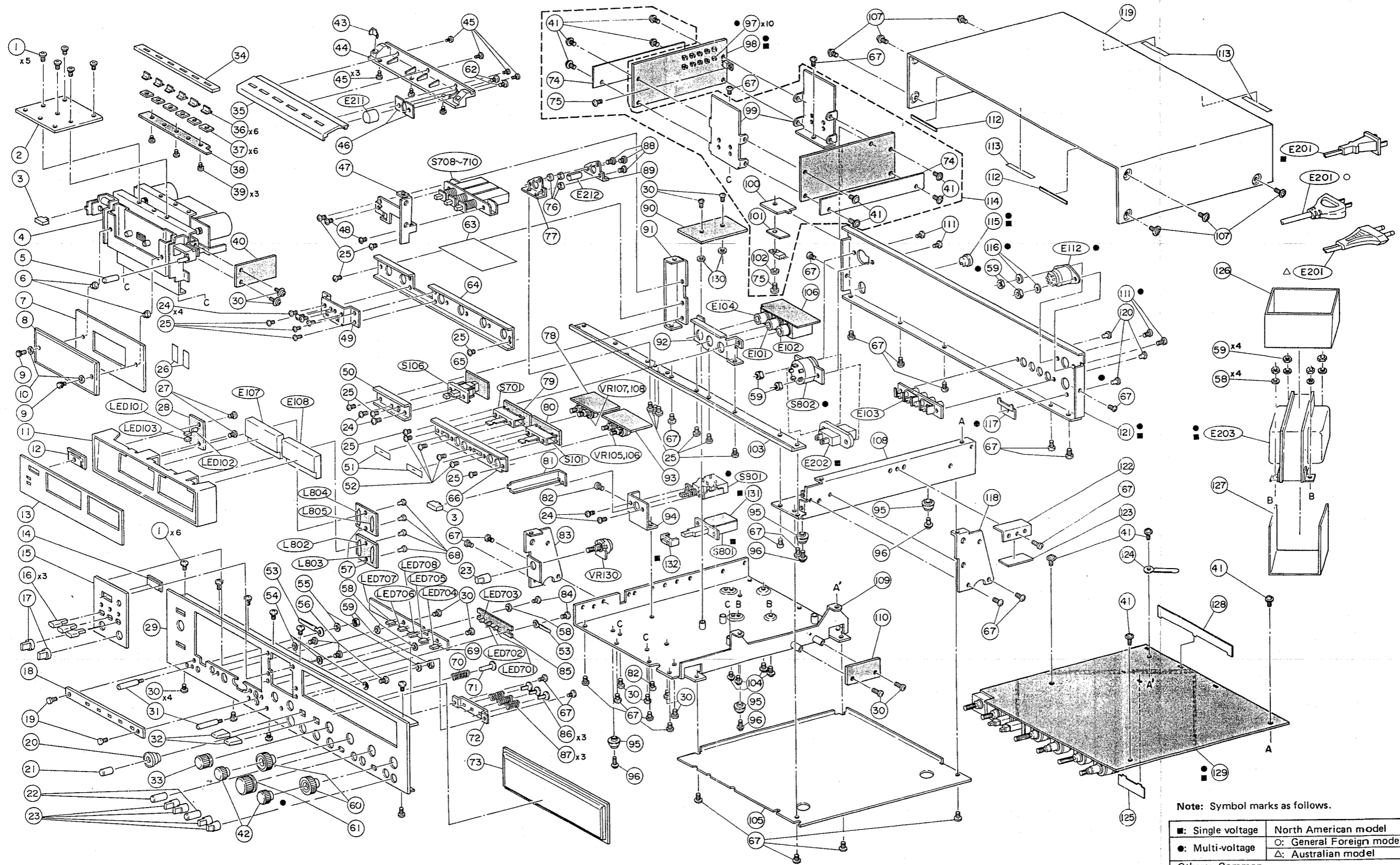

Note: Symbol marks as follows.

■	Single voltage	North American model
●	Multi-voltage	○: General Foreign model
△		Australian model
Others: Common		

Cabinet Assembly Parts List

Symbol No.	Index	Part No.	Description
1	1-A	3S44205G16	Screw, Tap Tite (M3 x 6)
2	2-A	7A42471U01	Support, Deck
3	2-A	36B42462U01	Knob, Push
4	2-A	81D42120U01	Deck, Cassette (FA87M010)
5	2-A	36A42497U01	Knob, Counter
6	2-A	46A42953U01	Stud, Door Panel
7	2-A	64B42457U01	Panel, Door
8	3-A	7A42494U01	Frame, Door
9	3-A	3A42493U01	Screw, Special
10	3-A	4A41014U01	Washer, Rubber
11	3-A	7C42467U01	Frame, Meter
12	3-A	7A41247U01	Frame, Peak Level
13	4-A	64B42461U01	Plate, Meter
14	4-A	61A41340U01	Lens, Counter
15	4-A	64A42460U01	Panel, Counter
16	4-A	36A42961U01	Knob, Push Switch
17	4-A	36B42504U01	Knob, Rotary Switch
18	4-A	64A42458U01	Panel, Indicator
19	5-A	3A42509U01	Screw, Special
20	5-A	13A42502U01	Medallion, Rec. Mute
21	5-A	36A42499U01	Knob, Rec. Mute
22	5-A	36A42464U01	Knob, Slide Switch
23	5-A	36A42492U01	Knob, Control
24	2-A	3C40014G04	Screw, Machine (M3 x 6)
25	3-A	3A43852J02	Screw, F.T. (M2.5 x 5)
26	3-A	15A42952U01	Cover, Switch
27	3-A	3S40012G28	Screw, Tapping (M3 x 8)
28	3-A	84D42528U06	Panel, LED
29	4-A	64D42456U02	Panel, Front
30	5-A	3S44205G38	Screw, Tap Tite (M3 x 6)
31	5-A	47A42495U01	Shaft, Cassette Control
32	5-A	36B43812U01	Knob, Lever
33	5-A	36B42505U01	Knob, Control
34	1-B	7B42466U01	Frame, Rubber Switch
35	1-B	64B42459U01	Panel, Control
36	1-B	36A42463U01	Knob, Cassette Control
37	2-B	40A42511U01	Switch, Rubber
38	2-B	84B42518U01	Panel, Keyboard
39	2-B	3S40012G51	Screw, Tapping (M2.6 x 5)
40	2-B	1V51700F18	Assembly, Shat off Panel

Symbol No.	Index	Part No.	Description
41	1-D	3C42723U01	Screw, Cup (M3 x 6)
42	5-B	36B42508U01	Knob, Control (R)
43	1-C	41A40391F01	Spring, Lock
44	1-C	7C42465U01	Frame, Cassette Control
45	1-C	3S43997P23	Screw, Machine (M2 x 3)
46	2-B	46A42475U01	Stopper, DIN Jack
47	2-B	7B42477U01	Bracket, Push Switch
48	2-B	3S40011G42	Screw, Machine (M3 x 5)
49	3-B	7A42479U01	Bracket, Switch Lever
50	3-B	7A42480U01	Bracket, Rec. Mute Switch
51	3-B	15A42952U02	Cover, Switch
52	3-B	3S40011G31	Screw, Machine (M2.6 x 4)
53	4-B	29C41045P02	Lug, Wrap Around
54	4-B	4S40070G05	Washer
55	4-B	4S40071G01	Washer, Lock Spring
56	4-B	3S40011G06	Screw, Machine (M2.6 x 6)
57	4-C	84B43907U01	Panel, Meter Lamp
58	4-C	4S40070G13	Washer
59	4-C	2S40000G12	Nut, Hex. (M3 x 0.5)
60	5-C	36B42507U01	Knob, Control (L)
61	5-C	36B42506U01	Knob, Control
62	1-C	3S40011G18	Screw, Machine (M3 x 6)
63	2-C	14B43672U03	Fiber, Insulator
64	2-C	7B42478U01	Bracket, Volume Switch
65	3-C	84D42514U04	Panel, Rec. Mute
66	3-C	7A42482U01	Bracket, Slide Switch
67	4-C	3S44205G40	Screw, Tap Tite (M3 x 4)
68	4-C	5B41635J03	Rivet, Push
69	4-C	84D42514U03	Panel, Knob Indicator
70	4-C	41A42501U01	Spring, Rec. Mute
71	5-C	45A42515U01	Lever, Rec. Mute
72	5-C	7A42489U01	Support, Push Switch
73	5-C	61A42503U02	Crystal, Meter
74	1-D	26A40069F01	Shield, Control Panel
75	1-D	3S44205G01	Screw, Tap Tite (M3 x 6)
76	2-D	46A42981U01	Stud, DIN Jack
77	2-D	7A42474U01	Support, DIN Jack
78	3-D	84D42528U04	Panel, Bias Fine
79	3-D	84D42514U06	Panel, Time Switch
80	3-D	84D42528U03	Panel, Tone Switch

Symbol No.	Index	Part No.	Description
81	3-D	45A42487U01	Lever, Power Switch
82	4-D	3S44205G05	Screw, Tap Tite (M3 x 5)
83	4-D	7B42483U02	Bracke, Slide (L)
84	4-D	3S44204G04	Screw, Tap Tite (M3 x 5)
85	4-D	84D42514U05	Panel, Memory Indicator
86	5-D	45A42488U01	Lever, Push Switch
87	5-D	41A42498U01	Spring, Push Switch
88	2-D	3A43852J04	Screw, F.T. (M2.5 x 6)
89	2-D	7A42474U02	Support, DIN Jack
90	2-D	84D42514U08	Panel, Terminal
91	2-D	7A42476U01	Bracket, Center
92	3-D	7A42481U01	Bracket, Mic Jack
93	3-D	84D42528U05	Panel, Dolby Cal
94	4-D	7A42470U01	Bracket, Power Switch
95	5-D	75A42510U01	Pad, Rubber
96	5-D	3S40036U03	Screw, Tap Tite (M3 x 6)
97	1-E	9A40961P01	Holder, Fuse
98	1-E	1V51700F16	Assembly, Power Panel
99	1-E	1V53700F85	Assembly, Power Panel
100	2-E	7B42469U01	Bracket, Panel
101	2-E	7A44349P01	Bracket, Heat Sink
102	2-E	14A40472G02	Insulator, Transistor
103	2-E	43A43002U01	Spacer, Transistor
104	3-E	7B42473U01	Support, Slave Unit
105	5-E	3S40036U02	Screw, Tap Tite (M3 x 8)
106	5-E	15C42484U01	Cover, Bottom
107	2-E	84D42528U02	Panel, Jack
108	1-F	3S40036U01	Screw, Tap Tite (BIK)
109	3-F	7C42472U01	Bracket, Right
110	4-F	27C42468U01	Chassis, Bottom
111	4-F	1V41800F47	Assembly, Level Gain Adjustment
112	2-F	3S40011G93	Screw, Machine (M3 x 8)
113	1-F	75B44632G05	Pad, Cushion
114	2-F	75B44632G04	Pad, Cushion
115	2-F	1V51700F15	Assembly, Control Panel
116	2-F	43B41625J02	Stopper, Cord
117	2-F	43B41625J01	Stopper, Cord
118	2-F	4S40070G01	Washer (3.8 x 9 x 1)
119	3-F	7A40703T01	Support, DIN
120	4-F	7B42483U01	Bracket, Side (R)
121	1-G	15D42486U01	Cover, Top
122	3-G	5B41635J02	Rivet, Push

Symbol No.	Index	Part No.	Description
121	3-G	15D42485U03	Cover, Rear
122	3-G	15D42485U02	Cover, Rear
123	3-G	7A50526F01	Bracket, Panel
124	4-G	14A50527F01	Panel, Insulator
125	4-G	29C41045P03	Lug, Wrap Around
126	5-G	7A42249U02	Bracket, Shield
127	2-H	26A40450F01	Shield, Inside Magnetic
128	3-H	26A44579F01	Shield, Magnetic
129	4-H	26A44441U01	Shield, Plate
130	5-H	1V51700F20	Assembly, Master Board
131	5-H	1V53700F86	Assembly, Master Board
132	2-E	4A40067T01	Washer Fiber
133	4-E	84D42528U07	Panel, Power Switch
134	4-D	36A44465P01	Spacer, Switch

●: For multi-voltage model only ■: For single voltage model only Others: Common

Exploded View (Cassette Deck)

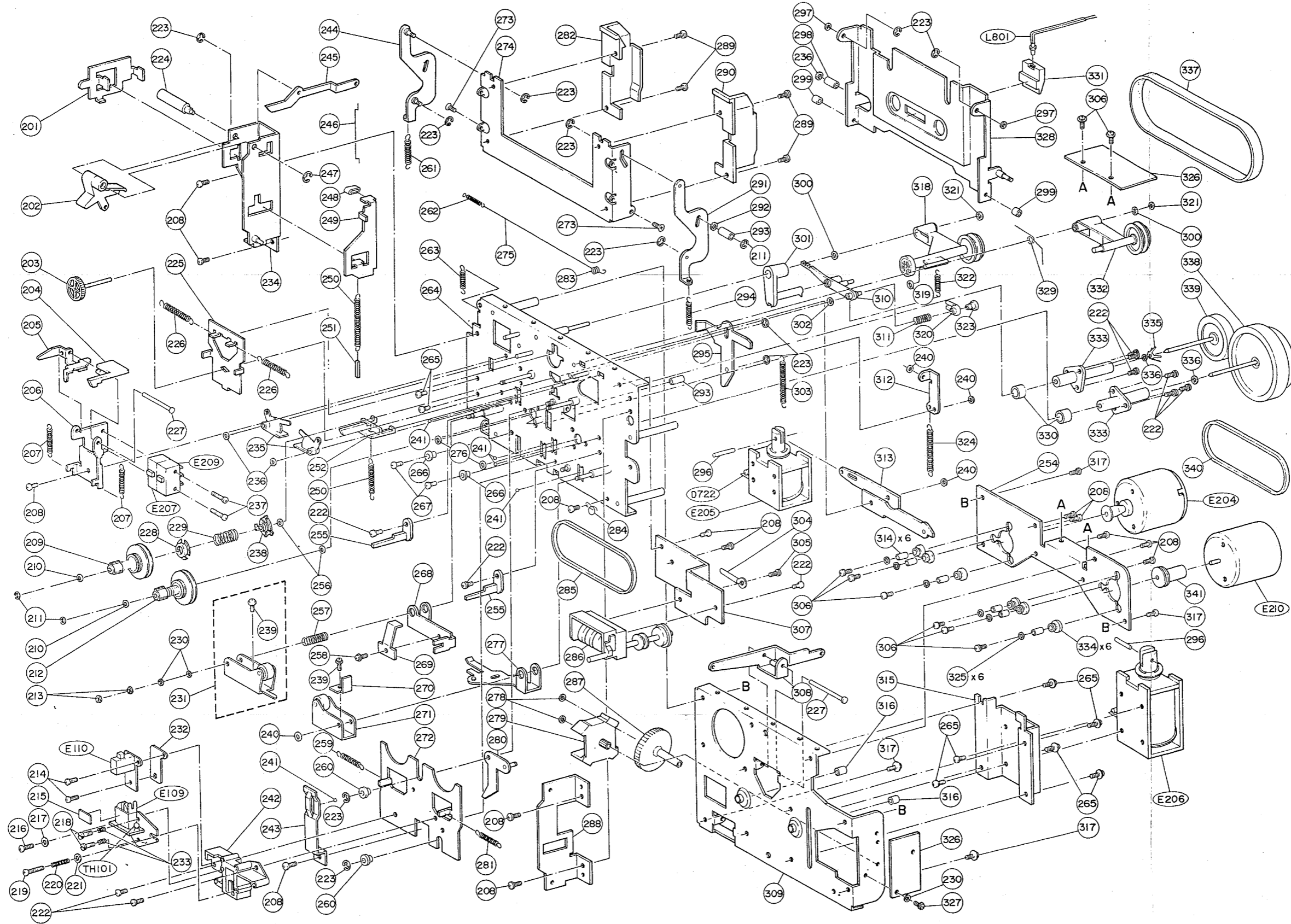

Cassette Deck Assembly Parts List

Symbol No.	Index	Part No.	Description
201	1-A	45A41932U01	Lever, Eject
202	2-A	45A41933U01	Arm, Eject
203	2-A	49T41970U01	Pulley, FF Idler
204	2-A	45B42011U01	Arm, Switch
205	2-A	7A41944U01	Bracket, Record Sensor
206	3-A	7A41942U01	Bracket, Micro Switch
207	3-A	41B41492U12	Spring, Pull
208	3-A	3S44205G01	Screw, Tap Tite (M3 x 6)
209	3-A	49T41448U01	Reel, Supply
210	4-A	4S40075G05	Washer, S.T.W.
211	4-A	4C42091G06	Washer, "C"
212	4-A	49T41447U01	Reel, Take-up
213	4-A	2S40000G12	Nut, Hex (M3 x 0.5)
214	5-A	3C40014G07	Screw, Machine (M2 x 4)
215	5-A	54A43085U01	Label, Head
216	5-A	3S40019G08	Screw, F-Lock (M2 x 10)
217	5-A	4A41071F03	Washer
218	5-A	3A51252F01	Screw, Adjustment
219	5-A	3S40011G75	Screw, Machine (M2 x 14)
220	5-A	41A41490U01	Spring, Azimuth
221	5-A	4S40070G33	Washer, Flat
222	5-A	3C40014G04	Screw, Machine (M3 x 6)
223	1-B	4C42091G05	Washer, "C"
224	1-B	47A42031U01	Shaft, Eject Arm
225	2-B	45B41935U01	Lever, Brake
226	2-B	41B41492U03	Spring, Pull
227	3-B	47A41173U02	Shaft, Record Sensor
228	3-B	49A42898U01	Wheel, Tension A
229	3-B	41A42895U01	Spring, Push
230	4-B	4S40075G13	Washer, S.T.W.
231	4-B	1A41516U03	Assembly, Pinch Roller
232	4-B	43A40595F01	Spacer, Erase Head
233	5-B	41A51253F01	Spring, Adjustment
234	2-B	1A42044U01	Assembly, Door Bracket Rivet (L)
235	3-B	45A41095U01	Arm, Brake
236	3-B	4A41345P02	Washer, Lock
237	3-B	3S40011G85	Screw, Machine (M2 x 15)
238	4-B	49B42899U01	Wheel, Tension B
239	4-B	3S40019G03	Screw, F-Lock (M2 x 4)
240	4-B	4A41345P03	Washer, Lock

Symbol No.	Index	Part No.	Description
241	5-B	43A41182P02	Ball, Steel
242	5-B	46B41972U01	Block, Head
243	5-B	41A41947U01	Spring, Head Base
244	1-C	1B42046U02	Assembly, Door Arm Rivet
245	1-C	1A42049U01	Assembly, Stopper Rivet
246	1-C	47A42110U01	Rod, Link
247	2-C	4C42091G04	Washer, "C"
248	2-C	75A42964U01	Pad, Brake
249	2-C	64A41931U01	Plate, Door Lock
250	2-C	41B44327P07	Spring, Pull
251	2-C	75A40913F01	Pad, Cushion (33mm)
252	3-C	45A41946U01	Arm, Cassette Holder
254	3-G	7A41971U01	Bracket, Motor
255	3-C	43A41096U01	Guide, Cassette
256	4-C	4S40075G06	Washer, S.T.W.
257	4-C	41A42895U02	Spring, Push
258	4-C	3S40019G01	Screw, F-Lock (M2 x 3)
259	5-C	41B43676U06	Spring, Pull
260	5-C	43A42023U01	Sleeve
261	2-C	41B43676U03	Spring, Pull
262	2-C	41A43685U01	Spring, Dumper
263	2-C	41A40594F01	Spring, Eject Lever
264	2-C	1C42041U01	Assembly, Chassis Rivet
265	3-C	3S40019G29	Screw, F-Lock
266	3-C	43A42115U01	Spacer, Head Base
267	3-C	3S44205G03	Screw, Tap Tite (M3 x 4)
268	4-C	7A41963U01	Bracket, Pinch Roller
269	4-C	41A43675U01	Spring, Pinch Push
270	4-C	41A42351U02	Spring, Pinch Roller Bracket
271	4-C	1A41990U01	Assembly, Pinch Roller Bracket
272	5-C	1A42047U01	Assembly, Head Base Rivet
273	1-D	3S43997P59	Screw, Machine (M3 x 8)
274	1-D	1A42054U01	Assembly, Door Frame
275	2-D	30S43803G05	Cord, Dial
276	3-C	43A44803P01	Washer, Oil Shield
277	4-C	7A41936U01	Bracket Pinch Roller
278	4-C	4A41345P01	Washer, Lock
279	4-C	44B40207T01	Gear, Drive
280	5-C	1A42048U01	Assembly, Cam Rivet

Symbol No.	Index	Part No.	Description
281	5-C	41B43676U02	Spring, Pull
282	1-D	15C41130U01	Holder, Chassis
283	2-D	41A43688U01	Spring, Cord
284	3-D	42A44230U01	Lug, Wrap Through
285	4-D	42A41387U01	Belt, Counter
286	4-D	72T41308U02	Counter, Tape
287	4-D	44B40208T01	Gear, Drive
288	5-D	1A42045U01	Assembly, Door Bracket Rivet
289	1-E	3S44205G04	Screw, Tap Tite (M3 x 5)
290	1-E	15C41130U02	Holder, Chassis
291	2-E	1B42046U01	Assembly, Door Arm Rivet
292	2-E	4S40075G12	Washer
293	2-E	75A44238P01	Pad, Bracket
294	2-E	41B41492U05	Spring, Pull
295	3-E	45A41958U01	Cam, Idler Clutch
296	3-E	22B40232G02	Spring, Pin
297	1-E	4S40075G18	Washer, S.T.W.
298	1-E	43A43966F01	Spacer, Support
299	1-E	43A42035U01	Spacer, Door
300	2-E	4S40075G24	Washer
301	2-E	45A41938U01	Arm, Idler A
302	2-E	4A43020G12	Washer
303	3-E	41A42109U01	Spring, Clutch Cam
304	3-E	29A737272	Lug, Wrap Around
305	4-E	3C40014G22	Screw, Machine (M3 x 8)
306	4-E	3C40121T04	Screw, Machine (M2.6 x 7)
307	4-E	7A41953U01	Bracket, Counter
308	4-E	1A42051U01	Assembly, Solenoid Lever Rivet
309	5-E	1B42042U01	Assembly, Sub Chassis Rivet
310	2-F	45A42256F01	Arm, New Idler
311	2-F	41A42372F01	Spring, F/R Clutch
312	3-F	45A41959U01	Link, Forward
313	3-F	45A41957U01	Lever, Sub Solenoid
314	4-F	43A41289U02	Sleeve, Cushion
315	4-F	7A41950U01	Bracket, Main Solenoid
316	4-F	3A41166U01	Screw, Bearing
317	5-F	3S40019G32	Screw, F-Lock
318	2-F	45T47014F01	Clutch, FF
319	2-F	4S40070G11	Washer
320	2-F	45A42341F01	Arm, Clutch
321	2-F	4A41345P05	Washer, Lock
322	2-F	41A45695F01	Spring, Idler
323	2-F	49A42078F01	Disk, Clutch
324	3-F	41B43676U01	Spring, Pull
325	4-F	4S40075G19	Washer

Symbol No.	Index	Part No.	Description
326	5-F	1V42600U05	Assembly, Deck Panel
327	5-F	3C40014G09	Screw, Machine (M3 x 5)
328	1-G	1A42043U01	Assembly, Cassette Support Rivet
329	2-G	41A42111U01	Spring, Clutch
330	3-G	75A44231U01	Cushion Head Base
331	1-G	61A41165U01	Lens, Back Light
332	2-G	45T41964U01	Clutch, Play
333	3-G	15A41956U01	Housing, Capstan
334	4-G	75A41685U01	Cushion, Motor
335	2-G	41A44528U01	Spring, Flywheel
336	3-G	4S40075G10	Washer, P.S.
337	1-G	42A41960U01	Belt, Main
338	2-G	49B41955U01	Flywheel, Capstan (R)
339	2-G	49A41954U01	Flywheel, Capstan (L)
340	3-G	42A41961U01	Belt, Sub
341	4-G	49A42113U01	Pulley, Motor

Semi-Conductor Lead Identifications

NE645N: OC101, 102, 103, 104

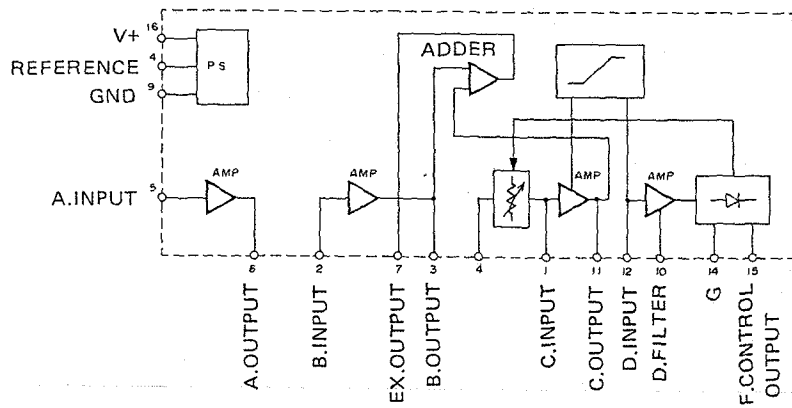
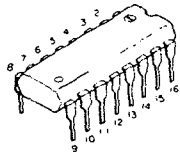

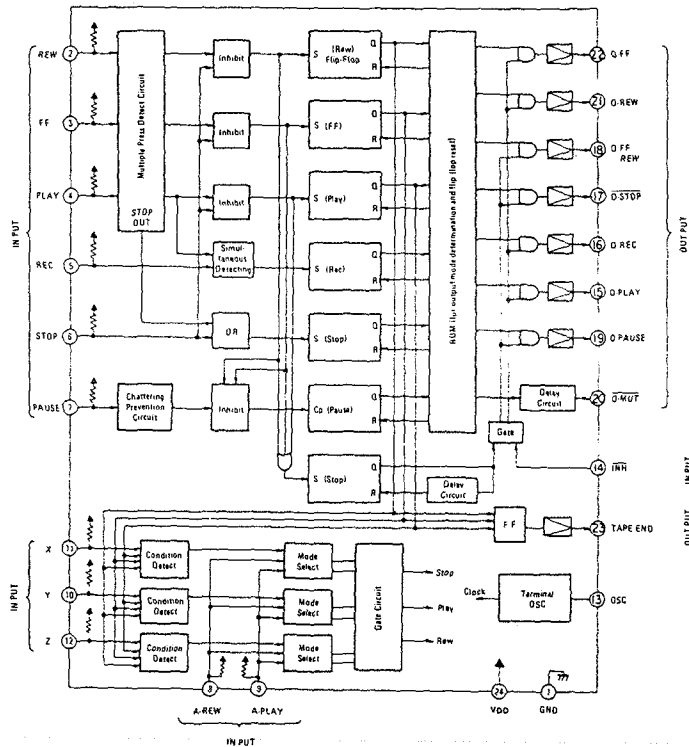
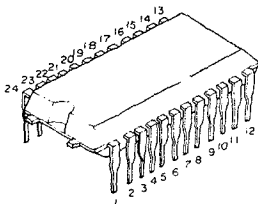

TC-9121P: IC701

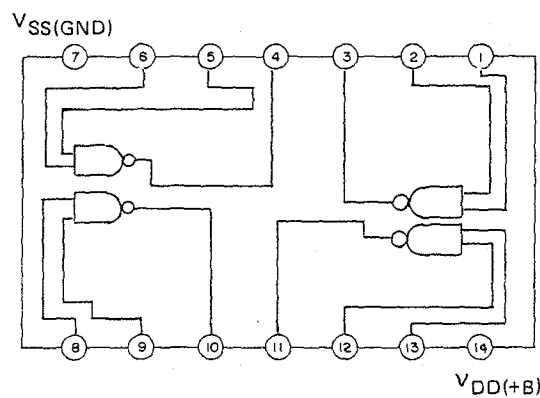
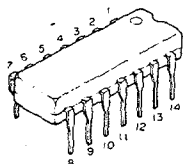

MC14011BCP: IC702

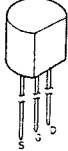
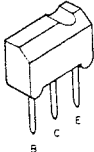
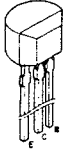
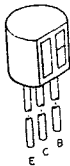

<p>2SC2263: Q101, 102, 103, 104, 151, 152, 155, 156 2SC1327: Q103, 104, 155, 156 2SC1684: Q107 to 112, 117 to 120, 123 to 128, 137, Q141, 142, 144, 148, 149, 157 to 164, Q169, 170, 173 to 176, 179 to 182, 184, Q187, 189, 190, 191, 193, 194, 199, 200, Q203, 204, 701, 702, 703 to 706, 708, 709, Q715, 717, 719 to 728, 802, 804 2SA564: Q121, 122, 165, 166, 183, 201 2SC1788: Q135, 136, 138, 171, 172, 186 2SA921: Q143, 185 2SA777: Q145, 150 2SD889: Q167, 168 2SA684: Q711, 713 2SC1384: Q712, 714</p> 	<p>2SK128: Q105, 106, 153, 154 2SK127: Q113 to 116, 133, 134, 146, 147, 177, 178, Q188, 197, 198</p> 	
<p>2SD636: Q107 to 112, 117 to 120, 123 to 128, 137, Q141, 142, 144, 148, 149, 157 to 164, 169, Q170, 173 to 176, 179 to 182, 184, 187, Q189, 190, 191, 193, 194, 199, 200, 701, Q702, 703 to 706, 708, 709, 715, 717, Q719 to 728, 802, 804 2SB641 or 2SB642: Q121, 122, 165, 166, 183, 201 2SD638: Q135, 136, 138, 171, 172, 186 2SD973: Q712, 714 2SB793: Q711, 713</p> 	<p>2SC1890: Q129 to 132, 139, Q140, 195, 196</p> 	
<p>2SA733: Q202</p> 	<p>2SD2350, 2SC790 or 2SD880: Q707 2SD2350 or 2SD880: Q801</p> 	<p>2SC1983: Q710</p> 
<p>2SD361: Q716, 718, 803</p> 