

# **AB INTERNATIONAL**

**MODELS 400 / 600A / 600LX  
(T)**

## **SERVICE INFORMATION**

**Amplified Design International, Inc.  
1830-6 Vernon Street / P.O. Box 1105  
Roseville, Ca 95678 / 916-783-7800**

## **General**

AB International amplifier products are designed to deliver uncompromised performance in continuous-duty commercial and professional audio applications. The following operating instructions cover the installation and operation of the model 600LX. New owners are encouraged to read the entire contents prior to placing amplifiers into service.

## **Circuit Description**

To assure absolute long term reliability, the output section of each channel incorporates 6 Toshiba Multiple Emitter Power Transistors, which provide 900 Watts of power dissipation per channel. The output stage is arranged in a quasi-complimentary format and biased for class AB/2 operation. The bias current is evenly distributed among all output devices. Bias thermal compensation is accomplished by thermally mating a bipolar semiconductor junction to the heat-producing output devices. Triple diffused high power driver transistors are employed along with high speed, high voltage silicon annular devices for the pre-driver and inverter stages. Utilization of these components provides the required separation of break points for absolute stability. Fully complimentary current source drive and loading is utilized throughout. Only 20 dB of negative feedback is used to reduce forward transfer distortion to minimum levels. VI type energy limiters are incorporated for short circuit protection of the amplifier. Due to the unusually large safe operating area of the output stage, the limiters do not actuate until driving a forty-five degree reactive load of under 2 ohms at full power.

## **Construction**

The 600LX is designed to an all-modular concept permitting rigorous pre-assembly module testing and maximum service accessibility. Each functional module is fully tested before final assembly. Although components of the highest quality are used throughout, each amplifier is burned in prior to shipment at the worst case operating point to eliminate any possibility of component malfunction. Six screws allow removal of the rear panel with the channel amp board intact. All chassis components are precision machined from high quality aluminum and sheet steel stock. The entire package concept is directed toward maximum efficiency of space and structure, accounting for the 600LX's compact size and light weight.

## Installation

All AB International amplifiers are designed for mounting in a standard 19-inch equipment rack, or one of the many 19-inch rack-type portable cases available. The model 600LX requires 5¼ inches of vertical panel space, with 11⅞ inches required behind the panel. Total depth, including handles, is 13-<sup>5</sup>/<sub>16</sub> inches. The front panel is machined from solid aluminum stock, with a black anodized grained finish and sturdy rack mount handles.

Placement of the amplifier is not critical for normal operating conditions, provided that sufficient air flow is allowed to reach the heatsink array. If the unit is to be placed on a shelf, or a similar unenclosed area, allow four inches clearance behind the heatsink to permit vertical air flow through the array. For installation in a cabinet, allow an additional *two inches above and one inch below the amplifier to permit air to be drawn around the back*. If the amplifier is to be mounted in an equipment rack or cabinet with heat-producing equipment, be sure that environmental operating temperatures do not exceed 55 degrees C (131 degrees F). Should over heating occur because of inadequate ventilation, the temperature protection circuitry will automatically protect the amplifier. When a safe operating temperature is restored, the amplifier will return to normal operation.

Because the 600LX is capable of delivering high power from a relatively small physical package, considerable heat can develop in cabinets containing several instruments. A good rule of thumb to adopt is to force-cool any enclosure containing four or more instruments.

## Power Connections

The 600LX includes a power transformer for operation from 100-125 volt 50-60Hz mains supply. (Option 220VAC 50-60Hz)

Equipment for domestic (USA) consumption includes a captive power cord with a three-pin polarized plug. **DO NOT REMOVE THE CENTER GROUNDING PIN.**

## **Power Connections (Cont'd)**

In new installations and portable sound systems, or any situation in which the main power is suspect, it is wise to confirm appropriate voltage and line polarity **BEFORE** connecting the instrument to power sources.

## **Thermal Protection**

Certain conditions of operation (restricted cooling airflow, sustained high power operation into low impedance loads) can result in a rise in output device case temperature sufficient to affect any amplifier's performance.

Should the heatsink reach 95 degrees C, the output will be automatically disconnected from the (loudspeaker) load, and will remain disconnected until the temperature drops to below 95 degrees C. The action of removing the load has the effect of eliminating the output current, which, in turn, results in an immediate and rapid drop in temperature. The load will automatically be reconnected when the temperature drops to below 95 degrees C.

# Rear Panel Connections

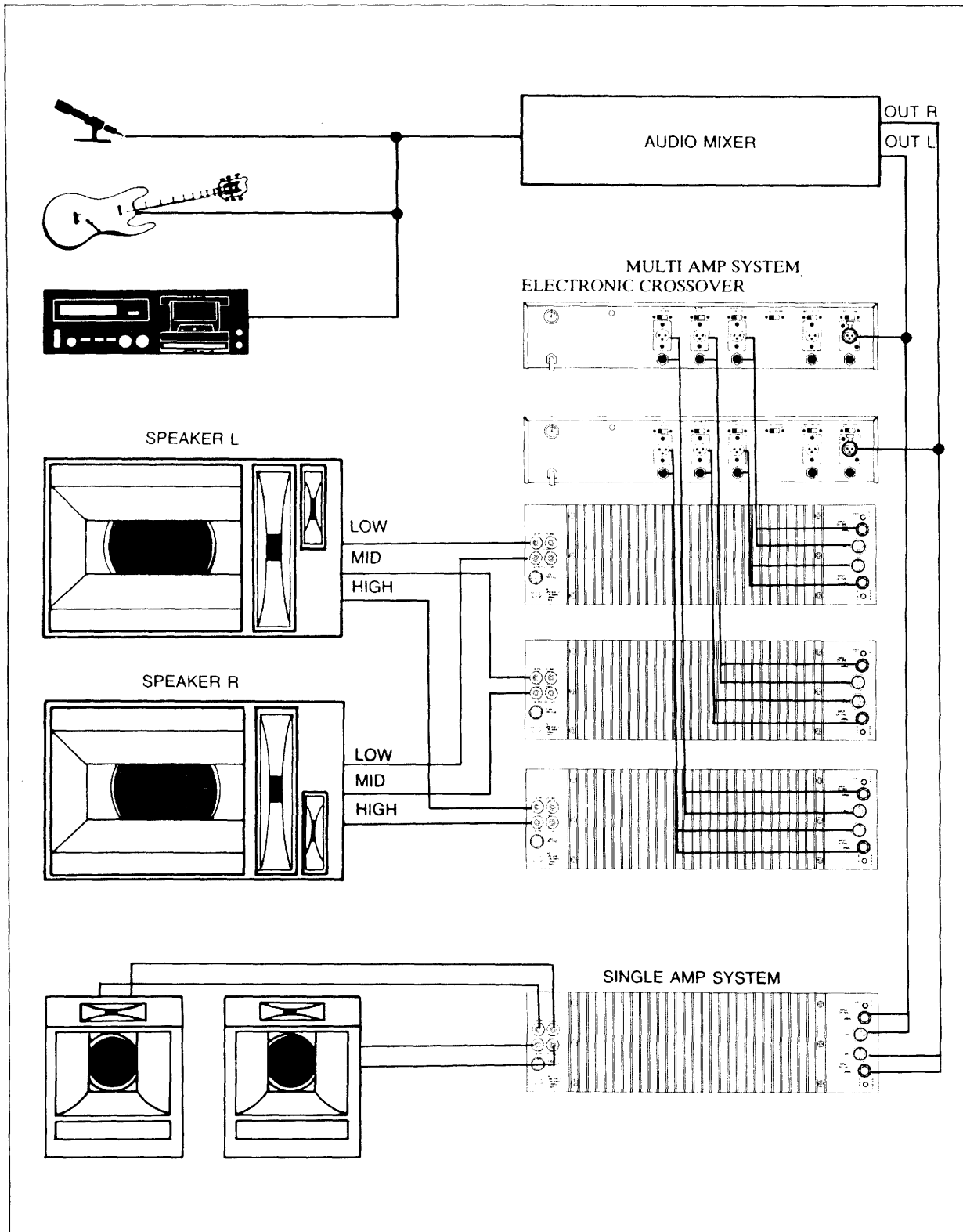

## Front Panel and Rear Panel Controls

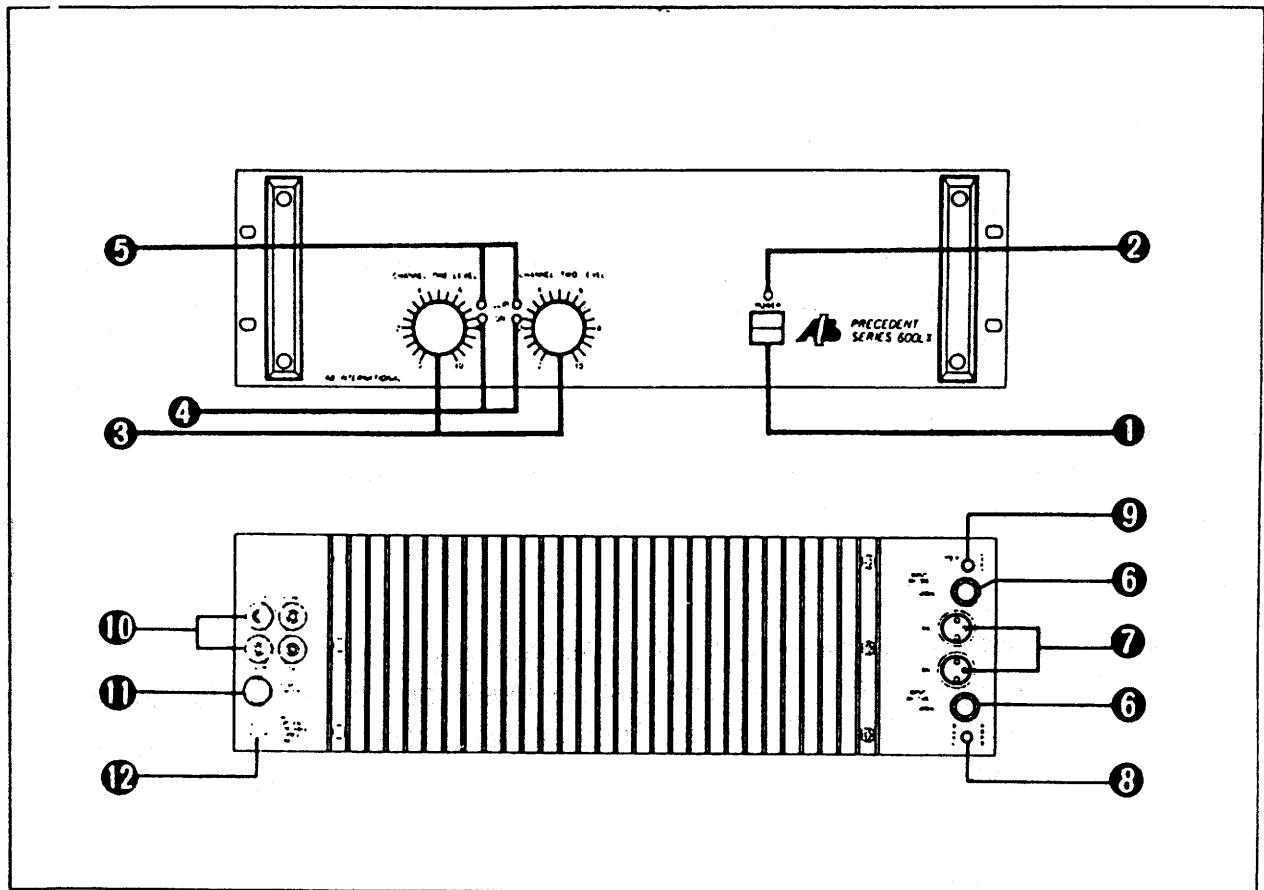

### 1. POWER SWITCH

To turn the Amplifier ON or OFF, press the upper or lower of this switch button.

### 2. POWER INDICATING LED

This LED indicates power is turned ON.

### 3. LEVEL CONTROLS

Each channel has a separate low-noise rotary level control. Rotate controls clockwise to increase level.

### 4. ON INDICATORS

Two LED indicators illuminate when the signal input provides greater than 0.5 watts output.

### 5. CLIP INDICATORS

Two LED indicators illuminate when the input signal levels exceed maximum output. If the indicators are illuminated regular then rejust the level controls.

## 6. UNBALANCED INPUT CONNECTIONS

Unbalanced inputs connect directly to the channel one and channel two quarter-inch phone jacks. These are prior to XLR input jacks.

## 7. BALANCED INPUT CONNECTIONS

XLR input connectors are provided for balanced input circuit. Please note that Pin 1: Ground, Pin 2: High, Pin 3: Low.

## 8. DUAL/MONO SELECTOR SWITCH

Bridged mono operation is easily achieved by that toggle switch. The input should be applied to channel one only, and the corresponding front panel gain control is used to set the level.

## 9. GROUND/LIFT SWITCH

To eliminate the ground loop between this amplifier and preamplifier on a certain case of system, GROUND/LIFT SWITCH is provided.

## 10. OUTPUT CONNECTIONS

Output connections are to five-way binding posts, which are identified as to polarity with a red and a black terminal. We suggest the use of dual banana plugs as a convenient and reliable method of hook-up. They allow rapid removal for polarity reversals, which is handy in the check-out and adjustment of multi-element bi-amplified and tri-amplified sound systems. Heavy Class II wire may be used by unscrewing the large plastic portion of the output terminal and inserting the wire into the hole provided. It is extremely important when making wire connections that no wire strand or end touches the adjacent terminal, shorting the output. (See Bridged Mono Operation.)

### **CAUTION:**

Never strap the two red output terminals together (in parallel). Never connect either red output to chassis ground.

## 11. FUSE HOLDER

This fuse holder contains AC primary fuse. Fuse should be replaced by same type fuse when this is blown out. If they continuously blow, stop replacing fuse and refer servicing to qualified personnel.

## 12. AC POWER CORD

Plug this AC input cord into AC outlet.



**CAUTION:**

The 600LX amplifier is a product of the most advanced technology and manufacturing techniques and is fully protected against overheating, input overload, and short or mismatched loads. But, as this is the case with any precision instrument, some care should be taken in the operation of the 600LX. The following precautions should be noted, since damage resulting from their omission is not covered under the terms of the warranty.

DO NOT PARALLEL THE TWO OUTPUTS OF EACH CHANNEL BY CONNECTING THEM TOGETHER, OR PARALLEL THEM WITH ANY OTHER AMPLIFIER OUTPUT NEVER CHANGE A FUSE WITH THE POWER CONNECTED. UNDER NO CIRCUMSTANCES SHOULD THE AMPLIFIER BE OPERATED WITH THE COVER REMOVED. THERE ARE NO USER-SERVICEABLE COMPONENTS INSIDE TO AVOID A POTENTIALLY DANGEROUS SHOCK, KEEP THE COVER CLOSED.

**BRIDGED MONO OPERATION**

1. Set the Mode Selector to MONO.
2. Connect a mono input signal to channel one input jack.
3. Connect the speaker load to the two red terminals of each channels. Please confirm the (+) terminal of speaker to channel one and the (-) terminal to channel two.
4. Do not use the black terminals of each channel.
5. Connect the speaker impedance to 8 ohms or above.
6. To adjust level use channel one control and leave channel two level at "0".

# MODEL 400

## Specifications

Type:	Two channel audio power amplifier
Gain:	26.5dB (each channel)
Continuous Average Power Output	145 watts per channel at 8 ohms 270 watts per channel at 4 ohms 400 watts at bridged mono at 8 ohms
Frequency Response:	Plus/Minus 0.25dB 20Hz-20KHz
Distortion:	THD — 20-20KHz at rated power less than 0.1% SMPTE-IMD less than 0.01% at rated power
Hum and Noise:	- 104dB below rated output (unweighted 20KHz bandwidth)
Slew rate:	Typically 40 volted per microsecond
Input Sensitivity:	1.0V RMS for rated output
Damping factor at 8 ohms:	250, 20Hz to 1KHz at 8 ohms
Input Impedance:	15K ohms nominal unbalanced
Input Connectors:	(2) 1/4-inch phone jacks (unbalanced)
Cooling:	Passive — combined with high efficiency output stage for reduced operating temperature.
Output Connectors:	Dual 5-way binding posts
Controls & Indicators:	(Front Panel) AC main power switch, Power-on LED indicator, Channel One and Two level controls, Signal and Clip indicators, Mono bridge switch
Amplifier & Load protection:	Indefinite short circuit, open circuit and over-temp protection. Stable into reactive and mismatched loads. Inputs protected from overload. DC fault, transient and excess low frequency protection.
Power Requirement:	100-125VAC, 50-60Hz (Option 220VAC 50-60Hz) 90W (idle), 500W (maximum)
Dimensions:	5-1/4"H (13.3cm) 19"W (48.3cm) 11-7/8" (30.2cm) behind panel 13-3/8" (34cm) overall
Weight:	30 lbs (13.6kg)
Shipping Weight:	34 lbs (15.5kg)

# MODEL 600A/600LX

## Specifications

Type:	Two channel audio power amplifier
Gain:	28dB (each channel)
Continuous Average Power Output	270 watts per channel at 8 ohms 425 watts per channel at 4 ohms 750 watts at bridged mono at 8 ohms
Frequency Response:	Plus/Minus 0.25dB 20Hz-20KHz
Distortion:	THD — 20-20KHz at rated power less than 0.1% SMPTE-IMD less than 0.01% at rated power
Hum and Noise:	- 104dB below rated output (unweighted 20KHz bandwidth)
Slew rate:	Typically 40 volted per microsecond
Input Sensitivity:	1.0V RMS for rated output
Damping factor at 8 ohms:	250, 20Hz to 1KHz at 8 ohms
Input Impedance:	15K ohms nominal unbalanced or balanced bridging
Input Connectors:	(2) 1/4-inch phone jacks and (2) XLR jacks (unbalanced and balanced)
Cooling:	Passive — combined with high efficiency output stage for reduced operating temperature, built in internal fan.
Output Connectors:	Dual 5-way binding posts
Controls & Indicators:	(Front Panel) AC main power switch, Power-on LED indicator, Channel One and Two level controls, Signal and Clip indicators, Mono bridge switch, Ground lift
Amplifier & Load protection:	Indefinite short circuit, open circuit and over-temp protection. Stable into reactive and mismatched loads. Inputs protected from overload. DC fault, transient and excess low frequency protection.
Power Requirement:	100-125VAC, 50-60Hz (Option 220VAC 50-60Hz) 90W (idle), 1200W (maximum)
Dimensions:	5-1/4"H (13.3cm) 19"W (48.3cm) 11-7/8" (30.2cm) behind panel 13-3/8" (34cm) overall
Weight:	31 lbs (14.1kg)
Shipping Weight:	35 lbs (15.9kg)

REF. NO.	DESCRIPTION	Q'TY	REMARK
1.	FRONT PANEL L-288	1	
2.	MAIN CHASSIS C-1301	1	
3.	RIGHT OF REAR PANEL C-1303	1	400,600A
	RIGHT OF REAR PANEL C-1304	1	600LX
4.	LEFT OF REAR PANEL C-1305	1	
5.	UPPER COVER C-1302	1	
6.	CARRY HANDLE H-157	2	
7.	PIECE OF TRANSFORMER C-626	4	
8.	TRANSFORMER H46044A2	1	USA, 400
	TRANSFORMER EI.114x60	1	EUR, 400
	TRANSFORMER H46056A2AB60	1	USA, 600A
	TRANSFORMER EI.114x60	1	EUR, 600A
	TRANSFORMER H46056A2AB60	1	USA, 600LX
	TRANSFORMER EI.114x60	1	EUR, 600LX
9.	HEAT SINK (RIGHT) H-152	1	
10.	HEAT SINK (LEFT) H-153	1	
11.	AC CORD 3P SVT	1	USA
	AC CORD 3P VDE	1	EUR
12.	BUSHING 6-V2	1	
13.	FUSE HOLDER R3-22A (LONG)	1	USA
	FUSE HOLDER R3-22A (SHORT)	1	EUR
14.	SPEAKER TERMINAL 2P HT-2874	2	
15.	KNOB KB-234 (B)	2	
16.	FUSE 6.3 $\phi$ x31.7x8A	1	USA, 400
	FUSE 5 $\phi$ x20x4A	1	EUR, 400
	FUSE 6.3 $\phi$ x31.7x10A	1	USA, 600A
	FUSE 5 $\phi$ x20x5A	1	EUR, 600A
	FUSE 6.3 $\phi$ x31.7x10A	1	USA, 600LX
	FUSE 5 $\phi$ x20x5A	1	EUR, 600LX
17.	CONNECTOR E-D304	1	S. P.
18.	CONNECTOR E-D305	2	S. P.
19.	FOOT CUSHION 24 $\phi$ x16mm	4	
20.	STYROFOAM PF-087	2	
21.	STYROFOAM PF-091	2	
22.	INSIDE CARTON	1	
23.	OUTSIDE CARTON	1	
24.	OWNER'S MANUAL	1	
25.	LIMITED WARRANTY	1	
26.	TEST REPORT CARD	1	
27.	TABLE OF SERIAL NO.	1	
28.	SCREW CRMS 3x6 (Y)	6	
29.	SCREW CRMS 3x8 (B)	10	
30.	SCREW CRMS 4x8 (B)	7	
31.	SCREW CRMS 4x12 (B)	6	
32.	SCREW CRVMS 4x12 (V)	4	
33.	SCREW CRVMS 4x12 (B)	8	
34.	SCREW CRTS 3x6 (Y)	5	
35.	SCREW MS 4x44 (B)	4	HANDLE
36.	NUT 4 $\phi$ (Y)	5	
37.	GEAR WASHER 4 $\phi$ (Y)	1	
38.	GEAR WASHER 3 $\phi$ (B)	2	
39.	GEAR WASHER 12.5x10.2x0.5	2	
40.	FLAT WASHER 4.2x12x1.6 (Y)	4	
41.	SPRING WASHER 4 $\phi$ (Y)	4	

## 8. PARTS LIST

8-2

## P.C. BOARD PVK-B40 (A)

REF. NO.	DESCRIPTION	Q'TY	REMARKS
	HEAT SINK HOLDER H-154	4	
	HEAT SINK L TYPE H-156	1	
	GEAR WASHER 3 $\phi$ (W)	32	
	SCREW CRMS 3x16 (W)	4	
	NUT 3 $\phi$ (W)	16	
	PIN 1.2x1.2x19	1	
	WAFER 5045-2	2	
	WAFER 5045-3	1	
	WAFER 5273-3	2	
	WAFER 5273-6	1	
	THERMOSTAT SW T95AR1U1	2	
	THERMOSTAT SW HOLDER C-1307	2	
	PVC WIRE #22 1015, RED 200mm	4	
	SCREW CRTS 3x6 (Y)	5	
	SCRMS CRMS 3x14 (W)	12	
	SILICON GRESS		
	WIRE CONNECTOR SW-2	1	
-CARBON RESISTORS T TYPE-			
ALL RESISTORS ARE RATED $\pm 5\%$ TOLERANCE AND 1/4W			
R117, R118, R111, R112	22 ohm		
R218, R217, R211, R212	22 ohm		
R147, R146, R246, R247	100 ohm		
R122, R222, R227	220 ohm		
R130, R128, R230, R228	470 ohm		
R123, R223	470 ohm		
R133, R125, R101, R148	1K ohm		
R248, R225, R201, R233	1K ohm		
R145	2K2 ohm		
R119, R120, R108, R109	3K3 ohm		
R208, R209, R219, R220	3K3 ohm		
R249	4K7 ohm		
R129, R148, R229	10K ohm		
R124, R102, R003, R005	15K ohm		
R202, R224	15K ohm		
R115, R114, R214, R215	22K ohm		
R004, R006	10K ohm		
-CARBON RESISTORS T TYPE-			
ALL RESISTORS ARE RATED $\pm 5\%$ TOLERANCE AND 1/2W			
R134, R234, R135, R235	47 ohm		
R144, R244	5K6 ohm		
R131, R132, R231, R232	22K ohm		
-METAL FILM RESISTORS T TYPE-			
ALL RESISTORS ARE RATED $\pm 5\%$ TOLERANCE AND 2W			
R136, R137, R140, R141	0.43 ohm		
R236, R237, R240, R241	0.43 ohm		
R142, R242	4.7 ohm		
WITH 15Tx10 $\phi$ x1.2mm COIL	10 ohm		
R001, R002	5K8 ohm		

# 8. PARTS LIST

8-3

## P.C. BOARD PVK-B40 (A)

REF. NO.	DESCRIPTION	Q'TY	REMARKS
-CAPACITORS-			
C105, C205	22P/500V CERAMIC		
C102x2	200P/500V CERAMIC		
C108, C109, C208, C209	220P/500V CERAMIC		
C111, C105, C205, C211	0.04/50V CERAMIC		
C107, C207	0.1/50V MYLAR	K	
C112, C212	0.1/50V MYLAR	J	
C101, C201	4.7u/50V ELEC.	NP	
C113, C114	100u/50V ELEC.	NP	
C115, C215	220u/16V ELEC.	NP	
C001, C002	47u/25V ELEC.		
-DIODE-			
D105, D106, D108, D205	IN4148		
D206, D208	IN4148		
Z001, Z002	15V/0.5W ZENER DIODE		
D104, D107, D204, D207	IN4004		
-VARIABLE RESISTORS-			
TVR101, TVR201	6 $\phi$ H TYPE 1K		
TVR001, TVR002	8 $\phi$ H TYPE 10K		
-TRANSISTORS-			
Q107, Q108, Q207, Q208	2SA970BL		
Q116, Q216	2SA970BL		
Q103, Q104, Q203, Q204	2SC2240BL		
Q115, Q215	2SC2240BL		
Q109, Q110, Q209, Q210	2SA1370		
Q125, Q225	2SA1370		
Q111, Q112, Q211, Q212	2SC3467		
Q114, Q214	2SC3467		
Q113, Q213	2SC3421		
Q118, Q218	HJE15030		
Q117, Q217	HJE15031		
Q119, Q121, Q219, Q212	HJ15011		
Q122, Q124, Q222, Q224	HJ15012		
-COIL-			
L101, L201	15Tx10 $\phi$ x1.2m/m		
-TRIAC-			
T101	HAC97A8		

## P.C. BOARD PVK-B40 (B) 400, 600A ONLY

REF. NO.	DESCRIPTION	Q'TY	REMARKS
	PHONE JACK HTJ084-04J 6.3 $\phi$	2	
	SLIDE SW SSSP122 NB1	1	
	PIN 1x1x19	2	
	CONNECTOR E-D299	1	
-CARBON RESISTORS T TYPE-			
R001, R002	ALL RESISTORS ARE RATED $\pm 5\%$ TOLERANCE AND 1/4W 2K7 ohm		

# 8. PARTS LIST

8-4

## P.C. BOARD PWK-B40 (C) 600LX ONLY

REF.NO.	DESCRIPTION	Q'TY	REMARKS
	PHONE JACK HTJ064-04J 6.3 $\phi$	2	
	LEVEL SV A1M4-T05 (UPPER)	1	
	LEVEL SV A2M4-T05 (UNDER)	1	
	XL/R SOCKET 4-24027	2	
	PIN 1x1x19	2	
	CONNECTOR E-D302	1	
	-CARBON RESISTORS T TYPE-		
	ALL RESISTORS ARE RATED $\pm 5\%$ TOLERANCE AND 1/4W		
R306, R406	100 ohm		
R301, R402	2K7 ohm		
R302 ohm			
R307, R407	47K ohm		
	-CAPACITORS-		
C303			
06, C403			
06	220P/50V CERAMIC		
C301, C302, C401, C402	0.47u/50V ELEC.	NP	
C307, C407	4.7u/25V ELEC.		
C308, C408	47u/50V ELEC.		
	-IC-		
IC001	JRC4558DD		

## P.C. BOARD PWK-B40 (D)

REF.NO.	DESCRIPTION	Q'TY	REMARKS
	HEAT SINK H-155	1	
	POWER PCB HOLDER C-1306	1	
	GEAR WASHER 3 $\phi$ (V)	3	
	FLAT WASHER 3.2x8x0.5 (V)	1	
	SPRING WASHER 3 $\phi$	1	
	COPPER POST E-180	1	
	CONNECTOR WIRE E-D297	1	
	RELAY ME-48VDC	1	
	CONNECTOR E-D303 6P	1	
	PIN 1x1x19	6	
	SCREW CRMS 3x6 (V)	5	
	SCREW CRTS 3x18 (Y)	1	
	SCREW CRMS 4.5x9	4	WITH CAP.
	GEAR WASHER 5.3x10.2x0.5	4	WITH CAP.
	-CARBON RESISTORS T TYPE-		
	ALL RESISTORS ARE RATED $\pm 5\%$ TOLERANCE AND 1/2W		
R503	10 ohm		
R501, R504	1K ohm		400 ONLY
R504	1K ohm		600LX, 600A ONLY
R501	2K7 ohm		600LX, 600A ONLY
	-CARBON RESISTORS T TYPE-		
	ALL RESISTORS ARE RATED $\pm 5\%$ TOLERANCE AND 1/4W		
R502	33K ohm		400 ONLY
R502	39K ohm		600LX, 600A ONLY

# 8. PARTS LIST

8-5

## P.C. BOARD PVK-B40 (D)

REF. NO.	DESCRIPTION	Q'TY	REMARKS
-CAPACITORS-			
C505, C506	.01/500V CERAMIC		
C501, C502	6800u/80V ELEC.		400 ONLY
C501, C502	10000u/80V ELEC.		600LX, 600A ONLY
-DIODE-			
D502	IN4004		
D501	RB-252 BRIDGE RECTIFIER		
-TRIAC-			
T501	MAC15A6FP		

## P.C. BOARD PVK-B40 (E) VR

REF. NO.	DESCRIPTION	Q'TY	REMARKS
	LED 2 $\phi$	2	
	VR R-10A 50K 419C	2	
	CONNECTOR E-D298 3P	1	
	CONNECTOR E-D300	1	
	CONNECTOR E-D301	1	
	PVC WIRE #28 RED 350mm	1	
	PVC WIRE #28 WHITE 350mm	1	
-CARBON RESISTORS T TYPE-			
ALL RESISTORS ARE RATED $\pm 5\%$ TOLERANCE AND 1/4W			
R601, R603, R604, R606	33K ohm		400 ONLY
R602, R605	68K ohm		400 ONLY
R603, R606	33K ohm		600LX, 600A ONLY
R601, R604	39K ohm		600LX, 600A ONLY
R602, R605	68K ohm		600LX, 600A ONLY
-CAPACITORS-			
C601, C602, C603, C604	1u/50V ELEC.		
-DIODE-			
D601, D602	IN4004		
-TRANSISTORS-			
Q601, Q603	2SA970BL		
Q602, Q604	2SC2240BL		

## P.C. BOARD AC SV. PCB

REF. NO.	DESCRIPTION	Q'TY	REMARKS
	AC SV. 18041121R50	1	
	LED L-13IP 2 $\phi$ RED	1	
	PRESS TERMINAL FDMI-205	6	
	PVC WIRE #18 1015, ORANGE 160mm	1	
	PVC WIRE #18 1015, RED 140mm	1	
	PVC WIRE #22 1007, BLACK 200mm	1	
	PVC WIRE #22 1007, BLUE 200mm	1	



# 3. PARTS LOCATION FOR 400

3-1

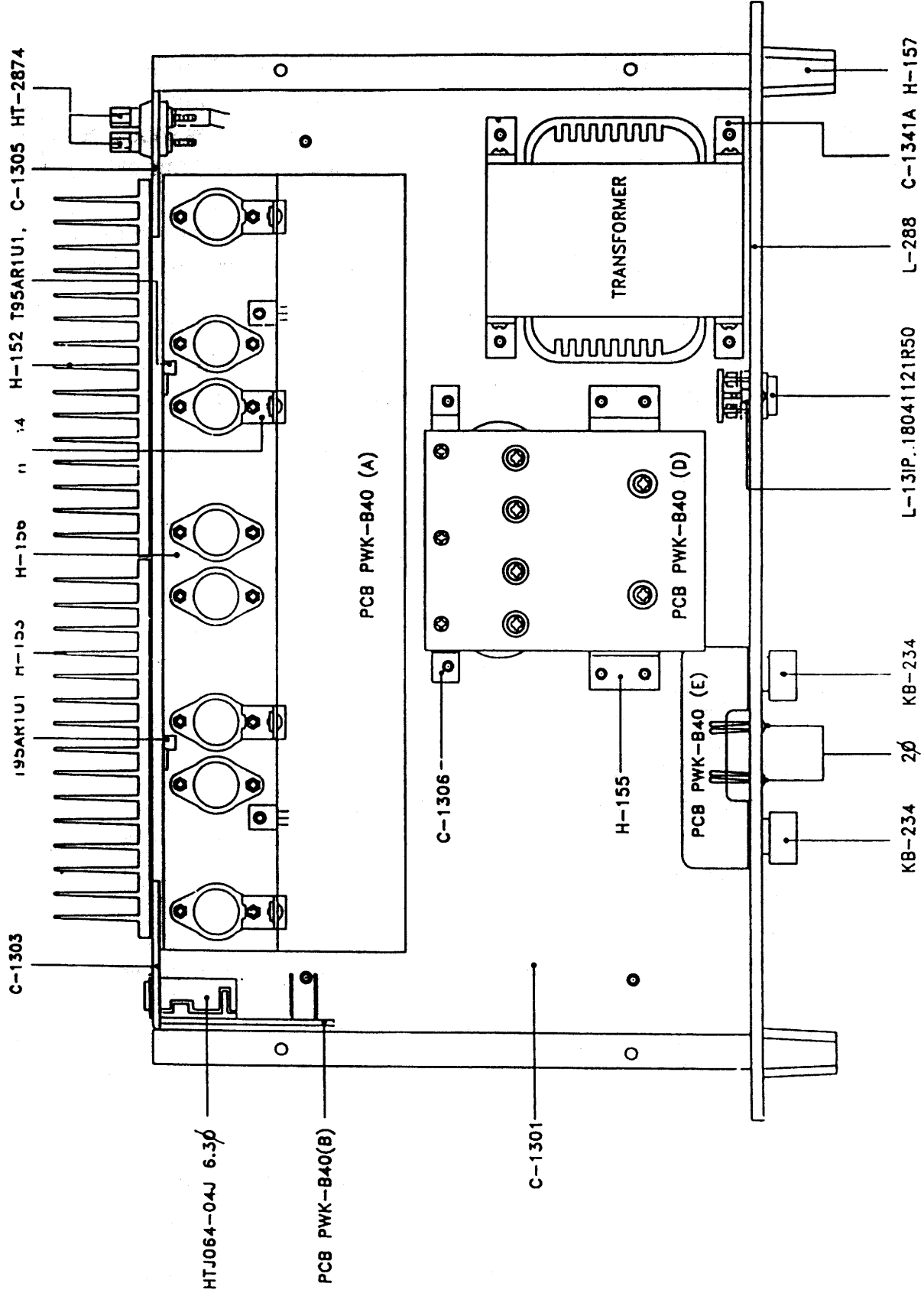

# 3. PARTS LOCATION FOR 600A

3-2

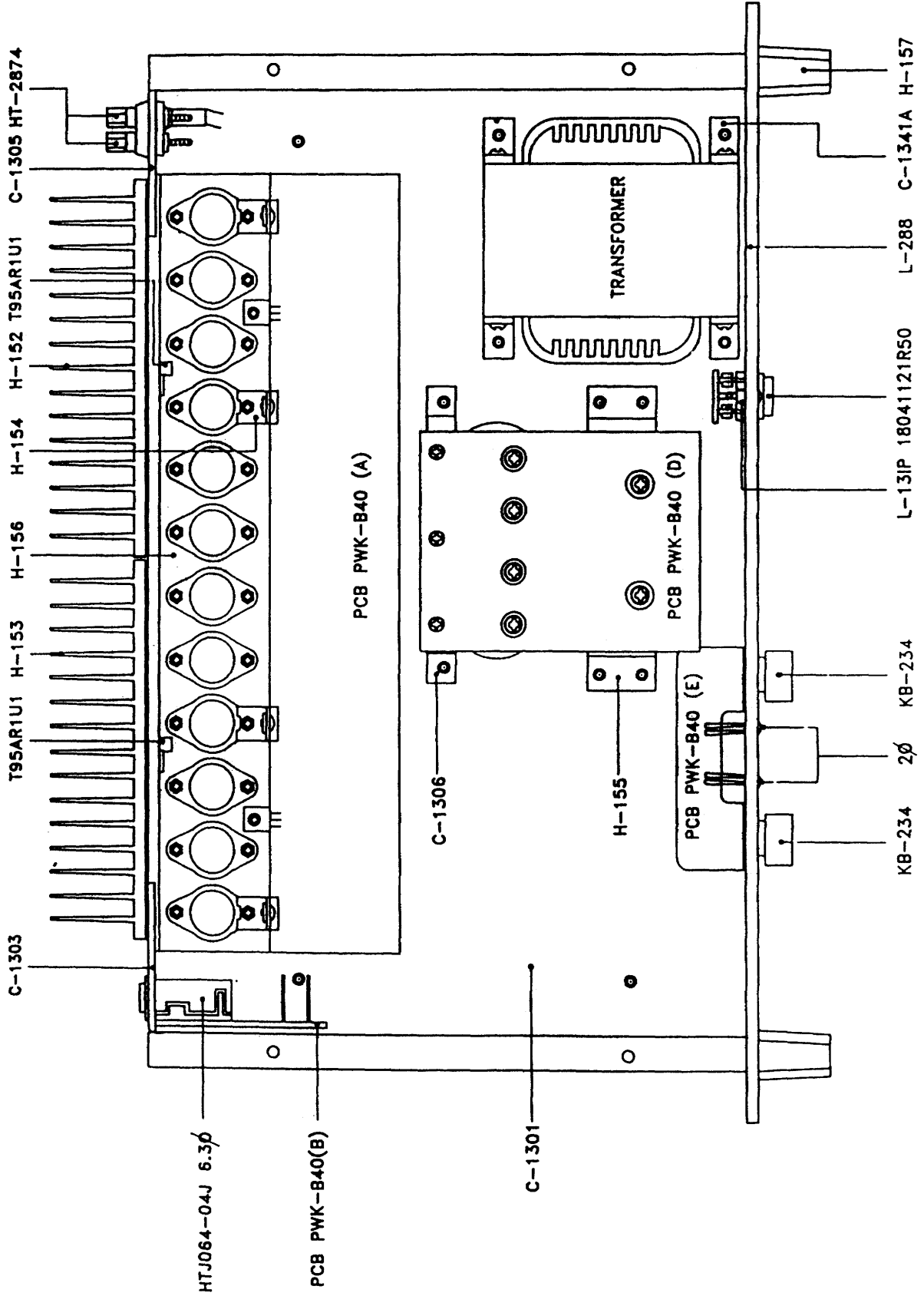

# 3. PARTS LOCATION FOR 600LX

3-3

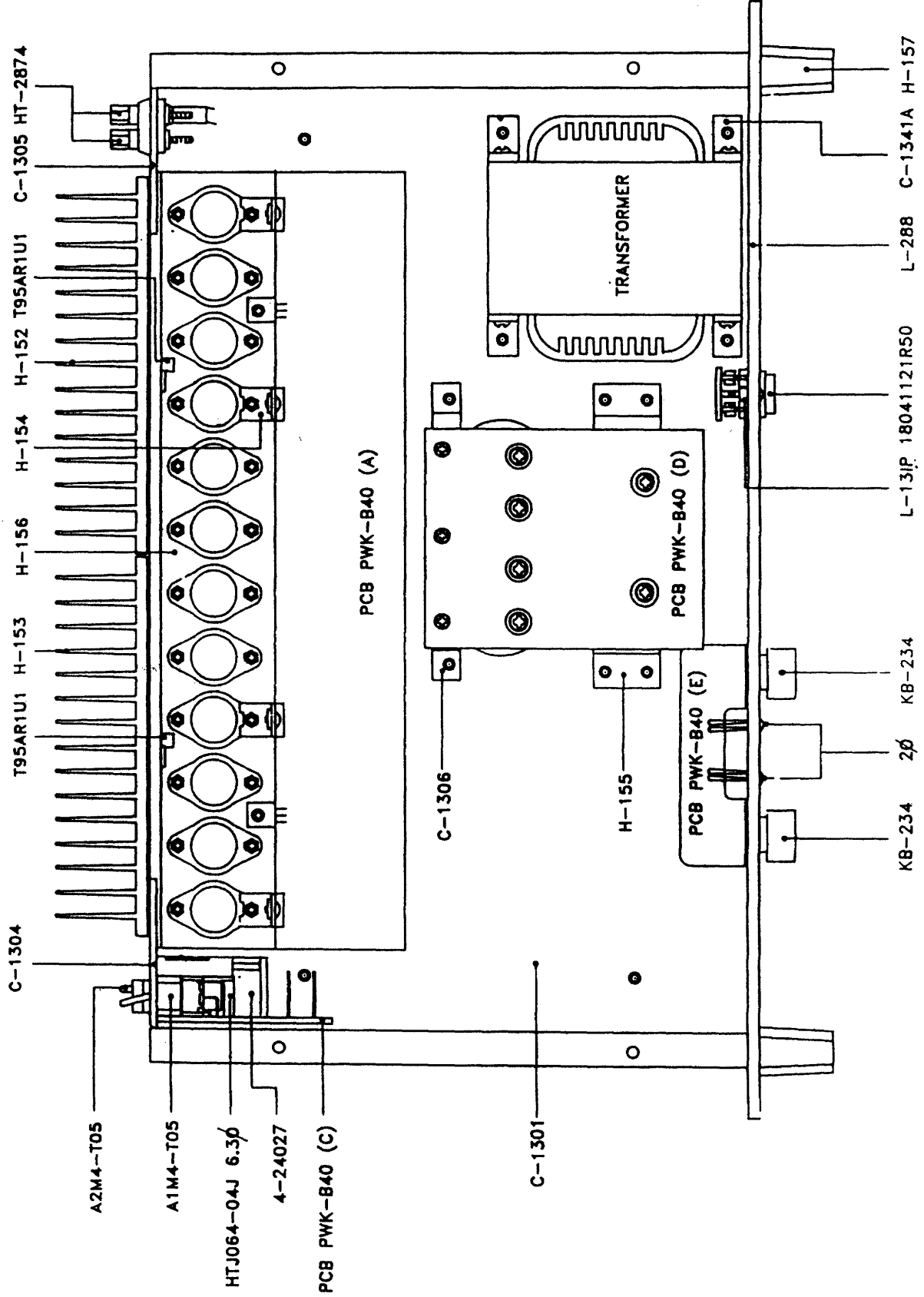

# LINE VOLTAGE CONVERSION

## 100/120V - 220-240V

### MODELS 400/600A/600LX

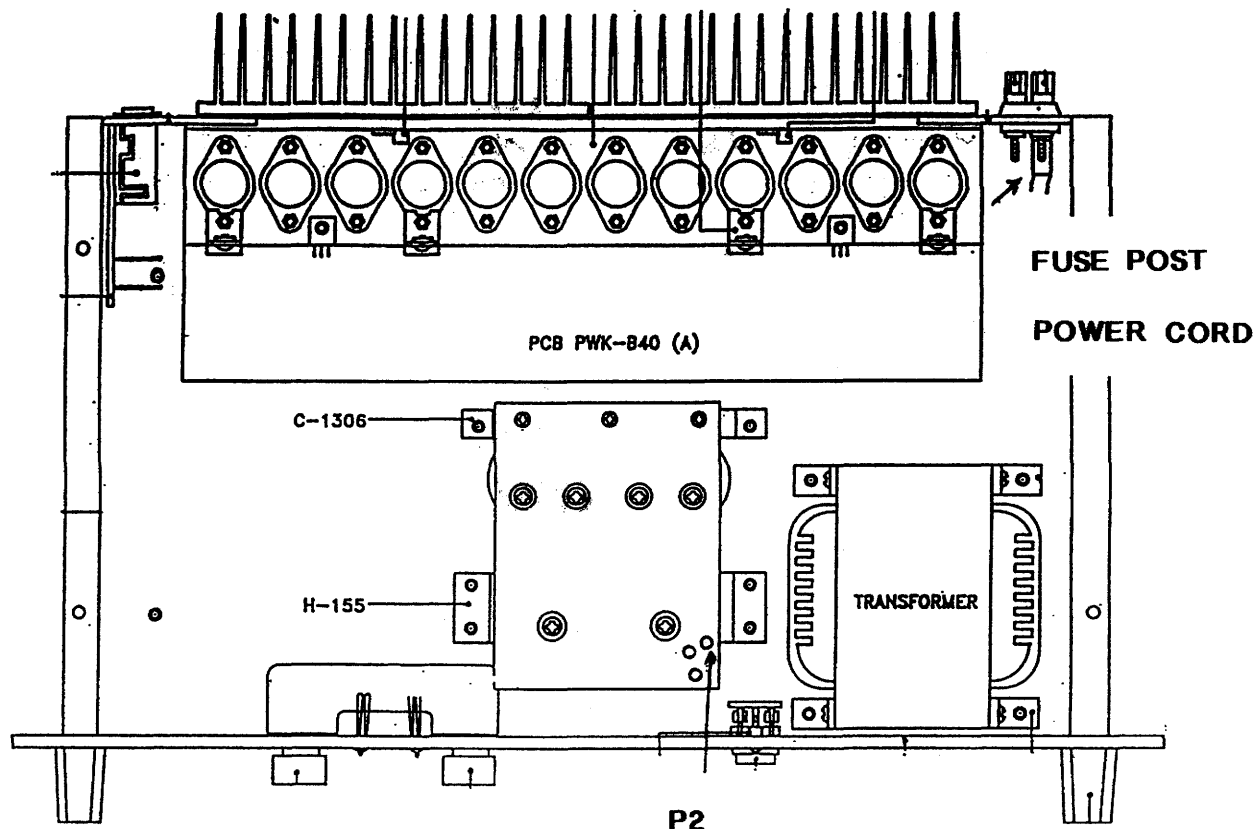

MODELS 400, 600A, 600LX SERIAL NUMBERS MUST FOLLOW THIS SEQUENCE 714-XXXXX-XX FOR THESE PROCEDURES.

1. REMOVE THE TRANSFORMER RED WIRE FROM PIN 2 OF THE POWER SUPPLY.  
NOTE: LEAVE THE TRANSFORMER PURPLE WIRE CONNECTED TO PIN 2 OF THE POWER SUPPLY.
2. DISCONNECT THE TRANSFORMER GREY WIRE FROM THE POWER CORD.  
NOTE: LEAVE THE TRANSFORMER **WHITE** WIRE CONNECTED TO THE POWER CORD WHITE WIRE.
3. CONNECT THE TRANSFORMER RED & **GREY** WIRES TOGETHER.
4. CHANGE THE THE FUSE TO THE PROPER VALUE WHICH IS INDICATED ON THE REAR PLATE OF THE AMPLIFIER.

# LINE VOLTAGE CONVERSION

220-240V - 100/120V

MODELS 400/600A/600LX

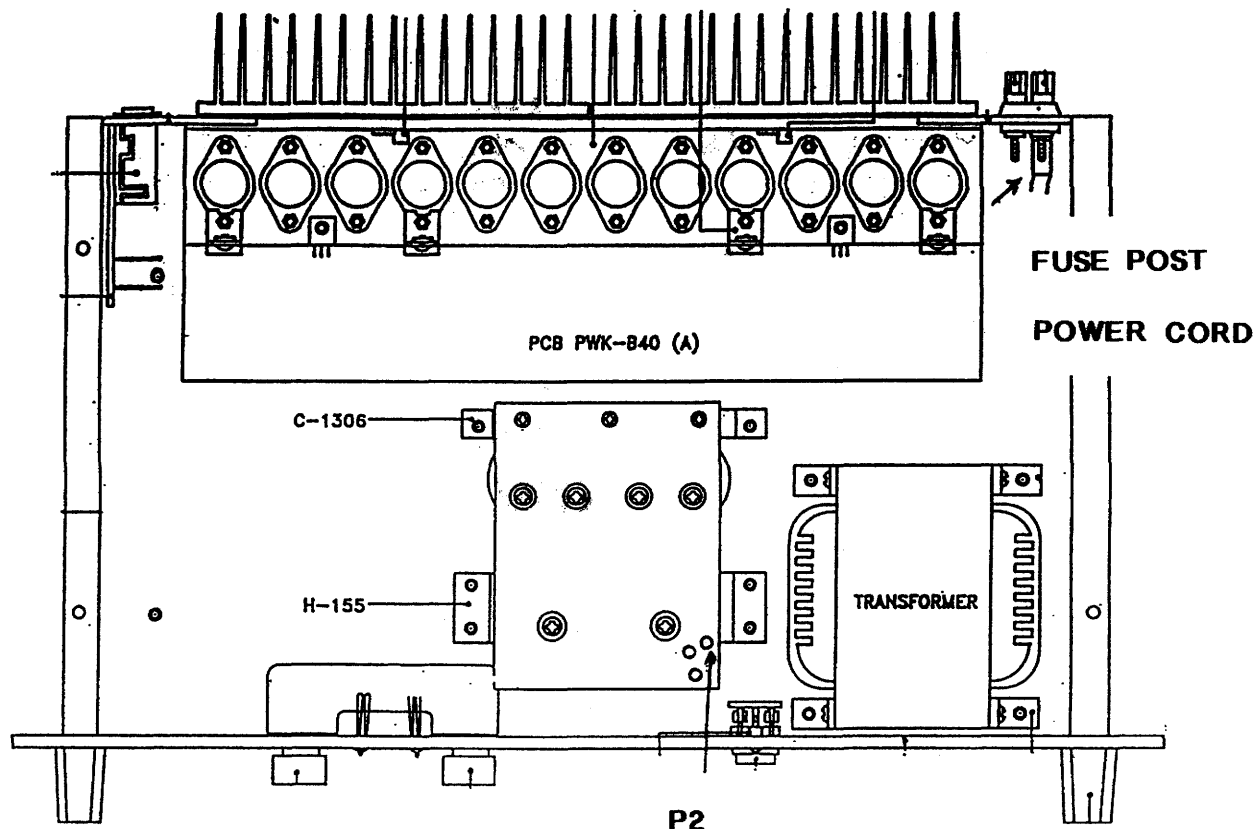

MODELS 400, 600A, 600LX SERIAL NUMBERS MUST FOLLOW THIS SEQUENCE 714-XXXXX-XX FOR THESE PROCEDURES.

1. SEPERATE THE CONNECTION OF THE RED AND GRAY WIRES COMING FROM THE TRANSFORMER (RED AND GRAY WIRES TIED TOGETHER FOR 220VAC OPERATION).
2. CONNECT RED WIRE FROM TRANSFORMER TO "P2" ON THE POWER SUPPLY PCB. (PURPLE WIRE FROM TRANSFORMER IS ALSO CONNECTED TO "P2" TERMINAL).
3. CONNECT GRAY WIRE FROM TRANSFORMER TO POWER CORD WHITE WIRE (POWER CORD WHITE WIRE IS ALSO CONNECTED TO WHITE WIRE FROM TRANSFORMER).
4. INSTALL A 5 AMP FUSE FOR THE MODEL 400A  
INSTALL A 10 AMP FUSE FOR THE MODEL 600A, 600LX

NOTE: WHEN THE OPERATION IS COMPLETED 2 WIRES (RED & PURPLE) WILL BE CONNECTED TO "P2", AND 2 WIRES (GRAY & WHITE) WILL BE CONNECTED TO THE AC POWER CORD WHITE WIRE.

# FAN REPLACEMENT MODEL 600A/600LX

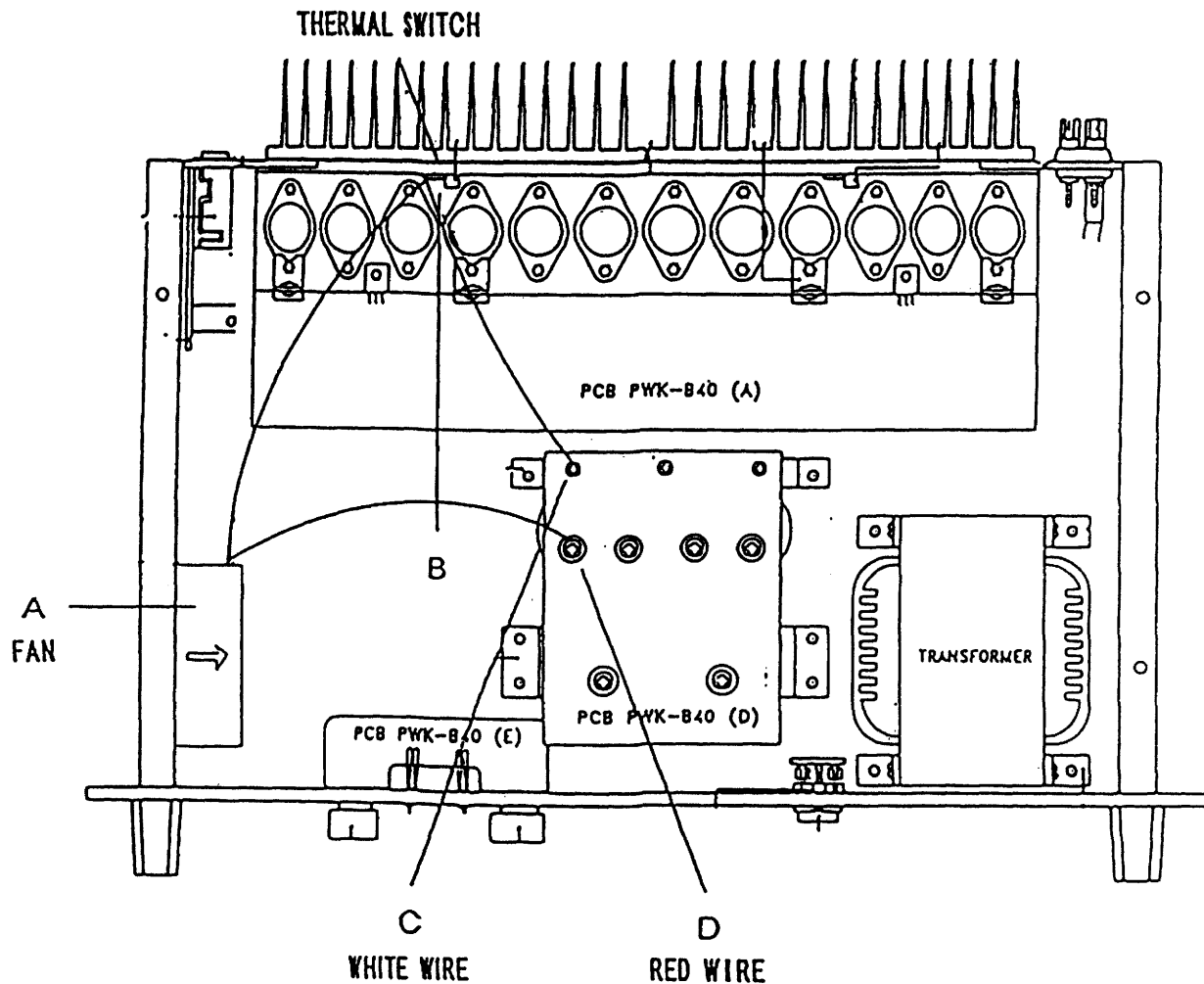

- STEP 1. REMOVE FAN (A)
2. REMOVE RED & BLACK FAN WIRES FROM POWER SUPPLY
3. INSTALL NEW FAN
4. MOUNT THERMAL SWITCH WITH CLIP USING PCB HEATSINK SCREW (B)
5. SOLDER WHITE WIRE TO LOCATION (C)
6. SOLDER RED WIRE TO LOCATION (D)

# PCB REPLACEMENT MODEL 400/600A/600LX

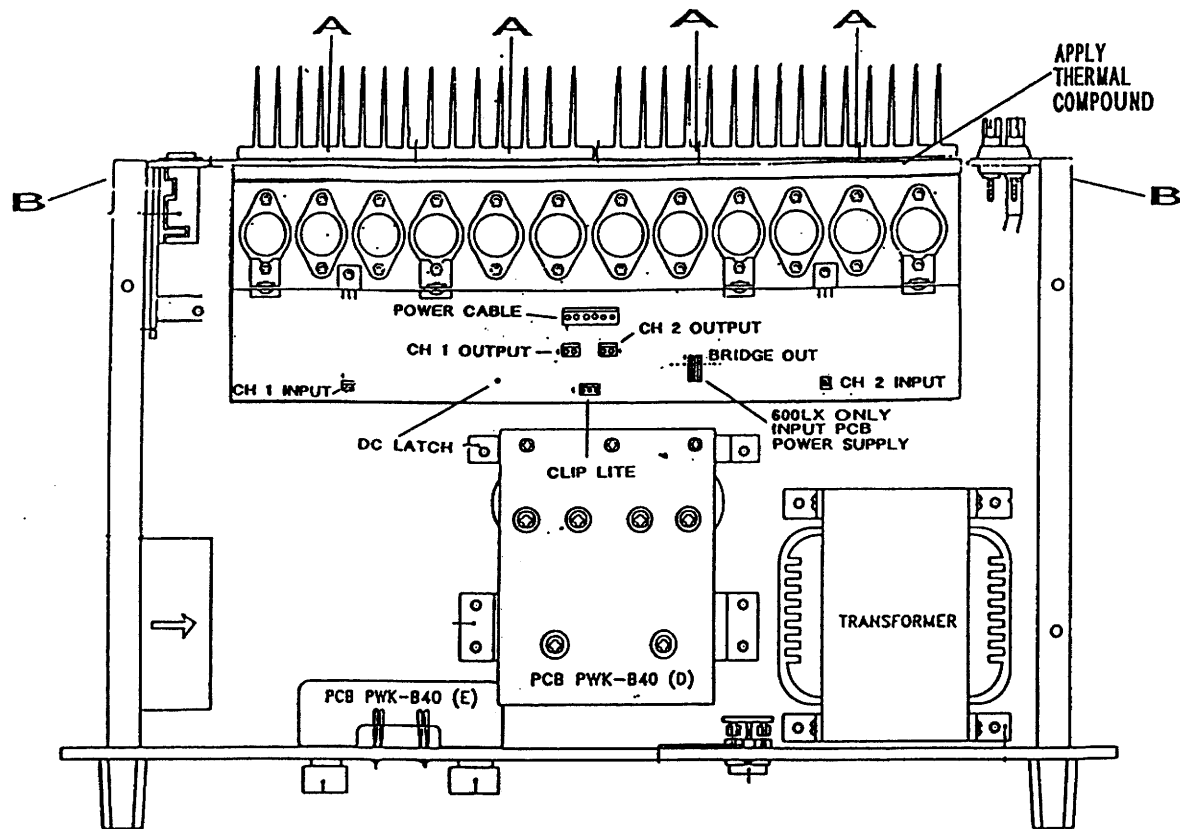

**STEP 1. UNPLUG AND REMOVE AMPLIFIER FROM POWER SOURCE.**

**2. REMOVE FOUR TOP COVER SCREWS.**

**3. DISCONNECT ALL CABLES FROM MAIN PCB.**

**NOTE: POWER SUPPLY FILTER CAPS WILL BE STILL CHARGED. DO NOT SHORT ANY DEVICES ACROSS THE CAPS.**

**4. REMOVE THE FOUR HEATSINK SCREWS HOLDING THE MAIN PCB ASSEMBLY, INDICATED AS (A) ON THE DRAWING. IT MAY BE NECESSARY TO REMOVE THE SIX REAR PANEL ASSEMBLY MOUNTING SCREWS INDICATED AS (B).**

**5. BEFORE MOUNTING THE NEW PCB INTO THE CHASSIE, APPLY A THIN EVEN COAT OF SILICON THERMAL COMPOUND TO THE REAR ANGLE HEATSINK OF THE PCB. NOTE: IF FAILURE TO DO SO, IT WILL CAUSE IMPROPER HEAT TRANSFER AND THE AMPLIFIER WILL GO INTO THERMAL PROTECT.**

**6. AFTER MOUNTING THE PCB INTO THE CHASSIE MAKE SURE ALL THE SCREWS ARE TIGHT TO ASSURE PROPER RELIABILITY.**

**7. CONNECT ALL CABLES BACK TO THEIR ORIGINAL PLACES.**

# 4. ADJUSTMENT AND TEST POINT LOCATIONS

FOR 600A, 600LX

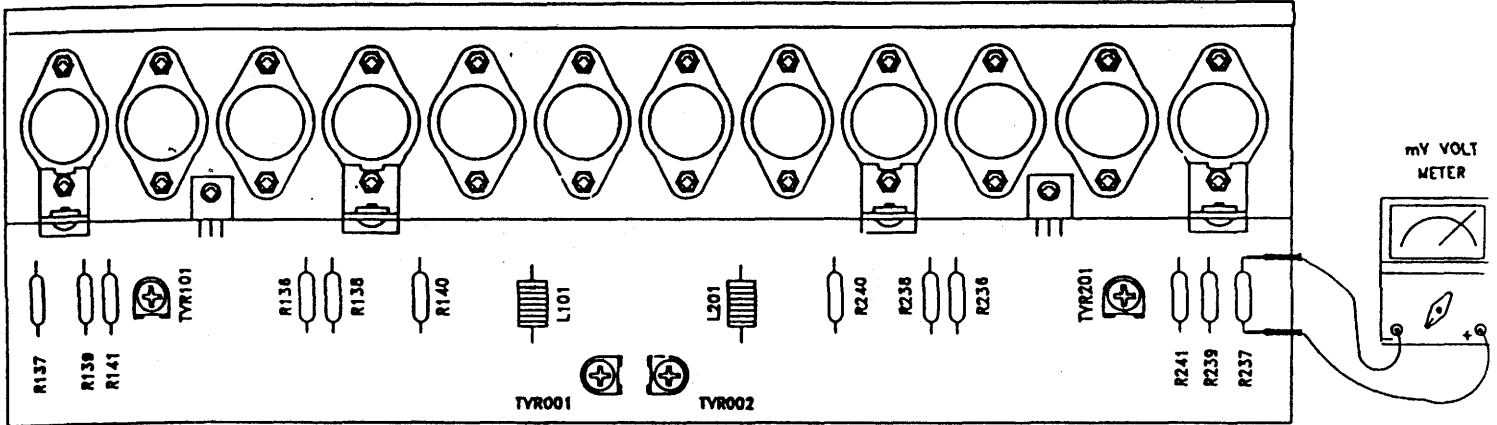

1. **BAS ADJUSTMENT:** THE "LEVEL CONTROL" CLOSE TO MINIMUM POSITION, USE mV VOLT METER CONNECTED TO R137, R138, R141, R136, R138, R140 (CH1) R237, R238, R241, R238, R236, R240, (CH2) AND ADJUSTMENT TYR101 (CH1), TYR201 (CH2), LET THE mV VOLT METER SHOWED 5mV~12mV.
2. **CLIP LED INDICATOR ADJUSTMENT:** USED SINGLE CHANNEL (CH1 OR CH2) 1KHz OUTPUT, LET THE OUTPUT LEVEL IN CLIPPING POSITION AND DISTORTION ABOUT 3X, ADJUSTMENT TYR001 (CH1), TYR002 (CH2) TO CLIP LED LIGHT AND ATTENUATED INPUT LEVEL - 0.5dB, THE CLIP LED MUST BE NO LIGHT.

FOR 400

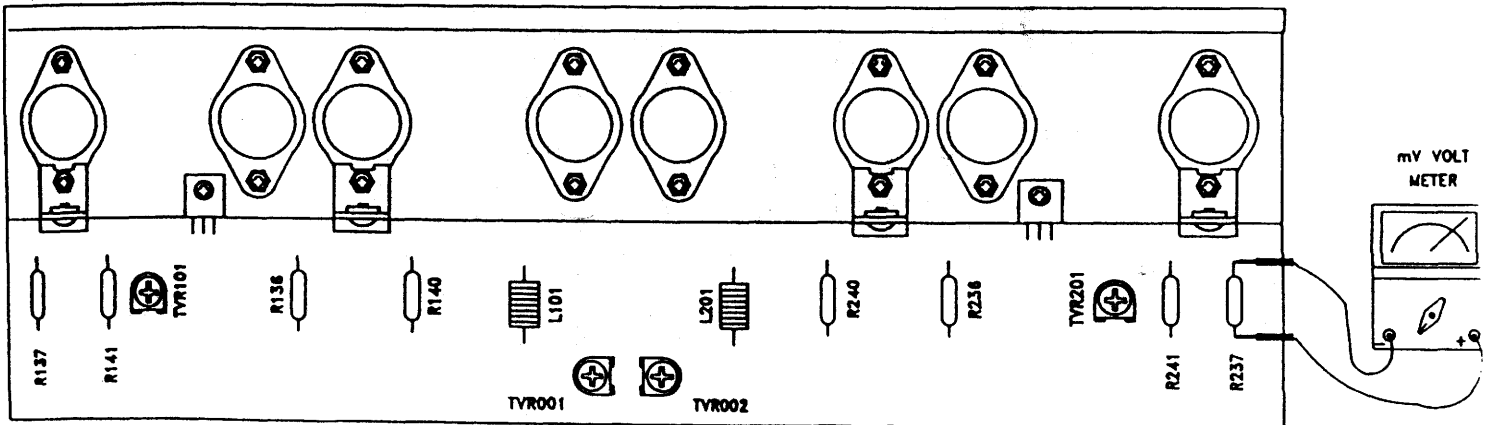

1. **BAS ADJUSTMENT:** THE "LEVEL CONTROL" CLOSE TO MINIMUM POSITION, USE mV VOLT METER CONNECTED TO R137, R141, R136, R140 (CH1), R237, R241, R236, R240 (CH2) AND ADJUSTMENT TYR101 (CH1), TYR201 (CH2), LET THE mV VOLT METER SHOWED 5mV~12mV.
2. **CLIP LED INDICATOR ADJUSTMENT:** USED SINGLE CHANNEL (CH1 OR CH2) 1KHz OUTPUT, LET THE OUTPUT LEVEL IN CLIPPING POSITION AND DISTORTION ABOUT 3X, ADJUSTMENT TYR001 (CH1), TYR002 (CH2) TO CLIP LED LIGHT AND ATTENUATED INPUT LEVEL - 0.5dB, THE CLIP LED MUST BE NO LIGHT.



# INPUT SENSITIVITY CHANGE

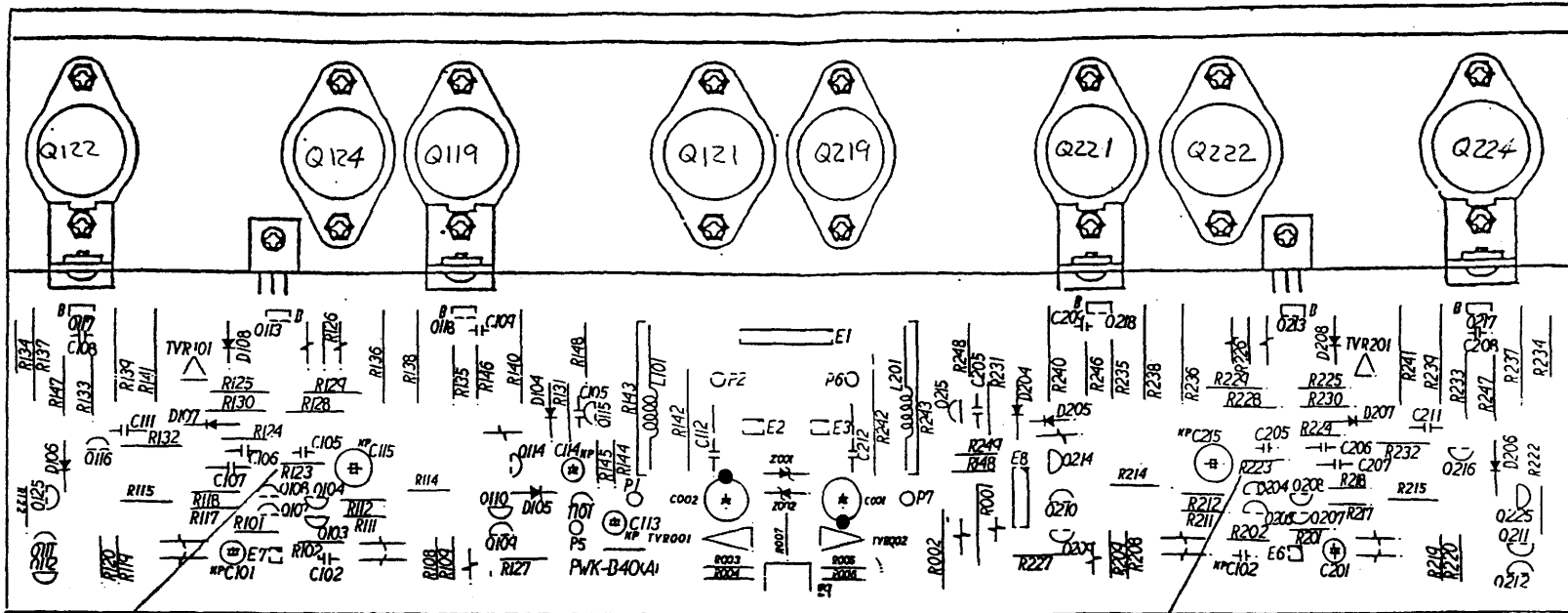

R123

INPUT SENSITIVITY CHANGES CAN BE ACCOMPLISHED WITH TWO METHODS, BUT FIRST LOCATE R123 AND R223 ON THE COMPONENT DIAGRAM. BOTH THESE RESISTORS SHOULD BE 470 ohm's FOR A 1.5V INPUT SENSITIVITY AND IF THEY ARE NOT CONTACT AB INTERNATIONAL FOR FURTHER INFORMATION.

R223

**METHOD #1.** REPLACING RESISTORS R123 AND R223 WITH THE FOLLOWING RESISTOR VALUES. FOR A 1V INPUT SENSITIVITY REPLACE THE RESISTORS WITH A 300 ohm 1/4W. FOR A .775V INPUT SENSITIVITY REPLACE THE RESISTORS WITH A 220 ohm 1/4W.

**#2.** THE SAME INPUT SENSITIVITY CAN BE ACCOMPLISHED BY PARALLELING A RESISTOR ACROSS THE 470 ohm IN R123 AND R223 LOCATIONS. FOR A 1V INPUT, SOLDER A 750 ohm RESISTOR ACROSS THE EXISTING 470 ohm. FOR A 775V INPUT, SOLDER A 390 ohm RESISTOR ACROSS THE EXISTING 470 ohm.

**AB INTERNATIONAL, INC.**

TITLE: COMPONENT DIAGRAM

MODEL: 400

DATE: 4-22-94

REV.

# INPUT SENSITIVITY CHANGE

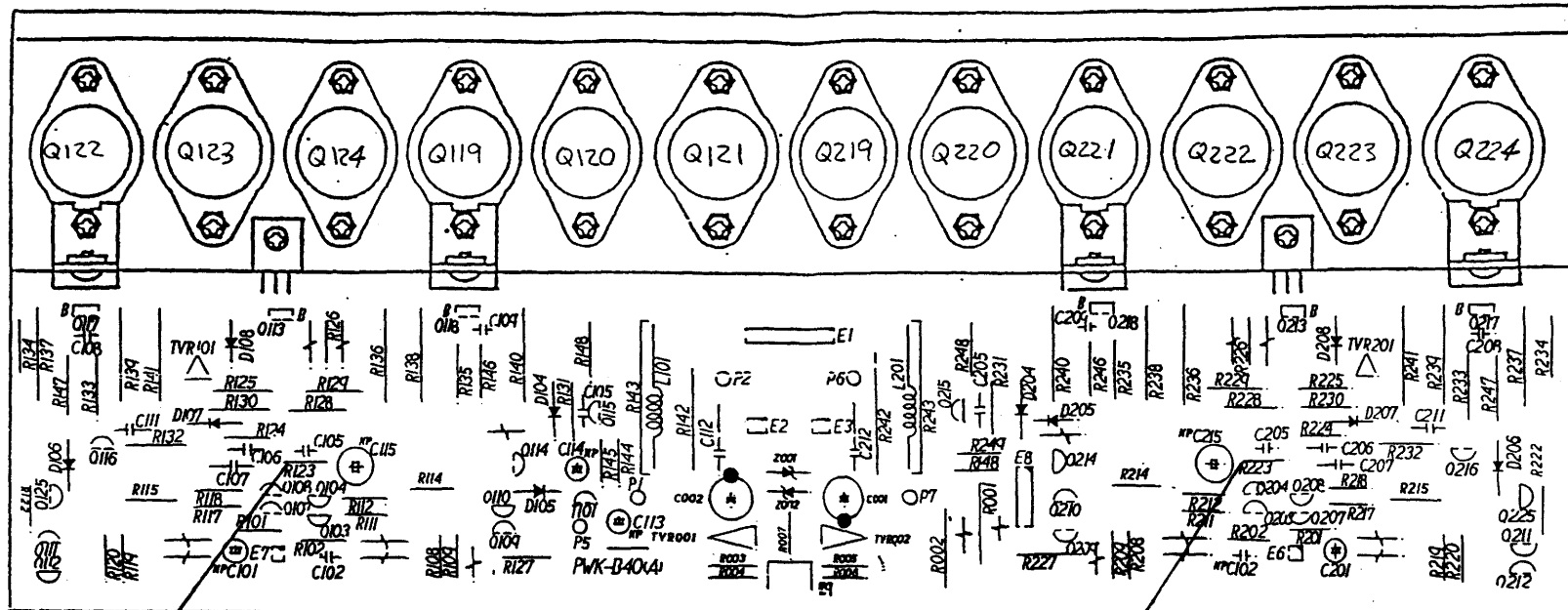

R123

INPUT SENSITIVITY CHANGES CAN BE ACCOMPLISHED WITH TWO METHODS, BUT FIRST LOCATE R123 AND R223 ON THE COMPONENT DIAGRAM. BOTH THESE RESISTORS SHOULD BE 470 ohm's FOR A 1.5V INPUT SENSITIVITY AND IF THEY ARE NOT CONTACT AB INTERNATIONAL FOR FURTHER INFORMATION.

R223

**METHOD #1.** REPLACING RESISTORS R123 AND R223 WITH THE FOLLOWING RESISTOR VALUES. FOR A 1V INPUT SENSITIVITY REPLACE THE RESISTORS WITH A 240 ohm 1/4W. FOR A .775V INPUT SENSITIVITY REPLACE THE RESISTORS WITH A 180 ohm 1/4W.

**#2.** THE SAME INPUT SENSITIVITY CAN BE ACCOMPLISHED BY PARALLELING A RESISTOR ACROSS THE 470 ohm IN R123 AND R223 LOCATIONS. FOR A 1V INPUT, SOLDER A 470 ohm RESISTOR ACROSS THE EXISTING 470 ohm. FOR A 775V INPUT, SOLDER A 300 ohm RESISTOR ACROSS THE EXISTING 470 ohm.

**AB INTERNATIONAL, INC.**

TITLE: COMPONENT DIAGRAM

MODEL: 600A 600LX

DATE: 4-22-94

REV.

# 5. BLOCK DIAGRAM FOR 400, 600A

5-1

AB 400, 600A

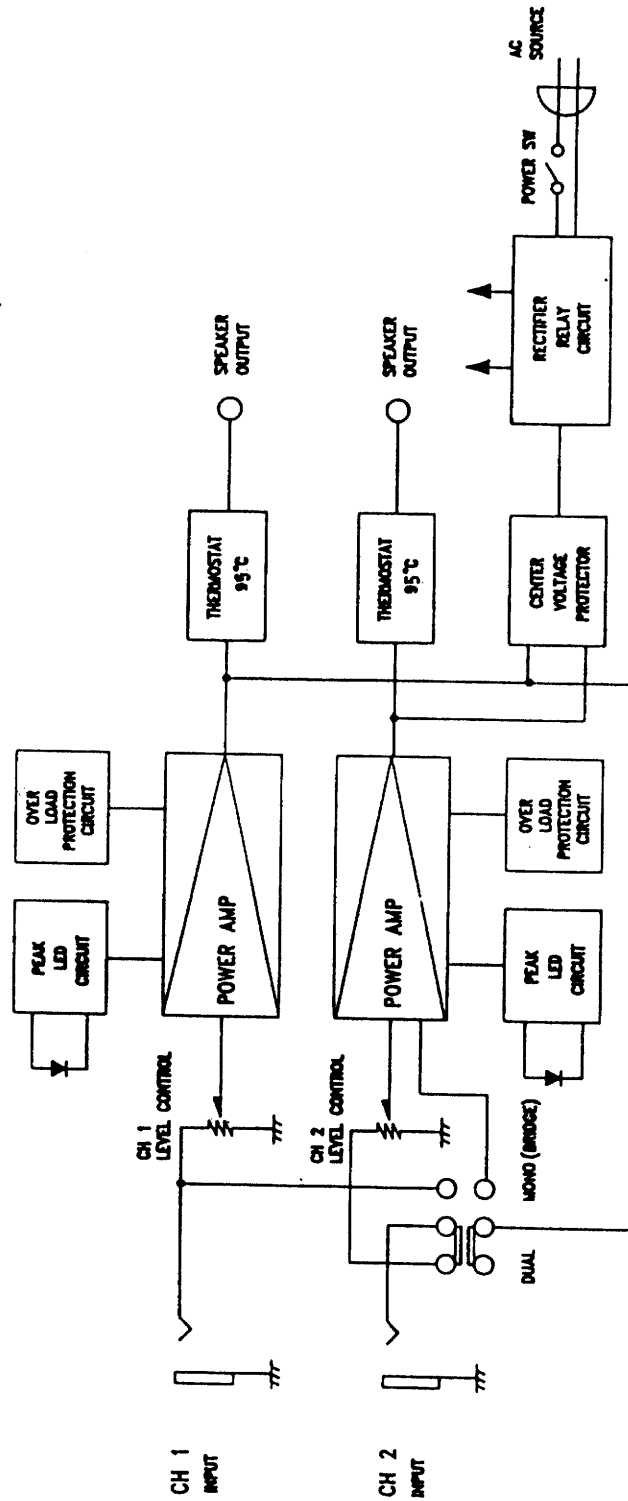

# 5. BLOCK DIAGRAM FOR 600LX

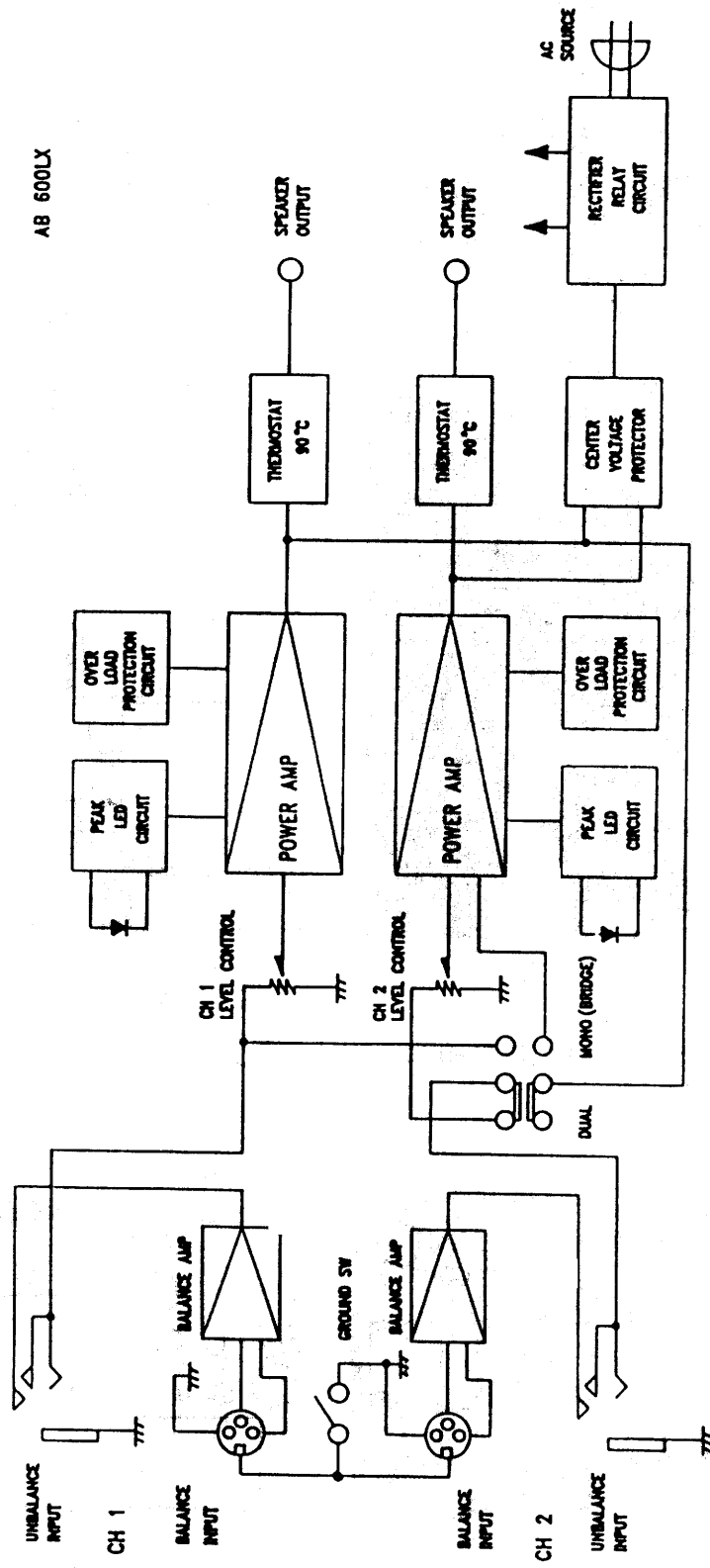

P.C. BOARD PWK-B40 (C) 600LX ONLY

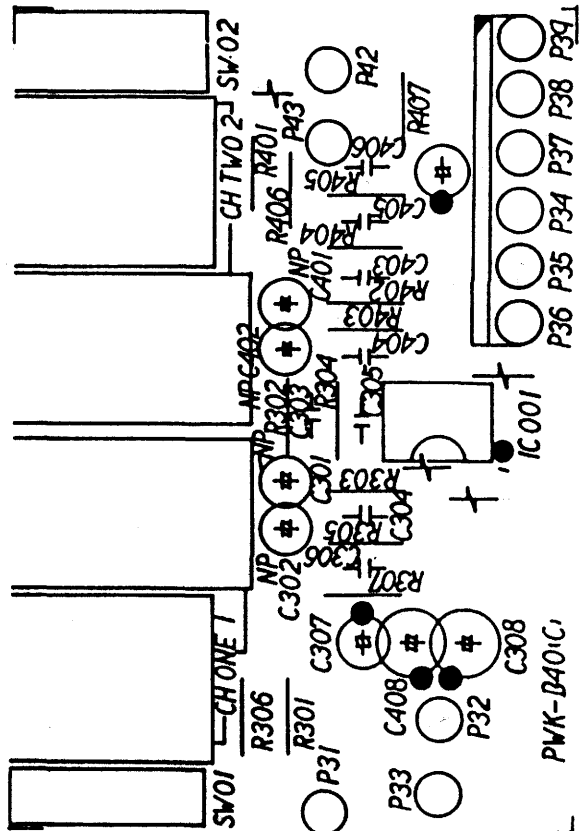
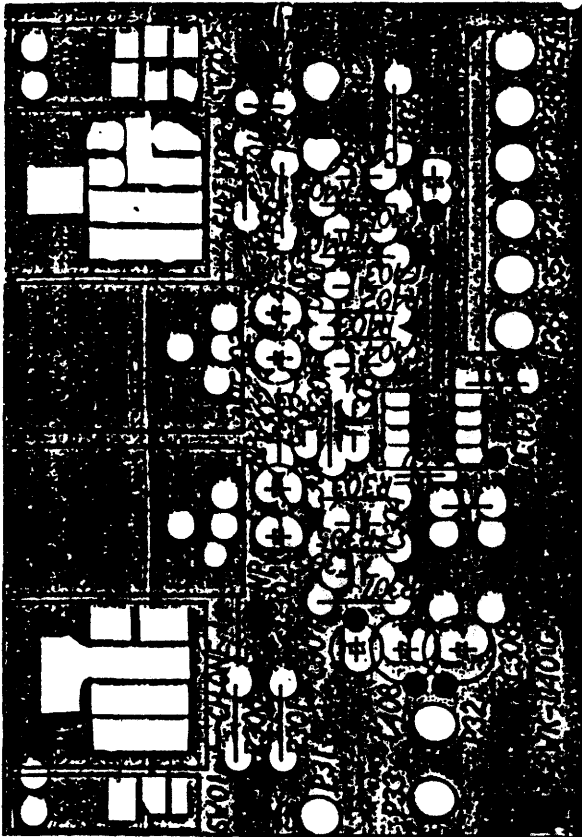

P.C. BOARD PWK-B40 (B) 400, 600A ONLY

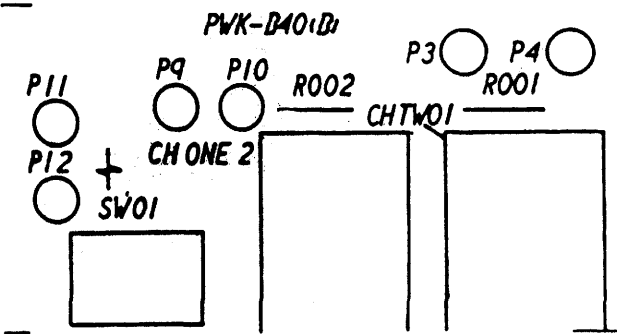
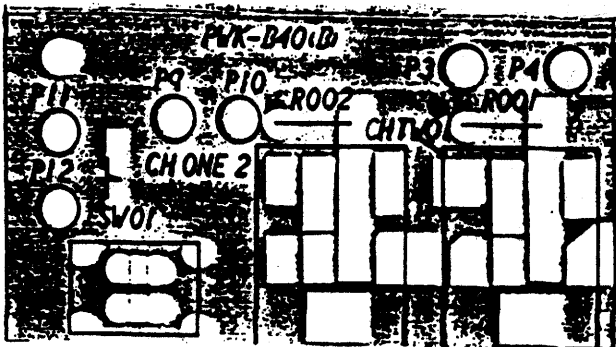

# Z. P.C. BOARD PATTERNS

7-2

P.C. BOARD PWK-B40 (D)

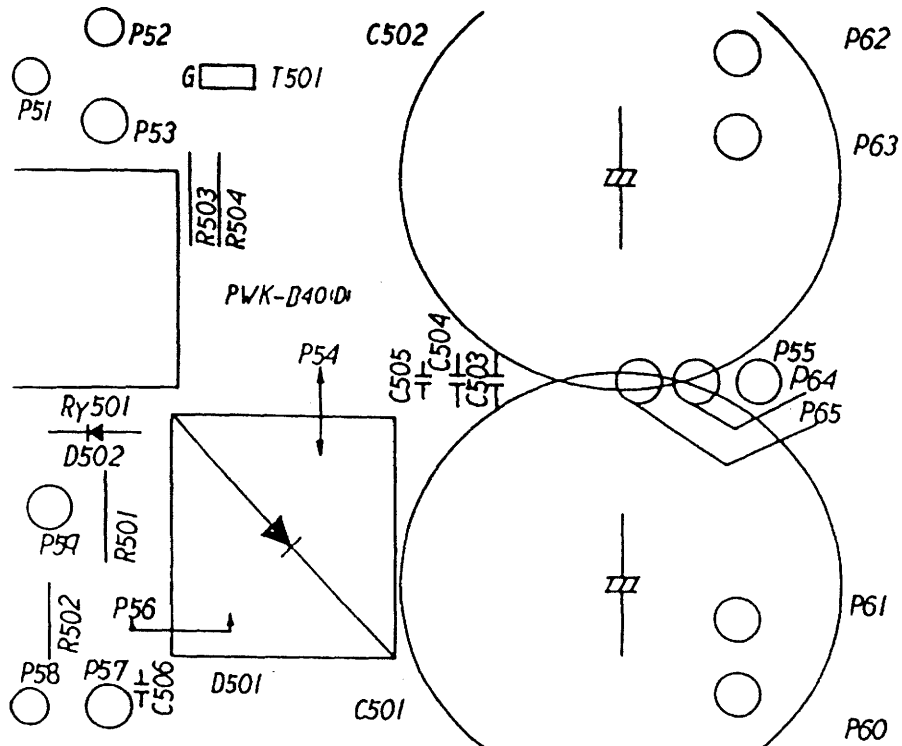
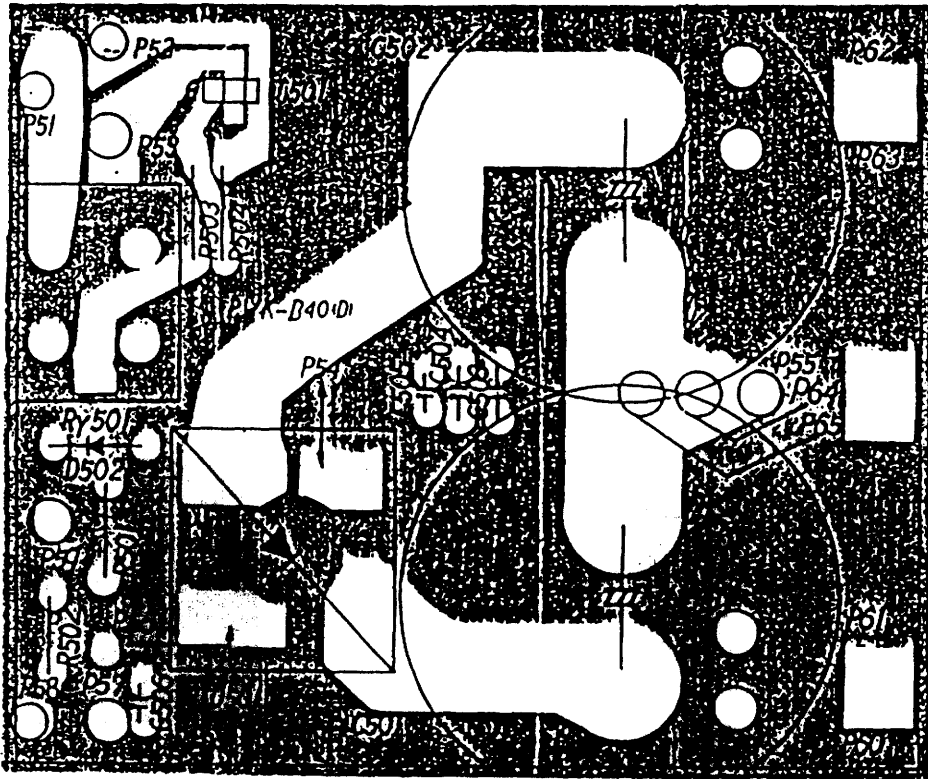

# 7. P.C. BOARD PATTERNS

7-2

P.C. BOARD PWK-B40 (E)

P.C. BOARD AC SW

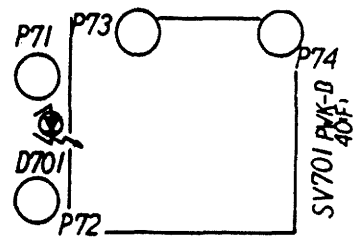
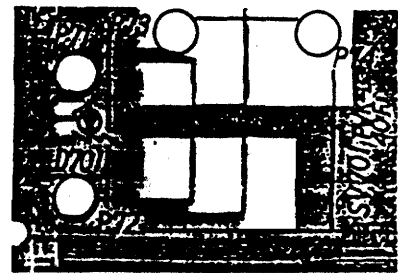
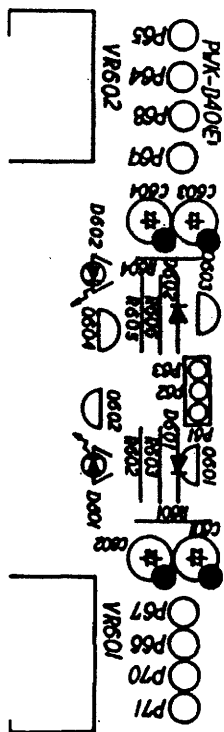
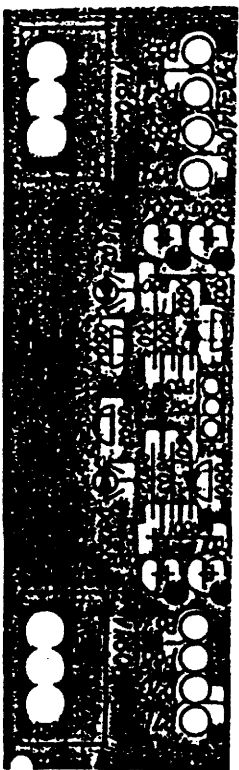

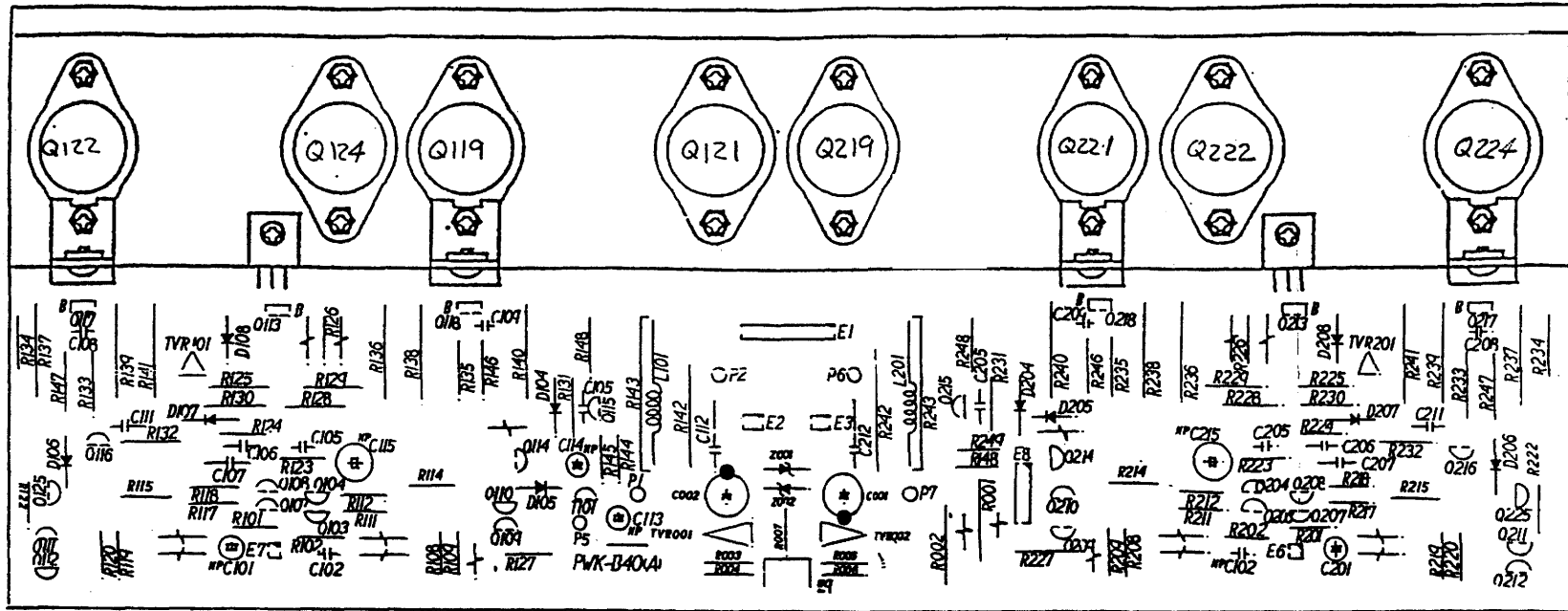

<b>AB INTERNATIONAL, INC.</b>
<b>TITLE: COMPONENT DIAGRAM</b>
<b>MODEL: 400</b>
<b>DATE:</b>
<b>REV.</b>



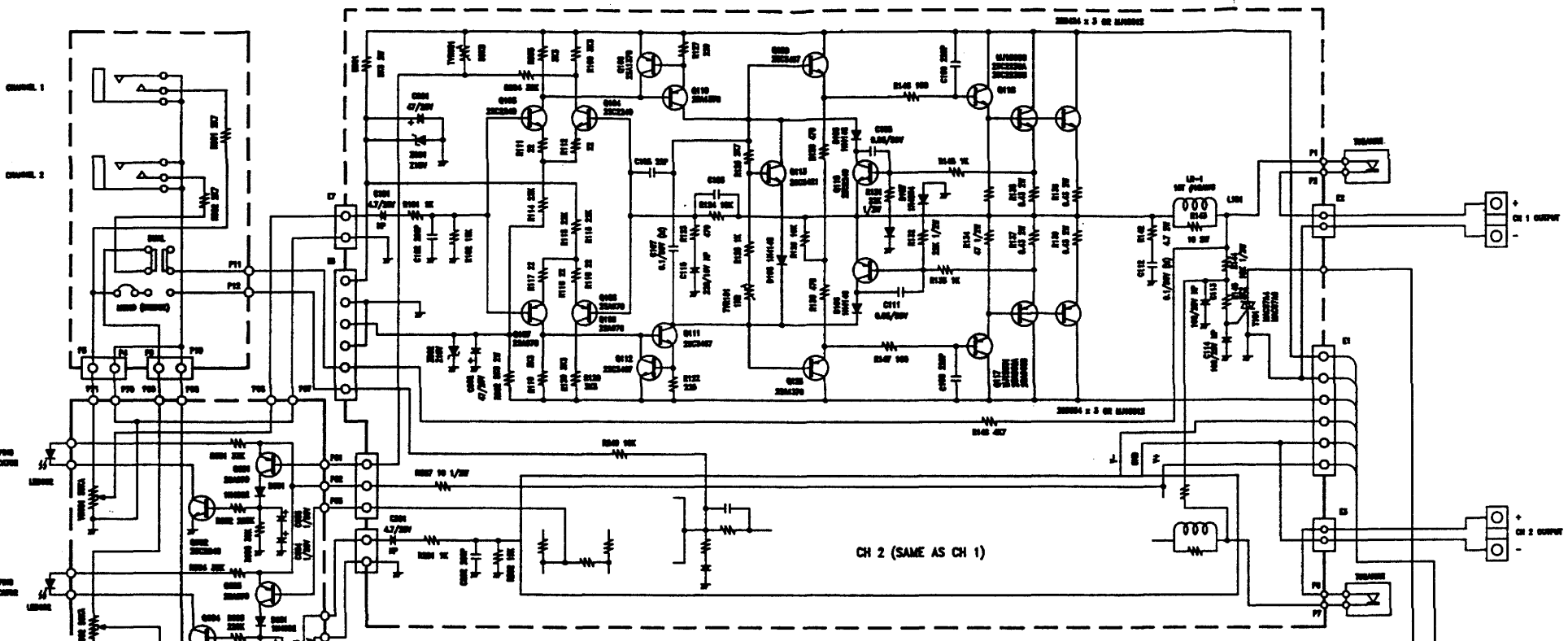

**SERVICE INFORMATION**

1. RESISTOR VALUES ARE SHOWN IN OHMS UNLESS OTHERWISE SPECIFIED. (R=RESISTOR, W=WATTAGE)
2. CAPACITOR VALUES ARE SHOWN IN MICROFARADS UNLESS OTHERWISE SPECIFIED. (P=POLYMER - MICROFARAD)
3. ALL VALUES ARE GIVEN TO 5% UNLESS OTHERWISE SPECIFIED. DO NOT EXCEED THESE DIMENSIONS.
4. NOTES:
  - A - ALL COMPONENTS LISTED MUST BE REPLACED ONLY WITH ORIGINAL TYPE SPECIFIED BY THE MANUFACTURER, AS SHOWN AND INSTALLED AS THE ORIGINAL, WITH SPACERS AND POSITIONED AWAY FROM ADJACENT COMPONENTS WHERE APPLICABLE.
  - B - ALL DIMENSIONS MUST BE DONE IN A PROFESSIONAL MANNER USING CALIBER WHEELS ONLY ONCE.
  - C - ALL SPRINGS, SHIMS AND DISPLACEMENT SPACERS MUST BE REPLACED BEFORE RETURNING APPLIANCE TO CUSTOMER.
  - D - A DAMAGED POWER SUPPLY UNIT MUST BE REPLACED BEFORE RETURNING APPLIANCE TO CUSTOMER.
  - E - A BULBING TEST CONDUCTED BY CHECKING AC SOLELY IS TO BE APPROVED EXCEPT WITH CLAMS OF THE POWER SUPPLY UNIT ASSEMBLY PLUS THE EXTERNAL CONNECTIONS OF THE APPLIANCE FOR A PERIOD OF NOT LESS THAN ONE HOUR BEFORE RETURNING APPLIANCE TO CUSTOMER.

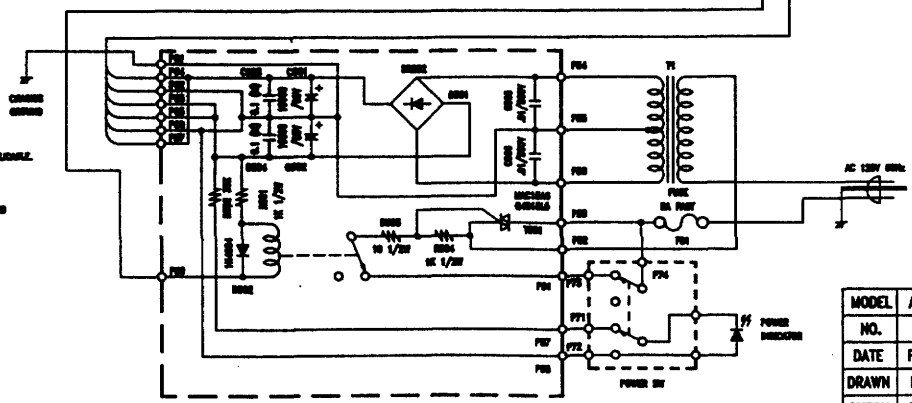
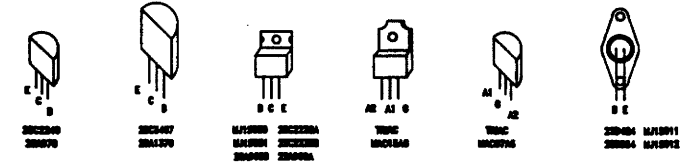

MODEL	AB MODEL 400
NO.	
DATE	FEB. 13, 1989
DRAWN	M. J. YEH.
CHECK	G. L. LIU.

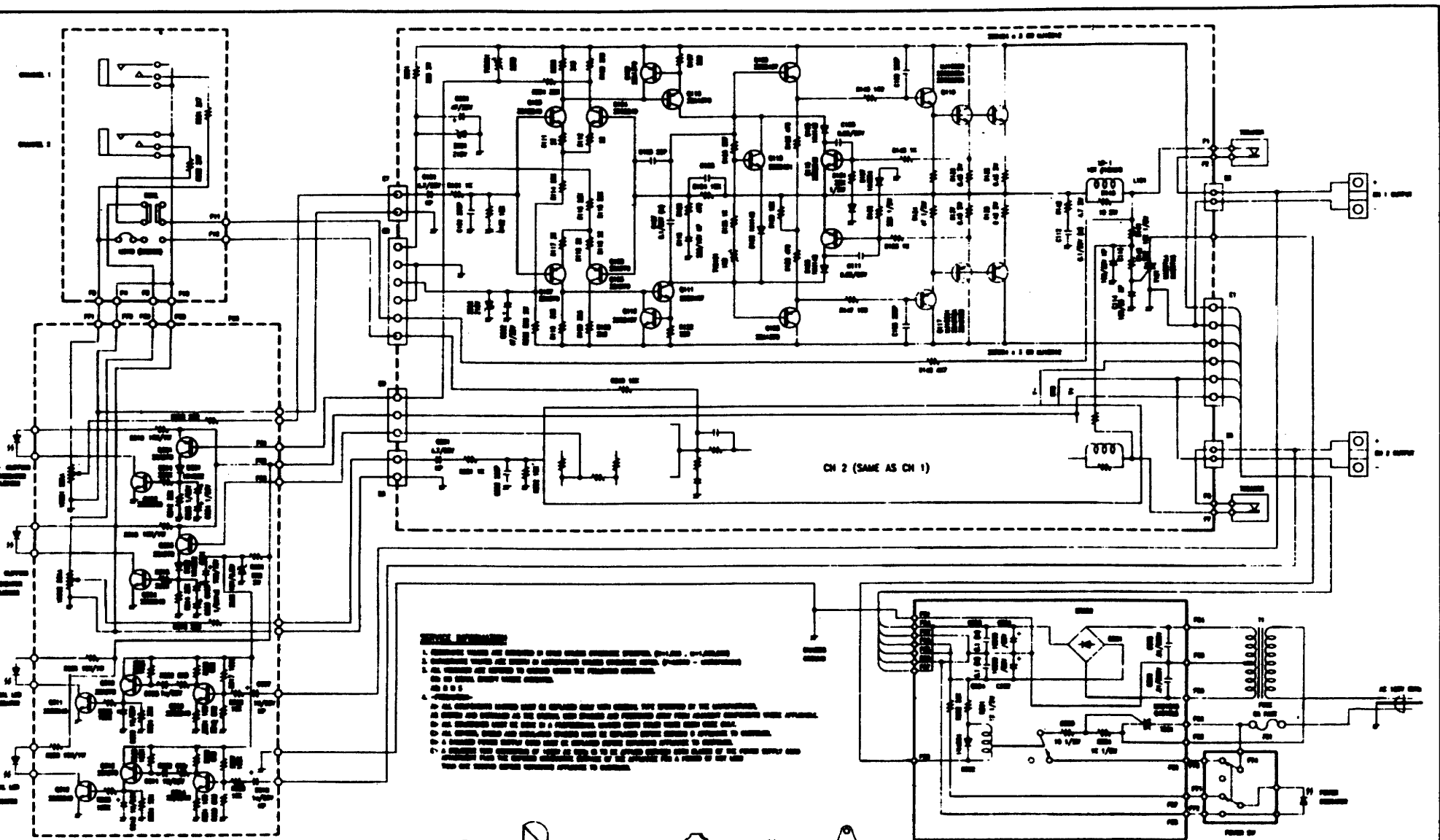

**NOTES:**

1. COMPONENTS SHOWN ARE ASSUMED TO BE OF THE HIGHEST QUALITY AVAILABLE.
2. ALL DIMENSIONS ARE IN MILLIMETERS UNLESS OTHERWISE SPECIFIED.
3. ALL DIMENSIONS ARE TO CENTER UNLESS OTHERWISE SPECIFIED.
4. ALL DIMENSIONS ARE TO CENTER UNLESS OTHERWISE SPECIFIED.
5. ALL DIMENSIONS ARE TO CENTER UNLESS OTHERWISE SPECIFIED.
6. ALL DIMENSIONS ARE TO CENTER UNLESS OTHERWISE SPECIFIED.
7. ALL DIMENSIONS ARE TO CENTER UNLESS OTHERWISE SPECIFIED.

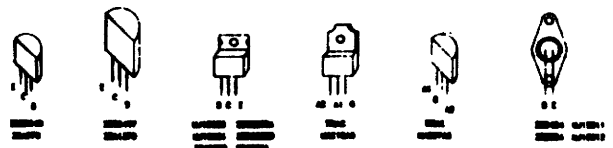

FILE	MODEL	DRAWN	CHECK	DATE
C AB400	AB400	HUANG		MAY 29, 1991

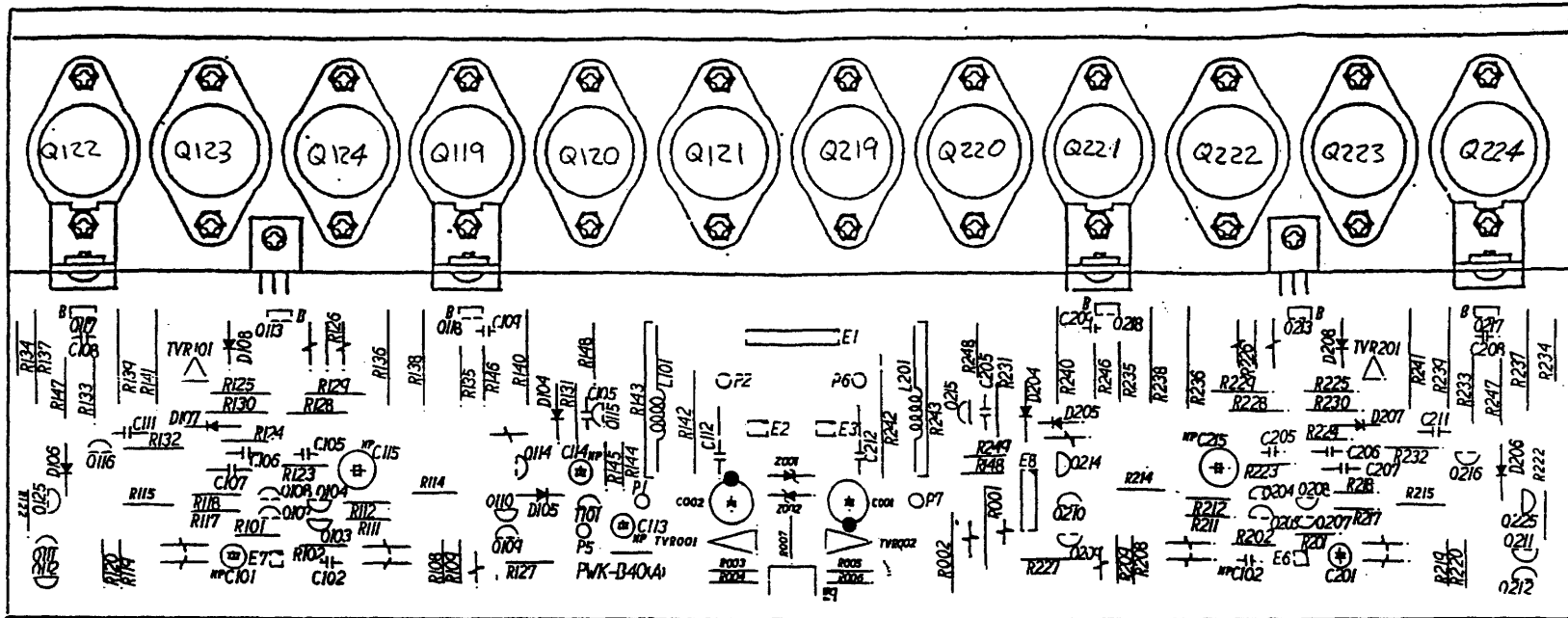

AB INTERNATIONAL, INC.

TITLE: COMPONENT DIAGRAM

MODEL: 600A 600LX

DATE:

REV.

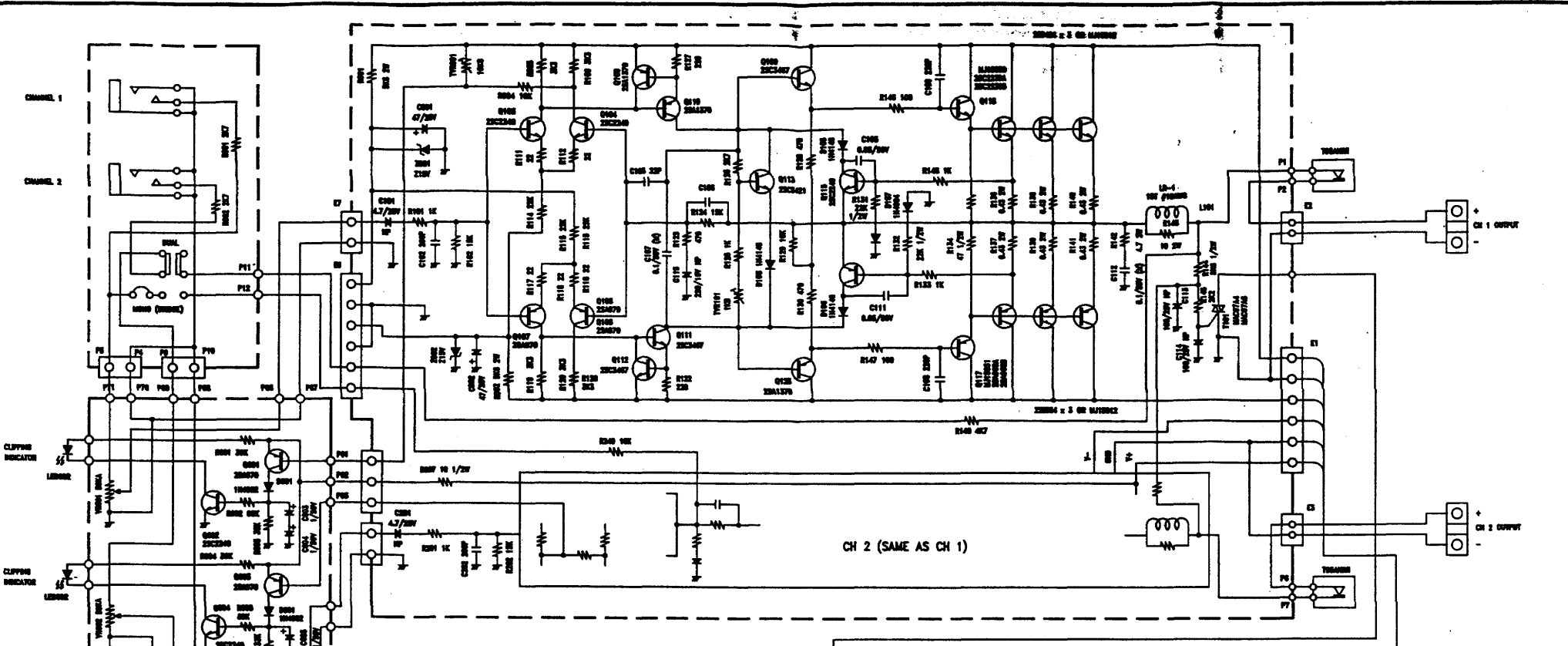

**SERVICE INFORMATION**

1. RESISTANCE VALUES ARE INDICATED IN OHMS UNLESS OTHERWISE SPECIFIED. (R=100Ω, M=1000Ω)
2. CAPACITANCE VALUES ARE SHOWN IN MICROFARADS UNLESS OTHERWISE INDICATED. (P=1000P, M=100000P)
3. ALL VOLTAGES ARE REFERRED TO GROUND UNLESS OTHERWISE SPECIFIED.  
DC IS DC, AC IS AC.
4. -NOTES-  
 (A) ALL COMPONENTS SHOWN MUST BE REPLACED ONLY WITH ORIGINAL TYPE SPECIFIED BY THE MANUFACTURER, AS SPECIFIED AND INSTALLED AS THE ORIGINAL, USING SPACERS AND PREVIOUSLY USED FROM ANALOGUE COMPONENTS WHERE APPLICABLE.  
 (B) ALL SCHEMATIC SHOWN BE DONE IN A PROFESSIONAL MANNER USING SOLID LINE DRAWING ONLY.  
 (C) ALL SWITCHES, SHIELD AND INSULATING SPACERS MUST BE REPLACED BEFORE RETURNING APPLIANCE TO CUSTOMER.  
 (D) A DAMAGED POWER SUPPLY CORD MUST BE REPLACED BEFORE RETURNING APPLIANCE TO CUSTOMER.  
 (E) A BULBING TEST CONSISTING OF 120V AC 60HZ IS TO BE APPLIED BETWEEN BOTH BLADES OF THE POWER SUPPLY CORD ATTACHMENT PLUS THE EXPOSED CONDUCTIVE SURFACE OF THE APPLIANCE FOR A PERIOD OF NOT LESS THAN ONE SECOND BEFORE RETURNING APPLIANCE TO CUSTOMER.

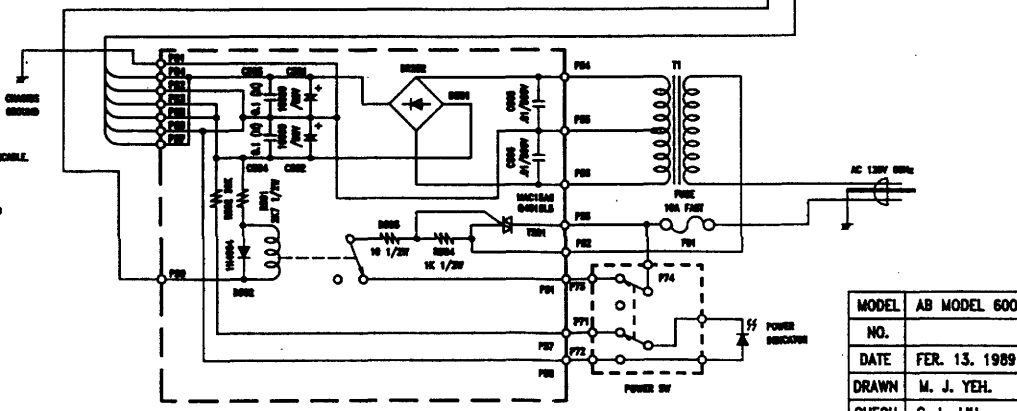
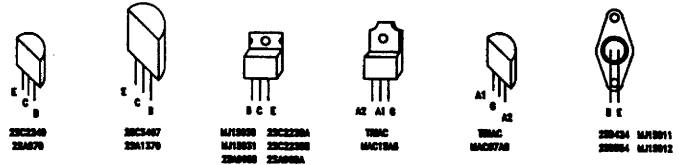

MODEL	AB MODEL 600A
NO.	
DATE	FEB. 13, 1969
DRAWN	M. J. YEH.
CHECK	G. L. LIU.

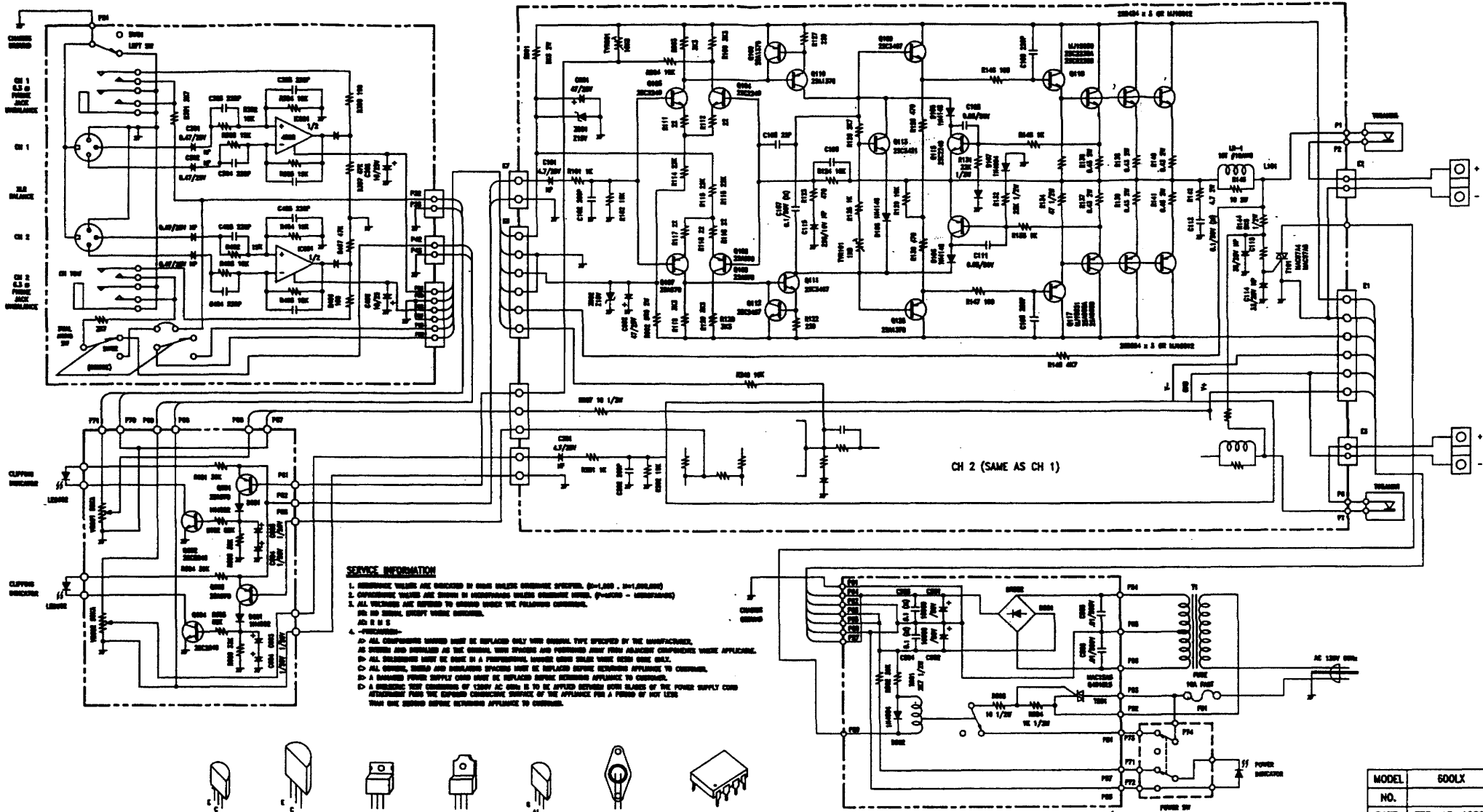

**SERVICE INFORMATION**

1. RESISTOR VALUES ARE GIVEN IN OHMS UNLESS OTHERWISE SPECIFIED (R=1,000 - 100,000Ω)
2. CAPACITOR VALUES ARE GIVEN IN MICROFARADS UNLESS OTHERWISE SPECIFIED (P=PICTURE - INTERPHONE)
3. ALL VOLTAGE ARE REFERRED TO GROUND UNLESS THE FOLLOWING OTHERWISE INDICATED.
4. -RESISTORS-
  - A) ALL COMPONENTS LISTED MUST BE REPLACED ONLY WITH ORIGINAL TYPE SPECIFIED BY THE MANUFACTURER, AS SHOWN AND INSTALLED AS THE ORIGINAL, WITH SPACING AND POSITIONING EXACT FROM ADJACENT COMPONENTS WHERE APPLICABLE.
  - B) ALL SOLDERS MUST BE DONE IN A PROFESSIONAL MANNER WITH SOLDER THAT HAS BEEN USED ONLY.
  - C) ALL SOLDERING, HEATING AND DRILLING OPERATIONS MUST BE COMPLETED BEFORE RECONNECTING APPLIANCE TO CURRENT.
  - D) A DAMAGED POWER SUPPLY CORD MUST BE REPLACED BEFORE RECONNECTING APPLIANCE TO CURRENT.
  - E) A FUSE THAT CONTAINS 0.125V AC TURNS IS TO BE APPLIED BETWEEN BOTH BLADES OF THE POWER SUPPLY CORD ATTACHMENT PLUG THE EXPANDED CONNECTIVE SERVICE OF THE APPLIANCE FOR A PERIOD OF NOT LESS THAN ONE SECOND BEFORE RECONNECTING APPLIANCE TO CURRENT.

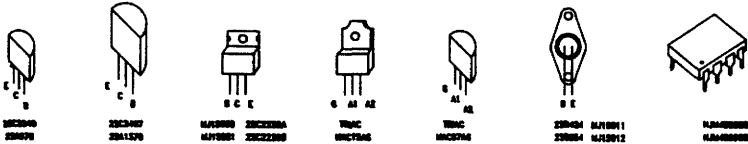

MODEL	600LX
NO.	
DATE	FEB. 13, 1989
DRAWN	M. J. YEH.
CHECK	G. L. LIU.

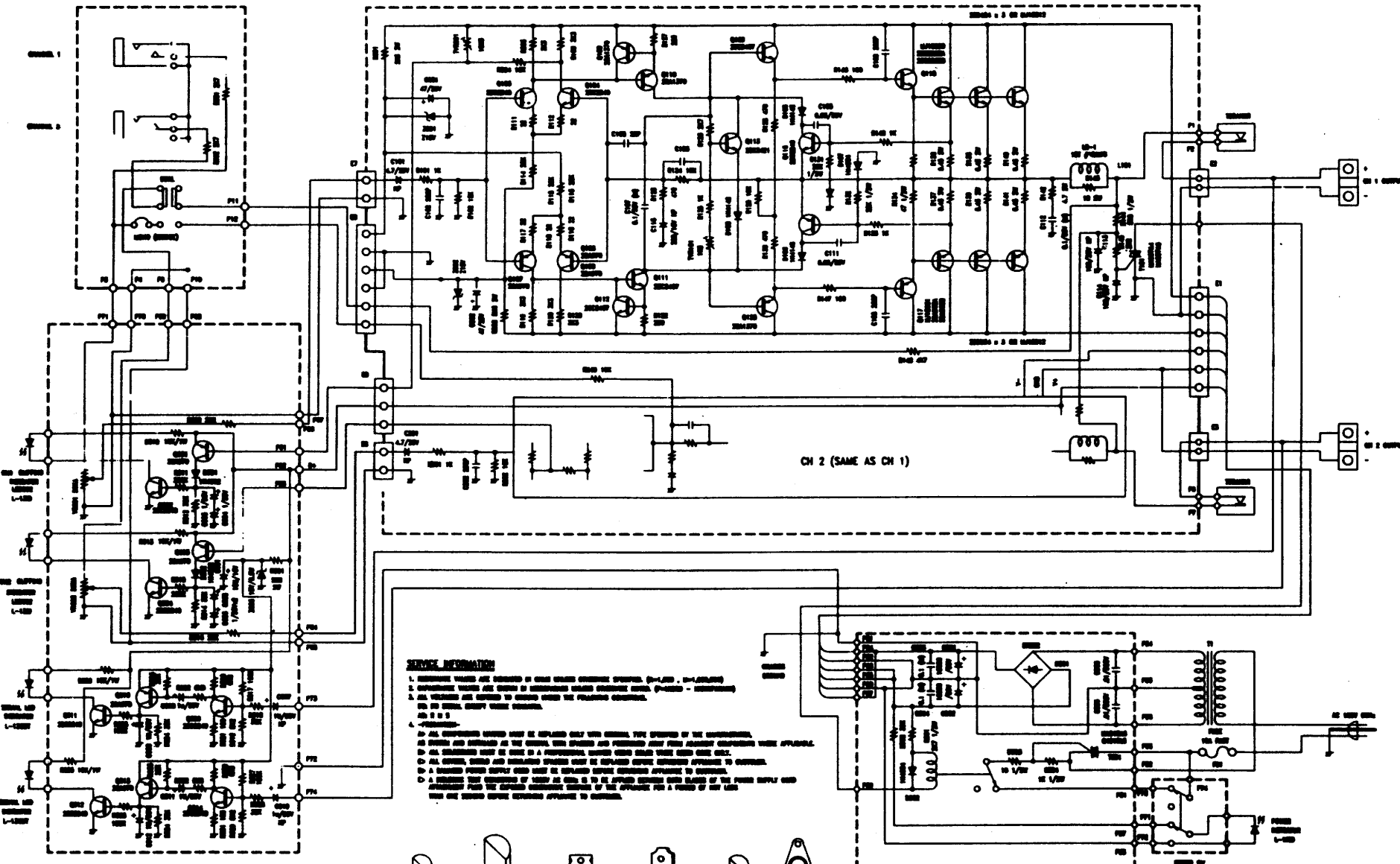

**SERVICE INFORMATION**

1. RESISTOR VALUES ARE GIVEN IN OHMS UNLESS OTHERWISE SPECIFIED (R=RESISTOR)
2. CAPACITOR VALUES ARE GIVEN IN MICROFARADS UNLESS OTHERWISE SPECIFIED (P=PIANO - INTERMEDIATE)
3. ALL VALUES ARE GIVEN TO THREE SIGNS UNLESS OTHERWISE SPECIFIED.
4. NOTES:
  - ALL COMPONENTS SHOWN MUST BE REPLACED ONLY WITH ORIGINAL TYPE SPECIFIED IN THE SPECIFICATIONS.
  - RESISTOR AND CAPACITOR VALUES IN THE CIRCUIT ARE SPECIFIED AND PROVIDED WITH TOLERANCE SPECIFICATIONS WHEN APPLICABLE.
  - ALL DIMENSIONS MUST BE GIVEN IN A STANDARDIZED SYSTEM UNLESS OTHERWISE SPECIFIED.
  - ALL CIRCUITS, SCHEMATIC AND MECHANICAL DRAWINGS MUST BE REPRODUCED EXACTLY AS SHOWN UNLESS OTHERWISE SPECIFIED TO CONTRARY.
  - A STANDARD POWER SUPPLY MUST BE USED IN REPLACING SERVICE EQUIPMENT TO GUARANTEE.
  - A WARNING LABEL MUST BE PLACED ON THE EQUIPMENT TO ADVISE THE USER TO OBTAIN THE SERVICE INFORMATION MANUAL OF THE PRODUCER FOR A LISTING OF THE USE AND CARE OF THE EQUIPMENT SPECIFIED IN THE SPECIFICATIONS.

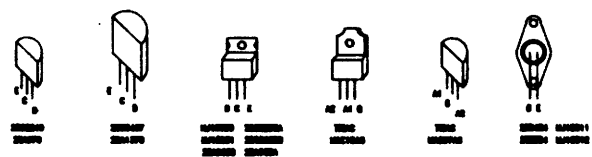

FILE	C_4800A
MODEL	4800A
DRAWN	HMMS
CHECK	
DATE	MAY 23, 1961

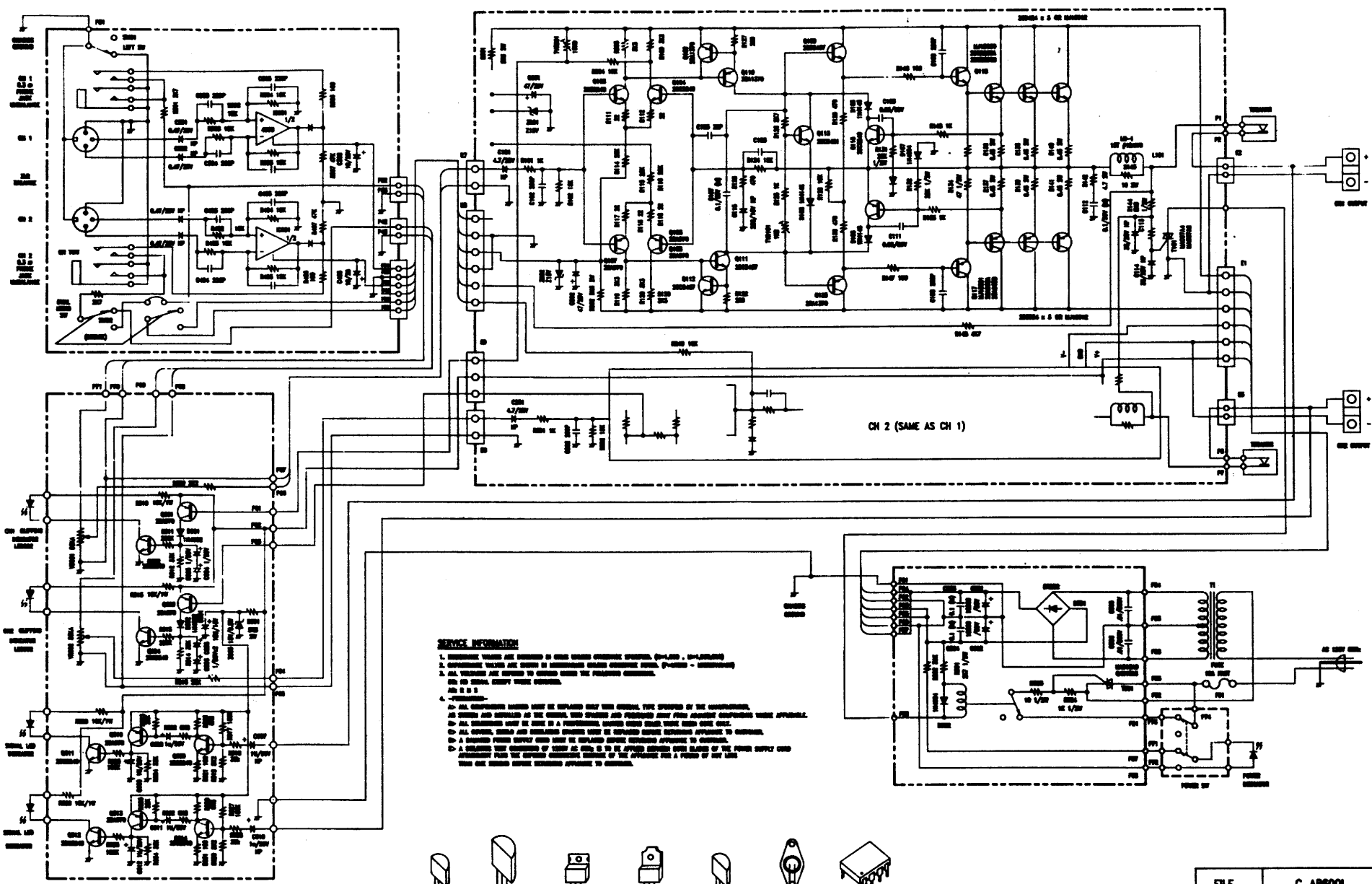

Page 2 of 2  
Page 3 of 3

**SERVICE INFORMATION**

1. COMPONENT VALUES ARE LISTED IN EACH SCHEMATIC SECTION (PAGES 1, 2, 3, 4).
2. COMPONENT VALUES ARE LISTED IN ALPHABETIC ORDER (RESISTOR VALUE, CAPACITOR VALUE - NOMINAL VALUE) AND IN ORDER OF APPEARANCE IN THE SCHEMATIC.
3. ALL VALUES ARE LISTED IN OHMS UNLESS OTHERWISE SPECIFIED.
4. ALL VALUES ARE LISTED IN OHMS UNLESS OTHERWISE SPECIFIED.
5. ALL VALUES ARE LISTED IN OHMS UNLESS OTHERWISE SPECIFIED.
6. ALL VALUES ARE LISTED IN OHMS UNLESS OTHERWISE SPECIFIED.
7. ALL VALUES ARE LISTED IN OHMS UNLESS OTHERWISE SPECIFIED.
8. ALL VALUES ARE LISTED IN OHMS UNLESS OTHERWISE SPECIFIED.
9. ALL VALUES ARE LISTED IN OHMS UNLESS OTHERWISE SPECIFIED.
10. ALL VALUES ARE LISTED IN OHMS UNLESS OTHERWISE SPECIFIED.
11. ALL VALUES ARE LISTED IN OHMS UNLESS OTHERWISE SPECIFIED.
12. ALL VALUES ARE LISTED IN OHMS UNLESS OTHERWISE SPECIFIED.
13. ALL VALUES ARE LISTED IN OHMS UNLESS OTHERWISE SPECIFIED.
14. ALL VALUES ARE LISTED IN OHMS UNLESS OTHERWISE SPECIFIED.
15. ALL VALUES ARE LISTED IN OHMS UNLESS OTHERWISE SPECIFIED.
16. ALL VALUES ARE LISTED IN OHMS UNLESS OTHERWISE SPECIFIED.
17. ALL VALUES ARE LISTED IN OHMS UNLESS OTHERWISE SPECIFIED.
18. ALL VALUES ARE LISTED IN OHMS UNLESS OTHERWISE SPECIFIED.
19. ALL VALUES ARE LISTED IN OHMS UNLESS OTHERWISE SPECIFIED.
20. ALL VALUES ARE LISTED IN OHMS UNLESS OTHERWISE SPECIFIED.

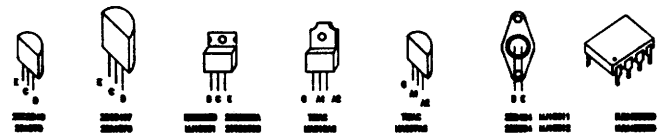

FILE	C_A8800L
MODEL	A8800LX
DRAWN	HUANG
CHECK	
DATE	MAY 29, 1991