

service manual

360

361

acoustic control corporation

7949 WOODLEY AVENUE
VAN NUYS, CA 91406
(213) 997-6631

ACOUSTIC SERVICE MANUAL

Models 360 and 361

	Page
I. General Information	1
A. Description	1
B. Specifications	1
II. Theory of Operations	1
III. General Troubleshooting	3
A. Equipment Required	3
B. Preliminary Checks	3
C. Detailed Testing and Voltage Tables	3
D. Adjustments	13
IV. Schematic Diagrams and Illustrations	
A. Pre Amp Control Head Schematic	14
B. Power Amp Schematic	15
C. Pre Amp P.C. Board Photo 17-1A	16
D. Pre Amp P.C. Board Photo 17-1A	17
E. Fuzz P.C. Board Photo 17-2A	18
F. E.T.F. P.C. Board Photo 17-4	19
G. Regulator P.C. Board Photo 17-7	20
H. Power Amp P.C. Board Photo 17-9	21
V. Control Locations	23
VI. Speaker and Network Wiring	24
VII. Troubleshooting Chart	25
VIII. Parts List	26
IX. Specifications	31

I. GENERAL INFORMATION

A. Description

The model 361 is a bass guitar amplifier. The unit consists of two pieces — a preamplifier control unit — and a speaker enclosure which contains a power amplifier unit.

The preamplifier has the following features:

- High & Low Gain Inputs
- Bright Switch
- Variamp
- Fuzz
- Electronic Tuning Fork

B. Specifications

The speaker enclosure is a folded horn configuration with an 18" speaker acting as a compression loaded driver. The power amplifier is nominally rated at 200W RMS. power output. A foot switch control panel is provided to activate the fuzz and/or the tuning fork.

II. THEORY OF OPERATION

For the following discussion it will be necessary to refer to the schematic diagram — Fig. 1 Page 14

Preamp Section — Beginning with the control unit, the signal inputs are J1 and J2. J1 is the high gain input and J2 is a low gain input. Stage Q1 is an emitter follower. This stage has unity gain and provides a high input impedance for J1 and J2. Q2 is an amplifying stage which also provides gain control with R7 in a feedback configuration. Q3 is an emitter follower which provides a low impedance source of drive for Q4. Q4 also provides some gain and drive for the tone control circuitry. Q5 provides a gain of 2 at all frequencies when R24 is in the midposition. When R24 is fully clockwise, the emitter of Q5 is returned to ground signalwise through R25 and the series resonant circuit formed by L1 and the particular capacitor selected by S4. Now the gain of stage Q5 is increased in the band of frequencies selected. When R24 is fully counterclockwise the collector of Q5 is shunted to ground signalwise thus causing a significant gain reduction for the band of frequencies determined by the LC series resonant circuit. Q6 is again an emitter follower acting as a buffer stage for Q5. R29 is mechanically ganged to R7. J3 thru J6 are output jacks from which low level signals are available for the power amplifier section contained in the speaker cabinet.

Fuzz Section — Reed relay RY1 is used to switch the fuzz section in or out. Signal from Q1's emitter is always applied to the fuzz section. The relay determines whether or not Q2 takes its signal directly from Q1 or from the fuzz section.

Q7 is used as a zener diode by reverse biasing its emitter-base junction. The zener voltage is about 7-1/2 volts which remains essentially constant and supplies operating voltage for Q8 and Q9.

Q8 and Q9 are two high gain, low dynamic range amplifiers. Q8 is somewhat overdriven while Q9 is heavily overdriven. R40 determines from which stage signal is taken. A mixture of Q8 and Q9 signal is also available depending upon the setting of R40. Q10 is again an emitter follower acting as a buffer stage.

E.T.F. Section – Q11 and Q12 are series connected and act as zener diodes to stabilize the supply for the unijunction oscillator – Q13. The operating frequency of the oscillator is determined by the settings of R49 and R50 in conjunction with C33. The network consisting of C31, C32, R47 and R48 is a wave filter which changes the sawtooth wave at C33 to a waveshape which has no abrupt discontinuities. This new signal is fed to the input of the preamp Q1 via a 1 meg resistor R46. This resistor also provides high impedance isolation of the ETF circuitry from the input when the ETF is turned off. Switch S6 turns the ETF circuit on and off by interrupting the supply voltage. Foot switch control of the ETF is realized by shorting R54 to ground. This does not overload the supply because R54 limits the current drawn from the +36V supply.

Pre-Amp Power Supply Section – The power transformer T1 has a 227 VAC at 60 Hz primary winding. Power is turned on and off by S2A. C34 is a noise suppressor. C35 and S3 determine which side of the line is at chassis potential. R55 limits the current for the pilot lamp P.L.I. J8 is an auxiliary power outlet which is also controlled by S2A. The secondary of T1 feeds a full wave bridge rectifier BR-1 and filter capacitor C36. S2B is mechanically gaged to S2A and serves to connect R56 across C36 when the primary circuit is opened. This results in C36 being discharged after power is turned off. Q14 is connected as a series regulator to obtain +25V. Q15 supplies drive current to Q14 and also compares the output voltage (+25) with the supply reference Q16. Q16 is again connected as a zener diode. R61 is used to adjust the +25V.

Power Amplifier Model 361 – The model 360 preamp is used in conjunction with the model 361 power amplifier which in turn is mounted in the folded horn speaker cabinet. For the following explanation refer to the schematic diagram Fig. 2 on Page 15

Input to the power amp is applied via J1. Q1 and Q15 are connected as a differential amplifier. Q2 is a class A stage with fairly high gain. Q3 and Q4 do not amplify signal and are not really part of the basic amplifier. These two act as part of a short circuit protection scheme. Q5, 7, 9, 11, and 13 and Q6, 8, 10, 12, and 14 groups are compound emitter followers providing high current gain but unity voltage gain. The upper group conducts on positive going signal excursions while the lower group conducts on negative going signal excursions.

The gain of the amplifier is determined entirely by R11 and R9. These two resistors divide down the output voltage and apply the result to Q15's base as negative feedback. R5 adjusts the DC conditions of the amp for symmetric clipping under load. R24 adjusts the bias current of the output transistors for no crossover distortion. C7 is a bootstrapping system which allows the upper output transistors to drive fully positive under load. Diodes D1 and D2 prevent overdriving of the differential amplifier. The 0.1Ω resistors in the emitters of the output transistors are stabilizing resistors. Current through R26 and R7 is sampled by Q3 and Q4. When sufficiently large currents flow through these resistors, Q3 and Q4 are biased on. This action clamps the bases of Q5 and Q6 to the output line thus preventing further current increase. This therefore is a current limiting short circuit protection scheme. D6 limits drive to Q2. D3 and D4 prevent reverse currents from flowing thru Q3 and Q4 during alternate signal excursions. The power supply circuit is conventional with T1 a step-down transformer. BR-1 is a bridge rectifier driven by the secondary of T1. R37 is a surge limiting resistor which protects the bridge rectifier during initial turn-on as C1 charges to full voltage. An external speaker may be connected at the auxiliary output jack. A $5\Omega/100W$ resistor R38 limits the loading effect to a safe value.

III. GENERAL TROUBLESHOOTING

A. Equipment Required

- 1) FET VM or VTVM.
- 2) VOM with 20 k/v.D.C. rating.
- 3) 5A variac with line voltage meter.
- 4) Audio signal generator with output level control and calibrated frequency dial.
- 5) Oscilloscope with good sync capability and calibrated vertical amplifier.

B. Preliminary Checks

It is often difficult to establish meaningful communication between the equipment user and the technically qualified man whose duty it is to effect the repair of the equipment. With this in mind, the repair technician should either have the customer actually demonstrate the problem or connect an instrument to the amplifier and determine the problem himself. It is necessary to first determine if the trouble exists in the preamp control head or in the power amplifier unit in the speaker box. Connect an audio signal generator to a signal line and connect the line directly into J7 of the power amplifier. (See schematic on page 14.) Set the frequency between 50 and 100 Hz. Increase drive from generator gradually until a fairly loud signal is heard from the speaker. The tone should be smooth and round, free of distortion or scratching noises. An instrument may actually be directly connected to J1 to test the power amplifier and speaker but sufficient drive may not be available depending on the brand of instrument. If the power amplifier unit appears to be operating correctly, the problem may be assumed to exist in the preamp.

Once the problem has been determined to exist in one or the other units the next step is to check the fuses and the power card. Remove the chassis from the case and give a thorough visual inspection of the wiring and the components on the circuit cards. If the problem has been determined to exist in the preamp control head, measure the power supply voltage at the input filter capacitor C36(+) and the emitter of Q14, the series regulator. These voltages should be +36V and +25V respectively. If these are OK, proceed as outlined in the section on detailed testing. If the problem exists in the power amplifier unit, measure the voltage also at the input filter capacitor C1(+). This should be +80V. If this is so, proceed as outlined in the section on detailed testing. In both cases be sure that the line voltage is 120 VAC. Tolerances on voltage readings are $\pm 10\%$. When visually inspecting the chassis, be ready for anything as someone may have been into the equipment at a previous time.

C. Detailed Testing and Voltage Tables

- 1) Control Head Preamp – In the section on preliminary checks, the power supply voltages were measured. If these were normal proceed by signal tracing until the troubled area is located. When this is found, remove signal from the unit and measure the D.C. voltages which will reveal the problem.

Preamp – The following conditions should be met before going ahead with A.C. signal tracing.

Line voltage = 120 VAC.
 Bright sw. = normal Range = #1
 Volume = full cw Effect = mid (vertical)
 Treble = full cw Attack = full ccw
 Bass = full cw Gain = full ccw (sw, off)
 ETF = off (until actually testing this circuit)
 Input signal level = 100 mvpp at J1; frequency = 300 Hz.

(Note: all levels given in peak-to-peak figures).

Turn on oscilloscope and connect scope ground to chassis. With the scope probe, measure voltages at the points given in the following A.C. tables.

Q1	Base	97 mv	Q5	Base	400 mv
Q1	Emitter	94 mv	Q5	Collector	800 mv
Q2	Base	92 mv	Q5	Emitter	400 mv
Q2	Collector	1.2V	Q6	Base	800 mv
Q3	Base	1.2V	Q6	Emitter	800 mv
Q3	Emitter	1.2V	J3 – J6		0.64V
Q4	Base	1.2V			
Q4	Collector	4.7V			

Bright Switch – Testing bright switch – all conditions remain the same as previously stated except for the following:

Frequency = 10 KHz; volume = 1/2
 Bright sw. = normal

Adjust input level for 87 mv at Q3 emitter. Change bright switch to "BRIGHT" position and level at Q3's emitter should increase to approximately 500 mv or +16 db..

Tone Controls

Frequency response tests:

Volume = full cw

Bright sw. = normal

Remaining conditions as before except for the following as tabulated.

Treble and Bass = full cw

Test Point	Frequency	Level
Q5 Base	300 Hz	400 mv
Q5 Base	50 Hz	1.6V
Q5 Base	5 KHz	3.7V

Treble and Base = full ccw

Q5 Base	300 Hz	310 mv
Q5 Base	50 Hz	240 mv
Q5 Base	5 KHz	380 mv

Variamp — Testing of the 'variamp' section involves checking to see that the five selectable frequencies are approximately where they should be and that these frequencies may be boosted or cut by the correct amounts. The following table shows the center frequencies of the LC network for the different switch positions and shows also the amount of boost or cut.

Conditions: Treble and bass = full ccw
 Volume = full cw
 Point of measurement = Q6 emitter
 Input at J1 = 100 mv

Range	Effect	Frequency	Level
#1	cw	65 Hz	1.7V
#1	ccw	65 Hz	35 mv
#2	cw	100 Hz	1.85V
#2	ccw	100 Hz	23 mv
#3	cw	136 Hz	1.9V
#3	ccw	136 Hz	22 mv
#4	cw	400 Hz	1.9V
#4	ccw	400 Hz	30 mv
#5	cw	800 Hz	1.85V
#5	ccw	800 Hz	40 mv

Fuzz Section – The fuzz section is really an overdriven amplifier system. Q8 is less overdriven than Q9. The attack control, R40, selects signal from either Q8 or Q9 or a mixture of both. The waveforms are not critical but pictures are provided as a guide. Conditions are the same as described in the beginning of the preamp testing section with the following exceptions:

Gain = full cw

Point of measurement = Q10 emitter

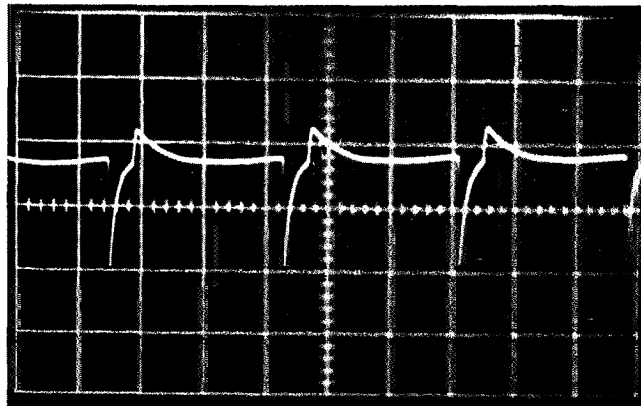

Attack	Frequency	Level
cw	1000 Hz	5V P.P.

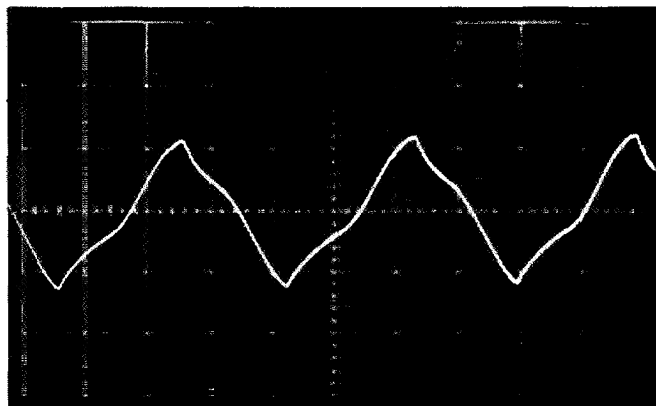

Attack	Frequency	Level
ccw	1000 Hz	2.5V P.P.

E.T.F. — The electronic tuning fork is a inunction oscillator. A check of waveforms and timing is all that is necessary for A.C. measurements.

Conditions: Switch on (up) —
Point of measurement = 013 emitter (C33)

Coarse & Fine = Full cw

Coarse & Fine = Full ccw

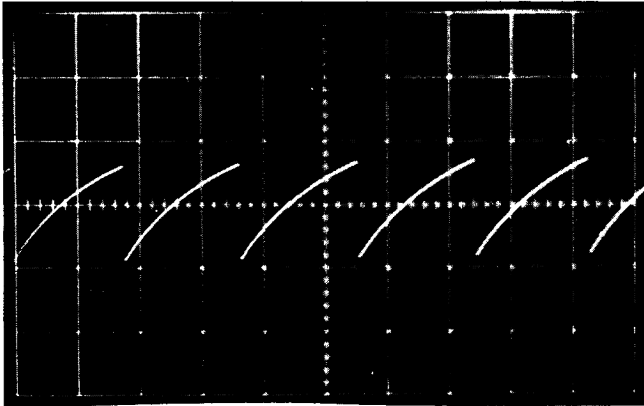

→ 350 ms ← 5 V P.P.

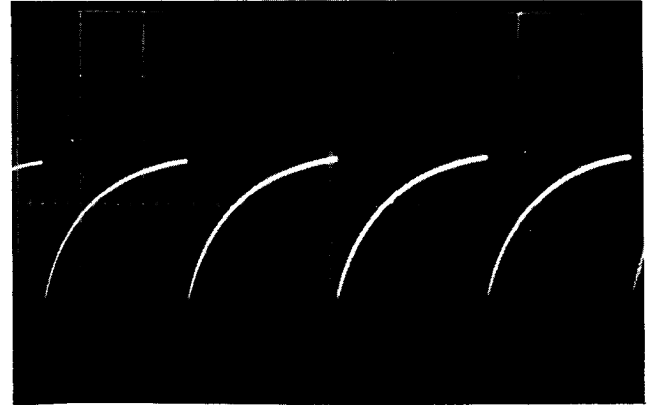

→ 11 ms ← v.5 V PP.

Remove input signal from J1 and put scope probe on Q3's emitter

Volume = full cw
Coarse and fine = full cw

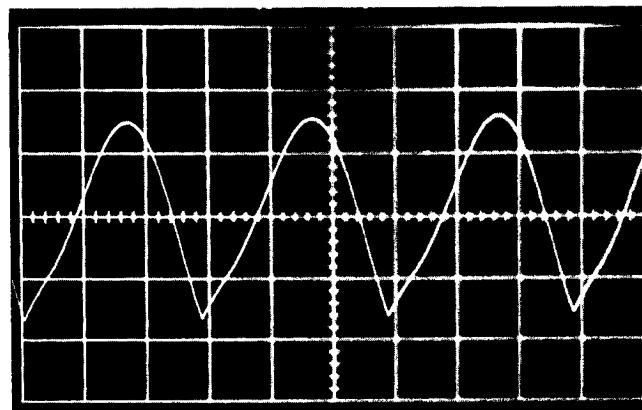

1 V P.P.

The foregoing consists of the A.C. testing and signal tracing troubleshooting information. When a circuit area does not conform to the data given, the D.C. conditions of that area should be measured and compared to the tabulated data following.

The conditions under which the DC data is measured are as follows:

Volume	= full ccw	Range	= #1
Input	= no signal	Effect	= mid
Bass	= ccw	Attack	= full ccw
Treble	= cw	Gain	= full ccw (sw. off)
Bright sw.	= normal	ETF	= off
Line	= 120 VAC at 60 Hz		

Q	Collector	Emitter	Base
1	+25V	+19.5V	+20.1V#
2	+11V	+0.9V	+1.5V#
3	+25V	+10.3V	+11V
4	+7V	+3.4V	+4.0V#
5	+12V	+6.3V	+7V#
6	+25V	+11.3V	+12V
7	0	+7.5V	—
8	+1.5V	0	+0.5V#
9	+0.56V	0	+0.5V#
10	+25V	+20V	+20.7V#
11	+6V	+12V	—
12	0	+6V	—
13	—	—	Base ₁ +12V

//Use FETUM or VTVM.

- 2) Power Amplifier Detailed Testing – The power amplifier is probably the most difficult area in which to locate a specific problem because it is a highly feedback system and a single problem can throw the entire voltage levels scheme out of balance. An attempt will be made to indicate some common symptoms and their probable causes along with proper operating voltages, both A.C. and D.C. It would be wise to apply line power gradually by using a 5 amp variac setup. The power amp will be tested under two major modes – with load and without load. It would be very helpful if a

5 amp current meter were inserted in series with the +80V line. There are failures which can occur that do not allow full line voltage to be applied without blowing the fuse or burning up the surge limiter R37 or burning up some other component. This is because excessive current flows through the +80 line. The current meter will detect this immediately as the variac dial is increased slowly from zero.

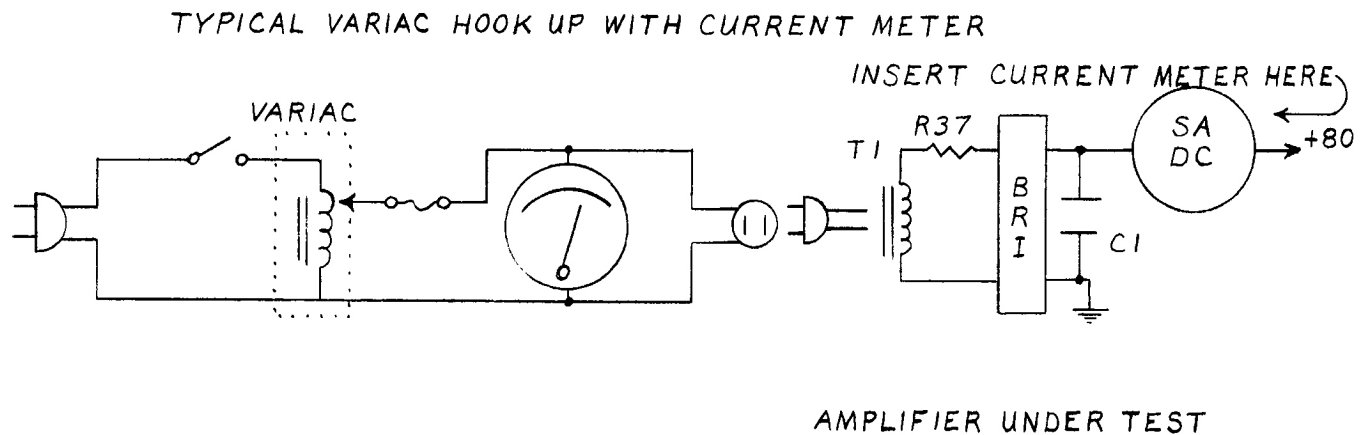

- a) Large +80V supply currents under no load can be caused by:
- (1) Any shorted transistor from Q5 through Q14. More than one transistor may be shorted. To find shorted transistor, use your VOM set on Rx1 scale. Remove primary power and apply meter leads to the emitter and collector terminals of each transistor successively. Any transistor giving a low or shorted indication should be *removed* from the circuit and re-checked in the conventional manner. Any transistor giving a doubtful reading should also be removed and carefully checked. Generally a truly shorted unit will indicate so regardless of the polarity of the meter leads.
 - (2) R14 or D7 open.
 - (3) Short to ground in the wiring harness containing the +80V line or on the P.C. board.
 - (4) Foreign material.

- b) Often the output line (+ end of C9) will be at +80V when amp is turned on. This can be caused by:
- (1) Q2 open.
 - (2) D6 shorted.
 - (3) Q15 shorted collector-to-emitter.
 - (4) Q1 open; R11 open.
 - (5) R5 open.
 - (6) Break in P.C. board.
 - (7) D5 open; R7 open; R18 pen; R8 open; R36 open.
 - (8) C5 shorted; C6 shorted.
- c) The output line may be at ground. This can be caused by the following:
- (1) Q2 shorted collector-to-emitter.
 - (2) Q15 open; R4 open.
 - (3) Q1 shorted.
 - (4) C4 shorted; C3 shorted.
- d) The output line may be at +20V or close to it. This may be caused by:
- (1) R10 open.
 - (2) R9 open.

When the output line is at around +40V, Q1, Q2 and Q15 are operating correctly. If this is so, apply drive to J1 at a frequency of 1000 Hz. The output should swing a full 80 Vpp at clipping with a good sine wave output and no load. This does not necessarily mean that the amplifier is operating correctly, as no load has yet been applied. One could entirely remove Q7 through Q14 and under no load the amplifier would behave well. The following table shows D.C. voltages when the output line "locks in" at around +40V (assuming R5 wiper is at +20V). Line at 120 VAC

Point	Voltage	Point	Voltage
C4 (+)	+20V	C7 (+)	+67.5V
C1 (+)	+80V	C9 (+)	+40V
C6 (+)	+20V	Q2 collector	+40V
Q1/Q15 emitter	+21V	Q2 base	+0.7V
Q2 emitter	+0.15V	Q6 collector	+0.7V
Q15 collector	0V	Q6 emitter	+40V
Q15 base	+20V	Q6 base	+39.3V
Q5 collector	+80V		
Q5 base	+40.6V		
Q5 emitter	+40V		

Certain amplifier problems will show themselves only under load and with signal applied. Following will be some common symptoms and their typical cause:

- a) Negative half of signal OK – positive clips quite early.
 - (1) Q3 shorted.
 - (2) D4 shorted.
 - (3) Q7 open.
 - (4) Q5 open with emitter/base junction OK or shorted.

- b) Positive half of signal OK – negative clips quite early.
 - (1) Q4 shorted.
 - (2) D3 shorted.
 - (3) Q8 open.
 - (4) Q6 open.

When an amplifier is operating under load, it is important to ensure that all of the output transistors are working. With certain beta combinations only two or even one of the three output transistors of a group may be doing the work without showing itself on the output waveform. However this condition is bad because the power dissipation is not properly shared, even though the output signal is OK. To test the output transistors for equal current sharing, load the amplifier with 4Ω and drive to just clipping. Be sure your oscilloscope ground is isolated from the power lines. Apply the scope ground to the output line (+ end of C9) and apply the probe successively to the emitter of each output transistor Q9, Q11 and Q13. The same peak voltage should exist at each emitter. The waveform will be as shown below:

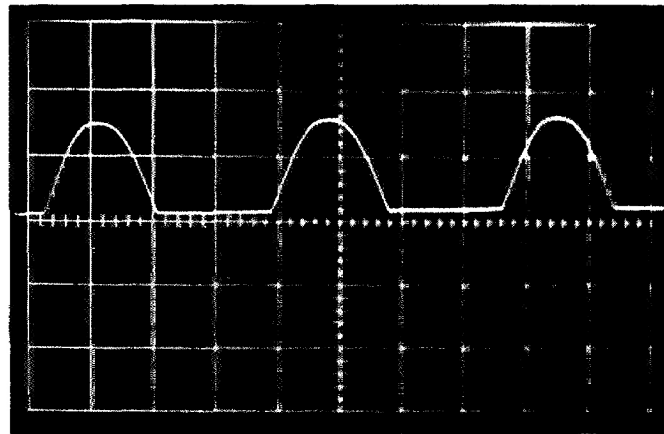

0.85 V P.P.

To check the negative half, place the scope ground at ground of the amplifier and apply the probe successively to the emitters of Q10, Q12 and Q14. The resulting waveforms should be the same for each emitter and the same as shown just above.

The amplifier should operate under a shorted output. To check the current levels for both the positive and negative directions, connect the scope in the same fashion as for the current sharing tests. With the input signal level at J1 sufficiently high to cause clipping under 4Ω load, short the output while observing voltage across any of the 0.1Ω resistors in the emitter on any transistor first in the positive group and then in the negative group. The waveform should appear as below:

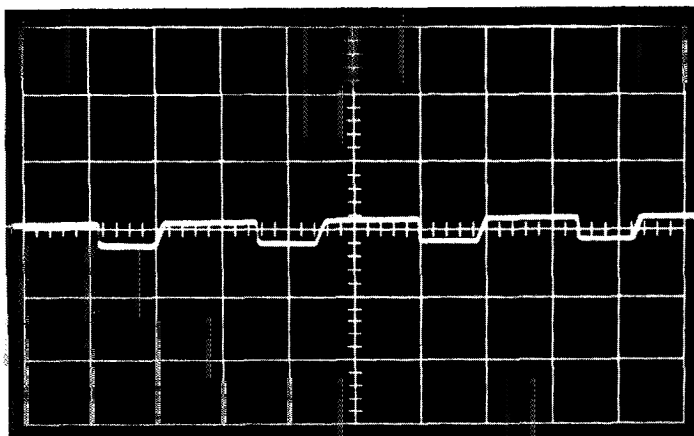

Amplifier gain — no load; $f = 1000$ Hz.

Input at J1 = 225 mvpp

Output = 50 Vpp

Gain = x220

Power Output (4Ω) = 150W rms (min) = 70 Vpp

at 120 VAC line voltage

$f = 1000$ Hz.

D. Adjustments

- 1) Preamp Control Head – The only adjustment necessary in the preamp control head is R61. Adjust this control while measuring Q14's emitter until Q14's emitter reads +25V.
- 2) Power amplifier unit.

Two adjustments are required in the power amplifier. The first is made with the amp loaded (4Ω) and under drive. Increase drive until first sign of output waveform clipping. Adjust R5 so that clipping occurs on both the negative and positive waveform peaks simultaneously. Line voltage = 120 VAC. The second adjustment is made with load also while the amplifier is cold. Line voltage should be 100 VAC and output level should be 1 Vpp across 4Ω load. Beginning with R14 fully ccw, adjust R14 until crossover distortion just disappears. Crossover distortion appears as shown below:

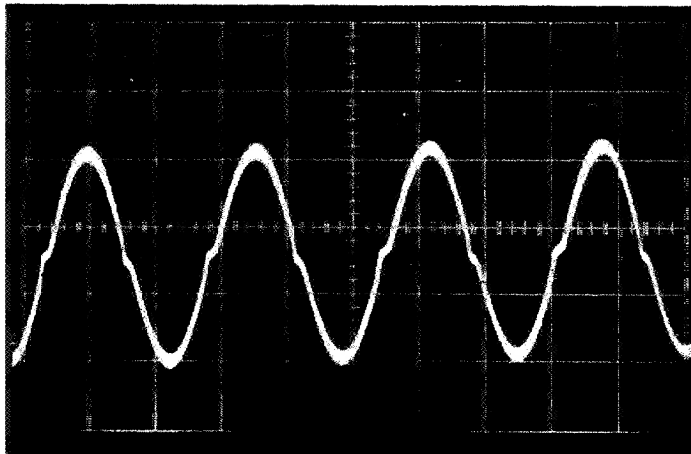

1 V P.P.

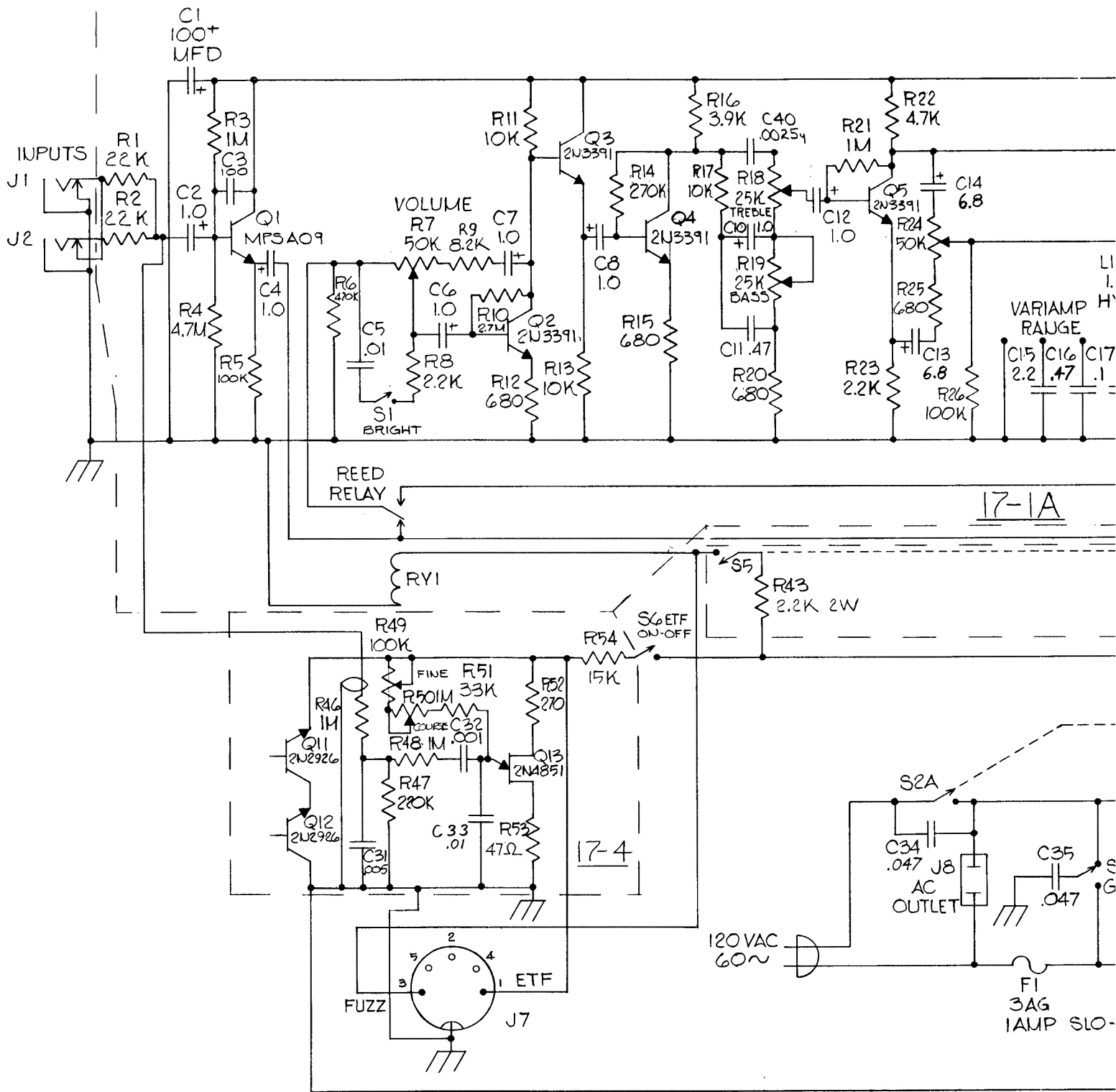

LAST DIODE BR1
 LAST TRANSISTOR Q16
 LAST CAPACITOR C40
 LAST RESISTOR R62

2. ALL CAPACITORS
 ALL OTHERS
 1. ALL RESISTORS
 NOTES:

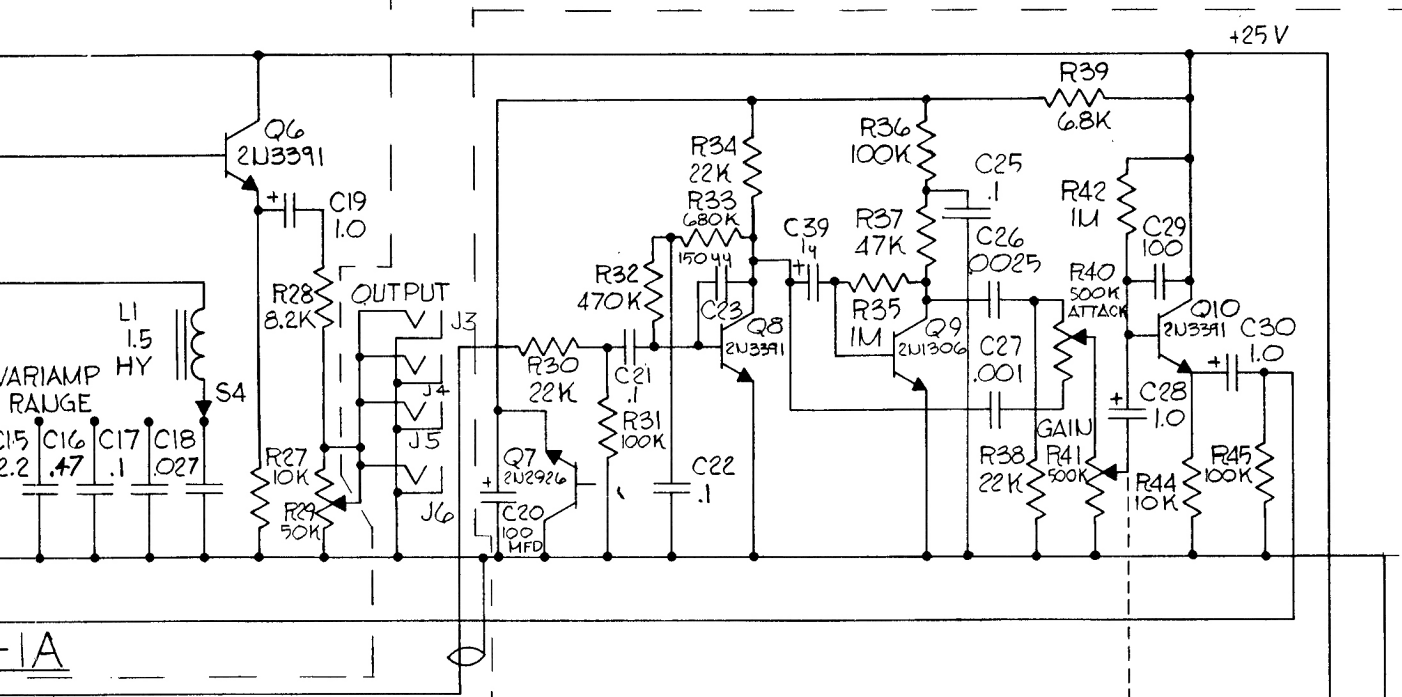

17-2A

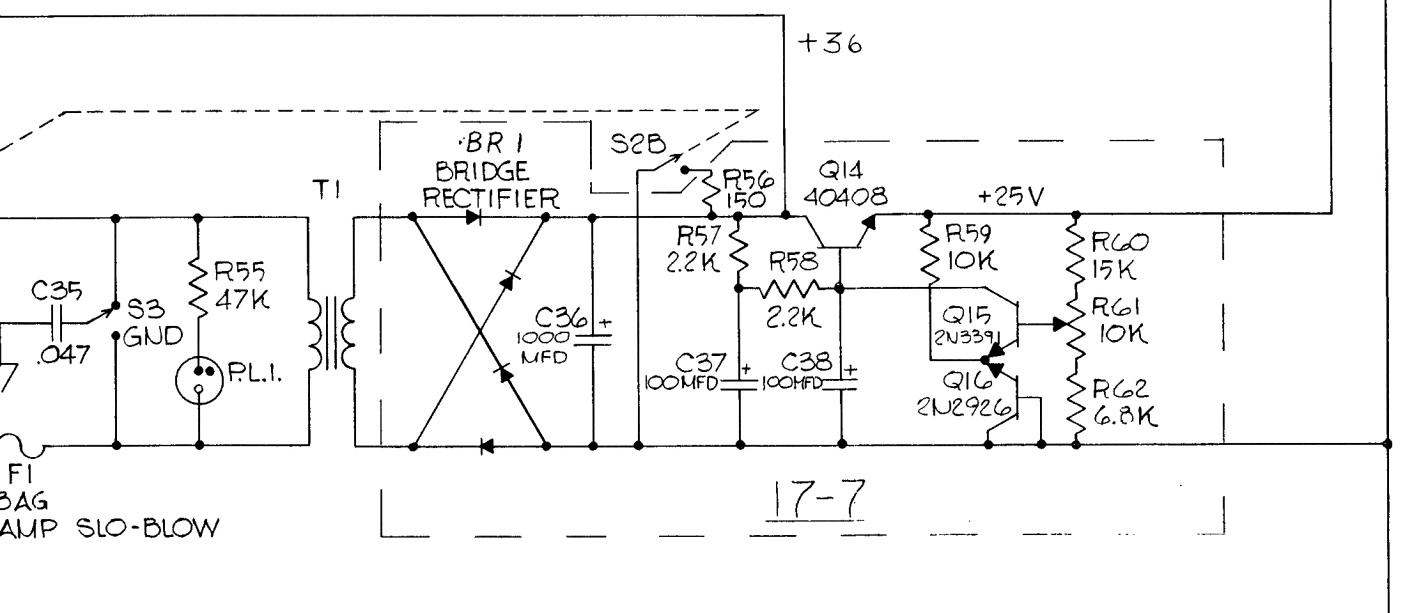

17-7

2. ALL CAPACITOR VALUES WITH DECIMAL POINTS ARE IN MFD.
 ALL OTHERS ARE IN MMFD UNLESS NOTED.
 3. ALL RESISTORS ARE 1/2 WATT UNLESS OTHERWISE NOTED.
 NOTES:

A UPDATED SCHEMATIC		7/11	7/10/70
SCALE NONE	APPROVED	REVISED 119B	
DATE 7/30/68	R V Allee		
MODEL 370 SCHEMATIC			
ACOUSTIC CONTROL CORP			1006A

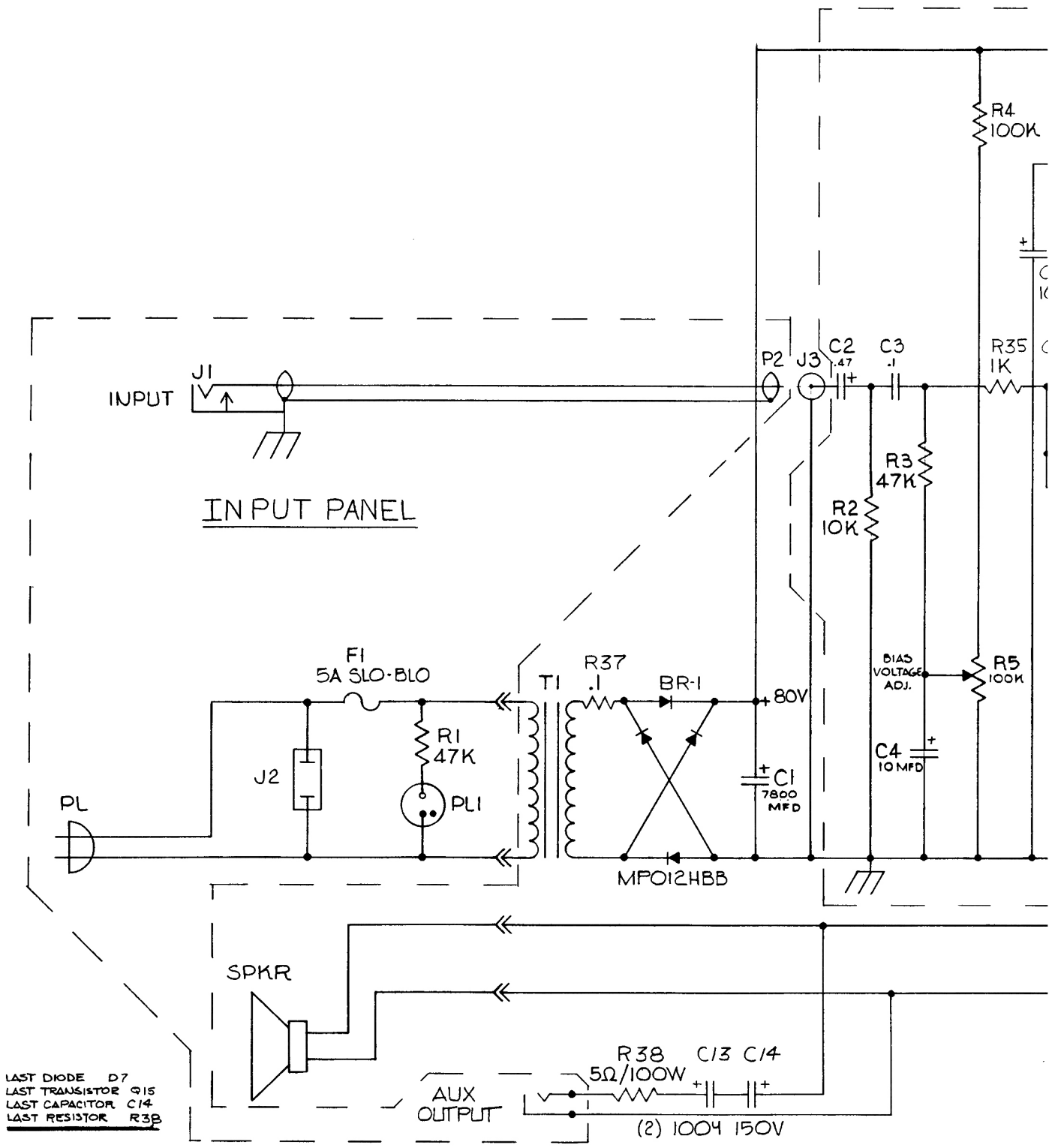

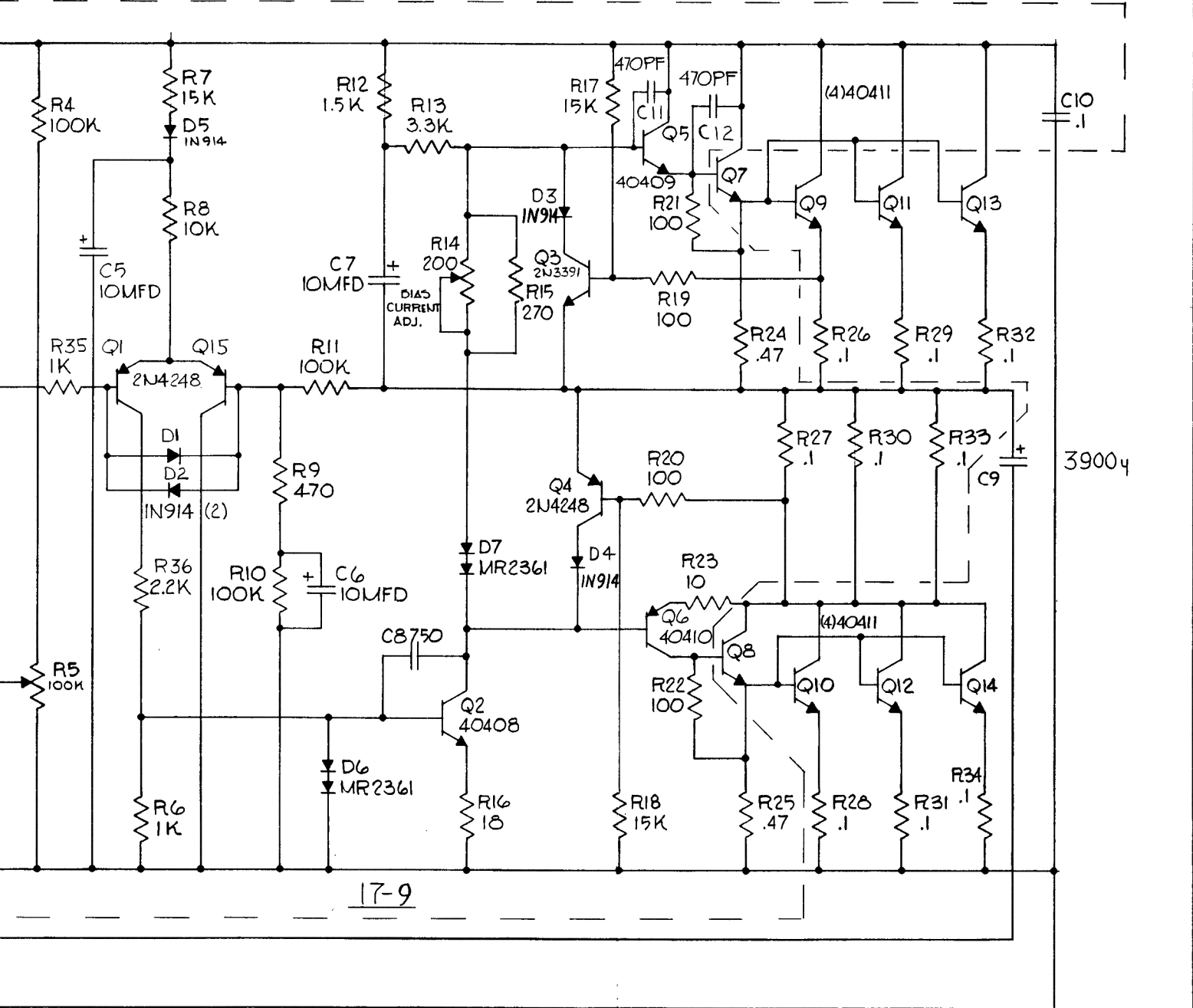

17-9

- 2. ALL CAPACITOR VALUES WITH DECIMAL POINTS ARE IN MFD. ALL OTHERS ARE IN UUMFD UNLESS NOTED
 - 1. ALL RESISTORS ARE 1/2 WATT UNLESS OTHERWISE NOTED
- NOTES:

A1 UPDATED SCHEMATIC		7/18/68 7/10/70
SCALE: NONE	APPROVED BY: R. V. Allen	DRAWN BY: T.M.E.
DATE: 7/30/68		REVISED
SCHEMATIC MODEL 361		
ACOUSTIC CONTROL CO		1005A

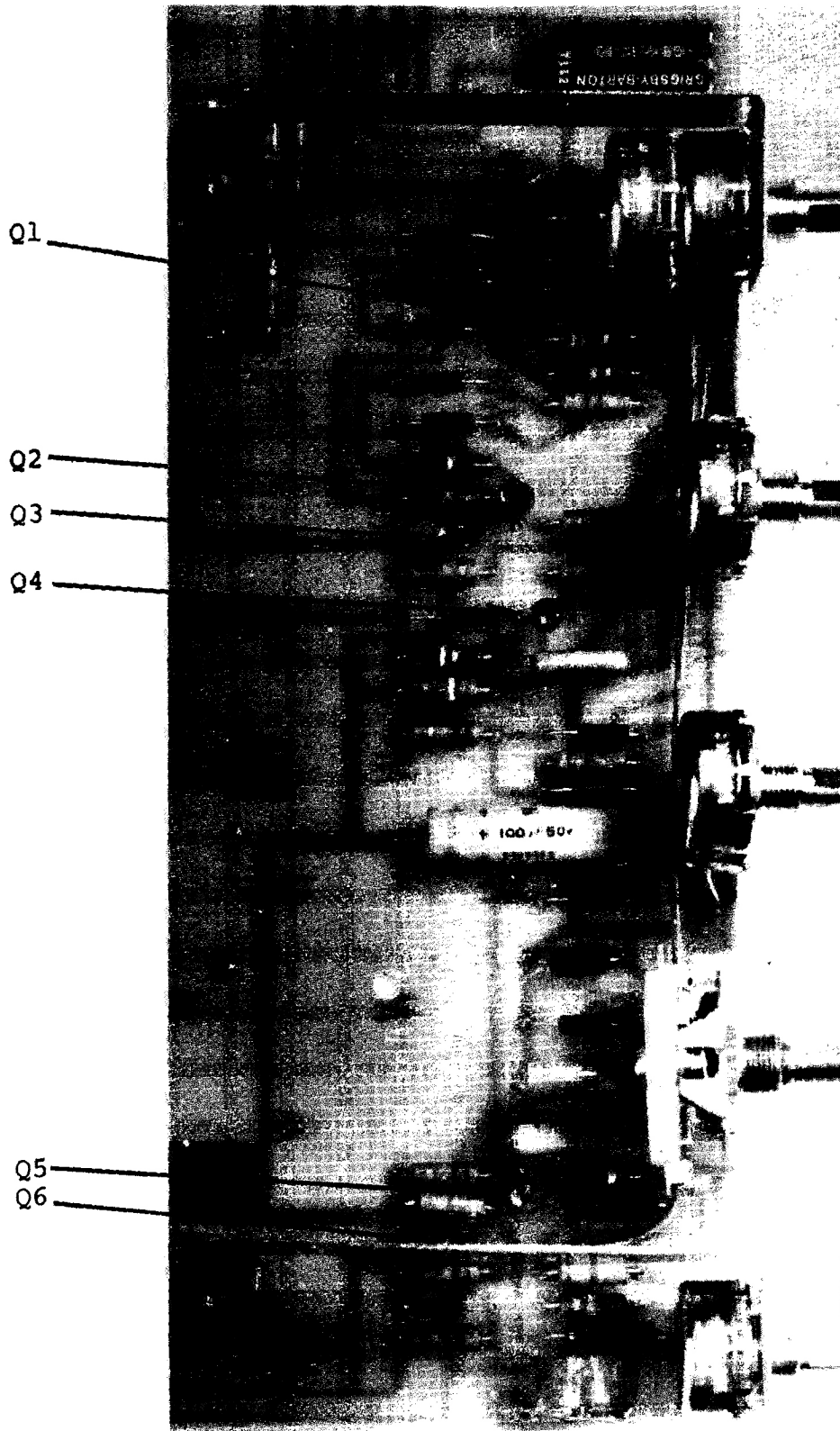

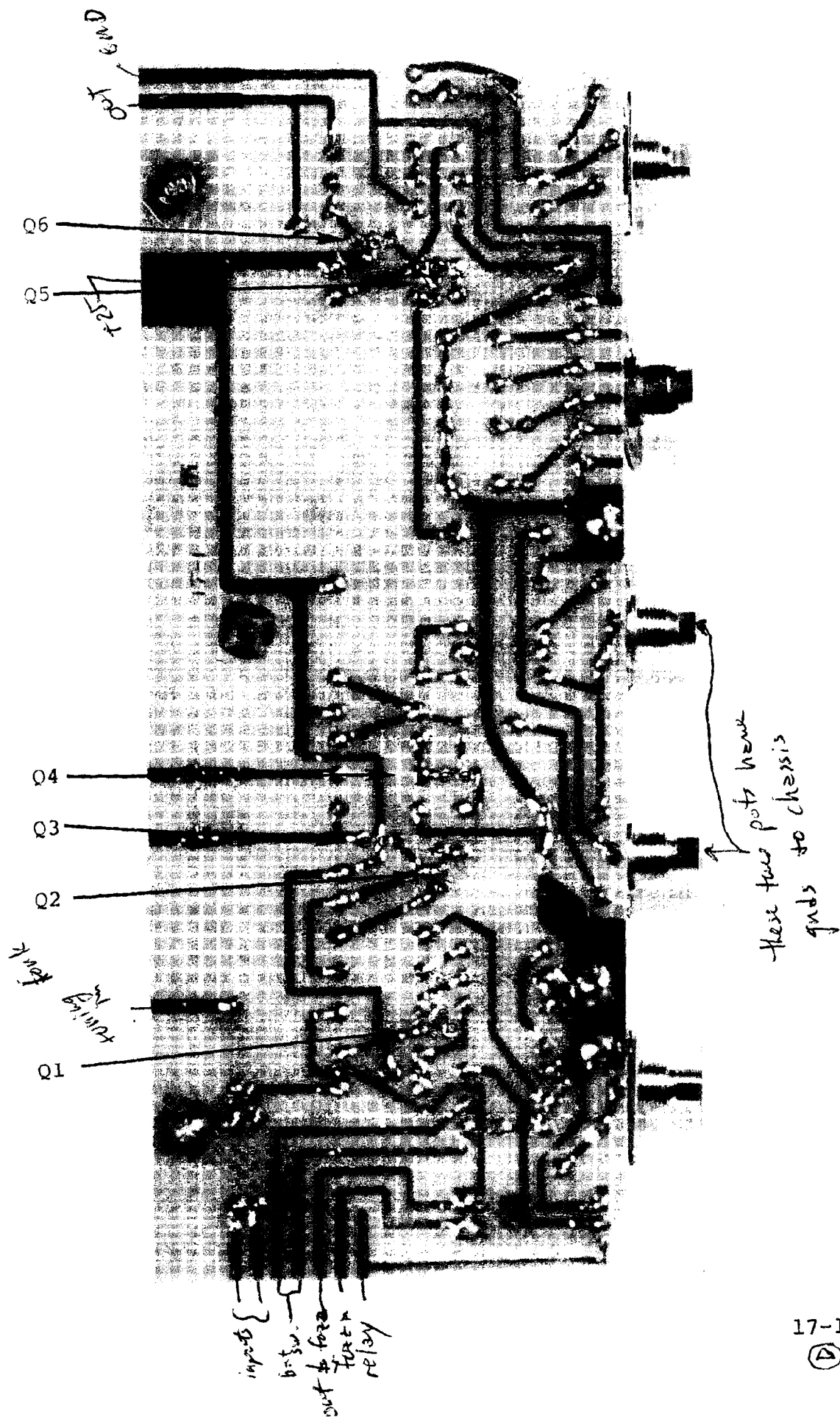

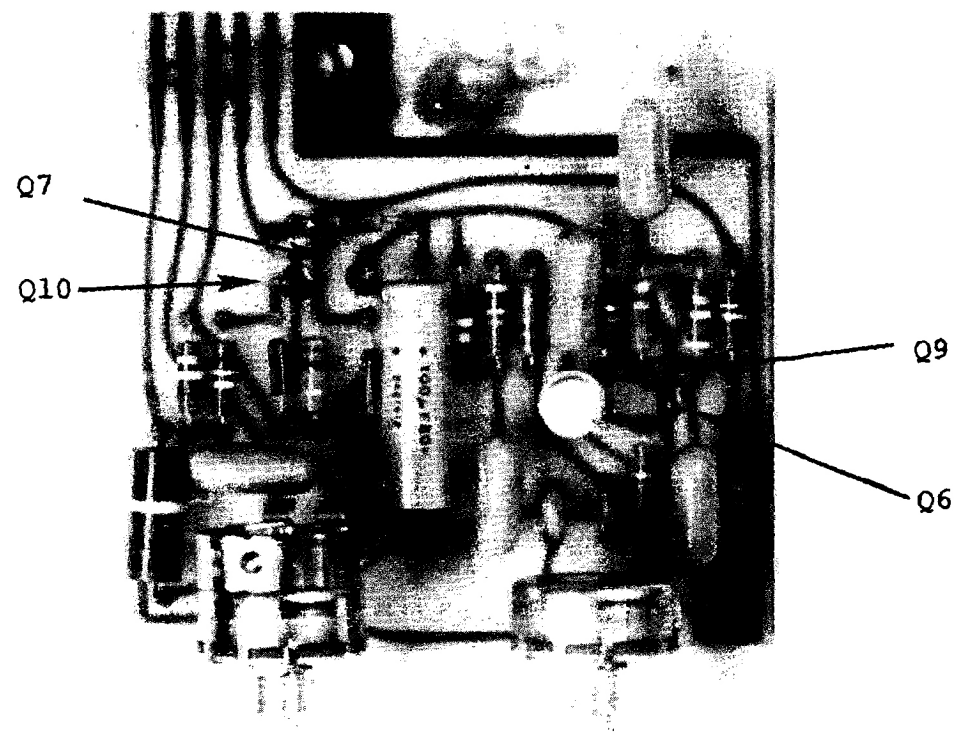
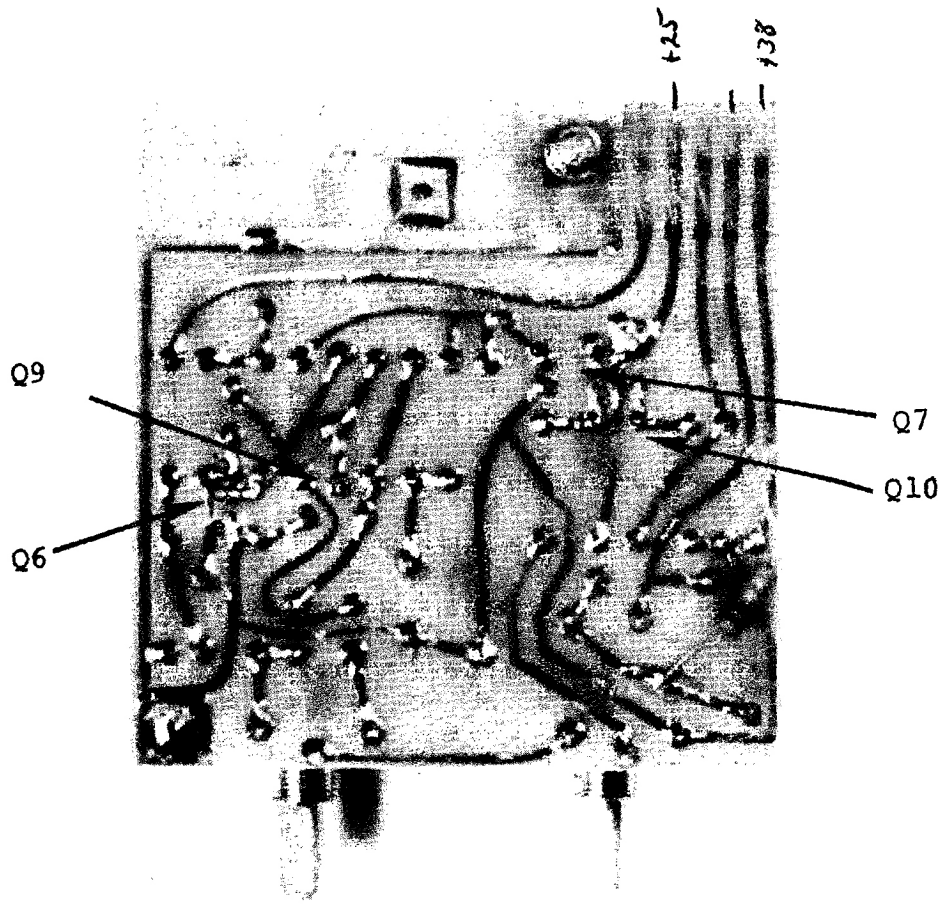

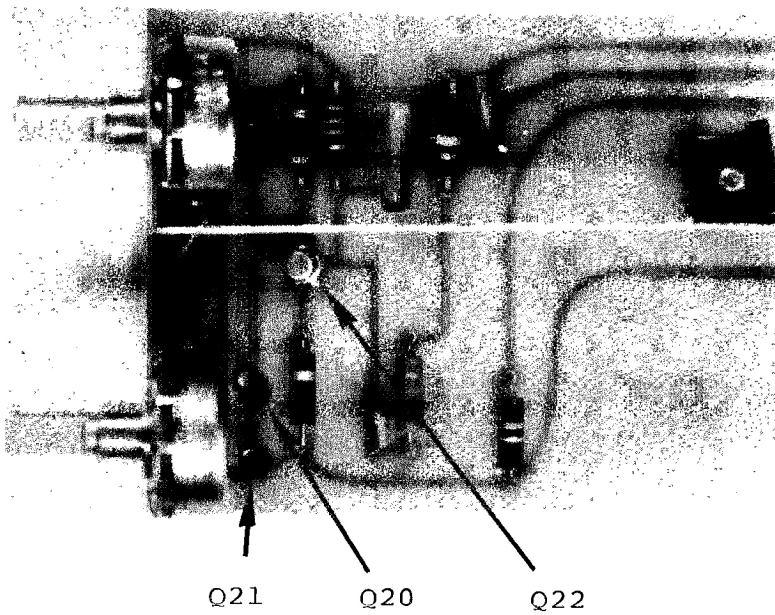
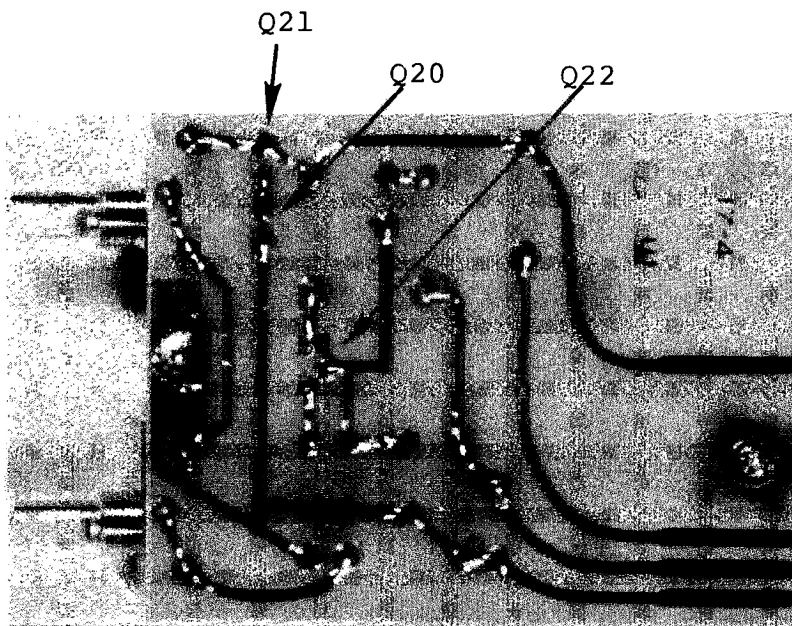

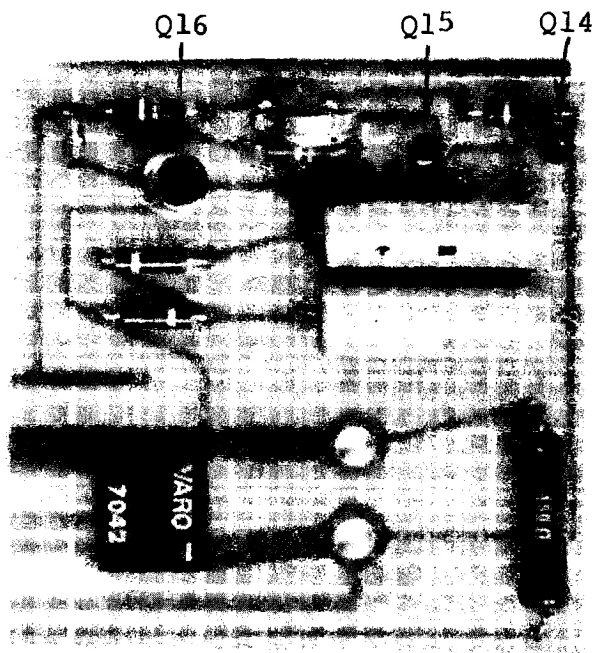
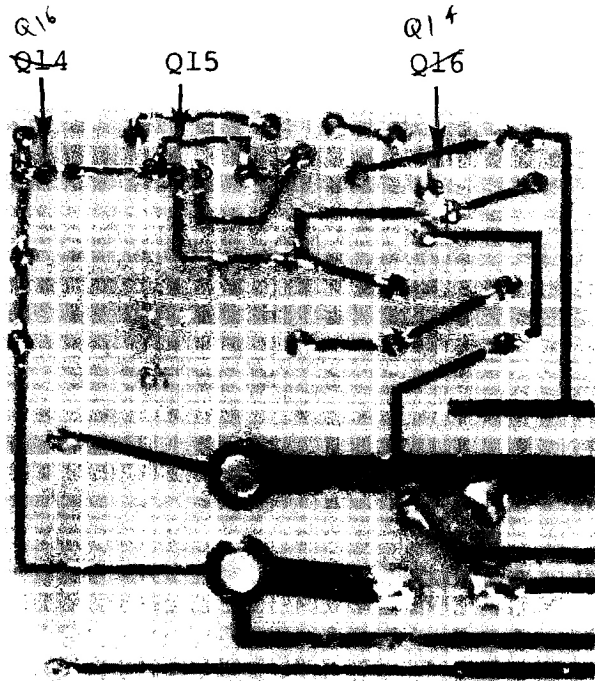

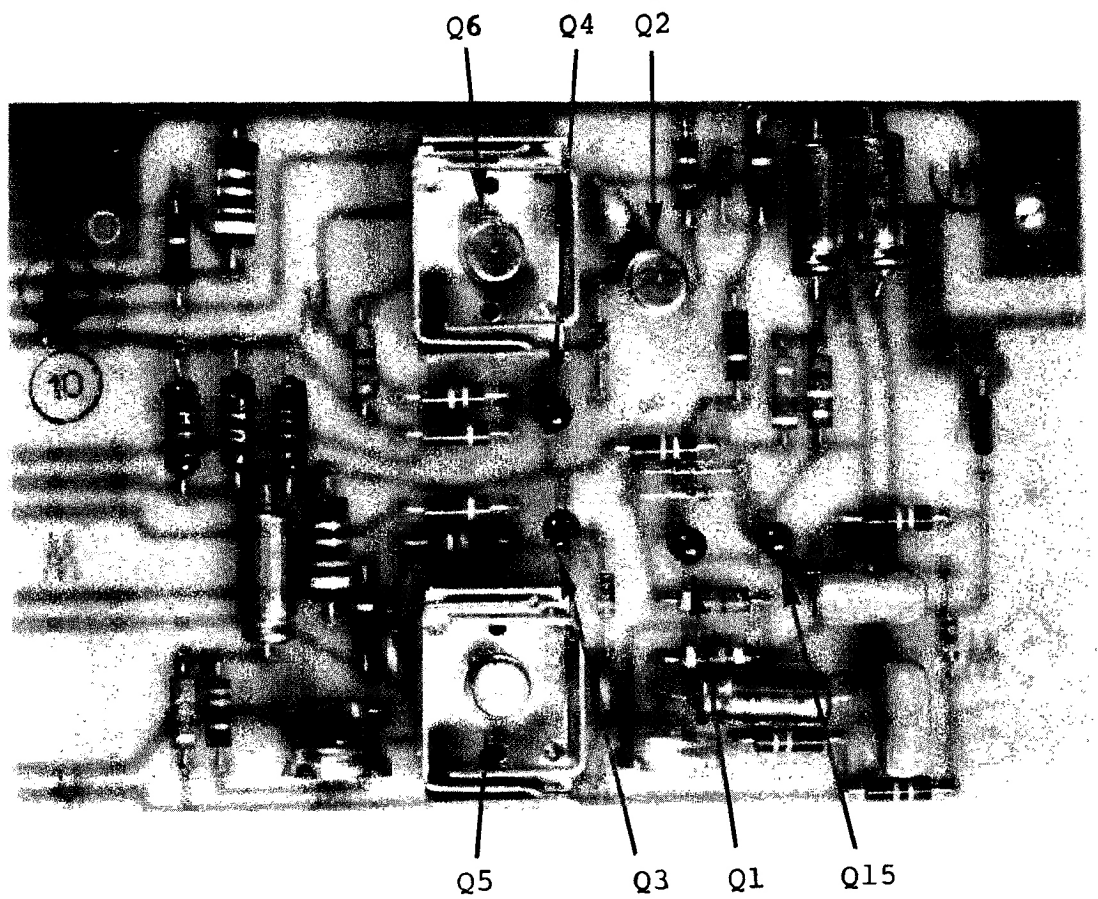
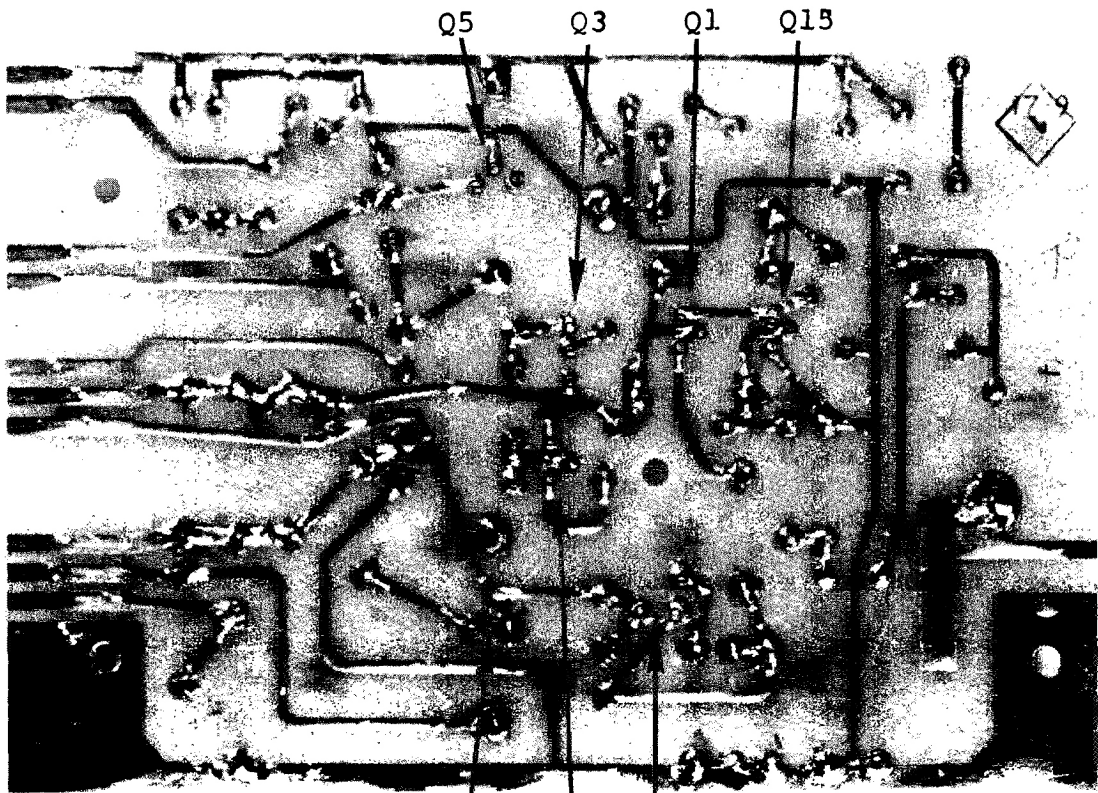

MODEL 360

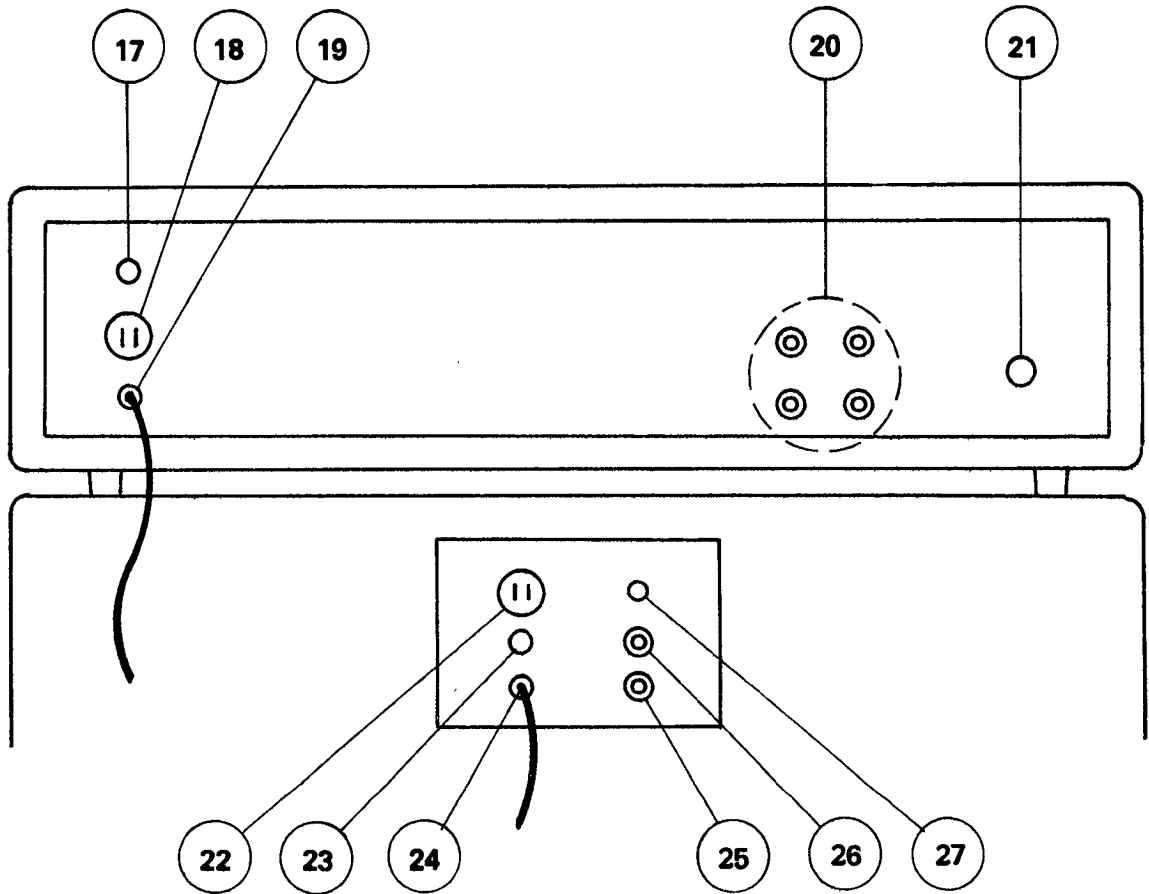
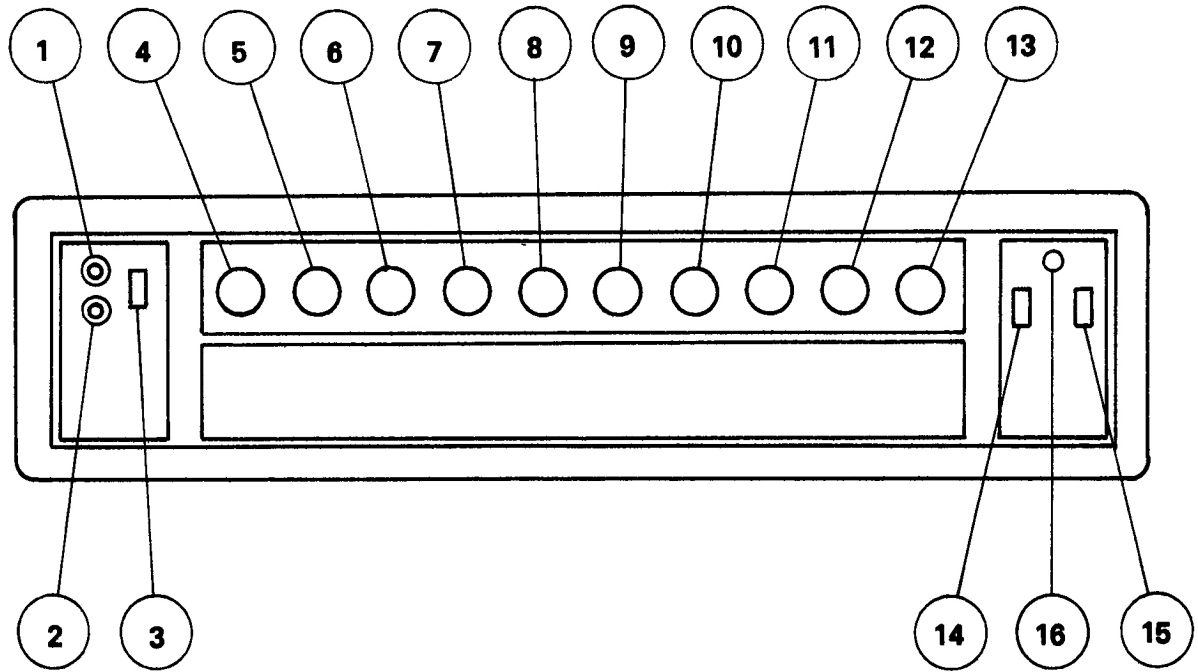

CONTROL LOCATIONS

1. Low Signal Input Jack
2. High Signal Input Jack
3. Bright Switch
4. Volume Control
5. Treble Control
6. Bass Control
7. Variamp Range Control
8. Variamp Effect Control
9. Fuzz Attack Control
10. Fuzz Gain Control
11. E.T.F. (Electronic Tuning Fork) Fine Control
12. E.T.F. Coarse Control
13. E.T.F. On/Off Switch
14. Ground Reverse Switch
15. Power Switch
16. Pilot Light
17. Power Fuse
18. AC Receptacle
19. Power Cord
20. Footswitch Plug
21. Output Jack
22. AC Receptacle
23. Power Fuse
24. Power Cord
25. Input Jack
26. Output Jack
27. Pilot Light

ACOUSTIC CONTROL CORPORATION

Troubleshooting Chart

MODEL 360

Problem	Cause	Suggested Check
Blows fuses	Short circuit	Check power transistor. Check bias voltage. Check fuse size and type. Check bridge
Distortion or no output	Shorted power transistor or bias adjustment is off	Q1 and Q15 power transistor in the 361. Check the bias.
Output drops after amplifier heats up	Short circuit	Check the drop across each 1 mfd coupling capacitors.
Output low from turn on	Regulated voltage is low	Readjust trimer potentiometer to 25 V and replace Q1 and Q2 if necessary.
Intermittent operation	Loose connection	Check jack connection in front of power amp. Check potentiometer connections on controls. Check audio cables.

PARTS LIST FOR A MODEL 360

<u>Acoustic Part Number</u>	<u>Part</u>
14-1	Chassis
14-2	Side Plate
14-3	Front Chassis
14-4	PC Bracket
14-5	Amp-Wood
14-6	Strap Handle
14-7	Foot
14-13	3/4" Cup
14-19	Footswitch Cov. Plt.
14-20	Rubber Foot
14-23	3/4" Handle Retanr.
15-1	100 pf Disc.
15-2	150 pf Disc.
15-3	0.001 mf Disc.
15-4	0.0025 mf Disc.
15-5	0.0027 mf Dip.
15-6	0.005 mf Disc.
15-7	0.01 mf Disc.
15-8	0.01 mf Dip.
15-9	0.027 mf Dip.
15-10	0.047 mf Tubular
15-11	0.1 mf Dip.
15-12	0.47 mf 35v Tant.
15-13	1.0 mf 35v Tant.
15-14	2.2 mf 35v Tant.
15-15	6.8 mf 35v Tant.
15-16	100 mf 40v Elect.
15-17	1000 mf 40v Elect.
17-1	P.C. Board
17-2	P.C. Board
17-4	P.C. Board
17-7	P.C. Board
18-2	1.5 HY Torroid
21-1	Terminal 2 pt
21-2	Phone Jack — Open
21-3	Phone Jack — Closed
21-4	Jack — 5 pin
21-5	AC Outlet
21-6	#18 Butt Connector
21-14	Plug — 5 Pin
24-1	Faceplate

<u>Acoustic Part Number</u>	<u>Part</u>
24-2	Knob
28-1	Clamp 1 3/8
28-37	Fibre Gasket
28-44	3 Prong Corners
28-45	3/4 x #6 Oval Hd Drive Screw
28-46	2 Prong Corners
28-47	Glide, Steel Nickel
28-48	Glide, Steel Nickel
31-5-1	Chassis Screened
31-5-3	Footswitch Cstng. 2 Hole
39-1	Pilot Light
45-1	Relay
47-1	47 10% 1/2w C.C.
47-1	470 10% 1/2w C.C.
47-1	680 10% 1/2w C.C.
47-1	1k 10% 1/2w C.C.
47-1	2.2k 10% 1/2w C.C.
47-1	3.9k 10% 1/2w C.C.
47-1	4.7k 10% 1/2w C.C.
47-1	6.8k 10% 1/2w C.C.
47-1	10k 10% 1/2w C.C.
47-1	15k 10% 1/2w C.C.
47-1	22k 10% 1/2w C.C.
47-1	33k 10% 1/2w C.C.
47-1	47k 10% 1/2w C.C.
47-1	100k 10% 1/2w C.C.
47-1	220k 10% 1/2w C.C.
47-1	470k 10% 1/2w C.C.
47-1	1m 10% 1/2w C.C.
47-1	2.7m 10% 1/2w C.C.
47-1	4.7m 10% 1/2w C.C.
47-1	270k 10% 1/2w C.C.
47-1	47k 10% 1/2w C.C.
47-2	2.2k 10% 2w C.C.
47-3	150 10% 5w W.W.
47-4	0.1 10% 3w W.W.
47.5-8	10k Trim.
47.5-19	50k
47.5-20	100k
47.5-21	500k
47.5-22	1m
47.5-23	25k
47.5-24	50k Dual

<u>Acoustic Part Number</u>	<u>Part</u>
47.5-25	500k w/Switch
48-1	2N1306
48-1	2N2926
48-1	2N3391
48-1	2N4851
48-3	40408 RCA
48-4	VS148 VARO
48-13	MPS A09 MOTO.
51-1	3 A Rocker Switch
51-2	Toggle Switch
51-3	Fuse Holder
51-4	1A 3AG Fuse
51-6	Rocker Switch
51-7	Rotary Switch
51-8	Push-Push Switch
56-1	XFMR

PARTS LIST FOR A MODEL 361

<u>Acoustic Part Number</u>	<u>Part</u>
14-8	Wood – 361
14-9	Speaker Plug
14-10	Grille Board
14-11	Cast Handle
14-12	Grille Frame
14-13	3/4" Cup
14-14	Blue Strip
14-15	Power Amp Chassis
14-16	Heat Sink
14-17	Input Panel
14-18	Kick Plate
15-11	0.1 mf Dip
15-12	0.47 mf 35v Tant.
15-19	750 pf Disc.
15-20	10 mf 50v Elect.
15-21	3900 mf 80v Elect.
15-22	7800 mf 100v Elect.
17-9	P.C. Board
21-3	Phone Jack – Closed
21-5	AC Outlet
21-9	Terminal – 11 pt
21-10	Terminal – 3 pt
21-11	Socket
21-13	#10 Crimp Lug
21-20	Phono Plug
21-21	Phono Jack
21-22	Sleeve Molex
21-23	Pin Molex
21-24	Receptacle – Molex
21-25	Plug – Molex
21-26	Terminal 6 pt
21-35	Jack – Open
28-4	Clamp – 2"
28-5	Clamp – 3"
28-6	PC Brkt – MB128
28-7	Speaker Clamp
28-8	Wheel
28-9	Drive Nail
28-15	Staples – 1/4" (10kBx)
28-19	3/8 OD x 1/2 Spacer
28-20	PC Bracket

<u>Acoustic Part Number</u>	<u>Part</u>
28-21	Grommet 1/2"
28-44	3 Prong Corners
28-45	3/4 x #6 Oval Hd Drive Screw
28-46	2 Prong Corners
28-47	Glides, Steel Nickel
28-48	Glides, Steel Nickel
31.5-2	Input Panel
39-1	Pilot Light
47-1	10 10% 1/2w C.C.
47-1	18 10% 1/2w C.C.
47-1	100 10% 1/2w C.C.
47-1	270 10% 1/2w C.C.
47-1	1k 10% 1/2w C.C.
47-1	1.5k 10% 1/2w C.C.
47-1	3.3k 10% 1/2w C.C.
47-1	10k 10% 1/2w C.C.
47-1	15k 10% 1/2w C.C.
47-1	47k 10% 1/2w C.C.
47-1	100k 10% 1/2w C.C.
47-1	47k 10% 1/2w C.C.
47-5	0.47 10% 2w W.W.
47.5-9	100k Trim.
47.5-10	200 Trim.
48-1	2N3391
48-1	2N4248
48-3	40408 RCA
48-5	IN914
48-6	40409 RCA
48-7	40410 RCA
48-9	MG2361
48-15	60085
48-19	MPO 12 JBD
51-3	Fuse Holder
51-5	5A 3AG Fuse
56-2	XFMR

ACOUSTIC CONTROL CORPORATION
Troubleshooting

MODEL 360

Problem	Cause	Suggested Check
Output low from turn on	Regulated voltage is low	Readjust trimer potenio- meter to 25 V and replace Q1 and Q2 if necessary
Output drops after amplifier heats up	Short circuit	Check the drop across each 1 mfd coupling capacitors

ACOUSTIC CONTROL CORPORATION
Troubleshooting

MODEL 361

Problem	Cause	Suggested Check
Amplifier blows power fuse	Short circuit	Check for shorted bridge rectifier Check for shorted output transistors Note: if output transistors are changed, check and reset quiescent bias current R-14 and adjust DC bias voltage R-5 for maximum symmetry
Loud hum or buzzing	Shorted capacitor or open ground	Check filter capacitor
No output or intermittent output	Open circuit	Check audio jack connection on power amplifier, input jack or network
No signal in top channel except when fuzz gain is turned on	Control element not operating	Check the capacitor connected across the fuzz switch terminals on 17-2 PC Board or 102

2/24/71

BIAS ADJUSTMENTS FOR 361

Adjustments

a) Pre-Amp Control Head

The only adjustment necessary in the pre-amp control head is R-61. Adjust this control while measuring Q-14's emitter until Q-14's emitter reads +25V.

b) Power Amplifier Unit

Two adjustments are required in the power amplifier. The first is made with the amp. loaded (4 ohm) and under drive. Increase drive until first sign of output waveform clipping. Adjust R-5 so that clipping occurs on both the negative and positive waveform peaks simultaneously. Line voltage = 120VAC. The second adjustment is made with load also while the amplifier is cold. Line voltage should be 100VAC and output level should be 1V pp across 4 ohm load. Beginning with R-14 fully ccw, adjust R-14 until crossover distortion just disappears. Crossover distortion appears as shown below:

