

ADVENT

Service Manual for Model 300

Beginning with Serial Numbers JO 07000 and YO 01000



Table of Contents

I. GENERAL INFORMATION

1.1 Specifications	2
1.2 Required Test Equipment	2

II. AMPLIFIER SECTION

2.1 Preparation	3
2.2 Power Supply and Output Bias	3
2.3 Amplifier Test	3-4
2.4 Phono Pre-Amp	4-5
2.5 Amplifier Board View	5

III. TUNER SECTION

3.1 Preparation	6
3.2 Detector Alignment	6
3.3 IF Alignment	6-7
3.4 Local Oscillator Calibration	7
3.5 RF Alignment	7
3.6 Stereo Alignment	7
3.7 Tuner Board View	8
3.8 Multiplex Filter Adjustment	9
3.9 Transistor Basing Diagrams	9

IV. POWER SUPPLY 120 VAC/12 VDC

4.1 300/12 VDC Board View	10
4.2 300/12 VDC Schematic Diagram	10
4.3 120 VAC and Amplifier Schematic Diagram	11
4.4 Tuner Schematic Diagram	12

V. PARTS LIST

5-1 Amplifier PC Board	13
5-2 Heat Sink Mounting Hardware	13-14
5-3 Power Supply 120 VAC	14
5-4 Tuner Board	14-15
5-5 Power Supply 12 VDC	15
5-6 Cosmetic Parts	15

I. GENERAL INFORMATION

1.1 SPECIFICATIONS

Amplifier section

Continuous power output, both channels driven, 8 ohms
40 Hz to 20 kHz: 15 watts + 15 watts
1 kHz: 18 watts + 18 watts

Total harmonic distortion, 40 Hz to 20 kHz
15 watts-per channel: less than 0.5%
7.5 watts per channel: less than 0.1%

Intermodulation distortion

60/7000 Hz; 4: 1: less than 0.15%

Preamp section

Maximum output: greater than 6V

Hum and noise, shorted input, A-weighted

Phono ref 10 mV @ 1 kHz: better than 80 dB
Aux, Tape monitor: better than 80 dB

Total Harmonic distortion

20 Hz to 20 kHz: less than 0.1% (2.5V)

Intermodulation distortion

60/7000 Hz; 4: 1: less than 0.1% (2.5V)

Tone controls

Bass: ± 10 dB @ 100 Hz
Treble: ± 10 dB @ 10,000 Hz

Infrasonic filter

Phono: 0 dB @ 25 Hz
-1 dB @ 20 Hz
-31 dB @ 4 Hz

FM tuner section

Mono sensitivity

IHF 30 dB: 2.5 μ V*
IHF 50 dB: 3.5 μ V

Stereo sensitivity

IHF 50 dB: 35 μ V

Total harmonic distortion, 400 Hz, IHF
Mono: less than 0.15%
Stereo: less than 0.2%

Stereo separation, IHF

400 Hz: greater than 40 dB
30 Hz to 10 kHz: 28 dB

Alternate channel selectivity: 70 dB

Image rejection: 55 dB

IF rejection: 70 dB

Spurious rejection: 70 dB

AM suppression: 60 dB

Capture ratio: 1.6 dB

Antenna input: 300 ohms balanced

Power requirements

Model 300: 120 VAC, 60 Hz,
100 watts maximum

Model 300/12: 12 VDC, negative
ground, 7 amps maximum

1.2 REQUIRED TEST EQUIPMENT

The following list of test equipment is required to properly service the Model 300 stereo receiver.

1. Audio Oscillator, Hewlett Packard 204C or equivalent.
2. Precision ACVM, Hewlett Packard 400 GL or equivalent.
3. Oscilloscope, Tektronix T922 or equivalent.
4. Volt, Ohm Meter, Hewlett Packard Model 427A or equivalent.
5. Distortion Analyzer, Hewlett Packard Model 333A or equivalent.
6. FM Multiplex Generator, less than 0.2 THD and better than -60 dB signal to noise.
Sound Technology Model 1000A or equivalent.
7. Two (2), Eight ohm load resistors, 1%, 25 watt minimum rating.
8. AC line variac. General Radio WSMT3A or equivalent.
9. Frequency counter, 100 MHz, Data Precision Model 5740 or equivalent.

II. AMPLIFIER SECTION

2.1 PREPARATION

- 1-1 Remove the top cover of the Model 300. (six screws).
- 1-2 Connect the "A" speaker outputs, left and right channels, across eight ohm load resistors.
- 1-3 Connect ACVM, Distortion Analyzer, and Oscilloscope across the load resistors. A small DPDT switch box should be used to switch the signal from either channel load resistor to the inputs of the test equipment.
- 1-4 Set the front panel controls of the Model 300 as follows:
 - Tape Monitor, **Out**.
 - Loudness, **Off**.
 - Mono/Stereo, **Stereo**.
 - Muting, **Off**.
 - Speakers "A," **On**.
 - Tone Controls, **Mid-rotation (flat)**.
 - Balance Control, **As required to achieve equal channel outputs**.
 - Mode Selector, **Aux**.
 - Volume Control, **Minimum**.

2.2 POWER SUPPLY AND OUTPUT BIAS ADJUSTMENT

- 2-1 Using VOM, measure the power supply voltage at F400. Voltage must be $+24\text{ DC} \pm 10\%$. Now measure at F401 for $-24\text{ VDC} \pm 10\%$.
- 2-2 With the volume control at minimum, no input signal, no load across speaker outputs, and amplifier circuit at room temperature adjust bias pot R316 to obtain 0.003 VDC across R330 and R332.
Repeat for the right channel, adjusting R317 to obtain 0.003 VDC across R331 and R333.
Note: The bias pot setting is critical. If output transistors are replaced, set bias pot fully CCW, viewed from the front, before power is reapplied. Advance pot slowly to obtain 0.003 VDC reading.
- 2-3 Measure the voltage at the output of RA400 for $+15\text{ VDC} \pm 10\%$.
Now measure the voltage at the emitter of Q401 for $-15\text{ VDC} \pm 10\%$.
- 2-4 Measure the voltage at the emitter of Q110 for $+12\text{ VDC} \pm 10\%$.
Now measure the voltage at the emitter of Q111 for $-12\text{ VDC} \pm 10\%$.

Note: On early Model 300's the plus and minus 12 volt regulator circuits were located on a separate board mounted to the amplifier board.

2.3 AMPLIFIER TEST

- 3-1 Connect the output of the audio oscillator into the Auxilliary inputs of the Model 300. Feed in a $0.15\text{ Volt} \pm 3\text{ dB}$, 400 Hz signal.
- 3-2 Increase the Model 300 volume control until the wave form on the oscilloscope begins to clip. Voltage at the point clipping begins must be 12 volts RMS minimum across the 8 ohm loads. The AC line voltage must be 120 volts AC.
Note: The circuit breaker on the Model 300 back panel will trip if the amplifier is allowed to clip for an extended period.
- 3-3 Decrease the volume control on the Model 300 to read 11 VAC across the load resistors. Now measure the distortion in both channels. Note readings.
- 3-4 Increase the oscillator frequency to 20 kHz. If required, readjust the volume control to obtain 11 Volts across the load resistors. Now measure the distortion in both channels. Distortion must not exceed 0.5% THD at either frequency.

3-5 Decrease the Model 300 volume to minimum. Hum and noise must not exceed 3 mv.

Note: This measurement was made using a Hewlett Packard Model 400 GL ACVM which has a 100 kHz low pass filter. If using an ACVM not equipped with this provision, insert the following 100 kHz low pass filter before the input.

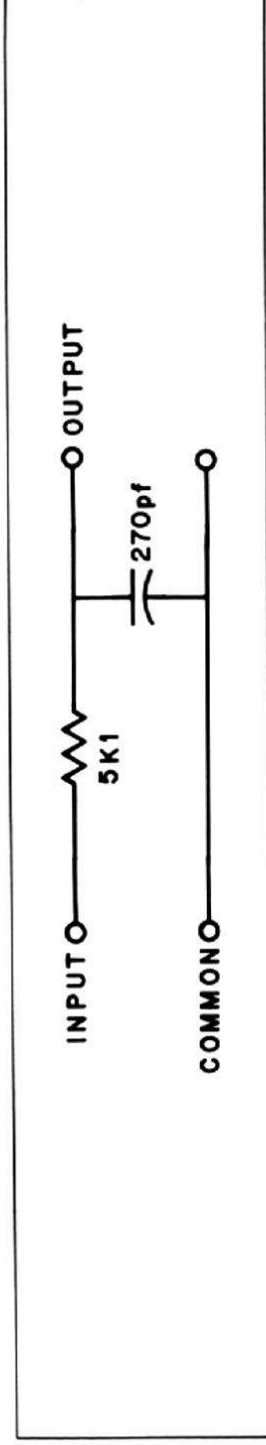

2.4 PHONO PRE-AMP

4-1 With the Model 300 mode switch in Phono position, feed a 10 mv at 1 kHz signal from the audio generator into the Phono inputs. Connect the distortion analyzer to the tape output jacks and measure the distortion from each channel. Distortion must not exceed 0.02% THD.

4-2 Now connect the oscilloscope to the tape outputs and increase the audio generator level from 10mv, at 1 kHz, until the sine wave on the scope begins to clip. Next, measure the voltage from the audio generator. The voltage from the generator must exceed 100 mv, -1 dB, at the point of clipping.

Note: Signal to noise measurements made through a weighting filter correspond more closely with perceived noise levels than unweighted measurements. The "A" weighting filter network shown below is a convenient one to construct and use. The weighting filter is inserted before the measuring voltmeter in order to obtain an "A" weighted measurement.

4-3 Remove cables from the Phono inputs and install shorting plugs. Connect the "A" weighting network between the tape outputs and the ACVM. Measure hum and noise from each channel. Hum and noise must not exceed 0.1 mv, "A" weighted.

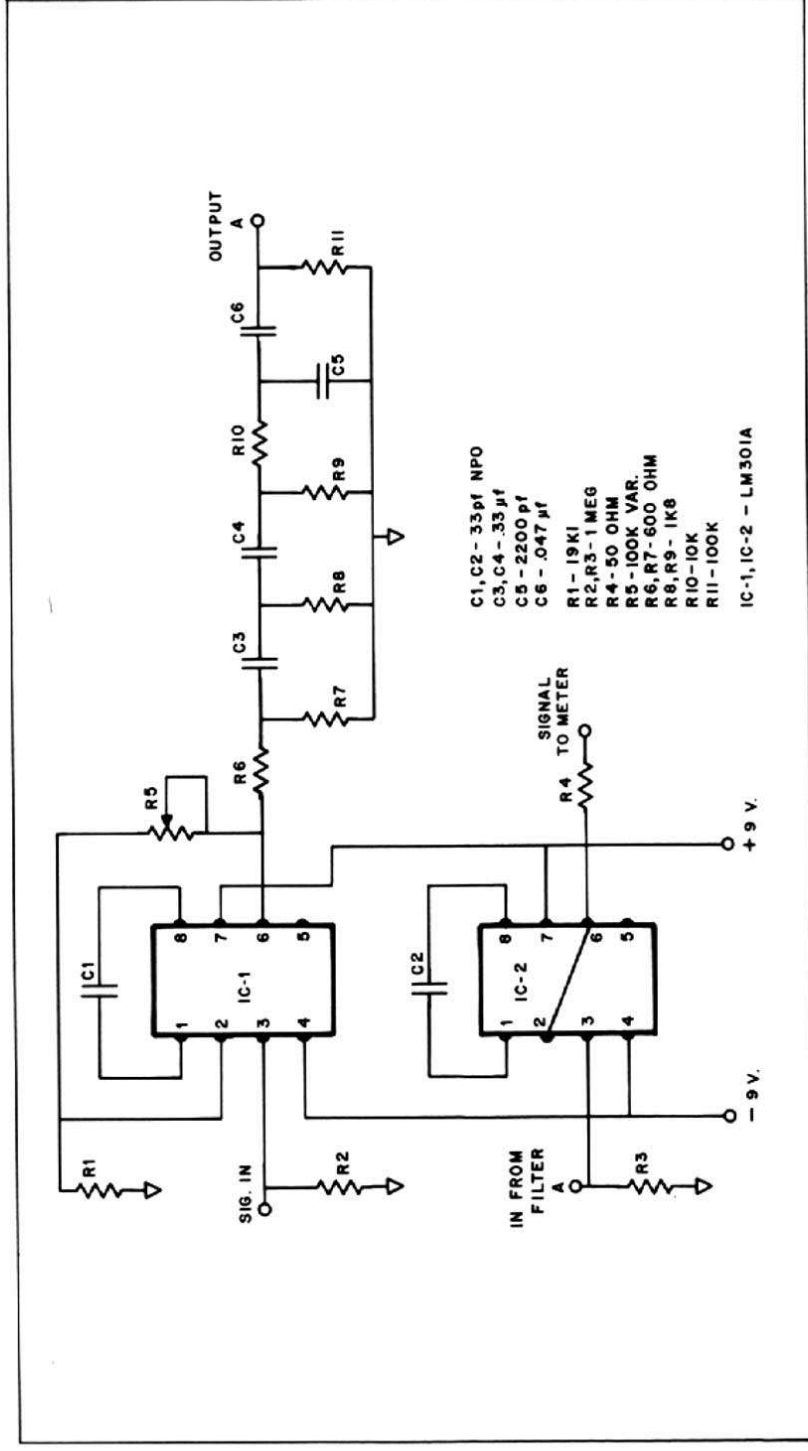

2.5 AMPLIFIER BOARD VIEW

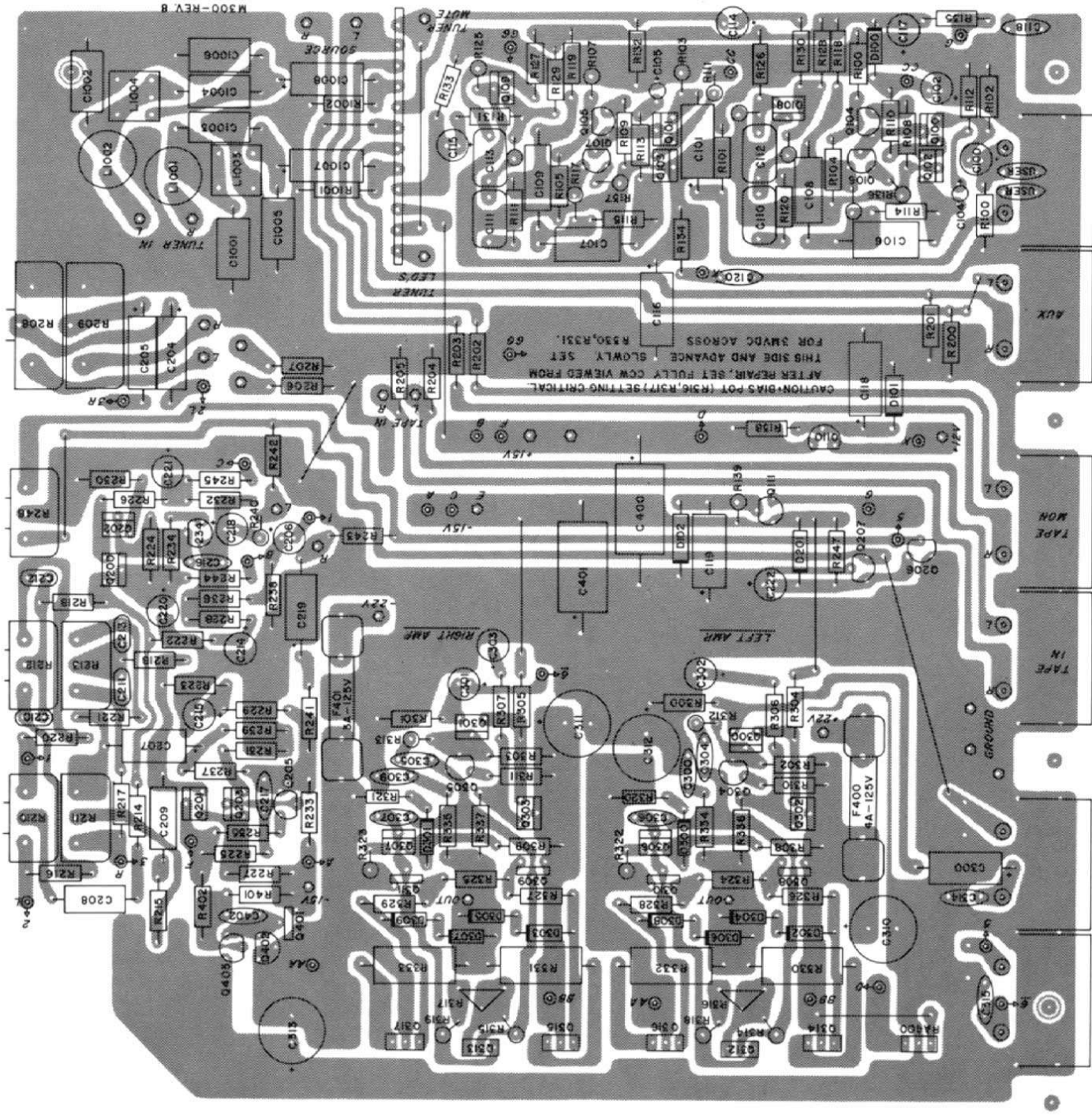

III. TUNER SECTION

3.1 PREPARATION

- 1-1 Connect the oscilloscope, AC voltmeter and distortion analyzer across the Model 300 tape output jacks. A small dpdt switch should be used which will allow the right or left channels to be switched into the test equipment without having to plug and unplug cables.
- 1-2 Connect the RF output of the FM multiplex generator to the antenna connectors located on the rear panel of the Model 300. Be certain the generator output is matched to 300 ohms.
- 1-3 Place the Model 300 controls and switches as follows:
 - Loudness, **Off**.
 - Tape Monitor, **Out**.
 - Mode, **Tuner**.
 - Mono/Stereo, **Stereo**.
 - Muting, **Off**.All other controls, **as required**, if monitoring from headphones or loudspeakers.

Note: All tests are to be done at 100% modulation.

3.2 DETECTOR ALIGNMENT

- 2-1 With a small jumper wire, short the junction of R625 and R626 to ground, (chassis). Now adjust R707 to obtain equal brilliance of the tuning LEDES. Remove the jumper wire.
- 2-2 With the Model 300 tuning dial at a mid-band point with no station interference, (approx. 98 mHz), feed a weak 400 hz **mono** signal from the FM generator. Next tune the generator frequency to obtain maximum recovered audio from the Tuner. Now increase the generator output to 100 uv and check to see that the tuning LEDES are at equal brilliance.

Note: Step 7-2 must precede all the following tests and adjustments at each appropriate frequency called for in the test.

- 2-3 Adjust T603 (blue core) for zero volts DC \pm 0.005 volt at the junction of R625 and R626. Both are 15K ohms. Recheck the tuning LEDES for equal brilliance. Readjust R707 if required.
- 2-4 With the same 1000 uv signal, adjust T602 (pink core) for minimum distortion, less than 0.5% at the tape output jack. If high distortion is measured and cannot be lowered, connect the output of the distortion analyzer to the oscilloscope and verify that hum due to ground loops is not the cause.

3.3 IF ALIGNMENT

- 3-1 Decrease the RF level from the generator until noise becomes visible on the oscilloscope.
- 3-2 If the mono sensitivity is not better than 5 uv at the point where noise becomes visible, adjust coil T501 for maximum mono sensitivity. As signal improves, lower the RF level until T501 is peaked for maximum sensitivity.

3.4 LOCAL OSCILLATOR CALIBRATION

- 4-1 Check the calibration of the local oscillator with a known frequency or station at the low end of the band, (approx. 92 mHz). Adjust T500 (oscillator coil) to the tune known frequency to the proper point of the dial.
- 4-2 Tune to the known frequency at the high end of the band. (Approx. 104 mHz) adjust C511, (oscillator trimmer) until the known frequency is correct on the dial.
- 4-3 Due to the interaction of T500 and C511 recheck step 3.4-1. Readjust if necessary. If adjustment was needed, recheck step 3.4-2. Repeat the procedure as required. Dial accuracy should be within ± 300 kHz.

3.5 RF ALIGNMENT

- 5-1 With a weak mono signal at the low end of the band (approx. 90 mHz) adjust L500 and L501 for Maximum sensitivity.
- 5-2 Now with a weak mono signal at the high end of the band, (approx. 104 mHz) adjust both trimmers, located on the main tuning capacitor C505 for maximum sensitivity. Note, it is possible to have more than one peak. Be certain you tune for the peak which gives the maximum sensitivity. If the trimmers required adjustment recheck step 5-2. Repeat procedure as required.

3.6 STEREO ALIGNMENT

- 6-1 With the 1000 uv mono signal from the generator at a mid-band frequency adjust R902 for $19 \text{ kHz} \pm 20 \text{ Hz}$.
Note: A 20 K ohm resistor must be used for isolation between the TP, (pin 10 of LC900) and the input of frequency counter.
- 6-2 With a 1000 uv 1 kHz **stereo** signal at a mid-band frequency, monitor the left channel tape output jack. Now modulate the right channel only at 100%. Adjust R800 for minimum signal output from the left tape output jack. Note the reading from the ACVM.
- 6-3 Reverse the above procedure and compare the readings. Readjust R800 if necessary to average any differences. Separation must exceed 32 dB @ 1 kHz for both channels.
- 6-4 Adjust RF level from FM generator to zero. Place muting switch (located on M-300 front panel) to on. Now increase the RF level to 7 uv. Adjust R804 until muting circuit opens. Recheck by lowering the RF level back to zero and slowly increase until muting circuit opens at 7 uv.
- 6-5 Recheck the detector. Step 3.2-1.
- 6.6 Recheck the mono sensitivity. Step 3.3-1.

3.8 MULTIPLEX FILTER ADJUSTMENT

- 8-1 With a 1000 uv stereo signal, left and right channels modulated, adjust the Pilot Level from the Multiplex generator to 10%. Verify that the **Stereo Indicator LED** on the Model 300 glows. Now turn the modulation level to zero per cent. Adjust L1003 and L1004, (located on the amplifier board), for minimum 19 kHz output at the tape output jacks.

3.9 TRANSISTOR BASING DIAGRAMS

BOTTOM VIEWS

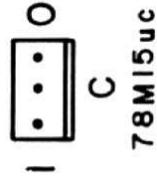
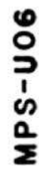
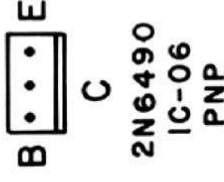
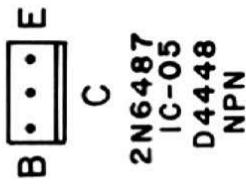
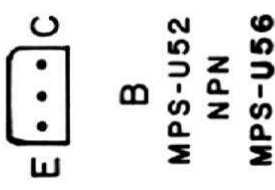
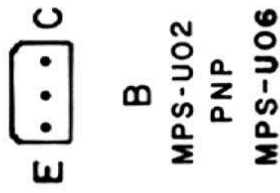
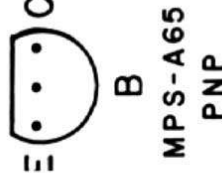
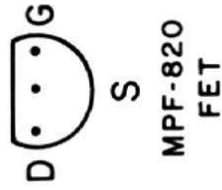
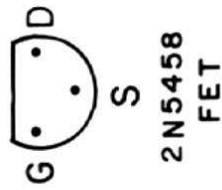
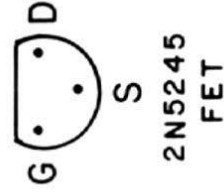
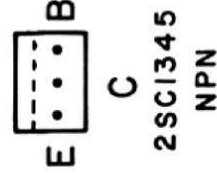
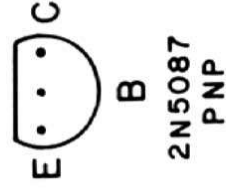
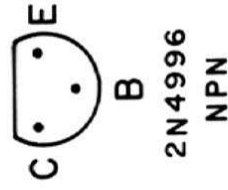
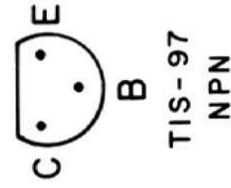

IV. POWER SUPPLY 120V AC/12V DC

4.1 300/12 VDC BOARD VIEW

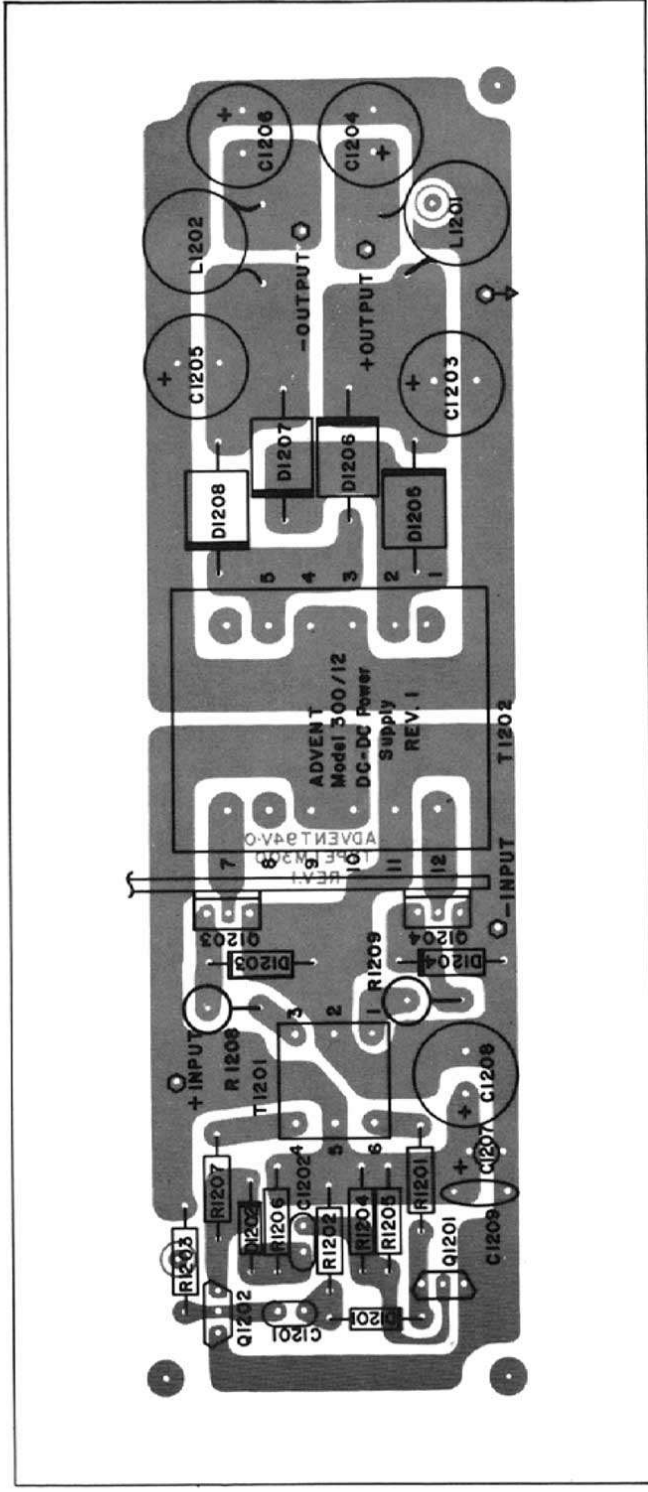

4.2 300/12 VDC SCHEMATIC DIAGRAM

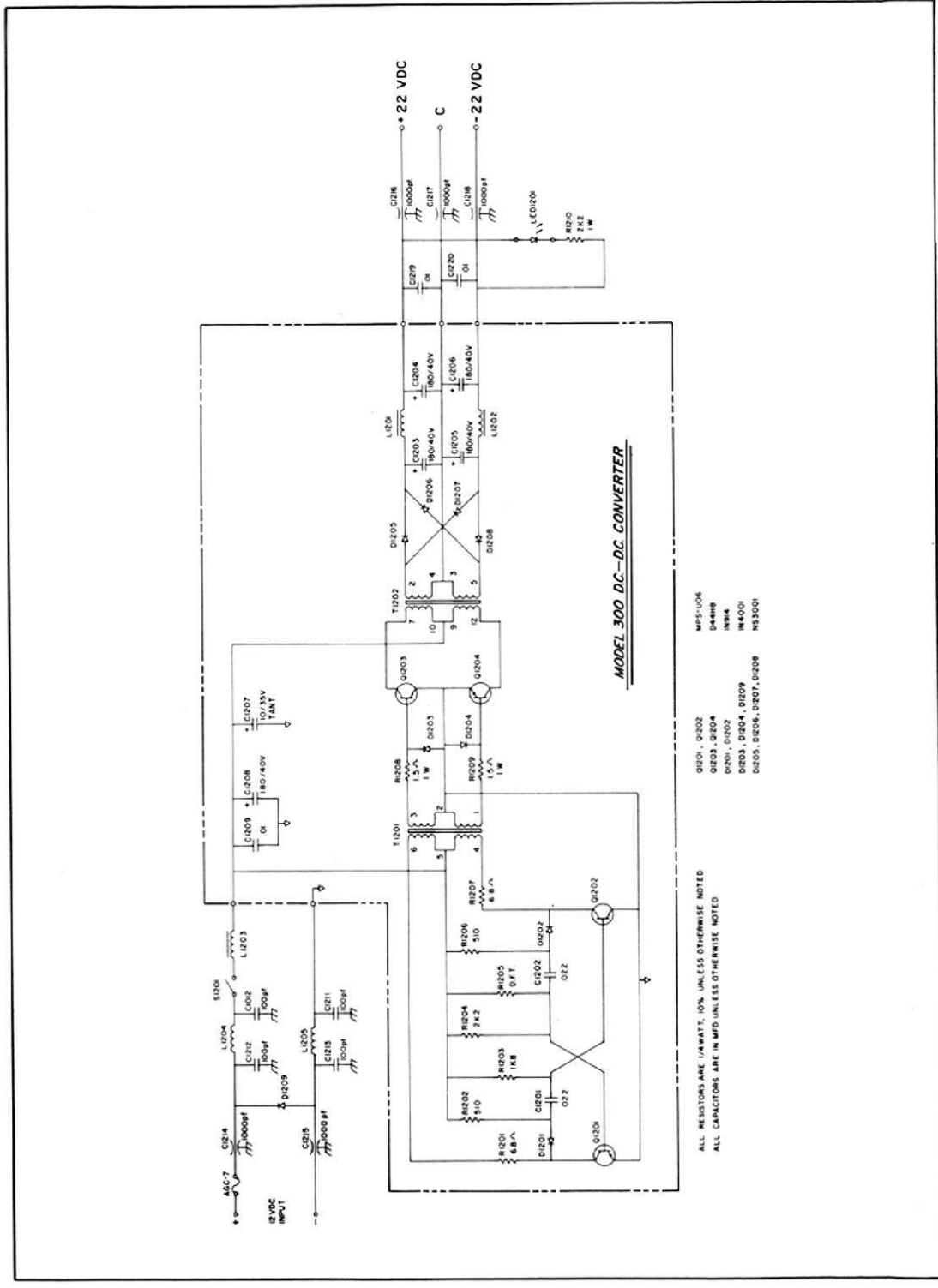

4.4 TUNER 120 VAC POWER SUPPLY SCHEMATIC DIAGRAM

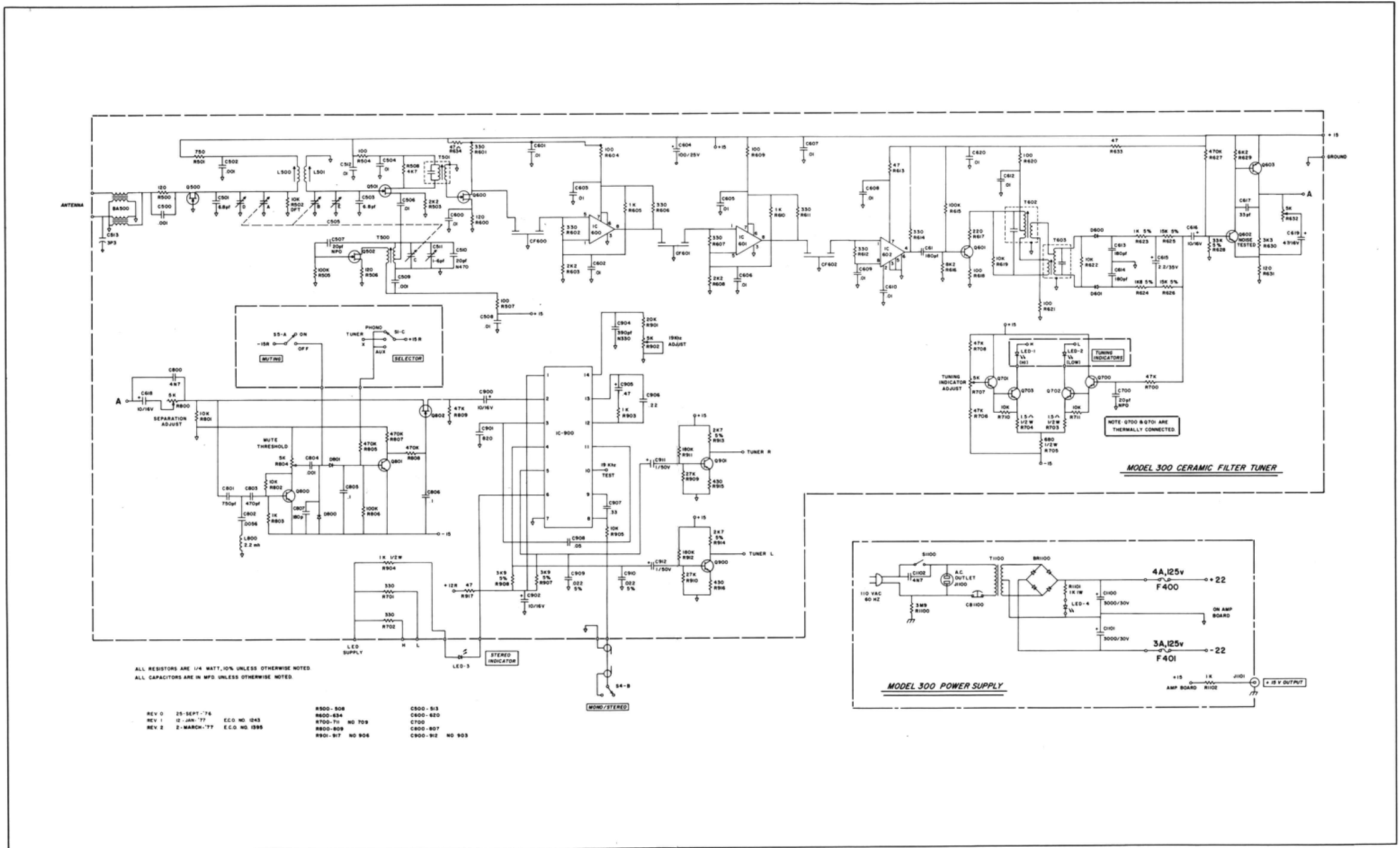

V. PARTS LIST

Symbol	Part No.	Description
5-1 AMPLIFIER PC BOARD		
C101, C300, C1007, C1008	60-613-040	Cap. 1 MFD, 50V, AX Electrolytic
C102	60-613-085	Cap. 47 MFD, 16V, PC Electrolytic
C104, C105	60-632-292	Cap. 4.7 MFD, Tantalum 10%
C106, C107	60-632-271	Cap. 2700 pf, Polystyrene, 2.5%, 33V
C108, C109	60-632-269	Cap. 750 pf, Polystyrene, 2.5%, 33V AX
C210, C211, C212, C213	60-632-043	Cap. 0.01 MFD, Mylar 5%, 100V, PC
C216, C217	60-632-050	Cap. 33 pf, NPO, 5%
C304, C305	60-632-210	Cap. 68 pf, NPO, 5%
C310, C311, C312, C313	60-613-045	Cap. 100 MFD, 35V, Electrolytic PC
C314, C315	60-632-259	Cap. 300 pf, 50V, 5% Ceramic Disc
C400, C401	60-613-061	Cap. 100 MFD, 25V, Electrolytic AX
C1001, C1002	60-632-047	Cap. 3900 pf, 63V, 5%, Polystyrene
C1003, C1004	60-632-028	Cap. 300 pf, 50V, 5%, Polystyrene
C1005, C1006	60-632-029	Cap. 2200 pf, 50V, 5%, Polystyrene
D100, D201	60-663-003	Diode 1N914 or 1N4148
D300--thru--D309	" " "	" " "
D101, D102	60-663-049	Diode 1N5242A, 12V, Zener
Q100, Q101, Q102, Q103	60-673-040	Transistor, 2SC1345E, Noise Tested (color code blue)
Q200, Q201, Q202, Q203	60-673-040	Transistor, 2SC1345E, Noise Tested (color code blue)
Q104, Q105, Q111, Q204	60-674-003	Transistor, 2N5087
Q205, Q304, Q305, Q403	" " "	" " "
Q106, Q107	60-673-044	Transistor, Motorola MPS A65
Q110	60-673-006	Transistor, TIS 97
Q206, Q207	60-674-012	Transistor, 2N5458, Selected (color code pink)
Q108, Q109, Q300, Q301	60-673-047	Transistor, 2SC1345E, No Noise Test
Q302, Q303, Q306, Q307	" " "	" " "
Q312, Q313	" " "	" " "
Q308, Q309	60-673-015	Transistor, MPS U06
Q310, Q311	60-673-016	Transistor, MPS U56
Q314, Q315	60-673-048	IC05 is replaced by 2N6487
Q316, Q317	60-673-049	IC06 is replaced by 2N6490
Q401	60-673-028	Transistor, MPS U52
Q402	60-674-007	Transistor, 2N5458, Selected (color code yellow)
5-2 HEAT SINK MOUNTING HARDWARE		
R114, R115	60-321-026	Insulator, Mica
R116, R117	30-423-152	Clamp, Bias Sensor
R134, R135, R244, R245	60-311-195	Screw, Black Nylon No. 6-32 x 3/8"
R326, R327, R328, R329	60-654-173	Resistor, 1M2 ohm, 1/4w, 2%
R208, R209	60-654-171	Resistor, 100 K ohm 1/4w, 2%
	60-654-066	Resistor, 10 ohm 1/4w, 10%
	" " "	" " "
	50-714-094	Pot. 25K, Dual with tap

NOTE: All parts not listed in this parts list should be obtained through local suppliers.

Symbol	Part No.	Description
R210, R211, R212, R213 R246 R316, R317 R330, R331, R332, R333 S1 S2, S3, S4, S5, S6, S7 RA400 L1001, L1002 L1003, L1004 F400 F401	50-714-097 50-714-095 50-714-042 60-652-053 50-265-005 50-264-003 60-663-051 60-623-004 60-623-003 60-743-026 60-743-025	Pot. 150 K Pot. 25 K Pot. 20 K, Trimpot Resistor, 0.15 ohm 1w, 5% Switch, Rotary (mode select) Switch Slide Fairchild 15V, Reg No. 78M15UC Coil 30 mH Coil 23 mH Adj. Fuse AGC-4 amp. Fuse AGC-3 amp.
5-3 POWER SUPPLY 120 VAC		
C1100, C1101 BR1100 T1100 CB1100 S1100 J1100	60-615-003 60-663-053 80-000-077 60-743-032 50-263-041 50-211-017	3000 uF Electrolytic 30v Bridge Rectifier Transformer, Power Circuit Breaker, 1.0 amp. Switch Slide DPDT A.C. Outlet, convenience
5-4 TUNER BOARD		
C501, C503 C505 C504, C506, C508, C512 C600, C601, C602, C603 C605, C606, C607, C608 C609, C610, C612, C620 C510 C511 D600, D601 D800, D801 Q500 Q501, Q502, Q600, Q802 Q601 Q602 Q603 Q700, Q701, Q702, Q703 Q800, Q801, Q900, Q901 L500, L501 L800 BA500	60-632-202 80-000-081 60-632-234 " " " " " " " " " 60-632-334 60-629-008 60-663-040 60-663-003 60-673-045 60-674-009 60-674-010 60-673-040 60-674-003 60-673-006 60-673-047 60-623-085 60-623-088 60-623-089	Cap. 6.8 pf, NPO, 10%, Ceramic Disc Tuning Cap. (variable) Cap. 0.01 MFD, 100V, 20% " " " " " " " " " " " " Cap. 20 pf, N750, 5% Trimcap 1-6 pf Diode No. AA119MP Diode 1N914 of 1N4148 Transistor, MPF 820 Transistor, 2N5245 Transistor, 2N4996 Transistor, 2SC1345E, Noise Tested, (color code blue) Transistor, 2N5087 Transistor, TIS97 Transistor, 2SC1345E, No Noise Test RF Coil, Yellow Coil, 2.2 Mh \pm 10%, Nom Q = 53 Balun, Antenna Matching

NOTE: All parts not listed in this parts list should be obtained through local suppliers.

Symbol	Part No.	Description
T500	60-623-087	Local Oscillator Coil, Blue
T501	20-623-001	Tank Circuit Coil
T602	60-623-063	Detector Coil, Pink
T603	60-623-064	Detector Coil, Blue
CF600, CF601, CF602	60-623-093	Ceramic Filter
IC600, IC601	60-677-026	IC, RCA CA 3053
IC602	60-677-019	IC, RCA CA 3076
IC900	60-677-028	MPX IC Mot MC1310E or RCA CA 1310E
LED 1, 2, 3, 4	60-663-059	Light Emitting Diode, Red
5-5 POWER SUPPLY		
		12 VDC
C1203, C1204	60-613-088	180 uF Electrolytic Cap. (Lo-ESR)
C1205, C1206, C1208	" " "	" " "
D1203, D1204	60-663-054	1N4001
D1205, D1206, D1207, D1208	60-663-055	NS3001
Q1203, Q1204	60-673-046	D44H8
Q1201, Q1202	60-673-015	MPS U06
R1208, R1209	60-651-113	1.5 ohm 1w, 10%
R1201, R1207	60-653-109	6.8 ohm 1/4w
5-6 COSMETIC PARTS		
	30-427-044	Panel, Front Dress (Black)
	60-312-065	Spacer, Front Panel
	60-311-417	Screw, Front Panel 4-40 x 3/8"
	30-416-101	Cover, Top (Black)
	60-311-114	Screw, Top Cover
	30-533-045	Knob, Mode Selector
	30-533-046	Knob, Volume
	30-533-041	Knob, Balance, Tone
	30-533-048	Hub, Tuner
	30-427-034	Hub, Tuner Skirt
	30-533-049	Knob, Tuner
	85-220-001	Speaker and Antenna Block Assembly

When ordering parts please use both the part number and the description.

Address all orders to: **Advent Corporation**
195 Albany Street
Cambridge, Ma. 02139
Attn: Audio Service Dept.

Model 300 Amplifier Test

1-0 Preparation

1-1 Remove the top cover of the Model 300. (six screws).

1-2 Connect the "A" speaker outputs, left and right channels, across eight ohm load resistors.

1-3 Connect ACVM, Distortion Analyzer, and Oscilloscope across the load resistors. A small DPDT switch box should be used to switch the signal from either channel load resistor to the inputs of the test equipment.

1-4 Set the front panel controls of the Model 300 as follows:

Tape Monitor, OUT.	Loudness, OFF.
Mono/Stereo, STEREO.	Muting, OFF.
Speakers "A", ON.	Tone Controls, MID-ROTATION (FLAT).
Balance Control, AS REQUIRED TO ACHIEVE EQUAL CHANNEL OUTPUTS.	Volume Control, MINIMUM.
Mode Selector, AUX.	

2-0 Power Supply and Output Bias Adjustment.

2-1 Using VOM, measure the power supply voltage at F400. Voltage must be +24 DC \pm 10%. Now measure at F401 for -24 VDC \pm 10%.

2-2 With the volume control at minimum, no load across the speaker outputs, measure the bias voltage across R330. If required, adjust R316 to obtain a reading of 0.003 VDC across R330. Repeat for R332. Readjust R316 to average any difference.

NOTE: The bias pot setting is critical. If output transistors are replaced, set bias pot fully CCW, viewed from the front, before power is reapplied. Advance pot slowly to obtain 0.003 VDC reading.

2-3 Measure the voltage at the output of RA400 for +15 VDC \pm 10%. Now measure the voltage at the emitter of Q401 for -15 VDC \pm 10%.

2-4 Measure the voltage at the emitter of Q110 for +12 VDC \pm 10%. Now measure the voltage at the emitter of Q111 for -12 VDC \pm 10%.

NOTE: On early Model 300's the plus and minus 12 volt regulator circuits were located on a separate board mounted to the amplifier board.

3-0 Amplifier Test

3-1 Connect the output of the audio oscillator into the Aux. inputs of the Model 300. Feed in a 0.15 Volt \pm 3 db, 400 Hz signal.

3-2 Increase the Model 300 volume control until the wave form on the oscilloscope begins to clip. Voltage at the point clipping begins must be 12 volts RMS minimum across the 8 ohm loads. The AC line voltage must be 120 volts AC.

NOTE: The circuit breaker on the Model 300 back panel will trip if the amplifier is allowed to clip for an extended period.

3-3 Decrease the volume control on the Model 300 to read 11 VAC across the load resistors. Now measure the distortion in both channels. Note readings.

3-4 Increase the oscillator frequency to 20 KHz. If required, readjust the volume control to obtain 11 Volts across the load resistors. Now measure the distortion in both channels. Distortion must not exceed 0.5% THD at either frequency.

3-5 Decrease the Model 300 volume to minimum. Hum and noise must not exceed 3 mv.

Note: This measurement was made using a Hewlett Packard Model 400 GL ACVM which has a 100 KHz low pass filter. If using an ACVM not equipped with this provision, insert the following 100 KHz low pass filter before the input.

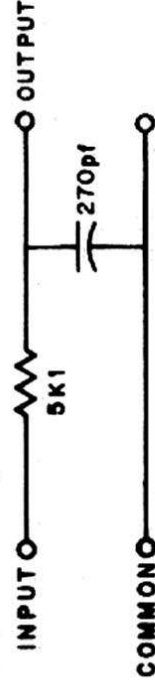

4-0 Phono Pre-Amp

4-1 With the Model 300 mode switch in Phono position, feed a 10 mv at 1 KHz signal from the audio generator into the Phono inputs. Connect the distortion analyzer to the tape output jacks and measure the distortion from each channel. Distortion must not exceed 0.02% THD.

4-2 Now connect the oscilloscope to the tape outputs and increase the audio generator level from 10mv, at 1 KHz, until the sine wave on the scope begins to clip. Next, measure the voltage from the audio generator. The voltage from the generator must not exceed 100 mv, -1 db, at the point of clipping.

4-3 Note: Signal to noise measurements made through a weighting filter correspond more closely with perceived noise levels than unweighted measurements. The "A" weighting filter network shown below is a convenient one to construct and use.

