

EQUALIZER PCB A2015A501B

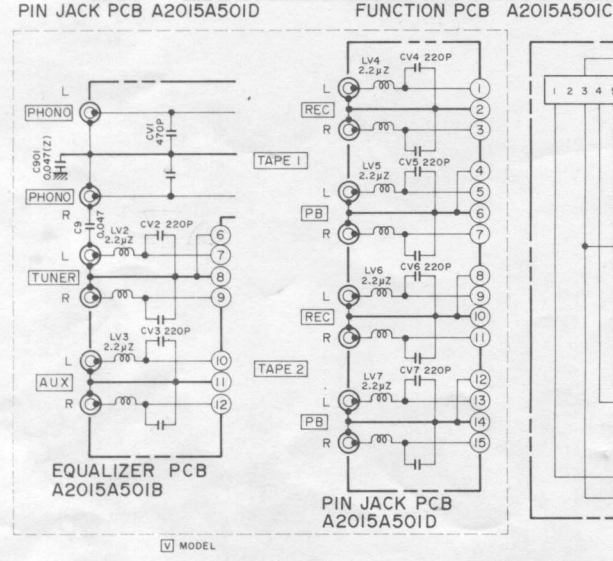

BALANCE PCB A2015A501F

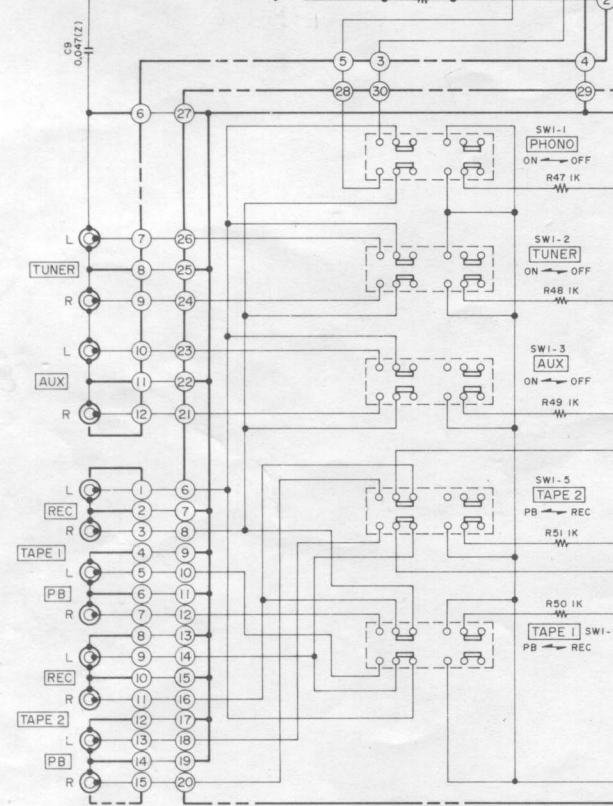
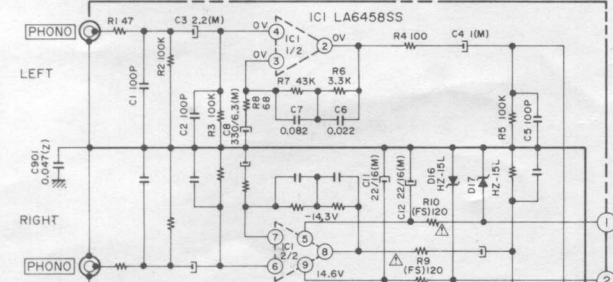
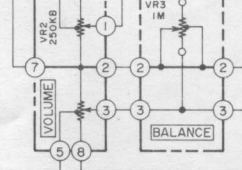

MAIN VOLUME PCB A2015A501E

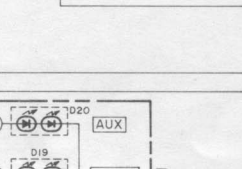

LED(A) PCB A2015A501J

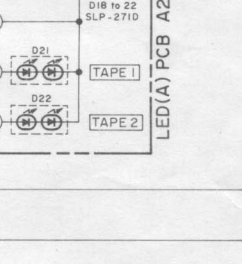

FUNCTION PCB A2015A501C

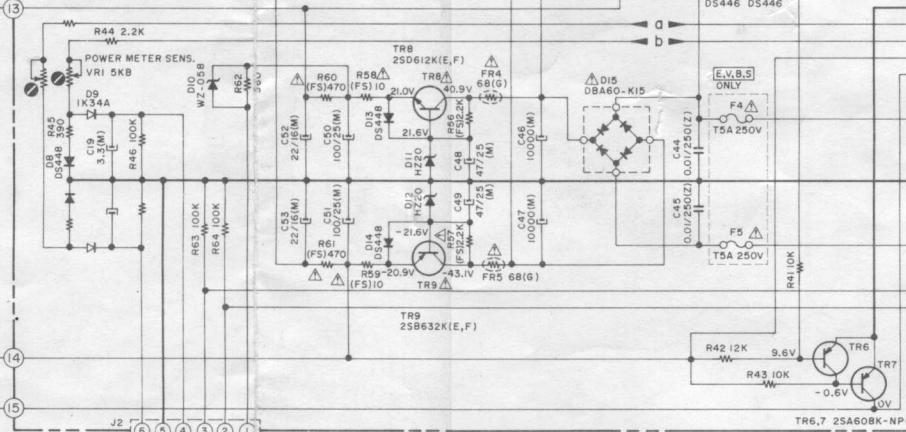
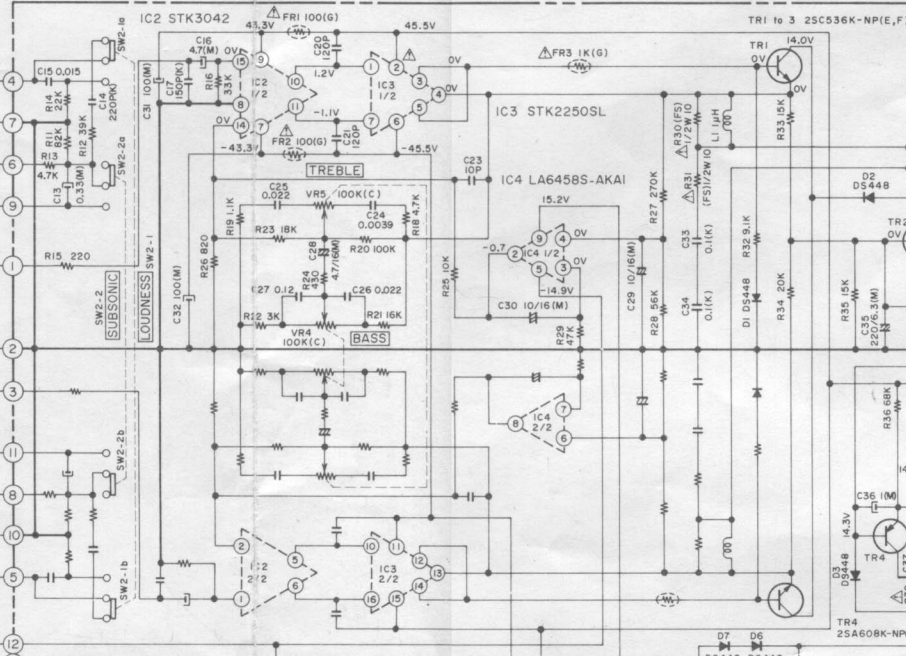
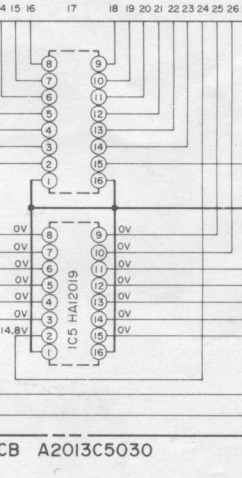

MAIN PCB A2015A501A

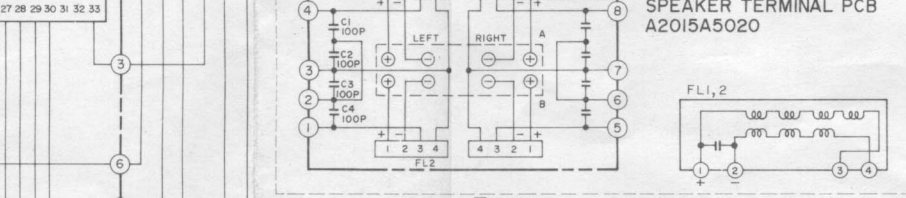

WARNING: Δ INDICATES SAFETY CRITICAL COMPONENTS. FOR CONTINUED SAFETY, REPLACE SAFETY CRITICAL COMPONENTS ONLY WITH MANUFACTURER'S RECOMMENDED PARTS. AVERTISSEMENT: Δ IL INDIQUE LES COMPOSANTS CRITIQUES DE SÛRETÉ. POUR MAINTENIR LE DEGRÉ DE SÛRETÉ DE L'APPAREIL NE REMPLACER LES COMPOSANTS DONT LE FONCTIONNEMENT EST CRITIQUE POUR LA SÛRETÉ QUE PAR DES PIÈCES RECOMMANDÉES PAR LE FABRICANT.

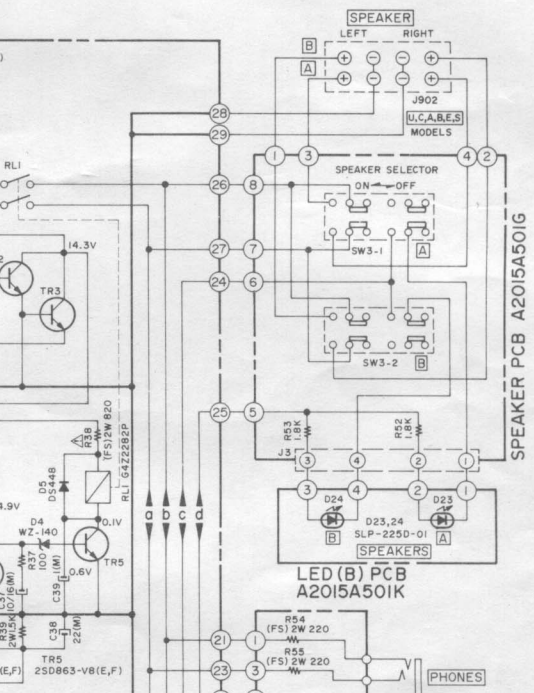
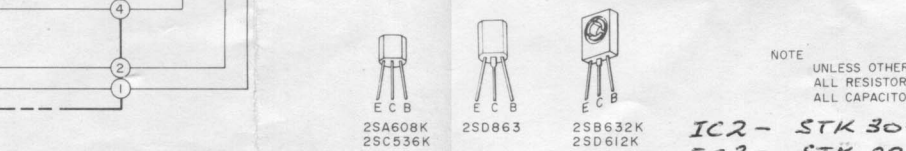

LED (B) PCB A2015A501K

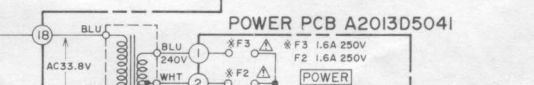

HEAD PHONE PCB A2015A501H

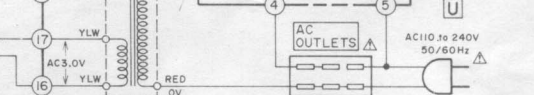

POWER PCB A2013D5041



POWER PCB A2013D5050

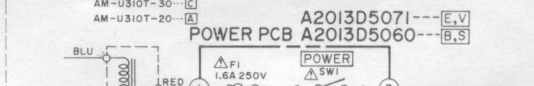

POWER PCB A2013D5071



POWER PCB A2013D5060

