



NSX-AJ300 U

NSX-SZ300 LH,EZ

NSX-AJ305 U

SERVICE MANUAL

COMPACT DISC
STEREO SYSTEM

BASIC TAPE MECHANISM : ZZM-3 PR1NM
BASIC CD MECHANISM : BZG-5 ZD3NM

- Replace this Service manual with "Revision Publishing" when it is issued.

aiwa

S/M Code No. 09-011-440-5T1

SIMPLE

DATA

PARTS LIST

! = Δ SAFTY PARTS
 C = Components marked

All components used on this model at the production line are shown in this service manual.

However, please note that not all components will be available as spare parts for after-sales service.

Components marked S and O are designated as spare parts for service and will be stocked at the spare parts centers.

Components marked X and R are not designated as spare parts for after sales service, and will not be stocked at the spare parts centers.

K NO. = Only use japanese.

! C	UNIT NAME	REF NO.	PARTS CODE	K NO.	DESCRIPTION	SUFFIX	MODEL NAME
O AC		C 0085	87-010-831-080		C-CAP,U 0.1-16 Z F	EZSM	CX-NSZ300
S AC		D 0082	87-A40-270-080		C-DIODE,MC2838	USM	CX-SNAJ300
S AC		D 0082	87-A40-270-080		C-DIODE,MC2838	USM	CX-SNAJ305
S AC		D 0082	87-A40-270-080		C-DIODE,MC2838	EZSM	CX-NSZ300
S AC		D 0082	87-A40-270-080	0E	C-DIODE,MC2838	USM	CX-SNAJ300
S AC		D 0082	87-A40-270-080	0E	C-DIODE,MC2838	USM	CX-SNAJ305
S AC		D 0083	87-A40-269-080		C-DIODE,MC2836	USM	CX-SNAJ300
S AC		D 0083	87-A40-269-080		C-DIODE,MC2836	USM	CX-SNAJ305
S AC		D 0083	87-A40-269-080		C-DIODE,MC2836	EZSM	CX-NSZ300
S AC		D 0083	87-A40-269-080	0E	C-DIODE,MC2836	USM	CX-SNAJ300
S AC		D 0083	87-A40-269-080	0E	C-DIODE,MC2836	USM	CX-SNAJ305
X AC		F 0081	88-100-000-010		PLATING-JW, 0.58 SN95	USM	CX-SNAJ300
X AC		F 0081	88-100-000-010		PLATING-JW, 0.58 SN95	USM	CX-SNAJ305
X AC		F 0081	88-100-000-010		PLATING-JW, 0.58 SN95	EZSM	CX-NSZ300
X AC		F 0081	88-100-000-010	0E	PLATING-JW, 0.58 SN95	USM	CX-SNAJ300
X AC		F 0081	88-100-000-010	0E	PLATING-JW, 0.58 SN95	USM	CX-SNAJ305
! O AC		PT 0081	8B-MA6-671-010	1B	PT,SUB BMA U (VRK)	USM	CX-SNAJ300
! O AC		PT 0081	8B-MA6-671-010	1B	PT,SUB BMA U (VRK)	USM	CX-SNAJ305
! O AC		PT 0081	8B-MA6-675-010		PT,SUB BMA E (VRK)	EZSM	CX-NSZ300
O AC		PT 0081	8B-NF9-661-010		PT,SUB BNF U (TAM)	USM	CX-SNAJ300
O AC		PT 0081	8B-NF9-661-010		PT,SUB BNF U (TAM)	USM	CX-SNAJ305
X AC		R 0097	88-140-225-080		RES,2.2M-1/2W J	USM	CX-SNAJ300
X AC		R 0097	88-140-225-080		RES,2.2M-1/2W J	USM	CX-SNAJ305
X AC		R 0097	88-140-225-080	0E	RES,2.2M-1/2W J	USM	CX-SNAJ300
X AC		R 0097	88-140-225-080	0E	RES,2.2M-1/2W J	USM	CX-SNAJ305
O AC		RY 0081	87-A91-418-010		RELAY,AC12V G5PA-1-M	USM	CX-SNAJ300
O AC		RY 0081	87-A91-418-010		RELAY,AC12V G5PA-1-M	USM	CX-SNAJ305
! O AC		RY 0081	87-A91-418-010		RELAY,AC12V G5PA-1-M	EZSM	CX-NSZ300
! O AC		RY 0081	87-A92-072-010	1A	RELAY,AC DC12V HRM3H-S-1POLE	USM	CX-SNAJ300
! O AC		RY 0081	87-A92-072-010	1A	RELAY,AC DC12V HRM3H-S-1POLE	USM	CX-SNAJ305
O AC		T 0081	87-A60-317-010		TERMINAL, 1P MSC	USM	CX-SNAJ300
O AC		T 0081	87-A60-317-010		TERMINAL, 1P MSC	USM	CX-SNAJ305
O AC		T 0081	87-A60-317-010		TERMINAL, 1P MSC	EZSM	CX-NSZ300
O AC		T 0081	87-A60-317-010	0E	TERMINAL, 1P MSC	USM	CX-SNAJ300
O AC		T 0081	87-A60-317-010	0E	TERMINAL, 1P MSC	USM	CX-SNAJ305
O AC		T 0082	87-A60-317-010		TERMINAL, 1P MSC	USM	CX-SNAJ300
O AC		T 0082	87-A60-317-010		TERMINAL, 1P MSC	USM	CX-SNAJ305
O AC		T 0082	87-A60-317-010		TERMINAL, 1P MSC	EZSM	CX-NSZ300
O AC		T 0082	87-A60-317-010	0E	TERMINAL, 1P MSC	USM	CX-SNAJ300
O AC		T 0082	87-A60-317-010	0E	TERMINAL, 1P MSC	USM	CX-SNAJ305
O AC		WH 0081	87-A90-510-010		HLDR,WIRE 2.5-9P	USM	CX-SNAJ300
O AC		WH 0081	87-A90-510-010		HLDR,WIRE 2.5-9P	USM	CX-SNAJ305
! O AC		WH 0081	87-A90-510-010		HLDR,WIRE 2.5-9P	EZSM	CX-NSZ300
! O AC		WH 0081	87-A90-510-010	0E	HLDR,WIRE 2.5-9P	USM	CX-SNAJ300
! O AC		WH 0081	87-A90-510-010	0E	HLDR,WIRE 2.5-9P	USM	CX-SNAJ305
O ACCESSORY			87-006-225-010		ANT,LOOP ANT NC2	LHSM	CX-NSZ300
O ACCESSORY			87-006-225-010		ANT,LOOP ANT NC2	USM	CX-SNAJ300
O ACCESSORY			87-006-225-010		ANT,LOOP ANT NC2	USM	CX-SNAJ305
O ACCESSORY			87-043-115-010		FEEDER-ANT, FM	LHSM	CX-NSZ300
O ACCESSORY			87-043-115-010		FEEDER-ANT, FM	USM	CX-SNAJ300
O ACCESSORY			87-043-115-010		FEEDER-ANT, FM	USM	CX-SNAJ305
O ACCESSORY			87-043-115-010	1A	FEEDER-ANT, FM	USM	CX-SNAJ300
O ACCESSORY			87-043-115-010	1A	FEEDER-ANT, FM	USM	CX-SNAJ305
O ACCESSORY			87-A90-118-010		ANT,WIRE FM(Z)	EZSM	CX-NSZ300
O ACCESSORY			87-A91-017-010		PLUG,CONVERSION JT-0476	LHSM	CX-NSZ300
O ACCESSORY			87-A92-150-010		ANT,LOOP AM NO-CONT	EZSM	CX-NSZ300
O ACCESSORY			87-A92-150-010	1A	ANT,LOOP AM NO-CONT	USM	CX-SNAJ300
O ACCESSORY			87-A92-150-010	1A	ANT,LOOP AM NO-CONT	USM	CX-SNAJ305
O ACCESSORY			8Z-NF9-701-210		RC UNIT,ZAS02	LHSM	CX-NSZ300
O ACCESSORY			8Z-NF9-701-210		RC UNIT,ZAS02	USM	CX-SNAJ300
O ACCESSORY			8Z-NF9-701-210	1A	RC UNIT,ZAS02	USM	CX-SNAJ305
O ACCESSORY			8Z-NF9-701-210	1H	RC UNIT,ZAS02	USM	CX-SNAJ300
O APPEARANCE			87-CE3-023-010		BADGE,AIWA 30N SILV	LHSM	CX-NSZ300
O APPEARANCE			87-CE3-023-010		BADGE,AIWA 30N SILV	USM	CX-SNAJ300
O APPEARANCE			87-CE3-023-010		BADGE,AIWA 30N SILV	USM	CX-SNAJ305
! O APPEARANCE			87-CE3-023-010		BADGE,AIWA 30N SILV	EZSM	CX-NSZ300
! O APPEARANCE			87-CE3-023-010	0E	BADGE,AIWA 30N SILV	LHSM	CX-NSZ300
! O APPEARANCE			87-CE3-023-010	0E	BADGE,AIWA 30N SILV	USM	CX-SNAJ300

PARTS LIST

! = Δ SAFTY PARTS
 C = Components marked

All components used on this model at the production line are shown in this service manual.

However, please note that not all components will be available as spare parts for after-sales service.

Components marked S and O are designated as spare parts for service and will be stocked at the spare parts centers.

Components marked X and R are not designated as spare parts for after sales service, and will not be stocked at the spare parts centers.

K NO. = Only use japanese.

! C	UNIT NAME	REF NO.	PARTS CODE	K NO.	DESCRIPTION	SUFFIX	MODEL NAME
!	O APPEARANCE		87-CE3-023-010	0E	BADGE,AIWA 30N SILV	USM	CX-SNAJ305
	O APPEARANCE		8B-NF9-001-010		CABI, FR U	LHSM	CX-NSZ300
	O APPEARANCE		8B-NF9-001-010		CABI, FR U	USM	CX-SNAJ300
	O APPEARANCE		8B-NF9-001-010		CABI, FR U	USM	CX-SNAJ305
	O APPEARANCE		8B-NF9-001-010	1H	CABI, FR U	USM	CX-SNAJ300
	O APPEARANCE		8B-NF9-001-010	1H	CABI, FR U	USM	CX-SNAJ305
	O APPEARANCE		8B-NF9-003-010		BOX, CASS 1	LHSM	CX-NSZ300
	O APPEARANCE		8B-NF9-003-010		BOX, CASS 1	USM	CX-SNAJ300
	O APPEARANCE		8B-NF9-003-010		BOX, CASS 1	USM	CX-SNAJ305
	O APPEARANCE		8B-NF9-003-010		BOX, CASS 1	EZSM	CX-NSZ300
	O APPEARANCE		8B-NF9-003-010	1	BOX, CASS 1	LHSM	CX-NSZ300
	O APPEARANCE		8B-NF9-003-010	1B	BOX, CASS 1	USM	CX-SNAJ300
	O APPEARANCE		8B-NF9-003-010	1B	BOX, CASS 1	USM	CX-SNAJ305
	O APPEARANCE		8B-NF9-004-010		BOX, CASS 2	LHSM	CX-NSZ300
	O APPEARANCE		8B-NF9-004-010		BOX, CASS 2	USM	CX-SNAJ300
	O APPEARANCE		8B-NF9-004-010		BOX, CASS 2	USM	CX-SNAJ305
	O APPEARANCE		8B-NF9-004-010		BOX, CASS 2	USM	CX-SNAJ300
	O APPEARANCE		8B-NF9-004-010		BOX, CASS 2	EZSM	CX-SNAJ305
	O APPEARANCE		8B-NF9-004-010	1	BOX, CASS 2	LHSM	CX-NSZ300
	O APPEARANCE		8B-NF9-004-010	1B	BOX, CASS 2	USM	CX-SNAJ300
	O APPEARANCE		8B-NF9-004-010	1B	BOX, CASS 2	USM	CX-SNAJ305
	O APPEARANCE		8B-NF9-006-010		PANEL, TRAY	LHSM	CX-NSZ300
	O APPEARANCE		8B-NF9-006-010		PANEL, TRAY	EZSM	CX-NSZ300
	O APPEARANCE		8B-NF9-006-010	1	PANEL, TRAY	LHSM	CX-NSZ300
	O APPEARANCE		8B-NF9-006-010	1B	PANEL, TRAY	USM	CX-SNAJ300
	O APPEARANCE		8B-NF9-006-010	1B	PANEL, TRAY	USM	CX-SNAJ305
	O APPEARANCE		8B-NF9-007-010		PANEL, JOG	LHSM	CX-NSZ300
	O APPEARANCE		8B-NF9-007-010		PANEL, JOG	EZSM	CX-NSZ300
	O APPEARANCE		8B-NF9-007-010	0E	PANEL, JOG	LHSM	CX-NSZ300
	O APPEARANCE		8B-NF9-007-010	0E	PANEL, JOG	USM	CX-SNAJ300
	O APPEARANCE		8B-NF9-007-010	0E	PANEL, JOG	USM	CX-SNAJ305
	O APPEARANCE		8B-NF9-025-010		PANEL, RIGHT	LHSM	CX-NSZ300
	O APPEARANCE		8B-NF9-025-010		PANEL, RIGHT	USM	CX-SNAJ300
	O APPEARANCE		8B-NF9-025-010		PANEL, RIGHT	USM	CX-SNAJ305
	O APPEARANCE		8B-NF9-025-010		PANEL, RIGHT	EZSM	CX-NSZ300
	O APPEARANCE		8B-NF9-025-010	1	PANEL, RIGHT	LHSM	CX-NSZ300
	O APPEARANCE		8B-NF9-025-010	1B	PANEL, RIGHT	USM	CX-SNAJ300
	O APPEARANCE		8B-NF9-025-010	1B	PANEL, RIGHT	USM	CX-SNAJ305
	O APPEARANCE		8B-NF9-026-010		PANEL, LEFT	LHSM	CX-NSZ300
	O APPEARANCE		8B-NF9-026-010		PANEL, LEFT	USM	CX-SNAJ300
	O APPEARANCE		8B-NF9-026-010		PANEL, LEFT	USM	CX-SNAJ305
	O APPEARANCE		8B-NF9-026-010		PANEL, LEFT	EZSM	CX-NSZ300
	O APPEARANCE		8B-NF9-026-010	1	PANEL, LEFT	LHSM	CX-NSZ300
	O APPEARANCE		8B-NF9-026-010	1B	PANEL, LEFT	USM	CX-SNAJ300
	O APPEARANCE		8B-NF9-026-010	1B	PANEL, LEFT	USM	CX-SNAJ305
	O APPEARANCE		8B-NF9-026-010	1B	PANEL, LEFT	USM	CX-SNAJ300
	O APPEARANCE		8B-NF9-027-010		PANEL, TOP	LHSM	CX-NSZ300
	O APPEARANCE		8B-NF9-027-010		PANEL, TOP	USM	CX-SNAJ300
	O APPEARANCE		8B-NF9-027-010		PANEL, TOP	USM	CX-SNAJ305
	O APPEARANCE		8B-NF9-027-010		PANEL, TOP	EZSM	CX-NSZ300
	O APPEARANCE		8B-NF9-027-010	1C	PANEL, TOP	LHSM	CX-NSZ300
	O APPEARANCE		8B-NF9-027-010	1C	PANEL, TOP	USM	CX-SNAJ300
	O APPEARANCE		8B-NF9-027-010	1C	PANEL, TOP	USM	CX-SNAJ305
	O APPEARANCE		8B-NF9-032-010		CABI, FR	EZSM	CX-NSZ300
	O APPEARANCE		8B-NF9-032-010	1H	CABI, FR	LHSM	CX-NSZ300
	O APPEARANCE		8B-NF9-041-010		PANEL, TRAY U	USM	CX-SNAJ300
	O APPEARANCE		8B-NF9-041-010		PANEL, TRAY U	USM	CX-SNAJ305
	O APPEARANCE		8B-NF9-046-010		PANEL, JOG U	USM	CX-SNAJ300
	O APPEARANCE		8B-NF9-046-010		PANEL, JOG U	USM	CX-SNAJ305
	O APPEARANCE		8B-NF9-069-010		CABI, REAR USM	USM	CX-SNAJ300
	O APPEARANCE		8B-NF9-069-010	1B	CABI, REAR USM	USM	CX-SNAJ300
	O APPEARANCE		8B-NF9-070-010		CABI, REAR USM 305	USM	CX-SNAJ305
	O APPEARANCE		8B-NF9-070-010	1B	CABI, REAR USM 305	USM	CX-SNAJ305
	O APPEARANCE		8B-NF9-071-010		CABI, REAR LHSM	LHSM	CX-NSZ300
	O APPEARANCE		8B-NF9-071-010	1	CABI, REAR LHSM	LHSM	CX-NSZ300
	O APPEARANCE		8B-NF9-072-010		CABI, REAR EZSM	EZSM	CX-NSZ300
X	CD		M8-BZG-590-030		BZG-5 ZD3NM	LHSM	CX-NSZ300
X	CD		M8-BZG-590-030		BZG-5 ZD3NM	USM	CX-SNAJ300
X	CD		M8-BZG-590-030		BZG-5 ZD3NM	USM	CX-SNAJ305
X	CD		M8-BZG-590-030		BZG-5 ZD3NM	EZSM	CX-NSZ300
X	CD		M8-BZG-590-030	--	BZG-5 ZD3NM	LHSM	CX-NSZ300
X	CD		M8-BZG-590-030	--	BZG-5 ZD3NM	USM	CX-SNAJ300

PARTS LIST

! = Δ SAFTY PARTS
 C = Components marked

All components used on this model at the production line are shown in this service manual.

However, please note that not all components will be available as spare parts for after-sales service.

Components marked S and O are designated as spare parts for service and will be stocked at the spare parts centers.

Components marked X and R are not designated as spare parts for after sales service, and will not be stocked at the spare parts centers.

K NO. = Only use japanese.

! C	UNIT NAME	REF NO.	PARTS CODE	K NO.	DESCRIPTION	SUFFIX	MODEL NAME
X	CD		M8-BZG-590-030	--	BZG-5 ZD3NM	USM	CX-SNAJ305
X	ELECTRICAL		87-069-033-010		CABLE,TIE	LHSM	CX-NSZ300
X	ELECTRICAL		87-069-033-010		CABLE,TIE	USM	CX-SNAJ300
X	ELECTRICAL		87-069-033-010		CABLE,TIE	USM	CX-SNAJ305
!	X ELECTRICAL		87-069-033-010		CABLE,TIE	EZSM	CX-NSZ300
!	X ELECTRICAL		87-069-033-010	0E	CABLE,TIE	LHSM	CX-NSZ300
!	X ELECTRICAL		87-069-033-010	0E	CABLE,TIE	USM	CX-SNAJ300
!	X ELECTRICAL		87-069-033-010	0E	CABLE,TIE	USM	CX-SNAJ305
!	O ELECTRICAL		87-085-185-010		BUSHING,AC CORD(E) CM-22B	LHSM	CX-NSZ300
!	O ELECTRICAL		87-085-185-010		BUSHING,AC CORD(E) CM-22B	EZSM	CX-NSZ300
!	O ELECTRICAL		87-085-185-010	0E	BUSHING,AC CORD(E) CM-22B	LHSM	CX-NSZ300
!	O ELECTRICAL		87-A91-422-010		BUSHING,AC CORD(U)	USM	CX-SNAJ300
!	O ELECTRICAL		87-A91-422-010		BUSHING,AC CORD(U)	USM	CX-SNAJ305
!	O ELECTRICAL		87-A91-422-010	1D	BUSHING,AC CORD(U)	USM	CX-SNAJ300
!	O ELECTRICAL		87-A91-422-010	1D	BUSHING,AC CORD(U)	USM	CX-SNAJ305
!	O ELECTRICAL		88-906-251-110		FF-CABLE,6P 1.25	LHSM	CX-NSZ300
!	O ELECTRICAL		88-906-251-110		FF-CABLE,6P 1.25	USM	CX-SNAJ300
!	O ELECTRICAL		88-906-251-110		FF-CABLE,6P 1.25	USM	CX-SNAJ305
!	O ELECTRICAL		88-906-251-110		FF-CABLE,6P 1.25	EZSM	CX-NSZ300
!	O ELECTRICAL		88-906-251-110	1A	FF-CABLE,6P 1.25	LHSM	CX-NSZ300
!	O ELECTRICAL		88-906-251-110	1A	FF-CABLE,6P 1.25	USM	CX-SNAJ300
!	O ELECTRICAL		88-906-251-110	1A	FF-CABLE,6P 1.25	USM	CX-SNAJ305
!	O ELECTRICAL		88-906-251-110	1A	FF-CABLE,6P 1.25	LHSM	CX-NSZ300
!	O ELECTRICAL		88-908-301-110		FF-CABLE,8P 1.25	LHSM	CX-NSZ300
!	O ELECTRICAL		88-908-301-110		FF-CABLE,8P 1.25	USM	CX-SNAJ300
!	O ELECTRICAL		88-908-301-110		FF-CABLE,8P 1.25	USM	CX-SNAJ305
!	O ELECTRICAL		88-908-301-110		FF-CABLE,8P 1.25	EZSM	CX-NSZ300
!	O ELECTRICAL		88-908-301-110	1A	FF-CABLE,8P 1.25	LHSM	CX-SNAJ300
!	O ELECTRICAL		88-908-301-110	1A	FF-CABLE,8P 1.25	USM	CX-SNAJ300
!	O ELECTRICAL		88-908-301-110	1A	FF-CABLE,8P 1.25	USM	CX-SNAJ305
!	O ELECTRICAL		88-911-101-110		FF-CABLE,11P 1.25	LHSM	CX-NSZ300
!	O ELECTRICAL		88-911-101-110		FF-CABLE,11P 1.25	USM	CX-SNAJ300
!	O ELECTRICAL		88-911-101-110		FF-CABLE,11P 1.25	EZSM	CX-NSZ300
!	O ELECTRICAL		88-911-101-110	0E	FF-CABLE,11P 1.25	LHSM	CX-NSZ300
!	O ELECTRICAL		88-911-101-110	0E	FF-CABLE,11P 1.25	USM	CX-SNAJ300
!	O ELECTRICAL		88-911-101-110	0E	FF-CABLE,11P 1.25	USM	CX-SNAJ305
!	O ELECTRICAL	PT 0001	8B-NF9-612-010		PT,BNF-9 U	USM	CX-SNAJ305
!	O ELECTRICAL	PT 0001	8B-NF9-612-010	2M	PT,BNF-9 U	USM	CX-SNAJ305
!	O ELECTRICAL	PT 0001	8B-NF9-615-010		PT,BNF-9 LH	LHSM	CX-NSZ300
!	O ELECTRICAL	PT 0001	8B-NF9-615-010	2P	PT,BNF-9 LH	LHSM	CX-NSZ300
!	O ELECTRICAL	PT 0001	8B-NF9-616-010		PT,BNF-9 EZ-LOW	EZSM	CX-NSZ300
!	O ELECTRICAL	PT 0001	8B-NFY-610-010		PT,BNF-Y U	USM	CX-SNAJ300
!	O ELECTRICAL	PT 0001	8B-NFY-690-010	--	PT,BNF-Y U	USM	CX-SNAJ300
!	O ELECTRICAL	W 0001	87-A80-092-010		AC CORD ASSY,E BLK SUN FAI	LHSM	CX-NSZ300
!	O ELECTRICAL	W 0001	87-A80-110-010		AC CORD ASSY,U SPT-2W	USM	CX-SNAJ300
!	O ELECTRICAL	W 0001	87-A80-110-010		AC CORD ASSY,U SPT-2W	USM	CX-SNAJ305
!	O ELECTRICAL	W 0001	87-A80-149-010	1B	AC CORD ASSY,U BLK	USM	CX-SNAJ300
!	O ELECTRICAL	W 0001	87-A80-149-010	1B	AC CORD ASSY,U BLK	USM	CX-SNAJ305
!	O ELECTRICAL	W 0001	87-A80-157-010		AC CORD ASSY,E BLK CC	EZSM	CX-NSZ300
!	O ELECTRICAL	W 0001	87-A80-157-010	1B	AC CORD ASSY,E BLK CC	LHSM	CX-NSZ300
!	O FRCB MECHA	*	8B-NF9-207-010		GUIDE,FL 90.2-20	LHSM	CX-NSZ300
!	O FRCB MECHA	*	8B-NF9-207-010		GUIDE,FL 90.2-20	USM	CX-SNAJ300
!	O FRCB MECHA	*	8B-NF9-207-010		GUIDE,FL 90.2-20	USM	CX-SNAJ305
!	O FRCB MECHA	*	8B-NF9-207-010		GUIDE,FL 90.2-20	EZSM	CX-NSZ300
!	O FRCB MECHA	*	8B-NF9-207-010	0E	GUIDE,FL 90.2-20	LHSM	CX-NSZ300
!	O FRCB MECHA	*	8B-NF9-207-010	0E	GUIDE,FL 90.2-20	USM	CX-SNAJ300
!	O FRCB MECHA	*	8B-NF9-207-010	0E	GUIDE,FL 90.2-20	USM	CX-SNAJ305
!	O FUNC/E.VR	C 0605	87-012-280-080		C-CAP,U 3300P-50 K B	LHSM	CX-NSZ300
!	O FUNC/E.VR	C 0605	87-012-280-080		C-CAP,U 3300P-50 K B	USM	CX-SNAJ300
!	O FUNC/E.VR	C 0605	87-012-280-080		C-CAP,U 3300P-50 K B	USM	CX-SNAJ305
!	O FUNC/E.VR	C 0605	87-012-280-080		C-CAP,U 3300P-50 K B	EZSM	CX-NSZ300
!	O FUNC/E.VR	C 0605	87-012-280-080	0E	C-CAP,U 3300P-50 K B	USM	CX-SNAJ300
!	O FUNC/E.VR	C 0605	87-012-280-080	0E	C-CAP,U 3300P-50 K B	USM	CX-SNAJ305
!	O FUNC/E.VR	C 0606	87-012-280-080		C-CAP,U 3300P-50 K B	LHSM	CX-NSZ300
!	O FUNC/E.VR	C 0606	87-012-280-080		C-CAP,U 3300P-50 K B	USM	CX-SNAJ300
!	O FUNC/E.VR	C 0606	87-012-280-080		C-CAP,U 3300P-50 K B	USM	CX-SNAJ305
!	O FUNC/E.VR	C 0606	87-012-280-080		C-CAP,U 3300P-50 K B	EZSM	CX-NSZ300
!	O FUNC/E.VR	C 0606	87-012-280-080	0E	C-CAP,U 3300P-50 K B	USM	CX-SNAJ300
!	O FUNC/E.VR	C 0606	87-012-280-080	0E	C-CAP,U 3300P-50 K B	USM	CX-SNAJ305
!	O FUNC/E.VR	C 0609	87-010-785-080		C-CAP,U 0.015-25 K B GRM	LHSM	CX-NSZ300

PARTS LIST

! = Δ SAFTY PARTS
 C = Components marked

All components used on this model at the production line are shown in this service manual.

However, please note that not all components will be available as spare parts for after-sales service.

Components marked S and O are designated as spare parts for service and will be stocked at the spare parts centers.

Components marked X and R are not designated as spare parts for after sales service, and will not be stocked at the spare parts centers.

K NO. = Only use japanese.

! C	UNIT NAME	REF NO.	PARTS CODE	K NO.	DESCRIPTION	SUFFIX	MODEL NAME
O	FUNC/E.VR	C	0609 87-010-785-080		C-CAP,U 0.015-25 K B GRM	USM	CX-SNAJ300
O	FUNC/E.VR	C	0609 87-010-785-080		C-CAP,U 0.015-25 K B GRM	USM	CX-SNAJ305
O	FUNC/E.VR	C	0609 87-010-785-080		C-CAP,U 0.015-25 K B GRM	EZSM	CX-NSZ300
O	FUNC/E.VR	C	0609 87-010-785-080	OE	C-CAP,U 0.015-25 K B GRM	USM	CX-SNAJ300
O	FUNC/E.VR	C	0609 87-010-785-080	OE	C-CAP,U 0.015-25 K B GRM	USM	CX-SNAJ305
O	FUNC/E.VR	C	0610 87-010-785-080		C-CAP,U 0.015-25 K B GRM	LHSM	CX-NSZ300
O	FUNC/E.VR	C	0610 87-010-785-080		C-CAP,U 0.015-25 K B GRM	USM	CX-SNAJ300
O	FUNC/E.VR	C	0610 87-010-785-080		C-CAP,U 0.015-25 K B GRM	USM	CX-SNAJ305
O	FUNC/E.VR	C	0610 87-010-785-080		C-CAP,U 0.015-25 K B GRM	EZSM	CX-NSZ300
O	FUNC/E.VR	C	0610 87-010-785-080	OE	C-CAP,U 0.015-25 K B GRM	USM	CX-SNAJ300
O	FUNC/E.VR	C	0610 87-010-785-080	OE	C-CAP,U 0.015-25 K B GRM	USM	CX-SNAJ305
O	FUNC/E.VR	C	0611 87-A12-084-080		CAP,E 0.22-50 SMG	LHSM	CX-NSZ300
O	FUNC/E.VR	C	0611 87-A12-084-080		CAP,E 0.22-50 SMG	USM	CX-SNAJ300
O	FUNC/E.VR	C	0611 87-A12-084-080		CAP,E 0.22-50 SMG	USM	CX-SNAJ305
O	FUNC/E.VR	C	0611 87-A12-084-080		CAP,E 0.22-50 SMG	EZSM	CX-NSZ300
O	FUNC/E.VR	C	0611 87-A12-084-080	OE	CAP,E 0.22-50 SMG	USM	CX-SNAJ300
O	FUNC/E.VR	C	0611 87-A12-084-080	OE	CAP,E 0.22-50 SMG	USM	CX-SNAJ305
O	FUNC/E.VR	C	0612 87-A12-084-080		CAP,E 0.22-50 SMG	LHSM	CX-NSZ300
O	FUNC/E.VR	C	0612 87-A12-084-080		CAP,E 0.22-50 SMG	USM	CX-SNAJ300
O	FUNC/E.VR	C	0612 87-A12-084-080		CAP,E 0.22-50 SMG	USM	CX-SNAJ305
O	FUNC/E.VR	C	0612 87-A12-084-080		CAP,E 0.22-50 SMG	EZSM	CX-NSZ300
O	FUNC/E.VR	C	0612 87-A12-084-080	OE	CAP,E 0.22-50 SMG	USM	CX-SNAJ300
O	FUNC/E.VR	C	0612 87-A12-084-080	OE	CAP,E 0.22-50 SMG	LHSM	CX-NSZ300
O	FUNC/E.VR	C	0613 87-A12-084-080		CAP,E 0.22-50 SMG	USM	CX-SNAJ300
O	FUNC/E.VR	C	0613 87-A12-084-080		CAP,E 0.22-50 SMG	USM	CX-SNAJ305
O	FUNC/E.VR	C	0613 87-A12-084-080		CAP,E 0.22-50 SMG	EZSM	CX-NSZ300
O	FUNC/E.VR	C	0613 87-A12-084-080	OE	CAP,E 0.22-50 SMG	USM	CX-SNAJ300
O	FUNC/E.VR	C	0613 87-A12-084-080	OE	CAP,E 0.22-50 SMG	USM	CX-SNAJ305
O	FUNC/E.VR	C	0614 87-A12-084-080		CAP,E 0.22-50 SMG	LHSM	CX-NSZ300
O	FUNC/E.VR	C	0614 87-A12-084-080		CAP,E 0.22-50 SMG	USM	CX-SNAJ300
O	FUNC/E.VR	C	0614 87-A12-084-080		CAP,E 0.22-50 SMG	USM	CX-SNAJ305
O	FUNC/E.VR	C	0614 87-A12-084-080		CAP,E 0.22-50 SMG	EZSM	CX-NSZ300
O	FUNC/E.VR	C	0614 87-A12-084-080	OE	CAP,E 0.22-50 SMG	USM	CX-SNAJ300
O	FUNC/E.VR	C	0614 87-A12-084-080	OE	CAP,E 0.22-50 SMG	USM	CX-SNAJ305
O	FUNC/E.VR	C	0615 87-012-172-080		C-CAP,U 10P-50 D CH	LHSM	CX-NSZ300
O	FUNC/E.VR	C	0615 87-012-172-080		C-CAP,U 10P-50 D CH	USM	CX-SNAJ300
O	FUNC/E.VR	C	0615 87-012-172-080		C-CAP,U 10P-50 D CH	USM	CX-SNAJ305
O	FUNC/E.VR	C	0615 87-012-172-080		C-CAP,U 10P-50 D CH	EZSM	CX-NSZ300
O	FUNC/E.VR	C	0615 87-012-172-080	OE	C-CAP,U 10P-50 D CH	USM	CX-SNAJ300
O	FUNC/E.VR	C	0615 87-012-172-080	OE	C-CAP,U 10P-50 D CH	USM	CX-SNAJ305
O	FUNC/E.VR	C	0616 87-016-459-080		CAP,E 470-10 M SMG	LHSM	CX-NSZ300
O	FUNC/E.VR	C	0616 87-016-459-080		CAP,E 470-10 M SMG	USM	CX-SNAJ300
O	FUNC/E.VR	C	0616 87-016-459-080		CAP,E 470-10 M SMG	USM	CX-SNAJ305
O	FUNC/E.VR	C	0616 87-016-459-080		CAP,E 470-10 M SMG	EZSM	CX-NSZ300
O	FUNC/E.VR	C	0616 87-016-459-080	OE	CAP,E 470-10 M SMG	USM	CX-SNAJ300
O	FUNC/E.VR	C	0616 87-016-459-080	OE	CAP,E 470-10 M SMG	USM	CX-SNAJ305
O	FUNC/E.VR	C	0617 87-016-459-080		CAP,E 470-10 M SMG	LHSM	CX-NSZ300
O	FUNC/E.VR	C	0617 87-016-459-080		CAP,E 470-10 M SMG	USM	CX-SNAJ300
O	FUNC/E.VR	C	0617 87-016-459-080		CAP,E 470-10 M SMG	USM	CX-SNAJ305
O	FUNC/E.VR	C	0617 87-016-459-080		CAP,E 470-10 M SMG	EZSM	CX-NSZ300
O	FUNC/E.VR	C	0617 87-016-459-080	OE	CAP,E 470-10 M SMG	USM	CX-SNAJ300
O	FUNC/E.VR	C	0617 87-016-459-080	OE	CAP,E 470-10 M SMG	USM	CX-SNAJ305
O	FUNC/E.VR	C	0618 87-A12-091-080		CAP,E 10-50 SMG	LHSM	CX-NSZ300
O	FUNC/E.VR	C	0618 87-A12-091-080		CAP,E 10-50 SMG	USM	CX-SNAJ300
O	FUNC/E.VR	C	0618 87-A12-091-080		CAP,E 10-50 SMG	USM	CX-SNAJ305
O	FUNC/E.VR	C	0618 87-A12-091-080		CAP,E 10-50 SMG	EZSM	CX-NSZ300
O	FUNC/E.VR	C	0618 87-A12-091-080	OE	CAP,E 10-50 SMG	USM	CX-SNAJ300
O	FUNC/E.VR	C	0618 87-A12-091-080	OE	CAP,E 10-50 SMG	USM	CX-SNAJ305
O	FUNC/E.VR	C	0620 87-010-263-080		CAP,E 100-10 M 11L SME	LHSM	CX-NSZ300
O	FUNC/E.VR	C	0620 87-010-263-080		CAP,E 100-10 M 11L SME	USM	CX-SNAJ300
O	FUNC/E.VR	C	0620 87-010-263-080		CAP,E 100-10 M 11L SME	USM	CX-SNAJ305
O	FUNC/E.VR	C	0620 87-010-263-080		CAP,E 100-10 M 11L SME	EZSM	CX-NSZ300
O	FUNC/E.VR	C	0620 87-010-263-080	OE	CAP,E 100-10 M 11L SME	USM	CX-SNAJ300
O	FUNC/E.VR	C	0620 87-010-263-080	OE	CAP,E 100-10 M 11L SME	USM	CX-SNAJ305
O	FUNC/E.VR	C	0623 87-A12-088-080		CAP,E 2.2-50 SMG	LHSM	CX-NSZ300
O	FUNC/E.VR	C	0623 87-A12-088-080		CAP,E 2.2-50 SMG	USM	CX-SNAJ300
O	FUNC/E.VR	C	0623 87-A12-088-080		CAP,E 2.2-50 SMG	USM	CX-SNAJ305
O	FUNC/E.VR	C	0623 87-A12-372-080		CAP,M 0.047-100 J CP	EZSM	CX-NSZ300
O	FUNC/E.VR	C	0623 87-A12-372-080	OE	CAP,M 0.047-100 J CP	USM	CX-SNAJ300

PARTS LIST

! = Δ SAFTY PARTS
 C = Components marked

All components used on this model at the production line are shown in this service manual.

However, please note that not all components will be available as spare parts for after-sales service.

Components marked S and O are designated as spare parts for service and will be stocked at the spare parts centers.

Components marked X and R are not designated as spare parts for after sales service, and will not be stocked at the spare parts centers.

K NO. = Only use japanese.

! C	UNIT NAME	REF NO.	PARTS CODE	K NO.	DESCRIPTION	SUFFIX	MODEL NAME
O	FUNC/E.VR	C	0623 87-A12-372-080	OE	CAP,M 0.047-100 J CP	USM	CX-SNAJ305
O	FUNC/E.VR	C	0624 87-A12-088-080		CAP,E 2.2-50 SMG	LHSM	CX-NSZ300
O	FUNC/E.VR	C	0624 87-A12-088-080		CAP,E 2.2-50 SMG	USM	CX-SNAJ300
O	FUNC/E.VR	C	0624 87-A12-088-080		CAP,E 2.2-50 SMG	USM	CX-SNAJ305
O	FUNC/E.VR	C	0624 87-A12-372-080		CAP,M 0.047-100 J CP	EZSM	CX-NSZ300
O	FUNC/E.VR	C	0624 87-A12-372-080	OE	CAP,M 0.047-100 J CP	USM	CX-SNAJ300
O	FUNC/E.VR	C	0624 87-A12-372-080	OE	CAP,M 0.047-100 J CP	USM	CX-SNAJ305
O	FUNC/E.VR	C	0630 87-016-669-080		C-CAP,S 0.1-25 K B	LHSM	CX-NSZ300
O	FUNC/E.VR	C	0630 87-016-669-080		C-CAP,S 0.1-25 K B	USM	CX-SNAJ300
O	FUNC/E.VR	C	0630 87-016-669-080		C-CAP,S 0.1-25 K B	USM	CX-SNAJ305
O	FUNC/E.VR	C	0630 87-016-669-080		C-CAP,S 0.1-25 K B	EZSM	CX-NSZ300
O	FUNC/E.VR	C	0630 87-016-669-080	OE	C-CAP,S 0.1-25 K B	USM	CX-SNAJ300
O	FUNC/E.VR	C	0630 87-016-669-080	OE	C-CAP,S 0.1-25 K B	USM	CX-SNAJ305
O	FUNC/E.VR	C	0631 87-012-281-080		C-CAP,U 3900P-50 K B GRM	LHSM	CX-NSZ300
O	FUNC/E.VR	C	0631 87-012-281-080		C-CAP,U 3900P-50 K B GRM	USM	CX-SNAJ300
O	FUNC/E.VR	C	0631 87-012-281-080		C-CAP,U 3900P-50 K B GRM	USM	CX-SNAJ305
O	FUNC/E.VR	C	0631 87-012-281-080		C-CAP,U 3900P-50 K B GRM	EZSM	CX-NSZ300
O	FUNC/E.VR	C	0631 87-012-281-080	OE	C-CAP,U 3900P-50 K B GRM	USM	CX-SNAJ300
O	FUNC/E.VR	C	0631 87-012-281-080	OE	C-CAP,U 3900P-50 K B GRM	USM	CX-SNAJ305
O	FUNC/E.VR	C	0632 87-012-281-080		C-CAP,U 3900P-50 K B GRM	LHSM	CX-NSZ300
O	FUNC/E.VR	C	0632 87-012-281-080		C-CAP,U 3900P-50 K B GRM	USM	CX-SNAJ300
O	FUNC/E.VR	C	0632 87-012-281-080		C-CAP,U 3900P-50 K B GRM	USM	CX-SNAJ305
O	FUNC/E.VR	C	0632 87-012-281-080	OE	C-CAP,U 3900P-50 K B GRM	USM	CX-SNAJ300
O	FUNC/E.VR	C	0632 87-012-281-080	OE	C-CAP,U 3900P-50 K B GRM	USM	CX-SNAJ305
O	FUNC/E.VR	C	0633 87-A11-070-080		C-CAP,U 0.033-16 K B	LHSM	CX-NSZ300
O	FUNC/E.VR	C	0633 87-A11-070-080		C-CAP,U 0.033-16 K B	USM	CX-SNAJ300
O	FUNC/E.VR	C	0633 87-A11-070-080		C-CAP,U 0.033-16 K B	USM	CX-SNAJ305
O	FUNC/E.VR	C	0633 87-A11-070-080		C-CAP,U 0.033-16 K B	EZSM	CX-NSZ300
O	FUNC/E.VR	C	0633 87-A11-070-080	OE	C-CAP,U 0.033-16 K B	USM	CX-SNAJ300
O	FUNC/E.VR	C	0633 87-A11-070-080	OE	C-CAP,U 0.033-16 K B	USM	CX-SNAJ305
O	FUNC/E.VR	C	0634 87-A11-070-080		C-CAP,U 0.033-16 K B	LHSM	CX-NSZ300
O	FUNC/E.VR	C	0634 87-A11-070-080		C-CAP,U 0.033-16 K B	USM	CX-SNAJ300
O	FUNC/E.VR	C	0634 87-A11-070-080		C-CAP,U 0.033-16 K B	USM	CX-SNAJ305
O	FUNC/E.VR	C	0634 87-A11-070-080		C-CAP,U 0.033-16 K B	EZSM	CX-NSZ300
O	FUNC/E.VR	C	0634 87-A11-070-080	OE	C-CAP,U 0.033-16 K B	USM	CX-SNAJ300
O	FUNC/E.VR	C	0634 87-A11-070-080	OE	C-CAP,U 0.033-16 K B	USM	CX-SNAJ305
O	FUNC/E.VR	C	0661 87-012-336-080		C-CAP,U 330P-50 J SL	LHSM	CX-NSZ300
O	FUNC/E.VR	C	0661 87-012-336-080		C-CAP,U 330P-50 J SL	USM	CX-SNAJ300
O	FUNC/E.VR	C	0661 87-012-336-080		C-CAP,U 330P-50 J SL	USM	CX-SNAJ305
O	FUNC/E.VR	C	0661 87-012-336-080		C-CAP,U 330P-50 J SL	EZSM	CX-NSZ300
O	FUNC/E.VR	C	0661 87-012-336-080	OE	C-CAP,U 330P-50 J SL	USM	CX-SNAJ300
O	FUNC/E.VR	C	0661 87-012-336-080	OE	C-CAP,U 330P-50 J SL	USM	CX-SNAJ305
O	FUNC/E.VR	C	0662 87-012-336-080		C-CAP,U 330P-50 J SL	LHSM	CX-NSZ300
O	FUNC/E.VR	C	0662 87-012-336-080		C-CAP,U 330P-50 J SL	USM	CX-SNAJ300
O	FUNC/E.VR	C	0662 87-012-336-080		C-CAP,U 330P-50 J SL	USM	CX-SNAJ305
O	FUNC/E.VR	C	0662 87-012-336-080		C-CAP,U 330P-50 J SL	EZSM	CX-NSZ300
O	FUNC/E.VR	C	0662 87-012-336-080	OE	C-CAP,U 330P-50 J SL	USM	CX-SNAJ300
O	FUNC/E.VR	C	0662 87-012-336-080	OE	C-CAP,U 330P-50 J SL	USM	CX-SNAJ305
O	FUNC/E.VR	C	0669 87-012-274-080		C-CAP,U 1000P-50 K B	EZSM	CX-NSZ300
O	FUNC/E.VR	C	0670 87-012-274-080		C-CAP,U 1000P-50 K B	EZSM	CX-NSZ300
O	FUNC/E.VR	C	0677 87-012-286-080		C-CAP,U 0.01-25 K B	LHSM	CX-NSZ300
O	FUNC/E.VR	C	0677 87-012-286-080		C-CAP,U 0.01-25 K B	USM	CX-SNAJ300
O	FUNC/E.VR	C	0677 87-012-286-080		C-CAP,U 0.01-25 K B	USM	CX-SNAJ305
O	FUNC/E.VR	C	0677 87-012-286-080		C-CAP,U 0.01-25 K B	EZSM	CX-NSZ300
O	FUNC/E.VR	C	0677 87-012-286-080	OE	C-CAP,U 0.01-25 K B	USM	CX-SNAJ300
O	FUNC/E.VR	C	0677 87-012-286-080	OE	C-CAP,U 0.01-25 K B	USM	CX-SNAJ305
X	FUNC/E.VR	C	0678 88-108-000-080		C-JUMPER,U	LHSM	CX-NSZ300
X	FUNC/E.VR	C	0678 88-108-000-080		C-JUMPER,U	USM	CX-SNAJ300
X	FUNC/E.VR	C	0678 88-108-000-080		C-JUMPER,U	USM	CX-SNAJ305
X	FUNC/E.VR	C	0678 88-108-000-080		C-JUMPER,U	EZSM	CX-NSZ300
X	FUNC/E.VR	C	0678 88-108-000-080	OE	C-JUMPER,U	USM	CX-SNAJ300
X	FUNC/E.VR	C	0678 88-108-000-080	OE	C-JUMPER,U	USM	CX-SNAJ305
O	FUNC/E.VR	CN	0601 87-099-719-010		CONN,30P H BLK TYK-B(X)	LHSM	CX-NSZ300
O	FUNC/E.VR	CN	0601 87-099-719-010		CONN,30P H BLK TYK-B(X)	USM	CX-SNAJ300
O	FUNC/E.VR	CN	0601 87-099-719-010		CONN,30P H BLK TYK-B(X)	USM	CX-SNAJ305
!	FUNC/E.VR	CN	0601 87-099-719-010		CONN,30P H BLK TYK-B(X)	EZSM	CX-NSZ300
!	FUNC/E.VR	CN	0601 87-099-719-010	1B	CONN,30P H BLK TYK-B(X)	USM	CX-SNAJ300
!	FUNC/E.VR	CN	0601 87-099-719-010	1B	CONN,30P H BLK TYK-B(X)	USM	CX-SNAJ305
O	FUNC/E.VR	CN	0602 87-A60-131-010		CONN,6P V FE	LHSM	CX-NSZ300

PARTS LIST

! = Δ SAFTY PARTS
 C = Components marked

All components used on this model at the production line are shown in this service manual.

However, please note that not all components will be available as spare parts for after-sales service.

Components marked S and O are designated as spare parts for service and will be stocked at the spare parts centers.

Components marked X and R are not designated as spare parts for after sales service, and will not be stocked at the spare parts centers.

K NO. = Only use japanese.

! C	UNIT NAME	REF NO.	PARTS CODE	K NO.	DESCRIPTION	SUFFIX	MODEL NAME
O	FUNC/E.VR	CN 0602	87-A60-131-010		CONN,6P V FE	USM	CX-SNAJ300
O	FUNC/E.VR	CN 0602	87-A60-131-010		CONN,6P V FE	USM	CX-SNAJ305
!	O FUNC/E.VR	CN 0602	87-A60-131-010		CONN,6P V FE	EZSM	CX-NSZ300
!	O FUNC/E.VR	CN 0602	87-A60-131-010	OE	CONN,6P V FE	USM	CX-SNAJ300
!	O FUNC/E.VR	CN 0602	87-A60-131-010	OE	CONN,6P V FE	USM	CX-SNAJ305
S	FUNC/E.VR	D 0601	87-A40-739-080		ZENER,UZ2.7BSA	LHSM	CX-NSZ300
S	FUNC/E.VR	D 0601	87-A40-739-080		ZENER,UZ2.7BSA	USM	CX-SNAJ300
S	FUNC/E.VR	D 0601	87-A40-739-080		ZENER,UZ2.7BSA	USM	CX-SNAJ305
S	FUNC/E.VR	D 0601	87-A40-739-080		ZENER,UZ2.7BSA	EZSM	CX-NSZ300
S	FUNC/E.VR	D 0601	87-A40-739-080	OE	ZENER,UZ2.7BSA	USM	CX-SNAJ300
S	FUNC/E.VR	D 0601	87-A40-739-080	OE	ZENER,UZ2.7BSA	USM	CX-SNAJ305
S	FUNC/E.VR	D 0602	87-A40-739-080	OE	ZENER,UZ2.7BSA	LHSM	CX-NSZ300
S	FUNC/E.VR	D 0602	87-A40-739-080		ZENER,UZ2.7BSA	USM	CX-SNAJ300
S	FUNC/E.VR	D 0602	87-A40-739-080		ZENER,UZ2.7BSA	USM	CX-SNAJ305
S	FUNC/E.VR	D 0602	87-A40-739-080		ZENER,UZ2.7BSA	USM	CX-SNAJ300
S	FUNC/E.VR	D 0602	87-A40-739-080	OE	ZENER,UZ2.7BSA	EZSM	CX-NSZ300
S	FUNC/E.VR	D 0602	87-A40-739-080	OE	ZENER,UZ2.7BSA	USM	CX-SNAJ300
X	FUNC/E.VR	FB 0602	88-100-000-010		PLATING-JW, 0.58 SN95	LHSM	CX-NSZ300
X	FUNC/E.VR	FB 0602	88-100-000-010		PLATING-JW, 0.58 SN95	USM	CX-SNAJ300
X	FUNC/E.VR	FB 0602	88-100-000-010		PLATING-JW, 0.58 SN95	USM	CX-SNAJ305
X	FUNC/E.VR	FB 0602	88-100-000-010		PLATING-JW, 0.58 SN95	EZSM	CX-NSZ300
X	FUNC/E.VR	FB 0602	88-100-000-010	OE	PLATING-JW, 0.58 SN95	USM	CX-SNAJ300
X	FUNC/E.VR	FB 0602	88-100-000-010	OE	PLATING-JW, 0.58 SN95	USM	CX-SNAJ305
O	S FUNC/E.VR	IC 0601	87-A21-401-040		C-IC,M61503FP	EZSM	CX-NSZ300
O	S FUNC/E.VR	IC 0601	87-A21-401-040	1C	C-IC,M61503FP	USM	CX-SNAJ300
O	S FUNC/E.VR	IC 0601	87-A21-401-040	1C	C-IC,M61503FP	USM	CX-SNAJ305
O	S FUNC/E.VR	IC 0601	87-A21-401-040		C-IC,M61503FP	LHSM	CX-NSZ300
O	S FUNC/E.VR	IC 0601	87-A21-401-040		C-IC,M61503FP	USM	CX-SNAJ300
O	S FUNC/E.VR	IC 0601	87-A21-401-040		C-IC,M61503FP	USM	CX-SNAJ305
O	FUNC/E.VR	J 0602	87-A60-881-010		JACK,PIN 2P MSP 242V05 PBSN	LHSM	CX-NSZ300
O	FUNC/E.VR	J 0602	87-A60-881-010		JACK,PIN 2P MSP 242V05 PBSN	USM	CX-SNAJ300
O	FUNC/E.VR	J 0602	87-A60-881-010		JACK,PIN 2P MSP 242V05 PBSN	USM	CX-SNAJ305
O	FUNC/E.VR	J 0602	87-A60-881-010		JACK,PIN 2P MSP 242V05 PBSN	EZSM	CX-NSZ300
O	FUNC/E.VR	J 0602	87-A60-881-010	OE	JACK,PIN 2P MSP 242V05 PBSN	USM	CX-SNAJ300
O	FUNC/E.VR	J 0602	87-A60-881-010	OE	JACK,PIN 2P MSP 242V05 PBSN	USM	CX-SNAJ305
X	FUNC/E.VR	JR 0601	88-108-000-080		C-JUMPER,U	LHSM	CX-NSZ300
X	FUNC/E.VR	JR 0601	88-108-000-080		C-JUMPER,U	USM	CX-SNAJ300
X	FUNC/E.VR	JR 0601	88-108-000-080		C-JUMPER,U	USM	CX-SNAJ305
X	FUNC/E.VR	JR 0601	88-108-000-080		C-JUMPER,U	EZSM	CX-NSZ300
X	FUNC/E.VR	JR 0601	88-108-000-080	OE	C-JUMPER,U	USM	CX-SNAJ300
X	FUNC/E.VR	JR 0601	88-108-000-080	OE	C-JUMPER,U	USM	CX-SNAJ305
X	FUNC/E.VR	JR 0602	88-108-000-080	OE	C-JUMPER,U	USM	CX-SNAJ300
X	FUNC/E.VR	JR 0602	88-108-000-080		C-JUMPER,U	LHSM	CX-NSZ300
X	FUNC/E.VR	JR 0602	88-108-000-080		C-JUMPER,U	USM	CX-SNAJ300
X	FUNC/E.VR	JR 0602	88-108-000-080		C-JUMPER,U	USM	CX-SNAJ305
X	FUNC/E.VR	JR 0602	88-108-000-080		C-JUMPER,U	EZSM	CX-NSZ300
X	FUNC/E.VR	JR 0602	88-108-000-080	OE	C-JUMPER,U	USM	CX-SNAJ300
X	FUNC/E.VR	JR 0602	88-108-000-080	OE	C-JUMPER,U	USM	CX-SNAJ305
X	FUNC/E.VR	JR 0605	88-108-000-080		C-JUMPER,U	LHSM	CX-NSZ300
X	FUNC/E.VR	JR 0605	88-108-000-080		C-JUMPER,U	USM	CX-SNAJ300
X	FUNC/E.VR	JR 0605	88-108-000-080		C-JUMPER,U	USM	CX-SNAJ305
X	FUNC/E.VR	JR 0605	88-108-000-080	OE	C-JUMPER,U	EZSM	CX-NSZ300
X	FUNC/E.VR	JR 0605	88-108-000-080	OE	C-JUMPER,U	USM	CX-SNAJ300
X	FUNC/E.VR	JR 0606	88-129-000-080		C-JUMPER,3216	EZSM	CX-NSZ300
X	FUNC/E.VR	JR 0606	88-129-000-080	OE	C-JUMPER,3216	USM	CX-SNAJ300
X	FUNC/E.VR	JR 0606	88-129-000-080	OE	C-JUMPER,3216	USM	CX-SNAJ305
X	FUNC/E.VR	JR 0606	88-129-000-080	OE	C-JUMPER,3216	EZSM	CX-NSZ300
X	FUNC/E.VR	JR 0607	88-108-000-080		C-JUMPER,U	USM	CX-SNAJ300
X	FUNC/E.VR	JR 0607	88-108-000-080	OE	C-JUMPER,U	USM	CX-SNAJ305
X	FUNC/E.VR	JR 0607	88-108-000-080	OE	C-JUMPER,U	USM	CX-SNAJ300
X	FUNC/E.VR	JR 0612	88-129-000-080		C-JUMPER,3216	LHSM	CX-NSZ300
X	FUNC/E.VR	JR 0612	88-129-000-080		C-JUMPER,3216	USM	CX-SNAJ300
X	FUNC/E.VR	JR 0612	88-129-000-080		C-JUMPER,3216	USM	CX-SNAJ305
X	FUNC/E.VR	JR 0612	88-129-000-080	OE	C-JUMPER,3216	USM	CX-SNAJ300
X	FUNC/E.VR	JR 0612	88-129-000-080	OE	C-JUMPER,3216	USM	CX-SNAJ305
X	FUNC/E.VR	JR 0613	88-129-000-080		C-JUMPER,3216	LHSM	CX-NSZ300
X	FUNC/E.VR	JR 0613	88-129-000-080		C-JUMPER,3216	USM	CX-SNAJ300
X	FUNC/E.VR	JR 0613	88-129-000-080		C-JUMPER,3216	USM	CX-SNAJ305
X	FUNC/E.VR	JR 0613	88-129-000-080	OE	C-JUMPER,3216	USM	CX-SNAJ300
X	FUNC/E.VR	JR 0613	88-129-000-080	OE	C-JUMPER,3216	USM	CX-SNAJ305
X	FUNC/E.VR	JR 0614	88-129-000-080		C-JUMPER,3216	LHSM	CX-NSZ300

PARTS LIST

! = Δ SAFTY PARTS
 C = Components marked

All components used on this model at the production line are shown in this service manual.

However, please note that not all components will be available as spare parts for after-sales service.

Components marked S and O are designated as spare parts for service and will be stocked at the spare parts centers.

Components marked X and R are not designated as spare parts for after sales service, and will not be stocked at the spare parts centers.

K NO. = Only use japanese.

! C	UNIT NAME	REF NO.	PARTS CODE	K NO.	DESCRIPTION	SUFFIX	MODEL NAME
X	FUNC/E.VR	JR 0614	88-129-000-080		C-JUMPER, 3216	USM	CX-SNAJ300
X	FUNC/E.VR	JR 0614	88-129-000-080		C-JUMPER, 3216	USM	CX-SNAJ305
X	FUNC/E.VR	JR 0614	88-129-000-080	OE	C-JUMPER, 3216	USM	CX-SNAJ300
X	FUNC/E.VR	JR 0614	88-129-000-080	OE	C-JUMPER, 3216	USM	CX-SNAJ305
X	FUNC/E.VR	JR 0615	88-129-000-080		C-JUMPER, 3216	LHSM	CX-NSZ300
X	FUNC/E.VR	JR 0615	88-129-000-080		C-JUMPER, 3216	USM	CX-SNAJ300
X	FUNC/E.VR	JR 0615	88-129-000-080		C-JUMPER, 3216	USM	CX-SNAJ305
X	FUNC/E.VR	JR 0615	88-129-000-080	OE	C-JUMPER, 3216	USM	CX-SNAJ300
X	FUNC/E.VR	JR 0615	88-129-000-080	OE	C-JUMPER, 3216	USM	CX-SNAJ305
X	FUNC/E.VR	JR 0616	88-108-000-080		C-JUMPER, U	EZSM	CX-NSZ300
X	FUNC/E.VR	JR 0616	88-108-000-080	OE	C-JUMPER, U	USM	CX-SNAJ300
X	FUNC/E.VR	JR 0616	88-108-000-080	OE	C-JUMPER, U	USM	CX-SNAJ305
S	FUNC/E.VR	Q 0601	87-A30-087-080		C-FET, 2SK2158	LHSM	CX-NSZ300
S	FUNC/E.VR	Q 0601	87-A30-087-080		C-FET, 2SK2158	USM	CX-SNAJ300
S	FUNC/E.VR	Q 0601	87-A30-087-080		C-FET, 2SK2158	USM	CX-SNAJ305
S	FUNC/E.VR	Q 0601	87-A30-087-080		C-FET, 2SK2158	EZSM	CX-NSZ300
S	FUNC/E.VR	Q 0601	87-A30-087-080	OE	C-FET, 2SK2158	USM	CX-SNAJ300
S	FUNC/E.VR	Q 0601	87-A30-087-080	OE	C-FET, 2SK2158	USM	CX-SNAJ305
S	FUNC/E.VR	Q 0602	87-A30-087-080		C-FET, 2SK2158	LHSM	CX-NSZ300
S	FUNC/E.VR	Q 0602	87-A30-087-080		C-FET, 2SK2158	USM	CX-SNAJ300
S	FUNC/E.VR	Q 0602	87-A30-087-080		C-FET, 2SK2158	USM	CX-SNAJ305
S	FUNC/E.VR	Q 0602	87-A30-087-080		C-FET, 2SK2158	EZSM	CX-NSZ300
S	FUNC/E.VR	Q 0602	87-A30-087-080	OE	C-FET, 2SK2158	USM	CX-SNAJ300
S	FUNC/E.VR	Q 0602	87-A30-087-080	OE	C-FET, 2SK2158	USM	CX-SNAJ305
S	FUNC/E.VR	Q 0605	87-A30-090-080		FET, 2SK2541	LHSM	CX-NSZ300
S	FUNC/E.VR	Q 0605	87-A30-090-080		FET, 2SK2541	USM	CX-SNAJ300
S	FUNC/E.VR	Q 0605	87-A30-090-080		FET, 2SK2541	USM	CX-SNAJ305
S	FUNC/E.VR	Q 0605	87-A30-090-080		FET, 2SK2541	EZSM	CX-NSZ300
S	FUNC/E.VR	Q 0605	87-A30-090-080	OE	FET, 2SK2541	USM	CX-SNAJ300
S	FUNC/E.VR	Q 0605	87-A30-090-080	OE	FET, 2SK2541	USM	CX-SNAJ305
S	FUNC/E.VR	Q 0606	87-A30-090-080		FET, 2SK2541	LHSM	CX-NSZ300
S	FUNC/E.VR	Q 0606	87-A30-090-080		FET, 2SK2541	USM	CX-SNAJ300
S	FUNC/E.VR	Q 0606	87-A30-090-080		FET, 2SK2541	USM	CX-SNAJ305
S	FUNC/E.VR	Q 0606	87-A30-090-080		FET, 2SK2541	EZSM	CX-NSZ300
S	FUNC/E.VR	Q 0606	87-A30-090-080	OE	FET, 2SK2541	USM	CX-SNAJ300
S	FUNC/E.VR	Q 0606	87-A30-090-080	OE	FET, 2SK2541	USM	CX-SNAJ305
S	FUNC/E.VR	Q 0607	87-A30-076-080		C-TR, 2SC3052F	LHSM	CX-NSZ300
S	FUNC/E.VR	Q 0607	87-A30-076-080		C-TR, 2SC3052F	USM	CX-SNAJ300
S	FUNC/E.VR	Q 0607	87-A30-076-080		C-TR, 2SC3052F	USM	CX-SNAJ305
S	FUNC/E.VR	Q 0607	87-A30-076-080		C-TR, 2SC3052F	EZSM	CX-NSZ300
S	FUNC/E.VR	Q 0607	87-A30-076-080	OE	C-TR, 2SC3052F	USM	CX-SNAJ300
S	FUNC/E.VR	Q 0607	87-A30-076-080	OE	C-TR, 2SC3052F	USM	CX-SNAJ305
X	FUNC/E.VR	R 0077	88-108-102-080		C-RES, U 1K-1/16W J	LHSM	CX-NSZ300
X	FUNC/E.VR	R 0077	88-108-102-080		C-RES, U 1K-1/16W J	USM	CX-SNAJ300
X	FUNC/E.VR	R 0077	88-108-102-080		C-RES, U 1K-1/16W J	USM	CX-SNAJ305
X	FUNC/E.VR	R 0077	88-108-102-080		C-RES, U 1K-1/16W J	EZSM	CX-NSZ300
X	FUNC/E.VR	R 0077	88-108-102-080	OE	C-RES, U 1K-1/16W J	USM	CX-SNAJ300
X	FUNC/E.VR	R 0077	88-108-102-080	OE	C-RES, U 1K-1/16W J	USM	CX-SNAJ305
X	FUNC/E.VR	R 0601	88-108-102-080		C-RES, U 1K-1/16W J	LHSM	CX-NSZ300
X	FUNC/E.VR	R 0601	88-108-102-080		C-RES, U 1K-1/16W J	USM	CX-SNAJ300
X	FUNC/E.VR	R 0601	88-108-102-080	OE	C-RES, U 1K-1/16W J	EZSM	CX-NSZ300
X	FUNC/E.VR	R 0601	88-108-102-080	OE	C-RES, U 1K-1/16W J	USM	CX-SNAJ305
X	FUNC/E.VR	R 0602	88-108-102-080		C-RES, U 1K-1/16W J	LHSM	CX-NSZ300
X	FUNC/E.VR	R 0602	88-108-102-080		C-RES, U 1K-1/16W J	USM	CX-SNAJ300
X	FUNC/E.VR	R 0602	88-108-102-080		C-RES, U 1K-1/16W J	USM	CX-SNAJ305
X	FUNC/E.VR	R 0602	88-108-102-080		C-RES, U 1K-1/16W J	EZSM	CX-NSZ300
X	FUNC/E.VR	R 0602	88-108-102-080	OE	C-RES, U 1K-1/16W J	USM	CX-SNAJ300
X	FUNC/E.VR	R 0602	88-108-102-080	OE	C-RES, U 1K-1/16W J	USM	CX-SNAJ305
X	FUNC/E.VR	R 0603	88-108-682-080		C-RES, U 6.8K-1/16W J	LHSM	CX-NSZ300
X	FUNC/E.VR	R 0603	88-108-682-080		C-RES, U 6.8K-1/16W J	USM	CX-SNAJ300
X	FUNC/E.VR	R 0603	88-108-682-080		C-RES, U 6.8K-1/16W J	USM	CX-SNAJ305
X	FUNC/E.VR	R 0603	88-108-682-080		C-RES, U 6.8K-1/16W J	EZSM	CX-NSZ300
X	FUNC/E.VR	R 0603	88-108-682-080	OE	C-RES, U 6.8K-1/16W J	USM	CX-SNAJ300
X	FUNC/E.VR	R 0603	88-108-682-080	OE	C-RES, U 6.8K-1/16W J	USM	CX-SNAJ305
X	FUNC/E.VR	R 0604	88-108-682-080		C-RES, U 6.8K-1/16W J	LHSM	CX-NSZ300
X	FUNC/E.VR	R 0604	88-108-682-080		C-RES, U 6.8K-1/16W J	USM	CX-SNAJ300
X	FUNC/E.VR	R 0604	88-108-682-080		C-RES, U 6.8K-1/16W J	USM	CX-SNAJ305
X	FUNC/E.VR	R 0604	88-108-682-080		C-RES, U 6.8K-1/16W J	EZSM	CX-NSZ300

PARTS LIST

! = Δ SAFTY PARTS
 C = Components marked

All components used on this model at the production line are shown in this service manual.

However, please note that not all components will be available as spare parts for after-sales service.

Components marked S and O are designated as spare parts for service and will be stocked at the spare parts centers.

Components marked X and R are not designated as spare parts for after sales service, and will not be stocked at the spare parts centers.

K NO. = Only use japanese.

! C	UNIT NAME	REF NO.	PARTS CODE	K NO.	DESCRIPTION	SUFFIX	MODEL NAME	
X	FUNC/E.VR	R	0604	88-108-682-080	OE	C-RES,U 6.8K-1/16W J	USM	CX-SNAJ300
X	FUNC/E.VR	R	0604	88-108-682-080	OE	C-RES,U 6.8K-1/16W J	USM	CX-SNAJ305
X	FUNC/E.VR	R	0605	88-108-103-080		C-RES,U 10K-1/16W J	LHSM	CX-NSZ300
X	FUNC/E.VR	R	0605	88-108-103-080		C-RES,U 10K-1/16W J	USM	CX-SNAJ300
X	FUNC/E.VR	R	0605	88-108-103-080		C-RES,U 10K-1/16W J	USM	CX-SNAJ305
X	FUNC/E.VR	R	0605	88-108-103-080		C-RES,U 10K-1/16W J	EZSM	CX-NSZ300
X	FUNC/E.VR	R	0605	88-108-103-080	OE	C-RES,U 10K-1/16W J	USM	CX-SNAJ300
X	FUNC/E.VR	R	0605	88-108-103-080	OE	C-RES,U 10K-1/16W J	USM	CX-SNAJ305
X	FUNC/E.VR	R	0606	88-108-103-080		C-RES,U 10K-1/16W J	LHSM	CX-NSZ300
X	FUNC/E.VR	R	0606	88-108-103-080		C-RES,U 10K-1/16W J	USM	CX-SNAJ300
X	FUNC/E.VR	R	0606	88-108-103-080		C-RES,U 10K-1/16W J	USM	CX-SNAJ305
X	FUNC/E.VR	R	0606	88-108-103-080		C-RES,U 10K-1/16W J	EZSM	CX-NSZ300
X	FUNC/E.VR	R	0606	88-108-103-080	OE	C-RES,U 10K-1/16W J	USM	CX-SNAJ300
X	FUNC/E.VR	R	0606	88-108-103-080	OE	C-RES,U 10K-1/16W J	USM	CX-SNAJ305
X	FUNC/E.VR	R	0607	88-108-103-080		C-RES,U 10K-1/16W J	LHSM	CX-NSZ300
X	FUNC/E.VR	R	0607	88-108-103-080		C-RES,U 10K-1/16W J	USM	CX-SNAJ300
X	FUNC/E.VR	R	0607	88-108-103-080		C-RES,U 10K-1/16W J	USM	CX-SNAJ305
X	FUNC/E.VR	R	0607	88-108-103-080		C-RES,U 10K-1/16W J	EZSM	CX-NSZ300
X	FUNC/E.VR	R	0607	88-108-103-080	OE	C-RES,U 10K-1/16W J	USM	CX-SNAJ300
X	FUNC/E.VR	R	0607	88-108-103-080	OE	C-RES,U 10K-1/16W J	USM	CX-SNAJ305
X	FUNC/E.VR	R	0608	88-108-103-080		C-RES,U 10K-1/16W J	LHSM	CX-NSZ300
X	FUNC/E.VR	R	0608	88-108-103-080		C-RES,U 10K-1/16W J	USM	CX-SNAJ300
X	FUNC/E.VR	R	0608	88-108-103-080		C-RES,U 10K-1/16W J	USM	CX-SNAJ305
X	FUNC/E.VR	R	0608	88-108-103-080		C-RES,U 10K-1/16W J	EZSM	CX-NSZ300
X	FUNC/E.VR	R	0608	88-108-103-080	OE	C-RES,U 10K-1/16W J	USM	CX-SNAJ300
X	FUNC/E.VR	R	0608	88-108-103-080	OE	C-RES,U 10K-1/16W J	USM	CX-SNAJ305
X	FUNC/E.VR	R	0609	88-108-562-080		C-RES,U 5.6K-1/16W J	LHSM	CX-NSZ300
X	FUNC/E.VR	R	0609	88-108-562-080		C-RES,U 5.6K-1/16W J	USM	CX-SNAJ300
X	FUNC/E.VR	R	0609	88-108-562-080		C-RES,U 5.6K-1/16W J	USM	CX-SNAJ305
X	FUNC/E.VR	R	0609	88-108-562-080		C-RES,U 5.6K-1/16W J	EZSM	CX-NSZ300
X	FUNC/E.VR	R	0609	88-108-562-080	OE	C-RES,U 5.6K-1/16W J	USM	CX-SNAJ300
X	FUNC/E.VR	R	0609	88-108-562-080	OE	C-RES,U 5.6K-1/16W J	USM	CX-SNAJ305
X	FUNC/E.VR	R	0610	88-121-562-080		RES,5.6K-1/8W J	LHSM	CX-NSZ300
X	FUNC/E.VR	R	0610	88-121-562-080		RES,5.6K-1/8W J	USM	CX-SNAJ300
X	FUNC/E.VR	R	0610	88-121-562-080		RES,5.6K-1/8W J	USM	CX-SNAJ305
X	FUNC/E.VR	R	0610	88-121-562-080		RES,5.6K-1/8W J	EZSM	CX-NSZ300
X	FUNC/E.VR	R	0610	88-121-562-080	OE	RES,5.6K-1/8W J	USM	CX-SNAJ300
X	FUNC/E.VR	R	0610	88-121-562-080	OE	RES,5.6K-1/8W J	USM	CX-SNAJ305
X	FUNC/E.VR	R	0611	88-108-183-080		C-RES,U 18K-1/16W J	LHSM	CX-NSZ300
X	FUNC/E.VR	R	0611	88-108-183-080		C-RES,U 18K-1/16W J	USM	CX-SNAJ300
X	FUNC/E.VR	R	0611	88-108-183-080		C-RES,U 18K-1/16W J	USM	CX-SNAJ305
X	FUNC/E.VR	R	0611	88-108-183-080		C-RES,U 18K-1/16W J	EZSM	CX-NSZ300
X	FUNC/E.VR	R	0611	88-108-183-080	OE	C-RES,U 18K-1/16W J	USM	CX-SNAJ300
X	FUNC/E.VR	R	0611	88-108-183-080	OE	C-RES,U 18K-1/16W J	USM	CX-SNAJ305
X	FUNC/E.VR	R	0612	88-108-183-080		C-RES,U 18K-1/16W J	LHSM	CX-NSZ300
X	FUNC/E.VR	R	0612	88-108-183-080		C-RES,U 18K-1/16W J	USM	CX-SNAJ300
X	FUNC/E.VR	R	0612	88-108-183-080		C-RES,U 18K-1/16W J	USM	CX-SNAJ305
X	FUNC/E.VR	R	0612	88-108-183-080		C-RES,U 18K-1/16W J	EZSM	CX-NSZ300
X	FUNC/E.VR	R	0612	88-108-183-080	OE	C-RES,U 18K-1/16W J	USM	CX-SNAJ300
X	FUNC/E.VR	R	0612	88-108-183-080	OE	C-RES,U 18K-1/16W J	USM	CX-SNAJ305
X	FUNC/E.VR	R	0613	88-121-472-080		RES,4.7K-1/8W J	LHSM	CX-NSZ300
X	FUNC/E.VR	R	0613	88-121-472-080		RES,4.7K-1/8W J	USM	CX-SNAJ300
X	FUNC/E.VR	R	0613	88-121-472-080		RES,4.7K-1/8W J	USM	CX-SNAJ305
X	FUNC/E.VR	R	0613	88-121-472-080	OE	RES,4.7K-1/8W J	USM	CX-SNAJ300
X	FUNC/E.VR	R	0613	88-121-472-080	OE	RES,4.7K-1/8W J	USM	CX-SNAJ305
X	FUNC/E.VR	R	0613	88-121-681-080		RES,680-1/8W J	EZSM	CX-NSZ300
X	FUNC/E.VR	R	0614	88-121-472-080		RES,4.7K-1/8W J	LHSM	CX-NSZ300
X	FUNC/E.VR	R	0614	88-121-472-080		RES,4.7K-1/8W J	USM	CX-SNAJ300
X	FUNC/E.VR	R	0614	88-121-472-080		RES,4.7K-1/8W J	USM	CX-SNAJ305
X	FUNC/E.VR	R	0614	88-121-472-080	OE	RES,4.7K-1/8W J	USM	CX-SNAJ300
X	FUNC/E.VR	R	0614	88-121-472-080	OE	RES,4.7K-1/8W J	USM	CX-SNAJ305
X	FUNC/E.VR	R	0614	88-121-681-080	OE	RES,4.7K-1/8W J	USM	CX-SNAJ305
X	FUNC/E.VR	R	0614	88-121-681-080		RES,680-1/8W J	EZSM	CX-NSZ300
X	FUNC/E.VR	R	0615	88-108-183-080		C-RES,U 18K-1/16W J	LHSM	CX-NSZ300
X	FUNC/E.VR	R	0615	88-108-183-080		C-RES,U 18K-1/16W J	USM	CX-SNAJ300
X	FUNC/E.VR	R	0615	88-108-183-080		C-RES,U 18K-1/16W J	USM	CX-SNAJ305
X	FUNC/E.VR	R	0615	88-108-183-080		C-RES,U 18K-1/16W J	EZSM	CX-NSZ300
X	FUNC/E.VR	R	0615	88-108-183-080	OE	C-RES,U 18K-1/16W J	USM	CX-SNAJ300
X	FUNC/E.VR	R	0615	88-108-183-080	OE	C-RES,U 18K-1/16W J	USM	CX-SNAJ305
X	FUNC/E.VR	R	0616	88-108-183-080		C-RES,U 18K-1/16W J	LHSM	CX-NSZ300
X	FUNC/E.VR	R	0616	88-108-183-080		C-RES,U 18K-1/16W J	USM	CX-SNAJ300

PARTS LIST

! = Δ SAFTY PARTS
 C = Components marked

All components used on this model at the production line are shown in this service manual.

However, please note that not all components will be available as spare parts for after-sales service.

Components marked S and O are designated as spare parts for service and will be stocked at the spare parts centers.

Components marked X and R are not designated as spare parts for after sales service, and will not be stocked at the spare parts centers.

K NO. = Only use japanese.

! C	UNIT NAME	REF NO.	PARTS CODE	K NO.	DESCRIPTION	SUFFIX	MODEL NAME
X	FUNC/E.VR	R	0616 88-108-183-080		C-RES,U 18K-1/16W J	USM	CX-SNAJ305
X	FUNC/E.VR	R	0616 88-108-183-080		C-RES,U 18K-1/16W J	EZSM	CX-NSZ300
X	FUNC/E.VR	R	0616 88-108-183-080	OE	C-RES,U 18K-1/16W J	USM	CX-SNAJ300
X	FUNC/E.VR	R	0616 88-108-183-080	OE	C-RES,U 18K-1/16W J	USM	CX-SNAJ305
X	FUNC/E.VR	R	0618 88-108-332-080		C-RES,U 3.3K-1/16W J	LHSM	CX-NSZ300
X	FUNC/E.VR	R	0618 88-108-332-080		C-RES,U 3.3K-1/16W J	USM	CX-SNAJ300
X	FUNC/E.VR	R	0618 88-108-332-080		C-RES,U 3.3K-1/16W J	USM	CX-SNAJ305
X	FUNC/E.VR	R	0618 88-108-332-080		C-RES,U 3.3K-1/16W J	EZSM	CX-NSZ300
X	FUNC/E.VR	R	0618 88-108-332-080	OE	C-RES,U 3.3K-1/16W J	USM	CX-SNAJ300
X	FUNC/E.VR	R	0618 88-108-332-080	OE	C-RES,U 3.3K-1/16W J	USM	CX-SNAJ305
X	FUNC/E.VR	R	0619 88-108-273-080		C-RES,U 27K-1/16W J	LHSM	CX-NSZ300
X	FUNC/E.VR	R	0619 88-108-273-080		C-RES,U 27K-1/16W J	USM	CX-SNAJ300
X	FUNC/E.VR	R	0619 88-108-273-080		C-RES,U 27K-1/16W J	USM	CX-SNAJ305
X	FUNC/E.VR	R	0619 88-108-273-080		C-RES,U 27K-1/16W J	EZSM	CX-NSZ300
X	FUNC/E.VR	R	0619 88-108-273-080	OE	C-RES,U 27K-1/16W J	USM	CX-SNAJ300
X	FUNC/E.VR	R	0619 88-108-273-080	OE	C-RES,U 27K-1/16W J	USM	CX-SNAJ305
X	FUNC/E.VR	R	0620 88-108-273-080		C-RES,U 27K-1/16W J	LHSM	CX-NSZ300
X	FUNC/E.VR	R	0620 88-108-273-080		C-RES,U 27K-1/16W J	USM	CX-SNAJ300
X	FUNC/E.VR	R	0620 88-108-273-080		C-RES,U 27K-1/16W J	USM	CX-SNAJ305
X	FUNC/E.VR	R	0620 88-108-273-080		C-RES,U 27K-1/16W J	EZSM	CX-NSZ300
X	FUNC/E.VR	R	0620 88-108-273-080	OE	C-RES,U 27K-1/16W J	USM	CX-SNAJ300
X	FUNC/E.VR	R	0620 88-108-273-080	OE	C-RES,U 27K-1/16W J	USM	CX-SNAJ305
X	FUNC/E.VR	R	0621 88-108-824-080		C-RES,U 820K-1/16W J	LHSM	CX-NSZ300
X	FUNC/E.VR	R	0621 88-108-824-080		C-RES,U 820K-1/16W J	USM	CX-SNAJ300
X	FUNC/E.VR	R	0621 88-108-824-080		C-RES,U 820K-1/16W J	USM	CX-SNAJ305
X	FUNC/E.VR	R	0621 88-108-824-080		C-RES,U 820K-1/16W J	EZSM	CX-NSZ300
X	FUNC/E.VR	R	0621 88-108-824-080	OE	C-RES,U 820K-1/16W J	USM	CX-SNAJ300
X	FUNC/E.VR	R	0621 88-108-824-080	OE	C-RES,U 820K-1/16W J	USM	CX-SNAJ305
X	FUNC/E.VR	R	0622 88-108-824-080		C-RES,U 820K-1/16W J	LHSM	CX-NSZ300
X	FUNC/E.VR	R	0622 88-108-824-080		C-RES,U 820K-1/16W J	USM	CX-SNAJ300
X	FUNC/E.VR	R	0622 88-108-824-080		C-RES,U 820K-1/16W J	USM	CX-SNAJ305
X	FUNC/E.VR	R	0622 88-108-824-080	OE	C-RES,U 820K-1/16W J	USM	CX-NSZ300
X	FUNC/E.VR	R	0622 88-108-824-080	OE	C-RES,U 820K-1/16W J	USM	CX-SNAJ300
X	FUNC/E.VR	R	0625 88-108-472-080		C-RES,U 4.7K-1/16W J	LHSM	CX-NSZ300
X	FUNC/E.VR	R	0625 88-108-472-080		C-RES,U 4.7K-1/16W J	USM	CX-SNAJ300
X	FUNC/E.VR	R	0625 88-108-472-080		C-RES,U 4.7K-1/16W J	USM	CX-SNAJ305
X	FUNC/E.VR	R	0625 88-121-472-080		RES,4.7K-1/8W J	EZSM	CX-NSZ300
X	FUNC/E.VR	R	0625 88-121-472-080	OE	RES,4.7K-1/8W J	USM	CX-SNAJ300
X	FUNC/E.VR	R	0625 88-121-472-080	OE	RES,4.7K-1/8W J	USM	CX-SNAJ305
X	FUNC/E.VR	R	0626 88-108-103-080		C-RES,U 10K-1/16W J	LHSM	CX-NSZ300
X	FUNC/E.VR	R	0626 88-108-103-080		C-RES,U 10K-1/16W J	USM	CX-SNAJ300
X	FUNC/E.VR	R	0626 88-108-103-080		C-RES,U 10K-1/16W J	USM	CX-SNAJ305
X	FUNC/E.VR	R	0626 88-121-103-080		RES,10K-1/8W J	EZSM	CX-NSZ300
X	FUNC/E.VR	R	0626 88-121-103-080	OE	RES,10K-1/8W J	USM	CX-SNAJ300
X	FUNC/E.VR	R	0626 88-121-103-080	OE	RES,10K-1/8W J	USM	CX-SNAJ305
X	FUNC/E.VR	R	0627 88-108-123-080		C-RES,U 12K-1/16W J	LHSM	CX-NSZ300
X	FUNC/E.VR	R	0627 88-108-123-080		C-RES,U 12K-1/16W J	USM	CX-SNAJ300
X	FUNC/E.VR	R	0627 88-108-123-080		C-RES,U 12K-1/16W J	USM	CX-SNAJ305
X	FUNC/E.VR	R	0627 88-108-123-080		C-RES,U 12K-1/16W J	EZSM	CX-NSZ300
X	FUNC/E.VR	R	0627 88-108-123-080	OE	C-RES,U 12K-1/16W J	USM	CX-SNAJ300
X	FUNC/E.VR	R	0627 88-108-123-080	OE	C-RES,U 12K-1/16W J	USM	CX-SNAJ305
X	FUNC/E.VR	R	0628 88-108-332-080		C-RES,U 3.3K-1/16W J	LHSM	CX-NSZ300
X	FUNC/E.VR	R	0628 88-108-332-080		C-RES,U 3.3K-1/16W J	USM	CX-SNAJ300
X	FUNC/E.VR	R	0628 88-108-332-080		C-RES,U 3.3K-1/16W J	USM	CX-SNAJ305
X	FUNC/E.VR	R	0628 88-121-332-080		RES,3.3K-1/8W J	EZSM	CX-NSZ300
X	FUNC/E.VR	R	0628 88-121-332-080	OE	RES,3.3K-1/8W J	USM	CX-SNAJ300
X	FUNC/E.VR	R	0628 88-121-332-080	OE	RES,3.3K-1/8W J	USM	CX-SNAJ305
X	FUNC/E.VR	R	0631 88-108-104-080		C-RES,U 100K-1/16W J	LHSM	CX-NSZ300
X	FUNC/E.VR	R	0631 88-108-104-080		C-RES,U 100K-1/16W J	USM	CX-SNAJ300
X	FUNC/E.VR	R	0631 88-108-104-080		C-RES,U 100K-1/16W J	USM	CX-SNAJ305
X	FUNC/E.VR	R	0631 88-108-104-080	OE	C-RES,U 100K-1/16W J	USM	CX-SNAJ300
X	FUNC/E.VR	R	0631 88-108-104-080	OE	C-RES,U 100K-1/16W J	USM	CX-SNAJ305
X	FUNC/E.VR	R	0632 88-108-123-080		C-RES,U 12K-1/16W J	EZSM	CX-NSZ300
X	FUNC/E.VR	R	0632 88-108-822-080		C-RES,U 8.2K-1/16W J	LHSM	CX-NSZ300
X	FUNC/E.VR	R	0632 88-108-822-080		C-RES,U 8.2K-1/16W J	USM	CX-SNAJ300
X	FUNC/E.VR	R	0632 88-108-822-080		C-RES,U 8.2K-1/16W J	USM	CX-SNAJ305
X	FUNC/E.VR	R	0632 88-108-822-080	OE	C-RES,U 8.2K-1/16W J	USM	CX-SNAJ300
X	FUNC/E.VR	R	0632 88-108-822-080	OE	C-RES,U 8.2K-1/16W J	USM	CX-SNAJ305

PARTS LIST

! = Δ SAFTY PARTS
 C = Components marked

All components used on this model at the production line are shown in this service manual.

However, please note that not all components will be available as spare parts for after-sales service.

Components marked S and O are designated as spare parts for service and will be stocked at the spare parts centers.

Components marked X and R are not designated as spare parts for after sales service, and will not be stocked at the spare parts centers.

K NO. = Only use japanese.

! C	UNIT NAME	REF NO.	PARTS CODE	K NO.	DESCRIPTION	SUFFIX	MODEL NAME
X	FUNC/E.VR	R	0633 88-108-184-080		C-RES,U 180K-1/16W J	EZSM	CX-NSZ300
X	FUNC/E.VR	R	0633 88-108-224-080		C-RES,U 220K-1/16W J	LHSM	CX-NSZ300
X	FUNC/E.VR	R	0634 88-108-103-080		C-RES,U 10K-1/16W J	EZSM	CX-NSZ300
X	FUNC/E.VR	R	0634 88-108-103-080	OE	C-RES,U 10K-1/16W J	USM	CX-SNAJ300
X	FUNC/E.VR	R	0634 88-108-103-080	OE	C-RES,U 10K-1/16W J	USM	CX-SNAJ305
X	FUNC/E.VR	R	0634 88-108-223-080		C-RES,U 22K-1/16W J	LHSM	CX-NSZ300
X	FUNC/E.VR	R	0634 88-108-223-080		C-RES,U 22K-1/16W J	USM	CX-SNAJ300
X	FUNC/E.VR	R	0634 88-108-223-080		C-RES,U 22K-1/16W J	USM	CX-SNAJ305
X	FUNC/E.VR	R	0635 88-108-103-080		C-RES,U 10K-1/16W J	EZSM	CX-NSZ300
X	FUNC/E.VR	R	0635 88-108-103-080	OE	C-RES,U 10K-1/16W J	USM	CX-SNAJ300
X	FUNC/E.VR	R	0635 88-108-103-080	OE	C-RES,U 10K-1/16W J	USM	CX-SNAJ305
X	FUNC/E.VR	R	0635 88-108-223-080		C-RES,U 22K-1/16W J	LHSM	CX-NSZ300
X	FUNC/E.VR	R	0635 88-108-223-080		C-RES,U 22K-1/16W J	USM	CX-SNAJ300
X	FUNC/E.VR	R	0635 88-108-223-080		C-RES,U 22K-1/16W J	USM	CX-SNAJ305
X	FUNC/E.VR	R	0637 88-108-222-080		C-RES,U 2.2K-1/16W J	LHSM	CX-NSZ300
X	FUNC/E.VR	R	0637 88-108-222-080		C-RES,U 2.2K-1/16W J	USM	CX-SNAJ300
X	FUNC/E.VR	R	0637 88-108-222-080		C-RES,U 2.2K-1/16W J	USM	CX-SNAJ305
X	FUNC/E.VR	R	0637 88-108-222-080		C-RES,U 2.2K-1/16W J	EZSM	CX-NSZ300
X	FUNC/E.VR	R	0637 88-108-222-080	OE	C-RES,U 2.2K-1/16W J	USM	CX-SNAJ300
X	FUNC/E.VR	R	0637 88-108-222-080	OE	C-RES,U 2.2K-1/16W J	USM	CX-SNAJ305
X	FUNC/E.VR	R	0638 88-108-222-080		C-RES,U 2.2K-1/16W J	LHSM	CX-NSZ300
X	FUNC/E.VR	R	0638 88-108-222-080		C-RES,U 2.2K-1/16W J	USM	CX-SNAJ300
X	FUNC/E.VR	R	0638 88-108-222-080		C-RES,U 2.2K-1/16W J	USM	CX-SNAJ305
X	FUNC/E.VR	R	0638 88-108-222-080		C-RES,U 2.2K-1/16W J	EZSM	CX-NSZ300
X	FUNC/E.VR	R	0638 88-108-222-080	OE	C-RES,U 2.2K-1/16W J	USM	CX-SNAJ300
X	FUNC/E.VR	R	0638 88-108-222-080	OE	C-RES,U 2.2K-1/16W J	USM	CX-SNAJ305
X	FUNC/E.VR	R	0639 88-108-273-080		C-RES,U 27K-1/16W J	LHSM	CX-NSZ300
X	FUNC/E.VR	R	0639 88-108-273-080		C-RES,U 27K-1/16W J	USM	CX-SNAJ300
X	FUNC/E.VR	R	0639 88-108-273-080		C-RES,U 27K-1/16W J	USM	CX-SNAJ305
X	FUNC/E.VR	R	0639 88-108-273-080		C-RES,U 27K-1/16W J	EZSM	CX-NSZ300
X	FUNC/E.VR	R	0639 88-108-273-080	OE	C-RES,U 27K-1/16W J	USM	CX-SNAJ300
X	FUNC/E.VR	R	0639 88-108-273-080	OE	C-RES,U 27K-1/16W J	USM	CX-SNAJ305
X	FUNC/E.VR	R	0640 88-108-273-080		C-RES,U 27K-1/16W J	LHSM	CX-NSZ300
X	FUNC/E.VR	R	0640 88-108-273-080		C-RES,U 27K-1/16W J	USM	CX-SNAJ300
X	FUNC/E.VR	R	0640 88-108-273-080		C-RES,U 27K-1/16W J	USM	CX-SNAJ305
X	FUNC/E.VR	R	0640 88-108-273-080		C-RES,U 27K-1/16W J	EZSM	CX-NSZ300
X	FUNC/E.VR	R	0640 88-108-273-080	OE	C-RES,U 27K-1/16W J	USM	CX-SNAJ300
X	FUNC/E.VR	R	0640 88-108-273-080	OE	C-RES,U 27K-1/16W J	USM	CX-SNAJ305
X	FUNC/E.VR	R	0653 88-108-000-080		C-JUMPER,U	LHSM	CX-NSZ300
X	FUNC/E.VR	R	0653 88-108-000-080		C-JUMPER,U	USM	CX-SNAJ300
X	FUNC/E.VR	R	0653 88-108-000-080		C-JUMPER,U	USM	CX-SNAJ305
X	FUNC/E.VR	R	0653 88-108-000-080	OE	C-JUMPER,U	USM	CX-SNAJ300
X	FUNC/E.VR	R	0653 88-108-000-080	OE	C-JUMPER,U	USM	CX-SNAJ305
X	FUNC/E.VR	R	0654 88-108-000-080		C-JUMPER,U	LHSM	CX-NSZ300
X	FUNC/E.VR	R	0654 88-108-000-080		C-JUMPER,U	USM	CX-SNAJ300
X	FUNC/E.VR	R	0654 88-108-000-080		C-JUMPER,U	USM	CX-SNAJ305
X	FUNC/E.VR	R	0654 88-108-000-080		C-JUMPER,U	EZSM	CX-NSZ300
X	FUNC/E.VR	R	0654 88-108-000-080	OE	C-JUMPER,U	USM	CX-SNAJ300
X	FUNC/E.VR	R	0654 88-108-000-080	OE	C-JUMPER,U	USM	CX-SNAJ305
X	FUNC/E.VR	R	0661 88-108-153-080		C-RES,U 15K-1/16W J	LHSM	CX-NSZ300
X	FUNC/E.VR	R	0661 88-108-153-080		C-RES,U 15K-1/16W J	USM	CX-SNAJ300
X	FUNC/E.VR	R	0661 88-108-153-080		C-RES,U 15K-1/16W J	USM	CX-SNAJ305
X	FUNC/E.VR	R	0661 88-108-153-080		C-RES,U 15K-1/16W J	EZSM	CX-NSZ300
X	FUNC/E.VR	R	0661 88-108-153-080	OE	C-RES,U 15K-1/16W J	USM	CX-SNAJ300
X	FUNC/E.VR	R	0661 88-108-153-080	OE	C-RES,U 15K-1/16W J	USM	CX-SNAJ305
X	FUNC/E.VR	R	0662 88-108-153-080		C-RES,U 15K-1/16W J	LHSM	CX-NSZ300
X	FUNC/E.VR	R	0662 88-108-153-080		C-RES,U 15K-1/16W J	USM	CX-SNAJ300
X	FUNC/E.VR	R	0662 88-108-153-080		C-RES,U 15K-1/16W J	USM	CX-SNAJ305
X	FUNC/E.VR	R	0662 88-108-153-080		C-RES,U 15K-1/16W J	EZSM	CX-NSZ300
X	FUNC/E.VR	R	0662 88-108-153-080	OE	C-RES,U 15K-1/16W J	USM	CX-SNAJ300
X	FUNC/E.VR	R	0662 88-108-153-080	OE	C-RES,U 15K-1/16W J	USM	CX-SNAJ305
O	KNOB		8B-NF9-011-010		KEY, POWER	LHSM	CX-NSZ300
O	KNOB		8B-NF9-011-010		KEY, POWER	USM	CX-SNAJ300
O	KNOB		8B-NF9-011-010		KEY, POWER	USM	CX-SNAJ305
O	KNOB		8B-NF9-011-010	OE	KEY, POWER	LHSM	CX-NSZ300
O	KNOB		8B-NF9-011-010	OE	KEY, POWER	USM	CX-SNAJ300
O	KNOB		8B-NF9-011-010	OE	KEY, POWER	USM	CX-SNAJ305
O	KNOB		8B-NF9-011-110		KEY, POWER	EZSM	CX-NSZ300
O	KNOB		8B-NF9-012-010		KEY, T-BASS	LHSM	CX-NSZ300

PARTS LIST

! = Δ SAFTY PARTS
 C = Components marked

All components used on this model at the production line are shown in this service manual.

However, please note that not all components will be available as spare parts for after-sales service.

Components marked S and O are designated as spare parts for service and will be stocked at the spare parts centers.

Components marked X and R are not designated as spare parts for after sales service, and will not be stocked at the spare parts centers.

K NO. = Only use Japanese.

! C	UNIT NAME	REF NO.	PARTS CODE	K NO.	DESCRIPTION	SUFFIX	MODEL NAME
O	KNOB		8B-NF9-012-010		KEY, T-BASS	USM	CX-SNAJ300
O	KNOB		8B-NF9-012-010		KEY, T-BASS	USM	CX-SNAJ305
O	KNOB		8B-NF9-012-010		KEY, T-BASS	EZSM	CX-NSZ300
O	KNOB		8B-NF9-012-010	0E	KEY, T-BASS	LHSM	CX-NSZ300
O	KNOB		8B-NF9-012-010	0E	KEY, T-BASS	USM	CX-SNAJ300
O	KNOB		8B-NF9-012-010	0E	KEY, T-BASS	USM	CX-SNAJ305
O	KNOB		8B-NF9-013-010		KEY, FUN	LHSM	CX-NSZ300
O	KNOB		8B-NF9-013-010		KEY, FUN	USM	CX-SNAJ300
O	KNOB		8B-NF9-013-010		KEY, FUN	USM	CX-SNAJ305
O	KNOB		8B-NF9-013-010		KEY, FUN	EZSM	CX-NSZ300
O	KNOB		8B-NF9-013-010	1A	KEY, FUN	LHSM	CX-NSZ300
O	KNOB		8B-NF9-013-010	1A	KEY, FUN	USM	CX-SNAJ300
O	KNOB		8B-NF9-013-010	1A	KEY, FUN	USM	CX-SNAJ305
O	KNOB		8B-NF9-014-010		KEY, CD	LHSM	CX-NSZ300
O	KNOB		8B-NF9-014-010		KEY, CD	EZSM	CX-NSZ300
O	KNOB		8B-NF9-014-010	0E	KEY, CD	LHSM	CX-NSZ300
O	KNOB		8B-NF9-014-010	0E	KEY, CD	USM	CX-SNAJ300
O	KNOB		8B-NF9-014-010	0E	KEY, CD	USM	CX-SNAJ305
O	KNOB		8B-NF9-016-010		KEY, OPE P	LHSM	CX-NSZ300
O	KNOB		8B-NF9-016-010		KEY, OPE P	EZSM	CX-NSZ300
O	KNOB		8B-NF9-016-010	1A	KEY, OPE P	LHSM	CX-NSZ300
O	KNOB		8B-NF9-016-010	1A	KEY, OPE P	USM	CX-SNAJ300
O	KNOB		8B-NF9-016-010	1A	KEY, OPE P	USM	CX-SNAJ305
O	KNOB		8B-NF9-018-010		KEY, GEQ	LHSM	CX-NSZ300
O	KNOB		8B-NF9-018-010		KEY, GEQ	EZSM	CX-NSZ300
O	KNOB		8B-NF9-018-010	0E	KEY, GEQ	LHSM	CX-NSZ300
O	KNOB		8B-NF9-018-010	0E	KEY, GEQ	USM	CX-SNAJ300
O	KNOB		8B-NF9-018-010	0E	KEY, GEQ	USM	CX-SNAJ305
O	KNOB		8B-NF9-019-010		KNOB, RTRY VOL	LHSM	CX-NSZ300
O	KNOB		8B-NF9-019-010		KNOB, RTRY VOL	USM	CX-SNAJ300
O	KNOB		8B-NF9-019-010		KNOB, RTRY VOL	USM	CX-SNAJ305
O	KNOB		8B-NF9-019-010	0E	KNOB, RTRY VOL	LHSM	CX-NSZ300
O	KNOB		8B-NF9-019-010	0E	KNOB, RTRY VOL	USM	CX-SNAJ300
O	KNOB		8B-NF9-019-010	0E	KNOB, RTRY VOL	USM	CX-SNAJ305
O	KNOB		8B-NF9-020-010		KNOB, RTRY JOG	LHSM	CX-NSZ300
O	KNOB		8B-NF9-020-010		KNOB, RTRY JOG	USM	CX-SNAJ300
O	KNOB		8B-NF9-020-010		KNOB, RTRY JOG	USM	CX-SNAJ305
O	KNOB		8B-NF9-020-010		KNOB, RTRY JOG	EZSM	CX-NSZ300
O	KNOB		8B-NF9-020-010	0E	KNOB, RTRY JOG	LHSM	CX-NSZ300
O	KNOB		8B-NF9-020-010	0E	KNOB, RTRY JOG	USM	CX-SNAJ300
O	KNOB		8B-NF9-020-010	0E	KNOB, RTRY JOG	USM	CX-SNAJ305
X	LBL, POP		87-B40-034-010		LBL, USA 1-800	USM	CX-SNAJ300
X	LBL, POP		87-B40-034-010		LBL, USA 1-800	USM	CX-SNAJ305
X	LBL, POP		87-B40-034-010	1B	LBL, USA 1-800	USM	CX-SNAJ300
X	LBL, POP		87-B40-034-010	1B	LBL, USA 1-800	USM	CX-SNAJ305
X	LBL, POP		8A-NF8-972-010		LBL, POP ENG	USM	CX-SNAJ300
X	LBL, POP		8A-NF8-972-010		LBL, POP ENG	USM	CX-SNAJ305
X	LBL, POP		8A-NF8-972-010	0E	LBL, POP ENG	USM	CX-SNAJ300
X	LBL, POP		8A-NF8-972-010	0E	LBL, POP ENG	USM	CX-SNAJ305
X	LBL, POP		8B-NF9-970-010		LBL, POP LHL	LHSM	CX-NSZ300
X	LBL, POP		8B-NF9-971-010		LBL, POP LHR	LHSM	CX-NSZ300
X	LBL, POP		8B-NF9-972-010		LBL, POP EZL	EZSM	CX-NSZ300
X	LBL, POP		8B-NF9-973-010		LBL, POP EZR	EZSM	CX-NSZ300
X	LBL, POP		8B-NF9-976-010		LBL, POP UL	USM	CX-SNAJ300
X	LBL, POP		8B-NF9-976-010	0E	LBL, POP UL	USM	CX-SNAJ300
X	LBL, POP		8B-NF9-976-010	0E	LBL, POP UL	USM	CX-SNAJ305
X	LBL, POP		8B-NF9-977-010		LBL, POP UR	USM	CX-SNAJ300
X	LBL, POP		8B-NF9-977-010	0E	LBL, POP UR	USM	CX-SNAJ300
X	LBL, POP		8B-NF9-977-010	0E	LBL, POP UR	USM	CX-SNAJ305
X	LBL, POP		8B-NF9-978-010		LBL, POP 305UL	USM	CX-SNAJ305
X	LBL, POP		8B-NF9-979-010		LBL, POP 305UR	USM	CX-SNAJ305
X	MECHANICAL		8B-NF9-236-010		CHAS, MAIN BS 66-40	EZSM	CX-NSZ300
X	MECHANICAL		8B-NF9-237-010		CHAS, MAIN BS 66-60	LHSM	CX-NSZ300

PARTS LIST

! = Δ SAFTY PARTS
 C = Components marked

All components used on this model at the production line are shown in this service manual.

However, please note that not all components will be available as spare parts for after-sales service.

Components marked S and O are designated as spare parts for service and will be stocked at the spare parts centers.

Components marked X and R are not designated as spare parts for after sales service, and will not be stocked at the spare parts centers.

K NO. = Only use japanese.

! C	UNIT NAME	REF NO.	PARTS CODE	K NO.	DESCRIPTION	SUFFIX	MODEL NAME
X	MECHANICAL		8B-NF9-237-010		CHAS,MAIN BS 66-60	USM	CX-SNAJ300
X	MECHANICAL		8B-NF9-237-010		CHAS,MAIN BS 66-60	USM	CX-SNAJ305
X	MECHANICAL		8B-NF9-237-010	1D	CHAS,MAIN BS 66-60	LHSM	CX-NSZ300
X	MECHANICAL		8B-NF9-237-010	1D	CHAS,MAIN BS 66-60	USM	CX-SNAJ300
X	MECHANICAL		8B-NF9-237-010	1D	CHAS,MAIN BS 66-60	USM	CX-SNAJ305
X	MICON	*	8B-NF9-621-010		PWB,FRONT BNF-9 (MSIA)	LHSM	CX-NSZ300
X	MICON	*	8B-NF9-621-010		PWB,FRONT BNF-9 (MSIA)	USM	CX-SNAJ300
X	MICON	*	8B-NF9-621-010		PWB,FRONT BNF-9 (MSIA)	USM	CX-SNAJ305
X	MICON	*	8B-NF9-621-010		PWB,FRONT BNF-9 (MSIA)	EZSM	CX-NSZ300
X	MICON	*	8B-NF9-621-010	1C	PWB,FRONT BNF-9 (MSIA)	LHSM	CX-NSZ300
X	MICON	*	8B-NF9-621-010	1C	PWB,FRONT BNF-9 (MSIA)	USM	CX-SNAJ300
X	MICON	*	8B-NF9-621-010	1C	PWB,FRONT BNF-9 (MSIA)	USM	CX-SNAJ305
O	MICON	C	0108 87-010-785-080		C-CAP,U 0.015-25 K B GRM	LHSM	CX-NSZ300
O	MICON	C	0108 87-010-785-080		C-CAP,U 0.015-25 K B GRM	USM	CX-SNAJ300
O	MICON	C	0108 87-010-785-080		C-CAP,U 0.015-25 K B GRM	USM	CX-SNAJ305
O	MICON	C	0108 87-010-785-080		C-CAP,U 0.015-25 K B GRM	EZSM	CX-NSZ300
O	MICON	C	0108 87-010-785-080	0E	C-CAP,U 0.015-25 K B GRM	LHSM	CX-NSZ300
O	MICON	C	0108 87-010-785-080	0E	C-CAP,U 0.015-25 K B GRM	USM	CX-SNAJ300
O	MICON	C	0108 87-010-785-080	0E	C-CAP,U 0.015-25 K B GRM	USM	CX-SNAJ305
O	MICON	C	0153 87-010-787-080		C-CAP,U 0.022-25 K B	LHSM	CX-NSZ300
O	MICON	C	0153 87-010-787-080		C-CAP,U 0.022-25 K B	USM	CX-SNAJ300
O	MICON	C	0153 87-010-787-080		C-CAP,U 0.022-25 K B	USM	CX-SNAJ305
O	MICON	C	0153 87-010-787-080	0E	C-CAP,U 0.022-25 K B	LHSM	CX-NSZ300
O	MICON	C	0153 87-010-787-080	0E	C-CAP,U 0.022-25 K B	USM	CX-SNAJ300
O	MICON	C	0153 87-010-787-080	0E	C-CAP,U 0.022-25 K B	USM	CX-SNAJ305
O	MICON	C	0154 87-A12-078-040		CAP,E 47-35 SMG	LHSM	CX-NSZ300
O	MICON	C	0154 87-A12-078-040		CAP,E 47-35 SMG	USM	CX-SNAJ300
O	MICON	C	0154 87-A12-078-040		CAP,E 47-35 SMG	USM	CX-SNAJ305
O	MICON	C	0154 87-A12-078-040		CAP,E 47-35 SMG	EZSM	CX-NSZ300
O	MICON	C	0154 87-A12-078-040	0E	CAP,E 47-35 SMG	LHSM	CX-NSZ300
O	MICON	C	0154 87-A12-078-040	0E	CAP,E 47-35 SMG	USM	CX-SNAJ300
O	MICON	C	0154 87-A12-078-040	0E	CAP,E 47-35 SMG	USM	CX-SNAJ305
O	MICON	C	0155 87-010-404-040		CAP,E 4.7-50 M 11L SME	LHSM	CX-NSZ300
O	MICON	C	0155 87-010-404-040		CAP,E 4.7-50 M 11L SME	USM	CX-SNAJ300
O	MICON	C	0155 87-010-404-040		CAP,E 4.7-50 M 11L SME	USM	CX-SNAJ305
O	MICON	C	0155 87-010-404-040		CAP,E 4.7-50 M 11L SME	EZSM	CX-NSZ300
O	MICON	C	0155 87-010-404-040	0E	CAP,E 4.7-50 M 11L SME	LHSM	CX-NSZ300
O	MICON	C	0155 87-010-404-040	0E	CAP,E 4.7-50 M 11L SME	USM	CX-SNAJ300
O	MICON	C	0155 87-010-404-040	0E	CAP,E 4.7-50 M 11L SME	USM	CX-SNAJ305
O	MICON	C	0156 87-010-404-040		CAP,E 4.7-50 M 11L SME	LHSM	CX-NSZ300
O	MICON	C	0156 87-010-404-040		CAP,E 4.7-50 M 11L SME	USM	CX-SNAJ300
O	MICON	C	0156 87-010-404-040		CAP,E 4.7-50 M 11L SME	USM	CX-SNAJ305
O	MICON	C	0156 87-010-404-040		CAP,E 4.7-50 M 11L SME	EZSM	CX-NSZ300
O	MICON	C	0156 87-010-404-040	0E	CAP,E 4.7-50 M 11L SME	LHSM	CX-NSZ300
O	MICON	C	0156 87-010-404-040	0E	CAP,E 4.7-50 M 11L SME	USM	CX-SNAJ300
O	MICON	C	0156 87-010-404-040	0E	CAP,E 4.7-50 M 11L SME	USM	CX-SNAJ305
O	MICON	C	0301 87-012-278-080		C-CAP,U 2200P-50 K B	LHSM	CX-NSZ300
O	MICON	C	0301 87-012-278-080		C-CAP,U 2200P-50 K B	USM	CX-SNAJ300
O	MICON	C	0301 87-012-278-080		C-CAP,U 2200P-50 K B	USM	CX-SNAJ305
O	MICON	C	0301 87-012-278-080	0E	C-CAP,U 2200P-50 K B	EZSM	CX-NSZ300
O	MICON	C	0301 87-012-278-080	0E	C-CAP,U 2200P-50 K B	LHSM	CX-NSZ300
O	MICON	C	0301 87-012-278-080	0E	C-CAP,U 2200P-50 K B	USM	CX-SNAJ300
O	MICON	C	0351 87-A10-353-080		C-CAP,U 0.22-10 K B	LHSM	CX-NSZ300
O	MICON	C	0351 87-A10-353-080		C-CAP,U 0.22-10 K B	USM	CX-SNAJ300
O	MICON	C	0351 87-A10-353-080		C-CAP,U 0.22-10 K B	USM	CX-SNAJ305
O	MICON	C	0351 87-A10-353-080		C-CAP,U 0.22-10 K B	EZSM	CX-NSZ300
O	MICON	C	0351 87-A10-353-080	0E	C-CAP,U 0.22-10 K B	LHSM	CX-NSZ300
O	MICON	C	0351 87-A10-353-080	0E	C-CAP,U 0.22-10 K B	USM	CX-SNAJ300
O	MICON	C	0351 87-A10-353-080	0E	C-CAP,U 0.22-10 K B	USM	CX-SNAJ305
O	MICON	C	0361 87-012-274-080		C-CAP,U 1000P-50 K B	USM	CX-SNAJ300
O	MICON	C	0361 87-012-274-080		C-CAP,U 1000P-50 K B	LHSM	CX-NSZ300
O	MICON	C	0361 87-012-274-080		C-CAP,U 1000P-50 K B	USM	CX-SNAJ300
O	MICON	C	0361 87-012-274-080		C-CAP,U 1000P-50 K B	USM	CX-SNAJ305
O	MICON	C	0361 87-012-274-080		C-CAP,U 1000P-50 K B	EZSM	CX-NSZ300
O	MICON	C	0361 87-012-274-080	0E	C-CAP,U 1000P-50 K B	LHSM	CX-NSZ300
O	MICON	C	0361 87-012-274-080	0E	C-CAP,U 1000P-50 K B	USM	CX-SNAJ300
O	MICON	C	0361 87-012-274-080	0E	C-CAP,U 1000P-50 K B	USM	CX-SNAJ305
O	MICON	C	0362 87-012-274-080		C-CAP,U 1000P-50 K B	LHSM	CX-NSZ300
O	MICON	C	0362 87-012-274-080		C-CAP,U 1000P-50 K B	USM	CX-SNAJ300

PARTS LIST

! = Δ SAFTY PARTS
 C = Components marked

All components used on this model at the production line are shown in this service manual.

However, please note that not all components will be available as spare parts for after-sales service.

Components marked S and O are designated as spare parts for service and will be stocked at the spare parts centers.

Components marked X and R are not designated as spare parts for after sales service, and will not be stocked at the spare parts centers.

K NO. = Only use japanese.

! C	UNIT NAME	REF NO.	PARTS CODE	K NO.	DESCRIPTION	SUFFIX	MODEL NAME	
O	MICON	C	0362	87-012-274-080		C-CAP,U 1000P-50 K B	USM	CX-SNAJ305
O	MICON	C	0362	87-012-274-080		C-CAP,U 1000P-50 K B	EZSM	CX-NSZ300
O	MICON	C	0362	87-012-274-080	OE	C-CAP,U 1000P-50 K B	LHSM	CX-NSZ300
O	MICON	C	0362	87-012-274-080	OE	C-CAP,U 1000P-50 K B	USM	CX-SNAJ300
O	MICON	C	0362	87-012-274-080	OE	C-CAP,U 1000P-50 K B	USM	CX-SNAJ305
O	MICON	C	0371	87-012-274-080		C-CAP,U 1000P-50 K B	LHSM	CX-NSZ300
O	MICON	C	0371	87-012-274-080		C-CAP,U 1000P-50 K B	USM	CX-SNAJ300
O	MICON	C	0371	87-012-274-080		C-CAP,U 1000P-50 K B	USM	CX-SNAJ305
O	MICON	C	0371	87-012-274-080		C-CAP,U 1000P-50 K B	EZSM	CX-NSZ300
O	MICON	C	0371	87-012-274-080	OE	C-CAP,U 1000P-50 K B	LHSM	CX-NSZ300
O	MICON	C	0371	87-012-274-080	OE	C-CAP,U 1000P-50 K B	USM	CX-SNAJ300
O	MICON	C	0372	87-012-274-080		C-CAP,U 1000P-50 K B	LHSM	CX-NSZ300
O	MICON	C	0372	87-012-274-080		C-CAP,U 1000P-50 K B	USM	CX-SNAJ300
O	MICON	C	0372	87-012-274-080	OE	C-CAP,U 1000P-50 K B	LHSM	CX-NSZ300
O	MICON	C	0372	87-012-274-080	OE	C-CAP,U 1000P-50 K B	USM	CX-SNAJ300
O	MICON	C	0372	87-012-274-080	OE	C-CAP,U 1000P-50 K B	USM	CX-SNAJ305
O	MICON	C	0601	87-010-382-040		CAP,E 22-25 M 11L SME	LHSM	CX-NSZ300
O	MICON	C	0601	87-010-382-040		CAP,E 22-25 M 11L SME	USM	CX-SNAJ300
O	MICON	C	0601	87-010-382-040		CAP,E 22-25 M 11L SME	USM	CX-SNAJ305
O	MICON	C	0601	87-010-382-040		CAP,E 22-25 M 11L SME	EZSM	CX-NSZ300
O	MICON	C	0601	87-010-382-040	OE	CAP,E 22-25 M 11L SME	LHSM	CX-NSZ300
O	MICON	C	0601	87-010-382-040	OE	CAP,E 22-25 M 11L SME	USM	CX-SNAJ300
O	MICON	C	0601	87-010-382-040	OE	CAP,E 22-25 M 11L SME	USM	CX-SNAJ305
O	MICON	C	0801	87-A10-804-080		C-CAP,S 0.1-25 J B	LHSM	CX-NSZ300
O	MICON	C	0801	87-A10-804-080		C-CAP,S 0.1-25 J B	USM	CX-SNAJ300
O	MICON	C	0801	87-A10-804-080		C-CAP,S 0.1-25 J B	USM	CX-SNAJ305
O	MICON	C	0801	87-A10-804-080		C-CAP,S 0.1-25 J B	EZSM	CX-NSZ300
O	MICON	C	0801	87-A10-804-080	OE	C-CAP,S 0.1-25 J B	LHSM	CX-NSZ300
O	MICON	C	0801	87-A10-804-080	OE	C-CAP,S 0.1-25 J B	USM	CX-SNAJ300
O	MICON	C	0801	87-A10-804-080	OE	C-CAP,S 0.1-25 J B	USM	CX-SNAJ305
O	MICON	C	0802	87-010-316-080		C-CAP,S 33P-50 J CH GRM	EZSM	CX-NSZ300
O	MICON	C	0802	87-010-316-080	OE	C-CAP,S 33P-50 J CH GRM	LHSM	CX-NSZ300
O	MICON	C	0802	87-010-316-080	OE	C-CAP,S 33P-50 J CH GRM	USM	CX-SNAJ300
O	MICON	C	0802	87-010-316-080	OE	C-CAP,S 33P-50 J CH GRM	USM	CX-SNAJ305
O	MICON	C	0803	87-012-280-080		C-CAP,U 3300P-50 K B	LHSM	CX-NSZ300
O	MICON	C	0803	87-012-280-080		C-CAP,U 3300P-50 K B	USM	CX-SNAJ300
O	MICON	C	0803	87-012-280-080		C-CAP,U 3300P-50 K B	USM	CX-SNAJ305
O	MICON	C	0803	87-012-280-080		C-CAP,U 3300P-50 K B	EZSM	CX-NSZ300
O	MICON	C	0803	87-012-280-080	OE	C-CAP,U 3300P-50 K B	LHSM	CX-NSZ300
O	MICON	C	0803	87-012-280-080	OE	C-CAP,U 3300P-50 K B	USM	CX-SNAJ300
O	MICON	C	0803	87-012-280-080	OE	C-CAP,U 3300P-50 K B	USM	CX-SNAJ305
O	MICON	C	0804	87-A10-592-080		C-CAP,S 0.015-50 J B	LHSM	CX-NSZ300
O	MICON	C	0804	87-A10-592-080		C-CAP,S 0.015-50 J B	USM	CX-SNAJ300
O	MICON	C	0804	87-A10-592-080		C-CAP,S 0.015-50 J B	USM	CX-SNAJ305
O	MICON	C	0804	87-A10-592-080		C-CAP,S 0.015-50 J B	EZSM	CX-NSZ300
O	MICON	C	0804	87-A10-592-080	OE	C-CAP,S 0.015-50 J B	LHSM	CX-NSZ300
O	MICON	C	0804	87-A10-592-080	OE	C-CAP,S 0.015-50 J B	USM	CX-SNAJ300
O	MICON	C	0804	87-A10-592-080	OE	C-CAP,S 0.015-50 J B	USM	CX-SNAJ305
O	MICON	C	0805	87-012-184-080		C-CAP,U 33P-50 J CH	LHSM	CX-NSZ300
O	MICON	C	0805	87-012-184-080		C-CAP,U 33P-50 J CH	USM	CX-SNAJ300
O	MICON	C	0805	87-012-184-080		C-CAP,U 33P-50 J CH	USM	CX-SNAJ305
O	MICON	C	0805	87-012-184-080		C-CAP,U 33P-50 J CH	EZSM	CX-NSZ300
O	MICON	C	0805	87-012-184-080	OE	C-CAP,U 33P-50 J CH	LHSM	CX-NSZ300
O	MICON	C	0805	87-012-184-080	OE	C-CAP,U 33P-50 J CH	USM	CX-SNAJ300
O	MICON	C	0805	87-012-184-080	OE	C-CAP,U 33P-50 J CH	USM	CX-SNAJ305
O	MICON	C	0806	87-012-274-080		C-CAP,U 1000P-50 K B	LHSM	CX-NSZ300
O	MICON	C	0806	87-012-274-080		C-CAP,U 1000P-50 K B	USM	CX-SNAJ300
O	MICON	C	0806	87-012-274-080		C-CAP,U 1000P-50 K B	USM	CX-SNAJ305
O	MICON	C	0806	87-012-274-080		C-CAP,U 1000P-50 K B	EZSM	CX-NSZ300
O	MICON	C	0806	87-012-274-080	OE	C-CAP,U 1000P-50 K B	LHSM	CX-NSZ300
O	MICON	C	0806	87-012-274-080	OE	C-CAP,U 1000P-50 K B	USM	CX-SNAJ300
O	MICON	C	0806	87-012-274-080	OE	C-CAP,U 1000P-50 K B	USM	CX-SNAJ305
O	MICON	C	0807	87-012-274-080		C-CAP,U 1000P-50 K B	LHSM	CX-NSZ300
O	MICON	C	0807	87-012-274-080		C-CAP,U 1000P-50 K B	USM	CX-SNAJ300
O	MICON	C	0807	87-012-274-080		C-CAP,U 1000P-50 K B	USM	CX-SNAJ305
O	MICON	C	0807	87-012-274-080		C-CAP,U 1000P-50 K B	EZSM	CX-NSZ300
O	MICON	C	0807	87-012-274-080	OE	C-CAP,U 1000P-50 K B	LHSM	CX-NSZ300

PARTS LIST

! = Δ SAFTY PARTS
 C = Components marked

All components used on this model at the production line are shown in this service manual.

However, please note that not all components will be available as spare parts for after-sales service.

Components marked S and O are designated as spare parts for service and will be stocked at the spare parts centers.

Components marked X and R are not designated as spare parts for after sales service, and will not be stocked at the spare parts centers.

K NO. = Only use japanese.

! C	UNIT NAME	REF NO.	PARTS CODE	K NO.	DESCRIPTION	SUFFIX	MODEL NAME	
O	MICON	C	0807	87-012-274-080	OE	C-CAP,U 1000P-50 K B	USM	CX-SNAJ300
O	MICON	C	0807	87-012-274-080	OE	C-CAP,U 1000P-50 K B	USM	CX-SNAJ305
O	MICON	C	0808	87-010-544-040		CAP,E 0.1-50 M 11L SME	LHSM	CX-NSZ300
O	MICON	C	0808	87-010-544-040		CAP,E 0.1-50 M 11L SME	USM	CX-SNAJ300
O	MICON	C	0808	87-010-544-040		CAP,E 0.1-50 M 11L SME	USM	CX-SNAJ305
O	MICON	C	0808	87-010-544-040		CAP,E 0.1-50 M 11L SME	EZSM	CX-NSZ300
O	MICON	C	0808	87-010-544-040	OE	CAP,E 0.1-50 M 11L SME	LHSM	CX-NSZ300
O	MICON	C	0808	87-010-544-040	OE	CAP,E 0.1-50 M 11L SME	USM	CX-SNAJ300
O	MICON	C	0808	87-010-544-040	OE	CAP,E 0.1-50 M 11L SME	USM	CX-SNAJ305
O	MICON	C	0809	87-010-404-040		CAP,E 4.7-50 M 11L SME	LHSM	CX-NSZ300
O	MICON	C	0809	87-010-404-040		CAP,E 4.7-50 M 11L SME	USM	CX-SNAJ300
O	MICON	C	0809	87-010-404-040		CAP,E 4.7-50 M 11L SME	USM	CX-SNAJ305
O	MICON	C	0809	87-010-404-040	OE	CAP,E 4.7-50 M 11L SME	LHSM	CX-NSZ300
O	MICON	C	0809	87-010-404-040	OE	CAP,E 4.7-50 M 11L SME	USM	CX-SNAJ300
O	MICON	C	0809	87-010-404-040	OE	CAP,E 4.7-50 M 11L SME	USM	CX-SNAJ305
O	MICON	C	0810	87-012-286-080		C-CAP,U 0.01-25 K B	LHSM	CX-NSZ300
O	MICON	C	0810	87-012-286-080		C-CAP,U 0.01-25 K B	USM	CX-SNAJ300
O	MICON	C	0810	87-012-286-080		C-CAP,U 0.01-25 K B	USM	CX-SNAJ305
O	MICON	C	0810	87-012-286-080		C-CAP,U 0.01-25 K B	EZSM	CX-NSZ300
O	MICON	C	0810	87-012-286-080	OE	C-CAP,U 0.01-25 K B	LHSM	CX-NSZ300
O	MICON	C	0810	87-012-286-080	OE	C-CAP,U 0.01-25 K B	USM	CX-SNAJ300
O	MICON	C	0810	87-012-286-080	OE	C-CAP,U 0.01-25 K B	USM	CX-SNAJ305
O	MICON	C	0811	87-A12-052-080		C-CAP,S 0.033-25 J B	LHSM	CX-NSZ300
O	MICON	C	0811	87-A12-052-080		C-CAP,S 0.033-25 J B	USM	CX-SNAJ300
O	MICON	C	0811	87-A12-052-080		C-CAP,S 0.033-25 J B	USM	CX-SNAJ305
O	MICON	C	0811	87-A12-052-080		C-CAP,S 0.033-25 J B	EZSM	CX-NSZ300
O	MICON	C	0811	87-A12-052-080	OE	C-CAP,S 0.033-25 J B	LHSM	CX-NSZ300
O	MICON	C	0811	87-A12-052-080	OE	C-CAP,S 0.033-25 J B	USM	CX-SNAJ300
O	MICON	C	0811	87-A12-052-080	OE	C-CAP,S 0.033-25 J B	USM	CX-SNAJ305
O	MICON	C	0901	87-012-195-080		C-CAP,U 100P-50 J CH	LHSM	CX-NSZ300
O	MICON	C	0901	87-012-195-080		C-CAP,U 100P-50 J CH	USM	CX-SNAJ300
O	MICON	C	0901	87-012-195-080		C-CAP,U 100P-50 J CH	USM	CX-SNAJ305
O	MICON	C	0901	87-012-195-080		C-CAP,U 100P-50 J CH	EZSM	CX-NSZ300
O	MICON	C	0901	87-012-195-080	OE	C-CAP,U 100P-50 J CH	LHSM	CX-NSZ300
O	MICON	C	0901	87-012-195-080	OE	C-CAP,U 100P-50 J CH	USM	CX-SNAJ300
O	MICON	C	0901	87-012-195-080	OE	C-CAP,U 100P-50 J CH	USM	CX-SNAJ305
O	MICON	C	0902	87-012-195-080		C-CAP,U 100P-50 J CH	LHSM	CX-NSZ300
O	MICON	C	0902	87-012-195-080		C-CAP,U 100P-50 J CH	USM	CX-SNAJ300
O	MICON	C	0902	87-012-195-080		C-CAP,U 100P-50 J CH	USM	CX-SNAJ305
O	MICON	C	0902	87-012-195-080		C-CAP,U 100P-50 J CH	EZSM	CX-NSZ300
O	MICON	C	0902	87-012-195-080	OE	C-CAP,U 100P-50 J CH	LHSM	CX-NSZ300
O	MICON	C	0902	87-012-195-080	OE	C-CAP,U 100P-50 J CH	USM	CX-SNAJ300
O	MICON	C	0902	87-012-195-080	OE	C-CAP,U 100P-50 J CH	USM	CX-SNAJ305
O	MICON	C	0903	87-012-195-080		C-CAP,U 100P-50 J CH	LHSM	CX-NSZ300
O	MICON	C	0903	87-012-195-080		C-CAP,U 100P-50 J CH	USM	CX-SNAJ300
O	MICON	C	0903	87-012-195-080		C-CAP,U 100P-50 J CH	USM	CX-SNAJ305
O	MICON	C	0903	87-012-195-080		C-CAP,U 100P-50 J CH	EZSM	CX-NSZ300
O	MICON	C	0903	87-012-195-080	OE	C-CAP,U 100P-50 J CH	LHSM	CX-NSZ300
O	MICON	C	0903	87-012-195-080	OE	C-CAP,U 100P-50 J CH	USM	CX-SNAJ300
O	MICON	C	0903	87-012-195-080	OE	C-CAP,U 100P-50 J CH	USM	CX-SNAJ305
O	MICON	C	0904	87-012-195-080	OE	C-CAP,U 100P-50 J CH	USM	CX-SNAJ305
O	MICON	C	0904	87-012-195-080		C-CAP,U 100P-50 J CH	LHSM	CX-NSZ300
O	MICON	C	0904	87-012-195-080		C-CAP,U 100P-50 J CH	USM	CX-SNAJ300
O	MICON	C	0904	87-012-195-080		C-CAP,U 100P-50 J CH	USM	CX-SNAJ305
O	MICON	C	0904	87-012-195-080	OE	C-CAP,U 100P-50 J CH	LHSM	CX-NSZ300
O	MICON	C	0904	87-012-195-080	OE	C-CAP,U 100P-50 J CH	USM	CX-SNAJ300
O	MICON	C	0904	87-012-195-080	OE	C-CAP,U 100P-50 J CH	USM	CX-SNAJ305
O	MICON	C	0905	87-012-195-080		C-CAP,U 100P-50 J CH	LHSM	CX-NSZ300
O	MICON	C	0905	87-012-195-080		C-CAP,U 100P-50 J CH	USM	CX-SNAJ300
O	MICON	C	0905	87-012-195-080		C-CAP,U 100P-50 J CH	USM	CX-SNAJ305
O	MICON	C	0905	87-012-195-080		C-CAP,U 100P-50 J CH	EZSM	CX-NSZ300
O	MICON	C	0905	87-012-195-080	OE	C-CAP,U 100P-50 J CH	LHSM	CX-NSZ300
O	MICON	C	0905	87-012-195-080	OE	C-CAP,U 100P-50 J CH	USM	CX-SNAJ300
O	MICON	C	0905	87-012-195-080	OE	C-CAP,U 100P-50 J CH	USM	CX-SNAJ305
O	MICON	C	0906	87-012-195-080		C-CAP,U 100P-50 J CH	LHSM	CX-NSZ300
O	MICON	C	0906	87-012-195-080		C-CAP,U 100P-50 J CH	USM	CX-SNAJ300
O	MICON	C	0906	87-012-195-080		C-CAP,U 100P-50 J CH	USM	CX-SNAJ305
O	MICON	C	0906	87-012-195-080		C-CAP,U 100P-50 J CH	EZSM	CX-NSZ300
O	MICON	C	0906	87-012-195-080	OE	C-CAP,U 100P-50 J CH	LHSM	CX-NSZ300

PARTS LIST

! = Δ SAFTY PARTS
 C = Components marked

All components used on this model at the production line are shown in this service manual.

However, please note that not all components will be available as spare parts for after-sales service.

Components marked S and O are designated as spare parts for service and will be stocked at the spare parts centers.

Components marked X and R are not designated as spare parts for after sales service, and will not be stocked at the spare parts centers.

K NO. = Only use japanese.

! C	UNIT NAME	REF NO.	PARTS CODE	K NO.	DESCRIPTION	SUFFIX	MODEL NAME	
O	MICON	C	0906	87-012-195-080	OE	C-CAP,U 100P-50 J CH	USM	CX-SNAJ300
O	MICON	C	0906	87-012-195-080	OE	C-CAP,U 100P-50 J CH	USM	CX-SNAJ305
O	MICON	C	0907	87-012-195-080		C-CAP,U 100P-50 J CH	LHSM	CX-NSZ300
O	MICON	C	0907	87-012-195-080		C-CAP,U 100P-50 J CH	USM	CX-SNAJ300
O	MICON	C	0907	87-012-195-080		C-CAP,U 100P-50 J CH	USM	CX-SNAJ305
O	MICON	C	0907	87-012-195-080		C-CAP,U 100P-50 J CH	EZSM	CX-NSZ300
O	MICON	C	0907	87-012-195-080	OE	C-CAP,U 100P-50 J CH	LHSM	CX-NSZ300
O	MICON	C	0907	87-012-195-080	OE	C-CAP,U 100P-50 J CH	USM	CX-SNAJ300
O	MICON	C	0907	87-012-195-080	OE	C-CAP,U 100P-50 J CH	USM	CX-SNAJ305
O	MICON	C	0908	87-012-195-080		C-CAP,U 100P-50 J CH	LHSM	CX-NSZ300
O	MICON	C	0908	87-012-195-080		C-CAP,U 100P-50 J CH	USM	CX-SNAJ300
O	MICON	C	0908	87-012-195-080		C-CAP,U 100P-50 J CH	USM	CX-SNAJ305
O	MICON	C	0908	87-012-195-080		C-CAP,U 100P-50 J CH	EZSM	CX-NSZ300
O	MICON	C	0908	87-012-195-080	OE	C-CAP,U 100P-50 J CH	LHSM	CX-NSZ300
O	MICON	C	0908	87-012-195-080	OE	C-CAP,U 100P-50 J CH	USM	CX-SNAJ300
O	MICON	C	0908	87-012-195-080	OE	C-CAP,U 100P-50 J CH	USM	CX-SNAJ305
O	MICON	C	0909	87-012-195-080		C-CAP,U 100P-50 J CH	LHSM	CX-NSZ300
O	MICON	C	0909	87-012-195-080		C-CAP,U 100P-50 J CH	USM	CX-SNAJ300
O	MICON	C	0909	87-012-195-080		C-CAP,U 100P-50 J CH	USM	CX-SNAJ305
O	MICON	C	0909	87-012-195-080		C-CAP,U 100P-50 J CH	EZSM	CX-NSZ300
O	MICON	C	0909	87-012-195-080	OE	C-CAP,U 100P-50 J CH	LHSM	CX-NSZ300
O	MICON	C	0909	87-012-195-080	OE	C-CAP,U 100P-50 J CH	USM	CX-SNAJ300
O	MICON	C	0909	87-012-195-080	OE	C-CAP,U 100P-50 J CH	USM	CX-SNAJ305
O	MICON	C	0910	87-012-195-080		C-CAP,U 100P-50 J CH	LHSM	CX-NSZ300
O	MICON	C	0910	87-012-195-080		C-CAP,U 100P-50 J CH	USM	CX-SNAJ300
O	MICON	C	0910	87-012-195-080		C-CAP,U 100P-50 J CH	USM	CX-SNAJ305
O	MICON	C	0910	87-012-195-080		C-CAP,U 100P-50 J CH	LHSM	CX-NSZ300
O	MICON	C	0910	87-012-195-080		C-CAP,U 100P-50 J CH	USM	CX-SNAJ300
O	MICON	C	0910	87-012-195-080	OE	C-CAP,U 100P-50 J CH	LHSM	CX-NSZ300
O	MICON	C	0910	87-012-195-080	OE	C-CAP,U 100P-50 J CH	USM	CX-SNAJ300
O	MICON	C	0910	87-012-195-080	OE	C-CAP,U 100P-50 J CH	USM	CX-SNAJ305
O	MICON	C	0911	87-012-274-080		C-CAP,U 1000P-50 K B	LHSM	CX-NSZ300
O	MICON	C	0911	87-012-274-080		C-CAP,U 1000P-50 K B	USM	CX-SNAJ300
O	MICON	C	0911	87-012-274-080		C-CAP,U 1000P-50 K B	USM	CX-SNAJ305
O	MICON	C	0911	87-012-274-080		C-CAP,U 1000P-50 K B	EZSM	CX-NSZ300
O	MICON	C	0911	87-012-274-080	OE	C-CAP,U 1000P-50 K B	LHSM	CX-NSZ300
O	MICON	C	0911	87-012-274-080	OE	C-CAP,U 1000P-50 K B	USM	CX-SNAJ300
O	MICON	C	0911	87-012-274-080	OE	C-CAP,U 1000P-50 K B	USM	CX-SNAJ305
O	MICON	C	0912	87-010-831-080		C-CAP,U 0.1-16 Z F	LHSM	CX-NSZ300
O	MICON	C	0912	87-010-831-080		C-CAP,U 0.1-16 Z F	USM	CX-SNAJ300
O	MICON	C	0912	87-010-831-080		C-CAP,U 0.1-16 Z F	USM	CX-SNAJ305
O	MICON	C	0912	87-010-831-080		C-CAP,U 0.1-16 Z F	EZSM	CX-NSZ300
O	MICON	C	0912	87-010-831-080	OE	C-CAP,U 0.1-16 Z F	LHSM	CX-NSZ300
O	MICON	C	0912	87-010-831-080	OE	C-CAP,U 0.1-16 Z F	USM	CX-SNAJ300
O	MICON	C	0912	87-010-831-080	OE	C-CAP,U 0.1-16 Z F	USM	CX-SNAJ305
O	MICON	C	0913	87-A10-189-040		CAP,E 220-10 M 5L	LHSM	CX-NSZ300
O	MICON	C	0913	87-A10-189-040		CAP,E 220-10 M 5L	USM	CX-SNAJ300
O	MICON	C	0913	87-A10-189-040		CAP,E 220-10 M 5L	USM	CX-SNAJ305
O	MICON	C	0913	87-A10-189-040		CAP,E 220-10 M 5L	EZSM	CX-NSZ300
O	MICON	C	0913	87-A10-189-040	OE	CAP,E 220-10 M 5L	LHSM	CX-NSZ300
O	MICON	C	0913	87-A10-189-040	OE	CAP,E 220-10 M 5L	USM	CX-SNAJ300
O	MICON	C	0913	87-A10-189-040	OE	CAP,E 220-10 M 5L	USM	CX-SNAJ305
O	MICON	C	0914	87-A10-189-040	OE	CAP,E 220-10 M 5L	USM	CX-SNAJ300
O	MICON	C	0914	87-A10-189-040		CAP,E 220-10 M 5L	LHSM	CX-NSZ300
O	MICON	C	0914	87-A10-189-040		CAP,E 220-10 M 5L	USM	CX-SNAJ305
O	MICON	C	0914	87-A10-189-040		CAP,E 220-10 M 5L	EZSM	CX-NSZ300
O	MICON	C	0914	87-A10-189-040	OE	CAP,E 220-10 M 5L	LHSM	CX-NSZ300
O	MICON	C	0914	87-A10-189-040	OE	CAP,E 220-10 M 5L	USM	CX-SNAJ300
O	MICON	C	0914	87-A10-189-040	OE	CAP,E 220-10 M 5L	USM	CX-SNAJ305
O	MICON	C	0915	87-010-831-080		C-CAP,U 0.1-16 Z F	LHSM	CX-NSZ300
O	MICON	C	0915	87-010-831-080		C-CAP,U 0.1-16 Z F	USM	CX-SNAJ300
O	MICON	C	0915	87-010-831-080		C-CAP,U 0.1-16 Z F	USM	CX-SNAJ305
O	MICON	C	0915	87-010-831-080		C-CAP,U 0.1-16 Z F	EZSM	CX-NSZ300
O	MICON	C	0915	87-010-831-080	OE	C-CAP,U 0.1-16 Z F	LHSM	CX-NSZ300
O	MICON	C	0915	87-010-831-080	OE	C-CAP,U 0.1-16 Z F	USM	CX-SNAJ300
O	MICON	C	0915	87-010-831-080	OE	C-CAP,U 0.1-16 Z F	USM	CX-SNAJ305
O	MICON	C	0916	87-010-831-080		C-CAP,U 0.1-16 Z F	LHSM	CX-NSZ300
O	MICON	C	0916	87-010-831-080		C-CAP,U 0.1-16 Z F	USM	CX-SNAJ300
O	MICON	C	0916	87-010-831-080		C-CAP,U 0.1-16 Z F	USM	CX-SNAJ305
O	MICON	C	0916	87-010-831-080		C-CAP,U 0.1-16 Z F	EZSM	CX-NSZ300
O	MICON	C	0916	87-010-831-080	OE	C-CAP,U 0.1-16 Z F	LHSM	CX-NSZ300

PARTS LIST

! = Δ SAFTY PARTS
 C = Components marked

All components used on this model at the production line are shown in this service manual.

However, please note that not all components will be available as spare parts for after-sales service.

Components marked S and O are designated as spare parts for service and will be stocked at the spare parts centers.

Components marked X and R are not designated as spare parts for after sales service, and will not be stocked at the spare parts centers.

K NO. = Only use japanese.

! C	UNIT NAME	REF NO.	PARTS CODE	K NO.	DESCRIPTION	SUFFIX	MODEL NAME	
O	MICON	C	0916	87-010-831-080	OE	C-CAP,U 0.1-16 Z F	USM	CX-SNAJ300
O	MICON	C	0916	87-010-831-080	OE	C-CAP,U 0.1-16 Z F	USM	CX-SNAJ305
O	MICON	C	0917	87-010-831-080		C-CAP,U 0.1-16 Z F	LHSM	CX-NSZ300
O	MICON	C	0917	87-010-831-080		C-CAP,U 0.1-16 Z F	USM	CX-SNAJ300
O	MICON	C	0917	87-010-831-080		C-CAP,U 0.1-16 Z F	USM	CX-SNAJ305
O	MICON	C	0917	87-010-831-080		C-CAP,U 0.1-16 Z F	EZSM	CX-NSZ300
O	MICON	C	0917	87-010-831-080	OE	C-CAP,U 0.1-16 Z F	LHSM	CX-NSZ300
O	MICON	C	0917	87-010-831-080	OE	C-CAP,U 0.1-16 Z F	USM	CX-SNAJ300
O	MICON	C	0917	87-010-831-080	OE	C-CAP,U 0.1-16 Z F	USM	CX-SNAJ305
O	MICON	C	0919	87-012-286-080		C-CAP,U 0.01-25 K B	LHSM	CX-NSZ300
O	MICON	C	0919	87-012-286-080		C-CAP,U 0.01-25 K B	USM	CX-SNAJ300
O	MICON	C	0919	87-012-286-080		C-CAP,U 0.01-25 K B	USM	CX-SNAJ305
O	MICON	C	0919	87-012-286-080		C-CAP,U 0.01-25 K B	EZSM	CX-NSZ300
O	MICON	C	0919	87-012-286-080	OE	C-CAP,U 0.01-25 K B	LHSM	CX-NSZ300
O	MICON	C	0919	87-012-286-080	OE	C-CAP,U 0.01-25 K B	USM	CX-SNAJ300
O	MICON	C	0919	87-012-286-080	OE	C-CAP,U 0.01-25 K B	USM	CX-SNAJ305
O	MICON	C	0920	87-010-829-080		C-CAP,U 0.047-16 Z F	LHSM	CX-NSZ300
O	MICON	C	0920	87-010-829-080		C-CAP,U 0.047-16 Z F	USM	CX-SNAJ300
O	MICON	C	0920	87-010-829-080		C-CAP,U 0.047-16 Z F	USM	CX-SNAJ305
O	MICON	C	0920	87-010-829-080		C-CAP,U 0.047-16 Z F	EZSM	CX-NSZ300
O	MICON	C	0920	87-010-829-080	OE	C-CAP,U 0.047-16 Z F	LHSM	CX-NSZ300
O	MICON	C	0920	87-010-829-080	OE	C-CAP,U 0.047-16 Z F	USM	CX-SNAJ300
O	MICON	C	0920	87-010-829-080	OE	C-CAP,U 0.047-16 Z F	USM	CX-SNAJ305
O	MICON	C	0921	87-012-282-080		C-CAP,U 4700P-50 K B	LHSM	CX-NSZ300
O	MICON	C	0921	87-012-282-080		C-CAP,U 4700P-50 K B	USM	CX-SNAJ300
O	MICON	C	0921	87-012-282-080		C-CAP,U 4700P-50 K B	USM	CX-SNAJ305
O	MICON	C	0921	87-012-282-080		C-CAP,U 4700P-50 K B	EZSM	CX-NSZ300
O	MICON	C	0921	87-012-282-080	OE	C-CAP,U 4700P-50 K B	LHSM	CX-NSZ300
O	MICON	C	0921	87-012-282-080	OE	C-CAP,U 4700P-50 K B	USM	CX-SNAJ300
O	MICON	C	0921	87-012-282-080	OE	C-CAP,U 4700P-50 K B	USM	CX-SNAJ305
O	MICON	C	0951	87-012-172-080		C-CAP,U 10P-50 D CH	LHSM	CX-NSZ300
O	MICON	C	0951	87-012-172-080		C-CAP,U 10P-50 D CH	USM	CX-SNAJ300
O	MICON	C	0951	87-012-172-080		C-CAP,U 10P-50 D CH	USM	CX-SNAJ305
O	MICON	C	0951	87-012-172-080		C-CAP,U 10P-50 D CH	EZSM	CX-NSZ300
O	MICON	C	0951	87-012-172-080	OE	C-CAP,U 10P-50 D CH	LHSM	CX-NSZ300
O	MICON	C	0951	87-012-172-080	OE	C-CAP,U 10P-50 D CH	USM	CX-SNAJ300
O	MICON	C	0951	87-012-172-080	OE	C-CAP,U 10P-50 D CH	USM	CX-SNAJ305
O	MICON	C	0952	87-010-854-080		C-CAP,S 560P-50 J CH	LHSM	CX-NSZ300
O	MICON	C	0952	87-010-854-080		C-CAP,S 560P-50 J CH	USM	CX-SNAJ300
O	MICON	C	0952	87-010-854-080		C-CAP,S 560P-50 J CH	USM	CX-SNAJ305
O	MICON	C	0952	87-010-854-080		C-CAP,S 560P-50 J CH	EZSM	CX-NSZ300
O	MICON	C	0952	87-010-854-080	OE	C-CAP,S 560P-50 J CH	LHSM	CX-NSZ300
O	MICON	C	0952	87-010-854-080	OE	C-CAP,S 560P-50 J CH	USM	CX-SNAJ300
O	MICON	C	0952	87-010-854-080	OE	C-CAP,S 560P-50 J CH	USM	CX-SNAJ305
O	MICON	C	0953	87-012-349-080		C-CAP,S 1000P-50 J CH GRM	LHSM	CX-NSZ300
O	MICON	C	0953	87-012-349-080		C-CAP,S 1000P-50 J CH GRM	USM	CX-SNAJ300
O	MICON	C	0953	87-012-349-080		C-CAP,S 1000P-50 J CH GRM	USM	CX-SNAJ305
O	MICON	C	0953	87-012-349-080		C-CAP,S 1000P-50 J CH GRM	EZSM	CX-NSZ300
O	MICON	C	0953	87-012-349-080	OE	C-CAP,S 1000P-50 J CH GRM	LHSM	CX-NSZ300
O	MICON	C	0953	87-012-349-080	OE	C-CAP,S 1000P-50 J CH GRM	USM	CX-SNAJ300
O	MICON	C	0953	87-012-349-080	OE	C-CAP,S 1000P-50 J CH GRM	USM	CX-SNAJ305
O	MICON	C	0961	87-010-378-040		CAP,E 10-16 M 11L SME	LHSM	CX-NSZ300
O	MICON	C	0961	87-010-378-040		CAP,E 10-16 M 11L SME	USM	CX-SNAJ300
O	MICON	C	0961	87-010-378-040		CAP,E 10-16 M 11L SME	USM	CX-SNAJ305
O	MICON	C	0961	87-010-378-040		CAP,E 10-16 M 11L SME	EZSM	CX-NSZ300
O	MICON	C	0961	87-010-378-040	OE	CAP,E 10-16 M 11L SME	LHSM	CX-NSZ300
O	MICON	C	0961	87-010-378-040	OE	CAP,E 10-16 M 11L SME	USM	CX-SNAJ300
O	MICON	C	0961	87-010-378-040	OE	CAP,E 10-16 M 11L SME	USM	CX-SNAJ305
O	MICON	C	0962	87-012-336-080		C-CAP,U 330P-50 J SL	LHSM	CX-NSZ300
O	MICON	C	0962	87-012-336-080		C-CAP,U 330P-50 J SL	USM	CX-SNAJ300
O	MICON	C	0962	87-012-336-080		C-CAP,U 330P-50 J SL	USM	CX-SNAJ305
O	MICON	C	0962	87-012-336-080		C-CAP,U 330P-50 J SL	EZSM	CX-NSZ300
O	MICON	C	0962	87-012-336-080	OE	C-CAP,U 330P-50 J SL	LHSM	CX-NSZ300
O	MICON	C	0962	87-012-336-080	OE	C-CAP,U 330P-50 J SL	USM	CX-SNAJ300
O	MICON	C	0962	87-012-336-080	OE	C-CAP,U 330P-50 J SL	USM	CX-SNAJ305
O	MICON	C	0963	87-010-831-080		C-CAP,U 0.1-16 Z F	LHSM	CX-NSZ300
O	MICON	C	0963	87-010-831-080		C-CAP,U 0.1-16 Z F	USM	CX-SNAJ300
O	MICON	C	0963	87-010-831-080		C-CAP,U 0.1-16 Z F	USM	CX-SNAJ305
O	MICON	C	0963	87-010-831-080		C-CAP,U 0.1-16 Z F	EZSM	CX-NSZ300
O	MICON	C	0963	87-010-831-080	OE	C-CAP,U 0.1-16 Z F	LHSM	CX-NSZ300

PARTS LIST

! = Δ SAFTY PARTS
 C = Components marked

All components used on this model at the production line are shown in this service manual.

However, please note that not all components will be available as spare parts for after-sales service.

Components marked S and O are designated as spare parts for service and will be stocked at the spare parts centers.

Components marked X and R are not designated as spare parts for after sales service, and will not be stocked at the spare parts centers.

K NO. = Only use japanese.

! C	UNIT NAME	REF NO.	PARTS CODE	K NO.	DESCRIPTION	SUFFIX	MODEL NAME
	O MICON	C 0963	87-010-831-080	0E	C-CAP,U 0.1-16 Z F	USM	CX-SNAJ300
	O MICON	C 0963	87-010-831-080	0E	C-CAP,U 0.1-16 Z F	USM	CX-SNAJ305
	O MICON	CN 0104	87-A60-057-010		CONN,11P V 9604S-11C	LHSM	CX-NSZ300
	O MICON	CN 0104	87-A60-057-010		CONN,11P V 9604S-11C	USM	CX-SNAJ300
	O MICON	CN 0104	87-A60-057-010		CONN,11P V 9604S-11C	USM	CX-SNAJ305
!	O MICON	CN 0104	87-A60-057-010		CONN,11P V 9604S-11C	EZSM	CX-NSZ300
!	O MICON	CN 0104	87-A60-057-010	0E	CONN,11P V 9604S-11C	LHSM	CX-NSZ300
!	O MICON	CN 0104	87-A60-057-010	0E	CONN,11P V 9604S-11C	USM	CX-SNAJ300
!	O MICON	CN 0104	87-A60-057-010	0E	CONN,11P V 9604S-11C	USM	CX-SNAJ305
	O MICON	CN 0701	87-099-720-010		CONN,30P BLK TYK-B(P)	LHSM	CX-NSZ300
	O MICON	CN 0701	87-099-720-010		CONN,30P BLK TYK-B(P)	USM	CX-SNAJ300
	O MICON	CN 0701	87-099-720-010		CONN,30P BLK TYK-B(P)	USM	CX-SNAJ305
!	O MICON	CN 0701	87-099-720-010	1B	CONN,30P BLK TYK-B(P)	EZSM	CX-NSZ300
!	O MICON	CN 0701	87-099-720-010	1B	CONN,30P BLK TYK-B(P)	LHSM	CX-NSZ300
!	O MICON	CN 0701	87-099-720-010	1B	CONN,30P BLK TYK-B(P)	USM	CX-SNAJ300
!	O MICON	CN 0701	87-099-720-010	1B	CONN,30P BLK TYK-B(P)	USM	CX-SNAJ305
	O MICON	CN 0731	87-099-196-010		CONN,8P V BLK 6216	LHSM	CX-NSZ300
	O MICON	CN 0731	87-099-196-010		CONN,8P V BLK 6216	USM	CX-SNAJ300
	O MICON	CN 0731	87-099-196-010		CONN,8P V BLK 6216	USM	CX-SNAJ305
!	O MICON	CN 0731	87-099-196-010		CONN,8P V BLK 6216	EZSM	CX-NSZ300
!	O MICON	CN 0731	87-099-196-010	0E	CONN,8P V BLK 6216	LHSM	CX-NSZ300
!	O MICON	CN 0731	87-099-196-010	0E	CONN,8P V BLK 6216	USM	CX-SNAJ300
!	O MICON	CN 0731	87-099-196-010	0E	CONN,8P V BLK 6216	USM	CX-SNAJ305
	S MICON	D 0104	87-A40-291-080		DIODE,1N4148M (CPT)	LHSM	CX-NSZ300
	S MICON	D 0104	87-A40-291-080		DIODE,1N4148M (CPT)	USM	CX-SNAJ300
	S MICON	D 0104	87-A40-291-080		DIODE,1N4148M (CPT)	USM	CX-SNAJ305
	S MICON	D 0104	87-A40-291-080		DIODE,1N4148M (CPT)	EZSM	CX-NSZ300
	S MICON	D 0104	87-A40-291-080	0E	DIODE,1N4148M (CPT)	LHSM	CX-NSZ300
	S MICON	D 0104	87-A40-291-080	0E	DIODE,1N4148M (CPT)	USM	CX-SNAJ300
	S MICON	D 0104	87-A40-291-080	0E	DIODE,1N4148M (CPT)	USM	CX-SNAJ305
	S MICON	D 0301	87-A40-748-080		ZENER,UZ5.6BSA	LHSM	CX-NSZ300
	S MICON	D 0301	87-A40-748-080		ZENER,UZ5.6BSA	USM	CX-SNAJ300
	S MICON	D 0301	87-A40-748-080		ZENER,UZ5.6BSA	USM	CX-SNAJ305
	S MICON	D 0301	87-A40-748-080		ZENER,UZ5.6BSA	EZSM	CX-NSZ300
	S MICON	D 0301	87-A40-748-080	0E	ZENER,UZ5.6BSA	LHSM	CX-NSZ300
	S MICON	D 0301	87-A40-748-080	0E	ZENER,UZ5.6BSA	USM	CX-SNAJ300
	S MICON	D 0301	87-A40-748-080	0E	ZENER,UZ5.6BSA	USM	CX-SNAJ305
	S MICON	D 0302	87-A40-291-080		DIODE,1N4148M (CPT)	LHSM	CX-NSZ300
	S MICON	D 0302	87-A40-291-080		DIODE,1N4148M (CPT)	USM	CX-SNAJ300
	S MICON	D 0302	87-A40-291-080		DIODE,1N4148M (CPT)	USM	CX-SNAJ305
	S MICON	D 0302	87-A40-291-080		DIODE,1N4148M (CPT)	EZSM	CX-NSZ300
	S MICON	D 0302	87-A40-291-080	0E	DIODE,1N4148M (CPT)	LHSM	CX-NSZ300
	S MICON	D 0302	87-A40-291-080	0E	DIODE,1N4148M (CPT)	USM	CX-SNAJ300
	S MICON	D 0302	87-A40-291-080	0E	DIODE,1N4148M (CPT)	USM	CX-SNAJ305
	S MICON	D 0601	87-A40-269-080		C-DIODE,MC2836	LHSM	CX-NSZ300
	S MICON	D 0601	87-A40-269-080		C-DIODE,MC2836	USM	CX-SNAJ300
	S MICON	D 0601	87-A40-269-080		C-DIODE,MC2836	USM	CX-SNAJ305
	S MICON	D 0601	87-A40-269-080		C-DIODE,MC2836	EZSM	CX-NSZ300
	S MICON	D 0601	87-A40-269-080	0E	C-DIODE,MC2836	LHSM	CX-NSZ300
	S MICON	D 0601	87-A40-269-080	0E	C-DIODE,MC2836	USM	CX-SNAJ300
	S MICON	D 0601	87-A40-269-080	0E	C-DIODE,MC2836	USM	CX-SNAJ305
	S MICON	D 0651	87-A40-269-080		C-DIODE,MC2836	LHSM	CX-NSZ300
	S MICON	D 0651	87-A40-269-080		C-DIODE,MC2836	USM	CX-SNAJ300
	S MICON	D 0651	87-A40-269-080		C-DIODE,MC2836	USM	CX-SNAJ305
	S MICON	D 0651	87-A40-269-080		C-DIODE,MC2836	EZSM	CX-NSZ300
	S MICON	D 0651	87-A40-269-080	0E	C-DIODE,MC2836	LHSM	CX-NSZ300
	S MICON	D 0651	87-A40-269-080	0E	C-DIODE,MC2836	USM	CX-SNAJ300
	S MICON	D 0651	87-A40-269-080	0E	C-DIODE,MC2836	USM	CX-SNAJ305
	S MICON	D 0652	87-A40-269-080		C-DIODE,MC2836	LHSM	CX-NSZ300
	S MICON	D 0652	87-A40-269-080		C-DIODE,MC2836	USM	CX-SNAJ300
	S MICON	D 0652	87-A40-269-080	0E	C-DIODE,MC2836	LHSM	CX-NSZ300
	S MICON	D 0652	87-A40-269-080	0E	C-DIODE,MC2836	USM	CX-SNAJ305
	S MICON	D 0653	87-A40-269-080		C-DIODE,MC2836	LHSM	CX-NSZ300
	S MICON	D 0653	87-A40-269-080		C-DIODE,MC2836	USM	CX-SNAJ300
	S MICON	D 0653	87-A40-269-080		C-DIODE,MC2836	USM	CX-SNAJ305
	S MICON	D 0653	87-A40-269-080		C-DIODE,MC2836	EZSM	CX-NSZ300
	S MICON	D 0653	87-A40-269-080	0E	C-DIODE,MC2836	LHSM	CX-NSZ300

PARTS LIST

! = Δ SAFTY PARTS
 C = Components marked

All components used on this model at the production line are shown in this service manual.

However, please note that not all components will be available as spare parts for after-sales service.

Components marked S and O are designated as spare parts for service and will be stocked at the spare parts centers.

Components marked X and R are not designated as spare parts for after sales service, and will not be stocked at the spare parts centers.

K NO. = Only use japanese.

! C	UNIT NAME	REF NO.	PARTS CODE	K NO.	DESCRIPTION	SUFFIX	MODEL NAME	
S	MICON	D	0653	87-A40-269-080	OE	C-DIODE,MC2836	USM	CX-SNAJ300
S	MICON	D	0653	87-A40-269-080	OE	C-DIODE,MC2836	USM	CX-SNAJ305
S	MICON	D	0654	87-A40-269-080		C-DIODE,MC2836	LHSM	CX-NSZ300
S	MICON	D	0654	87-A40-269-080		C-DIODE,MC2836	USM	CX-SNAJ300
S	MICON	D	0654	87-A40-269-080		C-DIODE,MC2836	USM	CX-SNAJ305
S	MICON	D	0654	87-A40-269-080		C-DIODE,MC2836	EZSM	CX-NSZ300
S	MICON	D	0654	87-A40-269-080	OE	C-DIODE,MC2836	LHSM	CX-NSZ300
S	MICON	D	0654	87-A40-269-080	OE	C-DIODE,MC2836	USM	CX-SNAJ300
S	MICON	D	0654	87-A40-269-080	OE	C-DIODE,MC2836	USM	CX-SNAJ305
S	MICON	D	0655	87-A40-269-080		C-DIODE,MC2836	LHSM	CX-NSZ300
S	MICON	D	0655	87-A40-269-080		C-DIODE,MC2836	USM	CX-SNAJ300
S	MICON	D	0655	87-A40-269-080		C-DIODE,MC2836	USM	CX-SNAJ305
S	MICON	D	0655	87-A40-269-080	OE	C-DIODE,MC2836	LHSM	CX-NSZ300
S	MICON	D	0655	87-A40-269-080	OE	C-DIODE,MC2836	USM	CX-SNAJ300
S	MICON	D	0655	87-A40-269-080	OE	C-DIODE,MC2836	USM	CX-SNAJ305
S	MICON	D	0656	87-A40-269-080		C-DIODE,MC2836	LHSM	CX-NSZ300
S	MICON	D	0656	87-A40-269-080		C-DIODE,MC2836	USM	CX-SNAJ300
S	MICON	D	0656	87-A40-269-080		C-DIODE,MC2836	USM	CX-SNAJ305
S	MICON	D	0656	87-A40-269-080		C-DIODE,MC2836	EZSM	CX-NSZ300
S	MICON	D	0656	87-A40-269-080	OE	C-DIODE,MC2836	LHSM	CX-NSZ300
S	MICON	D	0656	87-A40-269-080	OE	C-DIODE,MC2836	USM	CX-SNAJ300
S	MICON	D	0656	87-A40-269-080	OE	C-DIODE,MC2836	USM	CX-SNAJ305
S	MICON	D	0657	87-A40-269-080		C-DIODE,MC2836	LHSM	CX-NSZ300
S	MICON	D	0657	87-A40-269-080		C-DIODE,MC2836	USM	CX-SNAJ300
S	MICON	D	0657	87-A40-269-080		C-DIODE,MC2836	USM	CX-SNAJ305
X	MICON	D	0702	88-100-000-010		PLATING-JW, 0.58 SN95	LHSM	CX-NSZ300
X	MICON	D	0702	88-100-000-010		PLATING-JW, 0.58 SN95	USM	CX-SNAJ300
X	MICON	D	0702	88-100-000-010		PLATING-JW, 0.58 SN95	USM	CX-SNAJ305
X	MICON	D	0702	88-100-000-010		PLATING-JW, 0.58 SN95	USM	CX-NSZ300
X	MICON	D	0702	88-100-000-010		PLATING-JW, 0.58 SN95	EZSM	CX-NSZ300
X	MICON	D	0702	88-100-000-010	OE	PLATING-JW, 0.58 SN95	LHSM	CX-NSZ300
X	MICON	D	0702	88-100-000-010	OE	PLATING-JW, 0.58 SN95	USM	CX-SNAJ300
X	MICON	D	0702	88-100-000-010	OE	PLATING-JW, 0.58 SN95	USM	CX-SNAJ305
X	MICON	D	0703	88-100-000-010		PLATING-JW, 0.58 SN95	LHSM	CX-NSZ300
X	MICON	D	0703	88-100-000-010		PLATING-JW, 0.58 SN95	USM	CX-SNAJ300
X	MICON	D	0703	88-100-000-010		PLATING-JW, 0.58 SN95	USM	CX-SNAJ305
X	MICON	D	0703	88-100-000-010		PLATING-JW, 0.58 SN95	EZSM	CX-NSZ300
X	MICON	D	0703	88-100-000-010	OE	PLATING-JW, 0.58 SN95	LHSM	CX-NSZ300
X	MICON	D	0703	88-100-000-010	OE	PLATING-JW, 0.58 SN95	USM	CX-SNAJ300
X	MICON	D	0703	88-100-000-010	OE	PLATING-JW, 0.58 SN95	USM	CX-SNAJ305
S	MICON	D	0801	87-A40-291-080		DIODE,1N4148M (CPT)	LHSM	CX-NSZ300
S	MICON	D	0801	87-A40-291-080		DIODE,1N4148M (CPT)	USM	CX-SNAJ300
S	MICON	D	0801	87-A40-291-080		DIODE,1N4148M (CPT)	USM	CX-SNAJ305
S	MICON	D	0801	87-A40-291-080		DIODE,1N4148M (CPT)	EZSM	CX-NSZ300
S	MICON	D	0801	87-A40-291-080	OE	DIODE,1N4148M (CPT)	LHSM	CX-NSZ300
S	MICON	D	0801	87-A40-291-080	OE	DIODE,1N4148M (CPT)	USM	CX-SNAJ300
S	MICON	D	0801	87-A40-291-080	OE	DIODE,1N4148M (CPT)	USM	CX-SNAJ305
S	MICON	D	0981	87-A40-291-080		DIODE,1N4148M (CPT)	LHSM	CX-NSZ300
S	MICON	D	0981	87-A40-291-080		DIODE,1N4148M (CPT)	USM	CX-SNAJ300
S	MICON	D	0981	87-A40-291-080		DIODE,1N4148M (CPT)	USM	CX-SNAJ305
S	MICON	D	0981	87-A40-291-080	OE	DIODE,1N4148M (CPT)	LHSM	CX-NSZ300
S	MICON	D	0981	87-A40-291-080	OE	DIODE,1N4148M (CPT)	USM	CX-SNAJ300
S	MICON	D	0981	87-A40-291-080	OE	DIODE,1N4148M (CPT)	USM	CX-SNAJ305
S	MICON	D	0983	87-A40-291-080		DIODE,1N4148M (CPT)	EZSM	CX-NSZ300
S	MICON	D	0989	87-A40-291-080		DIODE,1N4148M (CPT)	LHSM	CX-NSZ300
S	MICON	D	0989	87-A40-291-080	OE	DIODE,1N4148M (CPT)	LHSM	CX-NSZ300
S	MICON	D	0990	87-A40-291-080		DIODE,1N4148M (CPT)	LHSM	CX-NSZ300
S	MICON	D	0990	87-A40-291-080	OE	DIODE,1N4148M (CPT)	LHSM	CX-NSZ300
O	MICON	FL	0901	8B-NF9-605-010		FL,BJ814GNK	LHSM	CX-NSZ300
O	MICON	FL	0901	8B-NF9-605-010		FL,BJ814GNK	USM	CX-SNAJ300
O	MICON	FL	0901	8B-NF9-605-010		FL,BJ814GNK	USM	CX-SNAJ305
O	MICON	FL	0901	8B-NF9-605-010	2M	FL,BJ814GNK	LHSM	CX-NSZ300
O	MICON	FL	0901	8B-NF9-605-010	2M	FL,BJ814GNK	USM	CX-SNAJ300
O	MICON	FL	0901	8B-NF9-605-010	2M	FL,BJ814GNK	USM	CX-SNAJ305
O	S MICON	IC	0901	8B-NF9-601-030		C-IC,UPD780226GF-***	LHSM	CX-NSZ300
O	S MICON	IC	0901	8B-NF9-601-030		C-IC,UPD780226GF-***	USM	CX-SNAJ300
O	S MICON	IC	0901	8B-NF9-601-030		C-IC,UPD780226GF-***	USM	CX-SNAJ305
S	MICON	IC	0901	8B-NF9-601-030		C-IC,UPD780226GF-021-3BA	EZSM	CX-NSZ300
S	MICON	IC	0901	8B-NF9-601-030	2A	C-IC,UPD780226GF-021-3BA	LHSM	CX-NSZ300

PARTS LIST

! = Δ SAFTY PARTS
 C = Components marked

All components used on this model at the production line are shown in this service manual.

However, please note that not all components will be available as spare parts for after-sales service.

Components marked S and O are designated as spare parts for service and will be stocked at the spare parts centers.

Components marked X and R are not designated as spare parts for after sales service, and will not be stocked at the spare parts centers.

K NO. = Only use japanese.

! C	UNIT NAME	REF NO.	PARTS CODE	K NO.	DESCRIPTION	SUFFIX	MODEL NAME
S	MICON	IC 0901	8B-NF9-601-030	2A	C-IC, UPD780226GF-021-3BA	USM	CX-SNAJ300
S	MICON	IC 0901	8B-NF9-601-030	2A	C-IC, UPD780226GF-021-3BA	USM	CX-SNAJ305
S	MICON	IC 0961	87-A21-218-010		IC, NJL64H380A	LHSM	CX-NSZ300
S	MICON	IC 0961	87-A21-218-110		IC, NJL64H380A	USM	CX-SNAJ300
S	MICON	IC 0961	87-A21-218-110		IC, NJL64H380A	USM	CX-SNAJ305
S	MICON	IC 0961	87-A21-218-110		IC, NJL64H380A	EZSM	CX-NSZ300
S	MICON	IC 0961	87-A21-218-110	1B	IC, NJL64H380A	LHSM	CX-NSZ300
S	MICON	IC 0961	87-A21-218-110	1B	IC, NJL64H380A	USM	CX-SNAJ300
S	MICON	IC 0961	87-A21-218-110	1B	IC, NJL64H380A	USM	CX-SNAJ305
X	MICON	JR 0101	88-108-000-080		C-JUMPER, U	LHSM	CX-NSZ300
X	MICON	JR 0101	88-108-000-080		C-JUMPER, U	USM	CX-SNAJ300
X	MICON	JR 0101	88-108-000-080		C-JUMPER, U	EZSM	CX-NSZ300
X	MICON	JR 0101	88-108-000-080	OE	C-JUMPER, U	LHSM	CX-NSZ300
X	MICON	JR 0101	88-108-000-080	OE	C-JUMPER, U	USM	CX-SNAJ300
X	MICON	JR 0101	88-108-000-080	OE	C-JUMPER, U	USM	CX-SNAJ305
X	MICON	JR 0151	88-108-000-080		C-JUMPER, U	LHSM	CX-NSZ300
X	MICON	JR 0151	88-108-000-080		C-JUMPER, U	USM	CX-SNAJ300
X	MICON	JR 0151	88-108-000-080		C-JUMPER, U	USM	CX-SNAJ305
X	MICON	JR 0151	88-108-000-080		C-JUMPER, U	EZSM	CX-NSZ300
X	MICON	JR 0151	88-108-000-080	OE	C-JUMPER, U	LHSM	CX-NSZ300
X	MICON	JR 0151	88-108-000-080	OE	C-JUMPER, U	USM	CX-SNAJ300
X	MICON	JR 0151	88-108-000-080	OE	C-JUMPER, U	USM	CX-SNAJ305
X	MICON	JR 0152	88-108-000-080		C-JUMPER, U	LHSM	CX-NSZ300
X	MICON	JR 0152	88-108-000-080		C-JUMPER, U	USM	CX-SNAJ300
X	MICON	JR 0152	88-108-000-080		C-JUMPER, U	USM	CX-SNAJ305
X	MICON	JR 0152	88-108-000-080		C-JUMPER, U	LHSM	CX-NSZ300
X	MICON	JR 0152	88-108-000-080		C-JUMPER, U	USM	CX-SNAJ300
X	MICON	JR 0152	88-108-000-080	OE	C-JUMPER, U	LHSM	CX-NSZ300
X	MICON	JR 0152	88-108-000-080	OE	C-JUMPER, U	USM	CX-SNAJ300
X	MICON	JR 0152	88-108-000-080	OE	C-JUMPER, U	USM	CX-SNAJ305
X	MICON	JR 0361	88-108-000-080		C-JUMPER, U	LHSM	CX-NSZ300
X	MICON	JR 0361	88-108-000-080		C-JUMPER, U	USM	CX-SNAJ300
X	MICON	JR 0361	88-108-000-080		C-JUMPER, U	USM	CX-SNAJ305
X	MICON	JR 0361	88-108-000-080		C-JUMPER, U	EZSM	CX-NSZ300
X	MICON	JR 0361	88-108-000-080	OE	C-JUMPER, U	LHSM	CX-NSZ300
X	MICON	JR 0361	88-108-000-080	OE	C-JUMPER, U	USM	CX-SNAJ300
X	MICON	JR 0361	88-108-000-080	OE	C-JUMPER, U	USM	CX-SNAJ305
X	MICON	JR 0601	88-108-000-080		C-JUMPER, U	LHSM	CX-NSZ300
X	MICON	JR 0601	88-108-000-080		C-JUMPER, U	USM	CX-SNAJ300
X	MICON	JR 0601	88-108-000-080		C-JUMPER, U	USM	CX-SNAJ305
X	MICON	JR 0601	88-108-000-080		C-JUMPER, U	EZSM	CX-NSZ300
X	MICON	JR 0601	88-108-000-080	OE	C-JUMPER, U	LHSM	CX-NSZ300
X	MICON	JR 0601	88-108-000-080	OE	C-JUMPER, U	USM	CX-SNAJ300
X	MICON	JR 0601	88-108-000-080	OE	C-JUMPER, U	USM	CX-SNAJ305
X	MICON	JR 0603	88-108-000-080		C-JUMPER, U	LHSM	CX-NSZ300
X	MICON	JR 0603	88-108-000-080		C-JUMPER, U	USM	CX-SNAJ300
X	MICON	JR 0603	88-108-000-080		C-JUMPER, U	USM	CX-SNAJ305
X	MICON	JR 0603	88-108-000-080		C-JUMPER, U	LHSM	CX-NSZ300
X	MICON	JR 0603	88-108-000-080		C-JUMPER, U	USM	CX-SNAJ300
X	MICON	JR 0603	88-108-000-080	OE	C-JUMPER, U	USM	CX-SNAJ305
X	MICON	JR 0605	88-108-000-080		C-JUMPER, U	LHSM	CX-NSZ300
X	MICON	JR 0605	88-108-000-080		C-JUMPER, U	USM	CX-SNAJ300
X	MICON	JR 0605	88-108-000-080		C-JUMPER, U	USM	CX-SNAJ305
X	MICON	JR 0605	88-108-000-080		C-JUMPER, U	EZSM	CX-NSZ300
X	MICON	JR 0605	88-108-000-080	OE	C-JUMPER, U	LHSM	CX-NSZ300
X	MICON	JR 0605	88-108-000-080	OE	C-JUMPER, U	USM	CX-SNAJ300
X	MICON	JR 0605	88-108-000-080	OE	C-JUMPER, U	USM	CX-SNAJ305
X	MICON	JR 0607	88-108-000-080		C-JUMPER, U	LHSM	CX-NSZ300
X	MICON	JR 0607	88-108-000-080		C-JUMPER, U	USM	CX-SNAJ300
X	MICON	JR 0607	88-108-000-080		C-JUMPER, U	USM	CX-SNAJ305
X	MICON	JR 0607	88-108-000-080		C-JUMPER, U	EZSM	CX-NSZ300
X	MICON	JR 0607	88-108-000-080	OE	C-JUMPER, U	LHSM	CX-NSZ300
X	MICON	JR 0607	88-108-000-080	OE	C-JUMPER, U	USM	CX-SNAJ300
X	MICON	JR 0607	88-108-000-080	OE	C-JUMPER, U	USM	CX-SNAJ305
X	MICON	JR 0609	88-108-000-080		C-JUMPER, U	LHSM	CX-NSZ300
X	MICON	JR 0609	88-108-000-080		C-JUMPER, U	USM	CX-SNAJ300
X	MICON	JR 0609	88-108-000-080		C-JUMPER, U	USM	CX-SNAJ305
X	MICON	JR 0609	88-108-000-080		C-JUMPER, U	EZSM	CX-NSZ300
X	MICON	JR 0609	88-108-000-080	OE	C-JUMPER, U	LHSM	CX-NSZ300

PARTS LIST

! = Δ SAFTY PARTS
 C = Components marked

All components used on this model at the production line are shown in this service manual.

However, please note that not all components will be available as spare parts for after-sales service.

Components marked S and O are designated as spare parts for service and will be stocked at the spare parts centers.

Components marked X and R are not designated as spare parts for after sales service, and will not be stocked at the spare parts centers.

K NO. = Only use japanese.

! C	UNIT NAME	REF NO.	PARTS CODE	K NO.	DESCRIPTION	SUFFIX	MODEL NAME
X	MICON	JR 0609	88-108-000-080	OE	C-JUMPER, U	USM	CX-SNAJ300
X	MICON	JR 0609	88-108-000-080	OE	C-JUMPER, U	USM	CX-SNAJ305
X	MICON	JR 0612	88-108-000-080		C-JUMPER, U	LHSM	CX-NSZ300
X	MICON	JR 0612	88-108-000-080		C-JUMPER, U	USM	CX-SNAJ300
X	MICON	JR 0612	88-108-000-080		C-JUMPER, U	USM	CX-SNAJ305
X	MICON	JR 0612	88-108-000-080		C-JUMPER, U	EZSM	CX-NSZ300
X	MICON	JR 0612	88-108-000-080	OE	C-JUMPER, U	LHSM	CX-NSZ300
X	MICON	JR 0612	88-108-000-080	OE	C-JUMPER, U	USM	CX-SNAJ300
X	MICON	JR 0612	88-108-000-080	OE	C-JUMPER, U	USM	CX-SNAJ305
X	MICON	JR 0616	88-108-000-080		C-JUMPER, U	LHSM	CX-NSZ300
X	MICON	JR 0616	88-108-000-080		C-JUMPER, U	USM	CX-SNAJ300
X	MICON	JR 0616	88-108-000-080		C-JUMPER, U	USM	CX-SNAJ305
X	MICON	JR 0616	88-108-000-080		C-JUMPER, U	EZSM	CX-NSZ300
X	MICON	JR 0616	88-108-000-080	OE	C-JUMPER, U	LHSM	CX-NSZ300
X	MICON	JR 0616	88-108-000-080	OE	C-JUMPER, U	USM	CX-SNAJ300
X	MICON	JR 0616	88-108-000-080	OE	C-JUMPER, U	USM	CX-SNAJ305
X	MICON	JR 0617	88-108-000-080		C-JUMPER, U	LHSM	CX-NSZ300
X	MICON	JR 0617	88-108-000-080		C-JUMPER, U	USM	CX-SNAJ300
X	MICON	JR 0617	88-108-000-080		C-JUMPER, U	USM	CX-SNAJ305
X	MICON	JR 0617	88-108-000-080		C-JUMPER, U	EZSM	CX-NSZ300
X	MICON	JR 0617	88-108-000-080	OE	C-JUMPER, U	LHSM	CX-NSZ300
X	MICON	JR 0617	88-108-000-080	OE	C-JUMPER, U	USM	CX-SNAJ300
X	MICON	JR 0617	88-108-000-080	OE	C-JUMPER, U	USM	CX-SNAJ305
X	MICON	JR 0618	88-108-000-080		C-JUMPER, U	LHSM	CX-NSZ300
X	MICON	JR 0618	88-108-000-080		C-JUMPER, U	USM	CX-SNAJ300
X	MICON	JR 0618	88-108-000-080		C-JUMPER, U	USM	CX-SNAJ305
X	MICON	JR 0618	88-108-000-080		C-JUMPER, U	EZSM	CX-NSZ300
X	MICON	JR 0618	88-108-000-080	OE	C-JUMPER, U	LHSM	CX-NSZ300
X	MICON	JR 0618	88-108-000-080	OE	C-JUMPER, U	USM	CX-SNAJ300
X	MICON	JR 0618	88-108-000-080	OE	C-JUMPER, U	USM	CX-SNAJ305
X	MICON	JR 0619	88-108-000-080		C-JUMPER, U	LHSM	CX-NSZ300
X	MICON	JR 0619	88-108-000-080		C-JUMPER, U	USM	CX-SNAJ300
X	MICON	JR 0619	88-108-000-080		C-JUMPER, U	USM	CX-SNAJ305
X	MICON	JR 0619	88-108-000-080		C-JUMPER, U	EZSM	CX-NSZ300
X	MICON	JR 0619	88-108-000-080	OE	C-JUMPER, U	LHSM	CX-NSZ300
X	MICON	JR 0619	88-108-000-080	OE	C-JUMPER, U	USM	CX-SNAJ300
X	MICON	JR 0619	88-108-000-080	OE	C-JUMPER, U	USM	CX-SNAJ305
X	MICON	JR 0621	88-108-000-080		C-JUMPER, U	LHSM	CX-NSZ300
X	MICON	JR 0621	88-108-000-080		C-JUMPER, U	USM	CX-SNAJ300
X	MICON	JR 0621	88-108-000-080		C-JUMPER, U	USM	CX-SNAJ305
X	MICON	JR 0621	88-108-000-080		C-JUMPER, U	EZSM	CX-NSZ300
X	MICON	JR 0621	88-108-000-080	OE	C-JUMPER, U	LHSM	CX-NSZ300
X	MICON	JR 0621	88-108-000-080	OE	C-JUMPER, U	USM	CX-SNAJ300
X	MICON	JR 0621	88-108-000-080	OE	C-JUMPER, U	USM	CX-SNAJ305
X	MICON	JR 0731	88-108-000-080		C-JUMPER, U	LHSM	CX-NSZ300
X	MICON	JR 0731	88-108-000-080		C-JUMPER, U	USM	CX-SNAJ300
X	MICON	JR 0731	88-108-000-080		C-JUMPER, U	USM	CX-SNAJ305
X	MICON	JR 0733	88-108-000-080		C-JUMPER, U	LHSM	CX-NSZ300
X	MICON	JR 0733	88-108-000-080		C-JUMPER, U	USM	CX-SNAJ300
X	MICON	JR 0733	88-108-000-080		C-JUMPER, U	USM	CX-SNAJ305
X	MICON	JR 0740	88-108-000-080		C-JUMPER, U	LHSM	CX-NSZ300
X	MICON	JR 0740	88-108-000-080		C-JUMPER, U	USM	CX-SNAJ300
X	MICON	JR 0740	88-108-000-080		C-JUMPER, U	USM	CX-SNAJ305
X	MICON	JR 0901	88-108-000-080		C-JUMPER, U	LHSM	CX-NSZ300
X	MICON	JR 0901	88-108-000-080		C-JUMPER, U	USM	CX-SNAJ300
X	MICON	JR 0901	88-108-000-080		C-JUMPER, U	USM	CX-SNAJ305
X	MICON	JR 0901	88-108-000-080		C-JUMPER, U	EZSM	CX-NSZ300
X	MICON	JR 0901	88-108-000-080	OE	C-JUMPER, U	LHSM	CX-NSZ300
X	MICON	JR 0901	88-108-000-080	OE	C-JUMPER, U	USM	CX-SNAJ300
X	MICON	JR 0901	88-108-000-080	OE	C-JUMPER, U	USM	CX-SNAJ305
X	MICON	JR 0902	88-108-000-080		C-JUMPER, U	LHSM	CX-NSZ300
X	MICON	JR 0902	88-108-000-080		C-JUMPER, U	USM	CX-SNAJ300
X	MICON	JR 0902	88-108-000-080		C-JUMPER, U	USM	CX-SNAJ305
X	MICON	JR 0902	88-108-000-080		C-JUMPER, U	EZSM	CX-NSZ300
X	MICON	JR 0902	88-108-000-080	OE	C-JUMPER, U	LHSM	CX-NSZ300
X	MICON	JR 0902	88-108-000-080	OE	C-JUMPER, U	USM	CX-SNAJ300
X	MICON	JR 0902	88-108-000-080	OE	C-JUMPER, U	USM	CX-SNAJ305
X	MICON	JR 0903	88-108-000-080		C-JUMPER, U	LHSM	CX-NSZ300
X	MICON	JR 0903	88-108-000-080		C-JUMPER, U	USM	CX-SNAJ300
X	MICON	JR 0903	88-108-000-080		C-JUMPER, U	USM	CX-SNAJ305

PARTS LIST

! = Δ SAFTY PARTS
 C = Components marked

All components used on this model at the production line are shown in this service manual.

However, please note that not all components will be available as spare parts for after-sales service.

Components marked S and O are designated as spare parts for service and will be stocked at the spare parts centers.

Components marked X and R are not designated as spare parts for after sales service, and will not be stocked at the spare parts centers.

K NO. = Only use japanese.

! C	UNIT NAME	REF NO.	PARTS CODE	K NO.	DESCRIPTION	SUFFIX	MODEL NAME
X	MICON	JR 0903	88-108-000-080		C-JUMPER, U	EZSM	CX-NSZ300
X	MICON	JR 0903	88-108-000-080	0E	C-JUMPER, U	LHSM	CX-NSZ300
X	MICON	JR 0903	88-108-000-080	0E	C-JUMPER, U	USM	CX-SNAJ300
X	MICON	JR 0903	88-108-000-080	0E	C-JUMPER, U	USM	CX-SNAJ305
X	MICON	JR 0904	88-129-000-080		C-JUMPER, 3216	LHSM	CX-NSZ300
X	MICON	JR 0904	88-129-000-080		C-JUMPER, 3216	USM	CX-SNAJ300
X	MICON	JR 0904	88-129-000-080		C-JUMPER, 3216	USM	CX-SNAJ305
X	MICON	JR 0904	88-129-000-080		C-JUMPER, 3216	EZSM	CX-NSZ300
X	MICON	JR 0904	88-129-000-080	0E	C-JUMPER, 3216	LHSM	CX-NSZ300
X	MICON	JR 0904	88-129-000-080	0E	C-JUMPER, 3216	USM	CX-SNAJ300
X	MICON	JR 0904	88-129-000-080	0E	C-JUMPER, 3216	USM	CX-SNAJ305
X	MICON	JR 0905	88-108-000-080		C-JUMPER, U	LHSM	CX-NSZ300
X	MICON	JR 0905	88-108-000-080		C-JUMPER, U	USM	CX-SNAJ300
X	MICON	JR 0905	88-108-000-080		C-JUMPER, U	USM	CX-SNAJ305
X	MICON	JR 0905	88-108-000-080		C-JUMPER, U	EZSM	CX-NSZ300
X	MICON	JR 0905	88-108-000-080	0E	C-JUMPER, U	LHSM	CX-NSZ300
X	MICON	JR 0905	88-108-000-080	0E	C-JUMPER, U	USM	CX-SNAJ300
X	MICON	JR 0905	88-108-000-080	0E	C-JUMPER, U	USM	CX-SNAJ305
X	MICON	JR 0906	88-108-000-080		C-JUMPER, U	LHSM	CX-NSZ300
X	MICON	JR 0906	88-108-000-080		C-JUMPER, U	USM	CX-SNAJ300
X	MICON	JR 0906	88-108-000-080		C-JUMPER, U	USM	CX-SNAJ305
X	MICON	JR 0906	88-108-000-080		C-JUMPER, U	EZSM	CX-NSZ300
X	MICON	JR 0906	88-108-000-080	0E	C-JUMPER, U	LHSM	CX-NSZ300
X	MICON	JR 0906	88-108-000-080	0E	C-JUMPER, U	USM	CX-SNAJ300
X	MICON	JR 0906	88-108-000-080	0E	C-JUMPER, U	USM	CX-SNAJ305
X	MICON	JR 0964	88-108-000-080		C-JUMPER, U	LHSM	CX-NSZ300
X	MICON	JR 0964	88-108-000-080		C-JUMPER, U	USM	CX-SNAJ300
X	MICON	JR 0964	88-108-000-080		C-JUMPER, U	USM	CX-SNAJ305
X	MICON	JR 0964	88-108-000-080		C-JUMPER, U	LHSM	CX-NSZ300
X	MICON	JR 0964	88-108-000-080		C-JUMPER, U	USM	CX-SNAJ300
X	MICON	JR 0964	88-108-000-080		C-JUMPER, U	USM	CX-SNAJ305
X	MICON	JR 0964	88-108-000-080		C-JUMPER, U	EZSM	CX-NSZ300
X	MICON	JR 0964	88-108-000-080	0E	C-JUMPER, U	LHSM	CX-NSZ300
X	MICON	JR 0964	88-108-000-080	0E	C-JUMPER, U	USM	CX-SNAJ300
X	MICON	JR 0964	88-108-000-080	0E	C-JUMPER, U	USM	CX-SNAJ305
O	MICON	L 0951	87-A50-655-010		COIL, CLK 4.19MHZ (TOKO) 7KLY	LHSM	CX-NSZ300
O	MICON	L 0951	87-A50-655-010		COIL, CLK 4.19MHZ (TOKO) 7KLY	USM	CX-SNAJ300
O	MICON	L 0951	87-A50-655-010		COIL, CLK 4.19MHZ (TOKO) 7KLY	USM	CX-SNAJ305
O	MICON	L 0951	87-A50-655-010		COIL, CLK 4.19MHZ (TOKO) 7KLY	EZSM	CX-NSZ300
O	MICON	L 0951	87-A50-655-010	0E	COIL, CLK 4.19MHZ (TOKO) 7KLY	LHSM	CX-NSZ300
O	MICON	L 0951	87-A50-655-010	0E	COIL, CLK 4.19MHZ (TOKO) 7KLY	USM	CX-SNAJ300
O	MICON	L 0951	87-A50-655-010	0E	COIL, CLK 4.19MHZ (TOKO) 7KLY	USM	CX-SNAJ305
O	MICON	L 0951	87-A50-655-010	0E	COIL, CLK 4.19MHZ (TOKO) 7KLY	LHSM	CX-NSZ300
O	MICON	LED0209	87-A40-317-080		LED, SLR-342VCT31 RED	USM	CX-SNAJ300
O	MICON	LED0209	87-A40-317-080		LED, SLR-342VCT31 RED	USM	CX-SNAJ305
O	MICON	LED0209	87-A41-062-040		LED, LTL-1CHEE-012A RED	EZSM	CX-NSZ300
O	MICON	LED0209	87-A41-062-040	0E	LED, LTL-1CHEE-012A RED	LHSM	CX-NSZ300
O	MICON	LED0209	87-A41-062-040	0E	LED, LTL-1CHEE-012A RED	USM	CX-SNAJ300
O	MICON	LED0209	87-A41-062-040	0E	LED, LTL-1CHEE-012A RED	USM	CX-SNAJ305
S	MICON	Q 0102	87-A30-076-080		C-TR, 2SC3052F	LHSM	CX-NSZ300
S	MICON	Q 0102	87-A30-076-080		C-TR, 2SC3052F	USM	CX-SNAJ300
S	MICON	Q 0102	87-A30-076-080	0E	C-TR, 2SC3052F	USM	CX-SNAJ305
S	MICON	Q 0103	87-A30-074-080		C-TR, RT1P 141C	LHSM	CX-NSZ300
S	MICON	Q 0103	87-A30-074-080		C-TR, RT1P 141C	USM	CX-SNAJ300
S	MICON	Q 0103	87-A30-074-080		C-TR, RT1P 141C	USM	CX-SNAJ305
S	MICON	Q 0103	87-A30-074-080		C-TR, RT1P 141C	EZSM	CX-NSZ300
S	MICON	Q 0103	87-A30-074-080	0E	C-TR, RT1P 141C	LHSM	CX-NSZ300
S	MICON	Q 0103	87-A30-074-080	0E	C-TR, RT1P 141C	USM	CX-SNAJ300
S	MICON	Q 0103	87-A30-074-080	0E	C-TR, RT1P 141C	USM	CX-SNAJ305
S	MICON	Q 0104	87-A30-074-080		C-TR, RT1P 141C	LHSM	CX-NSZ300
S	MICON	Q 0104	87-A30-074-080		C-TR, RT1P 141C	USM	CX-SNAJ300
S	MICON	Q 0104	87-A30-074-080		C-TR, RT1P 141C	USM	CX-SNAJ305
S	MICON	Q 0104	87-A30-074-080		C-TR, RT1P 141C	EZSM	CX-NSZ300
S	MICON	Q 0104	87-A30-074-080	0E	C-TR, RT1P 141C	LHSM	CX-NSZ300
S	MICON	Q 0104	87-A30-074-080	0E	C-TR, RT1P 141C	USM	CX-SNAJ300
S	MICON	Q 0104	87-A30-074-080	0E	C-TR, RT1P 141C	USM	CX-SNAJ305
S	MICON	Q 0105	87-A30-468-080		C-TR, KRC102S-RTK	LHSM	CX-NSZ300
S	MICON	Q 0105	87-A30-468-080		C-TR, KRC102S-RTK	USM	CX-SNAJ300
S	MICON	Q 0105	87-A30-468-080		C-TR, KRC102S-RTK	USM	CX-SNAJ305

PARTS LIST

! = Δ SAFTY PARTS
 C = Components marked

All components used on this model at the production line are shown in this service manual.

However, please note that not all components will be available as spare parts for after-sales service.

Components marked S and O are designated as spare parts for service and will be stocked at the spare parts centers.

Components marked X and R are not designated as spare parts for after sales service, and will not be stocked at the spare parts centers.

K NO. = Only use japanese.

! C	UNIT NAME	REF NO.	PARTS CODE	K NO.	DESCRIPTION	SUFFIX	MODEL NAME
S	MICON	Q	0105 87-A30-468-080		C-TR, KRC102S-RTK	EZSM	CX-NSZ300
S	MICON	Q	0105 87-A30-468-080	OE	C-TR, KRC102S-RTK	LHSM	CX-NSZ300
S	MICON	Q	0105 87-A30-468-080	OE	C-TR, KRC102S-RTK	USM	CX-SNAJ300
S	MICON	Q	0105 87-A30-468-080	OE	C-TR, KRC102S-RTK	USM	CX-SNAJ305
S	MICON	Q	0301 87-A30-494-080		TR, 2SA1980G	LHSM	CX-NSZ300
S	MICON	Q	0301 87-A30-494-080		TR, 2SA1980G	USM	CX-SNAJ300
S	MICON	Q	0301 87-A30-494-080		TR, 2SA1980G	USM	CX-SNAJ305
S	MICON	Q	0301 87-A30-494-080		TR, 2SA1980G	EZSM	CX-NSZ300
S	MICON	Q	0301 87-A30-494-080	OE	TR, 2SA1980G	LHSM	CX-NSZ300
S	MICON	Q	0301 87-A30-494-080	OE	TR, 2SA1980G	USM	CX-SNAJ300
S	MICON	Q	0301 87-A30-494-080	OE	TR, 2SA1980G	USM	CX-SNAJ305
S	MICON	Q	0302 87-A30-076-080		C-TR, 2SC3052F	LHSM	CX-NSZ300
S	MICON	Q	0302 87-A30-076-080		C-TR, 2SC3052F	USM	CX-SNAJ300
S	MICON	Q	0302 87-A30-076-080		C-TR, 2SC3052F	USM	CX-SNAJ305
S	MICON	Q	0302 87-A30-076-080		C-TR, 2SC3052F	EZSM	CX-NSZ300
S	MICON	Q	0302 87-A30-076-080	OE	C-TR, 2SC3052F	LHSM	CX-NSZ300
S	MICON	Q	0302 87-A30-076-080	OE	C-TR, 2SC3052F	USM	CX-SNAJ300
S	MICON	Q	0302 87-A30-076-080	OE	C-TR, 2SC3052F	USM	CX-SNAJ305
S	MICON	Q	0303 87-A30-076-080		C-TR, 2SC3052F	LHSM	CX-NSZ300
S	MICON	Q	0303 87-A30-076-080		C-TR, 2SC3052F	USM	CX-SNAJ300
S	MICON	Q	0303 87-A30-076-080		C-TR, 2SC3052F	USM	CX-SNAJ305
S	MICON	Q	0303 87-A30-076-080		C-TR, 2SC3052F	EZSM	CX-NSZ300
S	MICON	Q	0303 87-A30-076-080	OE	C-TR, 2SC3052F	LHSM	CX-NSZ300
S	MICON	Q	0303 87-A30-076-080	OE	C-TR, 2SC3052F	USM	CX-SNAJ300
S	MICON	Q	0303 87-A30-076-080	OE	C-TR, 2SC3052F	USM	CX-SNAJ305
S	MICON	Q	0601 87-A30-495-080		TR, 2SA1981Y	LHSM	CX-NSZ300
S	MICON	Q	0601 87-A30-495-080		TR, 2SA1981Y	USM	CX-SNAJ300
S	MICON	Q	0601 87-A30-495-080		TR, 2SA1981Y	USM	CX-SNAJ305
S	MICON	Q	0601 87-A30-495-080		TR, 2SA1981Y	EZSM	CX-NSZ300
S	MICON	Q	0601 87-A30-495-080	OE	TR, 2SA1981Y	LHSM	CX-NSZ300
S	MICON	Q	0601 87-A30-495-080	OE	TR, 2SA1981Y	USM	CX-SNAJ300
S	MICON	Q	0601 87-A30-495-080	OE	TR, 2SA1981Y	USM	CX-SNAJ305
S	MICON	Q	0602 87-A30-495-080		TR, 2SA1981Y	LHSM	CX-NSZ300
S	MICON	Q	0602 87-A30-495-080		TR, 2SA1981Y	USM	CX-SNAJ300
S	MICON	Q	0602 87-A30-495-080		TR, 2SA1981Y	USM	CX-SNAJ305
S	MICON	Q	0602 87-A30-495-080		TR, 2SA1981Y	USM	CX-SNAJ300
S	MICON	Q	0602 87-A30-495-080	OE	TR, 2SA1981Y	LHSM	CX-NSZ300
S	MICON	Q	0602 87-A30-495-080	OE	TR, 2SA1981Y	USM	CX-SNAJ300
S	MICON	Q	0602 87-A30-495-080	OE	TR, 2SA1981Y	USM	CX-SNAJ305
S	MICON	Q	0603 87-A30-582-080		TR, CDA1585BC	LHSM	CX-NSZ300
S	MICON	Q	0603 87-A30-582-080		TR, CDA1585BC	USM	CX-SNAJ300
S	MICON	Q	0603 87-A30-582-080		TR, CDA1585BC	USM	CX-SNAJ305
S	MICON	Q	0603 87-A30-582-080		TR, CDA1585BC	EZSM	CX-NSZ300
S	MICON	Q	0603 87-A30-582-080	OE	TR, CDA1585BC	LHSM	CX-NSZ300
S	MICON	Q	0603 87-A30-582-080	OE	TR, CDA1585BC	USM	CX-SNAJ300
S	MICON	Q	0603 87-A30-582-080	OE	TR, CDA1585BC	USM	CX-SNAJ305
S	MICON	Q	0801 87-A30-076-080		C-TR, 2SC3052F	LHSM	CX-NSZ300
S	MICON	Q	0801 87-A30-076-080		C-TR, 2SC3052F	USM	CX-SNAJ300
S	MICON	Q	0801 87-A30-076-080		C-TR, 2SC3052F	USM	CX-SNAJ305
S	MICON	Q	0801 87-A30-076-080		C-TR, 2SC3052F	EZSM	CX-NSZ300
S	MICON	Q	0801 87-A30-076-080	OE	C-TR, 2SC3052F	LHSM	CX-NSZ300
S	MICON	Q	0801 87-A30-076-080	OE	C-TR, 2SC3052F	USM	CX-SNAJ300
S	MICON	Q	0801 87-A30-076-080	OE	C-TR, 2SC3052F	USM	CX-SNAJ305
S	MICON	Q	0802 87-A30-075-080		C-TR, 2SA1235F	LHSM	CX-NSZ300
S	MICON	Q	0802 87-A30-075-080		C-TR, 2SA1235F	USM	CX-SNAJ300
S	MICON	Q	0802 87-A30-075-080		C-TR, 2SA1235F	USM	CX-SNAJ305
S	MICON	Q	0802 87-A30-075-080		C-TR, 2SA1235F	EZSM	CX-NSZ300
S	MICON	Q	0802 87-A30-075-080	OE	C-TR, 2SA1235F	LHSM	CX-NSZ300
S	MICON	Q	0802 87-A30-075-080	OE	C-TR, 2SA1235F	USM	CX-SNAJ300
S	MICON	Q	0802 87-A30-075-080	OE	C-TR, 2SA1235F	USM	CX-SNAJ305
S	MICON	Q	0803 87-A30-076-080		C-TR, 2SC3052F	LHSM	CX-NSZ300
S	MICON	Q	0803 87-A30-076-080		C-TR, 2SC3052F	USM	CX-SNAJ300
S	MICON	Q	0803 87-A30-076-080		C-TR, 2SC3052F	USM	CX-SNAJ305
S	MICON	Q	0803 87-A30-288-040		C-TR, DTC114YKA	EZSM	CX-NSZ300
S	MICON	Q	0803 87-A30-288-040	OE	C-TR, DTC114YKA	LHSM	CX-NSZ300
S	MICON	Q	0803 87-A30-288-040	OE	C-TR, DTC114YKA	USM	CX-SNAJ300
S	MICON	Q	0803 87-A30-288-040	OE	C-TR, DTC114YKA	USM	CX-SNAJ305
S	MICON	Q	0804 87-A30-076-080		C-TR, 2SC3052F	LHSM	CX-NSZ300
S	MICON	Q	0804 87-A30-076-080		C-TR, 2SC3052F	USM	CX-SNAJ300
S	MICON	Q	0804 87-A30-076-080		C-TR, 2SC3052F	USM	CX-SNAJ305

PARTS LIST

! = Δ SAFTY PARTS
 C = Components marked

All components used on this model at the production line are shown in this service manual.

However, please note that not all components will be available as spare parts for after-sales service.

Components marked S and O are designated as spare parts for service and will be stocked at the spare parts centers.

Components marked X and R are not designated as spare parts for after sales service, and will not be stocked at the spare parts centers.

K NO. = Only use japanese.

! C	UNIT NAME	REF NO.	PARTS CODE	K NO.	DESCRIPTION	SUFFIX	MODEL NAME
S	MICON	Q	0804 87-A30-288-040		C-TR, DTC114YKA	EZSM	CX-NSZ300
S	MICON	Q	0804 87-A30-288-040	OE	C-TR, DTC114YKA	LHSM	CX-NSZ300
S	MICON	Q	0804 87-A30-288-040	OE	C-TR, DTC114YKA	USM	CX-SNAJ300
S	MICON	Q	0804 87-A30-288-040	OE	C-TR, DTC114YKA	USM	CX-SNAJ305
S	MICON	Q	0805 87-A30-076-080		C-TR, 2SC3052F	LHSM	CX-NSZ300
S	MICON	Q	0805 87-A30-076-080		C-TR, 2SC3052F	USM	CX-SNAJ300
S	MICON	Q	0805 87-A30-076-080		C-TR, 2SC3052F	USM	CX-SNAJ305
S	MICON	Q	0805 87-A30-288-040		C-TR, DTC114YKA	EZSM	CX-NSZ300
S	MICON	Q	0805 87-A30-288-040	OE	C-TR, DTC114YKA	LHSM	CX-NSZ300
S	MICON	Q	0805 87-A30-288-040	OE	C-TR, DTC114YKA	USM	CX-SNAJ300
S	MICON	Q	0805 87-A30-288-040	OE	C-TR, DTC114YKA	USM	CX-SNAJ305
S	MICON	Q	0901 87-A30-074-080		C-TR, RT1P 141C	LHSM	CX-NSZ300
S	MICON	Q	0901 87-A30-074-080		C-TR, RT1P 141C	USM	CX-SNAJ300
S	MICON	Q	0901 87-A30-074-080		C-TR, RT1P 141C	USM	CX-SNAJ305
S	MICON	Q	0901 87-A30-074-080		C-TR, RT1P 141C	USM	CX-SNAJ305
S	MICON	Q	0901 87-A30-074-080	OE	C-TR, RT1P 141C	LHSM	CX-NSZ300
S	MICON	Q	0901 87-A30-074-080	OE	C-TR, RT1P 141C	USM	CX-SNAJ300
S	MICON	Q	0901 87-A30-074-080	OE	C-TR, RT1P 141C	USM	CX-SNAJ305
X	MICON	R	0109 88-108-224-080		C-RES, U 220K-1/16W J	LHSM	CX-NSZ300
X	MICON	R	0109 88-108-224-080		C-RES, U 220K-1/16W J	USM	CX-SNAJ300
X	MICON	R	0109 88-108-224-080		C-RES, U 220K-1/16W J	USM	CX-SNAJ305
X	MICON	R	0109 88-108-224-080		C-RES, U 220K-1/16W J	EZSM	CX-NSZ300
X	MICON	R	0109 88-108-224-080	OE	C-RES, U 220K-1/16W J	LHSM	CX-NSZ300
X	MICON	R	0109 88-108-224-080	OE	C-RES, U 220K-1/16W J	USM	CX-SNAJ300
X	MICON	R	0109 88-108-224-080	OE	C-RES, U 220K-1/16W J	USM	CX-SNAJ305
X	MICON	R	0110 88-108-153-080		C-RES, U 15K-1/16W J	LHSM	CX-NSZ300
X	MICON	R	0110 88-108-153-080		C-RES, U 15K-1/16W J	USM	CX-SNAJ300
X	MICON	R	0110 88-108-153-080		C-RES, U 15K-1/16W J	USM	CX-SNAJ305
X	MICON	R	0110 88-108-153-080		C-RES, U 15K-1/16W J	EZSM	CX-NSZ300
X	MICON	R	0110 88-108-153-080	OE	C-RES, U 15K-1/16W J	LHSM	CX-NSZ300
X	MICON	R	0110 88-108-153-080	OE	C-RES, U 15K-1/16W J	USM	CX-SNAJ300
X	MICON	R	0110 88-108-153-080	OE	C-RES, U 15K-1/16W J	USM	CX-SNAJ305
X	MICON	R	0111 88-108-333-080		C-RES, U 33K-1/16W J	LHSM	CX-NSZ300
X	MICON	R	0111 88-108-333-080		C-RES, U 33K-1/16W J	USM	CX-SNAJ300
X	MICON	R	0111 88-108-333-080		C-RES, U 33K-1/16W J	USM	CX-SNAJ305
X	MICON	R	0111 88-108-333-080		C-RES, U 33K-1/16W J	EZSM	CX-NSZ300
X	MICON	R	0111 88-108-333-080	OE	C-RES, U 33K-1/16W J	LHSM	CX-NSZ300
X	MICON	R	0111 88-108-333-080	OE	C-RES, U 33K-1/16W J	USM	CX-SNAJ300
X	MICON	R	0111 88-108-333-080	OE	C-RES, U 33K-1/16W J	USM	CX-SNAJ305
X	MICON	R	0112 88-108-224-080		C-RES, U 220K-1/16W J	LHSM	CX-NSZ300
X	MICON	R	0112 88-108-224-080		C-RES, U 220K-1/16W J	USM	CX-SNAJ300
X	MICON	R	0112 88-108-224-080		C-RES, U 220K-1/16W J	USM	CX-SNAJ305
X	MICON	R	0112 88-108-224-080		C-RES, U 220K-1/16W J	EZSM	CX-NSZ300
X	MICON	R	0112 88-108-224-080	OE	C-RES, U 220K-1/16W J	LHSM	CX-NSZ300
X	MICON	R	0112 88-108-224-080	OE	C-RES, U 220K-1/16W J	USM	CX-SNAJ300
X	MICON	R	0112 88-108-224-080	OE	C-RES, U 220K-1/16W J	USM	CX-SNAJ305
X	MICON	R	0114 88-108-103-080		C-RES, U 10K-1/16W J	LHSM	CX-NSZ300
X	MICON	R	0114 88-108-103-080		C-RES, U 10K-1/16W J	USM	CX-SNAJ300
X	MICON	R	0114 88-108-103-080		C-RES, U 10K-1/16W J	USM	CX-SNAJ305
X	MICON	R	0114 88-108-103-080		C-RES, U 10K-1/16W J	EZSM	CX-NSZ300
X	MICON	R	0114 88-108-103-080	OE	C-RES, U 10K-1/16W J	LHSM	CX-NSZ300
X	MICON	R	0114 88-108-103-080	OE	C-RES, U 10K-1/16W J	USM	CX-SNAJ300
X	MICON	R	0114 88-108-103-080	OE	C-RES, U 10K-1/16W J	USM	CX-SNAJ305
X	MICON	R	0115 88-108-103-080		C-RES, U 10K-1/16W J	EZSM	CX-NSZ300
X	MICON	R	0115 88-108-103-080	OE	C-RES, U 10K-1/16W J	LHSM	CX-NSZ300
X	MICON	R	0115 88-108-103-080	OE	C-RES, U 10K-1/16W J	USM	CX-SNAJ300
X	MICON	R	0115 88-108-103-080	OE	C-RES, U 10K-1/16W J	USM	CX-SNAJ305
X	MICON	R	0116 88-108-104-080		C-RES, U 100K-1/16W J	EZSM	CX-NSZ300
X	MICON	R	0116 88-108-104-080	OE	C-RES, U 100K-1/16W J	LHSM	CX-NSZ300
X	MICON	R	0116 88-108-104-080	OE	C-RES, U 100K-1/16W J	USM	CX-SNAJ300
X	MICON	R	0116 88-108-104-080	OE	C-RES, U 100K-1/16W J	USM	CX-SNAJ305
X	MICON	R	0151 88-100-000-010		PLATING-JW, 0.58 SN95	LHSM	CX-NSZ300
X	MICON	R	0151 88-100-000-010		PLATING-JW, 0.58 SN95	USM	CX-SNAJ300
X	MICON	R	0151 88-100-000-010		PLATING-JW, 0.58 SN95	USM	CX-SNAJ305
X	MICON	R	0151 88-100-000-010		PLATING-JW, 0.58 SN95	EZSM	CX-NSZ300
X	MICON	R	0151 88-100-000-010	OE	PLATING-JW, 0.58 SN95	LHSM	CX-NSZ300
X	MICON	R	0151 88-100-000-010	OE	PLATING-JW, 0.58 SN95	USM	CX-SNAJ300
X	MICON	R	0151 88-100-000-010	OE	PLATING-JW, 0.58 SN95	USM	CX-SNAJ305
X	MICON	R	0152 88-100-000-010		PLATING-JW, 0.58 SN95	LHSM	CX-NSZ300
X	MICON	R	0152 88-100-000-010		PLATING-JW, 0.58 SN95	USM	CX-SNAJ300

PARTS LIST

! = Δ SAFTY PARTS
 C = Components marked

All components used on this model at the production line are shown in this service manual.

However, please note that not all components will be available as spare parts for after-sales service.

Components marked S and O are designated as spare parts for service and will be stocked at the spare parts centers.

Components marked X and R are not designated as spare parts for after sales service, and will not be stocked at the spare parts centers.

K NO. = Only use japanese.

! C	UNIT NAME	REF NO.	PARTS CODE	K NO.	DESCRIPTION	SUFFIX	MODEL NAME
X	MICON	R	0152 88-100-000-010		PLATING-JW, 0.58 SN95	USM	CX-SNAJ305
X	MICON	R	0152 88-100-000-010		PLATING-JW, 0.58 SN95	EZSM	CX-NSZ300
X	MICON	R	0152 88-100-000-010	OE	PLATING-JW, 0.58 SN95	LHSM	CX-NSZ300
X	MICON	R	0152 88-100-000-010	OE	PLATING-JW, 0.58 SN95	USM	CX-SNAJ300
X	MICON	R	0152 88-100-000-010	OE	PLATING-JW, 0.58 SN95	USM	CX-SNAJ305
X	MICON	R	0153 88-128-681-080		C-RES, 680-1/8W J	LHSM	CX-NSZ300
X	MICON	R	0153 88-128-681-080		C-RES, 680-1/8W J	USM	CX-SNAJ300
X	MICON	R	0153 88-128-681-080		C-RES, 680-1/8W J	USM	CX-SNAJ305
X	MICON	R	0153 88-128-821-080		C-RES, 820-1/8W J	EZSM	CX-NSZ300
X	MICON	R	0153 88-128-821-080	OE	C-RES, 820-1/8W J	LHSM	CX-NSZ300
X	MICON	R	0153 88-128-821-080	OE	C-RES, 820-1/8W J	USM	CX-SNAJ300
X	MICON	R	0153 88-128-821-080	OE	C-RES, 820-1/8W J	USM	CX-SNAJ305
X	MICON	R	0155 88-108-332-080		C-RES,U 3.3K-1/16W J	EZSM	CX-NSZ300
X	MICON	R	0155 88-108-332-080	OE	C-RES,U 3.3K-1/16W J	LHSM	CX-NSZ300
X	MICON	R	0155 88-108-332-080	OE	C-RES,U 3.3K-1/16W J	USM	CX-SNAJ300
X	MICON	R	0155 88-108-332-080	OE	C-RES,U 3.3K-1/16W J	USM	CX-SNAJ305
X	MICON	R	0155 88-108-472-080		C-RES,U 4.7K-1/16W J	LHSM	CX-NSZ300
X	MICON	R	0155 88-108-472-080		C-RES,U 4.7K-1/16W J	USM	CX-SNAJ300
X	MICON	R	0155 88-108-472-080		C-RES,U 4.7K-1/16W J	USM	CX-SNAJ305
X	MICON	R	0156 88-108-332-080		C-RES,U 3.3K-1/16W J	EZSM	CX-NSZ300
X	MICON	R	0156 88-108-332-080	OE	C-RES,U 3.3K-1/16W J	LHSM	CX-NSZ300
X	MICON	R	0156 88-108-332-080	OE	C-RES,U 3.3K-1/16W J	USM	CX-SNAJ300
X	MICON	R	0156 88-108-332-080	OE	C-RES,U 3.3K-1/16W J	USM	CX-SNAJ305
X	MICON	R	0156 88-108-472-080		C-RES,U 4.7K-1/16W J	LHSM	CX-NSZ300
X	MICON	R	0156 88-108-472-080		C-RES,U 4.7K-1/16W J	USM	CX-SNAJ300
X	MICON	R	0156 88-108-472-080		C-RES,U 4.7K-1/16W J	USM	CX-SNAJ305
X	MICON	R	0208 88-121-102-080		RES,1K-1/8W J	USM	CX-SNAJ300
X	MICON	R	0208 88-121-102-080		RES,1K-1/8W J	USM	CX-SNAJ305
X	MICON	R	0208 88-121-332-080		RES,3.3K-1/8W J	LHSM	CX-NSZ300
X	MICON	R	0208 88-121-332-080		RES,3.3K-1/8W J	EZSM	CX-NSZ300
X	MICON	R	0208 88-121-332-080	OE	RES,3.3K-1/8W J	LHSM	CX-NSZ300
X	MICON	R	0208 88-121-332-080	OE	RES,3.3K-1/8W J	USM	CX-SNAJ300
X	MICON	R	0208 88-121-332-080	OE	RES,3.3K-1/8W J	USM	CX-SNAJ305
X	MICON	R	0301 88-108-104-080		C-RES,U 100K-1/16W J	LHSM	CX-NSZ300
X	MICON	R	0301 88-108-104-080		C-RES,U 100K-1/16W J	USM	CX-SNAJ300
X	MICON	R	0301 88-108-104-080		C-RES,U 100K-1/16W J	USM	CX-SNAJ305
X	MICON	R	0301 88-108-104-080		C-RES,U 100K-1/16W J	EZSM	CX-NSZ300
X	MICON	R	0301 88-108-104-080	OE	C-RES,U 100K-1/16W J	LHSM	CX-NSZ300
X	MICON	R	0301 88-108-104-080	OE	C-RES,U 100K-1/16W J	USM	CX-SNAJ300
X	MICON	R	0301 88-108-104-080	OE	C-RES,U 100K-1/16W J	USM	CX-SNAJ305
X	MICON	R	0302 88-108-472-080		C-RES,U 4.7K-1/16W J	LHSM	CX-NSZ300
X	MICON	R	0302 88-108-472-080		C-RES,U 4.7K-1/16W J	USM	CX-SNAJ300
X	MICON	R	0302 88-108-472-080		C-RES,U 4.7K-1/16W J	USM	CX-SNAJ305
X	MICON	R	0302 88-108-472-080		C-RES,U 4.7K-1/16W J	EZSM	CX-NSZ300
X	MICON	R	0302 88-108-472-080	OE	C-RES,U 4.7K-1/16W J	LHSM	CX-NSZ300
X	MICON	R	0302 88-108-472-080	OE	C-RES,U 4.7K-1/16W J	USM	CX-SNAJ300
X	MICON	R	0303 88-108-153-080		C-RES,U 15K-1/16W J	LHSM	CX-NSZ300
X	MICON	R	0303 88-108-153-080		C-RES,U 15K-1/16W J	USM	CX-SNAJ300
X	MICON	R	0303 88-108-153-080		C-RES,U 15K-1/16W J	USM	CX-SNAJ305
X	MICON	R	0303 88-108-153-080		C-RES,U 15K-1/16W J	EZSM	CX-NSZ300
X	MICON	R	0303 88-108-153-080	OE	C-RES,U 15K-1/16W J	LHSM	CX-NSZ300
X	MICON	R	0303 88-108-153-080	OE	C-RES,U 15K-1/16W J	USM	CX-SNAJ300
X	MICON	R	0303 88-108-153-080	OE	C-RES,U 15K-1/16W J	USM	CX-SNAJ305
X	MICON	R	0304 88-108-102-080		C-RES,U 1K-1/16W J	LHSM	CX-NSZ300
X	MICON	R	0304 88-108-102-080		C-RES,U 1K-1/16W J	USM	CX-SNAJ300
X	MICON	R	0304 88-108-102-080		C-RES,U 1K-1/16W J	USM	CX-SNAJ305
X	MICON	R	0304 88-108-102-080		C-RES,U 1K-1/16W J	EZSM	CX-NSZ300
X	MICON	R	0304 88-108-102-080	OE	C-RES,U 1K-1/16W J	LHSM	CX-NSZ300
X	MICON	R	0304 88-108-102-080	OE	C-RES,U 1K-1/16W J	USM	CX-SNAJ300
X	MICON	R	0304 88-108-102-080	OE	C-RES,U 1K-1/16W J	USM	CX-SNAJ305
X	MICON	R	0306 88-108-471-080		C-RES,U 470-1/16W J	LHSM	CX-NSZ300
X	MICON	R	0306 88-108-471-080		C-RES,U 470-1/16W J	USM	CX-SNAJ300

PARTS LIST

! = Δ SAFTY PARTS
 C = Components marked

All components used on this model at the production line are shown in this service manual.

However, please note that not all components will be available as spare parts for after-sales service.

Components marked S and O are designated as spare parts for service and will be stocked at the spare parts centers.

Components marked X and R are not designated as spare parts for after sales service, and will not be stocked at the spare parts centers.

K NO. = Only use japanese.

! C	UNIT NAME	REF NO.	PARTS CODE	K NO.	DESCRIPTION	SUFFIX	MODEL NAME
X	MICON	R	0306 88-108-471-080		C-RES,U 470-1/16W J	USM	CX-SNAJ305
X	MICON	R	0306 88-108-471-080		C-RES,U 470-1/16W J	EZSM	CX-NSZ300
X	MICON	R	0306 88-108-471-080	OE	C-RES,U 470-1/16W J	LHSM	CX-NSZ300
X	MICON	R	0306 88-108-471-080	OE	C-RES,U 470-1/16W J	USM	CX-SNAJ300
X	MICON	R	0306 88-108-471-080	OE	C-RES,U 470-1/16W J	USM	CX-SNAJ305
X	MICON	R	0321 88-108-103-080		C-RES,U 10K-1/16W J	LHSM	CX-NSZ300
X	MICON	R	0321 88-108-103-080		C-RES,U 10K-1/16W J	USM	CX-SNAJ300
X	MICON	R	0321 88-108-103-080		C-RES,U 10K-1/16W J	USM	CX-SNAJ305
X	MICON	R	0321 88-108-103-080		C-RES,U 10K-1/16W J	EZSM	CX-NSZ300
X	MICON	R	0321 88-108-103-080	OE	C-RES,U 10K-1/16W J	LHSM	CX-NSZ300
X	MICON	R	0321 88-108-103-080	OE	C-RES,U 10K-1/16W J	USM	CX-SNAJ300
X	MICON	R	0322 88-108-102-080		C-RES,U 1K-1/16W J	LHSM	CX-NSZ300
X	MICON	R	0322 88-108-102-080		C-RES,U 1K-1/16W J	USM	CX-SNAJ300
X	MICON	R	0322 88-108-102-080		C-RES,U 1K-1/16W J	USM	CX-SNAJ305
X	MICON	R	0322 88-108-102-080		C-RES,U 1K-1/16W J	EZSM	CX-NSZ300
X	MICON	R	0322 88-108-102-080	OE	C-RES,U 1K-1/16W J	LHSM	CX-NSZ300
X	MICON	R	0322 88-108-102-080	OE	C-RES,U 1K-1/16W J	USM	CX-SNAJ300
X	MICON	R	0322 88-108-102-080	OE	C-RES,U 1K-1/16W J	USM	CX-SNAJ305
X	MICON	R	0323 88-108-821-080		C-RES,U 820-1/16W J	LHSM	CX-NSZ300
X	MICON	R	0323 88-108-821-080		C-RES,U 820-1/16W J	USM	CX-SNAJ300
X	MICON	R	0323 88-108-821-080		C-RES,U 820-1/16W J	USM	CX-SNAJ305
X	MICON	R	0323 88-108-821-080	OE	C-RES,U 820-1/16W J	EZSM	CX-NSZ300
X	MICON	R	0323 88-108-821-080	OE	C-RES,U 820-1/16W J	LHSM	CX-NSZ300
X	MICON	R	0323 88-108-821-080	OE	C-RES,U 820-1/16W J	USM	CX-SNAJ300
X	MICON	R	0323 88-108-821-080	OE	C-RES,U 820-1/16W J	USM	CX-SNAJ305
X	MICON	R	0324 88-108-122-080		C-RES,U 1.2K-1/16W J	LHSM	CX-NSZ300
X	MICON	R	0324 88-108-122-080		C-RES,U 1.2K-1/16W J	USM	CX-SNAJ300
X	MICON	R	0324 88-108-122-080		C-RES,U 1.2K-1/16W J	USM	CX-SNAJ305
X	MICON	R	0324 88-108-122-080		C-RES,U 1.2K-1/16W J	EZSM	CX-NSZ300
X	MICON	R	0324 88-108-122-080	OE	C-RES,U 1.2K-1/16W J	LHSM	CX-NSZ300
X	MICON	R	0324 88-108-122-080	OE	C-RES,U 1.2K-1/16W J	USM	CX-SNAJ300
X	MICON	R	0324 88-108-122-080	OE	C-RES,U 1.2K-1/16W J	USM	CX-SNAJ305
X	MICON	R	0325 88-108-122-080		C-RES,U 1.2K-1/16W J	LHSM	CX-NSZ300
X	MICON	R	0325 88-108-122-080		C-RES,U 1.2K-1/16W J	USM	CX-SNAJ300
X	MICON	R	0325 88-108-122-080		C-RES,U 1.2K-1/16W J	USM	CX-SNAJ305
X	MICON	R	0325 88-108-122-080		C-RES,U 1.2K-1/16W J	LHSM	CX-NSZ300
X	MICON	R	0325 88-108-122-080		C-RES,U 1.2K-1/16W J	USM	CX-SNAJ300
X	MICON	R	0325 88-108-122-080		C-RES,U 1.2K-1/16W J	USM	CX-SNAJ305
X	MICON	R	0325 88-108-122-080	OE	C-RES,U 1.2K-1/16W J	LHSM	CX-NSZ300
X	MICON	R	0325 88-108-122-080	OE	C-RES,U 1.2K-1/16W J	USM	CX-SNAJ300
X	MICON	R	0325 88-108-122-080	OE	C-RES,U 1.2K-1/16W J	USM	CX-SNAJ305
X	MICON	R	0326 88-108-122-080		C-RES,U 1.2K-1/16W J	LHSM	CX-NSZ300
X	MICON	R	0326 88-108-122-080		C-RES,U 1.2K-1/16W J	USM	CX-SNAJ300
X	MICON	R	0326 88-108-122-080		C-RES,U 1.2K-1/16W J	USM	CX-SNAJ305
X	MICON	R	0326 88-108-122-080		C-RES,U 1.2K-1/16W J	EZSM	CX-NSZ300
X	MICON	R	0326 88-108-122-080	OE	C-RES,U 1.2K-1/16W J	LHSM	CX-NSZ300
X	MICON	R	0326 88-108-122-080	OE	C-RES,U 1.2K-1/16W J	USM	CX-SNAJ300
X	MICON	R	0326 88-108-122-080	OE	C-RES,U 1.2K-1/16W J	USM	CX-SNAJ305
X	MICON	R	0327 88-108-182-080		C-RES,U 1.8K-1/16W J	LHSM	CX-NSZ300
X	MICON	R	0327 88-108-182-080		C-RES,U 1.8K-1/16W J	USM	CX-SNAJ300
X	MICON	R	0327 88-108-182-080		C-RES,U 1.8K-1/16W J	USM	CX-SNAJ305
X	MICON	R	0327 88-108-182-080		C-RES,U 1.8K-1/16W J	EZSM	CX-NSZ300
X	MICON	R	0327 88-108-182-080	OE	C-RES,U 1.8K-1/16W J	LHSM	CX-NSZ300
X	MICON	R	0327 88-108-182-080	OE	C-RES,U 1.8K-1/16W J	USM	CX-SNAJ300
X	MICON	R	0327 88-108-182-080	OE	C-RES,U 1.8K-1/16W J	USM	CX-SNAJ305
X	MICON	R	0328 88-108-182-080		C-RES,U 1.8K-1/16W J	LHSM	CX-NSZ300
X	MICON	R	0328 88-108-182-080		C-RES,U 1.8K-1/16W J	USM	CX-SNAJ300
X	MICON	R	0328 88-108-182-080		C-RES,U 1.8K-1/16W J	USM	CX-SNAJ305
X	MICON	R	0328 88-108-182-080		C-RES,U 1.8K-1/16W J	EZSM	CX-NSZ300
X	MICON	R	0328 88-108-182-080	OE	C-RES,U 1.8K-1/16W J	LHSM	CX-NSZ300
X	MICON	R	0328 88-108-182-080	OE	C-RES,U 1.8K-1/16W J	USM	CX-SNAJ300
X	MICON	R	0328 88-108-182-080	OE	C-RES,U 1.8K-1/16W J	USM	CX-SNAJ305
X	MICON	R	0329 88-108-182-080	OE	C-RES,U 1.8K-1/16W J	USM	CX-SNAJ305
X	MICON	R	0329 88-121-272-080		RES,2.7K-1/8W J	LHSM	CX-NSZ300
X	MICON	R	0329 88-121-272-080		RES,2.7K-1/8W J	USM	CX-SNAJ300
X	MICON	R	0329 88-121-272-080		RES,2.7K-1/8W J	USM	CX-SNAJ305
X	MICON	R	0329 88-121-272-080		RES,2.7K-1/8W J	EZSM	CX-NSZ300
X	MICON	R	0329 88-121-272-080	OE	RES,2.7K-1/8W J	LHSM	CX-NSZ300
X	MICON	R	0329 88-121-272-080	OE	RES,2.7K-1/8W J	USM	CX-SNAJ300
X	MICON	R	0329 88-121-272-080	OE	RES,2.7K-1/8W J	USM	CX-SNAJ305
X	MICON	R	0330 88-108-332-080		C-RES,U 3.3K-1/16W J	LHSM	CX-NSZ300
X	MICON	R	0330 88-108-332-080		C-RES,U 3.3K-1/16W J	USM	CX-SNAJ300

PARTS LIST

! = Δ SAFTY PARTS
 C = Components marked

All components used on this model at the production line are shown in this service manual.

However, please note that not all components will be available as spare parts for after-sales service.

Components marked S and O are designated as spare parts for service and will be stocked at the spare parts centers.

Components marked X and R are not designated as spare parts for after sales service, and will not be stocked at the spare parts centers.

K NO. = Only use japanese.

! C	UNIT NAME	REF NO.	PARTS CODE	K NO.	DESCRIPTION	SUFFIX	MODEL NAME
X	MICON	R	0330 88-108-332-080		C-RES,U 3.3K-1/16W J	USM	CX-SNAJ305
X	MICON	R	0330 88-108-332-080		C-RES,U 3.3K-1/16W J	EZSM	CX-NSZ300
X	MICON	R	0330 88-108-332-080	OE	C-RES,U 3.3K-1/16W J	LHSM	CX-NSZ300
X	MICON	R	0330 88-108-332-080	OE	C-RES,U 3.3K-1/16W J	USM	CX-SNAJ300
X	MICON	R	0330 88-108-332-080	OE	C-RES,U 3.3K-1/16W J	USM	CX-SNAJ305
X	MICON	R	0331 88-121-472-080		RES,4.7K-1/8W J	LHSM	CX-NSZ300
X	MICON	R	0331 88-121-472-080		RES,4.7K-1/8W J	USM	CX-SNAJ300
X	MICON	R	0331 88-121-472-080		RES,4.7K-1/8W J	USM	CX-SNAJ305
X	MICON	R	0331 88-121-472-080		RES,4.7K-1/8W J	EZSM	CX-NSZ300
X	MICON	R	0331 88-121-472-080	OE	RES,4.7K-1/8W J	LHSM	CX-NSZ300
X	MICON	R	0331 88-121-472-080	OE	RES,4.7K-1/8W J	USM	CX-SNAJ300
X	MICON	R	0332 88-108-682-080		C-RES,U 6.8K-1/16W J	LHSM	CX-NSZ300
X	MICON	R	0332 88-108-682-080		C-RES,U 6.8K-1/16W J	USM	CX-SNAJ300
X	MICON	R	0332 88-108-682-080		C-RES,U 6.8K-1/16W J	USM	CX-SNAJ305
X	MICON	R	0332 88-108-682-080	OE	C-RES,U 6.8K-1/16W J	EZSM	CX-NSZ300
X	MICON	R	0332 88-108-682-080	OE	C-RES,U 6.8K-1/16W J	LHSM	CX-NSZ300
X	MICON	R	0332 88-108-682-080	OE	C-RES,U 6.8K-1/16W J	USM	CX-SNAJ300
X	MICON	R	0332 88-108-682-080	OE	C-RES,U 6.8K-1/16W J	USM	CX-SNAJ305
X	MICON	R	0333 88-121-103-080		RES,10K-1/8W J	LHSM	CX-NSZ300
X	MICON	R	0333 88-121-103-080		RES,10K-1/8W J	USM	CX-SNAJ300
X	MICON	R	0333 88-121-103-080		RES,10K-1/8W J	USM	CX-SNAJ305
X	MICON	R	0333 88-121-103-080	OE	RES,10K-1/8W J	EZSM	CX-NSZ300
X	MICON	R	0333 88-121-103-080	OE	RES,10K-1/8W J	LHSM	CX-NSZ300
X	MICON	R	0333 88-121-103-080	OE	RES,10K-1/8W J	USM	CX-SNAJ300
X	MICON	R	0333 88-121-103-080	OE	RES,10K-1/8W J	USM	CX-SNAJ305
X	MICON	R	0334 88-108-183-080		C-RES,U 18K-1/16W J	LHSM	CX-NSZ300
X	MICON	R	0334 88-108-183-080		C-RES,U 18K-1/16W J	USM	CX-SNAJ300
X	MICON	R	0334 88-108-183-080		C-RES,U 18K-1/16W J	USM	CX-SNAJ305
X	MICON	R	0334 88-108-183-080		C-RES,U 18K-1/16W J	EZSM	CX-NSZ300
X	MICON	R	0334 88-108-183-080	OE	C-RES,U 18K-1/16W J	LHSM	CX-NSZ300
X	MICON	R	0334 88-108-183-080	OE	C-RES,U 18K-1/16W J	USM	CX-SNAJ300
X	MICON	R	0334 88-108-183-080	OE	C-RES,U 18K-1/16W J	USM	CX-SNAJ305
X	MICON	R	0341 88-108-103-080		C-RES,U 10K-1/16W J	LHSM	CX-NSZ300
X	MICON	R	0341 88-108-103-080		C-RES,U 10K-1/16W J	USM	CX-SNAJ300
X	MICON	R	0341 88-108-103-080		C-RES,U 10K-1/16W J	USM	CX-SNAJ305
X	MICON	R	0341 88-108-103-080		C-RES,U 10K-1/16W J	LHSM	CX-NSZ300
X	MICON	R	0341 88-108-103-080	OE	C-RES,U 10K-1/16W J	USM	CX-SNAJ300
X	MICON	R	0341 88-108-103-080	OE	C-RES,U 10K-1/16W J	USM	CX-SNAJ305
X	MICON	R	0342 88-108-102-080		C-RES,U 1K-1/16W J	LHSM	CX-NSZ300
X	MICON	R	0342 88-108-102-080		C-RES,U 1K-1/16W J	USM	CX-SNAJ300
X	MICON	R	0342 88-108-102-080		C-RES,U 1K-1/16W J	USM	CX-SNAJ305
X	MICON	R	0342 88-108-102-080		C-RES,U 1K-1/16W J	EZSM	CX-NSZ300
X	MICON	R	0342 88-108-102-080	OE	C-RES,U 1K-1/16W J	LHSM	CX-NSZ300
X	MICON	R	0342 88-108-102-080	OE	C-RES,U 1K-1/16W J	USM	CX-SNAJ300
X	MICON	R	0342 88-108-102-080	OE	C-RES,U 1K-1/16W J	USM	CX-SNAJ305
X	MICON	R	0343 88-108-821-080		C-RES,U 820-1/16W J	LHSM	CX-NSZ300
X	MICON	R	0343 88-108-821-080		C-RES,U 820-1/16W J	USM	CX-SNAJ300
X	MICON	R	0343 88-108-821-080		C-RES,U 820-1/16W J	USM	CX-SNAJ305
X	MICON	R	0343 88-108-821-080	OE	C-RES,U 820-1/16W J	EZSM	CX-NSZ300
X	MICON	R	0343 88-108-821-080	OE	C-RES,U 820-1/16W J	LHSM	CX-NSZ300
X	MICON	R	0343 88-108-821-080	OE	C-RES,U 820-1/16W J	USM	CX-SNAJ300
X	MICON	R	0343 88-108-821-080	OE	C-RES,U 820-1/16W J	USM	CX-SNAJ305
X	MICON	R	0344 88-108-102-080		C-RES,U 1K-1/16W J	LHSM	CX-NSZ300
X	MICON	R	0344 88-108-102-080		C-RES,U 1K-1/16W J	USM	CX-SNAJ300
X	MICON	R	0344 88-108-102-080		C-RES,U 1K-1/16W J	USM	CX-SNAJ305
X	MICON	R	0344 88-108-102-080		C-RES,U 1K-1/16W J	EZSM	CX-NSZ300
X	MICON	R	0344 88-108-102-080	OE	C-RES,U 1K-1/16W J	LHSM	CX-NSZ300
X	MICON	R	0344 88-108-102-080	OE	C-RES,U 1K-1/16W J	USM	CX-SNAJ300
X	MICON	R	0345 88-108-122-080	OE	C-RES,U 1.2K-1/16W J	USM	CX-SNAJ305
X	MICON	R	0345 88-108-122-080		C-RES,U 1.2K-1/16W J	LHSM	CX-NSZ300
X	MICON	R	0345 88-108-122-080		C-RES,U 1.2K-1/16W J	USM	CX-SNAJ300
X	MICON	R	0345 88-108-122-080		C-RES,U 1.2K-1/16W J	USM	CX-SNAJ305
X	MICON	R	0345 88-108-122-080		C-RES,U 1.2K-1/16W J	EZSM	CX-NSZ300
X	MICON	R	0345 88-108-122-080	OE	C-RES,U 1.2K-1/16W J	LHSM	CX-NSZ300
X	MICON	R	0345 88-108-122-080	OE	C-RES,U 1.2K-1/16W J	USM	CX-SNAJ300
X	MICON	R	0345 88-108-122-080	OE	C-RES,U 1.2K-1/16W J	USM	CX-SNAJ305
X	MICON	R	0346 88-121-122-080		RES,1.2K-1/8W J	LHSM	CX-NSZ300
X	MICON	R	0346 88-121-122-080		RES,1.2K-1/8W J	USM	CX-SNAJ300

PARTS LIST

! = Δ SAFTY PARTS
 C = Components marked

All components used on this model at the production line are shown in this service manual.

However, please note that not all components will be available as spare parts for after-sales service.

Components marked S and O are designated as spare parts for service and will be stocked at the spare parts centers.

Components marked X and R are not designated as spare parts for after sales service, and will not be stocked at the spare parts centers.

K NO. = Only use japanese.

! C	UNIT NAME	REF NO.	PARTS CODE	K NO.	DESCRIPTION	SUFFIX	MODEL NAME
X	MICON	R	0346 88-121-122-080		RES,1.2K-1/8W J	USM	CX-SNAJ305
X	MICON	R	0346 88-121-122-080		RES,1.2K-1/8W J	EZSM	CX-NSZ300
X	MICON	R	0346 88-121-122-080	OE	RES,1.2K-1/8W J	LHSM	CX-NSZ300
X	MICON	R	0346 88-121-122-080	OE	RES,1.2K-1/8W J	USM	CX-SNAJ300
X	MICON	R	0346 88-121-122-080	OE	RES,1.2K-1/8W J	USM	CX-SNAJ305
X	MICON	R	0347 88-108-182-080		C-RES,U 1.8K-1/16W J	LHSM	CX-NSZ300
X	MICON	R	0347 88-108-182-080		C-RES,U 1.8K-1/16W J	USM	CX-SNAJ300
X	MICON	R	0347 88-108-182-080		C-RES,U 1.8K-1/16W J	USM	CX-SNAJ305
X	MICON	R	0347 88-108-182-080		C-RES,U 1.8K-1/16W J	EZSM	CX-NSZ300
X	MICON	R	0347 88-108-182-080	OE	C-RES,U 1.8K-1/16W J	LHSM	CX-NSZ300
X	MICON	R	0347 88-108-182-080	OE	C-RES,U 1.8K-1/16W J	USM	CX-SNAJ300
X	MICON	R	0347 88-108-182-080	OE	C-RES,U 1.8K-1/16W J	USM	CX-SNAJ305
X	MICON	R	0348 88-108-182-080		C-RES,U 1.8K-1/16W J	LHSM	CX-NSZ300
X	MICON	R	0348 88-108-182-080		C-RES,U 1.8K-1/16W J	USM	CX-SNAJ300
X	MICON	R	0348 88-108-182-080		C-RES,U 1.8K-1/16W J	USM	CX-SNAJ305
X	MICON	R	0348 88-108-182-080		C-RES,U 1.8K-1/16W J	EZSM	CX-NSZ300
X	MICON	R	0348 88-108-182-080	OE	C-RES,U 1.8K-1/16W J	LHSM	CX-NSZ300
X	MICON	R	0348 88-108-182-080	OE	C-RES,U 1.8K-1/16W J	USM	CX-SNAJ300
X	MICON	R	0348 88-108-182-080	OE	C-RES,U 1.8K-1/16W J	USM	CX-SNAJ305
X	MICON	R	0349 88-108-272-080		C-RES,U 2.7K-1/16W J	LHSM	CX-NSZ300
X	MICON	R	0349 88-108-272-080		C-RES,U 2.7K-1/16W J	USM	CX-SNAJ300
X	MICON	R	0349 88-108-272-080		C-RES,U 2.7K-1/16W J	USM	CX-SNAJ305
X	MICON	R	0349 88-108-272-080		C-RES,U 2.7K-1/16W J	EZSM	CX-NSZ300
X	MICON	R	0349 88-108-272-080	OE	C-RES,U 2.7K-1/16W J	LHSM	CX-NSZ300
X	MICON	R	0349 88-108-272-080	OE	C-RES,U 2.7K-1/16W J	USM	CX-SNAJ300
X	MICON	R	0349 88-108-272-080	OE	C-RES,U 2.7K-1/16W J	USM	CX-SNAJ305
X	MICON	R	0361 88-108-103-080		C-RES,U 10K-1/16W J	LHSM	CX-NSZ300
X	MICON	R	0361 88-108-103-080		C-RES,U 10K-1/16W J	USM	CX-SNAJ300
X	MICON	R	0361 88-108-103-080		C-RES,U 10K-1/16W J	USM	CX-SNAJ305
X	MICON	R	0361 88-108-103-080		C-RES,U 10K-1/16W J	EZSM	CX-NSZ300
X	MICON	R	0361 88-108-103-080	OE	C-RES,U 10K-1/16W J	LHSM	CX-NSZ300
X	MICON	R	0361 88-108-103-080	OE	C-RES,U 10K-1/16W J	USM	CX-SNAJ300
X	MICON	R	0361 88-108-103-080	OE	C-RES,U 10K-1/16W J	USM	CX-SNAJ305
X	MICON	R	0362 88-108-103-080		C-RES,U 10K-1/16W J	LHSM	CX-NSZ300
X	MICON	R	0362 88-108-103-080		C-RES,U 10K-1/16W J	USM	CX-SNAJ300
X	MICON	R	0362 88-108-103-080		C-RES,U 10K-1/16W J	USM	CX-SNAJ305
X	MICON	R	0362 88-108-103-080		C-RES,U 10K-1/16W J	EZSM	CX-NSZ300
X	MICON	R	0362 88-108-103-080	OE	C-RES,U 10K-1/16W J	LHSM	CX-NSZ300
X	MICON	R	0362 88-108-103-080	OE	C-RES,U 10K-1/16W J	USM	CX-SNAJ300
X	MICON	R	0362 88-108-103-080	OE	C-RES,U 10K-1/16W J	USM	CX-SNAJ305
X	MICON	R	0363 88-108-100-080		C-RES,U 10-1/16W J	LHSM	CX-NSZ300
X	MICON	R	0363 88-108-100-080		C-RES,U 10-1/16W J	USM	CX-SNAJ300
X	MICON	R	0363 88-108-100-080		C-RES,U 10-1/16W J	USM	CX-SNAJ305
X	MICON	R	0363 88-108-100-080		C-RES,U 10-1/16W J	EZSM	CX-NSZ300
X	MICON	R	0363 88-108-100-080	OE	C-RES,U 10-1/16W J	LHSM	CX-NSZ300
X	MICON	R	0363 88-108-100-080	OE	C-RES,U 10-1/16W J	USM	CX-SNAJ300
X	MICON	R	0363 88-108-100-080	OE	C-RES,U 10-1/16W J	USM	CX-SNAJ305
X	MICON	R	0364 88-108-100-080		C-RES,U 10-1/16W J	LHSM	CX-NSZ300
X	MICON	R	0364 88-108-100-080		C-RES,U 10-1/16W J	USM	CX-SNAJ300
X	MICON	R	0364 88-108-100-080		C-RES,U 10-1/16W J	USM	CX-SNAJ305
X	MICON	R	0364 88-108-100-080		C-RES,U 10-1/16W J	EZSM	CX-NSZ300
X	MICON	R	0364 88-108-100-080	OE	C-RES,U 10-1/16W J	LHSM	CX-NSZ300
X	MICON	R	0364 88-108-100-080	OE	C-RES,U 10-1/16W J	USM	CX-SNAJ300
X	MICON	R	0364 88-108-100-080	OE	C-RES,U 10-1/16W J	USM	CX-SNAJ305
X	MICON	R	0371 88-108-103-080		C-RES,U 10K-1/16W J	LHSM	CX-NSZ300
X	MICON	R	0371 88-108-103-080		C-RES,U 10K-1/16W J	USM	CX-SNAJ300
X	MICON	R	0371 88-108-103-080		C-RES,U 10K-1/16W J	USM	CX-SNAJ305
X	MICON	R	0371 88-108-103-080		C-RES,U 10K-1/16W J	EZSM	CX-NSZ300
X	MICON	R	0371 88-108-103-080	OE	C-RES,U 10K-1/16W J	LHSM	CX-NSZ300
X	MICON	R	0371 88-108-103-080	OE	C-RES,U 10K-1/16W J	USM	CX-SNAJ300
X	MICON	R	0371 88-108-103-080	OE	C-RES,U 10K-1/16W J	USM	CX-SNAJ305
X	MICON	R	0372 88-108-103-080		C-RES,U 10K-1/16W J	LHSM	CX-NSZ300
X	MICON	R	0372 88-108-103-080		C-RES,U 10K-1/16W J	USM	CX-SNAJ300
X	MICON	R	0372 88-108-103-080		C-RES,U 10K-1/16W J	USM	CX-SNAJ305
X	MICON	R	0372 88-108-103-080		C-RES,U 10K-1/16W J	EZSM	CX-NSZ300
X	MICON	R	0372 88-108-103-080	OE	C-RES,U 10K-1/16W J	LHSM	CX-NSZ300
X	MICON	R	0372 88-108-103-080	OE	C-RES,U 10K-1/16W J	USM	CX-SNAJ300
X	MICON	R	0372 88-108-103-080	OE	C-RES,U 10K-1/16W J	USM	CX-SNAJ305
X	MICON	R	0373 88-108-100-080		C-RES,U 10-1/16W J	LHSM	CX-NSZ300
X	MICON	R	0373 88-108-100-080		C-RES,U 10-1/16W J	USM	CX-SNAJ300

PARTS LIST

! = Δ SAFTY PARTS
 C = Components marked

All components used on this model at the production line are shown in this service manual.

However, please note that not all components will be available as spare parts for after-sales service.

Components marked S and O are designated as spare parts for service and will be stocked at the spare parts centers.

Components marked X and R are not designated as spare parts for after sales service, and will not be stocked at the spare parts centers.

K NO. = Only use japanese.

! C	UNIT NAME	REF NO.	PARTS CODE	K NO.	DESCRIPTION	SUFFIX	MODEL NAME
X	MICON	R	0373 88-108-100-080		C-RES,U 10-1/16W J	USM	CX-SNAJ305
X	MICON	R	0373 88-108-100-080		C-RES,U 10-1/16W J	EZSM	CX-NSZ300
X	MICON	R	0373 88-108-100-080	OE	C-RES,U 10-1/16W J	LHSM	CX-NSZ300
X	MICON	R	0373 88-108-100-080	OE	C-RES,U 10-1/16W J	USM	CX-SNAJ300
X	MICON	R	0373 88-108-100-080	OE	C-RES,U 10-1/16W J	USM	CX-SNAJ305
X	MICON	R	0374 88-108-100-080		C-RES,U 10-1/16W J	LHSM	CX-NSZ300
X	MICON	R	0374 88-108-100-080		C-RES,U 10-1/16W J	USM	CX-SNAJ300
X	MICON	R	0374 88-108-100-080		C-RES,U 10-1/16W J	USM	CX-SNAJ305
X	MICON	R	0374 88-108-100-080		C-RES,U 10-1/16W J	EZSM	CX-NSZ300
X	MICON	R	0374 88-108-100-080	OE	C-RES,U 10-1/16W J	LHSM	CX-NSZ300
X	MICON	R	0374 88-108-100-080	OE	C-RES,U 10-1/16W J	USM	CX-SNAJ300
X	MICON	R	0374 88-108-100-080	OE	C-RES,U 10-1/16W J	USM	CX-SNAJ305
X	MICON	R	0374 88-108-100-080	OE	C-RES,U 10-1/16W J	LHSM	CX-NSZ300
X	MICON	R	0601 88-108-103-080		C-RES,U 10K-1/16W J	LHSM	CX-NSZ300
X	MICON	R	0601 88-108-103-080		C-RES,U 10K-1/16W J	USM	CX-SNAJ300
X	MICON	R	0601 88-108-103-080		C-RES,U 10K-1/16W J	USM	CX-SNAJ305
X	MICON	R	0601 88-108-103-080		C-RES,U 10K-1/16W J	EZSM	CX-NSZ300
X	MICON	R	0601 88-108-103-080	OE	C-RES,U 10K-1/16W J	LHSM	CX-NSZ300
X	MICON	R	0601 88-108-103-080	OE	C-RES,U 10K-1/16W J	USM	CX-SNAJ300
X	MICON	R	0601 88-108-103-080	OE	C-RES,U 10K-1/16W J	USM	CX-SNAJ305
X	MICON	R	0602 88-108-222-080		C-RES,U 2.2K-1/16W J	LHSM	CX-NSZ300
X	MICON	R	0602 88-108-222-080		C-RES,U 2.2K-1/16W J	USM	CX-SNAJ300
X	MICON	R	0602 88-108-222-080		C-RES,U 2.2K-1/16W J	USM	CX-SNAJ305
X	MICON	R	0602 88-108-222-080	OE	C-RES,U 2.2K-1/16W J	EZSM	CX-NSZ300
X	MICON	R	0602 88-108-222-080	OE	C-RES,U 2.2K-1/16W J	LHSM	CX-NSZ300
X	MICON	R	0602 88-108-222-080	OE	C-RES,U 2.2K-1/16W J	USM	CX-SNAJ300
X	MICON	R	0602 88-108-222-080	OE	C-RES,U 2.2K-1/16W J	USM	CX-SNAJ305
X	MICON	R	0603 88-108-103-080		C-RES,U 10K-1/16W J	LHSM	CX-NSZ300
X	MICON	R	0603 88-108-103-080		C-RES,U 10K-1/16W J	USM	CX-SNAJ300
X	MICON	R	0603 88-108-103-080		C-RES,U 10K-1/16W J	USM	CX-SNAJ305
X	MICON	R	0603 88-108-103-080		C-RES,U 10K-1/16W J	EZSM	CX-NSZ300
X	MICON	R	0603 88-108-103-080	OE	C-RES,U 10K-1/16W J	LHSM	CX-NSZ300
X	MICON	R	0603 88-108-103-080	OE	C-RES,U 10K-1/16W J	USM	CX-SNAJ300
X	MICON	R	0603 88-108-103-080	OE	C-RES,U 10K-1/16W J	USM	CX-SNAJ305
X	MICON	R	0604 88-108-222-080		C-RES,U 2.2K-1/16W J	LHSM	CX-NSZ300
X	MICON	R	0604 88-108-222-080		C-RES,U 2.2K-1/16W J	USM	CX-SNAJ300
X	MICON	R	0604 88-108-222-080		C-RES,U 2.2K-1/16W J	USM	CX-SNAJ305
X	MICON	R	0604 88-108-222-080	OE	C-RES,U 2.2K-1/16W J	EZSM	CX-NSZ300
X	MICON	R	0604 88-108-222-080	OE	C-RES,U 2.2K-1/16W J	LHSM	CX-NSZ300
X	MICON	R	0604 88-108-222-080	OE	C-RES,U 2.2K-1/16W J	USM	CX-SNAJ300
X	MICON	R	0604 88-108-222-080	OE	C-RES,U 2.2K-1/16W J	USM	CX-SNAJ305
X	MICON	R	0605 88-108-103-080		C-RES,U 10K-1/16W J	LHSM	CX-NSZ300
X	MICON	R	0605 88-108-103-080		C-RES,U 10K-1/16W J	USM	CX-SNAJ300
X	MICON	R	0605 88-108-103-080		C-RES,U 10K-1/16W J	USM	CX-SNAJ305
X	MICON	R	0605 88-108-103-080		C-RES,U 10K-1/16W J	EZSM	CX-NSZ300
X	MICON	R	0605 88-108-103-080	OE	C-RES,U 10K-1/16W J	LHSM	CX-NSZ300
X	MICON	R	0605 88-108-103-080	OE	C-RES,U 10K-1/16W J	USM	CX-SNAJ300
X	MICON	R	0605 88-108-103-080	OE	C-RES,U 10K-1/16W J	USM	CX-SNAJ305
X	MICON	R	0606 88-108-102-080		C-RES,U 1K-1/16W J	LHSM	CX-NSZ300
X	MICON	R	0606 88-108-102-080		C-RES,U 1K-1/16W J	USM	CX-SNAJ300
X	MICON	R	0606 88-108-102-080		C-RES,U 1K-1/16W J	USM	CX-SNAJ305
X	MICON	R	0606 88-108-102-080	OE	C-RES,U 1K-1/16W J	EZSM	CX-NSZ300
X	MICON	R	0606 88-108-102-080	OE	C-RES,U 1K-1/16W J	LHSM	CX-NSZ300
X	MICON	R	0606 88-108-102-080	OE	C-RES,U 1K-1/16W J	USM	CX-SNAJ300
X	MICON	R	0607 88-108-000-080		C-JUMPER,U	LHSM	CX-NSZ300
X	MICON	R	0607 88-108-000-080		C-JUMPER,U	USM	CX-SNAJ300
X	MICON	R	0607 88-108-000-080		C-JUMPER,U	USM	CX-SNAJ305
X	MICON	R	0607 88-108-000-080		C-JUMPER,U	EZSM	CX-NSZ300
X	MICON	R	0607 88-108-000-080	OE	C-JUMPER,U	LHSM	CX-NSZ300
X	MICON	R	0607 88-108-000-080	OE	C-JUMPER,U	USM	CX-SNAJ300
X	MICON	R	0607 88-108-000-080	OE	C-JUMPER,U	USM	CX-SNAJ305
X	MICON	R	0611 88-108-473-080		C-RES,U 47K-1/16W J	LHSM	CX-NSZ300
X	MICON	R	0611 88-108-473-080		C-RES,U 47K-1/16W J	USM	CX-SNAJ300
X	MICON	R	0611 88-108-473-080		C-RES,U 47K-1/16W J	USM	CX-SNAJ305
X	MICON	R	0611 88-108-473-080		C-RES,U 47K-1/16W J	EZSM	CX-NSZ300
X	MICON	R	0611 88-108-473-080	OE	C-RES,U 47K-1/16W J	LHSM	CX-NSZ300
X	MICON	R	0611 88-108-473-080	OE	C-RES,U 47K-1/16W J	USM	CX-SNAJ300
X	MICON	R	0611 88-108-473-080	OE	C-RES,U 47K-1/16W J	USM	CX-SNAJ305
X	MICON	R	0612 88-108-473-080		C-RES,U 47K-1/16W J	LHSM	CX-NSZ300
X	MICON	R	0612 88-108-473-080		C-RES,U 47K-1/16W J	USM	CX-SNAJ300

PARTS LIST

! = Δ SAFTY PARTS
 C = Components marked

All components used on this model at the production line are shown in this service manual.

However, please note that not all components will be available as spare parts for after-sales service.

Components marked S and O are designated as spare parts for service and will be stocked at the spare parts centers.

Components marked X and R are not designated as spare parts for after sales service, and will not be stocked at the spare parts centers.

K NO. = Only use japanese.

! C	UNIT NAME	REF NO.	PARTS CODE	K NO.	DESCRIPTION	SUFFIX	MODEL NAME
X	MICON	R	0612 88-108-473-080		C-RES,U 47K-1/16W J	USM	CX-SNAJ305
X	MICON	R	0613 88-108-473-080		C-RES,U 47K-1/16W J	LHSM	CX-NSZ300
X	MICON	R	0613 88-108-473-080		C-RES,U 47K-1/16W J	USM	CX-SNAJ300
X	MICON	R	0613 88-108-473-080		C-RES,U 47K-1/16W J	USM	CX-SNAJ305
X	MICON	R	0613 88-108-473-080		C-RES,U 47K-1/16W J	EZSM	CX-NSZ300
X	MICON	R	0613 88-108-473-080	OE	C-RES,U 47K-1/16W J	LHSM	CX-NSZ300
X	MICON	R	0613 88-108-473-080	OE	C-RES,U 47K-1/16W J	USM	CX-SNAJ300
X	MICON	R	0613 88-108-473-080	OE	C-RES,U 47K-1/16W J	USM	CX-SNAJ305
X	MICON	R	0614 88-108-473-080		C-RES,U 47K-1/16W J	LHSM	CX-NSZ300
X	MICON	R	0614 88-108-473-080		C-RES,U 47K-1/16W J	USM	CX-SNAJ300
X	MICON	R	0614 88-108-473-080		C-RES,U 47K-1/16W J	USM	CX-SNAJ305
X	MICON	R	0614 88-108-473-080		C-RES,U 47K-1/16W J	EZSM	CX-NSZ300
X	MICON	R	0614 88-108-473-080	OE	C-RES,U 47K-1/16W J	LHSM	CX-NSZ300
X	MICON	R	0614 88-108-473-080	OE	C-RES,U 47K-1/16W J	USM	CX-SNAJ300
X	MICON	R	0614 88-108-473-080	OE	C-RES,U 47K-1/16W J	USM	CX-SNAJ305
X	MICON	R	0615 88-108-473-080		C-RES,U 47K-1/16W J	LHSM	CX-NSZ300
X	MICON	R	0615 88-108-473-080		C-RES,U 47K-1/16W J	USM	CX-SNAJ300
X	MICON	R	0615 88-108-473-080		C-RES,U 47K-1/16W J	USM	CX-SNAJ305
X	MICON	R	0615 88-108-473-080		C-RES,U 47K-1/16W J	EZSM	CX-NSZ300
X	MICON	R	0615 88-108-473-080	OE	C-RES,U 47K-1/16W J	LHSM	CX-NSZ300
X	MICON	R	0615 88-108-473-080	OE	C-RES,U 47K-1/16W J	USM	CX-SNAJ300
X	MICON	R	0615 88-108-473-080	OE	C-RES,U 47K-1/16W J	USM	CX-SNAJ305
X	MICON	R	0616 88-108-473-080		C-RES,U 47K-1/16W J	LHSM	CX-NSZ300
X	MICON	R	0616 88-108-473-080		C-RES,U 47K-1/16W J	USM	CX-SNAJ300
X	MICON	R	0616 88-108-473-080		C-RES,U 47K-1/16W J	LHSM	CX-NSZ300
X	MICON	R	0616 88-108-473-080		C-RES,U 47K-1/16W J	USM	CX-SNAJ305
X	MICON	R	0616 88-108-473-080		C-RES,U 47K-1/16W J	EZSM	CX-NSZ300
X	MICON	R	0616 88-108-473-080	OE	C-RES,U 47K-1/16W J	LHSM	CX-NSZ300
X	MICON	R	0616 88-108-473-080	OE	C-RES,U 47K-1/16W J	USM	CX-SNAJ300
X	MICON	R	0616 88-108-473-080	OE	C-RES,U 47K-1/16W J	USM	CX-SNAJ305
X	MICON	R	0651 88-128-152-080		C-RES, 1.5K-1/8W J	LHSM	CX-NSZ300
X	MICON	R	0651 88-128-152-080		C-RES, 1.5K-1/8W J	USM	CX-SNAJ300
X	MICON	R	0651 88-128-152-080		C-RES, 1.5K-1/8W J	USM	CX-SNAJ305
X	MICON	R	0651 88-128-152-080		C-RES, 1.5K-1/8W J	EZSM	CX-NSZ300
X	MICON	R	0651 88-128-152-080	OE	C-RES, 1.5K-1/8W J	LHSM	CX-NSZ300
X	MICON	R	0651 88-128-152-080	OE	C-RES, 1.5K-1/8W J	USM	CX-SNAJ300
X	MICON	R	0651 88-128-152-080	OE	C-RES, 1.5K-1/8W J	USM	CX-SNAJ305
X	MICON	R	0652 88-108-152-080		C-RES,U 1.5K-1/16W J	LHSM	CX-NSZ300
X	MICON	R	0652 88-108-152-080		C-RES,U 1.5K-1/16W J	USM	CX-SNAJ300
X	MICON	R	0652 88-108-152-080		C-RES,U 1.5K-1/16W J	USM	CX-SNAJ305
X	MICON	R	0652 88-108-152-080		C-RES,U 1.5K-1/16W J	EZSM	CX-NSZ300
X	MICON	R	0652 88-108-152-080	OE	C-RES,U 1.5K-1/16W J	LHSM	CX-NSZ300
X	MICON	R	0652 88-108-152-080	OE	C-RES,U 1.5K-1/16W J	USM	CX-SNAJ300
X	MICON	R	0652 88-108-152-080	OE	C-RES,U 1.5K-1/16W J	USM	CX-SNAJ305
X	MICON	R	0652 88-108-152-080		C-RES,U 1.5K-1/16W J	LHSM	CX-NSZ300
X	MICON	R	0652 88-108-152-080		C-RES,U 1.5K-1/16W J	USM	CX-SNAJ300
X	MICON	R	0652 88-108-152-080		C-RES,U 1.5K-1/16W J	USM	CX-SNAJ305
X	MICON	R	0652 88-108-152-080		C-RES,U 1.5K-1/16W J	EZSM	CX-NSZ300
X	MICON	R	0653 88-108-152-080		C-RES,U 1.5K-1/16W J	LHSM	CX-NSZ300
X	MICON	R	0653 88-108-152-080		C-RES,U 1.5K-1/16W J	USM	CX-SNAJ300
X	MICON	R	0653 88-108-152-080		C-RES,U 1.5K-1/16W J	USM	CX-SNAJ305
X	MICON	R	0653 88-108-152-080		C-RES,U 1.5K-1/16W J	EZSM	CX-NSZ300
X	MICON	R	0653 88-108-152-080	OE	C-RES,U 1.5K-1/16W J	LHSM	CX-NSZ300
X	MICON	R	0653 88-108-152-080	OE	C-RES,U 1.5K-1/16W J	USM	CX-SNAJ300
X	MICON	R	0653 88-108-152-080	OE	C-RES,U 1.5K-1/16W J	USM	CX-SNAJ305
X	MICON	R	0654 88-108-152-080		C-RES,U 1.5K-1/16W J	LHSM	CX-NSZ300
X	MICON	R	0654 88-108-152-080		C-RES,U 1.5K-1/16W J	USM	CX-SNAJ300
X	MICON	R	0654 88-108-152-080		C-RES,U 1.5K-1/16W J	USM	CX-SNAJ305
X	MICON	R	0654 88-108-152-080		C-RES,U 1.5K-1/16W J	EZSM	CX-NSZ300
X	MICON	R	0654 88-108-152-080	OE	C-RES,U 1.5K-1/16W J	LHSM	CX-NSZ300
X	MICON	R	0654 88-108-152-080	OE	C-RES,U 1.5K-1/16W J	USM	CX-SNAJ300
X	MICON	R	0654 88-108-152-080	OE	C-RES,U 1.5K-1/16W J	USM	CX-SNAJ305
X	MICON	R	0655 88-128-152-080		C-RES, 1.5K-1/8W J	LHSM	CX-NSZ300
X	MICON	R	0655 88-128-152-080		C-RES, 1.5K-1/8W J	USM	CX-SNAJ300
X	MICON	R	0655 88-128-152-080		C-RES, 1.5K-1/8W J	USM	CX-SNAJ305
X	MICON	R	0655 88-128-152-080		C-RES, 1.5K-1/8W J	EZSM	CX-NSZ300
X	MICON	R	0655 88-128-152-080	OE	C-RES, 1.5K-1/8W J	LHSM	CX-NSZ300
X	MICON	R	0655 88-128-152-080	OE	C-RES, 1.5K-1/8W J	USM	CX-SNAJ300
X	MICON	R	0655 88-128-152-080	OE	C-RES, 1.5K-1/8W J	USM	CX-SNAJ305
X	MICON	R	0656 88-108-152-080		C-RES,U 1.5K-1/16W J	LHSM	CX-NSZ300
X	MICON	R	0656 88-108-152-080		C-RES,U 1.5K-1/16W J	USM	CX-SNAJ300
X	MICON	R	0656 88-108-152-080		C-RES,U 1.5K-1/16W J	USM	CX-SNAJ305
X	MICON	R	0656 88-108-152-080		C-RES,U 1.5K-1/16W J	EZSM	CX-NSZ300
X	MICON	R	0656 88-108-152-080	OE	C-RES,U 1.5K-1/16W J	LHSM	CX-NSZ300
X	MICON	R	0656 88-108-152-080	OE	C-RES,U 1.5K-1/16W J	USM	CX-SNAJ300

PARTS LIST

! = Δ SAFTY PARTS
 C = Components marked

All components used on this model at the production line are shown in this service manual.

However, please note that not all components will be available as spare parts for after-sales service.

Components marked S and O are designated as spare parts for service and will be stocked at the spare parts centers.

Components marked X and R are not designated as spare parts for after sales service, and will not be stocked at the spare parts centers.

K NO. = Only use japanese.

! C	UNIT NAME	REF NO.	PARTS CODE	K NO.	DESCRIPTION	SUFFIX	MODEL NAME
X	MICON	R	0656 88-108-152-080	OE	C-RES,U 1.5K-1/16W J	USM	CX-SNAJ305
X	MICON	R	0657 88-108-152-080		C-RES,U 1.5K-1/16W J	LHSM	CX-NSZ300
X	MICON	R	0657 88-108-152-080		C-RES,U 1.5K-1/16W J	USM	CX-SNAJ300
X	MICON	R	0657 88-108-152-080		C-RES,U 1.5K-1/16W J	USM	CX-SNAJ305
X	MICON	R	0704 88-121-102-080		RES,1K-1/8W J	LHSM	CX-NSZ300
X	MICON	R	0704 88-121-102-080		RES,1K-1/8W J	USM	CX-SNAJ300
X	MICON	R	0704 88-121-102-080		RES,1K-1/8W J	USM	CX-SNAJ305
X	MICON	R	0704 88-121-102-080		RES,1K-1/8W J	EZSM	CX-NSZ300
X	MICON	R	0704 88-121-102-080	OE	RES,1K-1/8W J	LHSM	CX-NSZ300
X	MICON	R	0704 88-121-102-080	OE	RES,1K-1/8W J	USM	CX-SNAJ300
X	MICON	R	0704 88-121-102-080	OE	RES,1K-1/8W J	USM	CX-SNAJ305
X	MICON	R	0705 88-108-102-080		C-RES,U 1K-1/16W J	LHSM	CX-NSZ300
X	MICON	R	0705 88-108-102-080		C-RES,U 1K-1/16W J	USM	CX-SNAJ300
X	MICON	R	0705 88-108-102-080		C-RES,U 1K-1/16W J	USM	CX-SNAJ305
X	MICON	R	0705 88-108-102-080		C-RES,U 1K-1/16W J	EZSM	CX-NSZ300
X	MICON	R	0705 88-108-102-080	OE	C-RES,U 1K-1/16W J	LHSM	CX-NSZ300
X	MICON	R	0705 88-108-102-080	OE	C-RES,U 1K-1/16W J	USM	CX-SNAJ300
X	MICON	R	0705 88-108-102-080	OE	C-RES,U 1K-1/16W J	USM	CX-SNAJ305
X	MICON	R	0706 88-108-102-080		C-RES,U 1K-1/16W J	LHSM	CX-NSZ300
X	MICON	R	0706 88-108-102-080		C-RES,U 1K-1/16W J	USM	CX-SNAJ300
X	MICON	R	0706 88-108-102-080		C-RES,U 1K-1/16W J	USM	CX-SNAJ305
X	MICON	R	0706 88-108-102-080		C-RES,U 1K-1/16W J	EZSM	CX-NSZ300
X	MICON	R	0706 88-108-102-080	OE	C-RES,U 1K-1/16W J	LHSM	CX-NSZ300
X	MICON	R	0706 88-108-102-080	OE	C-RES,U 1K-1/16W J	USM	CX-SNAJ300
X	MICON	R	0706 88-108-102-080	OE	C-RES,U 1K-1/16W J	USM	CX-SNAJ305
X	MICON	R	0707 88-108-102-080		C-RES,U 1K-1/16W J	LHSM	CX-NSZ300
X	MICON	R	0707 88-108-102-080		C-RES,U 1K-1/16W J	USM	CX-SNAJ300
X	MICON	R	0707 88-108-102-080		C-RES,U 1K-1/16W J	USM	CX-SNAJ305
X	MICON	R	0707 88-108-102-080		C-RES,U 1K-1/16W J	EZSM	CX-NSZ300
X	MICON	R	0707 88-108-102-080	OE	C-RES,U 1K-1/16W J	LHSM	CX-NSZ300
X	MICON	R	0707 88-108-102-080	OE	C-RES,U 1K-1/16W J	USM	CX-SNAJ300
X	MICON	R	0707 88-108-102-080	OE	C-RES,U 1K-1/16W J	USM	CX-SNAJ305
X	MICON	R	0708 88-108-102-080		C-RES,U 1K-1/16W J	LHSM	CX-NSZ300
X	MICON	R	0708 88-108-102-080		C-RES,U 1K-1/16W J	USM	CX-SNAJ300
X	MICON	R	0708 88-108-102-080		C-RES,U 1K-1/16W J	USM	CX-SNAJ305
X	MICON	R	0708 88-108-102-080		C-RES,U 1K-1/16W J	EZSM	CX-NSZ300
X	MICON	R	0708 88-108-102-080	OE	C-RES,U 1K-1/16W J	LHSM	CX-NSZ300
X	MICON	R	0708 88-108-102-080	OE	C-RES,U 1K-1/16W J	USM	CX-SNAJ300
X	MICON	R	0708 88-108-102-080	OE	C-RES,U 1K-1/16W J	USM	CX-SNAJ305
X	MICON	R	0709 88-108-101-080		C-RES,U 100-1/16W J	LHSM	CX-NSZ300
X	MICON	R	0709 88-108-101-080		C-RES,U 100-1/16W J	USM	CX-SNAJ300
X	MICON	R	0709 88-108-101-080		C-RES,U 100-1/16W J	USM	CX-SNAJ305
X	MICON	R	0709 88-108-101-080		C-RES,U 100-1/16W J	EZSM	CX-NSZ300
X	MICON	R	0709 88-108-101-080	OE	C-RES,U 100-1/16W J	LHSM	CX-NSZ300
X	MICON	R	0709 88-108-101-080	OE	C-RES,U 100-1/16W J	USM	CX-SNAJ300
X	MICON	R	0709 88-108-101-080	OE	C-RES,U 100-1/16W J	USM	CX-SNAJ305
X	MICON	R	0710 88-121-101-080		RES,100-1/8W J	LHSM	CX-NSZ300
X	MICON	R	0710 88-121-101-080		RES,100-1/8W J	USM	CX-SNAJ300
X	MICON	R	0710 88-121-101-080		RES,100-1/8W J	USM	CX-SNAJ305
X	MICON	R	0710 88-121-101-080		RES,100-1/8W J	EZSM	CX-NSZ300
X	MICON	R	0710 88-121-101-080	OE	RES,100-1/8W J	LHSM	CX-NSZ300
X	MICON	R	0710 88-121-101-080	OE	RES,100-1/8W J	USM	CX-SNAJ300
X	MICON	R	0710 88-121-101-080	OE	RES,100-1/8W J	USM	CX-SNAJ305
X	MICON	R	0711 88-108-101-080		C-RES,U 100-1/16W J	LHSM	CX-NSZ300
X	MICON	R	0711 88-108-101-080		C-RES,U 100-1/16W J	USM	CX-SNAJ300
X	MICON	R	0711 88-108-101-080		C-RES,U 100-1/16W J	USM	CX-SNAJ305
X	MICON	R	0711 88-108-101-080		C-RES,U 100-1/16W J	EZSM	CX-NSZ300
X	MICON	R	0711 88-108-101-080	OE	C-RES,U 100-1/16W J	LHSM	CX-NSZ300
X	MICON	R	0711 88-108-101-080	OE	C-RES,U 100-1/16W J	USM	CX-SNAJ300
X	MICON	R	0711 88-108-101-080	OE	C-RES,U 100-1/16W J	USM	CX-SNAJ305
X	MICON	R	0712 88-128-101-080		C-RES, 100-1/8W J	LHSM	CX-NSZ300
X	MICON	R	0712 88-128-101-080		C-RES, 100-1/8W J	USM	CX-SNAJ300
X	MICON	R	0712 88-128-101-080		C-RES, 100-1/8W J	USM	CX-SNAJ305
X	MICON	R	0712 88-128-101-080		C-RES, 100-1/8W J	EZSM	CX-NSZ300
X	MICON	R	0712 88-128-101-080	OE	C-RES, 100-1/8W J	LHSM	CX-NSZ300
X	MICON	R	0712 88-128-101-080	OE	C-RES, 100-1/8W J	USM	CX-SNAJ300
X	MICON	R	0712 88-128-101-080	OE	C-RES, 100-1/8W J	USM	CX-SNAJ305
X	MICON	R	0715 88-128-101-080		C-RES, 100-1/8W J	LHSM	CX-NSZ300
X	MICON	R	0715 88-128-101-080		C-RES, 100-1/8W J	USM	CX-SNAJ300
X	MICON	R	0715 88-128-101-080		C-RES, 100-1/8W J	USM	CX-SNAJ305

PARTS LIST

! = Δ SAFTY PARTS
 C = Components marked

All components used on this model at the production line are shown in this service manual.

However, please note that not all components will be available as spare parts for after-sales service.

Components marked S and O are designated as spare parts for service and will be stocked at the spare parts centers.

Components marked X and R are not designated as spare parts for after sales service, and will not be stocked at the spare parts centers.

K NO. = Only use japanese.

! C	UNIT NAME	REF NO.	PARTS CODE	K NO.	DESCRIPTION	SUFFIX	MODEL NAME
X	MICON	R	0715 88-128-101-080		C-RES, 100-1/8W J	EZSM	CX-NSZ300
X	MICON	R	0715 88-128-101-080	OE	C-RES, 100-1/8W J	LHSM	CX-NSZ300
X	MICON	R	0715 88-128-101-080	OE	C-RES, 100-1/8W J	USM	CX-SNAJ300
X	MICON	R	0715 88-128-101-080	OE	C-RES, 100-1/8W J	USM	CX-SNAJ305
X	MICON	R	0716 88-108-472-080		C-RES,U 4.7K-1/16W J	LHSM	CX-NSZ300
X	MICON	R	0716 88-108-472-080		C-RES,U 4.7K-1/16W J	USM	CX-SNAJ300
X	MICON	R	0716 88-108-472-080		C-RES,U 4.7K-1/16W J	USM	CX-SNAJ305
X	MICON	R	0716 88-108-472-080		C-RES,U 4.7K-1/16W J	EZSM	CX-NSZ300
X	MICON	R	0716 88-108-472-080	OE	C-RES,U 4.7K-1/16W J	LHSM	CX-NSZ300
X	MICON	R	0716 88-108-472-080	OE	C-RES,U 4.7K-1/16W J	USM	CX-SNAJ300
X	MICON	R	0716 88-108-472-080	OE	C-RES,U 4.7K-1/16W J	USM	CX-SNAJ300
X	MICON	R	0719 88-121-100-080	OE	C-RES,U 4.7K-1/16W J	USM	CX-SNAJ305
X	MICON	R	0719 88-121-100-080		RES,10-1/8W J	LHSM	CX-NSZ300
X	MICON	R	0719 88-121-100-080		RES,10-1/8W J	USM	CX-SNAJ300
X	MICON	R	0719 88-121-100-080		RES,10-1/8W J	USM	CX-SNAJ305
X	MICON	R	0719 88-121-100-080		RES,10-1/8W J	EZSM	CX-NSZ300
X	MICON	R	0719 88-121-100-080	OE	RES,10-1/8W J	LHSM	CX-NSZ300
X	MICON	R	0719 88-121-100-080	OE	RES,10-1/8W J	USM	CX-SNAJ300
X	MICON	R	0719 88-121-100-080	OE	RES,10-1/8W J	USM	CX-SNAJ305
X	MICON	R	0721 88-128-101-080		C-RES, 100-1/8W J	LHSM	CX-NSZ300
X	MICON	R	0721 88-128-101-080		C-RES, 100-1/8W J	USM	CX-SNAJ300
X	MICON	R	0721 88-128-101-080		C-RES, 100-1/8W J	USM	CX-SNAJ305
X	MICON	R	0721 88-128-101-080	OE	C-RES, 100-1/8W J	EZSM	CX-NSZ300
X	MICON	R	0721 88-128-101-080	OE	C-RES, 100-1/8W J	LHSM	CX-NSZ300
X	MICON	R	0721 88-128-101-080	OE	C-RES, 100-1/8W J	USM	CX-SNAJ300
X	MICON	R	0721 88-128-101-080	OE	C-RES, 100-1/8W J	USM	CX-SNAJ305
X	MICON	R	0730 88-108-102-080		C-RES,U 1K-1/16W J	LHSM	CX-NSZ300
X	MICON	R	0730 88-108-102-080		C-RES,U 1K-1/16W J	USM	CX-SNAJ300
X	MICON	R	0730 88-108-102-080		C-RES,U 1K-1/16W J	USM	CX-SNAJ305
X	MICON	R	0730 88-108-102-080		C-RES,U 1K-1/16W J	EZSM	CX-NSZ300
X	MICON	R	0730 88-108-102-080	OE	C-RES,U 1K-1/16W J	LHSM	CX-NSZ300
X	MICON	R	0730 88-108-102-080	OE	C-RES,U 1K-1/16W J	USM	CX-SNAJ300
X	MICON	R	0730 88-108-102-080	OE	C-RES,U 1K-1/16W J	USM	CX-SNAJ305
X	MICON	R	0730 88-108-102-080	OE	C-RES,U 1K-1/16W J	LHSM	CX-NSZ300
X	MICON	R	0732 88-108-101-080		C-RES,U 100-1/16W J	LHSM	CX-NSZ300
X	MICON	R	0732 88-108-101-080		C-RES,U 100-1/16W J	USM	CX-SNAJ300
X	MICON	R	0732 88-108-101-080		C-RES,U 100-1/16W J	USM	CX-SNAJ305
X	MICON	R	0732 88-108-101-080		C-RES,U 100-1/16W J	EZSM	CX-NSZ300
X	MICON	R	0732 88-108-101-080	OE	C-RES,U 100-1/16W J	LHSM	CX-NSZ300
X	MICON	R	0732 88-108-101-080	OE	C-RES,U 100-1/16W J	USM	CX-SNAJ300
X	MICON	R	0732 88-108-101-080	OE	C-RES,U 100-1/16W J	USM	CX-SNAJ305
X	MICON	R	0733 88-108-101-080		C-RES,U 100-1/16W J	LHSM	CX-NSZ300
X	MICON	R	0733 88-108-101-080		C-RES,U 100-1/16W J	USM	CX-SNAJ300
X	MICON	R	0733 88-108-101-080		C-RES,U 100-1/16W J	USM	CX-SNAJ305
X	MICON	R	0733 88-108-101-080		C-RES,U 100-1/16W J	EZSM	CX-NSZ300
X	MICON	R	0733 88-108-101-080	OE	C-RES,U 100-1/16W J	LHSM	CX-NSZ300
X	MICON	R	0733 88-108-101-080	OE	C-RES,U 100-1/16W J	USM	CX-SNAJ300
X	MICON	R	0733 88-108-101-080	OE	C-RES,U 100-1/16W J	USM	CX-SNAJ305
X	MICON	R	0734 88-121-102-080		RES,1K-1/8W J	LHSM	CX-NSZ300
X	MICON	R	0734 88-121-102-080		RES,1K-1/8W J	USM	CX-SNAJ300
X	MICON	R	0734 88-121-102-080		RES,1K-1/8W J	USM	CX-SNAJ305
X	MICON	R	0734 88-121-102-080		RES,1K-1/8W J	EZSM	CX-NSZ300
X	MICON	R	0734 88-121-102-080	OE	RES,1K-1/8W J	LHSM	CX-NSZ300
X	MICON	R	0734 88-121-102-080	OE	RES,1K-1/8W J	USM	CX-SNAJ300
X	MICON	R	0734 88-121-102-080	OE	RES,1K-1/8W J	USM	CX-SNAJ305
X	MICON	R	0735 88-108-102-080		C-RES,U 1K-1/16W J	LHSM	CX-NSZ300
X	MICON	R	0735 88-108-102-080		C-RES,U 1K-1/16W J	USM	CX-SNAJ300
X	MICON	R	0735 88-108-102-080		C-RES,U 1K-1/16W J	USM	CX-SNAJ305
X	MICON	R	0735 88-108-102-080		C-RES,U 1K-1/16W J	EZSM	CX-NSZ300
X	MICON	R	0735 88-108-102-080	OE	C-RES,U 1K-1/16W J	LHSM	CX-NSZ300
X	MICON	R	0735 88-108-102-080	OE	C-RES,U 1K-1/16W J	USM	CX-SNAJ300
X	MICON	R	0735 88-108-102-080	OE	C-RES,U 1K-1/16W J	USM	CX-SNAJ305
X	MICON	R	0740 88-108-102-080		C-RES,U 1K-1/16W J	LHSM	CX-NSZ300
X	MICON	R	0740 88-108-102-080		C-RES,U 1K-1/16W J	USM	CX-SNAJ300
X	MICON	R	0740 88-108-102-080		C-RES,U 1K-1/16W J	USM	CX-SNAJ305
X	MICON	R	0740 88-108-102-080		C-RES,U 1K-1/16W J	EZSM	CX-NSZ300
X	MICON	R	0740 88-108-102-080	OE	C-RES,U 1K-1/16W J	LHSM	CX-NSZ300
X	MICON	R	0740 88-108-102-080	OE	C-RES,U 1K-1/16W J	USM	CX-SNAJ300
X	MICON	R	0740 88-108-102-080	OE	C-RES,U 1K-1/16W J	USM	CX-SNAJ305
X	MICON	R	0741 88-121-101-080		RES,100-1/8W J	LHSM	CX-NSZ300
X	MICON	R	0741 88-121-101-080		RES,100-1/8W J	USM	CX-SNAJ300
X	MICON	R	0741 88-121-101-080		RES,100-1/8W J	USM	CX-SNAJ305

PARTS LIST

! = Δ SAFTY PARTS
 C = Components marked

All components used on this model at the production line are shown in this service manual.

However, please note that not all components will be available as spare parts for after-sales service.

Components marked S and O are designated as spare parts for service and will be stocked at the spare parts centers.

Components marked X and R are not designated as spare parts for after sales service, and will not be stocked at the spare parts centers.

K NO. = Only use japanese.

! C	UNIT NAME	REF NO.	PARTS CODE	K NO.	DESCRIPTION	SUFFIX	MODEL NAME
X	MICON	R	0741 88-121-101-080		RES,100-1/8W J	EZSM	CX-NSZ300
X	MICON	R	0741 88-121-101-080	OE	RES,100-1/8W J	LHSM	CX-NSZ300
X	MICON	R	0741 88-121-101-080	OE	RES,100-1/8W J	USM	CX-SNAJ300
X	MICON	R	0741 88-121-101-080	OE	RES,100-1/8W J	USM	CX-SNAJ305
X	MICON	R	0742 88-108-102-080		C-RES,U 1K-1/16W J	LHSM	CX-NSZ300
X	MICON	R	0742 88-108-102-080		C-RES,U 1K-1/16W J	USM	CX-SNAJ300
X	MICON	R	0742 88-108-102-080		C-RES,U 1K-1/16W J	USM	CX-SNAJ305
X	MICON	R	0742 88-108-102-080		C-RES,U 1K-1/16W J	EZSM	CX-NSZ300
X	MICON	R	0742 88-108-102-080	OE	C-RES,U 1K-1/16W J	LHSM	CX-NSZ300
X	MICON	R	0742 88-108-102-080	OE	C-RES,U 1K-1/16W J	USM	CX-SNAJ300
X	MICON	R	0742 88-108-102-080	OE	C-RES,U 1K-1/16W J	USM	CX-SNAJ300
X	MICON	R	0743 88-108-474-080		C-RES,U 470K-1/16W J	LHSM	CX-NSZ300
X	MICON	R	0743 88-108-474-080		C-RES,U 470K-1/16W J	USM	CX-SNAJ300
X	MICON	R	0743 88-108-474-080		C-RES,U 470K-1/16W J	USM	CX-SNAJ305
X	MICON	R	0743 88-108-474-080		C-RES,U 470K-1/16W J	EZSM	CX-NSZ300
X	MICON	R	0743 88-108-474-080	OE	C-RES,U 470K-1/16W J	LHSM	CX-NSZ300
X	MICON	R	0743 88-108-474-080	OE	C-RES,U 470K-1/16W J	USM	CX-SNAJ300
X	MICON	R	0743 88-108-474-080	OE	C-RES,U 470K-1/16W J	USM	CX-SNAJ305
X	MICON	R	0744 88-108-823-080		C-RES,U 82K-1/16W J	LHSM	CX-NSZ300
X	MICON	R	0744 88-108-823-080		C-RES,U 82K-1/16W J	USM	CX-SNAJ300
X	MICON	R	0744 88-108-823-080		C-RES,U 82K-1/16W J	USM	CX-SNAJ305
X	MICON	R	0744 88-108-823-080		C-RES,U 82K-1/16W J	EZSM	CX-NSZ300
X	MICON	R	0744 88-108-823-080	OE	C-RES,U 82K-1/16W J	LHSM	CX-NSZ300
X	MICON	R	0744 88-108-823-080	OE	C-RES,U 82K-1/16W J	USM	CX-SNAJ300
X	MICON	R	0744 88-108-823-080	OE	C-RES,U 82K-1/16W J	USM	CX-SNAJ305
X	MICON	R	0745 88-108-104-080		C-RES,U 100K-1/16W J	LHSM	CX-NSZ300
X	MICON	R	0745 88-108-104-080		C-RES,U 100K-1/16W J	USM	CX-SNAJ300
X	MICON	R	0745 88-108-104-080		C-RES,U 100K-1/16W J	USM	CX-SNAJ305
X	MICON	R	0745 88-108-104-080		C-RES,U 100K-1/16W J	EZSM	CX-NSZ300
X	MICON	R	0745 88-108-104-080	OE	C-RES,U 100K-1/16W J	LHSM	CX-NSZ300
X	MICON	R	0745 88-108-104-080	OE	C-RES,U 100K-1/16W J	USM	CX-SNAJ300
X	MICON	R	0745 88-108-104-080	OE	C-RES,U 100K-1/16W J	USM	CX-SNAJ305
X	MICON	R	0749 88-108-474-080		C-RES,U 470K-1/16W J	LHSM	CX-NSZ300
X	MICON	R	0749 88-108-474-080		C-RES,U 470K-1/16W J	USM	CX-SNAJ300
X	MICON	R	0749 88-108-474-080		C-RES,U 470K-1/16W J	EZSM	CX-NSZ300
X	MICON	R	0749 88-108-474-080	OE	C-RES,U 470K-1/16W J	LHSM	CX-NSZ300
X	MICON	R	0749 88-108-474-080	OE	C-RES,U 470K-1/16W J	USM	CX-SNAJ300
X	MICON	R	0749 88-108-474-080	OE	C-RES,U 470K-1/16W J	USM	CX-SNAJ305
X	MICON	R	0803 88-108-102-080		C-RES,U 1K-1/16W J	LHSM	CX-NSZ300
X	MICON	R	0803 88-108-102-080		C-RES,U 1K-1/16W J	USM	CX-SNAJ300
X	MICON	R	0803 88-108-102-080		C-RES,U 1K-1/16W J	USM	CX-SNAJ305
X	MICON	R	0803 88-108-102-080		C-RES,U 1K-1/16W J	EZSM	CX-NSZ300
X	MICON	R	0803 88-108-102-080	OE	C-RES,U 1K-1/16W J	LHSM	CX-NSZ300
X	MICON	R	0803 88-108-102-080	OE	C-RES,U 1K-1/16W J	USM	CX-SNAJ300
X	MICON	R	0803 88-108-102-080	OE	C-RES,U 1K-1/16W J	USM	CX-SNAJ305
X	MICON	R	0804 88-108-224-080		C-RES,U 220K-1/16W J	LHSM	CX-NSZ300
X	MICON	R	0804 88-108-224-080		C-RES,U 220K-1/16W J	USM	CX-SNAJ300
X	MICON	R	0804 88-108-224-080		C-RES,U 220K-1/16W J	USM	CX-SNAJ305
X	MICON	R	0804 88-108-224-080		C-RES,U 220K-1/16W J	EZSM	CX-NSZ300
X	MICON	R	0804 88-108-224-080	OE	C-RES,U 220K-1/16W J	LHSM	CX-NSZ300
X	MICON	R	0804 88-108-224-080	OE	C-RES,U 220K-1/16W J	USM	CX-SNAJ300
X	MICON	R	0804 88-108-224-080	OE	C-RES,U 220K-1/16W J	USM	CX-SNAJ305
X	MICON	R	0805 88-108-273-080		C-RES,U 27K-1/16W J	LHSM	CX-NSZ300
X	MICON	R	0805 88-108-273-080		C-RES,U 27K-1/16W J	USM	CX-SNAJ300
X	MICON	R	0805 88-108-273-080		C-RES,U 27K-1/16W J	USM	CX-SNAJ305
X	MICON	R	0805 88-108-273-080		C-RES,U 27K-1/16W J	EZSM	CX-NSZ300
X	MICON	R	0805 88-108-273-080	OE	C-RES,U 27K-1/16W J	LHSM	CX-NSZ300
X	MICON	R	0805 88-108-273-080	OE	C-RES,U 27K-1/16W J	USM	CX-SNAJ300
X	MICON	R	0805 88-108-273-080	OE	C-RES,U 27K-1/16W J	USM	CX-SNAJ305
X	MICON	R	0806 88-108-562-080		C-RES,U 5.6K-1/16W J	LHSM	CX-NSZ300
X	MICON	R	0806 88-108-562-080		C-RES,U 5.6K-1/16W J	USM	CX-SNAJ300
X	MICON	R	0806 88-108-562-080		C-RES,U 5.6K-1/16W J	USM	CX-SNAJ305
X	MICON	R	0806 88-108-562-080		C-RES,U 5.6K-1/16W J	EZSM	CX-NSZ300
X	MICON	R	0806 88-108-562-080	OE	C-RES,U 5.6K-1/16W J	LHSM	CX-NSZ300
X	MICON	R	0806 88-108-562-080	OE	C-RES,U 5.6K-1/16W J	USM	CX-SNAJ300
X	MICON	R	0806 88-108-562-080	OE	C-RES,U 5.6K-1/16W J	USM	CX-SNAJ305
X	MICON	R	0807 88-108-000-080		C-JUMPER,U	LHSM	CX-NSZ300
X	MICON	R	0807 88-108-000-080		C-JUMPER,U	USM	CX-SNAJ300
X	MICON	R	0807 88-108-000-080		C-JUMPER,U	USM	CX-SNAJ305
X	MICON	R	0807 88-108-000-080		C-JUMPER,U	EZSM	CX-NSZ300
X	MICON	R	0807 88-108-000-080	OE	C-JUMPER,U	LHSM	CX-NSZ300
X	MICON	R	0807 88-108-000-080	OE	C-JUMPER,U	USM	CX-SNAJ300

PARTS LIST

! = Δ SAFTY PARTS
 C = Components marked

All components used on this model at the production line are shown in this service manual.

However, please note that not all components will be available as spare parts for after-sales service.

Components marked S and O are designated as spare parts for service and will be stocked at the spare parts centers.

Components marked X and R are not designated as spare parts for after sales service, and will not be stocked at the spare parts centers.

K NO. = Only use japanese.

! C	UNIT NAME	REF NO.	PARTS CODE	K NO.	DESCRIPTION	SUFFIX	MODEL NAME
X	MICON	R	0807 88-108-000-080	OE	C-JUMPER,U	USM	CX-SNAJ305
X	MICON	R	0808 88-128-101-080		C-RES, 100-1/8W J	LHSM	CX-NSZ300
X	MICON	R	0808 88-128-101-080		C-RES, 100-1/8W J	USM	CX-SNAJ300
X	MICON	R	0808 88-128-101-080		C-RES, 100-1/8W J	USM	CX-SNAJ305
X	MICON	R	0808 88-128-101-080		C-RES, 100-1/8W J	EZSM	CX-NSZ300
X	MICON	R	0808 88-128-101-080	OE	C-RES, 100-1/8W J	LHSM	CX-NSZ300
X	MICON	R	0808 88-128-101-080	OE	C-RES, 100-1/8W J	USM	CX-SNAJ300
X	MICON	R	0808 88-128-101-080	OE	C-RES, 100-1/8W J	USM	CX-SNAJ305
X	MICON	R	0809 88-108-102-080		C-RES,U 1K-1/16W J	LHSM	CX-NSZ300
X	MICON	R	0809 88-108-102-080		C-RES,U 1K-1/16W J	USM	CX-SNAJ300
X	MICON	R	0809 88-108-102-080		C-RES,U 1K-1/16W J		
X	MICON	R	0809 88-108-102-080	OE	C-RES,U 1K-1/16W J	LHSM	CX-NSZ300
X	MICON	R	0809 88-108-102-080	OE	C-RES,U 1K-1/16W J	USM	CX-SNAJ300
X	MICON	R	0809 88-108-102-080	OE	C-RES,U 1K-1/16W J	USM	CX-SNAJ305
X	MICON	R	0810 88-108-272-080		C-RES,U 2.7K-1/16W J	LHSM	CX-NSZ300
X	MICON	R	0810 88-108-272-080		C-RES,U 2.7K-1/16W J	USM	CX-SNAJ300
X	MICON	R	0810 88-108-272-080		C-RES,U 2.7K-1/16W J	USM	CX-SNAJ305
X	MICON	R	0810 88-108-272-080		C-RES,U 2.7K-1/16W J	EZSM	CX-NSZ300
X	MICON	R	0810 88-108-272-080	OE	C-RES,U 2.7K-1/16W J	LHSM	CX-NSZ300
X	MICON	R	0810 88-108-272-080	OE	C-RES,U 2.7K-1/16W J	USM	CX-SNAJ300
X	MICON	R	0810 88-108-272-080	OE	C-RES,U 2.7K-1/16W J	USM	CX-SNAJ305
X	MICON	R	0811 88-108-104-080		C-RES,U 100K-1/16W J	LHSM	CX-NSZ300
X	MICON	R	0811 88-108-104-080		C-RES,U 100K-1/16W J	USM	CX-SNAJ300
X	MICON	R	0811 88-108-104-080		C-RES,U 100K-1/16W J	USM	CX-SNAJ305
X	MICON	R	0811 88-108-104-080		C-RES,U 100K-1/16W J	EZSM	CX-NSZ300
X	MICON	R	0811 88-108-104-080	OE	C-RES,U 100K-1/16W J	LHSM	CX-NSZ300
X	MICON	R	0811 88-108-104-080	OE	C-RES,U 100K-1/16W J	USM	CX-SNAJ300
X	MICON	R	0811 88-108-104-080	OE	C-RES,U 100K-1/16W J	USM	CX-SNAJ305
X	MICON	R	0813 88-108-223-080		C-RES,U 22K-1/16W J	EZSM	CX-NSZ300
X	MICON	R	0813 88-108-223-080	OE	C-RES,U 22K-1/16W J	LHSM	CX-NSZ300
X	MICON	R	0813 88-108-223-080	OE	C-RES,U 22K-1/16W J	USM	CX-SNAJ300
X	MICON	R	0813 88-108-223-080	OE	C-RES,U 22K-1/16W J	USM	CX-SNAJ305
X	MICON	R	0813 88-108-683-080		C-RES,U 68K-1/16W J	LHSM	CX-NSZ300
X	MICON	R	0813 88-108-683-080		C-RES,U 68K-1/16W J	USM	CX-SNAJ300
X	MICON	R	0813 88-108-683-080		C-RES,U 68K-1/16W J	USM	CX-SNAJ305
X	MICON	R	0815 88-108-272-080		C-RES,U 2.7K-1/16W J	LHSM	CX-NSZ300
X	MICON	R	0815 88-108-272-080		C-RES,U 2.7K-1/16W J	USM	CX-SNAJ300
X	MICON	R	0815 88-108-272-080		C-RES,U 2.7K-1/16W J	USM	CX-SNAJ305
X	MICON	R	0815 88-108-272-080		C-RES,U 2.7K-1/16W J	EZSM	CX-NSZ300
X	MICON	R	0815 88-108-272-080	OE	C-RES,U 2.7K-1/16W J	LHSM	CX-NSZ300
X	MICON	R	0815 88-108-272-080	OE	C-RES,U 2.7K-1/16W J	USM	CX-SNAJ300
X	MICON	R	0815 88-108-272-080	OE	C-RES,U 2.7K-1/16W J	USM	CX-SNAJ305
X	MICON	R	0816 88-108-104-080		C-RES,U 100K-1/16W J	LHSM	CX-NSZ300
X	MICON	R	0816 88-108-104-080		C-RES,U 100K-1/16W J	USM	CX-SNAJ300
X	MICON	R	0816 88-108-104-080		C-RES,U 100K-1/16W J	USM	CX-SNAJ305
X	MICON	R	0816 88-108-104-080		C-RES,U 100K-1/16W J	EZSM	CX-NSZ300
X	MICON	R	0816 88-108-104-080	OE	C-RES,U 100K-1/16W J	LHSM	CX-NSZ300
X	MICON	R	0816 88-108-104-080	OE	C-RES,U 100K-1/16W J	USM	CX-SNAJ300
X	MICON	R	0816 88-108-104-080	OE	C-RES,U 100K-1/16W J	USM	CX-SNAJ305
X	MICON	R	0818 88-108-223-080		C-RES,U 22K-1/16W J	EZSM	CX-NSZ300
X	MICON	R	0818 88-108-223-080	OE	C-RES,U 22K-1/16W J	LHSM	CX-NSZ300
X	MICON	R	0818 88-108-223-080	OE	C-RES,U 22K-1/16W J	USM	CX-SNAJ300
X	MICON	R	0818 88-108-223-080	OE	C-RES,U 22K-1/16W J	USM	CX-SNAJ305
X	MICON	R	0818 88-108-683-080		C-RES,U 68K-1/16W J	LHSM	CX-NSZ300
X	MICON	R	0818 88-108-683-080		C-RES,U 68K-1/16W J	USM	CX-SNAJ300
X	MICON	R	0818 88-108-683-080		C-RES,U 68K-1/16W J	USM	CX-SNAJ305
X	MICON	R	0819 88-108-272-080		C-RES,U 2.7K-1/16W J	LHSM	CX-NSZ300
X	MICON	R	0819 88-108-272-080		C-RES,U 2.7K-1/16W J	USM	CX-SNAJ300
X	MICON	R	0819 88-108-272-080		C-RES,U 2.7K-1/16W J	USM	CX-SNAJ305
X	MICON	R	0819 88-108-272-080	OE	C-RES,U 2.7K-1/16W J	EZSM	CX-NSZ300
X	MICON	R	0819 88-108-272-080	OE	C-RES,U 2.7K-1/16W J	LHSM	CX-NSZ300
X	MICON	R	0819 88-108-272-080	OE	C-RES,U 2.7K-1/16W J	USM	CX-SNAJ300
X	MICON	R	0819 88-108-272-080	OE	C-RES,U 2.7K-1/16W J	USM	CX-SNAJ305
X	MICON	R	0821 88-108-104-080		C-RES,U 100K-1/16W J	LHSM	CX-NSZ300
X	MICON	R	0821 88-108-104-080		C-RES,U 100K-1/16W J	USM	CX-SNAJ300
X	MICON	R	0821 88-108-104-080		C-RES,U 100K-1/16W J	USM	CX-SNAJ305
X	MICON	R	0821 88-108-104-080		C-RES,U 100K-1/16W J	EZSM	CX-NSZ300
X	MICON	R	0821 88-108-104-080	OE	C-RES,U 100K-1/16W J	LHSM	CX-NSZ300
X	MICON	R	0821 88-108-104-080	OE	C-RES,U 100K-1/16W J	USM	CX-SNAJ300

PARTS LIST

! = Δ SAFTY PARTS
 C = Components marked

All components used on this model at the production line are shown in this service manual.
 However, please note that not all components will be available as spare parts for after-sales service.
 Components marked S and O are designated as spare parts for service and will be stocked at the spare parts centers.
 Components marked X and R are not designated as spare parts for after sales service, and will not be stocked at the spare parts centers.

K NO. = Only use japanese.

! C	UNIT NAME	REF NO.	PARTS CODE	K NO.	DESCRIPTION	SUFFIX	MODEL NAME
X	MICON	R	0821 88-108-104-080	OE	C-RES,U 100K-1/16W J	USM	CX-SNAJ305
X	MICON	R	0822 88-108-223-080		C-RES,U 22K-1/16W J	EZSM	CX-NSZ300
X	MICON	R	0822 88-108-223-080	OE	C-RES,U 22K-1/16W J	LHSM	CX-NSZ300
X	MICON	R	0822 88-108-223-080	OE	C-RES,U 22K-1/16W J	USM	CX-SNAJ300
X	MICON	R	0822 88-108-223-080	OE	C-RES,U 22K-1/16W J	USM	CX-SNAJ305
X	MICON	R	0822 88-108-683-080		C-RES,U 68K-1/16W J	LHSM	CX-NSZ300
X	MICON	R	0822 88-108-683-080		C-RES,U 68K-1/16W J	USM	CX-SNAJ300
X	MICON	R	0822 88-108-683-080		C-RES,U 68K-1/16W J	USM	CX-SNAJ305
X	MICON	R	0823 88-108-101-080		C-RES,U 100-1/16W J	LHSM	CX-NSZ300
X	MICON	R	0823 88-108-101-080		C-RES,U 100-1/16W J	USM	CX-SNAJ300
X	MICON	R	0823 88-108-101-080		C-RES,U 100-1/16W J	USM	CX-SNAJ305
X	MICON	R	0823 88-108-101-080		C-RES,U 100-1/16W J	EZSM	CX-NSZ300
X	MICON	R	0823 88-108-101-080	OE	C-RES,U 100-1/16W J	LHSM	CX-NSZ300
X	MICON	R	0823 88-108-101-080	OE	C-RES,U 100-1/16W J	USM	CX-SNAJ300
X	MICON	R	0823 88-108-101-080	OE	C-RES,U 100-1/16W J	USM	CX-SNAJ305
X	MICON	R	0824 88-108-101-080		C-RES,U 100-1/16W J	USM	CX-SNAJ300
X	MICON	R	0824 88-108-101-080		C-RES,U 100-1/16W J	USM	CX-SNAJ305
X	MICON	R	0824 88-108-101-080		C-RES,U 100-1/16W J	EZSM	CX-NSZ300
X	MICON	R	0824 88-108-101-080	OE	C-RES,U 100-1/16W J	LHSM	CX-NSZ300
X	MICON	R	0824 88-108-101-080	OE	C-RES,U 100-1/16W J	USM	CX-SNAJ300
X	MICON	R	0824 88-108-101-080	OE	C-RES,U 100-1/16W J	USM	CX-SNAJ305
X	MICON	R	0825 88-108-101-080		C-RES,U 100-1/16W J	LHSM	CX-NSZ300
X	MICON	R	0825 88-108-101-080		C-RES,U 100-1/16W J	USM	CX-SNAJ300
X	MICON	R	0825 88-108-101-080		C-RES,U 100-1/16W J	USM	CX-SNAJ305
X	MICON	R	0825 88-108-101-080		C-RES,U 100-1/16W J	EZSM	CX-NSZ300
X	MICON	R	0825 88-108-101-080	OE	C-RES,U 100-1/16W J	LHSM	CX-NSZ300
X	MICON	R	0825 88-108-101-080	OE	C-RES,U 100-1/16W J	USM	CX-SNAJ300
X	MICON	R	0825 88-108-101-080	OE	C-RES,U 100-1/16W J	USM	CX-SNAJ305
X	MICON	R	0826 88-108-000-080		C-JUMPER,U	LHSM	CX-NSZ300
X	MICON	R	0826 88-108-000-080		C-JUMPER,U	USM	CX-SNAJ300
X	MICON	R	0826 88-108-000-080		C-JUMPER,U	USM	CX-SNAJ305
X	MICON	R	0826 88-108-000-080		C-JUMPER,U	EZSM	CX-NSZ300
X	MICON	R	0826 88-108-000-080	OE	C-JUMPER,U	LHSM	CX-NSZ300
X	MICON	R	0826 88-108-000-080	OE	C-JUMPER,U	USM	CX-SNAJ300
X	MICON	R	0826 88-108-000-080	OE	C-JUMPER,U	USM	CX-SNAJ305
X	MICON	R	0827 88-108-103-080		C-RES,U 10K-1/16W J	LHSM	CX-NSZ300
X	MICON	R	0827 88-108-103-080		C-RES,U 10K-1/16W J	USM	CX-SNAJ300
X	MICON	R	0827 88-108-103-080		C-RES,U 10K-1/16W J	USM	CX-SNAJ305
X	MICON	R	0827 88-108-103-080		C-RES,U 10K-1/16W J	EZSM	CX-NSZ300
X	MICON	R	0827 88-108-103-080	OE	C-RES,U 10K-1/16W J	LHSM	CX-NSZ300
X	MICON	R	0827 88-108-103-080	OE	C-RES,U 10K-1/16W J	USM	CX-SNAJ300
X	MICON	R	0827 88-108-103-080	OE	C-RES,U 10K-1/16W J	USM	CX-SNAJ305
X	MICON	R	0901 88-108-104-080		C-RES,U 100K-1/16W J	LHSM	CX-NSZ300
X	MICON	R	0901 88-108-104-080		C-RES,U 100K-1/16W J	USM	CX-SNAJ300
X	MICON	R	0901 88-108-104-080		C-RES,U 100K-1/16W J	USM	CX-SNAJ305
X	MICON	R	0901 88-108-104-080		C-RES,U 100K-1/16W J	EZSM	CX-NSZ300
X	MICON	R	0901 88-108-104-080	OE	C-RES,U 100K-1/16W J	LHSM	CX-NSZ300
X	MICON	R	0901 88-108-104-080	OE	C-RES,U 100K-1/16W J	USM	CX-SNAJ300
X	MICON	R	0901 88-108-104-080	OE	C-RES,U 100K-1/16W J	USM	CX-SNAJ305
X	MICON	R	0902 88-108-104-080		C-RES,U 100K-1/16W J	LHSM	CX-NSZ300
X	MICON	R	0902 88-108-104-080		C-RES,U 100K-1/16W J	USM	CX-SNAJ300
X	MICON	R	0902 88-108-104-080		C-RES,U 100K-1/16W J	USM	CX-SNAJ305
X	MICON	R	0902 88-108-104-080		C-RES,U 100K-1/16W J	EZSM	CX-NSZ300
X	MICON	R	0902 88-108-104-080	OE	C-RES,U 100K-1/16W J	LHSM	CX-NSZ300
X	MICON	R	0902 88-108-104-080	OE	C-RES,U 100K-1/16W J	USM	CX-SNAJ300
X	MICON	R	0902 88-108-104-080	OE	C-RES,U 100K-1/16W J	USM	CX-SNAJ305
X	MICON	R	0903 88-108-104-080		C-RES,U 100K-1/16W J	LHSM	CX-NSZ300
X	MICON	R	0903 88-108-104-080		C-RES,U 100K-1/16W J	USM	CX-SNAJ300
X	MICON	R	0903 88-108-104-080		C-RES,U 100K-1/16W J	USM	CX-SNAJ305
X	MICON	R	0903 88-108-104-080		C-RES,U 100K-1/16W J	EZSM	CX-NSZ300
X	MICON	R	0903 88-108-104-080	OE	C-RES,U 100K-1/16W J	LHSM	CX-NSZ300
X	MICON	R	0903 88-108-104-080	OE	C-RES,U 100K-1/16W J	USM	CX-SNAJ300
X	MICON	R	0903 88-108-104-080	OE	C-RES,U 100K-1/16W J	USM	CX-SNAJ305
X	MICON	R	0904 88-108-104-080		C-RES,U 100K-1/16W J	USM	CX-SNAJ300
X	MICON	R	0904 88-108-104-080		C-RES,U 100K-1/16W J	LHSM	CX-NSZ300
X	MICON	R	0904 88-108-104-080		C-RES,U 100K-1/16W J	USM	CX-SNAJ300
X	MICON	R	0904 88-108-104-080		C-RES,U 100K-1/16W J	USM	CX-SNAJ305
X	MICON	R	0904 88-108-104-080		C-RES,U 100K-1/16W J	EZSM	CX-NSZ300
X	MICON	R	0904 88-108-104-080	OE	C-RES,U 100K-1/16W J	LHSM	CX-NSZ300
X	MICON	R	0904 88-108-104-080	OE	C-RES,U 100K-1/16W J	USM	CX-SNAJ300

PARTS LIST

! = Δ SAFTY PARTS
 C = Components marked

All components used on this model at the production line are shown in this service manual.

However, please note that not all components will be available as spare parts for after-sales service.

Components marked S and O are designated as spare parts for service and will be stocked at the spare parts centers.

Components marked X and R are not designated as spare parts for after sales service, and will not be stocked at the spare parts centers.

K NO. = Only use japanese.

! C	UNIT NAME	REF NO.	PARTS CODE	K NO.	DESCRIPTION	SUFFIX	MODEL NAME
X	MICON	R	0904 88-108-104-080	OE	C-RES,U 100K-1/16W J	USM	CX-SNAJ305
X	MICON	R	0905 88-108-104-080		C-RES,U 100K-1/16W J	LHSM	CX-NSZ300
X	MICON	R	0905 88-108-104-080		C-RES,U 100K-1/16W J	USM	CX-SNAJ300
X	MICON	R	0905 88-108-104-080		C-RES,U 100K-1/16W J	USM	CX-SNAJ305
X	MICON	R	0905 88-108-104-080		C-RES,U 100K-1/16W J	EZSM	CX-NSZ300
X	MICON	R	0905 88-108-104-080	OE	C-RES,U 100K-1/16W J	LHSM	CX-NSZ300
X	MICON	R	0905 88-108-104-080	OE	C-RES,U 100K-1/16W J	USM	CX-SNAJ300
X	MICON	R	0905 88-108-104-080	OE	C-RES,U 100K-1/16W J	USM	CX-SNAJ305
X	MICON	R	0906 88-108-104-080		C-RES,U 100K-1/16W J	LHSM	CX-NSZ300
X	MICON	R	0906 88-108-104-080		C-RES,U 100K-1/16W J	USM	CX-SNAJ300
X	MICON	R	0906 88-108-104-080		C-RES,U 100K-1/16W J	USM	CX-SNAJ305
X	MICON	R	0906 88-108-104-080		C-RES,U 100K-1/16W J	EZSM	CX-NSZ300
X	MICON	R	0906 88-108-104-080	OE	C-RES,U 100K-1/16W J	LHSM	CX-NSZ300
X	MICON	R	0906 88-108-104-080	OE	C-RES,U 100K-1/16W J	USM	CX-SNAJ300
X	MICON	R	0906 88-108-104-080	OE	C-RES,U 100K-1/16W J	USM	CX-SNAJ305
X	MICON	R	0907 88-108-104-080		C-RES,U 100K-1/16W J	USM	CX-SNAJ300
X	MICON	R	0907 88-108-104-080		C-RES,U 100K-1/16W J	LHSM	CX-NSZ300
X	MICON	R	0907 88-108-104-080		C-RES,U 100K-1/16W J	USM	CX-SNAJ305
X	MICON	R	0907 88-108-104-080		C-RES,U 100K-1/16W J	USM	CX-SNAJ300
X	MICON	R	0907 88-108-104-080	OE	C-RES,U 100K-1/16W J	EZSM	CX-NSZ300
X	MICON	R	0907 88-108-104-080	OE	C-RES,U 100K-1/16W J	LHSM	CX-NSZ300
X	MICON	R	0907 88-108-104-080	OE	C-RES,U 100K-1/16W J	USM	CX-SNAJ300
X	MICON	R	0907 88-108-104-080	OE	C-RES,U 100K-1/16W J	USM	CX-SNAJ305
X	MICON	R	0908 88-108-104-080		C-RES,U 100K-1/16W J	LHSM	CX-NSZ300
X	MICON	R	0908 88-108-104-080		C-RES,U 100K-1/16W J	USM	CX-SNAJ300
X	MICON	R	0908 88-108-104-080		C-RES,U 100K-1/16W J	USM	CX-SNAJ305
X	MICON	R	0908 88-108-104-080		C-RES,U 100K-1/16W J	EZSM	CX-NSZ300
X	MICON	R	0908 88-108-104-080	OE	C-RES,U 100K-1/16W J	LHSM	CX-NSZ300
X	MICON	R	0908 88-108-104-080	OE	C-RES,U 100K-1/16W J	USM	CX-SNAJ300
X	MICON	R	0908 88-108-104-080	OE	C-RES,U 100K-1/16W J	USM	CX-SNAJ305
X	MICON	R	0909 88-108-104-080		C-RES,U 100K-1/16W J	LHSM	CX-NSZ300
X	MICON	R	0909 88-108-104-080		C-RES,U 100K-1/16W J	USM	CX-SNAJ300
X	MICON	R	0909 88-108-104-080		C-RES,U 100K-1/16W J	USM	CX-SNAJ305
X	MICON	R	0909 88-108-104-080	OE	C-RES,U 100K-1/16W J	LHSM	CX-NSZ300
X	MICON	R	0909 88-108-104-080	OE	C-RES,U 100K-1/16W J	USM	CX-SNAJ300
X	MICON	R	0909 88-108-104-080	OE	C-RES,U 100K-1/16W J	USM	CX-SNAJ305
X	MICON	R	0910 88-108-104-080		C-RES,U 100K-1/16W J	LHSM	CX-NSZ300
X	MICON	R	0910 88-108-104-080		C-RES,U 100K-1/16W J	USM	CX-SNAJ300
X	MICON	R	0910 88-108-104-080		C-RES,U 100K-1/16W J	USM	CX-SNAJ305
X	MICON	R	0910 88-108-104-080		C-RES,U 100K-1/16W J	EZSM	CX-NSZ300
X	MICON	R	0910 88-108-104-080	OE	C-RES,U 100K-1/16W J	LHSM	CX-NSZ300
X	MICON	R	0910 88-108-104-080	OE	C-RES,U 100K-1/16W J	USM	CX-SNAJ300
X	MICON	R	0910 88-108-104-080	OE	C-RES,U 100K-1/16W J	USM	CX-SNAJ305
X	MICON	R	0911 88-108-104-080		C-RES,U 100K-1/16W J	LHSM	CX-NSZ300
X	MICON	R	0911 88-108-104-080		C-RES,U 100K-1/16W J	USM	CX-SNAJ300
X	MICON	R	0911 88-108-104-080		C-RES,U 100K-1/16W J	USM	CX-SNAJ305
X	MICON	R	0911 88-108-104-080		C-RES,U 100K-1/16W J	EZSM	CX-NSZ300
X	MICON	R	0911 88-108-104-080	OE	C-RES,U 100K-1/16W J	LHSM	CX-NSZ300
X	MICON	R	0911 88-108-104-080	OE	C-RES,U 100K-1/16W J	USM	CX-SNAJ300
X	MICON	R	0911 88-108-104-080	OE	C-RES,U 100K-1/16W J	USM	CX-SNAJ305
X	MICON	R	0912 88-108-104-080		C-RES,U 100K-1/16W J	LHSM	CX-NSZ300
X	MICON	R	0912 88-108-104-080		C-RES,U 100K-1/16W J	USM	CX-SNAJ300
X	MICON	R	0912 88-108-104-080		C-RES,U 100K-1/16W J	USM	CX-SNAJ305
X	MICON	R	0912 88-108-104-080		C-RES,U 100K-1/16W J	EZSM	CX-NSZ300
X	MICON	R	0912 88-108-104-080	OE	C-RES,U 100K-1/16W J	LHSM	CX-NSZ300
X	MICON	R	0912 88-108-104-080	OE	C-RES,U 100K-1/16W J	USM	CX-SNAJ300
X	MICON	R	0912 88-108-104-080	OE	C-RES,U 100K-1/16W J	USM	CX-SNAJ305
X	MICON	R	0913 88-108-104-080		C-RES,U 100K-1/16W J	LHSM	CX-NSZ300
X	MICON	R	0913 88-108-104-080		C-RES,U 100K-1/16W J	USM	CX-SNAJ300
X	MICON	R	0913 88-108-104-080		C-RES,U 100K-1/16W J	USM	CX-SNAJ305
X	MICON	R	0913 88-108-104-080		C-RES,U 100K-1/16W J	EZSM	CX-NSZ300
X	MICON	R	0913 88-108-104-080	OE	C-RES,U 100K-1/16W J	LHSM	CX-NSZ300
X	MICON	R	0913 88-108-104-080	OE	C-RES,U 100K-1/16W J	USM	CX-SNAJ300
X	MICON	R	0913 88-108-104-080	OE	C-RES,U 100K-1/16W J	USM	CX-SNAJ305
X	MICON	R	0914 88-108-104-080		C-RES,U 100K-1/16W J	LHSM	CX-NSZ300
X	MICON	R	0914 88-108-104-080		C-RES,U 100K-1/16W J	USM	CX-SNAJ300
X	MICON	R	0914 88-108-104-080		C-RES,U 100K-1/16W J	USM	CX-SNAJ305
X	MICON	R	0914 88-108-104-080		C-RES,U 100K-1/16W J	EZSM	CX-NSZ300
X	MICON	R	0914 88-108-104-080	OE	C-RES,U 100K-1/16W J	LHSM	CX-NSZ300
X	MICON	R	0914 88-108-104-080	OE	C-RES,U 100K-1/16W J	USM	CX-SNAJ300

PARTS LIST

! = Δ SAFTY PARTS
 C = Components marked

All components used on this model at the production line are shown in this service manual.

However, please note that not all components will be available as spare parts for after-sales service.

Components marked S and O are designated as spare parts for service and will be stocked at the spare parts centers.

Components marked X and R are not designated as spare parts for after sales service, and will not be stocked at the spare parts centers.

K NO. = Only use japanese.

! C	UNIT NAME	REF NO.	PARTS CODE	K NO.	DESCRIPTION	SUFFIX	MODEL NAME
X	MICON	R	0914 88-108-104-080	OE	C-RES,U 100K-1/16W J	USM	CX-SNAJ305
X	MICON	R	0915 88-108-104-080		C-RES,U 100K-1/16W J	LHSM	CX-NSZ300
X	MICON	R	0915 88-108-104-080		C-RES,U 100K-1/16W J	USM	CX-SNAJ300
X	MICON	R	0915 88-108-104-080		C-RES,U 100K-1/16W J	USM	CX-SNAJ305
X	MICON	R	0915 88-108-104-080		C-RES,U 100K-1/16W J	EZSM	CX-NSZ300
X	MICON	R	0915 88-108-104-080	OE	C-RES,U 100K-1/16W J	LHSM	CX-NSZ300
X	MICON	R	0915 88-108-104-080	OE	C-RES,U 100K-1/16W J	USM	CX-SNAJ300
X	MICON	R	0915 88-108-104-080	OE	C-RES,U 100K-1/16W J	USM	CX-SNAJ305
X	MICON	R	0916 88-108-104-080		C-RES,U 100K-1/16W J	LHSM	CX-NSZ300
X	MICON	R	0916 88-108-104-080		C-RES,U 100K-1/16W J	USM	CX-SNAJ300
X	MICON	R	0916 88-108-104-080		C-RES,U 100K-1/16W J	USM	CX-SNAJ305
X	MICON	R	0916 88-108-104-080		C-RES,U 100K-1/16W J	EZSM	CX-NSZ300
X	MICON	R	0916 88-108-104-080	OE	C-RES,U 100K-1/16W J	LHSM	CX-NSZ300
X	MICON	R	0916 88-108-104-080	OE	C-RES,U 100K-1/16W J	USM	CX-SNAJ300
X	MICON	R	0916 88-108-104-080	OE	C-RES,U 100K-1/16W J	USM	CX-SNAJ305
X	MICON	R	0917 88-108-104-080		C-RES,U 100K-1/16W J	LHSM	CX-NSZ300
X	MICON	R	0917 88-108-104-080		C-RES,U 100K-1/16W J	USM	CX-SNAJ300
X	MICON	R	0917 88-108-104-080		C-RES,U 100K-1/16W J	USM	CX-SNAJ305
X	MICON	R	0917 88-108-104-080		C-RES,U 100K-1/16W J	EZSM	CX-NSZ300
X	MICON	R	0917 88-108-104-080	OE	C-RES,U 100K-1/16W J	LHSM	CX-NSZ300
X	MICON	R	0917 88-108-104-080	OE	C-RES,U 100K-1/16W J	USM	CX-SNAJ300
X	MICON	R	0917 88-108-104-080	OE	C-RES,U 100K-1/16W J	USM	CX-SNAJ305
X	MICON	R	0918 88-108-104-080		C-RES,U 100K-1/16W J	LHSM	CX-NSZ300
X	MICON	R	0918 88-108-104-080		C-RES,U 100K-1/16W J	USM	CX-SNAJ300
X	MICON	R	0918 88-108-104-080		C-RES,U 100K-1/16W J	USM	CX-SNAJ305
X	MICON	R	0918 88-108-104-080		C-RES,U 100K-1/16W J	EZSM	CX-NSZ300
X	MICON	R	0918 88-108-104-080	OE	C-RES,U 100K-1/16W J	LHSM	CX-NSZ300
X	MICON	R	0918 88-108-104-080	OE	C-RES,U 100K-1/16W J	USM	CX-SNAJ300
X	MICON	R	0918 88-108-104-080	OE	C-RES,U 100K-1/16W J	USM	CX-SNAJ305
X	MICON	R	0919 88-108-104-080		C-RES,U 100K-1/16W J	LHSM	CX-NSZ300
X	MICON	R	0919 88-108-104-080		C-RES,U 100K-1/16W J	USM	CX-SNAJ300
X	MICON	R	0919 88-108-104-080		C-RES,U 100K-1/16W J	USM	CX-SNAJ305
X	MICON	R	0919 88-108-104-080	OE	C-RES,U 100K-1/16W J	EZSM	CX-NSZ300
X	MICON	R	0919 88-108-104-080	OE	C-RES,U 100K-1/16W J	LHSM	CX-NSZ300
X	MICON	R	0919 88-108-104-080	OE	C-RES,U 100K-1/16W J	USM	CX-SNAJ300
X	MICON	R	0919 88-108-104-080	OE	C-RES,U 100K-1/16W J	USM	CX-SNAJ305
X	MICON	R	0920 88-108-104-080		C-RES,U 100K-1/16W J	LHSM	CX-NSZ300
X	MICON	R	0920 88-108-104-080		C-RES,U 100K-1/16W J	USM	CX-SNAJ300
X	MICON	R	0920 88-108-104-080		C-RES,U 100K-1/16W J	USM	CX-SNAJ305
X	MICON	R	0920 88-108-104-080		C-RES,U 100K-1/16W J	EZSM	CX-NSZ300
X	MICON	R	0920 88-108-104-080	OE	C-RES,U 100K-1/16W J	LHSM	CX-NSZ300
X	MICON	R	0920 88-108-104-080	OE	C-RES,U 100K-1/16W J	USM	CX-SNAJ300
X	MICON	R	0920 88-108-104-080	OE	C-RES,U 100K-1/16W J	USM	CX-SNAJ305
X	MICON	R	0921 88-108-104-080		C-RES,U 100K-1/16W J	LHSM	CX-NSZ300
X	MICON	R	0921 88-108-104-080		C-RES,U 100K-1/16W J	USM	CX-SNAJ300
X	MICON	R	0921 88-108-104-080		C-RES,U 100K-1/16W J	USM	CX-SNAJ305
X	MICON	R	0921 88-108-104-080		C-RES,U 100K-1/16W J	LHSM	CX-NSZ300
X	MICON	R	0921 88-108-104-080		C-RES,U 100K-1/16W J	USM	CX-SNAJ300
X	MICON	R	0921 88-108-104-080		C-RES,U 100K-1/16W J	USM	CX-SNAJ305
X	MICON	R	0921 88-108-104-080	OE	C-RES,U 100K-1/16W J	LHSM	CX-NSZ300
X	MICON	R	0921 88-108-104-080	OE	C-RES,U 100K-1/16W J	USM	CX-SNAJ300
X	MICON	R	0921 88-108-104-080	OE	C-RES,U 100K-1/16W J	USM	CX-SNAJ305
X	MICON	R	0922 88-108-104-080		C-RES,U 100K-1/16W J	LHSM	CX-NSZ300
X	MICON	R	0922 88-108-104-080		C-RES,U 100K-1/16W J	USM	CX-SNAJ300
X	MICON	R	0922 88-108-104-080		C-RES,U 100K-1/16W J	USM	CX-SNAJ305
X	MICON	R	0922 88-108-104-080		C-RES,U 100K-1/16W J	EZSM	CX-NSZ300
X	MICON	R	0922 88-108-104-080	OE	C-RES,U 100K-1/16W J	LHSM	CX-NSZ300
X	MICON	R	0922 88-108-104-080	OE	C-RES,U 100K-1/16W J	USM	CX-SNAJ300
X	MICON	R	0922 88-108-104-080	OE	C-RES,U 100K-1/16W J	USM	CX-SNAJ305
X	MICON	R	0923 88-108-104-080		C-RES,U 100K-1/16W J	LHSM	CX-NSZ300
X	MICON	R	0923 88-108-104-080		C-RES,U 100K-1/16W J	USM	CX-SNAJ300
X	MICON	R	0923 88-108-104-080		C-RES,U 100K-1/16W J	USM	CX-SNAJ305
X	MICON	R	0923 88-108-104-080		C-RES,U 100K-1/16W J	EZSM	CX-NSZ300
X	MICON	R	0923 88-108-104-080	OE	C-RES,U 100K-1/16W J	LHSM	CX-NSZ300
X	MICON	R	0923 88-108-104-080	OE	C-RES,U 100K-1/16W J	USM	CX-SNAJ300
X	MICON	R	0923 88-108-104-080	OE	C-RES,U 100K-1/16W J	USM	CX-SNAJ305
X	MICON	R	0924 88-108-104-080		C-RES,U 100K-1/16W J	LHSM	CX-NSZ300
X	MICON	R	0924 88-108-104-080		C-RES,U 100K-1/16W J	USM	CX-SNAJ300
X	MICON	R	0924 88-108-104-080		C-RES,U 100K-1/16W J	USM	CX-SNAJ305
X	MICON	R	0924 88-108-104-080		C-RES,U 100K-1/16W J	EZSM	CX-NSZ300
X	MICON	R	0924 88-108-104-080	OE	C-RES,U 100K-1/16W J	LHSM	CX-NSZ300
X	MICON	R	0924 88-108-104-080	OE	C-RES,U 100K-1/16W J	USM	CX-SNAJ300

PARTS LIST

! = \triangle SAFTY PARTS
C = Components marked

All components used on this model at the production line are shown in this service manual.

However, please note that not all components will be available as spare parts for after-sales service.

Components marked S and O are designated as spare parts for service and will be stocked at the spare parts centers.

Components marked X and R are not designated as spare parts for after sales service, and will not be stocked at the spare parts centers.

K NO. = Only use japanese.

! C	UNIT NAME	REF NO.	PARTS CODE	K NO.	DESCRIPTION	SUFFIX	MODEL NAME		
X	MICON	R	0924	88-108-104-080	OE	C-RES,U	100K-1/16W J	USM	CX-SNAJ305
X	MICON	R	0925	88-108-104-080		C-RES,U	100K-1/16W J	LHSM	CX-NSZ300
X	MICON	R	0925	88-108-104-080		C-RES,U	100K-1/16W J	USM	CX-SNAJ300
X	MICON	R	0925	88-108-104-080		C-RES,U	100K-1/16W J	USM	CX-SNAJ305
X	MICON	R	0925	88-108-104-080		C-RES,U	100K-1/16W J	EZSM	CX-NSZ300
X	MICON	R	0925	88-108-104-080	OE	C-RES,U	100K-1/16W J	LHSM	CX-NSZ300
X	MICON	R	0925	88-108-104-080	OE	C-RES,U	100K-1/16W J	USM	CX-SNAJ300
X	MICON	R	0925	88-108-104-080	OE	C-RES,U	100K-1/16W J	USM	CX-SNAJ305
X	MICON	R	0926	88-108-104-080		C-RES,U	100K-1/16W J	LHSM	CX-NSZ300
X	MICON	R	0926	88-108-104-080		C-RES,U	100K-1/16W J	USM	CX-SNAJ300
X	MICON	R	0926	88-108-104-080		C-RES,U	100K-1/16W J	USM	CX-SNAJ305
X	MICON	R	0926	88-108-104-080		C-RES,U	100K-1/16W J	EZSM	CX-NSZ300
X	MICON	R	0926	88-108-104-080	OE	C-RES,U	100K-1/16W J	LHSM	CX-NSZ300
X	MICON	R	0926	88-108-104-080	OE	C-RES,U	100K-1/16W J	USM	CX-SNAJ300
X	MICON	R	0926	88-108-104-080	OE	C-RES,U	100K-1/16W J	USM	CX-SNAJ305
X	MICON	R	0927	88-108-104-080		C-RES,U	100K-1/16W J	LHSM	CX-NSZ300
X	MICON	R	0927	88-108-104-080		C-RES,U	100K-1/16W J	USM	CX-SNAJ300
X	MICON	R	0927	88-108-104-080		C-RES,U	100K-1/16W J	USM	CX-SNAJ305
X	MICON	R	0927	88-108-104-080		C-RES,U	100K-1/16W J	EZSM	CX-NSZ300
X	MICON	R	0927	88-108-104-080	OE	C-RES,U	100K-1/16W J	LHSM	CX-NSZ300
X	MICON	R	0927	88-108-104-080	OE	C-RES,U	100K-1/16W J	USM	CX-SNAJ300
X	MICON	R	0927	88-108-104-080	OE	C-RES,U	100K-1/16W J	USM	CX-SNAJ305
X	MICON	R	0928	88-108-104-080		C-RES,U	100K-1/16W J	LHSM	CX-NSZ300
X	MICON	R	0928	88-108-104-080		C-RES,U	100K-1/16W J	USM	CX-SNAJ300
X	MICON	R	0928	88-108-104-080		C-RES,U	100K-1/16W J	USM	CX-SNAJ305
X	MICON	R	0928	88-108-104-080		C-RES,U	100K-1/16W J	EZSM	CX-NSZ300
X	MICON	R	0928	88-108-104-080	OE	C-RES,U	100K-1/16W J	LHSM	CX-NSZ300
X	MICON	R	0928	88-108-104-080	OE	C-RES,U	100K-1/16W J	USM	CX-SNAJ300
X	MICON	R	0928	88-108-104-080	OE	C-RES,U	100K-1/16W J	USM	CX-SNAJ305
X	MICON	R	0929	88-108-104-080		C-RES,U	100K-1/16W J	LHSM	CX-NSZ300
X	MICON	R	0929	88-108-104-080		C-RES,U	100K-1/16W J	USM	CX-SNAJ300
X	MICON	R	0929	88-108-104-080		C-RES,U	100K-1/16W J	USM	CX-SNAJ305
X	MICON	R	0929	88-108-104-080		C-RES,U	100K-1/16W J	EZSM	CX-NSZ300
X	MICON	R	0929	88-108-104-080	OE	C-RES,U	100K-1/16W J	LHSM	CX-NSZ300
X	MICON	R	0929	88-108-104-080	OE	C-RES,U	100K-1/16W J	USM	CX-SNAJ300
X	MICON	R	0929	88-108-104-080	OE	C-RES,U	100K-1/16W J	USM	CX-SNAJ305
X	MICON	R	0930	88-108-104-080		C-RES,U	100K-1/16W J	LHSM	CX-NSZ300
X	MICON	R	0930	88-108-104-080		C-RES,U	100K-1/16W J	USM	CX-SNAJ300
X	MICON	R	0930	88-108-104-080		C-RES,U	100K-1/16W J	USM	CX-SNAJ305
X	MICON	R	0930	88-108-104-080		C-RES,U	100K-1/16W J	EZSM	CX-NSZ300
X	MICON	R	0930	88-108-104-080	OE	C-RES,U	100K-1/16W J	LHSM	CX-NSZ300
X	MICON	R	0930	88-108-104-080	OE	C-RES,U	100K-1/16W J	USM	CX-SNAJ300
X	MICON	R	0930	88-108-104-080	OE	C-RES,U	100K-1/16W J	USM	CX-SNAJ305
X	MICON	R	0931	88-108-104-080		C-RES,U	100K-1/16W J	LHSM	CX-NSZ300
X	MICON	R	0931	88-108-104-080		C-RES,U	100K-1/16W J	USM	CX-SNAJ300
X	MICON	R	0931	88-108-104-080		C-RES,U	100K-1/16W J	USM	CX-SNAJ305
X	MICON	R	0931	88-108-104-080		C-RES,U	100K-1/16W J	EZSM	CX-NSZ300
X	MICON	R	0931	88-108-104-080	OE	C-RES,U	100K-1/16W J	LHSM	CX-NSZ300
X	MICON	R	0931	88-108-104-080	OE	C-RES,U	100K-1/16W J	USM	CX-SNAJ300
X	MICON	R	0931	88-108-104-080	OE	C-RES,U	100K-1/16W J	USM	CX-SNAJ305
X	MICON	R	0932	88-108-104-080		C-RES,U	100K-1/16W J	LHSM	CX-NSZ300
X	MICON	R	0932	88-108-104-080		C-RES,U	100K-1/16W J	USM	CX-SNAJ300
X	MICON	R	0932	88-108-104-080		C-RES,U	100K-1/16W J	USM	CX-SNAJ305
X	MICON	R	0932	88-108-104-080		C-RES,U	100K-1/16W J	EZSM	CX-NSZ300
X	MICON	R	0932	88-108-104-080	OE	C-RES,U	100K-1/16W J	LHSM	CX-NSZ300
X	MICON	R	0932	88-108-104-080	OE	C-RES,U	100K-1/16W J	USM	CX-SNAJ300
X	MICON	R	0932	88-108-104-080	OE	C-RES,U	100K-1/16W J	USM	CX-SNAJ305
X	MICON	R	0933	88-108-104-080		C-RES,U	100K-1/16W J	LHSM	CX-NSZ300
X	MICON	R	0933	88-108-104-080		C-RES,U	100K-1/16W J	USM	CX-SNAJ300
X	MICON	R	0933	88-108-104-080		C-RES,U	100K-1/16W J	USM	CX-SNAJ305
X	MICON	R	0933	88-108-104-080		C-RES,U	100K-1/16W J	EZSM	CX-NSZ300
X	MICON	R	0933	88-108-104-080	OE	C-RES,U	100K-1/16W J	LHSM	CX-NSZ300
X	MICON	R	0933	88-108-104-080	OE	C-RES,U	100K-1/16W J	USM	CX-SNAJ300
X	MICON	R	0933	88-108-104-080	OE	C-RES,U	100K-1/16W J	USM	CX-SNAJ305
X	MICON	R	0934	88-108-683-080		C-RES,U	68K-1/16W J	LHSM	CX-NSZ300
X	MICON	R	0934	88-108-683-080		C-RES,U	68K-1/16W J	USM	CX-SNAJ300
X	MICON	R	0934	88-108-683-080		C-RES,U	68K-1/16W J	USM	CX-SNAJ305
X	MICON	R	0934	88-108-683-080		C-RES,U	68K-1/16W J	EZSM	CX-NSZ300
X	MICON	R	0934	88-108-683-080	OE	C-RES,U	68K-1/16W J	LHSM	CX-NSZ300
X	MICON	R	0934	88-108-683-080	OE	C-RES,U	68K-1/16W J	USM	CX-SNAJ300

PARTS LIST

! = Δ SAFTY PARTS
 C = Components marked

All components used on this model at the production line are shown in this service manual.

However, please note that not all components will be available as spare parts for after-sales service.

Components marked S and O are designated as spare parts for service and will be stocked at the spare parts centers.

Components marked X and R are not designated as spare parts for after sales service, and will not be stocked at the spare parts centers.

K NO. = Only use japanese.

! C	UNIT NAME	REF NO.	PARTS CODE	K NO.	DESCRIPTION	SUFFIX	MODEL NAME
X	MICON	R	0934 88-108-683-080	OE	C-RES,U 68K-1/16W J	USM	CX-SNAJ305
X	MICON	R	0935 88-108-683-080		C-RES,U 68K-1/16W J	LHSM	CX-NSZ300
X	MICON	R	0935 88-108-683-080		C-RES,U 68K-1/16W J	USM	CX-SNAJ300
X	MICON	R	0935 88-108-683-080		C-RES,U 68K-1/16W J	USM	CX-SNAJ305
X	MICON	R	0935 88-108-683-080		C-RES,U 68K-1/16W J	EZSM	CX-NSZ300
X	MICON	R	0935 88-108-683-080	OE	C-RES,U 68K-1/16W J	LHSM	CX-NSZ300
X	MICON	R	0935 88-108-683-080	OE	C-RES,U 68K-1/16W J	USM	CX-SNAJ300
X	MICON	R	0935 88-108-683-080	OE	C-RES,U 68K-1/16W J	USM	CX-SNAJ305
X	MICON	R	0936 88-108-104-080		C-RES,U 100K-1/16W J	LHSM	CX-NSZ300
X	MICON	R	0936 88-108-104-080		C-RES,U 100K-1/16W J	USM	CX-SNAJ300
X	MICON	R	0936 88-108-104-080		C-RES,U 100K-1/16W J	USM	CX-SNAJ305
X	MICON	R	0936 88-108-104-080		C-RES,U 100K-1/16W J	EZSM	CX-NSZ300
X	MICON	R	0936 88-108-104-080	OE	C-RES,U 100K-1/16W J	LHSM	CX-NSZ300
X	MICON	R	0936 88-108-104-080	OE	C-RES,U 100K-1/16W J	USM	CX-SNAJ300
X	MICON	R	0936 88-108-104-080	OE	C-RES,U 100K-1/16W J	USM	CX-SNAJ305
X	MICON	R	0937 88-128-472-080		C-RES, 4.7K-1/8W J	LHSM	CX-NSZ300
X	MICON	R	0937 88-128-472-080		C-RES, 4.7K-1/8W J	USM	CX-SNAJ300
X	MICON	R	0937 88-128-472-080		C-RES, 4.7K-1/8W J	USM	CX-SNAJ305
X	MICON	R	0937 88-128-472-080		C-RES, 4.7K-1/8W J	EZSM	CX-NSZ300
X	MICON	R	0937 88-128-472-080	OE	C-RES, 4.7K-1/8W J	LHSM	CX-NSZ300
X	MICON	R	0937 88-128-472-080	OE	C-RES, 4.7K-1/8W J	USM	CX-SNAJ300
X	MICON	R	0937 88-128-472-080	OE	C-RES, 4.7K-1/8W J	USM	CX-SNAJ305
X	MICON	R	0938 88-108-472-080		C-RES,U 4.7K-1/16W J	LHSM	CX-NSZ300
X	MICON	R	0938 88-108-472-080		C-RES,U 4.7K-1/16W J	USM	CX-SNAJ300
X	MICON	R	0938 88-108-472-080		C-RES,U 4.7K-1/16W J	USM	CX-SNAJ305
X	MICON	R	0938 88-108-472-080		C-RES,U 4.7K-1/16W J	EZSM	CX-NSZ300
X	MICON	R	0938 88-108-472-080	OE	C-RES,U 4.7K-1/16W J	LHSM	CX-NSZ300
X	MICON	R	0938 88-108-472-080	OE	C-RES,U 4.7K-1/16W J	USM	CX-SNAJ300
X	MICON	R	0938 88-108-472-080	OE	C-RES,U 4.7K-1/16W J	USM	CX-SNAJ305
X	MICON	R	0939 88-108-472-080		C-RES,U 4.7K-1/16W J	LHSM	CX-NSZ300
X	MICON	R	0939 88-108-472-080		C-RES,U 4.7K-1/16W J	USM	CX-SNAJ300
X	MICON	R	0939 88-108-472-080		C-RES,U 4.7K-1/16W J	EZSM	CX-NSZ300
X	MICON	R	0939 88-108-472-080	OE	C-RES,U 4.7K-1/16W J	LHSM	CX-NSZ300
X	MICON	R	0939 88-108-472-080	OE	C-RES,U 4.7K-1/16W J	USM	CX-SNAJ300
X	MICON	R	0939 88-108-472-080	OE	C-RES,U 4.7K-1/16W J	USM	CX-SNAJ305
X	MICON	R	0940 88-121-104-080		RES,100K-1/8W J	LHSM	CX-NSZ300
X	MICON	R	0940 88-121-104-080		RES,100K-1/8W J	USM	CX-SNAJ300
X	MICON	R	0940 88-121-104-080		RES,100K-1/8W J	USM	CX-SNAJ305
X	MICON	R	0940 88-121-104-080		RES,100K-1/8W J	EZSM	CX-NSZ300
X	MICON	R	0940 88-121-104-080	OE	RES,100K-1/8W J	LHSM	CX-NSZ300
X	MICON	R	0940 88-121-104-080	OE	RES,100K-1/8W J	USM	CX-SNAJ300
X	MICON	R	0940 88-121-104-080	OE	RES,100K-1/8W J	USM	CX-SNAJ305
X	MICON	R	0941 88-108-104-080		C-RES,U 100K-1/16W J	LHSM	CX-NSZ300
X	MICON	R	0941 88-108-104-080		C-RES,U 100K-1/16W J	USM	CX-SNAJ300
X	MICON	R	0941 88-108-104-080		C-RES,U 100K-1/16W J	USM	CX-SNAJ305
X	MICON	R	0941 88-108-104-080		C-RES,U 100K-1/16W J	EZSM	CX-NSZ300
X	MICON	R	0941 88-108-104-080	OE	C-RES,U 100K-1/16W J	LHSM	CX-NSZ300
X	MICON	R	0941 88-108-104-080	OE	C-RES,U 100K-1/16W J	USM	CX-SNAJ300
X	MICON	R	0941 88-108-104-080	OE	C-RES,U 100K-1/16W J	USM	CX-SNAJ305
X	MICON	R	0942 88-108-103-080		C-RES,U 10K-1/16W J	LHSM	CX-NSZ300
X	MICON	R	0942 88-108-103-080		C-RES,U 10K-1/16W J	USM	CX-SNAJ300
X	MICON	R	0942 88-108-103-080		C-RES,U 10K-1/16W J	USM	CX-SNAJ305
X	MICON	R	0942 88-108-103-080		C-RES,U 10K-1/16W J	EZSM	CX-NSZ300
X	MICON	R	0942 88-108-103-080	OE	C-RES,U 10K-1/16W J	LHSM	CX-NSZ300
X	MICON	R	0942 88-108-103-080	OE	C-RES,U 10K-1/16W J	USM	CX-SNAJ300
X	MICON	R	0942 88-108-103-080	OE	C-RES,U 10K-1/16W J	USM	CX-SNAJ305
X	MICON	R	0943 88-108-103-080		C-RES,U 10K-1/16W J	LHSM	CX-NSZ300
X	MICON	R	0943 88-108-103-080		C-RES,U 10K-1/16W J	USM	CX-SNAJ300
X	MICON	R	0943 88-108-103-080		C-RES,U 10K-1/16W J	USM	CX-SNAJ305
X	MICON	R	0943 88-108-103-080		C-RES,U 10K-1/16W J	EZSM	CX-NSZ300
X	MICON	R	0943 88-108-103-080	OE	C-RES,U 10K-1/16W J	LHSM	CX-NSZ300
X	MICON	R	0943 88-108-103-080	OE	C-RES,U 10K-1/16W J	USM	CX-SNAJ300
X	MICON	R	0943 88-108-103-080	OE	C-RES,U 10K-1/16W J	USM	CX-SNAJ305
X	MICON	R	0946 88-108-000-080		C-JUMPER,U	LHSM	CX-NSZ300
X	MICON	R	0946 88-108-000-080		C-JUMPER,U	USM	CX-SNAJ300
X	MICON	R	0946 88-108-000-080		C-JUMPER,U	USM	CX-SNAJ305
X	MICON	R	0946 88-108-000-080		C-JUMPER,U	EZSM	CX-NSZ300
X	MICON	R	0946 88-108-000-080	OE	C-JUMPER,U	LHSM	CX-NSZ300
X	MICON	R	0946 88-108-000-080	OE	C-JUMPER,U	USM	CX-SNAJ300

PARTS LIST

! = Δ SAFTY PARTS
 C = Components marked

All components used on this model at the production line are shown in this service manual.

However, please note that not all components will be available as spare parts for after-sales service.

Components marked S and O are designated as spare parts for service and will be stocked at the spare parts centers.

Components marked X and R are not designated as spare parts for after sales service, and will not be stocked at the spare parts centers.

K NO. = Only use japanese.

! C	UNIT NAME	REF NO.	PARTS CODE	K NO.	DESCRIPTION	SUFFIX	MODEL NAME
X	MICON	R 0946	88-108-000-080	OE	C-JUMPER,U	USM	CX-SNAJ305
X	MICON	R 0947	88-108-104-080		C-RES,U 100K-1/16W J	LHSM	CX-NSZ300
X	MICON	R 0947	88-108-104-080		C-RES,U 100K-1/16W J	USM	CX-SNAJ300
X	MICON	R 0947	88-108-104-080		C-RES,U 100K-1/16W J	USM	CX-SNAJ305
X	MICON	R 0947	88-108-104-080		C-RES,U 100K-1/16W J	EZSM	CX-NSZ300
X	MICON	R 0947	88-108-104-080	OE	C-RES,U 100K-1/16W J	LHSM	CX-NSZ300
X	MICON	R 0947	88-108-104-080	OE	C-RES,U 100K-1/16W J	USM	CX-SNAJ300
X	MICON	R 0947	88-108-104-080	OE	C-RES,U 100K-1/16W J	USM	CX-SNAJ305
X	MICON	R 0948	88-108-104-080		C-RES,U 100K-1/16W J	LHSM	CX-NSZ300
X	MICON	R 0948	88-108-104-080		C-RES,U 100K-1/16W J	USM	CX-SNAJ300
X	MICON	R 0948	88-108-104-080		C-RES,U 100K-1/16W J	USM	CX-SNAJ305
X	MICON	R 0948	88-108-104-080		C-RES,U 100K-1/16W J	EZSM	CX-NSZ300
X	MICON	R 0948	88-108-104-080	OE	C-RES,U 100K-1/16W J	LHSM	CX-NSZ300
X	MICON	R 0948	88-108-104-080	OE	C-RES,U 100K-1/16W J	USM	CX-SNAJ300
X	MICON	R 0948	88-108-104-080	OE	C-RES,U 100K-1/16W J	USM	CX-SNAJ305
X	MICON	R 0951	88-108-102-080		C-RES,U 1K-1/16W J	LHSM	CX-NSZ300
X	MICON	R 0951	88-108-102-080		C-RES,U 1K-1/16W J	USM	CX-SNAJ300
X	MICON	R 0951	88-108-102-080		C-RES,U 1K-1/16W J	USM	CX-SNAJ305
X	MICON	R 0951	88-108-102-080		C-RES,U 1K-1/16W J	EZSM	CX-NSZ300
X	MICON	R 0951	88-108-102-080	OE	C-RES,U 1K-1/16W J	LHSM	CX-NSZ300
X	MICON	R 0951	88-108-102-080	OE	C-RES,U 1K-1/16W J	USM	CX-SNAJ300
X	MICON	R 0951	88-108-102-080	OE	C-RES,U 1K-1/16W J	USM	CX-SNAJ305
X	MICON	R 0955	88-108-104-080		C-RES,U 100K-1/16W J	LHSM	CX-NSZ300
X	MICON	R 0955	88-108-104-080		C-RES,U 100K-1/16W J	USM	CX-SNAJ300
X	MICON	R 0955	88-108-104-080		C-RES,U 100K-1/16W J	USM	CX-SNAJ305
X	MICON	R 0955	88-108-104-080		C-RES,U 100K-1/16W J	EZSM	CX-NSZ300
X	MICON	R 0955	88-108-104-080	OE	C-RES,U 100K-1/16W J	LHSM	CX-NSZ300
X	MICON	R 0955	88-108-104-080	OE	C-RES,U 100K-1/16W J	USM	CX-SNAJ300
X	MICON	R 0955	88-108-104-080	OE	C-RES,U 100K-1/16W J	USM	CX-SNAJ305
X	MICON	R 0956	88-108-104-080		C-RES,U 100K-1/16W J	LHSM	CX-NSZ300
X	MICON	R 0956	88-108-104-080		C-RES,U 100K-1/16W J	USM	CX-SNAJ300
X	MICON	R 0956	88-108-104-080		C-RES,U 100K-1/16W J	USM	CX-SNAJ305
X	MICON	R 0956	88-108-104-080		C-RES,U 100K-1/16W J	EZSM	CX-NSZ300
X	MICON	R 0956	88-108-104-080	OE	C-RES,U 100K-1/16W J	LHSM	CX-NSZ300
X	MICON	R 0956	88-108-104-080	OE	C-RES,U 100K-1/16W J	USM	CX-SNAJ300
X	MICON	R 0956	88-108-104-080	OE	C-RES,U 100K-1/16W J	USM	CX-SNAJ305
X	MICON	R 0957	88-108-104-080		C-RES,U 100K-1/16W J	LHSM	CX-NSZ300
X	MICON	R 0957	88-108-104-080		C-RES,U 100K-1/16W J	USM	CX-SNAJ300
X	MICON	R 0957	88-108-104-080		C-RES,U 100K-1/16W J	USM	CX-SNAJ305
X	MICON	R 0957	88-108-104-080		C-RES,U 100K-1/16W J	EZSM	CX-NSZ300
X	MICON	R 0957	88-108-104-080	OE	C-RES,U 100K-1/16W J	LHSM	CX-NSZ300
X	MICON	R 0957	88-108-104-080	OE	C-RES,U 100K-1/16W J	USM	CX-SNAJ300
X	MICON	R 0957	88-108-104-080	OE	C-RES,U 100K-1/16W J	USM	CX-SNAJ305
X	MICON	R 0958	88-108-104-080		C-RES,U 100K-1/16W J	LHSM	CX-NSZ300
X	MICON	R 0958	88-108-104-080		C-RES,U 100K-1/16W J	USM	CX-SNAJ300
X	MICON	R 0958	88-108-104-080		C-RES,U 100K-1/16W J	USM	CX-SNAJ305
X	MICON	R 0958	88-108-104-080		C-RES,U 100K-1/16W J	EZSM	CX-NSZ300
X	MICON	R 0958	88-108-104-080	OE	C-RES,U 100K-1/16W J	LHSM	CX-NSZ300
X	MICON	R 0958	88-108-104-080	OE	C-RES,U 100K-1/16W J	USM	CX-SNAJ300
X	MICON	R 0958	88-108-104-080	OE	C-RES,U 100K-1/16W J	USM	CX-SNAJ305
X	MICON	R 0961	88-128-181-080		C-RES, 180-1/8W J	LHSM	CX-NSZ300
X	MICON	R 0961	88-128-181-080		C-RES, 180-1/8W J	USM	CX-SNAJ300
X	MICON	R 0961	88-128-181-080		C-RES, 180-1/8W J	USM	CX-SNAJ305
X	MICON	R 0961	88-128-181-080		C-RES, 180-1/8W J	EZSM	CX-NSZ300
X	MICON	R 0961	88-128-181-080	OE	C-RES, 180-1/8W J	LHSM	CX-NSZ300
X	MICON	R 0961	88-128-181-080	OE	C-RES, 180-1/8W J	USM	CX-SNAJ300
X	MICON	R 0961	88-128-181-080	OE	C-RES, 180-1/8W J	USM	CX-SNAJ305
X	MICON	R 0962	88-108-563-080		C-RES,U 56K-1/16W J	LHSM	CX-NSZ300
X	MICON	R 0962	88-108-563-080		C-RES,U 56K-1/16W J	USM	CX-SNAJ300
X	MICON	R 0962	88-108-563-080		C-RES,U 56K-1/16W J	USM	CX-SNAJ305
X	MICON	R 0962	88-108-563-080		C-RES,U 56K-1/16W J	EZSM	CX-NSZ300
X	MICON	R 0962	88-108-563-080	OE	C-RES,U 56K-1/16W J	LHSM	CX-NSZ300
X	MICON	R 0962	88-108-563-080	OE	C-RES,U 56K-1/16W J	USM	CX-SNAJ300
X	MICON	R 0962	88-108-563-080	OE	C-RES,U 56K-1/16W J	USM	CX-SNAJ305
O	MICON	S 0321	87-A90-095-080		SW, TACT EVQ11G04M	LHSM	CX-NSZ300
O	MICON	S 0321	87-A90-095-080		SW, TACT EVQ11G04M	USM	CX-SNAJ300
O	MICON	S 0321	87-A90-095-080		SW, TACT EVQ11G04M	USM	CX-SNAJ305
O	MICON	S 0321	87-A90-164-080		SW, TACT SKQNAB(N)	EZSM	CX-NSZ300
O	MICON	S 0321	87-A90-164-080	OE	SW, TACT SKQNAB(N)	LHSM	CX-NSZ300
O	MICON	S 0321	87-A90-164-080	OE	SW, TACT SKQNAB(N)	USM	CX-SNAJ300

PARTS LIST

! = Δ SAFTY PARTS
 C = Components marked

All components used on this model at the production line are shown in this service manual.

However, please note that not all components will be available as spare parts for after-sales service.

Components marked S and O are designated as spare parts for service and will be stocked at the spare parts centers.

Components marked X and R are not designated as spare parts for after sales service, and will not be stocked at the spare parts centers.

K NO. = Only use japanese.

! C	UNIT NAME	REF NO.	PARTS CODE	K NO.	DESCRIPTION	SUFFIX	MODEL NAME
O	MICON	S	0321 87-A90-164-080	OE	SW, TACT SKQNAB (N)	USM	CX-SNAJ305
O	MICON	S	0322 87-A90-095-080		SW, TACT EVQ11G04M	LHSM	CX-NSZ300
O	MICON	S	0322 87-A90-095-080		SW, TACT EVQ11G04M	USM	CX-SNAJ300
O	MICON	S	0322 87-A90-095-080		SW, TACT EVQ11G04M	USM	CX-SNAJ305
O	MICON	S	0322 87-A90-164-080		SW, TACT SKQNAB (N)	EZSM	CX-NSZ300
O	MICON	S	0322 87-A90-164-080	OE	SW, TACT SKQNAB (N)	LHSM	CX-NSZ300
O	MICON	S	0322 87-A90-164-080	OE	SW, TACT SKQNAB (N)	USM	CX-SNAJ300
O	MICON	S	0322 87-A90-164-080	OE	SW, TACT SKQNAB (N)	USM	CX-SNAJ305
O	MICON	S	0323 87-A90-095-080		SW, TACT EVQ11G04M	LHSM	CX-NSZ300
O	MICON	S	0323 87-A90-095-080		SW, TACT EVQ11G04M	USM	CX-SNAJ300
O	MICON	S	0323 87-A90-095-080		SW, TACT EVQ11G04M	USM	CX-SNAJ305
O	MICON	S	0323 87-A90-164-080		SW, TACT SKQNAB (N)	EZSM	CX-NSZ300
O	MICON	S	0323 87-A90-164-080	OE	SW, TACT SKQNAB (N)	LHSM	CX-NSZ300
O	MICON	S	0323 87-A90-164-080	OE	SW, TACT SKQNAB (N)	USM	CX-SNAJ300
O	MICON	S	0323 87-A90-164-080	OE	SW, TACT SKQNAB (N)	USM	CX-SNAJ305
O	MICON	S	0324 87-A90-095-080		SW, TACT EVQ11G04M	LHSM	CX-NSZ300
O	MICON	S	0324 87-A90-095-080		SW, TACT EVQ11G04M	USM	CX-SNAJ300
O	MICON	S	0324 87-A90-095-080		SW, TACT EVQ11G04M	USM	CX-SNAJ305
O	MICON	S	0324 87-A90-164-080		SW, TACT SKQNAB (N)	EZSM	CX-NSZ300
O	MICON	S	0324 87-A90-164-080	OE	SW, TACT SKQNAB (N)	LHSM	CX-NSZ300
O	MICON	S	0324 87-A90-164-080	OE	SW, TACT SKQNAB (N)	USM	CX-SNAJ300
O	MICON	S	0324 87-A90-164-080	OE	SW, TACT SKQNAB (N)	USM	CX-SNAJ305
O	MICON	S	0325 87-A90-095-080		SW, TACT EVQ11G04M	LHSM	CX-NSZ300
O	MICON	S	0325 87-A90-095-080		SW, TACT EVQ11G04M	USM	CX-SNAJ300
O	MICON	S	0325 87-A90-095-080		SW, TACT EVQ11G04M	USM	CX-SNAJ305
O	MICON	S	0325 87-A90-164-080		SW, TACT SKQNAB (N)	EZSM	CX-NSZ300
O	MICON	S	0325 87-A90-164-080	OE	SW, TACT SKQNAB (N)	LHSM	CX-NSZ300
O	MICON	S	0325 87-A90-164-080	OE	SW, TACT SKQNAB (N)	USM	CX-SNAJ300
O	MICON	S	0325 87-A90-164-080	OE	SW, TACT SKQNAB (N)	USM	CX-SNAJ305
O	MICON	S	0326 87-A90-095-080		SW, TACT EVQ11G04M	LHSM	CX-NSZ300
O	MICON	S	0326 87-A90-095-080		SW, TACT EVQ11G04M	USM	CX-SNAJ300
O	MICON	S	0326 87-A90-095-080		SW, TACT EVQ11G04M	USM	CX-SNAJ305
O	MICON	S	0326 87-A90-164-080		SW, TACT SKQNAB (N)	EZSM	CX-NSZ300
O	MICON	S	0326 87-A90-164-080	OE	SW, TACT SKQNAB (N)	LHSM	CX-NSZ300
O	MICON	S	0326 87-A90-164-080	OE	SW, TACT SKQNAB (N)	USM	CX-SNAJ300
O	MICON	S	0326 87-A90-164-080	OE	SW, TACT SKQNAB (N)	USM	CX-SNAJ305
O	MICON	S	0327 87-A90-095-080		SW, TACT EVQ11G04M	LHSM	CX-NSZ300
O	MICON	S	0327 87-A90-095-080		SW, TACT EVQ11G04M	USM	CX-SNAJ300
O	MICON	S	0327 87-A90-095-080		SW, TACT EVQ11G04M	USM	CX-SNAJ305
O	MICON	S	0327 87-A90-095-080		SW, TACT EVQ11G04M	EZSM	CX-NSZ300
O	MICON	S	0327 87-A90-095-080	OE	SW, TACT EVQ11G04M	LHSM	CX-NSZ300
O	MICON	S	0327 87-A90-095-080	OE	SW, TACT EVQ11G04M	USM	CX-SNAJ300
O	MICON	S	0327 87-A90-095-080	OE	SW, TACT EVQ11G04M	USM	CX-SNAJ305
O	MICON	S	0328 87-A90-095-080		SW, TACT EVQ11G04M	LHSM	CX-NSZ300
O	MICON	S	0328 87-A90-095-080		SW, TACT EVQ11G04M	USM	CX-SNAJ300
O	MICON	S	0328 87-A90-095-080		SW, TACT EVQ11G04M	USM	CX-SNAJ305
O	MICON	S	0328 87-A90-095-080		SW, TACT EVQ11G04M	EZSM	CX-NSZ300
O	MICON	S	0328 87-A90-095-080	OE	SW, TACT EVQ11G04M	LHSM	CX-NSZ300
O	MICON	S	0328 87-A90-095-080	OE	SW, TACT EVQ11G04M	USM	CX-SNAJ300
O	MICON	S	0328 87-A90-095-080	OE	SW, TACT EVQ11G04M	USM	CX-SNAJ305
O	MICON	S	0329 87-A90-095-080		SW, TACT EVQ11G04M	LHSM	CX-NSZ300
O	MICON	S	0329 87-A90-095-080		SW, TACT EVQ11G04M	USM	CX-SNAJ300
O	MICON	S	0329 87-A90-095-080		SW, TACT EVQ11G04M	USM	CX-SNAJ305
O	MICON	S	0329 87-A90-095-080		SW, TACT EVQ11G04M	EZSM	CX-NSZ300
O	MICON	S	0329 87-A90-095-080	OE	SW, TACT EVQ11G04M	LHSM	CX-NSZ300
O	MICON	S	0329 87-A90-095-080	OE	SW, TACT EVQ11G04M	USM	CX-SNAJ300
O	MICON	S	0329 87-A90-095-080	OE	SW, TACT EVQ11G04M	USM	CX-SNAJ305
O	MICON	S	0330 87-A90-095-080		SW, TACT EVQ11G04M	LHSM	CX-NSZ300
O	MICON	S	0330 87-A90-095-080		SW, TACT EVQ11G04M	USM	CX-SNAJ300
O	MICON	S	0330 87-A90-095-080		SW, TACT EVQ11G04M	USM	CX-SNAJ305
O	MICON	S	0330 87-A90-164-080		SW, TACT SKQNAB (N)	EZSM	CX-NSZ300
O	MICON	S	0330 87-A90-164-080	OE	SW, TACT SKQNAB (N)	LHSM	CX-NSZ300
O	MICON	S	0330 87-A90-164-080	OE	SW, TACT SKQNAB (N)	USM	CX-SNAJ300
O	MICON	S	0330 87-A90-164-080	OE	SW, TACT SKQNAB (N)	USM	CX-SNAJ305
O	MICON	S	0331 87-A90-095-080		SW, TACT EVQ11G04M	LHSM	CX-NSZ300
O	MICON	S	0331 87-A90-095-080		SW, TACT EVQ11G04M	USM	CX-SNAJ300
O	MICON	S	0331 87-A90-095-080		SW, TACT EVQ11G04M	USM	CX-SNAJ305
O	MICON	S	0331 87-A90-164-080		SW, TACT SKQNAB (N)	EZSM	CX-NSZ300
O	MICON	S	0331 87-A90-164-080	OE	SW, TACT SKQNAB (N)	LHSM	CX-NSZ300
O	MICON	S	0331 87-A90-164-080	OE	SW, TACT SKQNAB (N)	USM	CX-SNAJ300

PARTS LIST

! = Δ SAFTY PARTS
 C = Components marked

All components used on this model at the production line are shown in this service manual.

However, please note that not all components will be available as spare parts for after-sales service.

Components marked S and O are designated as spare parts for service and will be stocked at the spare parts centers.

Components marked X and R are not designated as spare parts for after sales service, and will not be stocked at the spare parts centers.

K NO. = Only use japanese.

! C	UNIT NAME	REF NO.	PARTS CODE	K NO.	DESCRIPTION	SUFFIX	MODEL NAME
O	MICON	S	0331 87-A90-164-080	OE	SW, TACT SKQNAB (N)	USM	CX-SNAJ305
O	MICON	S	0332 87-A90-095-080		SW, TACT EVQ11G04M	LHSM	CX-NSZ300
O	MICON	S	0332 87-A90-095-080		SW, TACT EVQ11G04M	USM	CX-SNAJ300
O	MICON	S	0332 87-A90-095-080		SW, TACT EVQ11G04M	USM	CX-SNAJ305
O	MICON	S	0332 87-A90-164-080		SW, TACT SKQNAB (N)	EZSM	CX-NSZ300
O	MICON	S	0332 87-A90-164-080	OE	SW, TACT SKQNAB (N)	LHSM	CX-NSZ300
O	MICON	S	0332 87-A90-164-080	OE	SW, TACT SKQNAB (N)	USM	CX-SNAJ300
O	MICON	S	0332 87-A90-164-080	OE	SW, TACT SKQNAB (N)	USM	CX-SNAJ305
O	MICON	S	0333 87-A90-095-080		SW, TACT EVQ11G04M	LHSM	CX-NSZ300
O	MICON	S	0333 87-A90-095-080		SW, TACT EVQ11G04M	USM	CX-SNAJ300
O	MICON	S	0333 87-A90-095-080		SW, TACT EVQ11G04M	USM	CX-SNAJ305
O	MICON	S	0333 87-A90-164-080		SW, TACT SKQNAB (N)	EZSM	CX-NSZ300
O	MICON	S	0333 87-A90-164-080	OE	SW, TACT SKQNAB (N)	LHSM	CX-NSZ300
O	MICON	S	0333 87-A90-164-080	OE	SW, TACT SKQNAB (N)	USM	CX-SNAJ300
O	MICON	S	0333 87-A90-164-080	OE	SW, TACT SKQNAB (N)	USM	CX-SNAJ305
O	MICON	S	0333 87-A90-164-080	OE	SW, TACT SKQNAB (N)	USM	CX-SNAJ305
O	MICON	S	0333 87-A90-164-080	OE	SW, TACT SKQNAB (N)	USM	CX-SNAJ305
O	MICON	S	0333 87-A90-164-080	OE	SW, TACT SKQNAB (N)	USM	CX-SNAJ305
O	MICON	S	0334 87-A90-095-080		SW, TACT EVQ11G04M	USM	CX-SNAJ300
O	MICON	S	0334 87-A90-095-080		SW, TACT EVQ11G04M	USM	CX-SNAJ305
O	MICON	S	0334 87-A90-095-080		SW, TACT EVQ11G04M	USM	CX-SNAJ305
O	MICON	S	0334 87-A90-164-080		SW, TACT SKQNAB (N)	EZSM	CX-NSZ300
O	MICON	S	0334 87-A90-164-080	OE	SW, TACT SKQNAB (N)	LHSM	CX-NSZ300
O	MICON	S	0334 87-A90-164-080	OE	SW, TACT SKQNAB (N)	USM	CX-SNAJ300
O	MICON	S	0334 87-A90-164-080	OE	SW, TACT SKQNAB (N)	USM	CX-SNAJ305
O	MICON	S	0341 87-A90-095-080		SW, TACT EVQ11G04M	LHSM	CX-NSZ300
O	MICON	S	0341 87-A90-095-080		SW, TACT EVQ11G04M	USM	CX-SNAJ300
O	MICON	S	0341 87-A90-095-080		SW, TACT EVQ11G04M	USM	CX-SNAJ305
O	MICON	S	0341 87-A90-164-080		SW, TACT SKQNAB (N)	EZSM	CX-NSZ300
O	MICON	S	0341 87-A90-164-080	OE	SW, TACT SKQNAB (N)	LHSM	CX-NSZ300
O	MICON	S	0341 87-A90-164-080	OE	SW, TACT SKQNAB (N)	USM	CX-SNAJ300
O	MICON	S	0341 87-A90-164-080	OE	SW, TACT SKQNAB (N)	USM	CX-SNAJ305
O	MICON	S	0342 87-A90-095-080		SW, TACT EVQ11G04M	LHSM	CX-NSZ300
O	MICON	S	0342 87-A90-095-080		SW, TACT EVQ11G04M	USM	CX-SNAJ300
O	MICON	S	0342 87-A90-095-080		SW, TACT EVQ11G04M	USM	CX-SNAJ305
O	MICON	S	0342 87-A90-164-080		SW, TACT SKQNAB (N)	EZSM	CX-NSZ300
O	MICON	S	0342 87-A90-164-080	OE	SW, TACT SKQNAB (N)	LHSM	CX-NSZ300
O	MICON	S	0342 87-A90-164-080	OE	SW, TACT SKQNAB (N)	USM	CX-SNAJ300
O	MICON	S	0342 87-A90-164-080	OE	SW, TACT SKQNAB (N)	USM	CX-SNAJ305
O	MICON	S	0343 87-A90-095-080		SW, TACT EVQ11G04M	LHSM	CX-NSZ300
O	MICON	S	0343 87-A90-095-080		SW, TACT EVQ11G04M	USM	CX-SNAJ300
O	MICON	S	0343 87-A90-095-080		SW, TACT EVQ11G04M	USM	CX-SNAJ305
O	MICON	S	0343 87-A90-164-080		SW, TACT SKQNAB (N)	EZSM	CX-NSZ300
O	MICON	S	0343 87-A90-164-080	OE	SW, TACT SKQNAB (N)	LHSM	CX-NSZ300
O	MICON	S	0343 87-A90-164-080	OE	SW, TACT SKQNAB (N)	USM	CX-SNAJ300
O	MICON	S	0343 87-A90-164-080	OE	SW, TACT SKQNAB (N)	USM	CX-SNAJ305
O	MICON	S	0344 87-A90-095-080		SW, TACT EVQ11G04M	LHSM	CX-NSZ300
O	MICON	S	0344 87-A90-095-080		SW, TACT EVQ11G04M	USM	CX-SNAJ300
O	MICON	S	0344 87-A90-095-080		SW, TACT EVQ11G04M	USM	CX-SNAJ305
O	MICON	S	0344 87-A90-164-080		SW, TACT SKQNAB (N)	EZSM	CX-NSZ300
O	MICON	S	0344 87-A90-164-080	OE	SW, TACT SKQNAB (N)	LHSM	CX-NSZ300
O	MICON	S	0344 87-A90-164-080	OE	SW, TACT SKQNAB (N)	USM	CX-SNAJ300
O	MICON	S	0344 87-A90-164-080	OE	SW, TACT SKQNAB (N)	USM	CX-SNAJ305
O	MICON	S	0345 87-A90-095-080		SW, TACT EVQ11G04M	LHSM	CX-NSZ300
O	MICON	S	0345 87-A90-095-080		SW, TACT EVQ11G04M	USM	CX-SNAJ300
O	MICON	S	0345 87-A90-095-080		SW, TACT EVQ11G04M	USM	CX-SNAJ305
O	MICON	S	0345 87-A90-164-080		SW, TACT SKQNAB (N)	EZSM	CX-NSZ300
O	MICON	S	0345 87-A90-164-080	OE	SW, TACT SKQNAB (N)	LHSM	CX-NSZ300
O	MICON	S	0345 87-A90-164-080	OE	SW, TACT SKQNAB (N)	USM	CX-SNAJ300
O	MICON	S	0345 87-A90-164-080	OE	SW, TACT SKQNAB (N)	USM	CX-SNAJ305
O	MICON	S	0346 87-A90-095-080		SW, TACT EVQ11G04M	LHSM	CX-NSZ300
O	MICON	S	0346 87-A90-095-080		SW, TACT EVQ11G04M	USM	CX-SNAJ300
O	MICON	S	0346 87-A90-095-080		SW, TACT EVQ11G04M	USM	CX-SNAJ305
O	MICON	S	0346 87-A90-164-080		SW, TACT SKQNAB (N)	EZSM	CX-NSZ300
O	MICON	S	0346 87-A90-164-080	OE	SW, TACT SKQNAB (N)	LHSM	CX-NSZ300
O	MICON	S	0346 87-A90-164-080	OE	SW, TACT SKQNAB (N)	USM	CX-SNAJ300
O	MICON	S	0346 87-A90-164-080	OE	SW, TACT SKQNAB (N)	USM	CX-SNAJ305
O	MICON	S	0347 87-A90-095-080		SW, TACT EVQ11G04M	LHSM	CX-NSZ300
O	MICON	S	0347 87-A90-095-080		SW, TACT EVQ11G04M	USM	CX-SNAJ300
O	MICON	S	0347 87-A90-095-080		SW, TACT EVQ11G04M	USM	CX-SNAJ305
O	MICON	S	0347 87-A90-164-080		SW, TACT SKQNAB (N)	EZSM	CX-NSZ300
O	MICON	S	0347 87-A90-164-080	OE	SW, TACT SKQNAB (N)	LHSM	CX-NSZ300
O	MICON	S	0347 87-A90-164-080	OE	SW, TACT SKQNAB (N)	USM	CX-SNAJ300

PARTS LIST

! = Δ SAFTY PARTS
 C = Components marked

All components used on this model at the production line are shown in this service manual.

However, please note that not all components will be available as spare parts for after-sales service.

Components marked S and O are designated as spare parts for service and will be stocked at the spare parts centers.

Components marked X and R are not designated as spare parts for after sales service, and will not be stocked at the spare parts centers.

K NO. = Only use japanese.

! C	UNIT NAME	REF NO.	PARTS CODE	K NO.	DESCRIPTION	SUFFIX	MODEL NAME
O	MICON	S	0347 87-A90-164-080	OE	SW, TACT SKQNAB (N)	USM	CX-SNAJ305
O	MICON	S	0348 87-A90-095-080		SW, TACT EVQ11G04M	LHSM	CX-NSZ300
O	MICON	S	0348 87-A90-095-080		SW, TACT EVQ11G04M	USM	CX-SNAJ300
O	MICON	S	0348 87-A90-095-080		SW, TACT EVQ11G04M	USM	CX-SNAJ305
O	MICON	S	0348 87-A90-164-080		SW, TACT SKQNAB (N)	EZSM	CX-NSZ300
O	MICON	S	0348 87-A90-164-080	OE	SW, TACT SKQNAB (N)	LHSM	CX-NSZ300
O	MICON	S	0348 87-A90-164-080	OE	SW, TACT SKQNAB (N)	USM	CX-SNAJ300
O	MICON	S	0348 87-A90-164-080	OE	SW, TACT SKQNAB (N)	USM	CX-SNAJ305
O	MICON	S	0349 87-A90-095-080		SW, TACT EVQ11G04M	LHSM	CX-NSZ300
O	MICON	S	0349 87-A90-095-080		SW, TACT EVQ11G04M	USM	CX-SNAJ300
O	MICON	S	0349 87-A90-095-080		SW, TACT EVQ11G04M	USM	CX-SNAJ305
O	MICON	S	0349 87-A90-164-080		SW, TACT SKQNAB (N)	EZSM	CX-NSZ300
O	MICON	S	0349 87-A90-164-080	OE	SW, TACT SKQNAB (N)	LHSM	CX-NSZ300
O	MICON	S	0349 87-A90-164-080	OE	SW, TACT SKQNAB (N)	USM	CX-SNAJ300
O	MICON	S	0349 87-A90-164-080	OE	SW, TACT SKQNAB (N)	USM	CX-SNAJ305
O	MICON	S	0361 87-A92-040-010		SW, RTRY XRE012103PVB30F-12	LHSM	CX-NSZ300
O	MICON	S	0361 87-A92-040-010		SW, RTRY XRE012103PVB30F-12	USM	CX-SNAJ300
O	MICON	S	0361 87-A92-040-010		SW, RTRY XRE012103PVB30F-12	USM	CX-SNAJ305
O	MICON	S	0361 87-A92-041-010		SW, RTRY XRE012103PVB30F-24	EZSM	CX-NSZ300
O	MICON	S	0361 87-A92-041-010	1A	SW, RTRY XRE012103PVB30F-24	LHSM	CX-NSZ300
O	MICON	S	0361 87-A92-041-010	1A	SW, RTRY XRE012103PVB30F-24	USM	CX-SNAJ300
O	MICON	S	0361 87-A92-041-010	1A	SW, RTRY XRE012103PVB30F-24	USM	CX-SNAJ305
O	MICON	S	0371 87-A92-040-010		SW, RTRY XRE012103PVB30F-12	EZSM	CX-NSZ300
O	MICON	S	0371 87-A92-040-010	1A	SW, RTRY XRE012103PVB30F-12	LHSM	CX-NSZ300
O	MICON	S	0371 87-A92-040-010	1A	SW, RTRY XRE012103PVB30F-12	USM	CX-SNAJ300
O	MICON	S	0371 87-A92-040-010	1A	SW, RTRY XRE012103PVB30F-12	USM	CX-SNAJ305
O	MICON	S	0371 87-A92-041-010		SW, RTRY XRE012103PVB30F-24	LHSM	CX-NSZ300
O	MICON	S	0371 87-A92-041-010		SW, RTRY XRE012103PVB30F-24	USM	CX-SNAJ300
O	MICON	S	0371 87-A92-041-010		SW, RTRY XRE012103PVB30F-24	USM	CX-SNAJ305
O	OTHERS	S	82-NF5-229-010		PLATE, LOCK (*)	LHSM	CX-NSZ300
O	OTHERS		82-NF5-229-010		PLATE, LOCK (*)	USM	CX-SNAJ300
O	OTHERS		82-NF5-229-010		PLATE, LOCK (*)	USM	CX-SNAJ305
!	O OTHERS		82-NF5-229-010		PLATE, LOCK (*)	EZSM	CX-NSZ300
!	O OTHERS		82-NF5-229-010	OE	PLATE, LOCK (*)	LHSM	CX-NSZ300
!	O OTHERS		82-NF5-229-010	OE	PLATE, LOCK (*)	USM	CX-SNAJ300
!	O OTHERS		82-NF5-229-010	OE	PLATE, LOCK (*)	USM	CX-SNAJ305
O	OTHERS		86-NF9-224-010		SPR-C, LOCK	LHSM	CX-NSZ300
O	OTHERS		86-NF9-224-010		SPR-C, LOCK	USM	CX-SNAJ300
O	OTHERS		86-NF9-224-010		SPR-C, LOCK	USM	CX-SNAJ305
O	OTHERS		86-NF9-224-010		SPR-C, LOCK	EZSM	CX-NSZ300
O	OTHERS		86-NF9-224-010	OE	SPR-C, LOCK	LHSM	CX-NSZ300
O	OTHERS		86-NF9-224-010	OE	SPR-C, LOCK	USM	CX-SNAJ300
O	OTHERS		86-NF9-224-010	OE	SPR-C, LOCK	USM	CX-SNAJ305
X	OTHERS		87-064-080-010		BINDER, WIRE	EZSM	CX-NSZ300
X	OTHERS		87-064-080-010	OE	BINDER, WIRE	LHSM	CX-NSZ300
X	OTHERS		87-064-080-010	OE	BINDER, WIRE	USM	CX-SNAJ300
X	OTHERS		87-064-080-010	OE	BINDER, WIRE	USM	CX-SNAJ305
O	OTHERS		87-NF4-216-010		HLDR, LOCK 1	LHSM	CX-NSZ300
O	OTHERS		87-NF4-216-010		HLDR, LOCK 1	USM	CX-SNAJ300
O	OTHERS		87-NF4-216-010		HLDR, LOCK 1	USM	CX-SNAJ305
!	O OTHERS		87-NF4-216-010	OE	HLDR, LOCK 1	EZSM	CX-NSZ300
!	O OTHERS		87-NF4-216-010	OE	HLDR, LOCK 1	LHSM	CX-NSZ300
!	O OTHERS		87-NF4-216-010	OE	HLDR, LOCK 1	USM	CX-SNAJ300
!	O OTHERS		87-NF4-216-010	OE	HLDR, LOCK 1	USM	CX-SNAJ305
O	OTHERS		87-NF4-217-110		HLDR, LOCK 2	LHSM	CX-NSZ300
O	OTHERS		87-NF4-217-110		HLDR, LOCK 2	USM	CX-SNAJ300
O	OTHERS		87-NF4-217-110		HLDR, LOCK 2	USM	CX-SNAJ305
!	O OTHERS		87-NF4-217-110		HLDR, LOCK 2	EZSM	CX-NSZ300
!	O OTHERS		87-NF4-217-110	OE	HLDR, LOCK 2	LHSM	CX-NSZ300
!	O OTHERS		87-NF4-217-110	OE	HLDR, LOCK 2	USM	CX-SNAJ300
!	O OTHERS		87-NF4-217-110	OE	HLDR, LOCK 2	USM	CX-SNAJ305
O	OTHERS		87-NF4-221-010	OE	HLDR, LOCK 2	USM	CX-SNAJ305
O	OTHERS		87-NF4-221-010		HLDR, CABLE	LHSM	CX-NSZ300
O	OTHERS		87-NF4-221-010		HLDR, CABLE	USM	CX-SNAJ300
!	O OTHERS		87-NF4-221-010		HLDR, CABLE	EZSM	CX-NSZ300
!	O OTHERS		87-NF4-221-010	OE	HLDR, CABLE	LHSM	CX-NSZ300
!	O OTHERS		87-NF4-221-010	OE	HLDR, CABLE	USM	CX-SNAJ300
!	O OTHERS		87-NF4-221-010	OE	HLDR, CABLE	USM	CX-SNAJ305
X	OTHERS		88-NF8-202-010		HT-SINK, FIN	LHSM	CX-NSZ300
X	OTHERS		88-NF8-202-010		HT-SINK, FIN	USM	CX-SNAJ300

PARTS LIST

! = Δ SAFTY PARTS
 C = Components marked

All components used on this model at the production line are shown in this service manual.

However, please note that not all components will be available as spare parts for after-sales service.

Components marked S and O are designated as spare parts for service and will be stocked at the spare parts centers.

Components marked X and R are not designated as spare parts for after sales service, and will not be stocked at the spare parts centers.

K NO. = Only use japanese.

! C	UNIT NAME	REF NO.	PARTS CODE	K NO.	DESCRIPTION	SUFFIX	MODEL NAME
X	OTHERS		88-NF8-202-010		HT-SINK, FIN	USM	CX-SNAJ305
X	OTHERS		88-NF8-202-010	1A	HT-SINK, FIN	LHSM	CX-NSZ300
X	OTHERS		88-NF8-202-010	1A	HT-SINK, FIN	USM	CX-SNAJ300
X	OTHERS		88-NF8-202-010	1A	HT-SINK, FIN	USM	CX-SNAJ305
O	OTHERS		8A-NF8-206-010		HLDR, PWB M	LHSM	CX-NSZ300
O	OTHERS		8A-NF8-206-010		HLDR, PWB M	USM	CX-SNAJ300
O	OTHERS		8A-NF8-206-010		HLDR, PWB M	USM	CX-SNAJ305
!	O OTHERS		8A-NF8-206-010		HLDR, PWB M	EZSM	CX-NSZ300
!	O OTHERS		8A-NF8-206-010	0E	HLDR, PWB M	LHSM	CX-NSZ300
!	O OTHERS		8A-NF8-206-010	0E	HLDR, PWB M	USM	CX-SNAJ300
!	O OTHERS		8A-NF8-206-010	0E	HLDR, PWB M	USM	CX-SNAJ300
!	O OTHERS		8A-NF8-281-010	0E	HLDR, PWB M	USM	CX-SNAJ305
O	OTHERS		8A-NF8-281-010		SPR-T, EJECT 1	LHSM	CX-NSZ300
O	OTHERS		8A-NF8-281-010		SPR-T, EJECT 1	USM	CX-SNAJ300
O	OTHERS		8A-NF8-281-010		SPR-T, EJECT 1	USM	CX-SNAJ305
O	OTHERS		8A-NF8-281-010		SPR-T, EJECT 1	USM	CX-SNAJ305
O	OTHERS		8A-NF8-281-010	0E	SPR-T, EJECT 1	LHSM	CX-NSZ300
O	OTHERS		8A-NF8-281-010	0E	SPR-T, EJECT 1	USM	CX-SNAJ300
O	OTHERS		8A-NF8-281-010	0E	SPR-T, EJECT 1	USM	CX-SNAJ305
O	OTHERS		8A-NF8-282-010		SPR-T, EJECT 2	LHSM	CX-NSZ300
O	OTHERS		8A-NF8-282-010		SPR-T, EJECT 2	USM	CX-SNAJ300
O	OTHERS		8A-NF8-282-010		SPR-T, EJECT 2	USM	CX-SNAJ305
O	OTHERS		8A-NF8-282-010		SPR-T, EJECT 2	EZSM	CX-NSZ300
O	OTHERS		8A-NF8-282-010		SPR-T, EJECT 2	LHSM	CX-SNAJ300
O	OTHERS		8A-NF8-282-010		SPR-T, EJECT 2	USM	CX-SNAJ305
O	OTHERS		8A-NF9-211-010		HLDR, PWB PT HI	LHSM	CX-NSZ300
O	OTHERS		8A-NF9-211-010		HLDR, PWB PT HI	USM	CX-SNAJ300
O	OTHERS		8A-NF9-211-010		HLDR, PWB PT HI	USM	CX-SNAJ305
!	O OTHERS		8A-NF9-211-010		HLDR, PWB PT HI	EZSM	CX-NSZ300
!	O OTHERS		8A-NF9-211-010	0E	HLDR, PWB PT HI	LHSM	CX-NSZ300
!	O OTHERS		8A-NF9-211-010	0E	HLDR, PWB PT HI	USM	CX-SNAJ300
!	O OTHERS		8A-NF9-211-010	0E	HLDR, PWB PT HI	USM	CX-SNAJ305
X	OTHERS		8A-NF9-225-010	0E	SH, PT 20-16-1 W/ADH	LHSM	CX-NSZ300
X	OTHERS		8B-NF9-204-010		CUSH, 11-8.5-2	LHSM	CX-NSZ300
X	OTHERS		8B-NF9-204-010		CUSH, 11-8.5-2	USM	CX-SNAJ300
X	OTHERS		8B-NF9-204-010		CUSH, 11-8.5-2	USM	CX-SNAJ305
X	OTHERS		8B-NF9-204-010		CUSH, 11-8.5-2	EZSM	CX-NSZ300
X	OTHERS		8B-NF9-204-010	0E	CUSH, 11-8.5-2	LHSM	CX-NSZ300
X	OTHERS		8B-NF9-204-010	0E	CUSH, 11-8.5-2	USM	CX-SNAJ300
X	OTHERS		8B-NF9-204-010	0E	CUSH, 11-8.5-2	USM	CX-SNAJ305
X	OTHERS		8B-NF9-209-010		SH, TR	LHSM	CX-NSZ300
X	OTHERS		8B-NF9-209-010		SH, TR	USM	CX-SNAJ300
X	OTHERS		8B-NF9-209-010		SH, TR	USM	CX-SNAJ305
O	OTHERS		8B-NF9-211-010		HLDR, TR S	LHSM	CX-NSZ300
O	OTHERS		8B-NF9-211-010		HLDR, TR S	USM	CX-SNAJ300
O	OTHERS		8B-NF9-211-010		HLDR, TR S	USM	CX-SNAJ305
O	OTHERS		8B-NF9-211-010		HLDR, TR S	EZSM	CX-NSZ300
O	OTHERS		8B-NF9-211-010	1	HLDR, TR S	LHSM	CX-NSZ300
O	OTHERS		8B-NF9-211-010	1B	HLDR, TR S	USM	CX-SNAJ300
O	OTHERS		8B-NF9-211-010	1B	HLDR, TR S	USM	CX-SNAJ305
X	OTHERS		8B-NF9-212-010		HT-SINK, ASSY S	LHSM	CX-NSZ300
X	OTHERS		8B-NF9-212-010		HT-SINK, ASSY S	USM	CX-SNAJ300
X	OTHERS		8B-NF9-212-010		HT-SINK, ASSY S	USM	CX-SNAJ305
X	OTHERS		8B-NF9-212-010	1H	HT-SINK, ASSY S	LHSM	CX-NSZ300
X	OTHERS		8B-NF9-212-010	1H	HT-SINK, ASSY S	USM	CX-SNAJ300
X	OTHERS		8B-NF9-212-010	1H	HT-SINK, ASSY S	USM	CX-SNAJ305
X	OTHERS		8B-NF9-213-010		HT-SINK, MAIN100 S	LHSM	CX-NSZ300
X	OTHERS		8B-NF9-213-010		HT-SINK, MAIN100 S	USM	CX-SNAJ300
X	OTHERS		8B-NF9-213-010		HT-SINK, MAIN100 S	USM	CX-SNAJ305
X	OTHERS		8B-NF9-213-010	--	HT-SINK, MAIN100 S	LHSM	CX-NSZ300
X	OTHERS		8B-NF9-213-010	--	HT-SINK, MAIN100 S	USM	CX-SNAJ300
X	OTHERS		8B-NF9-213-010	--	HT-SINK, MAIN100 S	USM	CX-SNAJ305
X	OTHERS		8B-NF9-214-010		HT-SINK, MAIN60 S	EZSM	CX-NSZ300
X	OTHERS		8B-NF9-215-010	1A	PLATE, SHLD PT 1TS	USM	CX-SNAJ300
X	OTHERS		8B-NF9-215-010	1A	PLATE, SHLD PT 1TS	USM	CX-SNAJ305
X	OTHERS		8B-NFK-210-010		SH, TR VM	EZSM	CX-NSZ300
X	OTHERS		8B-NFK-210-010	0E	SH, TR VM	LHSM	CX-NSZ300
X	OTHERS		8B-NFK-210-010	0E	SH, TR VM	USM	CX-SNAJ300
X	OTHERS		8B-NFK-210-010	0E	SH, TR VM	USM	CX-SNAJ305
X	OTHERS		8Z-NB8-212-010		PLATE, EARTH MECH	LHSM	CX-NSZ300

PARTS LIST

! = Δ SAFTY PARTS
 C = Components marked

All components used on this model at the production line are shown in this service manual.

However, please note that not all components will be available as spare parts for after-sales service.

Components marked S and O are designated as spare parts for service and will be stocked at the spare parts centers.

Components marked X and R are not designated as spare parts for after sales service, and will not be stocked at the spare parts centers.

K NO. = Only use japanese.

! C	UNIT NAME	REF NO.	PARTS CODE	K NO.	DESCRIPTION	SUFFIX	MODEL NAME
X	OTHERS		8Z-NB8-212-010		PLATE, EARTH MECH	USM	CX-SNAJ300
X	OTHERS		8Z-NB8-212-010		PLATE, EARTH MECH	USM	CX-SNAJ305
X	OTHERS		8Z-NB8-212-010		PLATE, EARTH MECH	EZSM	CX-NSZ300
X	OTHERS		8Z-NB8-212-010	OE	PLATE, EARTH MECH	LHSM	CX-NSZ300
X	OTHERS		8Z-NB8-212-010	OE	PLATE, EARTH MECH	USM	CX-SNAJ300
X	OTHERS		8Z-NB8-212-010	OE	PLATE, EARTH MECH	USM	CX-SNAJ305
O	OTHERS		8Z-NF6-210-010		DMPR, 150 N	LHSM	CX-NSZ300
O	OTHERS		8Z-NF6-210-010		DMPR, 150 N	USM	CX-SNAJ300
O	OTHERS		8Z-NF6-210-010		DMPR, 150 N	USM	CX-SNAJ305
!	O OTHERS		8Z-NF6-210-010		DMPR, 150 N	EZSM	CX-NSZ300
!	O OTHERS		8Z-NF6-210-010	OE	DMPR, 150 N	LHSM	CX-NSZ300
!	O OTHERS		8Z-NF6-210-010	OE	DMPR, 150 N	USM	CX-SNAJ300
X	P-SUPPLY/PWB/FAN	*	8B-NF9-670-010		PWB, COMB MAIN -M'SIA	LHSM	CX-NSZ305
X	P-SUPPLY/PWB/FAN	*	8B-NF9-670-010		PWB, COMB MAIN -M'SIA	USM	CX-SNAJ300
X	P-SUPPLY/PWB/FAN	*	8B-NF9-670-010		PWB, COMB MAIN -M'SIA	USM	CX-SNAJ305
X	P-SUPPLY/PWB/FAN	*	8B-NF9-670-010	1E	PWB, COMB MAIN -M'SIA	LHSM	CX-NSZ300
X	P-SUPPLY/PWB/FAN	*	8B-NF9-670-010	1E	PWB, COMB MAIN -M'SIA	USM	CX-SNAJ300
X	P-SUPPLY/PWB/FAN	*	8B-NF9-670-010	1E	PWB, COMB MAIN -M'SIA	USM	CX-SNAJ305
X	P-SUPPLY/PWB/FAN	*	8B-NF9-670-110		PWB, COMB MAIN -M'SIA	EZSM	CX-NSZ300
X	P-SUPPLY/PWB/FAN	*	8B-NF9-671-010		PWB, MAIN-M'SIA	LHSM	CX-NSZ300
X	P-SUPPLY/PWB/FAN	*	8B-NF9-671-010		PWB, MAIN-M'SIA	USM	CX-SNAJ300
X	P-SUPPLY/PWB/FAN	*	8B-NF9-671-010		PWB, MAIN-M'SIA	USM	CX-SNAJ305
X	P-SUPPLY/PWB/FAN	*	8B-NF9-671-010	--	PWB, MAIN-M'SIA	LHSM	CX-NSZ300
X	P-SUPPLY/PWB/FAN	*	8B-NF9-671-010	--	PWB, MAIN-M'SIA	USM	CX-SNAJ300
X	P-SUPPLY/PWB/FAN	*	8B-NF9-671-010	--	PWB, MAIN-M'SIA	USM	CX-SNAJ305
X	P-SUPPLY/PWB/FAN	*	8B-NF9-671-110		PWB, MAIN-M'SIA	EZSM	CX-NSZ300
X	P-SUPPLY/PWB/FAN	*	8B-NF9-672-010		PWB, PT-M'SIA	USM	CX-SNAJ300
X	P-SUPPLY/PWB/FAN	*	8B-NF9-672-010		PWB, PT-M'SIA	USM	CX-SNAJ305
X	P-SUPPLY/PWB/FAN	*	8B-NF9-672-010	--	PWB, PT-M'SIA	USM	CX-SNAJ300
X	P-SUPPLY/PWB/FAN	*	8B-NF9-672-010	--	PWB, PT-M'SIA	USM	CX-SNAJ305
X	P-SUPPLY/PWB/FAN	*	8B-NF9-672-110		PWB, PT-M'SIA	EZSM	CX-NSZ300
O	P-SUPPLY/PWB/FAN	C 0003	87-012-368-080		C-CAP, S 0.1-50 Z F	LHSM	CX-NSZ300
O	P-SUPPLY/PWB/FAN	C 0003	87-012-368-080		C-CAP, S 0.1-50 Z F	USM	CX-SNAJ300
O	P-SUPPLY/PWB/FAN	C 0003	87-012-368-080		C-CAP, S 0.1-50 Z F	USM	CX-SNAJ305
O	P-SUPPLY/PWB/FAN	C 0003	87-012-368-080		C-CAP, S 0.1-50 Z F	EZSM	CX-NSZ300
O	P-SUPPLY/PWB/FAN	C 0003	87-012-368-080	OE	C-CAP, S 0.1-50 Z F	LHSM	CX-NSZ300
O	P-SUPPLY/PWB/FAN	C 0003	87-012-368-080	OE	C-CAP, S 0.1-50 Z F	USM	CX-SNAJ300
O	P-SUPPLY/PWB/FAN	C 0003	87-012-368-080	OE	C-CAP, S 0.1-50 Z F	USM	CX-SNAJ305
O	P-SUPPLY/PWB/FAN	C 0004	87-012-368-080		C-CAP, S 0.1-50 Z F	LHSM	CX-NSZ300
O	P-SUPPLY/PWB/FAN	C 0004	87-012-368-080		C-CAP, S 0.1-50 Z F	USM	CX-SNAJ300
O	P-SUPPLY/PWB/FAN	C 0004	87-012-368-080		C-CAP, S 0.1-50 Z F	EZSM	CX-NSZ300
O	P-SUPPLY/PWB/FAN	C 0004	87-012-368-080	OE	C-CAP, S 0.1-50 Z F	LHSM	CX-NSZ300
O	P-SUPPLY/PWB/FAN	C 0004	87-012-368-080	OE	C-CAP, S 0.1-50 Z F	USM	CX-SNAJ300
O	P-SUPPLY/PWB/FAN	C 0005	87-012-368-080		C-CAP, S 0.1-50 Z F	LHSM	CX-NSZ300
O	P-SUPPLY/PWB/FAN	C 0005	87-012-368-080		C-CAP, S 0.1-50 Z F	USM	CX-SNAJ300
O	P-SUPPLY/PWB/FAN	C 0005	87-012-368-080		C-CAP, S 0.1-50 Z F	USM	CX-SNAJ305
O	P-SUPPLY/PWB/FAN	C 0005	87-012-368-080		C-CAP, S 0.1-50 Z F	EZSM	CX-NSZ300
O	P-SUPPLY/PWB/FAN	C 0005	87-012-368-080	OE	C-CAP, S 0.1-50 Z F	LHSM	CX-NSZ300
O	P-SUPPLY/PWB/FAN	C 0005	87-012-368-080	OE	C-CAP, S 0.1-50 Z F	USM	CX-SNAJ300
O	P-SUPPLY/PWB/FAN	C 0005	87-012-368-080	OE	C-CAP, S 0.1-50 Z F	USM	CX-SNAJ305
O	P-SUPPLY/PWB/FAN	C 0006	87-012-368-080		C-CAP, S 0.1-50 Z F	LHSM	CX-NSZ300
O	P-SUPPLY/PWB/FAN	C 0006	87-012-368-080		C-CAP, S 0.1-50 Z F	USM	CX-SNAJ300
O	P-SUPPLY/PWB/FAN	C 0006	87-012-368-080		C-CAP, S 0.1-50 Z F	USM	CX-SNAJ305
O	P-SUPPLY/PWB/FAN	C 0006	87-012-368-080		C-CAP, S 0.1-50 Z F	EZSM	CX-NSZ300
O	P-SUPPLY/PWB/FAN	C 0006	87-012-368-080	OE	C-CAP, S 0.1-50 Z F	LHSM	CX-NSZ300
O	P-SUPPLY/PWB/FAN	C 0006	87-012-368-080	OE	C-CAP, S 0.1-50 Z F	USM	CX-SNAJ300
O	P-SUPPLY/PWB/FAN	C 0006	87-012-368-080	OE	C-CAP, S 0.1-50 Z F	USM	CX-SNAJ305
O	P-SUPPLY/PWB/FAN	C 0009	87-010-759-080		C-CAP, U 0.1-25 Z F	LHSM	CX-NSZ300
O	P-SUPPLY/PWB/FAN	C 0009	87-010-759-080		C-CAP, U 0.1-25 Z F	USM	CX-SNAJ300
O	P-SUPPLY/PWB/FAN	C 0009	87-010-759-080		C-CAP, U 0.1-25 Z F	USM	CX-SNAJ305
O	P-SUPPLY/PWB/FAN	C 0009	87-010-759-080		C-CAP, U 0.1-25 Z F	EZSM	CX-NSZ300
O	P-SUPPLY/PWB/FAN	C 0009	87-010-759-080	OE	C-CAP, U 0.1-25 Z F	LHSM	CX-NSZ300
O	P-SUPPLY/PWB/FAN	C 0009	87-010-759-080	OE	C-CAP, U 0.1-25 Z F	USM	CX-SNAJ300
O	P-SUPPLY/PWB/FAN	C 0009	87-010-759-080	OE	C-CAP, U 0.1-25 Z F	USM	CX-SNAJ305
O	P-SUPPLY/PWB/FAN	C 0010	87-010-759-080		C-CAP, U 0.1-25 Z F	LHSM	CX-NSZ300
O	P-SUPPLY/PWB/FAN	C 0010	87-010-759-080		C-CAP, U 0.1-25 Z F	USM	CX-SNAJ300
O	P-SUPPLY/PWB/FAN	C 0010	87-010-759-080		C-CAP, U 0.1-25 Z F	USM	CX-SNAJ305

PARTS LIST

! = Δ SAFTY PARTS
 C = Components marked

All components used on this model at the production line are shown in this service manual.
 However, please note that not all components will be available as spare parts for after-sales service.
 Components marked S and O are designated as spare parts for service and will be stocked at the spare parts centers.
 Components marked X and R are not designated as spare parts for after sales service, and will not be stocked at the spare parts centers.
 K NO. = Only use japanese.

! C	UNIT NAME	REF NO.	PARTS CODE	K NO.	DESCRIPTION	SUFFIX	MODEL NAME
O	P-SUPPLY/PWB/FAN	C	0010	87-010-759-080	C-CAP,U	0.1-25 Z F	EZSM CX-NSZ300
O	P-SUPPLY/PWB/FAN	C	0010	87-010-759-080	OE C-CAP,U	0.1-25 Z F	LHSM CX-NSZ300
O	P-SUPPLY/PWB/FAN	C	0010	87-010-759-080	OE C-CAP,U	0.1-25 Z F	USM CX-SNAJ300
O	P-SUPPLY/PWB/FAN	C	0010	87-010-759-080	OE C-CAP,U	0.1-25 Z F	USM CX-SNAJ305
O	P-SUPPLY/PWB/FAN	C	0011	87-010-759-080	C-CAP,U	0.1-25 Z F	LHSM CX-NSZ300
O	P-SUPPLY/PWB/FAN	C	0011	87-010-759-080	C-CAP,U	0.1-25 Z F	USM CX-SNAJ300
O	P-SUPPLY/PWB/FAN	C	0011	87-010-759-080	C-CAP,U	0.1-25 Z F	USM CX-SNAJ305
O	P-SUPPLY/PWB/FAN	C	0011	87-010-759-080	C-CAP,U	0.1-25 Z F	EZSM CX-NSZ300
O	P-SUPPLY/PWB/FAN	C	0011	87-010-759-080	OE C-CAP,U	0.1-25 Z F	LHSM CX-NSZ300
O	P-SUPPLY/PWB/FAN	C	0011	87-010-759-080	OE C-CAP,U	0.1-25 Z F	USM CX-SNAJ300
O	P-SUPPLY/PWB/FAN	C	0011	87-010-759-080	OE C-CAP,U	0.1-25 Z F	USM CX-SNAJ305
O	P-SUPPLY/PWB/FAN	C	0012	87-010-759-080	C-CAP,U	0.1-25 Z F	LHSM CX-NSZ300
O	P-SUPPLY/PWB/FAN	C	0012	87-010-759-080	C-CAP,U	0.1-25 Z F	USM CX-SNAJ300
O	P-SUPPLY/PWB/FAN	C	0012	87-010-759-080	C-CAP,U	0.1-25 Z F	USM CX-SNAJ305
O	P-SUPPLY/PWB/FAN	C	0012	87-010-759-080	C-CAP,U	0.1-25 Z F	USM CX-SNAJ305
O	P-SUPPLY/PWB/FAN	C	0012	87-010-759-080	OE C-CAP,U	0.1-25 Z F	EZSM CX-NSZ300
O	P-SUPPLY/PWB/FAN	C	0012	87-010-759-080	OE C-CAP,U	0.1-25 Z F	LHSM CX-NSZ300
O	P-SUPPLY/PWB/FAN	C	0012	87-010-759-080	OE C-CAP,U	0.1-25 Z F	USM CX-SNAJ300
O	P-SUPPLY/PWB/FAN	C	0012	87-010-759-080	OE C-CAP,U	0.1-25 Z F	USM CX-SNAJ305
O	P-SUPPLY/PWB/FAN	C	0019	87-A12-036-000	CAP,E	2200-63 M SMG	LHSM CX-NSZ300
O	P-SUPPLY/PWB/FAN	C	0019	87-A12-036-000	CAP,E	2200-63 M SMG	USM CX-SNAJ300
O	P-SUPPLY/PWB/FAN	C	0019	87-A12-036-000	1C CAP,E	2200-63 M SMG	LHSM CX-NSZ300
O	P-SUPPLY/PWB/FAN	C	0019	87-A12-036-000	1C CAP,E	2200-63 M SMG	USM CX-SNAJ300
O	P-SUPPLY/PWB/FAN	C	0019	87-A12-036-000	1C CAP,E	2200-63 M SMG	USM CX-SNAJ305
O	P-SUPPLY/PWB/FAN	C	0019	87-A12-776-090	CAP,E	2200-50 M 85 SKR	EZSM CX-NSZ300
O	P-SUPPLY/PWB/FAN	C	0020	87-A12-036-000	CAP,E	2200-63 M SMG	LHSM CX-NSZ300
O	P-SUPPLY/PWB/FAN	C	0020	87-A12-036-000	CAP,E	2200-63 M SMG	USM CX-SNAJ300
O	P-SUPPLY/PWB/FAN	C	0020	87-A12-036-000	CAP,E	2200-63 M SMG	USM CX-SNAJ305
O	P-SUPPLY/PWB/FAN	C	0020	87-A12-036-000	1C CAP,E	2200-63 M SMG	LHSM CX-NSZ300
O	P-SUPPLY/PWB/FAN	C	0020	87-A12-036-000	1C CAP,E	2200-63 M SMG	USM CX-SNAJ300
O	P-SUPPLY/PWB/FAN	C	0020	87-A12-036-000	1C CAP,E	2200-63 M SMG	USM CX-SNAJ305
O	P-SUPPLY/PWB/FAN	C	0020	87-A12-776-090	CAP,E	2200-50 M 85 SKR	EZSM CX-NSZ300
O	P-SUPPLY/PWB/FAN	C	0021	87-016-495-000	CAP,E	3300-25 M SMG	LHSM CX-NSZ300
O	P-SUPPLY/PWB/FAN	C	0021	87-016-495-000	CAP,E	3300-25 M SMG	USM CX-SNAJ300
O	P-SUPPLY/PWB/FAN	C	0021	87-016-495-000	CAP,E	3300-25 M SMG	USM CX-SNAJ305
O	P-SUPPLY/PWB/FAN	C	0021	87-016-495-000	CAP,E	3300-25 M SMG	USM CX-SNAJ305
O	P-SUPPLY/PWB/FAN	C	0021	87-A12-777-090	CAP,E	3300-25 M 85 SKR	EZSM CX-NSZ300
O	P-SUPPLY/PWB/FAN	C	0021	87-A12-777-090	1A CAP,E	3300-25 M 85 SKR	LHSM CX-NSZ300
O	P-SUPPLY/PWB/FAN	C	0021	87-A12-777-090	1A CAP,E	3300-25 M 85 SKR	USM CX-SNAJ300
O	P-SUPPLY/PWB/FAN	C	0021	87-A12-777-090	1A CAP,E	3300-25 M 85 SKR	USM CX-SNAJ305
O	P-SUPPLY/PWB/FAN	C	0022	87-016-495-000	CAP,E	3300-25 M SMG	LHSM CX-NSZ300
O	P-SUPPLY/PWB/FAN	C	0022	87-016-495-000	CAP,E	3300-25 M SMG	USM CX-SNAJ305
O	P-SUPPLY/PWB/FAN	C	0022	87-A12-777-090	CAP,E	3300-25 M 85 SKR	EZSM CX-NSZ300
O	P-SUPPLY/PWB/FAN	C	0022	87-A12-777-090	1A CAP,E	3300-25 M 85 SKR	LHSM CX-NSZ300
O	P-SUPPLY/PWB/FAN	C	0022	87-A12-777-090	1A CAP,E	3300-25 M 85 SKR	USM CX-SNAJ300
O	P-SUPPLY/PWB/FAN	C	0022	87-A12-777-090	1A CAP,E	3300-25 M 85 SKR	USM CX-SNAJ305
O	P-SUPPLY/PWB/FAN	C	0025	87-A12-072-080	CAP,E	100-25 SMG	LHSM CX-NSZ300
O	P-SUPPLY/PWB/FAN	C	0025	87-A12-072-080	CAP,E	100-25 SMG	USM CX-SNAJ300
O	P-SUPPLY/PWB/FAN	C	0025	87-A12-072-080	CAP,E	100-25 SMG	USM CX-SNAJ305
O	P-SUPPLY/PWB/FAN	C	0026	87-A12-072-080	CAP,E	100-25 SMG	LHSM CX-NSZ300
O	P-SUPPLY/PWB/FAN	C	0026	87-A12-072-080	CAP,E	100-25 SMG	USM CX-SNAJ300
O	P-SUPPLY/PWB/FAN	C	0026	87-A12-072-080	CAP,E	100-25 SMG	USM CX-SNAJ305
O	P-SUPPLY/PWB/FAN	C	0026	87-A12-072-080	CAP,E	100-25 SMG	EZSM CX-NSZ300
O	P-SUPPLY/PWB/FAN	C	0026	87-A12-072-080	OE CAP,E	100-25 SMG	LHSM CX-NSZ300
O	P-SUPPLY/PWB/FAN	C	0026	87-A12-072-080	OE CAP,E	100-25 SMG	USM CX-SNAJ300
O	P-SUPPLY/PWB/FAN	C	0026	87-A12-072-080	OE CAP,E	100-25 SMG	USM CX-SNAJ305
O	P-SUPPLY/PWB/FAN	C	0027	87-A12-072-080	CAP,E	100-25 SMG	LHSM CX-NSZ300
O	P-SUPPLY/PWB/FAN	C	0027	87-A12-072-080	CAP,E	100-25 SMG	USM CX-SNAJ300
O	P-SUPPLY/PWB/FAN	C	0027	87-A12-072-080	CAP,E	100-25 SMG	USM CX-SNAJ305
O	P-SUPPLY/PWB/FAN	C	0027	87-A12-072-080	CAP,E	100-25 SMG	EZSM CX-NSZ300
O	P-SUPPLY/PWB/FAN	C	0027	87-A12-072-080	OE CAP,E	100-25 SMG	LHSM CX-NSZ300
O	P-SUPPLY/PWB/FAN	C	0027	87-A12-072-080	OE CAP,E	100-25 SMG	USM CX-SNAJ300
O	P-SUPPLY/PWB/FAN	C	0027	87-A12-072-080	OE CAP,E	100-25 SMG	USM CX-SNAJ305
O	P-SUPPLY/PWB/FAN	C	0028	87-A12-072-080	CAP,E	100-25 SMG	LHSM CX-NSZ300
O	P-SUPPLY/PWB/FAN	C	0028	87-A12-072-080	CAP,E	100-25 SMG	USM CX-SNAJ300
O	P-SUPPLY/PWB/FAN	C	0028	87-A12-072-080	CAP,E	100-25 SMG	USM CX-SNAJ305

PARTS LIST

! = △ SAFTY PARTS
 C = Components marked

All components used on this model at the production line are shown in this service manual.

However, please note that not all components will be available as spare parts for after-sales service.

Components marked S and O are designated as spare parts for service and will be stocked at the spare parts centers.

Components marked X and R are not designated as spare parts for after sales service, and will not be stocked at the spare parts centers.

K NO. = Only use japanese.

! C	UNIT NAME	REF NO.	PARTS CODE	K NO.	DESCRIPTION	SUFFIX	MODEL NAME	
O	P-SUPPLY/PWB/FAN	C	0028	87-A12-072-080		CAP,E 100-25 SMG	EZSM	CX-NSZ300
O	P-SUPPLY/PWB/FAN	C	0028	87-A12-072-080	OE	CAP,E 100-25 SMG	LHSM	CX-NSZ300
O	P-SUPPLY/PWB/FAN	C	0028	87-A12-072-080	OE	CAP,E 100-25 SMG	USM	CX-SNAJ300
O	P-SUPPLY/PWB/FAN	C	0028	87-A12-072-080	OE	CAP,E 100-25 SMG	USM	CX-SNAJ305
O	P-SUPPLY/PWB/FAN	C	0030	87-A12-095-080		CAP,E 100-50 SMG	LHSM	CX-NSZ300
O	P-SUPPLY/PWB/FAN	C	0030	87-A12-095-080		CAP,E 100-50 SMG	USM	CX-SNAJ300
O	P-SUPPLY/PWB/FAN	C	0030	87-A12-095-080		CAP,E 100-50 SMG	USM	CX-SNAJ305
O	P-SUPPLY/PWB/FAN	C	0030	87-A12-095-080		CAP,E 100-50 SMG	EZSM	CX-NSZ300
O	P-SUPPLY/PWB/FAN	C	0030	87-A12-095-080	OE	CAP,E 100-50 SMG	LHSM	CX-NSZ300
O	P-SUPPLY/PWB/FAN	C	0030	87-A12-095-080	OE	CAP,E 100-50 SMG	USM	CX-SNAJ300
O	P-SUPPLY/PWB/FAN	C	0030	87-A12-095-080	OE	CAP,E 100-50 SMG	USM	CX-SNAJ305
O	P-SUPPLY/PWB/FAN	C	0031	87-A12-062-080		CAP,E 100-10 SMG	LHSM	CX-NSZ300
O	P-SUPPLY/PWB/FAN	C	0031	87-A12-062-080		CAP,E 100-10 SMG	USM	CX-SNAJ300
O	P-SUPPLY/PWB/FAN	C	0031	87-A12-062-080		CAP,E 100-10 SMG	USM	CX-SNAJ305
O	P-SUPPLY/PWB/FAN	C	0031	87-A12-062-080		CAP,E 100-10 SMG	EZSM	CX-NSZ300
O	P-SUPPLY/PWB/FAN	C	0031	87-A12-062-080	OE	CAP,E 100-10 SMG	LHSM	CX-NSZ300
O	P-SUPPLY/PWB/FAN	C	0031	87-A12-062-080	OE	CAP,E 100-10 SMG	USM	CX-SNAJ300
O	P-SUPPLY/PWB/FAN	C	0031	87-A12-062-080	OE	CAP,E 100-10 SMG	USM	CX-SNAJ305
O	P-SUPPLY/PWB/FAN	C	0032	87-012-286-080		C-CAP,U 0.01-25 K B	LHSM	CX-NSZ300
O	P-SUPPLY/PWB/FAN	C	0032	87-012-286-080		C-CAP,U 0.01-25 K B	USM	CX-SNAJ300
O	P-SUPPLY/PWB/FAN	C	0032	87-012-286-080		C-CAP,U 0.01-25 K B	USM	CX-SNAJ305
O	P-SUPPLY/PWB/FAN	C	0032	87-012-286-080		C-CAP,U 0.01-25 K B	EZSM	CX-NSZ300
O	P-SUPPLY/PWB/FAN	C	0032	87-012-286-080	OE	C-CAP,U 0.01-25 K B	LHSM	CX-NSZ300
O	P-SUPPLY/PWB/FAN	C	0032	87-012-286-080	OE	C-CAP,U 0.01-25 K B	USM	CX-SNAJ300
O	P-SUPPLY/PWB/FAN	C	0032	87-012-286-080	OE	C-CAP,U 0.01-25 K B	USM	CX-SNAJ305
O	P-SUPPLY/PWB/FAN	C	0033	87-A12-062-080		CAP,E 100-10 SMG	USM	CX-SNAJ300
O	P-SUPPLY/PWB/FAN	C	0033	87-A12-062-080		CAP,E 100-10 SMG	USM	CX-SNAJ305
O	P-SUPPLY/PWB/FAN	C	0033	87-A12-062-080	OE	CAP,E 100-10 SMG	USM	CX-SNAJ300
O	P-SUPPLY/PWB/FAN	C	0033	87-A12-062-080	OE	CAP,E 100-10 SMG	USM	CX-SNAJ305
O	P-SUPPLY/PWB/FAN	C	0034	87-A12-072-080		CAP,E 100-25 SMG	LHSM	CX-NSZ300
O	P-SUPPLY/PWB/FAN	C	0034	87-A12-072-080		CAP,E 100-25 SMG	USM	CX-SNAJ300
O	P-SUPPLY/PWB/FAN	C	0034	87-A12-072-080		CAP,E 100-25 SMG	USM	CX-SNAJ305
O	P-SUPPLY/PWB/FAN	C	0034	87-A12-072-080		CAP,E 100-25 SMG	EZSM	CX-NSZ300
O	P-SUPPLY/PWB/FAN	C	0034	87-A12-072-080	OE	CAP,E 100-25 SMG	LHSM	CX-NSZ300
O	P-SUPPLY/PWB/FAN	C	0034	87-A12-072-080	OE	CAP,E 100-25 SMG	USM	CX-SNAJ300
O	P-SUPPLY/PWB/FAN	C	0034	87-A12-072-080	OE	CAP,E 100-25 SMG	USM	CX-SNAJ305
O	P-SUPPLY/PWB/FAN	C	0035	87-A12-071-080		CAP,E 47-25 SMG	LHSM	CX-NSZ300
O	P-SUPPLY/PWB/FAN	C	0035	87-A12-071-080		CAP,E 47-25 SMG	USM	CX-SNAJ300
O	P-SUPPLY/PWB/FAN	C	0035	87-A12-071-080		CAP,E 47-25 SMG	USM	CX-SNAJ305
O	P-SUPPLY/PWB/FAN	C	0035	87-A12-071-080		CAP,E 47-25 SMG	EZSM	CX-NSZ300
O	P-SUPPLY/PWB/FAN	C	0035	87-A12-071-080	OE	CAP,E 47-25 SMG	LHSM	CX-NSZ300
O	P-SUPPLY/PWB/FAN	C	0035	87-A12-071-080	OE	CAP,E 47-25 SMG	USM	CX-SNAJ300
O	P-SUPPLY/PWB/FAN	C	0035	87-A12-071-080	OE	CAP,E 47-25 SMG	USM	CX-SNAJ305
O	P-SUPPLY/PWB/FAN	C	0036	87-A12-067-080		CAP,E 330-16 SMG	LHSM	CX-NSZ300
O	P-SUPPLY/PWB/FAN	C	0036	87-A12-067-080		CAP,E 330-16 SMG	USM	CX-SNAJ300
O	P-SUPPLY/PWB/FAN	C	0036	87-A12-067-080		CAP,E 330-16 SMG	USM	CX-SNAJ305
O	P-SUPPLY/PWB/FAN	C	0036	87-A12-067-080		CAP,E 330-16 SMG	EZSM	CX-NSZ300
O	P-SUPPLY/PWB/FAN	C	0036	87-A12-067-080	OE	CAP,E 330-16 SMG	LHSM	CX-NSZ300
O	P-SUPPLY/PWB/FAN	C	0036	87-A12-067-080	OE	CAP,E 330-16 SMG	USM	CX-SNAJ300
O	P-SUPPLY/PWB/FAN	C	0036	87-A12-067-080	OE	CAP,E 330-16 SMG	USM	CX-SNAJ305
O	P-SUPPLY/PWB/FAN	C	0038	87-012-286-080		C-CAP,U 0.01-25 K B	LHSM	CX-NSZ300
O	P-SUPPLY/PWB/FAN	C	0038	87-012-286-080		C-CAP,U 0.01-25 K B	USM	CX-SNAJ300
O	P-SUPPLY/PWB/FAN	C	0038	87-012-286-080		C-CAP,U 0.01-25 K B	USM	CX-SNAJ305
O	P-SUPPLY/PWB/FAN	C	0038	87-012-286-080		C-CAP,U 0.01-25 K B	EZSM	CX-NSZ300
O	P-SUPPLY/PWB/FAN	C	0038	87-012-286-080	OE	C-CAP,U 0.01-25 K B	LHSM	CX-NSZ300
O	P-SUPPLY/PWB/FAN	C	0038	87-012-286-080	OE	C-CAP,U 0.01-25 K B	USM	CX-SNAJ300
O	P-SUPPLY/PWB/FAN	C	0038	87-012-286-080	OE	C-CAP,U 0.01-25 K B	USM	CX-SNAJ305
O	P-SUPPLY/PWB/FAN	C	0060	87-A12-089-080		CAP,E 3.3-50 SMG	LHSM	CX-NSZ300
O	P-SUPPLY/PWB/FAN	C	0060	87-A12-089-080		CAP,E 3.3-50 SMG	USM	CX-SNAJ300
O	P-SUPPLY/PWB/FAN	C	0060	87-A12-089-080		CAP,E 3.3-50 SMG	USM	CX-SNAJ305
O	P-SUPPLY/PWB/FAN	C	0060	87-A12-089-080		CAP,E 3.3-50 SMG	EZSM	CX-NSZ300
O	P-SUPPLY/PWB/FAN	C	0060	87-A12-089-080	OE	CAP,E 3.3-50 SMG	LHSM	CX-NSZ300
O	P-SUPPLY/PWB/FAN	C	0060	87-A12-089-080	OE	CAP,E 3.3-50 SMG	USM	CX-SNAJ300
O	P-SUPPLY/PWB/FAN	C	0060	87-A12-089-080	OE	CAP,E 3.3-50 SMG	USM	CX-SNAJ305
O	P-SUPPLY/PWB/FAN	C	0061	87-A12-071-080		CAP,E 47-25 SMG	LHSM	CX-NSZ300
O	P-SUPPLY/PWB/FAN	C	0061	87-A12-071-080		CAP,E 47-25 SMG	USM	CX-SNAJ300
O	P-SUPPLY/PWB/FAN	C	0061	87-A12-071-080		CAP,E 47-25 SMG	USM	CX-SNAJ305
O	P-SUPPLY/PWB/FAN	C	0061	87-A12-071-080		CAP,E 47-25 SMG	EZSM	CX-NSZ300
O	P-SUPPLY/PWB/FAN	C	0061	87-A12-071-080	OE	CAP,E 47-25 SMG	LHSM	CX-NSZ300
O	P-SUPPLY/PWB/FAN	C	0061	87-A12-071-080	OE	CAP,E 47-25 SMG	USM	CX-SNAJ300

PARTS LIST

- ! = Δ SAFETY PARTS
 C = Components marked

All components used on this model at the production line are shown in this service manual.

However, please note that not all components will be available as spare parts for after-sales service.

Components marked S and O are designated as spare parts for service and will be stocked at the spare parts centers.

Components marked X and R are not designated as spare parts for after sales service, and will not be stocked at the spare parts centers.

K NO. = Only use Japanese.

! C	UNIT NAME	REF NO.	PARTS CODE	K NO.	DESCRIPTION	SUFFIX	MODEL NAME
O	P-SUPPLY/PWB/FAN	C	0061 87-A12-071-080	0E	CAP,E 47-25 SMG	USM	CX-SNAJ305
O	P-SUPPLY/PWB/FAN	C	0083 87-A12-068-080		CAP,E 470-16 SMG	EZSM	CX-NSZ300
O	P-SUPPLY/PWB/FAN	C	0083 87-A12-074-080		CAP,E 470-25 SMG	LHSM	CX-NSZ300
O	P-SUPPLY/PWB/FAN	C	0083 87-A12-074-080		CAP,E 470-25 SMG	USM	CX-SNAJ300
O	P-SUPPLY/PWB/FAN	C	0083 87-A12-074-080		CAP,E 470-25 SMG	USM	CX-SNAJ305
O	P-SUPPLY/PWB/FAN	C	0083 87-A12-074-080	0E	CAP,E 470-25 SMG	LHSM	CX-NSZ300
O	P-SUPPLY/PWB/FAN	C	0083 87-A12-074-080	0E	CAP,E 470-25 SMG	USM	CX-SNAJ300
O	P-SUPPLY/PWB/FAN	C	0083 87-A12-074-080	0E	CAP,E 470-25 SMG	USM	CX-SNAJ305
O	P-SUPPLY/PWB/FAN	C	0097 87-010-831-080		C-CAP,U 0.1-16 Z F	LHSM	CX-NSZ300
O	P-SUPPLY/PWB/FAN	C	0097 87-010-831-080		C-CAP,U 0.1-16 Z F	USM	CX-SNAJ300
O	P-SUPPLY/PWB/FAN	C	0097 87-010-831-080		C-CAP,U 0.1-16 Z F	USM	CX-SNAJ305
O	P-SUPPLY/PWB/FAN	C	0097 87-010-831-080	0E	C-CAP,U 0.1-16 Z F	LHSM	CX-NSZ300
O	P-SUPPLY/PWB/FAN	C	0097 87-010-831-080	0E	C-CAP,U 0.1-16 Z F	USM	CX-SNAJ300
O	P-SUPPLY/PWB/FAN	C	0097 87-010-831-080	0E	C-CAP,U 0.1-16 Z F	USM	CX-SNAJ305
!	P-SUPPLY/PWB/FAN	CNA0001	8A-NF8-653-010		CONN ASSY,9P TID-A(480)	LHSM	CX-NSZ300
!	P-SUPPLY/PWB/FAN	CNA0001	8A-NF8-653-010	1B	CONN ASSY,9P TID-A(480)	LHSM	CX-NSZ300
S	P-SUPPLY/PWB/FAN	D	0005 87-A40-393-090		DIODE,1N5402GW(F20)	USM	CX-SNAJ305
S	P-SUPPLY/PWB/FAN	D	0005 87-A40-393-090	0E	DIODE,1N5402GW(F20)	USM	CX-SNAJ305
S	P-SUPPLY/PWB/FAN	D	0006 87-A40-393-090		DIODE,1N5402GW(F20)	USM	CX-SNAJ305
S	P-SUPPLY/PWB/FAN	D	0006 87-A40-393-090	0E	DIODE,1N5402GW(F20)	USM	CX-SNAJ305
S	P-SUPPLY/PWB/FAN	D	0007 87-A40-393-090		DIODE,1N5402GW(F20)	USM	CX-SNAJ305
S	P-SUPPLY/PWB/FAN	D	0007 87-A40-393-090	0E	DIODE,1N5402GW(F20)	USM	CX-SNAJ305
S	P-SUPPLY/PWB/FAN	D	0008 87-A40-393-090		DIODE,1N5402GW(F20)	USM	CX-SNAJ305
S	P-SUPPLY/PWB/FAN	D	0008 87-A40-393-090	0E	DIODE,1N5402GW(F20)	USM	CX-SNAJ305
S	P-SUPPLY/PWB/FAN	D	0013 87-A40-454-090		DIODE,1N5393 GW 12.5	EZSM	CX-NSZ300
S	P-SUPPLY/PWB/FAN	D	0013 87-A40-455-090		DIODE,RL203 GW	LHSM	CX-NSZ300
S	P-SUPPLY/PWB/FAN	D	0013 87-A40-455-090		DIODE,RL203 GW	USM	CX-SNAJ300
S	P-SUPPLY/PWB/FAN	D	0013 87-A40-455-090		DIODE,RL203 GW	USM	CX-SNAJ305
S	P-SUPPLY/PWB/FAN	D	0013 87-A40-455-090	0E	DIODE,RL203 GW	LHSM	CX-NSZ300
S	P-SUPPLY/PWB/FAN	D	0013 87-A40-455-090	0E	DIODE,RL203 GW	USM	CX-SNAJ300
S	P-SUPPLY/PWB/FAN	D	0013 87-A40-455-090	0E	DIODE,RL203 GW	USM	CX-SNAJ305
S	P-SUPPLY/PWB/FAN	D	0013 87-A40-455-090	0E	DIODE,RL203 GW	LHSM	CX-NSZ300
S	P-SUPPLY/PWB/FAN	D	0013 87-A40-455-090	0E	DIODE,RL203 GW	USM	CX-SNAJ300
S	P-SUPPLY/PWB/FAN	D	0013 87-A40-455-090	0E	DIODE,RL203 GW	USM	CX-SNAJ305
S	P-SUPPLY/PWB/FAN	D	0014 87-A40-454-090		DIODE,1N5393 GW 12.5	EZSM	CX-NSZ300
S	P-SUPPLY/PWB/FAN	D	0014 87-A40-454-090	0E	DIODE,1N5393 GW 12.5	LHSM	CX-NSZ300
S	P-SUPPLY/PWB/FAN	D	0014 87-A40-455-090		DIODE,RL203 GW	USM	CX-SNAJ300
S	P-SUPPLY/PWB/FAN	D	0014 87-A40-455-090	0E	DIODE,RL203 GW	LHSM	CX-SNAJ305
S	P-SUPPLY/PWB/FAN	D	0014 87-A40-455-090	0E	DIODE,RL203 GW	USM	CX-NSZ300
S	P-SUPPLY/PWB/FAN	D	0014 87-A40-455-090	0E	DIODE,RL203 GW	USM	CX-SNAJ300
S	P-SUPPLY/PWB/FAN	D	0014 87-A40-455-090	0E	DIODE,RL203 GW	USM	CX-SNAJ305
S	P-SUPPLY/PWB/FAN	D	0015 87-A40-454-090		DIODE,1N5393 GW 12.5	EZSM	CX-NSZ300
S	P-SUPPLY/PWB/FAN	D	0015 87-A40-455-090		DIODE,RL203 GW	LHSM	CX-NSZ300
S	P-SUPPLY/PWB/FAN	D	0015 87-A40-455-090		DIODE,RL203 GW	USM	CX-SNAJ300
S	P-SUPPLY/PWB/FAN	D	0015 87-A40-455-090	0E	DIODE,RL203 GW	LHSM	CX-SNAJ305
S	P-SUPPLY/PWB/FAN	D	0015 87-A40-455-090	0E	DIODE,RL203 GW	USM	CX-SNAJ300
S	P-SUPPLY/PWB/FAN	D	0015 87-A40-455-090	0E	DIODE,RL203 GW	USM	CX-SNAJ305
S	P-SUPPLY/PWB/FAN	D	0015 87-A40-455-090	0E	DIODE,RL203 GW	LHSM	CX-NSZ300
S	P-SUPPLY/PWB/FAN	D	0015 87-A40-455-090	0E	DIODE,RL203 GW	USM	CX-SNAJ300
S	P-SUPPLY/PWB/FAN	D	0016 87-A40-454-090		DIODE,1N5393 GW 12.5	EZSM	CX-NSZ300
S	P-SUPPLY/PWB/FAN	D	0016 87-A40-455-090		DIODE,RL203 GW	LHSM	CX-NSZ300
S	P-SUPPLY/PWB/FAN	D	0016 87-A40-455-090		DIODE,RL203 GW	USM	CX-SNAJ300
S	P-SUPPLY/PWB/FAN	D	0016 87-A40-455-090	0E	DIODE,RL203 GW	LHSM	CX-SNAJ305
S	P-SUPPLY/PWB/FAN	D	0017 87-A40-454-090		DIODE,1N5393 GW 12.5	USM	CX-SNAJ300
S	P-SUPPLY/PWB/FAN	D	0017 87-A40-454-090		DIODE,1N5393 GW 12.5	EZSM	CX-NSZ300
S	P-SUPPLY/PWB/FAN	D	0017 87-A40-454-090	0E	DIODE,1N5393 GW 12.5	USM	CX-SNAJ300
S	P-SUPPLY/PWB/FAN	D	0017 87-A40-455-090		DIODE,RL203 GW	LHSM	CX-NSZ300
S	P-SUPPLY/PWB/FAN	D	0017 87-A40-455-090	0E	DIODE,RL203 GW	LHSM	CX-NSZ300
S	P-SUPPLY/PWB/FAN	D	0018 87-A40-454-090		DIODE,1N5393 GW 12.5	USM	CX-SNAJ300
S	P-SUPPLY/PWB/FAN	D	0018 87-A40-454-090		DIODE,1N5393 GW 12.5	EZSM	CX-NSZ300
S	P-SUPPLY/PWB/FAN	D	0018 87-A40-454-090	0E	DIODE,1N5393 GW 12.5	USM	CX-SNAJ300
S	P-SUPPLY/PWB/FAN	D	0018 87-A40-455-090		DIODE,RL203 GW	LHSM	CX-NSZ300
S	P-SUPPLY/PWB/FAN	D	0018 87-A40-455-090	0E	DIODE,RL203 GW	LHSM	CX-NSZ300
S	P-SUPPLY/PWB/FAN	D	0019 87-A40-454-090		DIODE,1N5393 GW 12.5	USM	CX-SNAJ300
S	P-SUPPLY/PWB/FAN	D	0019 87-A40-454-090		DIODE,1N5393 GW 12.5	EZSM	CX-NSZ300
S	P-SUPPLY/PWB/FAN	D	0019 87-A40-454-090	0E	DIODE,1N5393 GW 12.5	USM	CX-SNAJ300
S	P-SUPPLY/PWB/FAN	D	0019 87-A40-455-090		DIODE,RL203 GW	LHSM	CX-NSZ300
S	P-SUPPLY/PWB/FAN	D	0019 87-A40-455-090	0E	DIODE,RL203 GW	LHSM	CX-NSZ300
S	P-SUPPLY/PWB/FAN	D	0020 87-A40-454-090		DIODE,1N5393 GW 12.5	USM	CX-SNAJ300
S	P-SUPPLY/PWB/FAN	D	0020 87-A40-454-090		DIODE,1N5393 GW 12.5	EZSM	CX-NSZ300

PARTS LIST

! = Δ SAFTY PARTS
 C = Components marked

All components used on this model at the production line are shown in this service manual.

However, please note that not all components will be available as spare parts for after-sales service.

Components marked S and O are designated as spare parts for service and will be stocked at the spare parts centers.

Components marked X and R are not designated as spare parts for after sales service, and will not be stocked at the spare parts centers.

K NO. = Only use japanese.

! C	UNIT NAME	REF NO.	PARTS CODE	K NO.	DESCRIPTION	SUFFIX	MODEL NAME
S	P-SUPPLY/PWB/FAN	D 0020	87-A40-454-090	0E	DIODE,1N5393 GW 12.5	USM	CX-SNAJ300
S	P-SUPPLY/PWB/FAN	D 0020	87-A40-455-090		DIODE,RL203 GW	LHSM	CX-NSZ300
S	P-SUPPLY/PWB/FAN	D 0020	87-A40-455-090	0E	DIODE,RL203 GW	LHSM	CX-NSZ300
S	P-SUPPLY/PWB/FAN	D 0025	87-A40-553-080		DIODE,1N4003 LES	LHSM	CX-NSZ300
S	P-SUPPLY/PWB/FAN	D 0025	87-A40-553-080		DIODE,1N4003 LES	USM	CX-SNAJ300
S	P-SUPPLY/PWB/FAN	D 0025	87-A40-553-080		DIODE,1N4003 LES	USM	CX-SNAJ305
S	P-SUPPLY/PWB/FAN	D 0025	87-A40-553-080		DIODE,1N4003 LES	EZSM	CX-NSZ300
S	P-SUPPLY/PWB/FAN	D 0025	87-A40-553-080	0E	DIODE,1N4003 LES	LHSM	CX-NSZ300
S	P-SUPPLY/PWB/FAN	D 0025	87-A40-553-080	0E	DIODE,1N4003 LES	USM	CX-SNAJ300
S	P-SUPPLY/PWB/FAN	D 0025	87-A40-553-080	0E	DIODE,1N4003 LES	USM	CX-SNAJ305
S	P-SUPPLY/PWB/FAN	D 0026	87-A40-553-080		DIODE,1N4003 LES	LHSM	CX-NSZ300
S	P-SUPPLY/PWB/FAN	D 0026	87-A40-553-080		DIODE,1N4003 LES	USM	CX-SNAJ300
S	P-SUPPLY/PWB/FAN	D 0026	87-A40-553-080		DIODE,1N4003 LES	USM	CX-SNAJ305
S	P-SUPPLY/PWB/FAN	D 0026	87-A40-553-080		DIODE,1N4003 LES	EZSM	CX-NSZ300
S	P-SUPPLY/PWB/FAN	D 0026	87-A40-553-080	0E	DIODE,1N4003 LES	LHSM	CX-NSZ300
S	P-SUPPLY/PWB/FAN	D 0026	87-A40-553-080	0E	DIODE,1N4003 LES	USM	CX-SNAJ300
S	P-SUPPLY/PWB/FAN	D 0026	87-A40-553-080	0E	DIODE,1N4003 LES	USM	CX-SNAJ305
S	P-SUPPLY/PWB/FAN	D 0027	87-A40-553-080		DIODE,1N4003 LES	LHSM	CX-NSZ300
S	P-SUPPLY/PWB/FAN	D 0027	87-A40-553-080		DIODE,1N4003 LES	USM	CX-SNAJ300
S	P-SUPPLY/PWB/FAN	D 0027	87-A40-553-080		DIODE,1N4003 LES	USM	CX-SNAJ305
S	P-SUPPLY/PWB/FAN	D 0027	87-A40-553-080		DIODE,1N4003 LES	EZSM	CX-NSZ300
S	P-SUPPLY/PWB/FAN	D 0027	87-A40-553-080	0E	DIODE,1N4003 LES	LHSM	CX-NSZ300
S	P-SUPPLY/PWB/FAN	D 0027	87-A40-553-080	0E	DIODE,1N4003 LES	USM	CX-SNAJ300
S	P-SUPPLY/PWB/FAN	D 0027	87-A40-553-080	0E	DIODE,1N4003 LES	USM	CX-SNAJ305
S	P-SUPPLY/PWB/FAN	D 0028	87-A40-553-080		DIODE,1N4003 LES	LHSM	CX-NSZ300
S	P-SUPPLY/PWB/FAN	D 0028	87-A40-553-080		DIODE,1N4003 LES	USM	CX-SNAJ300
S	P-SUPPLY/PWB/FAN	D 0028	87-A40-553-080		DIODE,1N4003 LES	USM	CX-SNAJ305
S	P-SUPPLY/PWB/FAN	D 0028	87-A40-553-080		DIODE,1N4003 LES	EZSM	CX-NSZ300
S	P-SUPPLY/PWB/FAN	D 0028	87-A40-553-080	0E	DIODE,1N4003 LES	LHSM	CX-NSZ300
S	P-SUPPLY/PWB/FAN	D 0028	87-A40-553-080	0E	DIODE,1N4003 LES	USM	CX-SNAJ300
S	P-SUPPLY/PWB/FAN	D 0028	87-A40-553-080	0E	DIODE,1N4003 LES	USM	CX-SNAJ305
S	P-SUPPLY/PWB/FAN	D 0029	87-A40-776-080		ZENER,UZ27BSD	LHSM	CX-NSZ300
S	P-SUPPLY/PWB/FAN	D 0029	87-A40-776-080		ZENER,UZ27BSD	USM	CX-SNAJ300
S	P-SUPPLY/PWB/FAN	D 0029	87-A40-776-080		ZENER,UZ27BSD	USM	CX-SNAJ305
S	P-SUPPLY/PWB/FAN	D 0029	87-A40-776-080		ZENER,UZ27BSD	EZSM	CX-NSZ300
S	P-SUPPLY/PWB/FAN	D 0029	87-A40-776-080	0E	ZENER,UZ27BSD	LHSM	CX-NSZ300
S	P-SUPPLY/PWB/FAN	D 0029	87-A40-776-080	0E	ZENER,UZ27BSD	USM	CX-SNAJ300
S	P-SUPPLY/PWB/FAN	D 0029	87-A40-776-080	0E	ZENER,UZ27BSD	USM	CX-SNAJ305
S	P-SUPPLY/PWB/FAN	D 0030	87-A40-291-080		DIODE,1N4148M (CPT)	LHSM	CX-NSZ300
S	P-SUPPLY/PWB/FAN	D 0030	87-A40-291-080		DIODE,1N4148M (CPT)	USM	CX-SNAJ300
S	P-SUPPLY/PWB/FAN	D 0030	87-A40-291-080		DIODE,1N4148M (CPT)	USM	CX-SNAJ305
S	P-SUPPLY/PWB/FAN	D 0030	87-A40-291-080	0E	DIODE,1N4148M (CPT)	LHSM	CX-NSZ300
S	P-SUPPLY/PWB/FAN	D 0030	87-A40-291-080	0E	DIODE,1N4148M (CPT)	USM	CX-SNAJ300
S	P-SUPPLY/PWB/FAN	D 0031	87-A40-764-080		ZENER,UZ10BSC	LHSM	CX-NSZ300
S	P-SUPPLY/PWB/FAN	D 0031	87-A40-764-080		ZENER,UZ10BSC	USM	CX-SNAJ300
S	P-SUPPLY/PWB/FAN	D 0031	87-A40-764-080		ZENER,UZ10BSC	USM	CX-SNAJ305
S	P-SUPPLY/PWB/FAN	D 0031	87-A40-764-080		ZENER,UZ10BSC	EZSM	CX-NSZ300
S	P-SUPPLY/PWB/FAN	D 0031	87-A40-764-080	0E	ZENER,UZ10BSC	LHSM	CX-NSZ300
S	P-SUPPLY/PWB/FAN	D 0031	87-A40-764-080	0E	ZENER,UZ10BSC	USM	CX-SNAJ300
S	P-SUPPLY/PWB/FAN	D 0031	87-A40-764-080	0E	ZENER,UZ10BSC	USM	CX-SNAJ305
S	P-SUPPLY/PWB/FAN	D 0033	87-A40-553-080		DIODE,1N4003 LES	LHSM	CX-NSZ300
S	P-SUPPLY/PWB/FAN	D 0033	87-A40-553-080		DIODE,1N4003 LES	USM	CX-SNAJ300
S	P-SUPPLY/PWB/FAN	D 0033	87-A40-553-080		DIODE,1N4003 LES	USM	CX-SNAJ305
S	P-SUPPLY/PWB/FAN	D 0033	87-A40-553-080		DIODE,1N4003 LES	EZSM	CX-NSZ300
S	P-SUPPLY/PWB/FAN	D 0033	87-A40-553-080	0E	DIODE,1N4003 LES	LHSM	CX-NSZ300
S	P-SUPPLY/PWB/FAN	D 0033	87-A40-553-080	0E	DIODE,1N4003 LES	USM	CX-SNAJ300
S	P-SUPPLY/PWB/FAN	D 0033	87-A40-553-080	0E	DIODE,1N4003 LES	USM	CX-SNAJ305
S	P-SUPPLY/PWB/FAN	D 0034	87-A40-291-080		DIODE,1N4148M (CPT)	EZSM	CX-NSZ300
S	P-SUPPLY/PWB/FAN	D 0034	87-A40-291-080	0E	DIODE,1N4148M (CPT)	LHSM	CX-SNAJ300
S	P-SUPPLY/PWB/FAN	D 0034	87-A40-291-080	0E	DIODE,1N4148M (CPT)	USM	CX-SNAJ305
S	P-SUPPLY/PWB/FAN	D 0034	87-A40-313-080		C-DIODE,MC2840	LHSM	CX-NSZ300
S	P-SUPPLY/PWB/FAN	D 0034	87-A40-313-080		C-DIODE,MC2840	USM	CX-SNAJ300
S	P-SUPPLY/PWB/FAN	D 0034	87-A40-313-080		C-DIODE,MC2840	USM	CX-SNAJ305
S	P-SUPPLY/PWB/FAN	D 0035	87-A40-291-080		DIODE,1N4148M (CPT)	EZSM	CX-NSZ300
S	P-SUPPLY/PWB/FAN	D 0035	87-A40-291-080	0E	DIODE,1N4148M (CPT)	LHSM	CX-NSZ300
S	P-SUPPLY/PWB/FAN	D 0035	87-A40-291-080	0E	DIODE,1N4148M (CPT)	USM	CX-SNAJ300
S	P-SUPPLY/PWB/FAN	D 0035	87-A40-291-080	0E	DIODE,1N4148M (CPT)	USM	CX-SNAJ305

PARTS LIST

! = Δ SAFTY PARTS
 C = Components marked

All components used on this model at the production line are shown in this service manual.

However, please note that not all components will be available as spare parts for after-sales service.

Components marked S and O are designated as spare parts for service and will be stocked at the spare parts centers.

Components marked X and R are not designated as spare parts for after sales service, and will not be stocked at the spare parts centers.

K NO. = Only use japanese.

! C	UNIT NAME	REF NO.	PARTS CODE	K NO.	DESCRIPTION	SUFFIX	MODEL NAME	
S	P-SUPPLY/PWB/FAN	D	0041	87-A40-270-080		C-DIODE,MC2838	LHSM	CX-NSZ300
S	P-SUPPLY/PWB/FAN	D	0041	87-A40-270-080		C-DIODE,MC2838	USM	CX-SNAJ300
S	P-SUPPLY/PWB/FAN	D	0041	87-A40-270-080		C-DIODE,MC2838	USM	CX-SNAJ305
S	P-SUPPLY/PWB/FAN	D	0041	87-A40-270-080		C-DIODE,MC2838	EZSM	CX-NSZ300
S	P-SUPPLY/PWB/FAN	D	0041	87-A40-270-080	OE	C-DIODE,MC2838	LHSM	CX-NSZ300
S	P-SUPPLY/PWB/FAN	D	0041	87-A40-270-080	OE	C-DIODE,MC2838	USM	CX-SNAJ300
S	P-SUPPLY/PWB/FAN	D	0041	87-A40-270-080	OE	C-DIODE,MC2838	USM	CX-SNAJ305
S	P-SUPPLY/PWB/FAN	D	0042	87-A40-269-080		C-DIODE,MC2836	LHSM	CX-NSZ300
S	P-SUPPLY/PWB/FAN	D	0042	87-A40-269-080		C-DIODE,MC2836	USM	CX-SNAJ300
S	P-SUPPLY/PWB/FAN	D	0042	87-A40-269-080		C-DIODE,MC2836	USM	CX-SNAJ305
S	P-SUPPLY/PWB/FAN	D	0042	87-A40-269-080	OE	C-DIODE,MC2836	LHSM	CX-NSZ300
S	P-SUPPLY/PWB/FAN	D	0042	87-A40-269-080	OE	C-DIODE,MC2836	USM	CX-SNAJ300
S	P-SUPPLY/PWB/FAN	D	0042	87-A40-269-080	OE	C-DIODE,MC2836	USM	CX-SNAJ305
S	P-SUPPLY/PWB/FAN	D	0060	87-A40-291-080		DIODE,1N4148M (CPT)	LHSM	CX-NSZ300
S	P-SUPPLY/PWB/FAN	D	0060	87-A40-291-080		DIODE,1N4148M (CPT)	USM	CX-SNAJ300
S	P-SUPPLY/PWB/FAN	D	0060	87-A40-291-080		DIODE,1N4148M (CPT)	USM	CX-SNAJ305
S	P-SUPPLY/PWB/FAN	D	0060	87-A40-291-080		DIODE,1N4148M (CPT)	EZSM	CX-NSZ300
S	P-SUPPLY/PWB/FAN	D	0060	87-A40-291-080	OE	DIODE,1N4148M (CPT)	LHSM	CX-NSZ300
S	P-SUPPLY/PWB/FAN	D	0060	87-A40-291-080	OE	DIODE,1N4148M (CPT)	USM	CX-SNAJ300
S	P-SUPPLY/PWB/FAN	D	0060	87-A40-291-080	OE	DIODE,1N4148M (CPT)	USM	CX-SNAJ305
S	P-SUPPLY/PWB/FAN	D	0062	87-A40-270-080		C-DIODE,MC2838	LHSM	CX-NSZ300
S	P-SUPPLY/PWB/FAN	D	0062	87-A40-270-080		C-DIODE,MC2838	USM	CX-SNAJ300
S	P-SUPPLY/PWB/FAN	D	0062	87-A40-270-080		C-DIODE,MC2838	USM	CX-SNAJ305
S	P-SUPPLY/PWB/FAN	D	0062	87-A40-270-080		C-DIODE,MC2838	EZSM	CX-NSZ300
S	P-SUPPLY/PWB/FAN	D	0062	87-A40-270-080	OE	C-DIODE,MC2838	LHSM	CX-NSZ300
S	P-SUPPLY/PWB/FAN	D	0062	87-A40-270-080	OE	C-DIODE,MC2838	USM	CX-SNAJ300
S	P-SUPPLY/PWB/FAN	D	0062	87-A40-270-080	OE	C-DIODE,MC2838	USM	CX-SNAJ305
S	P-SUPPLY/PWB/FAN	D	0063	87-A40-270-080		C-DIODE,MC2838	LHSM	CX-NSZ300
S	P-SUPPLY/PWB/FAN	D	0063	87-A40-270-080		C-DIODE,MC2838	USM	CX-SNAJ300
S	P-SUPPLY/PWB/FAN	D	0063	87-A40-270-080		C-DIODE,MC2838	USM	CX-SNAJ305
S	P-SUPPLY/PWB/FAN	D	0063	87-A40-270-080	OE	C-DIODE,MC2838	LHSM	CX-NSZ300
S	P-SUPPLY/PWB/FAN	D	0063	87-A40-270-080	OE	C-DIODE,MC2838	USM	CX-SNAJ300
S	P-SUPPLY/PWB/FAN	D	0063	87-A40-270-080	OE	C-DIODE,MC2838	USM	CX-SNAJ305
S	P-SUPPLY/PWB/FAN	D	0064	87-A40-269-080		C-DIODE,MC2836	LHSM	CX-NSZ300
S	P-SUPPLY/PWB/FAN	D	0064	87-A40-269-080		C-DIODE,MC2836	USM	CX-SNAJ300
S	P-SUPPLY/PWB/FAN	D	0064	87-A40-269-080		C-DIODE,MC2836	USM	CX-SNAJ305
S	P-SUPPLY/PWB/FAN	D	0064	87-A40-269-080		C-DIODE,MC2836	EZSM	CX-NSZ300
S	P-SUPPLY/PWB/FAN	D	0064	87-A40-269-080	OE	C-DIODE,MC2836	LHSM	CX-NSZ300
S	P-SUPPLY/PWB/FAN	D	0064	87-A40-269-080	OE	C-DIODE,MC2836	USM	CX-SNAJ300
S	P-SUPPLY/PWB/FAN	D	0064	87-A40-269-080	OE	C-DIODE,MC2836	USM	CX-SNAJ305
S	P-SUPPLY/PWB/FAN	D	0071	87-A40-269-080		C-DIODE,MC2836	LHSM	CX-NSZ300
S	P-SUPPLY/PWB/FAN	D	0071	87-A40-269-080		C-DIODE,MC2836	USM	CX-SNAJ300
S	P-SUPPLY/PWB/FAN	D	0071	87-A40-269-080		C-DIODE,MC2836	USM	CX-SNAJ305
S	P-SUPPLY/PWB/FAN	D	0071	87-A40-269-080	OE	C-DIODE,MC2836	LHSM	CX-NSZ300
S	P-SUPPLY/PWB/FAN	D	0071	87-A40-269-080	OE	C-DIODE,MC2836	USM	CX-SNAJ300
S	P-SUPPLY/PWB/FAN	D	0071	87-A40-269-080	OE	C-DIODE,MC2836	USM	CX-SNAJ305
S	P-SUPPLY/PWB/FAN	D	0072	87-A40-270-080		C-DIODE,MC2838	LHSM	CX-NSZ300
S	P-SUPPLY/PWB/FAN	D	0072	87-A40-270-080		C-DIODE,MC2838	USM	CX-SNAJ300
S	P-SUPPLY/PWB/FAN	D	0072	87-A40-270-080		C-DIODE,MC2838	USM	CX-SNAJ305
S	P-SUPPLY/PWB/FAN	D	0072	87-A40-270-080		C-DIODE,MC2838	EZSM	CX-NSZ300
S	P-SUPPLY/PWB/FAN	D	0072	87-A40-270-080	OE	C-DIODE,MC2838	LHSM	CX-NSZ300
S	P-SUPPLY/PWB/FAN	D	0072	87-A40-270-080	OE	C-DIODE,MC2838	USM	CX-SNAJ300
S	P-SUPPLY/PWB/FAN	D	0072	87-A40-270-080	OE	C-DIODE,MC2838	USM	CX-SNAJ305
S	P-SUPPLY/PWB/FAN	D	0076	87-A40-269-080		C-DIODE,MC2836	LHSM	CX-NSZ300
S	P-SUPPLY/PWB/FAN	D	0076	87-A40-269-080		C-DIODE,MC2836	USM	CX-SNAJ300
S	P-SUPPLY/PWB/FAN	D	0076	87-A40-269-080		C-DIODE,MC2836	USM	CX-SNAJ305
S	P-SUPPLY/PWB/FAN	D	0076	87-A40-269-080		C-DIODE,MC2836	USM	CX-SNAJ300
S	P-SUPPLY/PWB/FAN	D	0076	87-A40-269-080		C-DIODE,MC2836	EZSM	CX-NSZ300
S	P-SUPPLY/PWB/FAN	D	0076	87-A40-269-080	OE	C-DIODE,MC2836	LHSM	CX-NSZ300
S	P-SUPPLY/PWB/FAN	D	0076	87-A40-269-080	OE	C-DIODE,MC2836	USM	CX-SNAJ300
S	P-SUPPLY/PWB/FAN	D	0076	87-A40-269-080	OE	C-DIODE,MC2836	USM	CX-SNAJ305

PARTS LIST

! = Δ SAFTY PARTS
 C = Components marked

All components used on this model at the production line are shown in this service manual.

However, please note that not all components will be available as spare parts for after-sales service.

Components marked S and O are designated as spare parts for service and will be stocked at the spare parts centers.

Components marked X and R are not designated as spare parts for after sales service, and will not be stocked at the spare parts centers.

K NO. = Only use japanese.

! C	UNIT NAME	REF NO.	PARTS CODE	K NO.	DESCRIPTION	SUFFIX	MODEL NAME
S	P-SUPPLY/PWB/FAN	D 0077	87-A40-270-080		C-DIODE,MC2838	LHSM	CX-NSZ300
S	P-SUPPLY/PWB/FAN	D 0077	87-A40-270-080		C-DIODE,MC2838	USM	CX-SNAJ300
S	P-SUPPLY/PWB/FAN	D 0077	87-A40-270-080		C-DIODE,MC2838	USM	CX-SNAJ305
S	P-SUPPLY/PWB/FAN	D 0077	87-A40-270-080		C-DIODE,MC2838	EZSM	CX-NSZ300
S	P-SUPPLY/PWB/FAN	D 0077	87-A40-270-080	OE	C-DIODE,MC2838	LHSM	CX-NSZ300
S	P-SUPPLY/PWB/FAN	D 0077	87-A40-270-080	OE	C-DIODE,MC2838	USM	CX-SNAJ300
S	P-SUPPLY/PWB/FAN	D 0077	87-A40-270-080	OE	C-DIODE,MC2838	USM	CX-SNAJ305
X	P-SUPPLY/PWB/FAN	JR 0001	88-108-000-080		C-JUMPER,U	LHSM	CX-NSZ300
X	P-SUPPLY/PWB/FAN	JR 0001	88-108-000-080		C-JUMPER,U	USM	CX-SNAJ300
X	P-SUPPLY/PWB/FAN	JR 0001	88-108-000-080		C-JUMPER,U	USM	CX-SNAJ305
X	P-SUPPLY/PWB/FAN	JR 0001	88-108-000-080	OE	C-JUMPER,U	LHSM	CX-NSZ300
X	P-SUPPLY/PWB/FAN	JR 0001	88-108-000-080	OE	C-JUMPER,U	USM	CX-SNAJ300
X	P-SUPPLY/PWB/FAN	JR 0001	88-108-000-080	OE	C-JUMPER,U	USM	CX-SNAJ305
X	P-SUPPLY/PWB/FAN	JR 0003	88-108-000-080		C-JUMPER,U	LHSM	CX-NSZ300
X	P-SUPPLY/PWB/FAN	JR 0003	88-108-000-080		C-JUMPER,U	USM	CX-SNAJ300
X	P-SUPPLY/PWB/FAN	JR 0003	88-108-000-080		C-JUMPER,U	USM	CX-SNAJ305
X	P-SUPPLY/PWB/FAN	JR 0003	88-108-000-080	OE	C-JUMPER,U	LHSM	CX-NSZ300
X	P-SUPPLY/PWB/FAN	JR 0003	88-108-000-080	OE	C-JUMPER,U	USM	CX-SNAJ300
X	P-SUPPLY/PWB/FAN	JR 0003	88-108-000-080	OE	C-JUMPER,U	USM	CX-SNAJ305
X	P-SUPPLY/PWB/FAN	JR 0004	88-108-000-080		C-JUMPER,U	LHSM	CX-NSZ300
X	P-SUPPLY/PWB/FAN	JR 0004	88-108-000-080		C-JUMPER,U	USM	CX-SNAJ300
X	P-SUPPLY/PWB/FAN	JR 0004	88-108-000-080		C-JUMPER,U	USM	CX-SNAJ305
X	P-SUPPLY/PWB/FAN	JR 0004	88-108-000-080	OE	C-JUMPER,U	LHSM	CX-NSZ300
X	P-SUPPLY/PWB/FAN	JR 0004	88-108-000-080	OE	C-JUMPER,U	USM	CX-SNAJ300
X	P-SUPPLY/PWB/FAN	JR 0004	88-108-000-080	OE	C-JUMPER,U	USM	CX-SNAJ305
X	P-SUPPLY/PWB/FAN	JR 0005	88-108-000-080		C-JUMPER,U	LHSM	CX-NSZ300
X	P-SUPPLY/PWB/FAN	JR 0005	88-108-000-080		C-JUMPER,U	USM	CX-SNAJ300
X	P-SUPPLY/PWB/FAN	JR 0005	88-108-000-080		C-JUMPER,U	USM	CX-SNAJ305
X	P-SUPPLY/PWB/FAN	JR 0005	88-108-000-080	OE	C-JUMPER,U	LHSM	CX-NSZ300
X	P-SUPPLY/PWB/FAN	JR 0005	88-108-000-080	OE	C-JUMPER,U	USM	CX-SNAJ300
X	P-SUPPLY/PWB/FAN	JR 0005	88-108-000-080	OE	C-JUMPER,U	USM	CX-SNAJ305
X	P-SUPPLY/PWB/FAN	JR 0006	88-129-000-080		C-JUMPER,3216	LHSM	CX-NSZ300
X	P-SUPPLY/PWB/FAN	JR 0006	88-129-000-080		C-JUMPER,3216	USM	CX-SNAJ300
X	P-SUPPLY/PWB/FAN	JR 0006	88-129-000-080		C-JUMPER,3216	USM	CX-SNAJ305
X	P-SUPPLY/PWB/FAN	JR 0006	88-129-000-080	OE	C-JUMPER,3216	EZSM	CX-NSZ300
X	P-SUPPLY/PWB/FAN	JR 0006	88-129-000-080	OE	C-JUMPER,3216	LHSM	CX-NSZ300
X	P-SUPPLY/PWB/FAN	JR 0006	88-129-000-080	OE	C-JUMPER,3216	USM	CX-SNAJ300
X	P-SUPPLY/PWB/FAN	JR 0006	88-129-000-080	OE	C-JUMPER,3216	USM	CX-SNAJ305
X	P-SUPPLY/PWB/FAN	JR 0023	88-128-560-080		C-RES, 56-1/8W J	USM	CX-SNAJ305
X	P-SUPPLY/PWB/FAN	JR 0023	88-128-560-080		C-RES, 56-1/8W J	USM	CX-SNAJ300
X	P-SUPPLY/PWB/FAN	JR 0023	88-128-560-080	OE	C-RES, 56-1/8W J	USM	CX-SNAJ305
X	P-SUPPLY/PWB/FAN	JR 0023	88-128-680-080		C-RES, 68-1/8W J	LHSM	CX-NSZ300
X	P-SUPPLY/PWB/FAN	JR 0023	88-128-680-080		C-RES, 68-1/8W J	EZSM	CX-NSZ300
X	P-SUPPLY/PWB/FAN	JR 0023	88-128-820-080	OE	C-RES, 82-1/8W J	LHSM	CX-NSZ300
X	P-SUPPLY/PWB/FAN	JR 0023	88-129-000-080		C-JUMPER,3216	USM	CX-SNAJ300
X	P-SUPPLY/PWB/FAN	JR 0024	88-128-560-080		C-RES, 56-1/8W J	USM	CX-SNAJ305
X	P-SUPPLY/PWB/FAN	JR 0024	88-128-560-080	OE	C-RES, 56-1/8W J	USM	CX-SNAJ305
X	P-SUPPLY/PWB/FAN	JR 0024	88-128-680-080		C-RES, 68-1/8W J	LHSM	CX-NSZ300
X	P-SUPPLY/PWB/FAN	JR 0024	88-128-680-080		C-RES, 68-1/8W J	EZSM	CX-NSZ300
X	P-SUPPLY/PWB/FAN	JR 0024	88-128-820-080	OE	C-RES, 82-1/8W J	LHSM	CX-NSZ300
X	P-SUPPLY/PWB/FAN	JR 0024	88-129-000-080		C-JUMPER,3216	USM	CX-SNAJ300
S	P-SUPPLY/PWB/FAN	Q 0001	87-A30-494-080		TR,2SA1980G	LHSM	CX-NSZ300
S	P-SUPPLY/PWB/FAN	Q 0001	87-A30-494-080		TR,2SA1980G	USM	CX-SNAJ300
S	P-SUPPLY/PWB/FAN	Q 0001	87-A30-494-080		TR,2SA1980G	USM	CX-SNAJ305
S	P-SUPPLY/PWB/FAN	Q 0001	87-A30-494-080		TR,2SA1980G	EZSM	CX-NSZ300
S	P-SUPPLY/PWB/FAN	Q 0001	87-A30-494-080	OE	TR,2SA1980G	LHSM	CX-NSZ300
S	P-SUPPLY/PWB/FAN	Q 0001	87-A30-494-080	OE	TR,2SA1980G	USM	CX-SNAJ300
S	P-SUPPLY/PWB/FAN	Q 0001	87-A30-494-080	OE	TR,2SA1980G	USM	CX-SNAJ305
S	P-SUPPLY/PWB/FAN	Q 0002	87-A30-494-080		TR,2SA1980G	LHSM	CX-NSZ300
S	P-SUPPLY/PWB/FAN	Q 0002	87-A30-494-080		TR,2SA1980G	USM	CX-SNAJ300
S	P-SUPPLY/PWB/FAN	Q 0002	87-A30-494-080		TR,2SA1980G	USM	CX-SNAJ305
S	P-SUPPLY/PWB/FAN	Q 0002	87-A30-494-080		TR,2SA1980G	EZSM	CX-NSZ300
S	P-SUPPLY/PWB/FAN	Q 0002	87-A30-494-080	OE	TR,2SA1980G	LHSM	CX-NSZ300
S	P-SUPPLY/PWB/FAN	Q 0002	87-A30-494-080	OE	TR,2SA1980G	USM	CX-SNAJ300
S	P-SUPPLY/PWB/FAN	Q 0002	87-A30-494-080	OE	TR,2SA1980G	USM	CX-SNAJ305

PARTS LIST

! = Δ SAFTY PARTS
 C = Components marked

All components used on this model at the production line are shown in this service manual.

However, please note that not all components will be available as spare parts for after-sales service.

Components marked S and O are designated as spare parts for service and will be stocked at the spare parts centers.

Components marked X and R are not designated as spare parts for after sales service, and will not be stocked at the spare parts centers.

K NO. = Only use japanese.

! C	UNIT NAME	REF NO.	PARTS CODE	K NO.	DESCRIPTION	SUFFIX	MODEL NAME
S	P-SUPPLY/PWB/FAN	Q	0003	87-A30-559-010	TR,CSB1370EF	LHSM	CX-NSZ300
S	P-SUPPLY/PWB/FAN	Q	0003	87-A30-559-010	TR,CSB1370EF	USM	CX-SNAJ300
S	P-SUPPLY/PWB/FAN	Q	0003	87-A30-559-010	TR,CSB1370EF	USM	CX-SNAJ305
S	P-SUPPLY/PWB/FAN	Q	0003	87-A30-559-010	TR,CSB1370EF	EZSM	CX-NSZ300
S	P-SUPPLY/PWB/FAN	Q	0003	87-A30-559-010	1A TR,CSB1370EF	LHSM	CX-NSZ300
S	P-SUPPLY/PWB/FAN	Q	0003	87-A30-559-010	1A TR,CSB1370EF	USM	CX-SNAJ300
S	P-SUPPLY/PWB/FAN	Q	0003	87-A30-559-010	1A TR,CSB1370EF	USM	CX-SNAJ305
S	P-SUPPLY/PWB/FAN	Q	0005	87-026-610-080	TR,KTC3198GR	EZSM	CX-NSZ300
S	P-SUPPLY/PWB/FAN	Q	0005	87-026-610-080	OE TR,KTC3198GR	LHSM	CX-NSZ300
S	P-SUPPLY/PWB/FAN	Q	0005	87-026-610-080	OE TR,KTC3198GR	USM	CX-SNAJ300
S	P-SUPPLY/PWB/FAN	Q	0005	87-026-610-080	OE TR,KTC3198GR	USM	CX-SNAJ305
S	P-SUPPLY/PWB/FAN	Q	0005	87-A30-492-080	TR,2SC5343G	LHSM	CX-NSZ300
S	P-SUPPLY/PWB/FAN	Q	0005	87-A30-492-080	TR,2SC5343G	USM	CX-SNAJ300
S	P-SUPPLY/PWB/FAN	Q	0005	87-A30-492-080	TR,2SC5343G	USM	CX-SNAJ305
S	P-SUPPLY/PWB/FAN	Q	0006	87-A30-076-080	C-TR,2SC3052F	LHSM	CX-NSZ300
S	P-SUPPLY/PWB/FAN	Q	0006	87-A30-076-080	C-TR,2SC3052F	USM	CX-SNAJ300
S	P-SUPPLY/PWB/FAN	Q	0006	87-A30-076-080	C-TR,2SC3052F	USM	CX-SNAJ305
S	P-SUPPLY/PWB/FAN	Q	0006	87-A30-076-080	C-TR,2SC3052F	EZSM	CX-NSZ300
S	P-SUPPLY/PWB/FAN	Q	0006	87-A30-076-080	OE C-TR,2SC3052F	LHSM	CX-NSZ300
S	P-SUPPLY/PWB/FAN	Q	0006	87-A30-076-080	OE C-TR,2SC3052F	USM	CX-SNAJ300
S	P-SUPPLY/PWB/FAN	Q	0006	87-A30-076-080	OE C-TR,2SC3052F	USM	CX-SNAJ305
S	P-SUPPLY/PWB/FAN	Q	0007	87-A30-075-080	C-TR,2SA1235F	USM	CX-SNAJ300
S	P-SUPPLY/PWB/FAN	Q	0007	87-A30-075-080	C-TR,2SA1235F	USM	CX-SNAJ305
S	P-SUPPLY/PWB/FAN	Q	0007	87-A30-075-080	C-TR,2SA1235F	USM	CX-SNAJ300
S	P-SUPPLY/PWB/FAN	Q	0007	87-A30-075-080	OE C-TR,2SA1235F	USM	CX-SNAJ305
S	P-SUPPLY/PWB/FAN	Q	0007	87-A30-075-080	OE C-TR,2SA1235F	USM	CX-SNAJ300
S	P-SUPPLY/PWB/FAN	Q	0008	87-A30-075-080	C-TR,2SA1235F	LHSM	CX-NSZ300
S	P-SUPPLY/PWB/FAN	Q	0008	87-A30-075-080	C-TR,2SA1235F	USM	CX-SNAJ300
S	P-SUPPLY/PWB/FAN	Q	0008	87-A30-075-080	C-TR,2SA1235F	USM	CX-SNAJ305
S	P-SUPPLY/PWB/FAN	Q	0008	87-A30-075-080	C-TR,2SA1235F	EZSM	CX-NSZ300
S	P-SUPPLY/PWB/FAN	Q	0008	87-A30-075-080	OE C-TR,2SA1235F	LHSM	CX-NSZ300
S	P-SUPPLY/PWB/FAN	Q	0008	87-A30-075-080	OE C-TR,2SA1235F	USM	CX-SNAJ300
S	P-SUPPLY/PWB/FAN	Q	0008	87-A30-075-080	OE C-TR,2SA1235F	USM	CX-SNAJ305
S	P-SUPPLY/PWB/FAN	Q	0009	87-A30-494-080	TR,2SA1980G	LHSM	CX-NSZ300
S	P-SUPPLY/PWB/FAN	Q	0009	87-A30-494-080	TR,2SA1980G	USM	CX-SNAJ300
S	P-SUPPLY/PWB/FAN	Q	0009	87-A30-494-080	TR,2SA1980G	USM	CX-SNAJ305
S	P-SUPPLY/PWB/FAN	Q	0009	87-A30-494-080	OE TR,2SA1980G	EZSM	CX-NSZ300
S	P-SUPPLY/PWB/FAN	Q	0009	87-A30-494-080	OE TR,2SA1980G	LHSM	CX-NSZ300
S	P-SUPPLY/PWB/FAN	Q	0009	87-A30-494-080	OE TR,2SA1980G	USM	CX-SNAJ300
S	P-SUPPLY/PWB/FAN	Q	0009	87-A30-494-080	OE TR,2SA1980G	USM	CX-SNAJ305
S	P-SUPPLY/PWB/FAN	Q	0010	87-A30-076-080	C-TR,2SC3052F	LHSM	CX-NSZ300
S	P-SUPPLY/PWB/FAN	Q	0010	87-A30-076-080	C-TR,2SC3052F	USM	CX-SNAJ300
S	P-SUPPLY/PWB/FAN	Q	0010	87-A30-076-080	C-TR,2SC3052F	USM	CX-SNAJ305
S	P-SUPPLY/PWB/FAN	Q	0010	87-A30-076-080	C-TR,2SC3052F	EZSM	CX-NSZ300
S	P-SUPPLY/PWB/FAN	Q	0010	87-A30-076-080	OE C-TR,2SC3052F	LHSM	CX-NSZ300
S	P-SUPPLY/PWB/FAN	Q	0010	87-A30-076-080	OE C-TR,2SC3052F	USM	CX-SNAJ300
S	P-SUPPLY/PWB/FAN	Q	0010	87-A30-076-080	OE C-TR,2SC3052F	USM	CX-SNAJ305
S	P-SUPPLY/PWB/FAN	Q	0059	87-A30-107-070	C-TR,CMBT5401	LHSM	CX-NSZ300
S	P-SUPPLY/PWB/FAN	Q	0059	87-A30-107-070	C-TR,CMBT5401	USM	CX-SNAJ300
S	P-SUPPLY/PWB/FAN	Q	0059	87-A30-107-070	OE C-TR,CMBT5401	USM	CX-SNAJ305
S	P-SUPPLY/PWB/FAN	Q	0060	87-A30-076-080	C-TR,2SC3052F	LHSM	CX-NSZ300
S	P-SUPPLY/PWB/FAN	Q	0060	87-A30-076-080	C-TR,2SC3052F	USM	CX-SNAJ300
S	P-SUPPLY/PWB/FAN	Q	0060	87-A30-076-080	C-TR,2SC3052F	USM	CX-SNAJ305
S	P-SUPPLY/PWB/FAN	Q	0060	87-A30-076-080	C-TR,2SC3052F	EZSM	CX-NSZ300
S	P-SUPPLY/PWB/FAN	Q	0060	87-A30-076-080	OE C-TR,2SC3052F	LHSM	CX-NSZ300
S	P-SUPPLY/PWB/FAN	Q	0060	87-A30-076-080	OE C-TR,2SC3052F	USM	CX-SNAJ300
S	P-SUPPLY/PWB/FAN	Q	0060	87-A30-076-080	OE C-TR,2SC3052F	USM	CX-SNAJ305
S	P-SUPPLY/PWB/FAN	Q	0061	87-A30-075-080	C-TR,2SA1235F	LHSM	CX-NSZ300
S	P-SUPPLY/PWB/FAN	Q	0061	87-A30-075-080	C-TR,2SA1235F	USM	CX-SNAJ300
S	P-SUPPLY/PWB/FAN	Q	0061	87-A30-075-080	C-TR,2SA1235F	USM	CX-SNAJ305
S	P-SUPPLY/PWB/FAN	Q	0061	87-A30-075-080	C-TR,2SA1235F	EZSM	CX-NSZ300
S	P-SUPPLY/PWB/FAN	Q	0061	87-A30-075-080	OE C-TR,2SA1235F	LHSM	CX-NSZ300
S	P-SUPPLY/PWB/FAN	Q	0061	87-A30-075-080	OE C-TR,2SA1235F	USM	CX-SNAJ300
S	P-SUPPLY/PWB/FAN	Q	0061	87-A30-075-080	OE C-TR,2SA1235F	USM	CX-SNAJ305
S	P-SUPPLY/PWB/FAN	Q	0062	87-A30-076-080	C-TR,2SC3052F	LHSM	CX-NSZ300
S	P-SUPPLY/PWB/FAN	Q	0062	87-A30-076-080	C-TR,2SC3052F	USM	CX-SNAJ300
S	P-SUPPLY/PWB/FAN	Q	0062	87-A30-076-080	C-TR,2SC3052F	USM	CX-SNAJ305

PARTS LIST

! = Δ SAFTY PARTS
 C = Components marked

All components used on this model at the production line are shown in this service manual.

However, please note that not all components will be available as spare parts for after-sales service.

Components marked S and O are designated as spare parts for service and will be stocked at the spare parts centers.

Components marked X and R are not designated as spare parts for after sales service, and will not be stocked at the spare parts centers.

K NO. = Only use japanese.

! C	UNIT NAME	REF NO.	PARTS CODE	K NO.	DESCRIPTION	SUFFIX	MODEL NAME
X	P-SUPPLY/PWB/FAN	R	0013	88-108-472-080		C-RES,U 4.7K-1/16W J	EZSM CX-NSZ300
X	P-SUPPLY/PWB/FAN	R	0013	88-108-472-080	OE	C-RES,U 4.7K-1/16W J	LHSM CX-NSZ300
X	P-SUPPLY/PWB/FAN	R	0013	88-108-472-080	OE	C-RES,U 4.7K-1/16W J	USM CX-SNAJ300
X	P-SUPPLY/PWB/FAN	R	0013	88-108-472-080	OE	C-RES,U 4.7K-1/16W J	USM CX-SNAJ305
X	P-SUPPLY/PWB/FAN	R	0014	88-118-100-080		C-RES,S 10-1/10W J	LHSM CX-NSZ300
X	P-SUPPLY/PWB/FAN	R	0014	88-118-100-080		C-RES,S 10-1/10W J	USM CX-SNAJ300
X	P-SUPPLY/PWB/FAN	R	0014	88-118-100-080		C-RES,S 10-1/10W J	USM CX-SNAJ305
X	P-SUPPLY/PWB/FAN	R	0014	88-118-100-080		C-RES,S 10-1/10W J	EZSM CX-NSZ300
X	P-SUPPLY/PWB/FAN	R	0014	88-118-100-080	OE	C-RES,S 10-1/10W J	LHSM CX-NSZ300
X	P-SUPPLY/PWB/FAN	R	0014	88-118-100-080	OE	C-RES,S 10-1/10W J	USM CX-SNAJ300
X	P-SUPPLY/PWB/FAN	R	0014	88-118-100-080	OE	C-RES,S 10-1/10W J	USM CX-SNAJ305
X	P-SUPPLY/PWB/FAN	R	0015	88-108-104-080		C-RES,U 100K-1/16W J	LHSM CX-NSZ300
X	P-SUPPLY/PWB/FAN	R	0015	88-108-104-080		C-RES,U 100K-1/16W J	USM CX-SNAJ300
X	P-SUPPLY/PWB/FAN	R	0015	88-108-104-080		C-RES,U 100K-1/16W J	USM CX-SNAJ305
X	P-SUPPLY/PWB/FAN	R	0015	88-108-104-080		C-RES,U 100K-1/16W J	EZSM CX-NSZ300
X	P-SUPPLY/PWB/FAN	R	0015	88-108-104-080	OE	C-RES,U 100K-1/16W J	LHSM CX-NSZ300
X	P-SUPPLY/PWB/FAN	R	0015	88-108-104-080	OE	C-RES,U 100K-1/16W J	USM CX-SNAJ300
X	P-SUPPLY/PWB/FAN	R	0015	88-108-104-080	OE	C-RES,U 100K-1/16W J	USM CX-SNAJ305
X	P-SUPPLY/PWB/FAN	R	0016	88-108-333-080		C-RES,U 33K-1/16W J	LHSM CX-NSZ300
X	P-SUPPLY/PWB/FAN	R	0016	88-108-333-080		C-RES,U 33K-1/16W J	USM CX-SNAJ300
X	P-SUPPLY/PWB/FAN	R	0016	88-108-333-080		C-RES,U 33K-1/16W J	USM CX-SNAJ305
X	P-SUPPLY/PWB/FAN	R	0016	88-108-333-080	OE	C-RES,U 33K-1/16W J	EZSM CX-NSZ300
X	P-SUPPLY/PWB/FAN	R	0016	88-108-333-080	OE	C-RES,U 33K-1/16W J	LHSM CX-NSZ300
X	P-SUPPLY/PWB/FAN	R	0016	88-108-333-080	OE	C-RES,U 33K-1/16W J	USM CX-SNAJ300
X	P-SUPPLY/PWB/FAN	R	0016	88-108-333-080	OE	C-RES,U 33K-1/16W J	USM CX-SNAJ305
X	P-SUPPLY/PWB/FAN	R	0017	88-100-000-010		PLATING-JW, 0.58 SN95	LHSM CX-NSZ300
X	P-SUPPLY/PWB/FAN	R	0017	88-100-000-010		PLATING-JW, 0.58 SN95	USM CX-SNAJ305
X	P-SUPPLY/PWB/FAN	R	0017	88-100-000-010		PLATING-JW, 0.58 SN95	EZSM CX-NSZ300
X	P-SUPPLY/PWB/FAN	R	0017	88-100-000-010	OE	PLATING-JW, 0.58 SN95	LHSM CX-NSZ300
X	P-SUPPLY/PWB/FAN	R	0017	88-100-000-010	OE	PLATING-JW, 0.58 SN95	USM CX-SNAJ300
X	P-SUPPLY/PWB/FAN	R	0017	88-100-000-010	OE	PLATING-JW, 0.58 SN95	USM CX-SNAJ305
X	P-SUPPLY/PWB/FAN	R	0017	88-130-151-080		RES,150-1/4W J	USM CX-SNAJ300
X	P-SUPPLY/PWB/FAN	R	0018	88-118-221-080		C-RES,S 220-1/10W J	LHSM CX-NSZ300
X	P-SUPPLY/PWB/FAN	R	0018	88-118-221-080		C-RES,S 220-1/10W J	USM CX-SNAJ300
X	P-SUPPLY/PWB/FAN	R	0018	88-118-221-080		C-RES,S 220-1/10W J	USM CX-SNAJ305
X	P-SUPPLY/PWB/FAN	R	0018	88-118-221-080		C-RES,S 220-1/10W J	EZSM CX-NSZ300
X	P-SUPPLY/PWB/FAN	R	0018	88-118-221-080	OE	C-RES,S 220-1/10W J	LHSM CX-NSZ300
X	P-SUPPLY/PWB/FAN	R	0018	88-118-221-080	OE	C-RES,S 220-1/10W J	USM CX-SNAJ300
X	P-SUPPLY/PWB/FAN	R	0018	88-118-221-080	OE	C-RES,S 220-1/10W J	USM CX-SNAJ305
X	P-SUPPLY/PWB/FAN	R	0019	88-108-000-080		C-JUMPER,U	LHSM CX-NSZ300
X	P-SUPPLY/PWB/FAN	R	0019	88-108-000-080		C-JUMPER,U	USM CX-SNAJ300
X	P-SUPPLY/PWB/FAN	R	0019	88-108-000-080		C-JUMPER,U	USM CX-SNAJ305
X	P-SUPPLY/PWB/FAN	R	0019	88-108-000-080		C-JUMPER,U	EZSM CX-NSZ300
X	P-SUPPLY/PWB/FAN	R	0019	88-108-000-080	OE	C-JUMPER,U	LHSM CX-NSZ300
X	P-SUPPLY/PWB/FAN	R	0019	88-108-000-080	OE	C-JUMPER,U	USM CX-SNAJ300
X	P-SUPPLY/PWB/FAN	R	0019	88-108-000-080	OE	C-JUMPER,U	USM CX-SNAJ305
X	P-SUPPLY/PWB/FAN	R	0020	88-121-680-080		RES,68-1/8W J	LHSM CX-NSZ300
X	P-SUPPLY/PWB/FAN	R	0020	88-121-680-080		RES,68-1/8W J	USM CX-SNAJ300
X	P-SUPPLY/PWB/FAN	R	0020	88-121-680-080		RES,68-1/8W J	USM CX-SNAJ305
X	P-SUPPLY/PWB/FAN	R	0020	88-121-680-080		RES,68-1/8W J	EZSM CX-NSZ300
X	P-SUPPLY/PWB/FAN	R	0020	88-121-680-080	OE	RES,68-1/8W J	LHSM CX-NSZ300
X	P-SUPPLY/PWB/FAN	R	0020	88-121-680-080	OE	RES,68-1/8W J	USM CX-SNAJ300
X	P-SUPPLY/PWB/FAN	R	0020	88-121-680-080	OE	RES,68-1/8W J	USM CX-SNAJ305
X	P-SUPPLY/PWB/FAN	R	0021	88-108-472-080		C-RES,U 4.7K-1/16W J	LHSM CX-NSZ300
X	P-SUPPLY/PWB/FAN	R	0021	88-108-472-080		C-RES,U 4.7K-1/16W J	USM CX-SNAJ300
X	P-SUPPLY/PWB/FAN	R	0021	88-108-472-080		C-RES,U 4.7K-1/16W J	USM CX-SNAJ305
X	P-SUPPLY/PWB/FAN	R	0021	88-108-472-080		C-RES,U 4.7K-1/16W J	EZSM CX-NSZ300
X	P-SUPPLY/PWB/FAN	R	0021	88-108-472-080	OE	C-RES,U 4.7K-1/16W J	LHSM CX-NSZ300
X	P-SUPPLY/PWB/FAN	R	0021	88-108-472-080	OE	C-RES,U 4.7K-1/16W J	USM CX-SNAJ300
X	P-SUPPLY/PWB/FAN	R	0021	88-108-472-080	OE	C-RES,U 4.7K-1/16W J	USM CX-SNAJ305
X	P-SUPPLY/PWB/FAN	R	0022	88-108-221-080		C-RES,U 220-1/16W J	LHSM CX-NSZ300
X	P-SUPPLY/PWB/FAN	R	0022	88-108-221-080		C-RES,U 220-1/16W J	USM CX-SNAJ300
X	P-SUPPLY/PWB/FAN	R	0022	88-108-221-080		C-RES,U 220-1/16W J	USM CX-SNAJ305
X	P-SUPPLY/PWB/FAN	R	0022	88-108-221-080		C-RES,U 220-1/16W J	EZSM CX-NSZ300
X	P-SUPPLY/PWB/FAN	R	0022	88-108-221-080	OE	C-RES,U 220-1/16W J	LHSM CX-NSZ300
X	P-SUPPLY/PWB/FAN	R	0022	88-108-221-080	OE	C-RES,U 220-1/16W J	USM CX-SNAJ300
X	P-SUPPLY/PWB/FAN	R	0022	88-108-221-080	OE	C-RES,U 220-1/16W J	USM CX-SNAJ305
X	P-SUPPLY/PWB/FAN	R	0023	88-108-103-080		C-RES,U 10K-1/16W J	LHSM CX-NSZ300
X	P-SUPPLY/PWB/FAN	R	0023	88-108-103-080		C-RES,U 10K-1/16W J	USM CX-SNAJ300
X	P-SUPPLY/PWB/FAN	R	0023	88-108-103-080		C-RES,U 10K-1/16W J	USM CX-SNAJ305

PARTS LIST

! = Δ SAFTY PARTS
 C = Components marked

All components used on this model at the production line are shown in this service manual.

However, please note that not all components will be available as spare parts for after-sales service.

Components marked S and O are designated as spare parts for service and will be stocked at the spare parts centers.

Components marked X and R are not designated as spare parts for after sales service, and will not be stocked at the spare parts centers.

K NO. = Only use japanese.

! C	UNIT NAME	REF NO.	PARTS CODE	K NO.	DESCRIPTION	SUFFIX	MODEL NAME
X	P-SUPPLY/PWB/FAN	R	0023	88-108-103-080		C-RES,U 10K-1/16W J	EZSM CX-NSZ300
X	P-SUPPLY/PWB/FAN	R	0023	88-108-103-080	OE	C-RES,U 10K-1/16W J	LHSM CX-NSZ300
X	P-SUPPLY/PWB/FAN	R	0023	88-108-103-080	OE	C-RES,U 10K-1/16W J	USM CX-SNAJ300
X	P-SUPPLY/PWB/FAN	R	0023	88-108-103-080	OE	C-RES,U 10K-1/16W J	USM CX-SNAJ305
X	P-SUPPLY/PWB/FAN	R	0024	88-118-101-080		C-RES,S 100-1/10W J	USM CX-SNAJ300
X	P-SUPPLY/PWB/FAN	R	0024	88-118-101-080		C-RES,S 100-1/10W J	USM CX-SNAJ305
X	P-SUPPLY/PWB/FAN	R	0024	88-118-101-080	OE	C-RES,S 100-1/10W J	USM CX-SNAJ300
X	P-SUPPLY/PWB/FAN	R	0024	88-118-101-080	OE	C-RES,S 100-1/10W J	USM CX-SNAJ305
X	P-SUPPLY/PWB/FAN	R	0026	88-108-103-080		C-RES,U 10K-1/16W J	USM CX-SNAJ300
X	P-SUPPLY/PWB/FAN	R	0026	88-108-103-080		C-RES,U 10K-1/16W J	USM CX-SNAJ305
X	P-SUPPLY/PWB/FAN	R	0026	88-108-103-080	OE	C-RES,U 10K-1/16W J	USM CX-SNAJ300
X	P-SUPPLY/PWB/FAN	R	0026	88-108-103-080	OE	C-RES,U 10K-1/16W J	USM CX-SNAJ305
X	P-SUPPLY/PWB/FAN	R	0027	88-118-471-080		C-RES,S 470-1/10W J	LHSM CX-NSZ300
X	P-SUPPLY/PWB/FAN	R	0027	88-118-471-080		C-RES,S 470-1/10W J	USM CX-SNAJ300
X	P-SUPPLY/PWB/FAN	R	0027	88-118-471-080		C-RES,S 470-1/10W J	USM CX-SNAJ305
X	P-SUPPLY/PWB/FAN	R	0027	88-118-471-080		C-RES,S 470-1/10W J	EZSM CX-NSZ300
X	P-SUPPLY/PWB/FAN	R	0027	88-118-471-080	OE	C-RES,S 470-1/10W J	LHSM CX-NSZ300
X	P-SUPPLY/PWB/FAN	R	0027	88-118-471-080	OE	C-RES,S 470-1/10W J	USM CX-SNAJ300
X	P-SUPPLY/PWB/FAN	R	0027	88-118-471-080	OE	C-RES,S 470-1/10W J	USM CX-SNAJ305
X	P-SUPPLY/PWB/FAN	R	0028	88-108-103-080		C-RES,U 10K-1/16W J	LHSM CX-NSZ300
X	P-SUPPLY/PWB/FAN	R	0028	88-108-103-080		C-RES,U 10K-1/16W J	USM CX-SNAJ300
X	P-SUPPLY/PWB/FAN	R	0028	88-108-103-080		C-RES,U 10K-1/16W J	USM CX-SNAJ305
X	P-SUPPLY/PWB/FAN	R	0028	88-108-103-080		C-RES,U 10K-1/16W J	EZSM CX-NSZ300
X	P-SUPPLY/PWB/FAN	R	0028	88-108-103-080	OE	C-RES,U 10K-1/16W J	LHSM CX-NSZ300
X	P-SUPPLY/PWB/FAN	R	0028	88-108-103-080	OE	C-RES,U 10K-1/16W J	USM CX-SNAJ300
X	P-SUPPLY/PWB/FAN	R	0028	88-108-103-080	OE	C-RES,U 10K-1/16W J	USM CX-SNAJ305
X	P-SUPPLY/PWB/FAN	R	0029	88-108-222-080		C-RES,U 2.2K-1/16W J	LHSM CX-NSZ300
X	P-SUPPLY/PWB/FAN	R	0029	88-108-222-080		C-RES,U 2.2K-1/16W J	USM CX-SNAJ300
X	P-SUPPLY/PWB/FAN	R	0029	88-108-222-080		C-RES,U 2.2K-1/16W J	USM CX-SNAJ305
X	P-SUPPLY/PWB/FAN	R	0029	88-108-222-080		C-RES,U 2.2K-1/16W J	EZSM CX-NSZ300
X	P-SUPPLY/PWB/FAN	R	0029	88-108-222-080	OE	C-RES,U 2.2K-1/16W J	LHSM CX-NSZ300
X	P-SUPPLY/PWB/FAN	R	0029	88-108-222-080	OE	C-RES,U 2.2K-1/16W J	USM CX-SNAJ300
X	P-SUPPLY/PWB/FAN	R	0029	88-108-222-080	OE	C-RES,U 2.2K-1/16W J	USM CX-SNAJ305
X	P-SUPPLY/PWB/FAN	R	0030	88-108-333-080		C-RES,U 33K-1/16W J	LHSM CX-NSZ300
X	P-SUPPLY/PWB/FAN	R	0030	88-108-333-080		C-RES,U 33K-1/16W J	USM CX-SNAJ300
X	P-SUPPLY/PWB/FAN	R	0030	88-108-333-080		C-RES,U 33K-1/16W J	USM CX-SNAJ305
X	P-SUPPLY/PWB/FAN	R	0030	88-108-333-080		C-RES,U 33K-1/16W J	EZSM CX-NSZ300
X	P-SUPPLY/PWB/FAN	R	0030	88-108-333-080	OE	C-RES,U 33K-1/16W J	LHSM CX-NSZ300
X	P-SUPPLY/PWB/FAN	R	0030	88-108-333-080	OE	C-RES,U 33K-1/16W J	USM CX-SNAJ300
X	P-SUPPLY/PWB/FAN	R	0030	88-108-333-080	OE	C-RES,U 33K-1/16W J	USM CX-SNAJ305
X	P-SUPPLY/PWB/FAN	R	0031	88-108-473-080		C-RES,U 47K-1/16W J	LHSM CX-NSZ300
X	P-SUPPLY/PWB/FAN	R	0031	88-108-473-080		C-RES,U 47K-1/16W J	USM CX-SNAJ300
X	P-SUPPLY/PWB/FAN	R	0031	88-108-473-080		C-RES,U 47K-1/16W J	USM CX-SNAJ305
X	P-SUPPLY/PWB/FAN	R	0031	88-108-473-080		C-RES,U 47K-1/16W J	EZSM CX-NSZ300
X	P-SUPPLY/PWB/FAN	R	0031	88-108-473-080	OE	C-RES,U 47K-1/16W J	LHSM CX-NSZ300
X	P-SUPPLY/PWB/FAN	R	0031	88-108-473-080	OE	C-RES,U 47K-1/16W J	USM CX-SNAJ300
X	P-SUPPLY/PWB/FAN	R	0031	88-108-473-080	OE	C-RES,U 47K-1/16W J	USM CX-SNAJ305
X	P-SUPPLY/PWB/FAN	R	0032	88-121-102-080		RES,1K-1/8W J	LHSM CX-NSZ300
X	P-SUPPLY/PWB/FAN	R	0032	88-121-102-080		RES,1K-1/8W J	USM CX-SNAJ300
X	P-SUPPLY/PWB/FAN	R	0032	88-121-102-080		RES,1K-1/8W J	USM CX-SNAJ305
X	P-SUPPLY/PWB/FAN	R	0032	88-121-102-080	OE	RES,1K-1/8W J	USM CX-SNAJ300
X	P-SUPPLY/PWB/FAN	R	0032	88-121-102-080	OE	RES,1K-1/8W J	USM CX-SNAJ305
X	P-SUPPLY/PWB/FAN	R	0033	88-108-101-080		C-RES,U 100-1/16W J	LHSM CX-NSZ300
X	P-SUPPLY/PWB/FAN	R	0033	88-108-101-080		C-RES,U 100-1/16W J	USM CX-SNAJ300
X	P-SUPPLY/PWB/FAN	R	0033	88-108-101-080		C-RES,U 100-1/16W J	USM CX-SNAJ305
X	P-SUPPLY/PWB/FAN	R	0033	88-108-101-080		C-RES,U 100-1/16W J	EZSM CX-NSZ300
X	P-SUPPLY/PWB/FAN	R	0033	88-108-101-080	OE	C-RES,U 100-1/16W J	LHSM CX-NSZ300
X	P-SUPPLY/PWB/FAN	R	0033	88-108-101-080	OE	C-RES,U 100-1/16W J	USM CX-SNAJ300
X	P-SUPPLY/PWB/FAN	R	0033	88-108-101-080	OE	C-RES,U 100-1/16W J	USM CX-SNAJ305
X	P-SUPPLY/PWB/FAN	R	0034	88-108-394-080		C-RES,U 390K-1/16W J	LHSM CX-NSZ300
X	P-SUPPLY/PWB/FAN	R	0034	88-108-394-080		C-RES,U 390K-1/16W J	USM CX-SNAJ300
X	P-SUPPLY/PWB/FAN	R	0034	88-108-394-080		C-RES,U 390K-1/16W J	USM CX-SNAJ305
X	P-SUPPLY/PWB/FAN	R	0034	88-108-394-080		C-RES,U 390K-1/16W J	EZSM CX-NSZ300
X	P-SUPPLY/PWB/FAN	R	0034	88-108-394-080	OE	C-RES,U 390K-1/16W J	LHSM CX-NSZ300
X	P-SUPPLY/PWB/FAN	R	0034	88-108-394-080	OE	C-RES,U 390K-1/16W J	USM CX-SNAJ300
X	P-SUPPLY/PWB/FAN	R	0034	88-108-394-080	OE	C-RES,U 390K-1/16W J	USM CX-SNAJ305
X	P-SUPPLY/PWB/FAN	R	0037	88-128-680-080		C-RES, 68-1/8W J	LHSM CX-NSZ300
X	P-SUPPLY/PWB/FAN	R	0037	88-128-680-080		C-RES, 68-1/8W J	USM CX-SNAJ300

PARTS LIST

! = Δ SAFTY PARTS
 C = Components marked

All components used on this model at the production line are shown in this service manual.

However, please note that not all components will be available as spare parts for after-sales service.

Components marked S and O are designated as spare parts for service and will be stocked at the spare parts centers.

Components marked X and R are not designated as spare parts for after sales service, and will not be stocked at the spare parts centers.

K NO. = Only use japanese.

! C	UNIT NAME	REF NO.	PARTS CODE	K NO.	DESCRIPTION	SUFFIX	MODEL NAME	
X	P-SUPPLY/PWB/FAN	R	0037	88-128-680-080		C-RES, 68-1/8W J	USM	CX-SNAJ305
X	P-SUPPLY/PWB/FAN	R	0037	88-128-680-080		C-RES, 68-1/8W J	EZSM	CX-NSZ300
X	P-SUPPLY/PWB/FAN	R	0037	88-128-680-080	OE	C-RES, 68-1/8W J	LHSM	CX-NSZ300
X	P-SUPPLY/PWB/FAN	R	0037	88-128-680-080	OE	C-RES, 68-1/8W J	USM	CX-SNAJ300
X	P-SUPPLY/PWB/FAN	R	0037	88-128-680-080	OE	C-RES, 68-1/8W J	USM	CX-SNAJ305
X	P-SUPPLY/PWB/FAN	R	0038	88-130-151-080		RES,150-1/4W J	LHSM	CX-NSZ300
X	P-SUPPLY/PWB/FAN	R	0038	88-130-151-080		RES,150-1/4W J	USM	CX-SNAJ300
X	P-SUPPLY/PWB/FAN	R	0038	88-130-151-080		RES,150-1/4W J	USM	CX-SNAJ305
X	P-SUPPLY/PWB/FAN	R	0038	88-130-151-080		RES,150-1/4W J	EZSM	CX-NSZ300
X	P-SUPPLY/PWB/FAN	R	0038	88-130-151-080	OE	RES,150-1/4W J	LHSM	CX-NSZ300
X	P-SUPPLY/PWB/FAN	R	0038	88-130-151-080	OE	RES,150-1/4W J	USM	CX-SNAJ300
X	P-SUPPLY/PWB/FAN	R	0038	88-130-151-080	OE	RES,150-1/4W J	USM	CX-SNAJ305
X	P-SUPPLY/PWB/FAN	R	0039	88-128-680-080		C-RES, 68-1/8W J	LHSM	CX-NSZ300
X	P-SUPPLY/PWB/FAN	R	0039	88-128-680-080		C-RES, 68-1/8W J	USM	CX-SNAJ300
X	P-SUPPLY/PWB/FAN	R	0039	88-128-680-080		C-RES, 68-1/8W J	USM	CX-SNAJ305
X	P-SUPPLY/PWB/FAN	R	0039	88-128-680-080	OE	C-RES, 68-1/8W J	EZSM	CX-NSZ300
X	P-SUPPLY/PWB/FAN	R	0039	88-128-680-080	OE	C-RES, 68-1/8W J	LHSM	CX-NSZ300
X	P-SUPPLY/PWB/FAN	R	0039	88-128-680-080	OE	C-RES, 68-1/8W J	USM	CX-SNAJ300
X	P-SUPPLY/PWB/FAN	R	0039	88-128-680-080	OE	C-RES, 68-1/8W J	USM	CX-SNAJ305
X	P-SUPPLY/PWB/FAN	R	0042	88-130-151-080		RES,150-1/4W J	LHSM	CX-NSZ300
X	P-SUPPLY/PWB/FAN	R	0042	88-130-151-080		RES,150-1/4W J	USM	CX-SNAJ300
X	P-SUPPLY/PWB/FAN	R	0042	88-130-151-080		RES,150-1/4W J	USM	CX-SNAJ305
X	P-SUPPLY/PWB/FAN	R	0042	88-130-151-080	OE	RES,150-1/4W J	EZSM	CX-NSZ300
X	P-SUPPLY/PWB/FAN	R	0042	88-130-151-080	OE	RES,150-1/4W J	LHSM	CX-NSZ300
X	P-SUPPLY/PWB/FAN	R	0042	88-130-151-080	OE	RES,150-1/4W J	USM	CX-SNAJ300
X	P-SUPPLY/PWB/FAN	R	0042	88-130-151-080	OE	RES,150-1/4W J	USM	CX-SNAJ305
X	P-SUPPLY/PWB/FAN	R	0043	88-130-151-080		RES,150-1/4W J	LHSM	CX-NSZ300
X	P-SUPPLY/PWB/FAN	R	0043	88-130-151-080		RES,150-1/4W J	USM	CX-SNAJ300
X	P-SUPPLY/PWB/FAN	R	0043	88-130-151-080		RES,150-1/4W J	USM	CX-SNAJ305
X	P-SUPPLY/PWB/FAN	R	0043	88-130-151-080		RES,150-1/4W J	EZSM	CX-NSZ300
X	P-SUPPLY/PWB/FAN	R	0043	88-130-151-080	OE	RES,150-1/4W J	LHSM	CX-NSZ300
X	P-SUPPLY/PWB/FAN	R	0043	88-130-151-080	OE	RES,150-1/4W J	USM	CX-SNAJ300
X	P-SUPPLY/PWB/FAN	R	0043	88-130-151-080	OE	RES,150-1/4W J	USM	CX-SNAJ305
X	P-SUPPLY/PWB/FAN	R	0043	88-130-151-080	OE	RES,150-1/4W J	LHSM	CX-NSZ300
X	P-SUPPLY/PWB/FAN	R	0043	88-130-151-080	OE	RES,150-1/4W J	USM	CX-SNAJ300
X	P-SUPPLY/PWB/FAN	R	0043	88-130-151-080	OE	RES,150-1/4W J	USM	CX-SNAJ305
X	P-SUPPLY/PWB/FAN	R	0044	88-128-680-080		C-RES, 68-1/8W J	LHSM	CX-NSZ300
X	P-SUPPLY/PWB/FAN	R	0044	88-128-680-080		C-RES, 68-1/8W J	USM	CX-SNAJ300
X	P-SUPPLY/PWB/FAN	R	0044	88-128-680-080		C-RES, 68-1/8W J	USM	CX-SNAJ305
X	P-SUPPLY/PWB/FAN	R	0044	88-128-680-080		C-RES, 68-1/8W J	EZSM	CX-NSZ300
X	P-SUPPLY/PWB/FAN	R	0044	88-128-680-080		C-RES, 68-1/8W J	USM	CX-SNAJ300
X	P-SUPPLY/PWB/FAN	R	0044	88-128-680-080	OE	C-RES, 68-1/8W J	USM	CX-SNAJ305
X	P-SUPPLY/PWB/FAN	R	0044	88-128-820-080	OE	C-RES, 82-1/8W J	LHSM	CX-NSZ300
X	P-SUPPLY/PWB/FAN	R	0045	88-128-680-080		C-RES, 68-1/8W J	LHSM	CX-NSZ300
X	P-SUPPLY/PWB/FAN	R	0045	88-128-680-080		C-RES, 68-1/8W J	USM	CX-SNAJ300
X	P-SUPPLY/PWB/FAN	R	0045	88-128-680-080		C-RES, 68-1/8W J	USM	CX-SNAJ305
X	P-SUPPLY/PWB/FAN	R	0045	88-128-680-080	OE	C-RES, 68-1/8W J	EZSM	CX-NSZ300
X	P-SUPPLY/PWB/FAN	R	0045	88-128-680-080	OE	C-RES, 68-1/8W J	LHSM	CX-NSZ300
X	P-SUPPLY/PWB/FAN	R	0045	88-128-680-080	OE	C-RES, 68-1/8W J	USM	CX-SNAJ300
X	P-SUPPLY/PWB/FAN	R	0045	88-128-680-080	OE	C-RES, 68-1/8W J	USM	CX-SNAJ305
X	P-SUPPLY/PWB/FAN	R	0046	88-130-151-080		RES,150-1/4W J	LHSM	CX-NSZ300
X	P-SUPPLY/PWB/FAN	R	0046	88-130-151-080		RES,150-1/4W J	USM	CX-SNAJ300
X	P-SUPPLY/PWB/FAN	R	0046	88-130-151-080		RES,150-1/4W J	USM	CX-SNAJ305
X	P-SUPPLY/PWB/FAN	R	0046	88-130-151-080	OE	RES,150-1/4W J	EZSM	CX-NSZ300
X	P-SUPPLY/PWB/FAN	R	0046	88-130-151-080	OE	RES,150-1/4W J	LHSM	CX-NSZ300
X	P-SUPPLY/PWB/FAN	R	0047	88-100-000-010		PLATING-JW, 0.58 SN95	LHSM	CX-SNAJ300
X	P-SUPPLY/PWB/FAN	R	0047	88-100-000-010		PLATING-JW, 0.58 SN95	USM	CX-SNAJ305
X	P-SUPPLY/PWB/FAN	R	0047	88-100-000-010		PLATING-JW, 0.58 SN95	USM	CX-SNAJ300
X	P-SUPPLY/PWB/FAN	R	0047	88-100-000-010		PLATING-JW, 0.58 SN95	EZSM	CX-NSZ300
X	P-SUPPLY/PWB/FAN	R	0047	88-100-000-010	OE	PLATING-JW, 0.58 SN95	LHSM	CX-NSZ300
X	P-SUPPLY/PWB/FAN	R	0047	88-100-000-010	OE	PLATING-JW, 0.58 SN95	USM	CX-SNAJ300
X	P-SUPPLY/PWB/FAN	R	0047	88-100-000-010	OE	PLATING-JW, 0.58 SN95	USM	CX-SNAJ305
X	P-SUPPLY/PWB/FAN	R	0047	88-130-151-080		RES,150-1/4W J	USM	CX-SNAJ300
X	P-SUPPLY/PWB/FAN	R	0050	88-128-680-080		C-RES, 68-1/8W J	LHSM	CX-NSZ300
X	P-SUPPLY/PWB/FAN	R	0050	88-128-680-080		C-RES, 68-1/8W J	USM	CX-SNAJ300
X	P-SUPPLY/PWB/FAN	R	0050	88-128-680-080		C-RES, 68-1/8W J	USM	CX-SNAJ305
X	P-SUPPLY/PWB/FAN	R	0050	88-128-680-080		C-RES, 68-1/8W J	EZSM	CX-NSZ300
X	P-SUPPLY/PWB/FAN	R	0050	88-128-680-080	OE	C-RES, 68-1/8W J	USM	CX-SNAJ300
X	P-SUPPLY/PWB/FAN	R	0050	88-128-680-080	OE	C-RES, 68-1/8W J	USM	CX-SNAJ305
X	P-SUPPLY/PWB/FAN	R	0050	88-128-820-080	OE	C-RES, 82-1/8W J	LHSM	CX-NSZ300
X	P-SUPPLY/PWB/FAN	R	0051	88-128-680-080		C-RES, 68-1/8W J	LHSM	CX-NSZ300
X	P-SUPPLY/PWB/FAN	R	0051	88-128-680-080		C-RES, 68-1/8W J	USM	CX-SNAJ300

PARTS LIST

! = Δ SAFTY PARTS
 C = Components marked

All components used on this model at the production line are shown in this service manual.

However, please note that not all components will be available as spare parts for after-sales service.

Components marked S and O are designated as spare parts for service and will be stocked at the spare parts centers.

Components marked X and R are not designated as spare parts for after sales service, and will not be stocked at the spare parts centers.

K NO. = Only use japanese.

! C	UNIT NAME	REF NO.	PARTS CODE	K NO.	DESCRIPTION	SUFFIX	MODEL NAME	
X	P-SUPPLY/PWB/FAN	R	0051	88-128-680-080		C-RES, 68-1/8W J	USM	CX-SNAJ305
X	P-SUPPLY/PWB/FAN	R	0051	88-128-680-080		C-RES, 68-1/8W J	EZSM	CX-NSZ300
X	P-SUPPLY/PWB/FAN	R	0051	88-128-680-080	OE	C-RES, 68-1/8W J	LHSM	CX-NSZ300
X	P-SUPPLY/PWB/FAN	R	0051	88-128-680-080	OE	C-RES, 68-1/8W J	USM	CX-SNAJ300
X	P-SUPPLY/PWB/FAN	R	0051	88-128-680-080	OE	C-RES, 68-1/8W J	USM	CX-SNAJ305
X	P-SUPPLY/PWB/FAN	R	0052	88-108-333-080		C-RES,U 33K-1/16W J	LHSM	CX-NSZ300
X	P-SUPPLY/PWB/FAN	R	0052	88-108-333-080		C-RES,U 33K-1/16W J	USM	CX-SNAJ300
X	P-SUPPLY/PWB/FAN	R	0052	88-108-333-080		C-RES,U 33K-1/16W J	USM	CX-SNAJ305
X	P-SUPPLY/PWB/FAN	R	0052	88-108-333-080		C-RES,U 33K-1/16W J	EZSM	CX-NSZ300
X	P-SUPPLY/PWB/FAN	R	0052	88-108-333-080	OE	C-RES,U 33K-1/16W J	LHSM	CX-NSZ300
X	P-SUPPLY/PWB/FAN	R	0052	88-108-333-080	OE	C-RES,U 33K-1/16W J	USM	CX-SNAJ300
X	P-SUPPLY/PWB/FAN	R	0052	88-108-333-080	OE	C-RES,U 33K-1/16W J	USM	CX-SNAJ305
X	P-SUPPLY/PWB/FAN	R	0052	88-108-333-080	OE	C-RES,U 33K-1/16W J	EZSM	CX-NSZ300
X	P-SUPPLY/PWB/FAN	R	0052	88-108-333-080	OE	C-RES,U 33K-1/16W J	LHSM	CX-NSZ300
X	P-SUPPLY/PWB/FAN	R	0054	88-118-473-080		C-RES,S 47K-1/10W J	USM	CX-SNAJ300
X	P-SUPPLY/PWB/FAN	R	0054	88-118-473-080		C-RES,S 47K-1/10W J	LHSM	CX-NSZ300
X	P-SUPPLY/PWB/FAN	R	0054	88-118-473-080		C-RES,S 47K-1/10W J	USM	CX-SNAJ300
X	P-SUPPLY/PWB/FAN	R	0054	88-118-473-080		C-RES,S 47K-1/10W J	USM	CX-SNAJ305
X	P-SUPPLY/PWB/FAN	R	0054	88-118-473-080	OE	C-RES,S 47K-1/10W J	EZSM	CX-NSZ300
X	P-SUPPLY/PWB/FAN	R	0054	88-118-473-080	OE	C-RES,S 47K-1/10W J	LHSM	CX-NSZ300
X	P-SUPPLY/PWB/FAN	R	0054	88-118-473-080	OE	C-RES,S 47K-1/10W J	USM	CX-SNAJ300
X	P-SUPPLY/PWB/FAN	R	0054	88-118-473-080	OE	C-RES,S 47K-1/10W J	USM	CX-SNAJ305
X	P-SUPPLY/PWB/FAN	R	0055	88-118-473-080		C-RES,S 47K-1/10W J	LHSM	CX-NSZ300
X	P-SUPPLY/PWB/FAN	R	0055	88-118-473-080		C-RES,S 47K-1/10W J	USM	CX-SNAJ300
X	P-SUPPLY/PWB/FAN	R	0055	88-118-473-080		C-RES,S 47K-1/10W J	USM	CX-SNAJ305
X	P-SUPPLY/PWB/FAN	R	0055	88-118-473-080		C-RES,S 47K-1/10W J	EZSM	CX-NSZ300
X	P-SUPPLY/PWB/FAN	R	0055	88-118-473-080	OE	C-RES,S 47K-1/10W J	LHSM	CX-NSZ300
X	P-SUPPLY/PWB/FAN	R	0055	88-118-473-080	OE	C-RES,S 47K-1/10W J	USM	CX-SNAJ300
X	P-SUPPLY/PWB/FAN	R	0055	88-118-473-080	OE	C-RES,S 47K-1/10W J	USM	CX-SNAJ305
X	P-SUPPLY/PWB/FAN	R	0055	88-118-473-080	OE	C-RES,S 47K-1/10W J	LHSM	CX-NSZ300
X	P-SUPPLY/PWB/FAN	R	0056	88-108-103-080		C-RES,U 10K-1/16W J	USM	CX-SNAJ305
X	P-SUPPLY/PWB/FAN	R	0056	88-108-123-080		C-RES,U 12K-1/16W J	USM	CX-SNAJ300
X	P-SUPPLY/PWB/FAN	R	0056	88-108-682-080	OE	C-RES,U 6.8K-1/16W J	LHSM	CX-NSZ300
X	P-SUPPLY/PWB/FAN	R	0056	88-108-822-080		C-RES,U 8.2K-1/16W J	LHSM	CX-NSZ300
X	P-SUPPLY/PWB/FAN	R	0056	88-108-822-080		C-RES,U 8.2K-1/16W J	EZSM	CX-NSZ300
X	P-SUPPLY/PWB/FAN	R	0056	88-108-822-080	OE	C-RES,U 8.2K-1/16W J	USM	CX-SNAJ300
X	P-SUPPLY/PWB/FAN	R	0056	88-108-822-080	OE	C-RES,U 8.2K-1/16W J	USM	CX-SNAJ305
X	P-SUPPLY/PWB/FAN	R	0057	88-108-182-080		C-RES,U 1.8K-1/16W J	USM	CX-SNAJ300
X	P-SUPPLY/PWB/FAN	R	0057	88-108-182-080		C-RES,U 1.8K-1/16W J	USM	CX-SNAJ305
X	P-SUPPLY/PWB/FAN	R	0057	88-108-182-080	OE	C-RES,U 1.8K-1/16W J	LHSM	CX-NSZ300
X	P-SUPPLY/PWB/FAN	R	0057	88-108-182-080	OE	C-RES,U 1.8K-1/16W J	USM	CX-SNAJ300
X	P-SUPPLY/PWB/FAN	R	0057	88-108-182-080	OE	C-RES,U 1.8K-1/16W J	USM	CX-SNAJ305
X	P-SUPPLY/PWB/FAN	R	0057	88-108-222-080		C-RES,U 2.2K-1/16W J	LHSM	CX-NSZ300
X	P-SUPPLY/PWB/FAN	R	0057	88-108-222-080		C-RES,U 2.2K-1/16W J	EZSM	CX-NSZ300
X	P-SUPPLY/PWB/FAN	R	0057	88-108-222-080	OE	C-RES,U 2.2K-1/16W J	LHSM	CX-NSZ300
X	P-SUPPLY/PWB/FAN	R	0058	88-108-223-080		C-RES,U 22K-1/16W J	USM	CX-SNAJ300
X	P-SUPPLY/PWB/FAN	R	0058	88-108-392-080	OE	C-RES,U 3.9K-1/16W J	LHSM	CX-NSZ300
X	P-SUPPLY/PWB/FAN	R	0058	88-108-472-080		C-RES,U 4.7K-1/16W J	LHSM	CX-NSZ300
X	P-SUPPLY/PWB/FAN	R	0058	88-108-472-080		C-RES,U 4.7K-1/16W J	USM	CX-SNAJ305
X	P-SUPPLY/PWB/FAN	R	0058	88-108-472-080	OE	C-RES,U 4.7K-1/16W J	USM	CX-SNAJ300
X	P-SUPPLY/PWB/FAN	R	0058	88-108-472-080	OE	C-RES,U 4.7K-1/16W J	USM	CX-SNAJ305
X	P-SUPPLY/PWB/FAN	R	0058	88-108-562-080		C-RES,U 5.6K-1/16W J	EZSM	CX-NSZ300
X	P-SUPPLY/PWB/FAN	R	0059	88-118-103-080		C-RES,S 10K-1/10W J	LHSM	CX-NSZ300
X	P-SUPPLY/PWB/FAN	R	0059	88-118-103-080		C-RES,S 10K-1/10W J	USM	CX-SNAJ300
X	P-SUPPLY/PWB/FAN	R	0059	88-118-103-080		C-RES,S 10K-1/10W J	USM	CX-SNAJ305
X	P-SUPPLY/PWB/FAN	R	0059	88-118-103-080	OE	C-RES,S 10K-1/10W J	EZSM	CX-NSZ300
X	P-SUPPLY/PWB/FAN	R	0059	88-118-103-080	OE	C-RES,S 10K-1/10W J	LHSM	CX-NSZ300
X	P-SUPPLY/PWB/FAN	R	0059	88-118-103-080	OE	C-RES,S 10K-1/10W J	USM	CX-SNAJ300
X	P-SUPPLY/PWB/FAN	R	0059	88-118-103-080	OE	C-RES,S 10K-1/10W J	USM	CX-SNAJ305
X	P-SUPPLY/PWB/FAN	R	0060	88-118-473-080		C-RES,S 47K-1/10W J	LHSM	CX-NSZ300
X	P-SUPPLY/PWB/FAN	R	0060	88-118-473-080		C-RES,S 47K-1/10W J	USM	CX-SNAJ300
X	P-SUPPLY/PWB/FAN	R	0060	88-118-473-080		C-RES,S 47K-1/10W J	USM	CX-SNAJ305
X	P-SUPPLY/PWB/FAN	R	0060	88-118-473-080		C-RES,S 47K-1/10W J	EZSM	CX-NSZ300
X	P-SUPPLY/PWB/FAN	R	0060	88-118-473-080	OE	C-RES,S 47K-1/10W J	LHSM	CX-NSZ300
X	P-SUPPLY/PWB/FAN	R	0060	88-118-473-080	OE	C-RES,S 47K-1/10W J	USM	CX-SNAJ300
X	P-SUPPLY/PWB/FAN	R	0061	88-108-333-080	OE	C-RES,S 47K-1/10W J	USM	CX-SNAJ305
X	P-SUPPLY/PWB/FAN	R	0061	88-108-333-080		C-RES,U 33K-1/16W J	LHSM	CX-NSZ300
X	P-SUPPLY/PWB/FAN	R	0061	88-108-333-080		C-RES,U 33K-1/16W J	USM	CX-SNAJ300
X	P-SUPPLY/PWB/FAN	R	0061	88-108-333-080		C-RES,U 33K-1/16W J	USM	CX-SNAJ305
X	P-SUPPLY/PWB/FAN	R	0061	88-108-333-080		C-RES,U 33K-1/16W J	EZSM	CX-NSZ300
X	P-SUPPLY/PWB/FAN	R	0061	88-108-333-080	OE	C-RES,U 33K-1/16W J	LHSM	CX-NSZ300
X	P-SUPPLY/PWB/FAN	R	0061	88-108-333-080	OE	C-RES,U 33K-1/16W J	USM	CX-SNAJ300
X	P-SUPPLY/PWB/FAN	R	0061	88-108-333-080	OE	C-RES,U 33K-1/16W J	USM	CX-SNAJ305
X	P-SUPPLY/PWB/FAN	R	0062	88-108-273-080		C-RES,U 27K-1/16W J	LHSM	CX-NSZ300
X	P-SUPPLY/PWB/FAN	R	0062	88-108-273-080		C-RES,U 27K-1/16W J	USM	CX-SNAJ300

PARTS LIST

! = Δ SAFTY PARTS
 C = Components marked

All components used on this model at the production line are shown in this service manual.

However, please note that not all components will be available as spare parts for after-sales service.

Components marked S and O are designated as spare parts for service and will be stocked at the spare parts centers.

Components marked X and R are not designated as spare parts for after sales service, and will not be stocked at the spare parts centers.

K NO. = Only use japanese.

! C	UNIT NAME	REF NO.	PARTS CODE	K NO.	DESCRIPTION	SUFFIX	MODEL NAME		
X	P-SUPPLY/PWB/FAN	R	0062	88-108-273-080		C-RES,U	27K-1/16W J	USM	CX-SNAJ305
X	P-SUPPLY/PWB/FAN	R	0062	88-108-273-080		C-RES,U	27K-1/16W J	EZSM	CX-NSZ300
X	P-SUPPLY/PWB/FAN	R	0062	88-108-273-080	OE	C-RES,U	27K-1/16W J	LHSM	CX-NSZ300
X	P-SUPPLY/PWB/FAN	R	0062	88-108-273-080	OE	C-RES,U	27K-1/16W J	USM	CX-SNAJ300
X	P-SUPPLY/PWB/FAN	R	0062	88-108-273-080	OE	C-RES,U	27K-1/16W J	USM	CX-SNAJ305
X	P-SUPPLY/PWB/FAN	R	0063	88-108-273-080		C-RES,U	27K-1/16W J	LHSM	CX-NSZ300
X	P-SUPPLY/PWB/FAN	R	0063	88-108-273-080		C-RES,U	27K-1/16W J	USM	CX-SNAJ300
X	P-SUPPLY/PWB/FAN	R	0063	88-108-273-080		C-RES,U	27K-1/16W J	USM	CX-SNAJ305
X	P-SUPPLY/PWB/FAN	R	0063	88-108-273-080		C-RES,U	27K-1/16W J	EZSM	CX-NSZ300
X	P-SUPPLY/PWB/FAN	R	0063	88-108-273-080	OE	C-RES,U	27K-1/16W J	LHSM	CX-NSZ300
X	P-SUPPLY/PWB/FAN	R	0063	88-108-273-080	OE	C-RES,U	27K-1/16W J	USM	CX-SNAJ300
X	P-SUPPLY/PWB/FAN	R	0063	88-108-273-080	OE	C-RES,U	27K-1/16W J	USM	CX-SNAJ305
X	P-SUPPLY/PWB/FAN	R	0064	88-108-102-080		C-RES,U	1K-1/16W J	LHSM	CX-NSZ300
X	P-SUPPLY/PWB/FAN	R	0064	88-108-102-080		C-RES,U	1K-1/16W J	USM	CX-SNAJ300
X	P-SUPPLY/PWB/FAN	R	0064	88-108-102-080		C-RES,U	1K-1/16W J	USM	CX-SNAJ305
X	P-SUPPLY/PWB/FAN	R	0064	88-108-102-080		C-RES,U	1K-1/16W J	EZSM	CX-NSZ300
X	P-SUPPLY/PWB/FAN	R	0064	88-108-102-080	OE	C-RES,U	1K-1/16W J	LHSM	CX-NSZ300
X	P-SUPPLY/PWB/FAN	R	0064	88-108-102-080	OE	C-RES,U	1K-1/16W J	USM	CX-SNAJ300
X	P-SUPPLY/PWB/FAN	R	0064	88-108-102-080	OE	C-RES,U	1K-1/16W J	USM	CX-SNAJ305
X	P-SUPPLY/PWB/FAN	R	0065	88-108-123-080		C-RES,U	12K-1/16W J	LHSM	CX-NSZ300
X	P-SUPPLY/PWB/FAN	R	0065	88-108-123-080		C-RES,U	12K-1/16W J	USM	CX-SNAJ300
X	P-SUPPLY/PWB/FAN	R	0065	88-108-123-080		C-RES,U	12K-1/16W J	USM	CX-SNAJ305
X	P-SUPPLY/PWB/FAN	R	0065	88-108-123-080		C-RES,U	12K-1/16W J	EZSM	CX-NSZ300
X	P-SUPPLY/PWB/FAN	R	0065	88-108-123-080	OE	C-RES,U	12K-1/16W J	LHSM	CX-NSZ300
X	P-SUPPLY/PWB/FAN	R	0065	88-108-123-080	OE	C-RES,U	12K-1/16W J	USM	CX-SNAJ300
X	P-SUPPLY/PWB/FAN	R	0065	88-108-123-080	OE	C-RES,U	12K-1/16W J	USM	CX-SNAJ305
X	P-SUPPLY/PWB/FAN	R	0066	88-108-104-080		C-RES,U	100K-1/16W J	LHSM	CX-NSZ300
X	P-SUPPLY/PWB/FAN	R	0066	88-108-104-080		C-RES,U	100K-1/16W J	USM	CX-SNAJ300
X	P-SUPPLY/PWB/FAN	R	0066	88-108-104-080		C-RES,U	100K-1/16W J	USM	CX-SNAJ305
X	P-SUPPLY/PWB/FAN	R	0066	88-108-104-080		C-RES,U	100K-1/16W J	EZSM	CX-NSZ300
X	P-SUPPLY/PWB/FAN	R	0066	88-108-104-080	OE	C-RES,U	100K-1/16W J	LHSM	CX-NSZ300
X	P-SUPPLY/PWB/FAN	R	0066	88-108-104-080	OE	C-RES,U	100K-1/16W J	USM	CX-SNAJ300
X	P-SUPPLY/PWB/FAN	R	0066	88-108-104-080	OE	C-RES,U	100K-1/16W J	USM	CX-SNAJ305
X	P-SUPPLY/PWB/FAN	R	0067	88-108-103-080		C-RES,U	10K-1/16W J	LHSM	CX-NSZ300
X	P-SUPPLY/PWB/FAN	R	0067	88-108-103-080		C-RES,U	10K-1/16W J	USM	CX-SNAJ300
X	P-SUPPLY/PWB/FAN	R	0067	88-108-103-080		C-RES,U	10K-1/16W J	USM	CX-SNAJ305
X	P-SUPPLY/PWB/FAN	R	0067	88-108-103-080		C-RES,U	10K-1/16W J	EZSM	CX-NSZ300
X	P-SUPPLY/PWB/FAN	R	0067	88-108-103-080	OE	C-RES,U	10K-1/16W J	LHSM	CX-NSZ300
X	P-SUPPLY/PWB/FAN	R	0067	88-108-103-080	OE	C-RES,U	10K-1/16W J	USM	CX-SNAJ300
X	P-SUPPLY/PWB/FAN	R	0067	88-108-103-080	OE	C-RES,U	10K-1/16W J	USM	CX-SNAJ305
X	P-SUPPLY/PWB/FAN	R	0068	88-108-224-080		C-RES,U	220K-1/16W J	LHSM	CX-NSZ300
X	P-SUPPLY/PWB/FAN	R	0068	88-108-224-080		C-RES,U	220K-1/16W J	USM	CX-SNAJ300
X	P-SUPPLY/PWB/FAN	R	0068	88-108-224-080		C-RES,U	220K-1/16W J	USM	CX-SNAJ305
X	P-SUPPLY/PWB/FAN	R	0068	88-108-224-080		C-RES,U	220K-1/16W J	EZSM	CX-NSZ300
X	P-SUPPLY/PWB/FAN	R	0068	88-108-224-080	OE	C-RES,U	220K-1/16W J	LHSM	CX-NSZ300
X	P-SUPPLY/PWB/FAN	R	0068	88-108-224-080	OE	C-RES,U	220K-1/16W J	USM	CX-SNAJ300
X	P-SUPPLY/PWB/FAN	R	0068	88-108-224-080	OE	C-RES,U	220K-1/16W J	USM	CX-SNAJ305
X	P-SUPPLY/PWB/FAN	R	0069	88-108-224-080		C-RES,U	220K-1/16W J	LHSM	CX-NSZ300
X	P-SUPPLY/PWB/FAN	R	0069	88-108-224-080		C-RES,U	220K-1/16W J	USM	CX-SNAJ300
X	P-SUPPLY/PWB/FAN	R	0069	88-108-224-080		C-RES,U	220K-1/16W J	USM	CX-SNAJ305
X	P-SUPPLY/PWB/FAN	R	0069	88-108-224-080		C-RES,U	220K-1/16W J	EZSM	CX-NSZ300
X	P-SUPPLY/PWB/FAN	R	0069	88-108-224-080	OE	C-RES,U	220K-1/16W J	LHSM	CX-NSZ300
X	P-SUPPLY/PWB/FAN	R	0069	88-108-224-080	OE	C-RES,U	220K-1/16W J	USM	CX-SNAJ300
X	P-SUPPLY/PWB/FAN	R	0069	88-108-224-080	OE	C-RES,U	220K-1/16W J	USM	CX-SNAJ305
X	P-SUPPLY/PWB/FAN	R	0070	88-108-102-080		C-RES,U	1K-1/16W J	LHSM	CX-NSZ300
X	P-SUPPLY/PWB/FAN	R	0070	88-108-102-080		C-RES,U	1K-1/16W J	USM	CX-SNAJ300
X	P-SUPPLY/PWB/FAN	R	0070	88-108-102-080		C-RES,U	1K-1/16W J	USM	CX-SNAJ305
X	P-SUPPLY/PWB/FAN	R	0070	88-108-102-080		C-RES,U	1K-1/16W J	EZSM	CX-NSZ300
X	P-SUPPLY/PWB/FAN	R	0070	88-108-102-080	OE	C-RES,U	1K-1/16W J	LHSM	CX-NSZ300
X	P-SUPPLY/PWB/FAN	R	0070	88-108-102-080	OE	C-RES,U	1K-1/16W J	USM	CX-SNAJ300
X	P-SUPPLY/PWB/FAN	R	0070	88-108-102-080	OE	C-RES,U	1K-1/16W J	USM	CX-SNAJ305
X	P-SUPPLY/PWB/FAN	R	0071	88-108-473-080		C-RES,U	47K-1/16W J	LHSM	CX-NSZ300
X	P-SUPPLY/PWB/FAN	R	0071	88-108-473-080		C-RES,U	47K-1/16W J	USM	CX-SNAJ300
X	P-SUPPLY/PWB/FAN	R	0071	88-108-473-080		C-RES,U	47K-1/16W J	USM	CX-SNAJ305
X	P-SUPPLY/PWB/FAN	R	0071	88-108-473-080		C-RES,U	47K-1/16W J	EZSM	CX-NSZ300
X	P-SUPPLY/PWB/FAN	R	0071	88-108-473-080	OE	C-RES,U	47K-1/16W J	LHSM	CX-NSZ300
X	P-SUPPLY/PWB/FAN	R	0071	88-108-473-080	OE	C-RES,U	47K-1/16W J	USM	CX-SNAJ300
X	P-SUPPLY/PWB/FAN	R	0071	88-108-473-080	OE	C-RES,U	47K-1/16W J	USM	CX-SNAJ305
X	P-SUPPLY/PWB/FAN	R	0072	88-108-473-080		C-RES,U	47K-1/16W J	LHSM	CX-NSZ300
X	P-SUPPLY/PWB/FAN	R	0072	88-108-473-080		C-RES,U	47K-1/16W J	USM	CX-SNAJ300

PARTS LIST

! = Δ SAFTY PARTS
 C = Components marked

All components used on this model at the production line are shown in this service manual.

However, please note that not all components will be available as spare parts for after-sales service.

Components marked S and O are designated as spare parts for service and will be stocked at the spare parts centers.

Components marked X and R are not designated as spare parts for after sales service, and will not be stocked at the spare parts centers.

K NO. = Only use japanese.

! C	UNIT NAME	REF NO.	PARTS CODE	K NO.	DESCRIPTION	SUFFIX	MODEL NAME
X	P-SUPPLY/PWB/FAN	R 0072	88-108-473-080		C-RES,U 47K-1/16W J	USM	CX-SNAJ305
X	P-SUPPLY/PWB/FAN	R 0072	88-108-473-080		C-RES,U 47K-1/16W J	EZSM	CX-NSZ300
X	P-SUPPLY/PWB/FAN	R 0072	88-108-473-080	OE	C-RES,U 47K-1/16W J	LHSM	CX-NSZ300
X	P-SUPPLY/PWB/FAN	R 0072	88-108-473-080	OE	C-RES,U 47K-1/16W J	USM	CX-SNAJ300
X	P-SUPPLY/PWB/FAN	R 0072	88-108-473-080	OE	C-RES,U 47K-1/16W J	USM	CX-SNAJ305
X	P-SUPPLY/PWB/FAN	R 0073	88-128-470-080		C-RES, 47-1/8W J	USM	CX-SNAJ305
X	P-SUPPLY/PWB/FAN	R 0073	88-128-470-080		C-RES, 47-1/8W J	EZSM	CX-NSZ300
X	P-SUPPLY/PWB/FAN	R 0073	88-128-470-080	OE	C-RES, 47-1/8W J	USM	CX-SNAJ300
X	P-SUPPLY/PWB/FAN	R 0073	88-128-470-080	OE	C-RES, 47-1/8W J	USM	CX-SNAJ305
X	P-SUPPLY/PWB/FAN	R 0073	88-128-560-080		C-RES, 56-1/8W J	LHSM	CX-NSZ300
X	P-SUPPLY/PWB/FAN	R 0073	88-128-560-080	OE	C-RES, 56-1/8W J	LHSM	CX-NSZ300
X	P-SUPPLY/PWB/FAN	R 0073	88-129-000-080		C-JUMPER, 3216	USM	CX-SNAJ300
X	P-SUPPLY/PWB/FAN	R 0074	88-128-470-080		C-RES, 47-1/8W J	USM	CX-SNAJ305
X	P-SUPPLY/PWB/FAN	R 0074	88-128-470-080		C-RES, 47-1/8W J	EZSM	CX-SNAJ300
X	P-SUPPLY/PWB/FAN	R 0074	88-128-470-080	OE	C-RES, 47-1/8W J	USM	CX-SNAJ300
X	P-SUPPLY/PWB/FAN	R 0074	88-128-470-080	OE	C-RES, 47-1/8W J	USM	CX-SNAJ305
X	P-SUPPLY/PWB/FAN	R 0074	88-128-560-080		C-RES, 56-1/8W J	LHSM	CX-NSZ300
X	P-SUPPLY/PWB/FAN	R 0074	88-128-560-080	OE	C-RES, 56-1/8W J	LHSM	CX-NSZ300
X	P-SUPPLY/PWB/FAN	R 0074	88-129-000-080		C-JUMPER, 3216	USM	CX-SNAJ300
X	P-SUPPLY/PWB/FAN	R 0076	88-108-562-080		C-RES,U 5.6K-1/16W J	LHSM	CX-NSZ300
X	P-SUPPLY/PWB/FAN	R 0076	88-108-562-080		C-RES,U 5.6K-1/16W J	USM	CX-SNAJ300
X	P-SUPPLY/PWB/FAN	R 0076	88-108-562-080		C-RES,U 5.6K-1/16W J	EZSM	CX-NSZ300
X	P-SUPPLY/PWB/FAN	R 0076	88-108-562-080	OE	C-RES,U 5.6K-1/16W J	LHSM	CX-NSZ300
X	P-SUPPLY/PWB/FAN	R 0076	88-108-562-080	OE	C-RES,U 5.6K-1/16W J	USM	CX-SNAJ300
X	P-SUPPLY/PWB/FAN	R 0076	88-108-562-080	OE	C-RES,U 5.6K-1/16W J	USM	CX-SNAJ305
X	P-SUPPLY/PWB/FAN	R 0078	88-108-393-080		C-RES,U 39K-1/16W J	LHSM	CX-NSZ300
X	P-SUPPLY/PWB/FAN	R 0078	88-108-393-080		C-RES,U 39K-1/16W J	USM	CX-SNAJ300
X	P-SUPPLY/PWB/FAN	R 0078	88-108-393-080		C-RES,U 39K-1/16W J	USM	CX-SNAJ305
X	P-SUPPLY/PWB/FAN	R 0078	88-108-393-080		C-RES,U 39K-1/16W J	EZSM	CX-NSZ300
X	P-SUPPLY/PWB/FAN	R 0078	88-108-393-080	OE	C-RES,U 39K-1/16W J	LHSM	CX-NSZ300
X	P-SUPPLY/PWB/FAN	R 0078	88-108-393-080	OE	C-RES,U 39K-1/16W J	USM	CX-SNAJ300
X	P-SUPPLY/PWB/FAN	R 0079	88-108-153-080		C-RES,U 15K-1/16W J	USM	CX-SNAJ300
X	P-SUPPLY/PWB/FAN	R 0079	88-108-223-080		C-RES,U 22K-1/16W J	LHSM	CX-NSZ300
X	P-SUPPLY/PWB/FAN	R 0079	88-108-223-080		C-RES,U 22K-1/16W J	EZSM	CX-NSZ300
X	P-SUPPLY/PWB/FAN	R 0079	88-108-223-080	OE	C-RES,U 22K-1/16W J	LHSM	CX-NSZ300
X	P-SUPPLY/PWB/FAN	R 0079	88-108-273-080	OE	C-RES,U 27K-1/16W J	USM	CX-SNAJ300
X	P-SUPPLY/PWB/FAN	R 0079	88-108-333-080		C-RES,U 33K-1/16W J	USM	CX-SNAJ305
X	P-SUPPLY/PWB/FAN	R 0079	88-108-333-080	OE	C-RES,U 33K-1/16W J	USM	CX-SNAJ305
X	P-SUPPLY/PWB/FAN	R 0081	88-108-101-080		C-RES,U 100-1/16W J	EZSM	CX-NSZ300
X	P-SUPPLY/PWB/FAN	R 0081	88-108-101-080	OE	C-RES,U 100-1/16W J	LHSM	CX-NSZ300
X	P-SUPPLY/PWB/FAN	R 0081	88-108-101-080	OE	C-RES,U 100-1/16W J	USM	CX-SNAJ300
X	P-SUPPLY/PWB/FAN	R 0081	88-108-101-080	OE	C-RES,U 100-1/16W J	USM	CX-SNAJ305
X	P-SUPPLY/PWB/FAN	R 0085	88-108-103-080		C-RES,U 10K-1/16W J	LHSM	CX-NSZ300
X	P-SUPPLY/PWB/FAN	R 0085	88-108-103-080		C-RES,U 10K-1/16W J	USM	CX-SNAJ300
X	P-SUPPLY/PWB/FAN	R 0085	88-108-103-080		C-RES,U 10K-1/16W J	USM	CX-SNAJ305
X	P-SUPPLY/PWB/FAN	R 0085	88-108-103-080		C-RES,U 10K-1/16W J	EZSM	CX-NSZ300
X	P-SUPPLY/PWB/FAN	R 0085	88-108-103-080	OE	C-RES,U 10K-1/16W J	LHSM	CX-NSZ300
X	P-SUPPLY/PWB/FAN	R 0085	88-108-103-080	OE	C-RES,U 10K-1/16W J	USM	CX-SNAJ300
X	P-SUPPLY/PWB/FAN	R 0086	88-108-334-080		C-RES,U 330K-1/16W J	EZSM	CX-NSZ300
X	P-SUPPLY/PWB/FAN	R 0086	88-108-394-080		C-RES,U 390K-1/16W J	USM	CX-SNAJ305
X	P-SUPPLY/PWB/FAN	R 0086	88-108-394-080	OE	C-RES,U 390K-1/16W J	USM	CX-SNAJ305
X	P-SUPPLY/PWB/FAN	R 0086	88-108-474-080		C-RES,U 470K-1/16W J	USM	CX-SNAJ300
X	P-SUPPLY/PWB/FAN	R 0086	88-108-474-080	OE	C-RES,U 470K-1/16W J	USM	CX-SNAJ300
X	P-SUPPLY/PWB/FAN	R 0086	88-108-564-080		C-RES,U 560K-1/16W J	LHSM	CX-NSZ300
X	P-SUPPLY/PWB/FAN	R 0086	88-108-564-080	OE	C-RES,U 560K-1/16W J	LHSM	CX-NSZ300
X	P-SUPPLY/PWB/FAN	R 0093	88-108-683-080		C-RES,U 68K-1/16W J	EZSM	CX-NSZ300
X	P-SUPPLY/PWB/FAN	R 0093	88-108-823-080		C-RES,U 82K-1/16W J	LHSM	CX-NSZ300
X	P-SUPPLY/PWB/FAN	R 0093	88-108-823-080		C-RES,U 82K-1/16W J	USM	CX-SNAJ300
X	P-SUPPLY/PWB/FAN	R 0093	88-108-823-080	OE	C-RES,U 82K-1/16W J	LHSM	CX-NSZ300
X	P-SUPPLY/PWB/FAN	R 0093	88-108-823-080	OE	C-RES,U 82K-1/16W J	USM	CX-SNAJ300
X	P-SUPPLY/PWB/FAN	R 0093	88-108-823-080	OE	C-RES,U 82K-1/16W J	USM	CX-SNAJ305
X	P-SUPPLY/PWB/FAN	R 0094	88-108-393-080		C-RES,U 39K-1/16W J	LHSM	CX-NSZ300
X	P-SUPPLY/PWB/FAN	R 0094	88-108-393-080		C-RES,U 39K-1/16W J	USM	CX-SNAJ300
X	P-SUPPLY/PWB/FAN	R 0094	88-108-393-080		C-RES,U 39K-1/16W J	USM	CX-SNAJ305
X	P-SUPPLY/PWB/FAN	R 0094	88-108-393-080		C-RES,U 39K-1/16W J	EZSM	CX-NSZ300
X	P-SUPPLY/PWB/FAN	R 0094	88-108-393-080	OE	C-RES,U 39K-1/16W J	LHSM	CX-NSZ300

PARTS LIST

! = Δ SAFTY PARTS
 C = Components marked

All components used on this model at the production line are shown in this service manual.

However, please note that not all components will be available as spare parts for after-sales service.

Components marked S and O are designated as spare parts for service and will be stocked at the spare parts centers.

Components marked X and R are not designated as spare parts for after sales service, and will not be stocked at the spare parts centers.

K NO. = Only use japanese.

! C	UNIT NAME	REF NO.	PARTS CODE	K NO.	DESCRIPTION	SUFFIX	MODEL NAME
X	P-SUPPLY/PWB/FAN	R 0094	88-108-393-080	0E	C-RES,U 39K-1/16W J	USM	CX-SNAJ300
X	P-SUPPLY/PWB/FAN	R 0094	88-108-393-080	0E	C-RES,U 39K-1/16W J	USM	CX-SNAJ305
X	P-SUPPLY/PWB/FAN	R 0095	88-108-153-080		C-RES,U 15K-1/16W J	USM	CX-SNAJ300
X	P-SUPPLY/PWB/FAN	R 0095	88-108-223-080		C-RES,U 22K-1/16W J	LHSM	CX-NSZ300
X	P-SUPPLY/PWB/FAN	R 0095	88-108-223-080		C-RES,U 22K-1/16W J	EZSM	CX-NSZ300
X	P-SUPPLY/PWB/FAN	R 0095	88-108-223-080	0E	C-RES,U 22K-1/16W J	LHSM	CX-NSZ300
X	P-SUPPLY/PWB/FAN	R 0095	88-108-273-080	0E	C-RES,U 27K-1/16W J	USM	CX-SNAJ300
X	P-SUPPLY/PWB/FAN	R 0095	88-108-333-080		C-RES,U 33K-1/16W J	USM	CX-SNAJ305
X	P-SUPPLY/PWB/FAN	R 0095	88-108-333-080	0E	C-RES,U 33K-1/16W J	USM	CX-SNAJ305
X	P-SUPPLY/PWB/FAN	R 0096	88-108-683-080		C-RES,U 68K-1/16W J	EZSM	CX-NSZ300
X	P-SUPPLY/PWB/FAN	R 0096	88-108-823-080		C-RES,U 82K-1/16W J	LHSM	CX-NSZ300
X	P-SUPPLY/PWB/FAN	R 0096	88-108-823-080		C-RES,U 82K-1/16W J	USM	CX-SNAJ300
X	P-SUPPLY/PWB/FAN	R 0096	88-108-823-080		C-RES,U 82K-1/16W J	USM	CX-SNAJ305
X	P-SUPPLY/PWB/FAN	R 0096	88-108-823-080	0E	C-RES,U 82K-1/16W J	LHSM	CX-NSZ300
X	P-SUPPLY/PWB/FAN	R 0096	88-108-823-080	0E	C-RES,U 82K-1/16W J	USM	CX-SNAJ300
X	P-SUPPLY/PWB/FAN	R 0096	88-108-823-080	0E	C-RES,U 82K-1/16W J	USM	CX-SNAJ305
X	P-SUPPLY/PWB/FAN	R 0098	88-128-129-080		C-RES, 1.2-1/8W J	USM	CX-SNAJ300
X	P-SUPPLY/PWB/FAN	R 0098	88-128-129-080		C-RES, 1.2-1/8W J	USM	CX-SNAJ305
X	P-SUPPLY/PWB/FAN	R 0098	88-128-129-080	0E	C-RES, 1.2-1/8W J	USM	CX-SNAJ300
X	P-SUPPLY/PWB/FAN	R 0098	88-128-129-080	0E	C-RES, 1.2-1/8W J	USM	CX-SNAJ305
X	P-SUPPLY/PWB/FAN	R 0099	88-128-129-080		C-RES, 1.2-1/8W J	USM	CX-SNAJ300
X	P-SUPPLY/PWB/FAN	R 0099	88-128-129-080		C-RES, 1.2-1/8W J	USM	CX-SNAJ305
X	P-SUPPLY/PWB/FAN	R 0099	88-128-129-080	0E	C-RES, 1.2-1/8W J	USM	CX-SNAJ300
X	P-SUPPLY/PWB/FAN	R 0099	88-128-129-080	0E	C-RES, 1.2-1/8W J	USM	CX-SNAJ305
X	P-SUPPLY/PWB/FAN	R 0099	88-128-129-080		F-CABLE,9P 2.5 480MM	USM	CX-SNAJ300
X	P-SUPPLY/PWB/FAN	R 0099	88-128-129-080		F-CABLE,9P 2.5 480MM	USM	CX-SNAJ305
X	P-SUPPLY/PWB/FAN	R 0099	88-128-129-080	0E	C-RES, 1.2-1/8W J	USM	CX-SNAJ300
X	P-SUPPLY/PWB/FAN	R 0099	88-128-129-080	0E	C-RES, 1.2-1/8W J	USM	CX-SNAJ305
O	P-SUPPLY/PWB/FAN	W 0099	8A-NF9-609-010		F-CABLE,9P 2.5 480MM	USM	CX-SNAJ300
O	P-SUPPLY/PWB/FAN	W 0099	8A-NF9-609-010		F-CABLE,9P 2.5 480MM	USM	CX-SNAJ305
O	P-SUPPLY/PWB/FAN	W 0099	8A-NF9-609-010	1A	F-CABLE,9P 2.5 480MM	EZSM	CX-NSZ300
O	P-SUPPLY/PWB/FAN	W 0099	8A-NF9-609-010	1A	F-CABLE,9P 2.5 480MM	USM	CX-SNAJ300
O	P-SUPPLY/PWB/FAN	W 0099	8A-NF9-609-010	1A	F-CABLE,9P 2.5 480MM	USM	CX-SNAJ305
O	P-SUPPLY/PWB/FAN	WH 0001	87-A90-510-010		HLDR,WIRE 2.5-9P	LHSM	CX-NSZ300
O	P-SUPPLY/PWB/FAN	WH 0001	87-A90-510-010		HLDR,WIRE 2.5-9P	USM	CX-SNAJ300
O	P-SUPPLY/PWB/FAN	WH 0001	87-A90-510-010		HLDR,WIRE 2.5-9P	USM	CX-SNAJ305
!	O P-SUPPLY/PWB/FAN	WH 0001	87-A90-510-010	0E	HLDR,WIRE 2.5-9P	EZSM	CX-NSZ300
!	O P-SUPPLY/PWB/FAN	WH 0001	87-A90-510-010	0E	HLDR,WIRE 2.5-9P	LHSM	CX-NSZ300
!	O P-SUPPLY/PWB/FAN	WH 0001	87-A90-510-010	0E	HLDR,WIRE 2.5-9P	USM	CX-SNAJ300
!	O P-SUPPLY/PWB/FAN	WH 0001	87-A90-510-010	0E	HLDR,WIRE 2.5-9P	USM	CX-SNAJ305
X	PACKING		86-NFA-860-010		PAD,BOX	EZSM	CX-NSZ300
X	PACKING		86-NFA-860-010	0E	PAD,BOX	USM	CX-SNAJ300
X	PACKING		86-NFA-860-010	0E	PAD,BOX	USM	CX-SNAJ305
X	PACKING		87-B40-057-010		BAG,PP 0.03-150-200	EZSM	CX-NSZ300
X	PACKING		87-B40-098-010		BAG,PV 0.025-650-750 PL	EZSM	CX-NSZ300
X	PACKING		87-B40-098-010	0E	BAG,PV 0.025-650-750 PL	USM	CX-SNAJ300
X	PACKING		87-B40-098-010	0E	BAG,PV 0.025-650-750 PL	USM	CX-SNAJ305
G X	PACKING		87-B40-098-010		BAG,PV 0.025-650-750 PL	LHSM	CX-NSZ300
G X	PACKING		87-B40-098-010		BAG,PV 0.025-650-750 PL	USM	CX-SNAJ300
G X	PACKING		87-B40-098-010		BAG,PV 0.025-650-750 PL	USM	CX-SNAJ305
X	PACKING		8B-NF9-859-010		CUSHION,FRONT USM	EZSM	CX-NSZ300
X	PACKING		8B-NF9-859-010	1A	CUSHION,FRONT USM	USM	CX-SNAJ300
X	PACKING		8B-NF9-859-010	1A	CUSHION,FRONT USM	USM	CX-SNAJ305
G X	PACKING		8B-NF9-859-010		CUSHION,FRONT USM	USM	CX-SNAJ300
G X	PACKING		8B-NF9-859-010		CUSHION,FRONT USM	USM	CX-SNAJ305
X	PACKING		8B-NF9-860-010		CUSHION,REAR USM	EZSM	CX-NSZ300
X	PACKING		8B-NF9-860-010	1A	CUSHION,REAR USM	USM	CX-SNAJ300
X	PACKING		8B-NF9-860-010	1A	CUSHION,REAR USM	USM	CX-SNAJ305
G X	PACKING		8B-NF9-860-010		CUSHION,REAR USM	USM	CX-SNAJ300
G X	PACKING		8B-NF9-860-010		CUSHION,REAR USM	USM	CX-SNAJ305
G X	PACKING		8B-NF9-863-010		CUSHION,FRONT LHSM	LHSM	CX-NSZ300
G X	PACKING		8B-NF9-864-010		CUSHION,REAR LHSM	LHSM	CX-NSZ300
G X	PACKING		8B-NF9-865-010		CTN,PRINTED LHSM	LHSM	CX-NSZ300
X	PACKING		8B-NF9-866-010		CTN,PRINTED EZSM	EZSM	CX-NSZ300
X	PACKING		93-704-337-010		SH,FOAMED-MAT 0.31-800-500	EZSM	CX-NSZ300
X	PACKING		93-704-337-010	1A	SH,FOAMED-MAT 0.31-800-500	USM	CX-SNAJ300
X	PACKING		93-704-337-010	1A	SH,FOAMED-MAT 0.31-800-500	USM	CX-SNAJ305
G X	PACKING		93-704-337-010		SH,FOAMED-MAT 0.31-800-500	LHSM	CX-NSZ300
G X	PACKING		93-704-337-010		SH,FOAMED-MAT 0.31-800-500	USM	CX-SNAJ300
G X	PACKING		93-704-337-010		SH,FOAMED-MAT 0.31-800-500	USM	CX-SNAJ305
X	PLATE		84-711-909-010		LBL DATE CODE	USM	CX-SNAJ300
X	PLATE		84-711-909-010		LBL DATE CODE	USM	CX-SNAJ305
X	PLATE		84-711-909-010	1A	LBL DATE CODE	USM	CX-SNAJ300
X	PLATE		84-711-909-010	1A	LBL DATE CODE	USM	CX-SNAJ305

PARTS LIST

! = Δ SAFTY PARTS
 C = Components marked

All components used on this model at the production line are shown in this service manual.

However, please note that not all components will be available as spare parts for after-sales service.

Components marked S and O are designated as spare parts for service and will be stocked at the spare parts centers.

Components marked X and R are not designated as spare parts for after sales service, and will not be stocked at the spare parts centers.

K NO. = Only use japanese.

! C	UNIT NAME	REF NO.	PARTS CODE	K NO.	DESCRIPTION	SUFFIX	MODEL NAME	
X	PLATE		87-057-961-010		LBL, CAUTION TRIANGLE	LHSM	CX-NSZ300	
!	X PLATE		87-057-961-010		LBL, CAUTION TRIANGLE	EZSM	CX-NSZ300	
!	X PLATE		87-057-961-010	0E	LBL, CAUTION TRIANGLE	LHSM	CX-NSZ300	
X	PLATE		87-057-995-010		LBL, CAUTION EFSO	LHSM	CX-NSZ300	
!	X PLATE		87-057-995-010		LBL, CAUTION EFSO	EZSM	CX-NSZ300	
!	X PLATE		87-057-995-010	0E	LBL, CAUTION EFSO	LHSM	CX-NSZ300	
X	PLATE		87-B40-016-010	0E	BAG, PP (BAR-CODE)	USM	CX-SNAJ300	
X	PLATE		87-B40-016-010	0E	BAG, PP (BAR-CODE)	USM	CX-SNAJ305	
X	PLATE		87-B40-281-010		LBL, BAR-CODE A 35X8	EZSM	CX-NSZ300	
X	PLATE		87-B40-281-010	0E	LBL, BAR-CODE A 35X8	LHSM	CX-NSZ300	
G X	PLATE		87-B40-281-010		LBL, BAR-CODE A 35X8	LHSM	CX-NSZ300	
X	PLATE		87-B40-282-010	0E	LBL, BAR-CODE AU 35X8	USM	CX-SNAJ300	
X	PLATE		87-B40-282-010	0E	LBL, BAR-CODE AU 35X8	USM	CX-SNAJ305	
G X	PLATE		87-B40-282-010		LBL, BAR-CODE AU 35X8	USM	CX-SNAJ300	
G X	PLATE		87-B40-282-010		LBL, BAR-CODE AU 35X8	USM	CX-SNAJ305	
O	PLATE		8B-NF9-008-010		WINDOW, CASS 1	LHSM	CX-NSZ300	
O	PLATE		8B-NF9-008-010		WINDOW, CASS 1	EZSM	CX-NSZ300	
O	PLATE		8B-NF9-008-010	0E	WINDOW, CASS 1	LHSM	CX-NSZ300	
O	PLATE		8B-NF9-008-010	0E	WINDOW, CASS 1	USM	CX-SNAJ300	
O	PLATE		8B-NF9-008-010	0E	WINDOW, CASS 1	USM	CX-SNAJ305	
O	PLATE		8B-NF9-009-010		WINDOW, CASS 2	LHSM	CX-NSZ300	
O	PLATE		8B-NF9-009-010		WINDOW, CASS 2	EZSM	CX-NSZ300	
O	PLATE		8B-NF9-009-010	0E	WINDOW, CASS 2	LHSM	CX-NSZ300	
O	PLATE		8B-NF9-009-010	0E	WINDOW, CASS 2	USM	CX-SNAJ300	
O	PLATE		8B-NF9-009-010	0E	WINDOW, CASS 2	USM	CX-SNAJ305	
O	PLATE		8B-NF9-010-010		WINDOW, DISP U	USM	CX-SNAJ300	
O	PLATE		8B-NF9-010-010	1A	WINDOW, DISP U	USM	CX-SNAJ300	
O	PLATE		8B-NF9-021-010		REFLECTOR, ECO	LHSM	CX-NSZ300	
O	PLATE		8B-NF9-021-010		REFLECTOR, ECO	USM	CX-SNAJ300	
O	PLATE		8B-NF9-021-010		REFLECTOR, ECO	USM	CX-SNAJ305	
O	PLATE		8B-NF9-021-010	0E	REFLECTOR, ECO	LHSM	CX-NSZ300	
O	PLATE		8B-NF9-021-010	0E	REFLECTOR, ECO	USM	CX-SNAJ305	
O	PLATE		8B-NF9-035-010		WINDOW, DISP H	LHSM	CX-NSZ300	
O	PLATE		8B-NF9-035-010		WINDOW, DISP H	EZSM	CX-NSZ300	
O	PLATE		8B-NF9-035-010	1A	WINDOW, DISP H	LHSM	CX-NSZ300	
O	PLATE		8B-NF9-037-010		WINDOW, DISP U 305	USM	CX-SNAJ305	
O	PLATE		8B-NF9-037-010	1A	WINDOW, DISP U 305	USM	CX-SNAJ305	
	PLATE		8B-NF9-042-010		WINDOW, CASS 1 U	USM	CX-SNAJ300	
	PLATE		8B-NF9-043-010		WINDOW, CASS 2 U	USM	CX-SNAJ300	
	PLATE		8B-NF9-043-010		WINDOW, CASS 2 U	USM	CX-SNAJ305	
O	POWER AMP	C	0101		87-012-278-080	C-CAP, U 2200P-50 K B	EZSM	CX-NSZ300
O	POWER AMP	C	0101		87-012-279-080	C-CAP, U 2700P-50 K B GRM	LHSM	CX-NSZ300
O	POWER AMP	C	0101		87-012-279-080	C-CAP, U 2700P-50 K B GRM	USM	CX-SNAJ300
O	POWER AMP	C	0101		87-012-279-080	C-CAP, U 2700P-50 K B GRM	USM	CX-SNAJ305
O	POWER AMP	C	0101		87-012-279-080	0E C-CAP, U 2700P-50 K B GRM	LHSM	CX-NSZ300
O	POWER AMP	C	0101		87-012-279-080	0E C-CAP, U 2700P-50 K B GRM	USM	CX-SNAJ300
O	POWER AMP	C	0101		87-012-279-080	0E C-CAP, U 2700P-50 K B GRM	USM	CX-SNAJ305
O	POWER AMP	C	0102		87-012-278-080	C-CAP, U 2200P-50 K B	EZSM	CX-NSZ300
O	POWER AMP	C	0102		87-012-279-080	C-CAP, U 2700P-50 K B GRM	LHSM	CX-NSZ300
O	POWER AMP	C	0102		87-012-279-080	C-CAP, U 2700P-50 K B GRM	USM	CX-SNAJ300
O	POWER AMP	C	0102		87-012-279-080	C-CAP, U 2700P-50 K B GRM	USM	CX-SNAJ305
O	POWER AMP	C	0102		87-012-279-080	0E C-CAP, U 2700P-50 K B GRM	LHSM	CX-NSZ300
O	POWER AMP	C	0102		87-012-279-080	0E C-CAP, U 2700P-50 K B GRM	USM	CX-SNAJ300
O	POWER AMP	C	0102		87-012-279-080	0E C-CAP, U 2700P-50 K B GRM	USM	CX-SNAJ305
O	POWER AMP	C	0103		87-A12-084-080	CAP, E 0.22-50 SMG	LHSM	CX-NSZ300
O	POWER AMP	C	0103		87-A12-084-080	CAP, E 0.22-50 SMG	USM	CX-SNAJ300
O	POWER AMP	C	0103		87-A12-084-080	CAP, E 0.22-50 SMG	USM	CX-SNAJ305
O	POWER AMP	C	0103		87-A12-084-080	CAP, E 0.22-50 SMG	EZSM	CX-NSZ300
O	POWER AMP	C	0103		87-A12-084-080	0E CAP, E 0.22-50 SMG	LHSM	CX-NSZ300
O	POWER AMP	C	0103		87-A12-084-080	0E CAP, E 0.22-50 SMG	USM	CX-SNAJ300
O	POWER AMP	C	0103		87-A12-084-080	0E CAP, E 0.22-50 SMG	USM	CX-SNAJ305
O	POWER AMP	C	0104		87-A12-084-080	CAP, E 0.22-50 SMG	LHSM	CX-NSZ300
O	POWER AMP	C	0104		87-A12-084-080	CAP, E 0.22-50 SMG	USM	CX-SNAJ300
O	POWER AMP	C	0104		87-A12-084-080	CAP, E 0.22-50 SMG	USM	CX-SNAJ305
O	POWER AMP	C	0104		87-A12-084-080	CAP, E 0.22-50 SMG	EZSM	CX-NSZ300
O	POWER AMP	C	0104		87-A12-084-080	0E CAP, E 0.22-50 SMG	LHSM	CX-NSZ300
O	POWER AMP	C	0104		87-A12-084-080	0E CAP, E 0.22-50 SMG	USM	CX-SNAJ300

PARTS LIST

! = Δ SAFTY PARTS
 C = Components marked

All components used on this model at the production line are shown in this service manual.

However, please note that not all components will be available as spare parts for after-sales service.

Components marked S and O are designated as spare parts for service and will be stocked at the spare parts centers.

Components marked X and R are not designated as spare parts for after sales service, and will not be stocked at the spare parts centers.

K NO. = Only use japanese.

! C	UNIT NAME	REF NO.	PARTS CODE	K NO.	DESCRIPTION	SUFFIX	MODEL NAME
O	POWER AMP	C	0104 87-A12-084-080	OE	CAP,E 0.22-50 SMG	USM	CX-SNAJ305
O	POWER AMP	C	0105 87-012-277-080		C-CAP,U 1800P-50 K B GRM	LHSM	CX-NSZ300
O	POWER AMP	C	0105 87-012-277-080		C-CAP,U 1800P-50 K B GRM	USM	CX-SNAJ300
O	POWER AMP	C	0105 87-012-277-080		C-CAP,U 1800P-50 K B GRM	USM	CX-SNAJ305
O	POWER AMP	C	0105 87-012-277-080		C-CAP,U 1800P-50 K B GRM	EZSM	CX-NSZ300
O	POWER AMP	C	0105 87-012-277-080	OE	C-CAP,U 1800P-50 K B GRM	LHSM	CX-NSZ300
O	POWER AMP	C	0105 87-012-277-080	OE	C-CAP,U 1800P-50 K B GRM	USM	CX-SNAJ300
O	POWER AMP	C	0105 87-012-277-080	OE	C-CAP,U 1800P-50 K B GRM	USM	CX-SNAJ305
O	POWER AMP	C	0106 87-012-277-080		C-CAP,U 1800P-50 K B GRM	LHSM	CX-NSZ300
O	POWER AMP	C	0106 87-012-277-080		C-CAP,U 1800P-50 K B GRM	USM	CX-SNAJ300
O	POWER AMP	C	0106 87-012-277-080		C-CAP,U 1800P-50 K B GRM	USM	CX-SNAJ305
O	POWER AMP	C	0106 87-012-277-080		C-CAP,U 1800P-50 K B GRM	EZSM	CX-NSZ300
O	POWER AMP	C	0106 87-012-277-080	OE	C-CAP,U 1800P-50 K B GRM	LHSM	CX-NSZ300
O	POWER AMP	C	0106 87-012-277-080	OE	C-CAP,U 1800P-50 K B GRM	USM	CX-SNAJ300
O	POWER AMP	C	0106 87-012-277-080	OE	C-CAP,U 1800P-50 K B GRM	USM	CX-SNAJ305
O	POWER AMP	C	0107 87-A12-089-080		CAP,E 3.3-50 SMG	LHSM	CX-NSZ300
O	POWER AMP	C	0107 87-A12-089-080		CAP,E 3.3-50 SMG	USM	CX-SNAJ300
O	POWER AMP	C	0107 87-A12-089-080		CAP,E 3.3-50 SMG	USM	CX-SNAJ305
O	POWER AMP	C	0107 87-A12-089-080		CAP,E 3.3-50 SMG	EZSM	CX-NSZ300
O	POWER AMP	C	0107 87-A12-089-080	OE	CAP,E 3.3-50 SMG	LHSM	CX-NSZ300
O	POWER AMP	C	0107 87-A12-089-080	OE	CAP,E 3.3-50 SMG	USM	CX-SNAJ300
O	POWER AMP	C	0107 87-A12-089-080	OE	CAP,E 3.3-50 SMG	USM	CX-SNAJ305
O	POWER AMP	C	0108 87-A12-089-080		CAP,E 3.3-50 SMG	LHSM	CX-NSZ300
O	POWER AMP	C	0108 87-A12-089-080		CAP,E 3.3-50 SMG	USM	CX-SNAJ300
O	POWER AMP	C	0108 87-A12-089-080		CAP,E 3.3-50 SMG	USM	CX-SNAJ305
O	POWER AMP	C	0108 87-A12-089-080		CAP,E 3.3-50 SMG	EZSM	CX-NSZ300
O	POWER AMP	C	0108 87-A12-089-080	OE	CAP,E 3.3-50 SMG	LHSM	CX-NSZ300
O	POWER AMP	C	0108 87-A12-089-080	OE	CAP,E 3.3-50 SMG	USM	CX-SNAJ300
O	POWER AMP	C	0108 87-A12-089-080	OE	CAP,E 3.3-50 SMG	USM	CX-SNAJ305
O	POWER AMP	C	0109 87-012-195-080		C-CAP,U 100P-50 J CH	EZSM	CX-NSZ300
O	POWER AMP	C	0110 87-012-195-080		C-CAP,U 100P-50 J CH	EZSM	CX-NSZ300
O	POWER AMP	C	0111 87-A12-077-080		CAP,E 33-35 SMG	LHSM	CX-NSZ300
O	POWER AMP	C	0111 87-A12-077-080		CAP,E 33-35 SMG	USM	CX-SNAJ300
O	POWER AMP	C	0111 87-A12-077-080		CAP,E 33-35 SMG	USM	CX-SNAJ305
O	POWER AMP	C	0111 87-A12-077-080		CAP,E 33-35 SMG	EZSM	CX-NSZ300
O	POWER AMP	C	0111 87-A12-077-080	OE	CAP,E 33-35 SMG	LHSM	CX-NSZ300
O	POWER AMP	C	0111 87-A12-077-080	OE	CAP,E 33-35 SMG	USM	CX-SNAJ300
O	POWER AMP	C	0111 87-A12-077-080	OE	CAP,E 33-35 SMG	USM	CX-SNAJ305
O	POWER AMP	C	0112 87-A12-077-080		CAP,E 33-35 SMG	LHSM	CX-NSZ300
O	POWER AMP	C	0112 87-A12-077-080		CAP,E 33-35 SMG	USM	CX-SNAJ300
O	POWER AMP	C	0112 87-A12-077-080		CAP,E 33-35 SMG	USM	CX-SNAJ305
O	POWER AMP	C	0112 87-A12-077-080	OE	CAP,E 33-35 SMG	LHSM	CX-NSZ300
O	POWER AMP	C	0112 87-A12-077-080	OE	CAP,E 33-35 SMG	USM	CX-SNAJ300
O	POWER AMP	C	0112 87-A12-077-080	OE	CAP,E 33-35 SMG	USM	CX-SNAJ305
O	POWER AMP	C	0113 87-012-195-080		C-CAP,U 100P-50 J CH	EZSM	CX-NSZ300
O	POWER AMP	C	0113 87-012-195-080	OE	C-CAP,U 100P-50 J CH	USM	CX-SNAJ300
O	POWER AMP	C	0113 87-012-195-080	OE	C-CAP,U 100P-50 J CH	USM	CX-SNAJ305
O	POWER AMP	C	0113 87-A10-596-080	OE	C-CAP,S 100P-100 J CH	LHSM	CX-NSZ300
O	POWER AMP	C	0113 87-A10-812-080		C-CAP,S 220P-200 J CH	LHSM	CX-NSZ300
O	POWER AMP	C	0113 87-A10-812-080		C-CAP,S 220P-200 J CH	USM	CX-SNAJ300
O	POWER AMP	C	0113 87-A10-812-080		C-CAP,S 220P-200 J CH	USM	CX-SNAJ305
O	POWER AMP	C	0114 87-012-195-080		C-CAP,U 100P-50 J CH	EZSM	CX-NSZ300
O	POWER AMP	C	0114 87-012-195-080	OE	C-CAP,U 100P-50 J CH	USM	CX-SNAJ300
O	POWER AMP	C	0114 87-012-195-080	OE	C-CAP,U 100P-50 J CH	USM	CX-SNAJ305
O	POWER AMP	C	0114 87-A10-596-080	OE	C-CAP,S 100P-100 J CH	LHSM	CX-NSZ300
O	POWER AMP	C	0114 87-A10-812-080		C-CAP,S 220P-200 J CH	LHSM	CX-NSZ300
O	POWER AMP	C	0114 87-A10-812-080		C-CAP,S 220P-200 J CH	USM	CX-SNAJ300
O	POWER AMP	C	0114 87-A10-812-080		C-CAP,S 220P-200 J CH	USM	CX-SNAJ305
O	POWER AMP	C	0117 87-012-368-080		C-CAP,S 0.1-50 Z F	LHSM	CX-NSZ300
O	POWER AMP	C	0117 87-012-368-080		C-CAP,S 0.1-50 Z F	USM	CX-SNAJ300
O	POWER AMP	C	0117 87-012-368-080		C-CAP,S 0.1-50 Z F	USM	CX-SNAJ305
O	POWER AMP	C	0117 87-012-368-080		C-CAP,S 0.1-50 Z F	EZSM	CX-NSZ300
O	POWER AMP	C	0117 87-012-368-080	OE	C-CAP,S 0.1-50 Z F	LHSM	CX-NSZ300
O	POWER AMP	C	0117 87-012-368-080	OE	C-CAP,S 0.1-50 Z F	USM	CX-SNAJ300
O	POWER AMP	C	0117 87-012-368-080	OE	C-CAP,S 0.1-50 Z F	USM	CX-SNAJ305
O	POWER AMP	C	0118 87-012-368-080		C-CAP,S 0.1-50 Z F	LHSM	CX-NSZ300
O	POWER AMP	C	0118 87-012-368-080		C-CAP,S 0.1-50 Z F	USM	CX-SNAJ300
O	POWER AMP	C	0118 87-012-368-080		C-CAP,S 0.1-50 Z F	USM	CX-SNAJ305
O	POWER AMP	C	0118 87-012-368-080		C-CAP,S 0.1-50 Z F	EZSM	CX-NSZ300

PARTS LIST

! = Δ SAFTY PARTS
 C = Components marked

All components used on this model at the production line are shown in this service manual.

However, please note that not all components will be available as spare parts for after-sales service.

Components marked S and O are designated as spare parts for service and will be stocked at the spare parts centers.

Components marked X and R are not designated as spare parts for after sales service, and will not be stocked at the spare parts centers.

K NO. = Only use japanese.

! C	UNIT NAME	REF NO.	PARTS CODE	K NO.	DESCRIPTION	SUFFIX	MODEL NAME
O	POWER AMP	C	0118 87-012-368-080	0E	C-CAP,S 0.1-50 Z F	LHSM	CX-NSZ300
O	POWER AMP	C	0118 87-012-368-080	0E	C-CAP,S 0.1-50 Z F	USM	CX-SNAJ300
O	POWER AMP	C	0118 87-012-368-080	0E	C-CAP,S 0.1-50 Z F	USM	CX-SNAJ305
O	POWER AMP	C	0119 87-012-286-080		C-CAP,U 0.01-25 K B	LHSM	CX-NSZ300
O	POWER AMP	C	0119 87-012-286-080		C-CAP,U 0.01-25 K B	USM	CX-SNAJ300
O	POWER AMP	C	0119 87-012-286-080		C-CAP,U 0.01-25 K B	USM	CX-SNAJ305
O	POWER AMP	C	0119 87-012-286-080		C-CAP,U 0.01-25 K B	EZSM	CX-NSZ300
O	POWER AMP	C	0119 87-012-286-080	0E	C-CAP,U 0.01-25 K B	LHSM	CX-NSZ300
O	POWER AMP	C	0119 87-012-286-080	0E	C-CAP,U 0.01-25 K B	USM	CX-SNAJ300
O	POWER AMP	C	0119 87-012-286-080	0E	C-CAP,U 0.01-25 K B	USM	CX-SNAJ305
O	POWER AMP	C	0120 87-012-286-080		C-CAP,U 0.01-25 K B	LHSM	CX-NSZ300
O	POWER AMP	C	0120 87-012-286-080		C-CAP,U 0.01-25 K B	USM	CX-SNAJ300
O	POWER AMP	C	0120 87-012-286-080		C-CAP,U 0.01-25 K B	USM	CX-SNAJ305
O	POWER AMP	C	0120 87-012-286-080		C-CAP,U 0.01-25 K B	EZSM	CX-NSZ300
O	POWER AMP	C	0120 87-012-286-080	0E	C-CAP,U 0.01-25 K B	LHSM	CX-NSZ300
O	POWER AMP	C	0120 87-012-286-080	0E	C-CAP,U 0.01-25 K B	USM	CX-SNAJ300
O	POWER AMP	C	0120 87-012-286-080	0E	C-CAP,U 0.01-25 K B	USM	CX-SNAJ305
O	POWER AMP	C	0123 87-010-177-080		C-CAP,S 820P-50 J SL C2012	EZSM	CX-NSZ300
O	POWER AMP	C	0123 87-010-177-080	0E	C-CAP,S 820P-50 J SL C2012	LHSM	CX-NSZ300
O	POWER AMP	C	0123 87-010-177-080	0E	C-CAP,S 820P-50 J SL C2012	USM	CX-SNAJ300
O	POWER AMP	C	0123 87-010-177-080	0E	C-CAP,S 820P-50 J SL C2012	USM	CX-SNAJ305
O	POWER AMP	C	0124 87-010-177-080		C-CAP,S 820P-50 J SL C2012	EZSM	CX-NSZ300
O	POWER AMP	C	0124 87-010-177-080	0E	C-CAP,S 820P-50 J SL C2012	LHSM	CX-NSZ300
O	POWER AMP	C	0124 87-010-177-080	0E	C-CAP,S 820P-50 J SL C2012	USM	CX-SNAJ300
O	POWER AMP	C	0124 87-010-177-080	0E	C-CAP,S 820P-50 J SL C2012	USM	CX-SNAJ305
O	POWER AMP	C	0133 87-012-282-080		C-CAP,U 4700P-50 K B	LHSM	CX-NSZ300
O	POWER AMP	C	0133 87-012-282-080		C-CAP,U 4700P-50 K B	USM	CX-SNAJ300
O	POWER AMP	C	0133 87-012-282-080		C-CAP,U 4700P-50 K B	USM	CX-SNAJ305
O	POWER AMP	C	0133 87-012-282-080		C-CAP,U 4700P-50 K B	EZSM	CX-NSZ300
O	POWER AMP	C	0133 87-012-282-080	0E	C-CAP,U 4700P-50 K B	LHSM	CX-NSZ300
O	POWER AMP	C	0133 87-012-282-080	0E	C-CAP,U 4700P-50 K B	USM	CX-SNAJ300
O	POWER AMP	C	0133 87-012-282-080	0E	C-CAP,U 4700P-50 K B	USM	CX-SNAJ305
O	POWER AMP	C	0186 87-010-759-080		C-CAP,U 0.1-25 Z F	LHSM	CX-NSZ300
O	POWER AMP	C	0186 87-010-759-080		C-CAP,U 0.1-25 Z F	USM	CX-SNAJ300
O	POWER AMP	C	0186 87-010-759-080		C-CAP,U 0.1-25 Z F	USM	CX-SNAJ305
O	POWER AMP	C	0186 87-010-759-080		C-CAP,U 0.1-25 Z F	EZSM	CX-NSZ300
O	POWER AMP	C	0186 87-010-759-080	0E	C-CAP,U 0.1-25 Z F	LHSM	CX-NSZ300
O	POWER AMP	C	0186 87-010-759-080	0E	C-CAP,U 0.1-25 Z F	USM	CX-SNAJ300
O	POWER AMP	C	0186 87-010-759-080	0E	C-CAP,U 0.1-25 Z F	USM	CX-SNAJ305
O	POWER AMP	C	0187 87-010-866-080		CAP,E 10-63 M VX	LHSM	CX-NSZ300
O	POWER AMP	C	0187 87-010-866-080		CAP,E 10-63 M VX	USM	CX-SNAJ300
O	POWER AMP	C	0187 87-010-866-080		CAP,E 10-63 M VX	USM	CX-SNAJ305
O	POWER AMP	C	0187 87-010-866-080	0E	CAP,E 10-63 M VX	LHSM	CX-NSZ300
O	POWER AMP	C	0187 87-010-866-080	0E	CAP,E 10-63 M VX	USM	CX-SNAJ300
O	POWER AMP	C	0187 87-010-866-080	0E	CAP,E 10-63 M VX	USM	CX-SNAJ305
O	POWER AMP	C	0187 87-A12-091-080		CAP,E 10-50 SMG	EZSM	CX-NSZ300
O	POWER AMP	C	0188 87-010-866-080		CAP,E 10-63 M VX	LHSM	CX-NSZ300
O	POWER AMP	C	0188 87-010-866-080		CAP,E 10-63 M VX	USM	CX-SNAJ300
O	POWER AMP	C	0188 87-010-866-080		CAP,E 10-63 M VX	USM	CX-SNAJ305
O	POWER AMP	C	0188 87-010-866-080	0E	CAP,E 10-63 M VX	LHSM	CX-NSZ300
O	POWER AMP	C	0188 87-010-866-080	0E	CAP,E 10-63 M VX	USM	CX-SNAJ300
O	POWER AMP	C	0188 87-010-866-080	0E	CAP,E 10-63 M VX	USM	CX-SNAJ305
O	POWER AMP	C	0188 87-A12-091-080		CAP,E 10-50 SMG	EZSM	CX-NSZ300
O	POWER AMP	C	0223 87-010-176-080		C-CAP,S 680P-50 J SL	EZSM	CX-NSZ300
O	POWER AMP	C	0224 87-010-176-080		C-CAP,S 680P-50 J SL	EZSM	CX-NSZ300
O	POWER AMP	C	0225 87-012-368-080		C-CAP,S 0.1-50 Z F	LHSM	CX-NSZ300
O	POWER AMP	C	0225 87-012-368-080		C-CAP,S 0.1-50 Z F	USM	CX-SNAJ300
O	POWER AMP	C	0225 87-012-368-080		C-CAP,S 0.1-50 Z F	USM	CX-SNAJ305
O	POWER AMP	C	0225 87-012-368-080		C-CAP,S 0.1-50 Z F	EZSM	CX-NSZ300
O	POWER AMP	C	0225 87-012-368-080	0E	C-CAP,S 0.1-50 Z F	LHSM	CX-NSZ300
O	POWER AMP	C	0225 87-012-368-080	0E	C-CAP,S 0.1-50 Z F	USM	CX-SNAJ300
O	POWER AMP	C	0225 87-012-368-080	0E	C-CAP,S 0.1-50 Z F	USM	CX-SNAJ305
O	POWER AMP	C	0225 87-012-368-080	0E	C-CAP,S 0.1-50 Z F	LHSM	CX-NSZ300

PARTS LIST

! = Δ SAFTY PARTS
 C = Components marked

All components used on this model at the production line are shown in this service manual.

However, please note that not all components will be available as spare parts for after-sales service.

Components marked S and O are designated as spare parts for service and will be stocked at the spare parts centers.

Components marked X and R are not designated as spare parts for after sales service, and will not be stocked at the spare parts centers.

K NO. = Only use japanese.

! C	UNIT NAME	REF NO.	PARTS CODE	K NO.	DESCRIPTION	SUFFIX	MODEL NAME
O	POWER AMP	C	0226 87-012-368-080		C-CAP,S 0.1-50 Z F	USM	CX-SNAJ300
O	POWER AMP	C	0226 87-012-368-080		C-CAP,S 0.1-50 Z F	USM	CX-SNAJ305
O	POWER AMP	C	0226 87-012-368-080		C-CAP,S 0.1-50 Z F	EZSM	CX-NSZ300
O	POWER AMP	C	0226 87-012-368-080	OE	C-CAP,S 0.1-50 Z F	LHSM	CX-NSZ300
O	POWER AMP	C	0226 87-012-368-080	OE	C-CAP,S 0.1-50 Z F	USM	CX-SNAJ300
O	POWER AMP	C	0226 87-012-368-080	OE	C-CAP,S 0.1-50 Z F	USM	CX-SNAJ305
O	POWER AMP	C	0227 87-012-368-080		C-CAP,S 0.1-50 Z F	LHSM	CX-NSZ300
O	POWER AMP	C	0227 87-012-368-080		C-CAP,S 0.1-50 Z F	USM	CX-SNAJ300
O	POWER AMP	C	0227 87-012-368-080		C-CAP,S 0.1-50 Z F	USM	CX-SNAJ305
O	POWER AMP	C	0227 87-012-368-080		C-CAP,S 0.1-50 Z F	EZSM	CX-NSZ300
O	POWER AMP	C	0227 87-012-368-080	OE	C-CAP,S 0.1-50 Z F	LHSM	CX-NSZ300
O	POWER AMP	C	0227 87-012-368-080	OE	C-CAP,S 0.1-50 Z F	USM	CX-SNAJ300
O	POWER AMP	C	0227 87-012-368-080	OE	C-CAP,S 0.1-50 Z F	USM	CX-SNAJ305
O	POWER AMP	C	0227 87-012-368-080	OE	C-CAP,S 0.1-50 Z F	USM	CX-SNAJ305
O	POWER AMP	C	0228 87-012-368-080		C-CAP,S 0.1-50 Z F	LHSM	CX-NSZ300
O	POWER AMP	C	0228 87-012-368-080		C-CAP,S 0.1-50 Z F	USM	CX-SNAJ300
O	POWER AMP	C	0228 87-012-368-080		C-CAP,S 0.1-50 Z F	USM	CX-SNAJ305
O	POWER AMP	C	0228 87-012-368-080		C-CAP,S 0.1-50 Z F	LHSM	CX-NSZ300
O	POWER AMP	C	0228 87-012-368-080		C-CAP,S 0.1-50 Z F	USM	CX-SNAJ300
O	POWER AMP	C	0228 87-012-368-080		C-CAP,S 0.1-50 Z F	USM	CX-SNAJ305
O	POWER AMP	C	0228 87-012-368-080	OE	C-CAP,S 0.1-50 Z F	LHSM	CX-NSZ300
O	POWER AMP	C	0228 87-012-368-080	OE	C-CAP,S 0.1-50 Z F	USM	CX-SNAJ300
O	POWER AMP	C	0228 87-012-368-080	OE	C-CAP,S 0.1-50 Z F	USM	CX-SNAJ305
O	POWER AMP	C	0229 87-010-191-080		C-CAP,S 0.015-50 Z F GRM	EZSM	CX-NSZ300
O	POWER AMP	C	0230 87-010-191-080		C-CAP,S 0.015-50 Z F GRM	EZSM	CX-NSZ300
O	POWER AMP	C	0231 87-012-286-080		C-CAP,U 0.01-25 K B	EZSM	CX-NSZ300
O	POWER AMP	C	0232 87-012-286-080		C-CAP,U 0.01-25 K B	EZSM	CX-NSZ300
O	POWER AMP	C	0235 87-A12-094-080		CAP,E 47-50 SMG	USM	CX-SNAJ305
O	POWER AMP	C	0235 87-A12-094-080	OE	CAP,E 47-50 SMG	USM	CX-SNAJ305
O	POWER AMP	C	0236 87-A12-094-080		CAP,E 47-50 SMG	USM	CX-SNAJ305
O	POWER AMP	C	0236 87-A12-094-080	OE	CAP,E 47-50 SMG	USM	CX-SNAJ305
O	POWER AMP	C	0241 87-010-831-080		C-CAP,U 0.1-16 Z F	LHSM	CX-NSZ300
O	POWER AMP	C	0241 87-010-831-080		C-CAP,U 0.1-16 Z F	USM	CX-SNAJ300
O	POWER AMP	C	0241 87-010-831-080		C-CAP,U 0.1-16 Z F	USM	CX-SNAJ305
O	POWER AMP	C	0241 87-010-831-080	OE	C-CAP,U 0.1-16 Z F	LHSM	CX-NSZ300
O	POWER AMP	C	0241 87-010-831-080	OE	C-CAP,U 0.1-16 Z F	USM	CX-SNAJ300
O	POWER AMP	C	0241 87-010-831-080	OE	C-CAP,U 0.1-16 Z F	USM	CX-SNAJ305
S	POWER AMP	D	0101 87-A40-269-080		C-DIODE,MC2836	LHSM	CX-NSZ300
S	POWER AMP	D	0101 87-A40-269-080		C-DIODE,MC2836	USM	CX-SNAJ300
S	POWER AMP	D	0101 87-A40-269-080	OE	C-DIODE,MC2836	LHSM	CX-NSZ300
S	POWER AMP	D	0101 87-A40-269-080	OE	C-DIODE,MC2836	USM	CX-SNAJ305
S	POWER AMP	D	0101 87-A40-269-080	OE	C-DIODE,MC2836	EZSM	CX-NSZ300
S	POWER AMP	D	0101 87-A40-269-080	OE	C-DIODE,MC2836	LHSM	CX-NSZ300
S	POWER AMP	D	0101 87-A40-269-080	OE	C-DIODE,MC2836	USM	CX-SNAJ300
S	POWER AMP	D	0101 87-A40-269-080	OE	C-DIODE,MC2836	USM	CX-SNAJ305
S	POWER AMP	D	0101 87-A40-269-080	OE	C-DIODE,MC2836	LHSM	CX-NSZ300
S	POWER AMP	D	0103 87-A40-291-080		DIODE,1N4148M (CPT)	LHSM	CX-NSZ300
S	POWER AMP	D	0103 87-A40-291-080		DIODE,1N4148M (CPT)	USM	CX-SNAJ300
S	POWER AMP	D	0103 87-A40-291-080		DIODE,1N4148M (CPT)	USM	CX-SNAJ305
S	POWER AMP	D	0103 87-A40-291-080		DIODE,1N4148M (CPT)	EZSM	CX-NSZ300
S	POWER AMP	D	0103 87-A40-291-080	OE	DIODE,1N4148M (CPT)	LHSM	CX-NSZ300
S	POWER AMP	D	0103 87-A40-291-080	OE	DIODE,1N4148M (CPT)	USM	CX-SNAJ300
S	POWER AMP	D	0103 87-A40-291-080	OE	DIODE,1N4148M (CPT)	USM	CX-SNAJ305
S	POWER AMP	D	0104 87-A40-291-080		DIODE,1N4148M (CPT)	LHSM	CX-NSZ300
S	POWER AMP	D	0104 87-A40-291-080		DIODE,1N4148M (CPT)	USM	CX-SNAJ300
S	POWER AMP	D	0104 87-A40-291-080		DIODE,1N4148M (CPT)	EZSM	CX-NSZ300
S	POWER AMP	D	0104 87-A40-291-080	OE	DIODE,1N4148M (CPT)	LHSM	CX-NSZ300
S	POWER AMP	D	0104 87-A40-291-080	OE	DIODE,1N4148M (CPT)	USM	CX-SNAJ300
S	POWER AMP	D	0104 87-A40-291-080	OE	DIODE,1N4148M (CPT)	USM	CX-SNAJ305
S	POWER AMP	D	0105 87-A40-291-080		DIODE,1N4148M (CPT)	LHSM	CX-NSZ300
S	POWER AMP	D	0105 87-A40-291-080		DIODE,1N4148M (CPT)	USM	CX-SNAJ300
S	POWER AMP	D	0105 87-A40-291-080		DIODE,1N4148M (CPT)	USM	CX-SNAJ305
S	POWER AMP	D	0105 87-A40-291-080	OE	DIODE,1N4148M (CPT)	LHSM	CX-NSZ300
S	POWER AMP	D	0105 87-A40-291-080	OE	DIODE,1N4148M (CPT)	USM	CX-SNAJ300
S	POWER AMP	D	0105 87-A40-291-080	OE	DIODE,1N4148M (CPT)	USM	CX-SNAJ305
S	POWER AMP	D	0106 87-A40-291-080		DIODE,1N4148M (CPT)	LHSM	CX-NSZ300
S	POWER AMP	D	0106 87-A40-291-080		DIODE,1N4148M (CPT)	USM	CX-SNAJ300
S	POWER AMP	D	0106 87-A40-291-080		DIODE,1N4148M (CPT)	USM	CX-SNAJ305
S	POWER AMP	D	0106 87-A40-291-080		DIODE,1N4148M (CPT)	USM	CX-NSZ300
S	POWER AMP	D	0106 87-A40-291-080	OE	DIODE,1N4148M (CPT)	EZSM	CX-NSZ300
S	POWER AMP	D	0106 87-A40-291-080	OE	DIODE,1N4148M (CPT)	LHSM	CX-NSZ300
S	POWER AMP	D	0106 87-A40-291-080	OE	DIODE,1N4148M (CPT)	USM	CX-SNAJ300
S	POWER AMP	D	0106 87-A40-291-080	OE	DIODE,1N4148M (CPT)	USM	CX-SNAJ305

PARTS LIST

! = Δ SAFTY PARTS
 C = Components marked

All components used on this model at the production line are shown in this service manual.

However, please note that not all components will be available as spare parts for after-sales service.

Components marked S and O are designated as spare parts for service and will be stocked at the spare parts centers.

Components marked X and R are not designated as spare parts for after sales service, and will not be stocked at the spare parts centers.

K NO. = Only use japanese.

! C	UNIT NAME	REF NO.	PARTS CODE	K NO.	DESCRIPTION	SUFFIX	MODEL NAME
S	POWER AMP	D	0107 87-A40-291-080		DIODE,1N4148M (CPT)	LHSM	CX-NSZ300
S	POWER AMP	D	0107 87-A40-291-080		DIODE,1N4148M (CPT)	USM	CX-SNAJ300
S	POWER AMP	D	0107 87-A40-291-080		DIODE,1N4148M (CPT)	USM	CX-SNAJ305
S	POWER AMP	D	0107 87-A40-291-080		DIODE,1N4148M (CPT)	EZSM	CX-NSZ300
S	POWER AMP	D	0107 87-A40-291-080	OE	DIODE,1N4148M (CPT)	LHSM	CX-NSZ300
S	POWER AMP	D	0107 87-A40-291-080	OE	DIODE,1N4148M (CPT)	USM	CX-SNAJ300
S	POWER AMP	D	0107 87-A40-291-080	OE	DIODE,1N4148M (CPT)	USM	CX-SNAJ305
S	POWER AMP	D	0108 87-A40-291-080		DIODE,1N4148M (CPT)	LHSM	CX-NSZ300
S	POWER AMP	D	0108 87-A40-291-080		DIODE,1N4148M (CPT)	USM	CX-SNAJ300
S	POWER AMP	D	0108 87-A40-291-080		DIODE,1N4148M (CPT)	USM	CX-SNAJ305
S	POWER AMP	D	0108 87-A40-291-080		DIODE,1N4148M (CPT)	EZSM	CX-NSZ300
S	POWER AMP	D	0108 87-A40-291-080	OE	DIODE,1N4148M (CPT)	LHSM	CX-NSZ300
S	POWER AMP	D	0108 87-A40-291-080	OE	DIODE,1N4148M (CPT)	USM	CX-SNAJ300
S	POWER AMP	D	0108 87-A40-291-080	OE	DIODE,1N4148M (CPT)	USM	CX-SNAJ305
S	POWER AMP	D	0115 87-A40-270-080		C-DIODE,MC2838	LHSM	CX-NSZ300
S	POWER AMP	D	0115 87-A40-270-080		C-DIODE,MC2838	USM	CX-SNAJ300
S	POWER AMP	D	0115 87-A40-270-080		C-DIODE,MC2838	USM	CX-SNAJ305
S	POWER AMP	D	0115 87-A40-270-080		C-DIODE,MC2838	EZSM	CX-NSZ300
S	POWER AMP	D	0115 87-A40-270-080	OE	C-DIODE,MC2838	LHSM	CX-NSZ300
S	POWER AMP	D	0115 87-A40-270-080	OE	C-DIODE,MC2838	USM	CX-SNAJ300
S	POWER AMP	D	0115 87-A40-270-080	OE	C-DIODE,MC2838	USM	CX-SNAJ305
S	POWER AMP	D	0117 87-A40-291-080		DIODE,1N4148M (CPT)	LHSM	CX-NSZ300
S	POWER AMP	D	0117 87-A40-291-080		DIODE,1N4148M (CPT)	USM	CX-SNAJ300
S	POWER AMP	D	0117 87-A40-291-080		DIODE,1N4148M (CPT)	USM	CX-SNAJ305
S	POWER AMP	D	0117 87-A40-291-080		DIODE,1N4148M (CPT)	EZSM	CX-NSZ300
S	POWER AMP	D	0117 87-A40-291-080	OE	DIODE,1N4148M (CPT)	LHSM	CX-NSZ300
S	POWER AMP	D	0117 87-A40-291-080	OE	DIODE,1N4148M (CPT)	USM	CX-SNAJ300
S	POWER AMP	D	0117 87-A40-291-080	OE	DIODE,1N4148M (CPT)	USM	CX-SNAJ305
S	POWER AMP	D	0118 87-A40-291-080		DIODE,1N4148M (CPT)	LHSM	CX-NSZ300
S	POWER AMP	D	0118 87-A40-291-080		DIODE,1N4148M (CPT)	USM	CX-SNAJ300
S	POWER AMP	D	0118 87-A40-291-080		DIODE,1N4148M (CPT)	USM	CX-SNAJ305
S	POWER AMP	D	0118 87-A40-291-080		DIODE,1N4148M (CPT)	EZSM	CX-NSZ300
S	POWER AMP	D	0118 87-A40-291-080	OE	DIODE,1N4148M (CPT)	LHSM	CX-NSZ300
S	POWER AMP	D	0118 87-A40-291-080	OE	DIODE,1N4148M (CPT)	USM	CX-SNAJ300
S	POWER AMP	D	0150 87-A40-270-080		C-DIODE,MC2838	LHSM	CX-NSZ300
S	POWER AMP	D	0150 87-A40-270-080		C-DIODE,MC2838	USM	CX-SNAJ300
S	POWER AMP	D	0150 87-A40-270-080		C-DIODE,MC2838	USM	CX-SNAJ305
S	POWER AMP	D	0150 87-A40-270-080		C-DIODE,MC2838	EZSM	CX-NSZ300
S	POWER AMP	D	0150 87-A40-270-080	OE	C-DIODE,MC2838	LHSM	CX-NSZ300
S	POWER AMP	D	0150 87-A40-270-080	OE	C-DIODE,MC2838	USM	CX-SNAJ300
S	POWER AMP	D	0150 87-A40-270-080	OE	C-DIODE,MC2838	USM	CX-SNAJ305
S	POWER AMP	D	0160 87-A40-270-080		C-DIODE,MC2838	LHSM	CX-NSZ300
S	POWER AMP	D	0160 87-A40-270-080		C-DIODE,MC2838	USM	CX-SNAJ300
S	POWER AMP	D	0160 87-A40-270-080		C-DIODE,MC2838	USM	CX-SNAJ305
S	POWER AMP	D	0160 87-A40-270-080		C-DIODE,MC2838	EZSM	CX-NSZ300
S	POWER AMP	D	0160 87-A40-270-080	OE	C-DIODE,MC2838	LHSM	CX-NSZ300
S	POWER AMP	D	0160 87-A40-270-080	OE	C-DIODE,MC2838	USM	CX-SNAJ300
S	POWER AMP	D	0160 87-A40-270-080	OE	C-DIODE,MC2838	USM	CX-SNAJ305
S	POWER AMP	D	0185 87-A40-393-090		DIODE,1N5402GW (F20)	LHSM	CX-NSZ300
S	POWER AMP	D	0185 87-A40-393-090		DIODE,1N5402GW (F20)	USM	CX-SNAJ300
S	POWER AMP	D	0185 87-A40-393-090		DIODE,1N5402GW (F20)	USM	CX-SNAJ305
S	POWER AMP	D	0185 87-A40-393-090		DIODE,1N5402GW (F20)	EZSM	CX-NSZ300
S	POWER AMP	D	0185 87-A40-393-090	OE	DIODE,1N5402GW (F20)	LHSM	CX-NSZ300
S	POWER AMP	D	0185 87-A40-393-090	OE	DIODE,1N5402GW (F20)	USM	CX-SNAJ300
S	POWER AMP	D	0185 87-A40-393-090	OE	DIODE,1N5402GW (F20)	USM	CX-SNAJ305
S	POWER AMP	D	0186 87-A40-393-090		DIODE,1N5402GW (F20)	LHSM	CX-NSZ300
S	POWER AMP	D	0186 87-A40-393-090		DIODE,1N5402GW (F20)	USM	CX-SNAJ300
S	POWER AMP	D	0186 87-A40-393-090		DIODE,1N5402GW (F20)	USM	CX-SNAJ305
S	POWER AMP	D	0186 87-A40-393-090		DIODE,1N5402GW (F20)	EZSM	CX-NSZ300
S	POWER AMP	D	0186 87-A40-393-090	OE	DIODE,1N5402GW (F20)	LHSM	CX-NSZ300
S	POWER AMP	D	0186 87-A40-393-090	OE	DIODE,1N5402GW (F20)	USM	CX-SNAJ300
S	POWER AMP	D	0186 87-A40-393-090	OE	DIODE,1N5402GW (F20)	USM	CX-SNAJ305
S	POWER AMP	D	0187 87-A40-747-080		ZENER,UZ5.1BSB	LHSM	CX-NSZ300
S	POWER AMP	D	0187 87-A40-747-080		ZENER,UZ5.1BSB	USM	CX-SNAJ300
S	POWER AMP	D	0187 87-A40-747-080		ZENER,UZ5.1BSB	USM	CX-SNAJ305
S	POWER AMP	D	0187 87-A40-747-080		ZENER,UZ5.1BSB	EZSM	CX-NSZ300
S	POWER AMP	D	0187 87-A40-747-080	OE	ZENER,UZ5.1BSB	LHSM	CX-NSZ300
S	POWER AMP	D	0187 87-A40-747-080	OE	ZENER,UZ5.1BSB	USM	CX-SNAJ300
S	POWER AMP	D	0187 87-A40-747-080	OE	ZENER,UZ5.1BSB	USM	CX-SNAJ305

PARTS LIST

! = Δ SAFTY PARTS
 C = Components marked

All components used on this model at the production line are shown in this service manual.

However, please note that not all components will be available as spare parts for after-sales service.

Components marked S and O are designated as spare parts for service and will be stocked at the spare parts centers.

Components marked X and R are not designated as spare parts for after sales service, and will not be stocked at the spare parts centers.

K NO. = Only use japanese.

! C	UNIT NAME	REF NO.	PARTS CODE	K NO.	DESCRIPTION	SUFFIX	MODEL NAME	
S	POWER AMP	D	0188 87-A40-749-080		ZENER, UZ5.6BSB	LHSM	CX-NSZ300	
S	POWER AMP	D	0188 87-A40-749-080		ZENER, UZ5.6BSB	USM	CX-SNAJ300	
S	POWER AMP	D	0188 87-A40-749-080		ZENER, UZ5.6BSB	USM	CX-SNAJ305	
S	POWER AMP	D	0188 87-A40-749-080		ZENER, UZ5.6BSB	EZSM	CX-NSZ300	
S	POWER AMP	D	0188 87-A40-749-080	OE	ZENER, UZ5.6BSB	LHSM	CX-NSZ300	
S	POWER AMP	D	0188 87-A40-749-080	OE	ZENER, UZ5.6BSB	USM	CX-SNAJ300	
S	POWER AMP	D	0188 87-A40-749-080	OE	ZENER, UZ5.6BSB	USM	CX-SNAJ305	
S	POWER AMP	D	0189 87-A40-270-080		C-DIODE, MC2838	LHSM	CX-NSZ300	
S	POWER AMP	D	0189 87-A40-270-080		C-DIODE, MC2838	USM	CX-SNAJ300	
S	POWER AMP	D	0189 87-A40-270-080		C-DIODE, MC2838	USM	CX-SNAJ305	
S	POWER AMP	D	0189 87-A40-270-080	OE	C-DIODE, MC2838	EZSM	CX-NSZ300	
S	POWER AMP	D	0189 87-A40-270-080	OE	C-DIODE, MC2838	LHSM	CX-NSZ300	
S	POWER AMP	D	0189 87-A40-270-080	OE	C-DIODE, MC2838	USM	CX-SNAJ300	
S	POWER AMP	D	0189 87-A40-270-080	OE	C-DIODE, MC2838	USM	CX-SNAJ305	
S	POWER AMP	D	0190 87-A40-269-080		C-DIODE, MC2836	LHSM	CX-NSZ300	
S	POWER AMP	D	0190 87-A40-269-080		C-DIODE, MC2836	USM	CX-SNAJ300	
S	POWER AMP	D	0190 87-A40-269-080	OE	C-DIODE, MC2836	USM	CX-SNAJ305	
S	POWER AMP	D	0190 87-A40-269-080	OE	C-DIODE, MC2836	EZSM	CX-NSZ300	
S	POWER AMP	D	0190 87-A40-269-080	OE	C-DIODE, MC2836	LHSM	CX-NSZ300	
S	POWER AMP	D	0190 87-A40-269-080	OE	C-DIODE, MC2836	USM	CX-SNAJ300	
S	POWER AMP	D	0190 87-A40-269-080	OE	C-DIODE, MC2836	USM	CX-SNAJ305	
S	POWER AMP	D	0191 87-A40-764-080		ZENER, UZ10BSC	LHSM	CX-NSZ300	
S	POWER AMP	D	0191 87-A40-764-080		ZENER, UZ10BSC	USM	CX-SNAJ300	
S	POWER AMP	D	0191 87-A40-764-080		ZENER, UZ10BSC	USM	CX-SNAJ305	
S	POWER AMP	D	0191 87-A40-764-080		ZENER, UZ10BSC	EZSM	CX-NSZ300	
S	POWER AMP	D	0191 87-A40-764-080	OE	ZENER, UZ10BSC	LHSM	CX-NSZ300	
S	POWER AMP	D	0191 87-A40-764-080	OE	ZENER, UZ10BSC	USM	CX-SNAJ300	
S	POWER AMP	D	0191 87-A40-764-080	OE	ZENER, UZ10BSC	USM	CX-SNAJ305	
S	POWER AMP	D	0192 87-A40-291-080		DIODE, 1N4148M (CPT)	LHSM	CX-NSZ300	
S	POWER AMP	D	0192 87-A40-291-080		DIODE, 1N4148M (CPT)	USM	CX-SNAJ300	
S	POWER AMP	D	0192 87-A40-291-080		DIODE, 1N4148M (CPT)	USM	CX-SNAJ305	
S	POWER AMP	D	0192 87-A40-291-080		DIODE, 1N4148M (CPT)	EZSM	CX-NSZ300	
S	POWER AMP	D	0192 87-A40-291-080	OE	DIODE, 1N4148M (CPT)	LHSM	CX-NSZ300	
S	POWER AMP	D	0192 87-A40-291-080	OE	DIODE, 1N4148M (CPT)	USM	CX-SNAJ300	
S	POWER AMP	D	0192 87-A40-291-080	OE	DIODE, 1N4148M (CPT)	USM	CX-SNAJ305	
S	POWER AMP	D	0192 87-A40-291-080	OE	DIODE, 1N4148M (CPT)	EZSM	CX-NSZ300	
S	POWER AMP	D	0192 87-A40-291-080	OE	DIODE, 1N4148M (CPT)	LHSM	CX-NSZ300	
S	POWER AMP	D	0193 87-A40-291-080		DIODE, 1N4148M (CPT)	LHSM	CX-NSZ300	
S	POWER AMP	D	0193 87-A40-291-080		DIODE, 1N4148M (CPT)	USM	CX-SNAJ300	
S	POWER AMP	D	0193 87-A40-291-080		DIODE, 1N4148M (CPT)	USM	CX-SNAJ305	
S	POWER AMP	D	0193 87-A40-291-080		DIODE, 1N4148M (CPT)	EZSM	CX-NSZ300	
S	POWER AMP	D	0193 87-A40-291-080	OE	DIODE, 1N4148M (CPT)	LHSM	CX-NSZ300	
S	POWER AMP	D	0193 87-A40-291-080	OE	DIODE, 1N4148M (CPT)	USM	CX-SNAJ300	
S	POWER AMP	D	0193 87-A40-291-080	OE	DIODE, 1N4148M (CPT)	USM	CX-SNAJ305	
S	POWER AMP	D	0193 87-A40-291-080	OE	DIODE, 1N4148M (CPT)	EZSM	CX-NSZ300	
S	POWER AMP	D	0193 87-A40-291-080	OE	DIODE, 1N4148M (CPT)	LHSM	CX-NSZ300	
O	POWER AMP	J	0201 87-A60-488-010		JACK, DIA6.3 BLK ST W/SW KM16AT	EZSM	CX-NSZ300	
O	POWER AMP	J	0201 87-A61-480-010		JACK, DIA6.3 BLK ST W/SW MSC16A	LHSM	CX-NSZ300	
O	POWER AMP	J	0201 87-A61-480-010		JACK, DIA6.3 BLK ST W/SW MSC16A	USM	CX-SNAJ300	
O	POWER AMP	J	0201 87-A61-480-010		JACK, DIA6.3 BLK ST W/SW MSC16A	USM	CX-SNAJ305	
O	POWER AMP	J	0201 87-A61-480-010	OE	JACK, DIA6.3 BLK ST W/SW MSC16A	LHSM	CX-NSZ300	
O	POWER AMP	J	0201 87-A61-480-010	OE	JACK, DIA6.3 BLK ST W/SW MSC16A	USM	CX-SNAJ300	
O	POWER AMP	J	0201 87-A61-480-010	OE	JACK, DIA6.3 BLK ST W/SW MSC16A	USM	CX-SNAJ305	
O	POWER AMP	J	0203 87-A60-238-010		TERMINAL, SP 4P (MSC)	LHSM	CX-NSZ300	
O	POWER AMP	J	0203 87-A60-238-010		TERMINAL, SP 4P (MSC)	USM	CX-SNAJ300	
O	POWER AMP	J	0203 87-A60-238-010		TERMINAL, SP 4P (MSC)	USM	CX-SNAJ305	
!	O	POWER AMP	J	0203 87-A60-238-010	1A	TERMINAL, SP 4P (MSC)	EZSM	CX-NSZ300
!	O	POWER AMP	J	0203 87-A60-238-010	1A	TERMINAL, SP 4P (MSC)	LHSM	CX-NSZ300
!	O	POWER AMP	J	0203 87-A60-238-010	1A	TERMINAL, SP 4P (MSC)	USM	CX-SNAJ300
!	O	POWER AMP	J	0203 87-A60-238-010	1A	TERMINAL, SP 4P (MSC)	USM	CX-SNAJ305
O	POWER AMP	J	0205 87-A60-881-010		JACK, PIN 2P MSP 242V05 PBSN	USM	CX-SNAJ305	
O	POWER AMP	J	0205 87-A60-881-010	OE	JACK, PIN 2P MSP 242V05 PBSN	USM	CX-SNAJ305	
X	POWER AMP	JR	0101 88-108-000-080		C-JUMPER, U	LHSM	CX-NSZ300	
X	POWER AMP	JR	0101 88-108-000-080		C-JUMPER, U	USM	CX-SNAJ300	
X	POWER AMP	JR	0101 88-108-000-080		C-JUMPER, U	USM	CX-SNAJ305	
X	POWER AMP	JR	0101 88-108-000-080	OE	C-JUMPER, U	EZSM	CX-NSZ300	
X	POWER AMP	JR	0101 88-108-000-080	OE	C-JUMPER, U	LHSM	CX-NSZ300	
X	POWER AMP	JR	0101 88-108-000-080	OE	C-JUMPER, U	USM	CX-SNAJ300	
X	POWER AMP	JR	0101 88-108-000-080	OE	C-JUMPER, U	USM	CX-SNAJ305	
X	POWER AMP	JR	0102 88-108-000-080		C-JUMPER, U	LHSM	CX-NSZ300	
X	POWER AMP	JR	0102 88-108-000-080		C-JUMPER, U	USM	CX-SNAJ300	
X	POWER AMP	JR	0102 88-108-000-080		C-JUMPER, U	USM	CX-SNAJ305	
X	POWER AMP	JR	0102 88-108-000-080		C-JUMPER, U	EZSM	CX-NSZ300	
X	POWER AMP	JR	0102 88-108-000-080	OE	C-JUMPER, U	LHSM	CX-NSZ300	

PARTS LIST

! = Δ SAFTY PARTS
 C = Components marked

All components used on this model at the production line are shown in this service manual.

However, please note that not all components will be available as spare parts for after-sales service.

Components marked S and O are designated as spare parts for service and will be stocked at the spare parts centers.

Components marked X and R are not designated as spare parts for after sales service, and will not be stocked at the spare parts centers.

K NO. = Only use japanese.

! C	UNIT NAME	REF NO.	PARTS CODE	K NO.	DESCRIPTION	SUFFIX	MODEL NAME
X	POWER AMP	JR 0102	88-108-000-080	OE	C-JUMPER,U	USM	CX-SNAJ300
X	POWER AMP	JR 0102	88-108-000-080	OE	C-JUMPER,U	USM	CX-SNAJ305
X	POWER AMP	JR 0103	88-108-000-080		C-JUMPER,U	LHSM	CX-NSZ300
X	POWER AMP	JR 0103	88-108-000-080		C-JUMPER,U	USM	CX-SNAJ300
X	POWER AMP	JR 0103	88-108-000-080		C-JUMPER,U	USM	CX-SNAJ305
X	POWER AMP	JR 0103	88-108-000-080		C-JUMPER,U	EZSM	CX-NSZ300
X	POWER AMP	JR 0103	88-108-000-080	OE	C-JUMPER,U	LHSM	CX-NSZ300
X	POWER AMP	JR 0103	88-108-000-080	OE	C-JUMPER,U	USM	CX-SNAJ300
X	POWER AMP	JR 0103	88-108-000-080	OE	C-JUMPER,U	USM	CX-SNAJ305
X	POWER AMP	JR 0104	88-108-000-080		C-JUMPER,U	LHSM	CX-NSZ300
X	POWER AMP	JR 0104	88-108-000-080		C-JUMPER,U	USM	CX-SNAJ300
X	POWER AMP	JR 0104	88-108-000-080		C-JUMPER,U	USM	CX-SNAJ305
X	POWER AMP	JR 0104	88-108-000-080		C-JUMPER,U	EZSM	CX-NSZ300
X	POWER AMP	JR 0104	88-108-000-080	OE	C-JUMPER,U	LHSM	CX-NSZ300
X	POWER AMP	JR 0104	88-108-000-080	OE	C-JUMPER,U	USM	CX-SNAJ300
X	POWER AMP	JR 0104	88-108-000-080	OE	C-JUMPER,U	USM	CX-SNAJ305
X	POWER AMP	JR 0105	88-128-273-080		C-RES, 27K-1/8W J	EZSM	CX-NSZ300
X	POWER AMP	JR 0105	88-128-273-080	OE	C-RES, 27K-1/8W J	LHSM	CX-NSZ300
X	POWER AMP	JR 0105	88-128-273-080	OE	C-RES, 27K-1/8W J	USM	CX-SNAJ300
X	POWER AMP	JR 0105	88-128-273-080	OE	C-RES, 27K-1/8W J	USM	CX-SNAJ305
X	POWER AMP	JR 0107	88-108-000-080		C-JUMPER,U	LHSM	CX-NSZ300
X	POWER AMP	JR 0107	88-108-000-080		C-JUMPER,U	USM	CX-SNAJ300
X	POWER AMP	JR 0107	88-108-000-080		C-JUMPER,U	USM	CX-SNAJ305
X	POWER AMP	JR 0107	88-108-000-080		C-JUMPER,U	EZSM	CX-NSZ300
X	POWER AMP	JR 0107	88-108-000-080	OE	C-JUMPER,U	LHSM	CX-NSZ300
X	POWER AMP	JR 0107	88-108-000-080	OE	C-JUMPER,U	USM	CX-SNAJ300
X	POWER AMP	JR 0107	88-108-000-080	OE	C-JUMPER,U	USM	CX-SNAJ305
X	POWER AMP	JR 0108	88-108-000-080		C-JUMPER,U	LHSM	CX-NSZ300
X	POWER AMP	JR 0108	88-108-000-080		C-JUMPER,U	USM	CX-SNAJ300
X	POWER AMP	JR 0108	88-108-000-080		C-JUMPER,U	USM	CX-SNAJ305
X	POWER AMP	JR 0109	88-108-000-080		C-JUMPER,U	LHSM	CX-NSZ300
X	POWER AMP	JR 0109	88-108-000-080		C-JUMPER,U	USM	CX-SNAJ300
X	POWER AMP	JR 0109	88-108-000-080		C-JUMPER,U	USM	CX-SNAJ305
X	POWER AMP	JR 0109	88-108-000-080		C-JUMPER,U	EZSM	CX-NSZ300
X	POWER AMP	JR 0109	88-108-000-080	OE	C-JUMPER,U	LHSM	CX-NSZ300
X	POWER AMP	JR 0109	88-108-000-080	OE	C-JUMPER,U	USM	CX-SNAJ300
X	POWER AMP	JR 0109	88-108-000-080	OE	C-JUMPER,U	USM	CX-SNAJ305
X	POWER AMP	JR 0110	88-108-000-080		C-JUMPER,U	LHSM	CX-NSZ300
X	POWER AMP	JR 0110	88-108-000-080		C-JUMPER,U	USM	CX-SNAJ300
X	POWER AMP	JR 0110	88-108-000-080		C-JUMPER,U	USM	CX-SNAJ305
X	POWER AMP	JR 0110	88-108-000-080		C-JUMPER,U	EZSM	CX-NSZ300
X	POWER AMP	JR 0110	88-108-000-080	OE	C-JUMPER,U	LHSM	CX-NSZ300
X	POWER AMP	JR 0110	88-108-000-080	OE	C-JUMPER,U	USM	CX-SNAJ300
X	POWER AMP	JR 0110	88-108-000-080	OE	C-JUMPER,U	USM	CX-SNAJ305
X	POWER AMP	JR 0111	88-129-000-080		C-JUMPER, 3216	LHSM	CX-NSZ300
X	POWER AMP	JR 0111	88-129-000-080		C-JUMPER, 3216	USM	CX-SNAJ300
X	POWER AMP	JR 0111	88-129-000-080		C-JUMPER, 3216	USM	CX-SNAJ305
X	POWER AMP	JR 0111	88-129-000-080		C-JUMPER, 3216	EZSM	CX-NSZ300
X	POWER AMP	JR 0111	88-129-000-080	OE	C-JUMPER, 3216	LHSM	CX-NSZ300
X	POWER AMP	JR 0111	88-129-000-080	OE	C-JUMPER, 3216	USM	CX-SNAJ300
X	POWER AMP	JR 0111	88-129-000-080	OE	C-JUMPER, 3216	USM	CX-SNAJ305
X	POWER AMP	JR 0111	88-129-000-080	OE	C-JUMPER, 3216	EZSM	CX-NSZ300
X	POWER AMP	JR 0113	88-108-000-080		C-JUMPER,U	USM	CX-SNAJ305
X	POWER AMP	JR 0113	88-108-000-080	OE	C-JUMPER,U	EZSM	CX-NSZ300
X	POWER AMP	JR 0113	88-108-000-080	OE	C-JUMPER,U	LHSM	CX-NSZ300
X	POWER AMP	JR 0113	88-108-000-080	OE	C-JUMPER,U	USM	CX-SNAJ300
X	POWER AMP	JR 0113	88-108-000-080	OE	C-JUMPER,U	USM	CX-SNAJ305
X	POWER AMP	JR 0114	88-108-000-080		C-JUMPER,U	EZSM	CX-NSZ300
X	POWER AMP	JR 0114	88-108-000-080	OE	C-JUMPER,U	LHSM	CX-NSZ300
X	POWER AMP	JR 0114	88-108-000-080	OE	C-JUMPER,U	USM	CX-SNAJ300
X	POWER AMP	JR 0114	88-108-000-080	OE	C-JUMPER,U	USM	CX-SNAJ305
O	POWER AMP	JR 0123	87-012-195-080		C-CAP,U 100P-50 J CH	EZSM	CX-NSZ300
O	POWER AMP	JR 0123	87-012-195-080	OE	C-CAP,U 100P-50 J CH	USM	CX-SNAJ300
O	POWER AMP	JR 0123	87-012-195-080	OE	C-CAP,U 100P-50 J CH	USM	CX-SNAJ305
O	POWER AMP	JR 0123	87-A10-596-080	OE	C-CAP,S 100P-100 J CH	LHSM	CX-NSZ300
O	POWER AMP	JR 0124	87-012-195-080		C-CAP,U 100P-50 J CH	EZSM	CX-NSZ300
O	POWER AMP	JR 0124	87-012-195-080	OE	C-CAP,U 100P-50 J CH	USM	CX-SNAJ300
O	POWER AMP	JR 0124	87-012-195-080	OE	C-CAP,U 100P-50 J CH	USM	CX-SNAJ305
O	POWER AMP	JR 0124	87-A10-596-080	OE	C-CAP,S 100P-100 J CH	LHSM	CX-NSZ300
O	POWER AMP	L 0201	87-A50-610-010		COIL,1UH K(MDEC)	LHSM	CX-NSZ300
O	POWER AMP	L 0201	87-A50-610-010		COIL,1UH K(MDEC)	USM	CX-SNAJ300
O	POWER AMP	L 0201	87-A50-610-010		COIL,1UH K(MDEC)	USM	CX-SNAJ305

PARTS LIST

! = Δ SAFTY PARTS
 C = Components marked

All components used on this model at the production line are shown in this service manual.

However, please note that not all components will be available as spare parts for after-sales service.

Components marked S and O are designated as spare parts for service and will be stocked at the spare parts centers.

Components marked X and R are not designated as spare parts for after sales service, and will not be stocked at the spare parts centers.

K NO. = Only use japanese.

! C	UNIT NAME	REF NO.	PARTS CODE	K NO.	DESCRIPTION	SUFFIX	MODEL NAME
S	POWER AMP	Q	0111 87-A30-190-080		TR,CC5551	EZSM	CX-NSZ300
S	POWER AMP	Q	0111 87-A30-190-080	0E	TR,CC5551	LHSM	CX-NSZ300
S	POWER AMP	Q	0111 87-A30-190-080	0E	TR,CC5551	USM	CX-SNAJ300
S	POWER AMP	Q	0111 87-A30-190-080	0E	TR,CC5551	USM	CX-SNAJ305
S	POWER AMP	Q	0112 87-A30-190-080		TR,CC5551	LHSM	CX-NSZ300
S	POWER AMP	Q	0112 87-A30-190-080		TR,CC5551	USM	CX-SNAJ300
S	POWER AMP	Q	0112 87-A30-190-080		TR,CC5551	USM	CX-SNAJ305
S	POWER AMP	Q	0112 87-A30-190-080		TR,CC5551	EZSM	CX-NSZ300
S	POWER AMP	Q	0112 87-A30-190-080	0E	TR,CC5551	LHSM	CX-NSZ300
S	POWER AMP	Q	0112 87-A30-190-080	0E	TR,CC5551	USM	CX-SNAJ300
S	POWER AMP	Q	0112 87-A30-190-080	0E	TR,CC5551	USM	CX-SNAJ305
S	POWER AMP	Q	0113 87-A30-076-080		C-TR,2SC3052F	LHSM	CX-NSZ300
S	POWER AMP	Q	0113 87-A30-076-080		C-TR,2SC3052F	USM	CX-SNAJ300
S	POWER AMP	Q	0113 87-A30-076-080		C-TR,2SC3052F	USM	CX-SNAJ305
S	POWER AMP	Q	0113 87-A30-076-080		C-TR,2SC3052F	USM	CX-SNAJ305
S	POWER AMP	Q	0113 87-A30-076-080		C-TR,2SC3052F	EZSM	CX-NSZ300
S	POWER AMP	Q	0113 87-A30-076-080	0E	C-TR,2SC3052F	LHSM	CX-NSZ300
S	POWER AMP	Q	0113 87-A30-076-080	0E	C-TR,2SC3052F	USM	CX-SNAJ300
S	POWER AMP	Q	0113 87-A30-076-080	0E	C-TR,2SC3052F	USM	CX-SNAJ305
S	POWER AMP	Q	0114 87-A30-076-080		C-TR,2SC3052F	LHSM	CX-NSZ300
S	POWER AMP	Q	0114 87-A30-076-080		C-TR,2SC3052F	USM	CX-SNAJ300
S	POWER AMP	Q	0114 87-A30-076-080		C-TR,2SC3052F	USM	CX-SNAJ305
S	POWER AMP	Q	0114 87-A30-076-080		C-TR,2SC3052F	EZSM	CX-NSZ300
S	POWER AMP	Q	0114 87-A30-076-080	0E	C-TR,2SC3052F	LHSM	CX-NSZ300
S	POWER AMP	Q	0114 87-A30-076-080	0E	C-TR,2SC3052F	USM	CX-SNAJ300
S	POWER AMP	Q	0114 87-A30-076-080	0E	C-TR,2SC3052F	USM	CX-SNAJ305
S	POWER AMP	Q	0115 87-A30-106-040		C-TR,CMBT5551	LHSM	CX-NSZ300
S	POWER AMP	Q	0115 87-A30-106-040		C-TR,CMBT5551	USM	CX-SNAJ300
S	POWER AMP	Q	0115 87-A30-106-040		C-TR,CMBT5551	USM	CX-SNAJ305
S	POWER AMP	Q	0115 87-A30-106-040		C-TR,CMBT5551	EZSM	CX-NSZ300
S	POWER AMP	Q	0115 87-A30-106-040	0E	C-TR,CMBT5551	LHSM	CX-NSZ300
S	POWER AMP	Q	0115 87-A30-106-040	0E	C-TR,CMBT5551	USM	CX-SNAJ300
S	POWER AMP	Q	0115 87-A30-106-040	0E	C-TR,CMBT5551	USM	CX-SNAJ305
S	POWER AMP	Q	0116 87-A30-106-040		C-TR,CMBT5551	LHSM	CX-NSZ300
S	POWER AMP	Q	0116 87-A30-106-040		C-TR,CMBT5551	USM	CX-SNAJ300
S	POWER AMP	Q	0116 87-A30-106-040		C-TR,CMBT5551	USM	CX-SNAJ305
S	POWER AMP	Q	0116 87-A30-106-040		C-TR,CMBT5551	USM	CX-SNAJ305
S	POWER AMP	Q	0116 87-A30-106-040		C-TR,CMBT5551	EZSM	CX-NSZ300
S	POWER AMP	Q	0116 87-A30-106-040	0E	C-TR,CMBT5551	LHSM	CX-NSZ300
S	POWER AMP	Q	0116 87-A30-106-040	0E	C-TR,CMBT5551	USM	CX-SNAJ300
S	POWER AMP	Q	0116 87-A30-106-040	0E	C-TR,CMBT5551	USM	CX-SNAJ305
S	POWER AMP	Q	0117 87-A30-528-010		TR,2SB1686	USM	CX-SNAJ300
S	POWER AMP	Q	0117 87-A30-528-010		TR,2SB1686	EZSM	CX-NSZ300
S	POWER AMP	Q	0117 87-A30-528-010	1B	TR,2SB1686	LHSM	CX-NSZ300
S	POWER AMP	Q	0117 87-A30-528-010	1B	TR,2SB1686	USM	CX-SNAJ300
S	POWER AMP	Q	0117 87-A30-528-010	1B	TR,2SB1686	USM	CX-SNAJ305
S	POWER AMP	Q	0117 87-A30-528-010		TR,2SB1686	LHSM	CX-NSZ300
S	POWER AMP	Q	0118 87-A30-528-010		TR,2SB1686	USM	CX-SNAJ300
S	POWER AMP	Q	0118 87-A30-528-010		TR,2SB1686	USM	CX-SNAJ305
S	POWER AMP	Q	0118 87-A30-528-010		TR,2SB1686	EZSM	CX-NSZ300
S	POWER AMP	Q	0118 87-A30-528-010	1B	TR,2SB1686	LHSM	CX-NSZ300
S	POWER AMP	Q	0118 87-A30-528-010	1B	TR,2SB1686	USM	CX-SNAJ300
S	POWER AMP	Q	0118 87-A30-528-010	1B	TR,2SB1686	USM	CX-SNAJ305
S	POWER AMP	Q	0118 87-A30-528-010		TR,C5B810	LHSM	CX-NSZ300
S	POWER AMP	Q	0119 87-A30-529-010		TR,2SD2642	USM	CX-SNAJ300
S	POWER AMP	Q	0119 87-A30-529-010		TR,2SD2642	USM	CX-SNAJ305
S	POWER AMP	Q	0119 87-A30-529-010		TR,2SD2642	USM	CX-SNAJ305
S	POWER AMP	Q	0119 87-A30-529-010		TR,2SD2642	EZSM	CX-NSZ300
S	POWER AMP	Q	0119 87-A30-529-010	1B	TR,2SD2642	LHSM	CX-NSZ300
S	POWER AMP	Q	0119 87-A30-529-010	1B	TR,2SD2642	USM	CX-SNAJ300
S	POWER AMP	Q	0119 87-A30-529-010	1B	TR,2SD2642	USM	CX-SNAJ305
S	POWER AMP	Q	0119 87-A30-529-010		TR,CSD811	LHSM	CX-NSZ300
S	POWER AMP	Q	0120 87-A30-529-010		TR,2SD2642	USM	CX-SNAJ300
S	POWER AMP	Q	0120 87-A30-529-010		TR,2SD2642	USM	CX-SNAJ305
S	POWER AMP	Q	0120 87-A30-529-010		TR,2SD2642	EZSM	CX-NSZ300
S	POWER AMP	Q	0120 87-A30-529-010	1B	TR,2SD2642	LHSM	CX-NSZ300
S	POWER AMP	Q	0120 87-A30-529-010	1B	TR,2SD2642	USM	CX-SNAJ300
S	POWER AMP	Q	0120 87-A30-529-010	1B	TR,2SD2642	USM	CX-SNAJ305
S	POWER AMP	Q	0120 87-A30-529-010		TR,CSD811	LHSM	CX-NSZ300
S	POWER AMP	Q	0121 87-A30-190-080		TR,CC5551	LHSM	CX-NSZ300
S	POWER AMP	Q	0121 87-A30-190-080		TR,CC5551	USM	CX-SNAJ300
S	POWER AMP	Q	0121 87-A30-190-080		TR,CC5551	USM	CX-SNAJ305

PARTS LIST

! = Δ SAFTY PARTS
 C = Components marked

All components used on this model at the production line are shown in this service manual.

However, please note that not all components will be available as spare parts for after-sales service.

Components marked S and O are designated as spare parts for service and will be stocked at the spare parts centers.

Components marked X and R are not designated as spare parts for after sales service, and will not be stocked at the spare parts centers.

K NO. = Only use japanese.

! C	UNIT NAME	REF NO.	PARTS CODE	K NO.	DESCRIPTION	SUFFIX	MODEL NAME
S	POWER AMP	Q	0121 87-A30-190-080		TR,CC5551	EZSM	CX-NSZ300
S	POWER AMP	Q	0121 87-A30-190-080	0E	TR,CC5551	LHSM	CX-NSZ300
S	POWER AMP	Q	0121 87-A30-190-080	0E	TR,CC5551	USM	CX-SNAJ300
S	POWER AMP	Q	0121 87-A30-190-080	0E	TR,CC5551	USM	CX-SNAJ305
S	POWER AMP	Q	0122 87-A30-190-080		TR,CC5551	LHSM	CX-NSZ300
S	POWER AMP	Q	0122 87-A30-190-080		TR,CC5551	USM	CX-SNAJ300
S	POWER AMP	Q	0122 87-A30-190-080		TR,CC5551	USM	CX-SNAJ305
S	POWER AMP	Q	0122 87-A30-190-080		TR,CC5551	EZSM	CX-NSZ300
S	POWER AMP	Q	0122 87-A30-190-080	0E	TR,CC5551	LHSM	CX-NSZ300
S	POWER AMP	Q	0122 87-A30-190-080	0E	TR,CC5551	USM	CX-SNAJ300
S	POWER AMP	Q	0122 87-A30-190-080	0E	TR,CC5551	USM	CX-SNAJ305
S	POWER AMP	Q	0123 87-A30-107-070		C-TR,CMBT5401	LHSM	CX-NSZ300
S	POWER AMP	Q	0123 87-A30-107-070		C-TR,CMBT5401	USM	CX-SNAJ300
S	POWER AMP	Q	0123 87-A30-107-070		C-TR,CMBT5401	USM	CX-SNAJ305
S	POWER AMP	Q	0123 87-A30-107-070		C-TR,CMBT5401	EZSM	CX-NSZ300
S	POWER AMP	Q	0123 87-A30-107-070	0E	C-TR,CMBT5401	LHSM	CX-NSZ300
S	POWER AMP	Q	0123 87-A30-107-070	0E	C-TR,CMBT5401	USM	CX-SNAJ300
S	POWER AMP	Q	0123 87-A30-107-070	0E	C-TR,CMBT5401	USM	CX-SNAJ305
S	POWER AMP	Q	0124 87-A30-107-070		C-TR,CMBT5401	LHSM	CX-NSZ300
S	POWER AMP	Q	0124 87-A30-107-070		C-TR,CMBT5401	USM	CX-SNAJ300
S	POWER AMP	Q	0124 87-A30-107-070		C-TR,CMBT5401	USM	CX-SNAJ305
S	POWER AMP	Q	0124 87-A30-107-070		C-TR,CMBT5401	EZSM	CX-NSZ300
S	POWER AMP	Q	0124 87-A30-107-070	0E	C-TR,CMBT5401	LHSM	CX-NSZ300
S	POWER AMP	Q	0124 87-A30-107-070	0E	C-TR,CMBT5401	USM	CX-SNAJ300
S	POWER AMP	Q	0124 87-A30-107-070	0E	C-TR,CMBT5401	USM	CX-SNAJ305
S	POWER AMP	Q	0126 87-A30-107-070		C-TR,CMBT5401	LHSM	CX-NSZ300
S	POWER AMP	Q	0126 87-A30-107-070		C-TR,CMBT5401	USM	CX-SNAJ300
S	POWER AMP	Q	0126 87-A30-107-070		C-TR,CMBT5401	USM	CX-SNAJ305
S	POWER AMP	Q	0126 87-A30-107-070		C-TR,CMBT5401	EZSM	CX-NSZ300
S	POWER AMP	Q	0126 87-A30-107-070	0E	C-TR,CMBT5401	LHSM	CX-NSZ300
S	POWER AMP	Q	0126 87-A30-107-070	0E	C-TR,CMBT5401	USM	CX-SNAJ300
S	POWER AMP	Q	0126 87-A30-107-070	0E	C-TR,CMBT5401	USM	CX-SNAJ305
S	POWER AMP	Q	0127 87-A30-076-080		C-TR,2SC3052F	LHSM	CX-NSZ300
S	POWER AMP	Q	0127 87-A30-076-080		C-TR,2SC3052F	USM	CX-SNAJ300
S	POWER AMP	Q	0127 87-A30-076-080		C-TR,2SC3052F	USM	CX-SNAJ305
S	POWER AMP	Q	0127 87-A30-076-080		C-TR,2SC3052F	EZSM	CX-NSZ300
S	POWER AMP	Q	0127 87-A30-076-080	0E	C-TR,2SC3052F	LHSM	CX-NSZ300
S	POWER AMP	Q	0127 87-A30-076-080	0E	C-TR,2SC3052F	USM	CX-SNAJ300
S	POWER AMP	Q	0127 87-A30-076-080	0E	C-TR,2SC3052F	USM	CX-SNAJ305
S	POWER AMP	Q	0128 87-A30-076-080		C-TR,2SC3052F	LHSM	CX-NSZ300
S	POWER AMP	Q	0128 87-A30-076-080		C-TR,2SC3052F	USM	CX-SNAJ300
S	POWER AMP	Q	0128 87-A30-076-080		C-TR,2SC3052F	EZSM	CX-NSZ300
S	POWER AMP	Q	0128 87-A30-076-080	0E	C-TR,2SC3052F	LHSM	CX-NSZ300
S	POWER AMP	Q	0128 87-A30-076-080	0E	C-TR,2SC3052F	USM	CX-SNAJ300
S	POWER AMP	Q	0128 87-A30-076-080	0E	C-TR,2SC3052F	USM	CX-SNAJ305
S	POWER AMP	Q	0130 87-A30-106-040		C-TR,CMBT5551	LHSM	CX-NSZ300
S	POWER AMP	Q	0130 87-A30-106-040		C-TR,CMBT5551	USM	CX-SNAJ300
S	POWER AMP	Q	0130 87-A30-106-040		C-TR,CMBT5551	USM	CX-SNAJ305
S	POWER AMP	Q	0183 87-A30-162-010		FET,2SK2937	LHSM	CX-NSZ300
S	POWER AMP	Q	0183 87-A30-162-010		FET,2SK2937	USM	CX-SNAJ300
S	POWER AMP	Q	0183 87-A30-162-010		FET,2SK2937	USM	CX-SNAJ305
S	POWER AMP	Q	0183 87-A30-162-010		FET,2SK2937	EZSM	CX-NSZ300
S	POWER AMP	Q	0183 87-A30-162-010	1B	FET,2SK2937	LHSM	CX-NSZ300
S	POWER AMP	Q	0183 87-A30-162-010	1B	FET,2SK2937	USM	CX-SNAJ300
S	POWER AMP	Q	0183 87-A30-162-010	1B	FET,2SK2937	USM	CX-SNAJ305
S	POWER AMP	Q	0184 87-A30-162-010		FET,2SK2937	LHSM	CX-NSZ300
S	POWER AMP	Q	0184 87-A30-162-010		FET,2SK2937	USM	CX-SNAJ300
S	POWER AMP	Q	0184 87-A30-162-010		FET,2SK2937	USM	CX-SNAJ305
S	POWER AMP	Q	0184 87-A30-162-010		FET,2SK2937	EZSM	CX-NSZ300
S	POWER AMP	Q	0184 87-A30-162-010	1B	FET,2SK2937	LHSM	CX-NSZ300
S	POWER AMP	Q	0184 87-A30-162-010	1B	FET,2SK2937	USM	CX-SNAJ300
S	POWER AMP	Q	0184 87-A30-162-010	1B	FET,2SK2937	USM	CX-SNAJ305
S	POWER AMP	Q	0185 87-A30-076-080		C-TR,2SC3052F	LHSM	CX-NSZ300
S	POWER AMP	Q	0185 87-A30-076-080		C-TR,2SC3052F	USM	CX-SNAJ300
S	POWER AMP	Q	0185 87-A30-076-080		C-TR,2SC3052F	USM	CX-SNAJ305

PARTS LIST

! = Δ SAFTY PARTS
 C = Components marked

All components used on this model at the production line are shown in this service manual.

However, please note that not all components will be available as spare parts for after-sales service.

Components marked S and O are designated as spare parts for service and will be stocked at the spare parts centers.

Components marked X and R are not designated as spare parts for after sales service, and will not be stocked at the spare parts centers.

K NO. = Only use japanese.

! C	UNIT NAME	REF NO.	PARTS CODE	K NO.	DESCRIPTION	SUFFIX	MODEL NAME
S	POWER AMP	Q	0185 87-A30-076-080		C-TR,2SC3052F	EZSM	CX-NSZ300
S	POWER AMP	Q	0185 87-A30-076-080	OE	C-TR,2SC3052F	LHSM	CX-NSZ300
S	POWER AMP	Q	0185 87-A30-076-080	OE	C-TR,2SC3052F	USM	CX-SNAJ300
S	POWER AMP	Q	0185 87-A30-076-080	OE	C-TR,2SC3052F	USM	CX-SNAJ305
S	POWER AMP	Q	0186 87-A30-075-080		C-TR,2SA1235F	LHSM	CX-NSZ300
S	POWER AMP	Q	0186 87-A30-075-080		C-TR,2SA1235F	USM	CX-SNAJ300
S	POWER AMP	Q	0186 87-A30-075-080		C-TR,2SA1235F	USM	CX-SNAJ305
S	POWER AMP	Q	0186 87-A30-075-080		C-TR,2SA1235F	EZSM	CX-NSZ300
S	POWER AMP	Q	0186 87-A30-075-080	OE	C-TR,2SA1235F	LHSM	CX-NSZ300
S	POWER AMP	Q	0186 87-A30-075-080	OE	C-TR,2SA1235F	USM	CX-SNAJ300
S	POWER AMP	Q	0186 87-A30-075-080	OE	C-TR,2SA1235F	USM	CX-SNAJ305
S	POWER AMP	Q	0187 87-A30-075-080		C-TR,2SA1235F	LHSM	CX-NSZ300
S	POWER AMP	Q	0187 87-A30-075-080		C-TR,2SA1235F	USM	CX-SNAJ300
S	POWER AMP	Q	0187 87-A30-075-080		C-TR,2SA1235F	USM	CX-SNAJ305
S	POWER AMP	Q	0187 87-A30-075-080		C-TR,2SA1235F	EZSM	CX-NSZ300
S	POWER AMP	Q	0187 87-A30-075-080	OE	C-TR,2SA1235F	LHSM	CX-NSZ300
S	POWER AMP	Q	0187 87-A30-075-080	OE	C-TR,2SA1235F	USM	CX-SNAJ300
S	POWER AMP	Q	0187 87-A30-075-080	OE	C-TR,2SA1235F	USM	CX-SNAJ305
X	POWER AMP	R	0101 88-108-392-080		C-RES,U 3.9K-1/16W J	LHSM	CX-NSZ300
X	POWER AMP	R	0101 88-108-392-080		C-RES,U 3.9K-1/16W J	USM	CX-SNAJ300
X	POWER AMP	R	0101 88-108-392-080		C-RES,U 3.9K-1/16W J	USM	CX-SNAJ305
X	POWER AMP	R	0101 88-108-392-080	OE	C-RES,U 3.9K-1/16W J	LHSM	CX-NSZ300
X	POWER AMP	R	0101 88-108-392-080	OE	C-RES,U 3.9K-1/16W J	USM	CX-SNAJ300
X	POWER AMP	R	0101 88-108-392-080	OE	C-RES,U 3.9K-1/16W J	USM	CX-SNAJ305
X	POWER AMP	R	0101 88-108-472-080		C-RES,U 4.7K-1/16W J	EZSM	CX-NSZ300
X	POWER AMP	R	0102 88-108-392-080		C-RES,U 3.9K-1/16W J	LHSM	CX-NSZ300
X	POWER AMP	R	0102 88-108-392-080		C-RES,U 3.9K-1/16W J	USM	CX-SNAJ300
X	POWER AMP	R	0102 88-108-392-080		C-RES,U 3.9K-1/16W J	USM	CX-SNAJ305
X	POWER AMP	R	0102 88-108-392-080	OE	C-RES,U 3.9K-1/16W J	LHSM	CX-NSZ300
X	POWER AMP	R	0102 88-108-392-080	OE	C-RES,U 3.9K-1/16W J	USM	CX-SNAJ300
X	POWER AMP	R	0102 88-108-392-080	OE	C-RES,U 3.9K-1/16W J	USM	CX-SNAJ305
X	POWER AMP	R	0102 88-108-472-080		C-RES,U 4.7K-1/16W J	EZSM	CX-NSZ300
X	POWER AMP	R	0103 88-108-103-080		C-RES,U 10K-1/16W J	EZSM	CX-NSZ300
X	POWER AMP	R	0103 88-108-393-080		C-RES,U 39K-1/16W J	USM	CX-SNAJ300
X	POWER AMP	R	0103 88-108-393-080		C-RES,U 39K-1/16W J	USM	CX-SNAJ305
X	POWER AMP	R	0103 88-108-393-080	OE	C-RES,U 39K-1/16W J	USM	CX-SNAJ300
X	POWER AMP	R	0103 88-108-393-080	OE	C-RES,U 39K-1/16W J	USM	CX-SNAJ305
X	POWER AMP	R	0103 88-108-683-080		C-RES,U 68K-1/16W J	LHSM	CX-NSZ300
X	POWER AMP	R	0103 88-108-683-080	OE	C-RES,U 68K-1/16W J	LHSM	CX-NSZ300
X	POWER AMP	R	0104 88-108-103-080		C-RES,U 10K-1/16W J	EZSM	CX-NSZ300
X	POWER AMP	R	0104 88-108-393-080		C-RES,U 39K-1/16W J	USM	CX-SNAJ300
X	POWER AMP	R	0104 88-108-393-080		C-RES,U 39K-1/16W J	USM	CX-SNAJ305
X	POWER AMP	R	0104 88-108-393-080	OE	C-RES,U 39K-1/16W J	USM	CX-SNAJ300
X	POWER AMP	R	0104 88-108-393-080	OE	C-RES,U 39K-1/16W J	USM	CX-SNAJ305
X	POWER AMP	R	0104 88-108-683-080	OE	C-RES,U 68K-1/16W J	LHSM	CX-NSZ300
X	POWER AMP	R	0105 88-108-273-080		C-RES,U 27K-1/16W J	LHSM	CX-NSZ300
X	POWER AMP	R	0105 88-108-273-080		C-RES,U 27K-1/16W J	USM	CX-SNAJ300
X	POWER AMP	R	0105 88-108-273-080		C-RES,U 27K-1/16W J	USM	CX-SNAJ305
X	POWER AMP	R	0105 88-108-273-080	OE	C-RES,U 27K-1/16W J	LHSM	CX-NSZ300
X	POWER AMP	R	0105 88-108-273-080	OE	C-RES,U 27K-1/16W J	USM	CX-SNAJ300
X	POWER AMP	R	0105 88-108-273-080	OE	C-RES,U 27K-1/16W J	USM	CX-SNAJ305
X	POWER AMP	R	0106 88-108-273-080		C-RES,U 27K-1/16W J	LHSM	CX-NSZ300
X	POWER AMP	R	0106 88-108-273-080		C-RES,U 27K-1/16W J	USM	CX-SNAJ300
X	POWER AMP	R	0106 88-108-273-080	OE	C-RES,U 27K-1/16W J	USM	CX-SNAJ305
X	POWER AMP	R	0106 88-108-273-080	OE	C-RES,U 27K-1/16W J	USM	CX-SNAJ300
X	POWER AMP	R	0106 88-108-273-080	OE	C-RES,U 27K-1/16W J	USM	CX-SNAJ305
X	POWER AMP	R	0107 88-108-101-080		C-RES,U 100-1/16W J	LHSM	CX-NSZ300
X	POWER AMP	R	0107 88-108-101-080		C-RES,U 100-1/16W J	USM	CX-SNAJ300
X	POWER AMP	R	0107 88-108-101-080		C-RES,U 100-1/16W J	USM	CX-SNAJ305
X	POWER AMP	R	0107 88-108-101-080		C-RES,U 100-1/16W J	EZSM	CX-NSZ300
X	POWER AMP	R	0107 88-108-101-080	OE	C-RES,U 100-1/16W J	LHSM	CX-NSZ300
X	POWER AMP	R	0107 88-108-101-080	OE	C-RES,U 100-1/16W J	USM	CX-SNAJ300
X	POWER AMP	R	0107 88-108-101-080	OE	C-RES,U 100-1/16W J	USM	CX-SNAJ305
X	POWER AMP	R	0108 88-108-101-080		C-RES,U 100-1/16W J	LHSM	CX-NSZ300
X	POWER AMP	R	0108 88-108-101-080		C-RES,U 100-1/16W J	USM	CX-SNAJ300
X	POWER AMP	R	0108 88-108-101-080		C-RES,U 100-1/16W J	USM	CX-SNAJ305

PARTS LIST

! = Δ SAFTY PARTS
 C = Components marked

All components used on this model at the production line are shown in this service manual.

However, please note that not all components will be available as spare parts for after-sales service.

Components marked S and O are designated as spare parts for service and will be stocked at the spare parts centers.

Components marked X and R are not designated as spare parts for after sales service, and will not be stocked at the spare parts centers.

K NO. = Only use japanese.

! C	UNIT NAME	REF NO.	PARTS CODE	K NO.	DESCRIPTION	SUFFIX	MODEL NAME
X	POWER AMP	R	0108 88-108-101-080		C-RES,U 100-1/16W J	EZSM	CX-NSZ300
X	POWER AMP	R	0108 88-108-101-080	OE	C-RES,U 100-1/16W J	LHSM	CX-NSZ300
X	POWER AMP	R	0108 88-108-101-080	OE	C-RES,U 100-1/16W J	USM	CX-SNAJ300
X	POWER AMP	R	0108 88-108-101-080	OE	C-RES,U 100-1/16W J	USM	CX-SNAJ305
X	POWER AMP	R	0109 88-108-472-080		C-RES,U 4.7K-1/16W J	LHSM	CX-NSZ300
X	POWER AMP	R	0109 88-108-472-080		C-RES,U 4.7K-1/16W J	USM	CX-SNAJ300
X	POWER AMP	R	0109 88-108-472-080		C-RES,U 4.7K-1/16W J	USM	CX-SNAJ305
X	POWER AMP	R	0109 88-108-472-080		C-RES,U 4.7K-1/16W J	EZSM	CX-NSZ300
X	POWER AMP	R	0109 88-108-472-080	OE	C-RES,U 4.7K-1/16W J	LHSM	CX-NSZ300
X	POWER AMP	R	0109 88-108-472-080	OE	C-RES,U 4.7K-1/16W J	USM	CX-SNAJ300
X	POWER AMP	R	0109 88-108-472-080	OE	C-RES,U 4.7K-1/16W J	USM	CX-SNAJ305
X	POWER AMP	R	0110 88-108-472-080		C-RES,U 4.7K-1/16W J	LHSM	CX-NSZ300
X	POWER AMP	R	0110 88-108-472-080		C-RES,U 4.7K-1/16W J	USM	CX-SNAJ300
X	POWER AMP	R	0110 88-108-472-080		C-RES,U 4.7K-1/16W J	USM	CX-SNAJ305
X	POWER AMP	R	0110 88-108-472-080		C-RES,U 4.7K-1/16W J	EZSM	CX-NSZ300
X	POWER AMP	R	0110 88-108-472-080	OE	C-RES,U 4.7K-1/16W J	LHSM	CX-NSZ300
X	POWER AMP	R	0110 88-108-472-080	OE	C-RES,U 4.7K-1/16W J	USM	CX-SNAJ300
X	POWER AMP	R	0110 88-108-472-080	OE	C-RES,U 4.7K-1/16W J	USM	CX-SNAJ305
X	POWER AMP	R	0111 88-118-102-080		C-RES,S 1K-1/10W J	LHSM	CX-NSZ300
X	POWER AMP	R	0111 88-118-102-080		C-RES,S 1K-1/10W J	USM	CX-SNAJ300
X	POWER AMP	R	0111 88-118-102-080		C-RES,S 1K-1/10W J	USM	CX-SNAJ305
X	POWER AMP	R	0111 88-118-102-080		C-RES,S 1K-1/10W J	EZSM	CX-NSZ300
X	POWER AMP	R	0111 88-118-102-080	OE	C-RES,S 1K-1/10W J	LHSM	CX-NSZ300
X	POWER AMP	R	0111 88-118-102-080	OE	C-RES,S 1K-1/10W J	USM	CX-SNAJ300
X	POWER AMP	R	0111 88-118-102-080	OE	C-RES,S 1K-1/10W J	USM	CX-SNAJ305
X	POWER AMP	R	0112 88-118-102-080		C-RES,S 1K-1/10W J	LHSM	CX-NSZ300
X	POWER AMP	R	0112 88-118-102-080		C-RES,S 1K-1/10W J	USM	CX-SNAJ300
X	POWER AMP	R	0112 88-118-102-080		C-RES,S 1K-1/10W J	USM	CX-SNAJ305
X	POWER AMP	R	0112 88-118-102-080		C-RES,S 1K-1/10W J	EZSM	CX-NSZ300
X	POWER AMP	R	0112 88-118-102-080	OE	C-RES,S 1K-1/10W J	LHSM	CX-NSZ300
X	POWER AMP	R	0112 88-118-102-080	OE	C-RES,S 1K-1/10W J	USM	CX-SNAJ300
X	POWER AMP	R	0112 88-118-102-080	OE	C-RES,S 1K-1/10W J	USM	CX-SNAJ305
X	POWER AMP	R	0113 88-118-273-080		C-RES,S 27K-1/10W J	LHSM	CX-NSZ300
X	POWER AMP	R	0113 88-118-273-080		C-RES,S 27K-1/10W J	USM	CX-SNAJ300
X	POWER AMP	R	0113 88-118-273-080		C-RES,S 27K-1/10W J	USM	CX-SNAJ305
X	POWER AMP	R	0113 88-118-273-080		C-RES,S 27K-1/10W J	EZSM	CX-NSZ300
X	POWER AMP	R	0113 88-118-273-080	OE	C-RES,S 27K-1/10W J	LHSM	CX-NSZ300
X	POWER AMP	R	0113 88-118-273-080	OE	C-RES,S 27K-1/10W J	USM	CX-SNAJ300
X	POWER AMP	R	0113 88-118-273-080	OE	C-RES,S 27K-1/10W J	USM	CX-SNAJ305
X	POWER AMP	R	0114 88-118-273-080		C-RES,S 27K-1/10W J	LHSM	CX-NSZ300
X	POWER AMP	R	0114 88-118-273-080		C-RES,S 27K-1/10W J	USM	CX-SNAJ300
X	POWER AMP	R	0114 88-118-273-080		C-RES,S 27K-1/10W J	USM	CX-SNAJ305
X	POWER AMP	R	0114 88-118-273-080		C-RES,S 27K-1/10W J	EZSM	CX-NSZ300
X	POWER AMP	R	0114 88-118-273-080	OE	C-RES,S 27K-1/10W J	LHSM	CX-NSZ300
X	POWER AMP	R	0114 88-118-273-080	OE	C-RES,S 27K-1/10W J	USM	CX-SNAJ300
X	POWER AMP	R	0114 88-118-273-080	OE	C-RES,S 27K-1/10W J	USM	CX-SNAJ305
X	POWER AMP	R	0115 88-128-222-080		C-RES, 2.2K-1/8W J	LHSM	CX-NSZ300
X	POWER AMP	R	0115 88-128-222-080		C-RES, 2.2K-1/8W J	USM	CX-SNAJ300
X	POWER AMP	R	0115 88-128-222-080		C-RES, 2.2K-1/8W J	USM	CX-SNAJ305
X	POWER AMP	R	0115 88-128-222-080		C-RES, 2.2K-1/8W J	EZSM	CX-NSZ300
X	POWER AMP	R	0115 88-128-222-080	OE	C-RES, 2.2K-1/8W J	LHSM	CX-NSZ300
X	POWER AMP	R	0115 88-128-222-080	OE	C-RES, 2.2K-1/8W J	USM	CX-SNAJ300
X	POWER AMP	R	0115 88-128-222-080	OE	C-RES, 2.2K-1/8W J	USM	CX-SNAJ305
X	POWER AMP	R	0116 88-128-222-080		C-RES, 2.2K-1/8W J	LHSM	CX-NSZ300
X	POWER AMP	R	0116 88-128-222-080		C-RES, 2.2K-1/8W J	USM	CX-SNAJ300
X	POWER AMP	R	0116 88-128-222-080		C-RES, 2.2K-1/8W J	USM	CX-SNAJ305
X	POWER AMP	R	0116 88-128-222-080		C-RES, 2.2K-1/8W J	EZSM	CX-NSZ300
X	POWER AMP	R	0116 88-128-222-080	OE	C-RES, 2.2K-1/8W J	LHSM	CX-NSZ300
X	POWER AMP	R	0116 88-128-222-080	OE	C-RES, 2.2K-1/8W J	USM	CX-SNAJ300
X	POWER AMP	R	0116 88-128-222-080	OE	C-RES, 2.2K-1/8W J	USM	CX-SNAJ305
X	POWER AMP	R	0117 88-108-103-080		C-RES,U 10K-1/16W J	LHSM	CX-NSZ300
X	POWER AMP	R	0117 88-108-103-080		C-RES,U 10K-1/16W J	USM	CX-SNAJ300
X	POWER AMP	R	0117 88-108-103-080		C-RES,U 10K-1/16W J	USM	CX-SNAJ305
X	POWER AMP	R	0117 88-108-103-080		C-RES,U 10K-1/16W J	EZSM	CX-NSZ300
X	POWER AMP	R	0117 88-108-103-080	OE	C-RES,U 10K-1/16W J	LHSM	CX-NSZ300
X	POWER AMP	R	0117 88-108-103-080	OE	C-RES,U 10K-1/16W J	USM	CX-SNAJ300
X	POWER AMP	R	0117 88-108-103-080	OE	C-RES,U 10K-1/16W J	USM	CX-SNAJ305
X	POWER AMP	R	0118 88-108-103-080		C-RES,U 10K-1/16W J	LHSM	CX-NSZ300
X	POWER AMP	R	0118 88-108-103-080		C-RES,U 10K-1/16W J	USM	CX-SNAJ300
X	POWER AMP	R	0118 88-108-103-080		C-RES,U 10K-1/16W J	USM	CX-SNAJ305

PARTS LIST

! = Δ SAFTY PARTS
 C = Components marked

All components used on this model at the production line are shown in this service manual.

However, please note that not all components will be available as spare parts for after-sales service.

Components marked S and O are designated as spare parts for service and will be stocked at the spare parts centers.

Components marked X and R are not designated as spare parts for after sales service, and will not be stocked at the spare parts centers.

K NO. = Only use japanese.

! C	UNIT NAME	REF NO.	PARTS CODE	K NO.	DESCRIPTION	SUFFIX	MODEL NAME
X	POWER AMP	R	0118 88-108-103-080		C-RES,U 10K-1/16W J	EZSM	CX-NSZ300
X	POWER AMP	R	0118 88-108-103-080	OE	C-RES,U 10K-1/16W J	LHSM	CX-NSZ300
X	POWER AMP	R	0118 88-108-103-080	OE	C-RES,U 10K-1/16W J	USM	CX-SNAJ300
X	POWER AMP	R	0118 88-108-103-080	OE	C-RES,U 10K-1/16W J	USM	CX-SNAJ305
X	POWER AMP	R	0119 88-118-101-080		C-RES,S 100-1/10W J	LHSM	CX-NSZ300
X	POWER AMP	R	0119 88-118-101-080		C-RES,S 100-1/10W J	USM	CX-SNAJ300
X	POWER AMP	R	0119 88-118-101-080		C-RES,S 100-1/10W J	USM	CX-SNAJ305
X	POWER AMP	R	0119 88-118-101-080		C-RES,S 100-1/10W J	EZSM	CX-NSZ300
X	POWER AMP	R	0119 88-118-101-080	OE	C-RES,S 100-1/10W J	LHSM	CX-NSZ300
X	POWER AMP	R	0119 88-118-101-080	OE	C-RES,S 100-1/10W J	USM	CX-SNAJ300
X	POWER AMP	R	0119 88-118-101-080	OE	C-RES,S 100-1/10W J	USM	CX-SNAJ305
X	POWER AMP	R	0120 88-118-101-080		C-RES,S 100-1/10W J	LHSM	CX-NSZ300
X	POWER AMP	R	0120 88-118-101-080		C-RES,S 100-1/10W J	USM	CX-SNAJ300
X	POWER AMP	R	0120 88-118-101-080		C-RES,S 100-1/10W J	USM	CX-SNAJ305
X	POWER AMP	R	0120 88-118-101-080		C-RES,S 100-1/10W J	EZSM	CX-NSZ300
X	POWER AMP	R	0120 88-118-101-080	OE	C-RES,S 100-1/10W J	LHSM	CX-NSZ300
X	POWER AMP	R	0120 88-118-101-080	OE	C-RES,S 100-1/10W J	USM	CX-SNAJ300
X	POWER AMP	R	0120 88-118-101-080	OE	C-RES,S 100-1/10W J	USM	CX-SNAJ305
X	POWER AMP	R	0121 88-118-101-080		C-RES,S 100-1/10W J	LHSM	CX-NSZ300
X	POWER AMP	R	0121 88-118-101-080		C-RES,S 100-1/10W J	USM	CX-SNAJ300
X	POWER AMP	R	0121 88-118-101-080		C-RES,S 100-1/10W J	USM	CX-SNAJ305
X	POWER AMP	R	0121 88-118-101-080		C-RES,S 100-1/10W J	EZSM	CX-NSZ300
X	POWER AMP	R	0121 88-118-101-080	OE	C-RES,S 100-1/10W J	LHSM	CX-NSZ300
X	POWER AMP	R	0121 88-118-101-080	OE	C-RES,S 100-1/10W J	USM	CX-SNAJ300
X	POWER AMP	R	0122 88-118-101-080		C-RES,S 100-1/10W J	LHSM	CX-NSZ300
X	POWER AMP	R	0122 88-118-101-080		C-RES,S 100-1/10W J	USM	CX-SNAJ300
X	POWER AMP	R	0122 88-118-101-080		C-RES,S 100-1/10W J	USM	CX-SNAJ305
X	POWER AMP	R	0122 88-118-101-080		C-RES,S 100-1/10W J	EZSM	CX-NSZ300
X	POWER AMP	R	0122 88-118-101-080	OE	C-RES,S 100-1/10W J	LHSM	CX-NSZ300
X	POWER AMP	R	0122 88-118-101-080	OE	C-RES,S 100-1/10W J	USM	CX-SNAJ300
X	POWER AMP	R	0122 88-118-101-080	OE	C-RES,S 100-1/10W J	USM	CX-SNAJ305
X	POWER AMP	R	0123 88-128-222-080		C-RES, 2.2K-1/8W J	LHSM	CX-NSZ300
X	POWER AMP	R	0123 88-128-222-080		C-RES, 2.2K-1/8W J	USM	CX-SNAJ300
X	POWER AMP	R	0123 88-128-222-080		C-RES, 2.2K-1/8W J	USM	CX-SNAJ305
X	POWER AMP	R	0123 88-128-222-080		C-RES, 2.2K-1/8W J	EZSM	CX-NSZ300
X	POWER AMP	R	0123 88-128-222-080	OE	C-RES, 2.2K-1/8W J	LHSM	CX-NSZ300
X	POWER AMP	R	0123 88-128-222-080	OE	C-RES, 2.2K-1/8W J	USM	CX-SNAJ300
X	POWER AMP	R	0123 88-128-222-080	OE	C-RES, 2.2K-1/8W J	USM	CX-SNAJ305
X	POWER AMP	R	0124 88-128-222-080		C-RES, 2.2K-1/8W J	LHSM	CX-NSZ300
X	POWER AMP	R	0124 88-128-222-080		C-RES, 2.2K-1/8W J	USM	CX-SNAJ300
X	POWER AMP	R	0124 88-128-222-080		C-RES, 2.2K-1/8W J	USM	CX-SNAJ305
X	POWER AMP	R	0124 88-128-222-080		C-RES, 2.2K-1/8W J	EZSM	CX-NSZ300
X	POWER AMP	R	0124 88-128-222-080	OE	C-RES, 2.2K-1/8W J	LHSM	CX-NSZ300
X	POWER AMP	R	0124 88-128-222-080	OE	C-RES, 2.2K-1/8W J	USM	CX-SNAJ300
X	POWER AMP	R	0124 88-128-222-080	OE	C-RES, 2.2K-1/8W J	USM	CX-SNAJ305
X	POWER AMP	R	0125 88-128-102-080		C-RES, 1K-1/8W J	LHSM	CX-NSZ300
X	POWER AMP	R	0125 88-128-102-080		C-RES, 1K-1/8W J	USM	CX-SNAJ300
X	POWER AMP	R	0125 88-128-102-080		C-RES, 1K-1/8W J	USM	CX-SNAJ305
X	POWER AMP	R	0125 88-128-102-080		C-RES, 1K-1/8W J	EZSM	CX-NSZ300
X	POWER AMP	R	0125 88-128-102-080	OE	C-RES, 1K-1/8W J	LHSM	CX-NSZ300
X	POWER AMP	R	0125 88-128-102-080	OE	C-RES, 1K-1/8W J	USM	CX-SNAJ300
X	POWER AMP	R	0125 88-128-102-080	OE	C-RES, 1K-1/8W J	USM	CX-SNAJ305
X	POWER AMP	R	0126 88-128-102-080		C-RES, 1K-1/8W J	LHSM	CX-NSZ300
X	POWER AMP	R	0126 88-128-102-080		C-RES, 1K-1/8W J	USM	CX-SNAJ300
X	POWER AMP	R	0126 88-128-102-080		C-RES, 1K-1/8W J	USM	CX-SNAJ305
X	POWER AMP	R	0126 88-128-102-080		C-RES, 1K-1/8W J	EZSM	CX-NSZ300
X	POWER AMP	R	0126 88-128-102-080	OE	C-RES, 1K-1/8W J	LHSM	CX-NSZ300
X	POWER AMP	R	0126 88-128-102-080	OE	C-RES, 1K-1/8W J	USM	CX-SNAJ300
X	POWER AMP	R	0126 88-128-102-080	OE	C-RES, 1K-1/8W J	USM	CX-SNAJ305
X	POWER AMP	R	0127 88-118-390-080		C-RES,S 39-1/10W J	LHSM	CX-NSZ300
X	POWER AMP	R	0127 88-118-390-080		C-RES,S 39-1/10W J	USM	CX-SNAJ300
X	POWER AMP	R	0127 88-118-390-080		C-RES,S 39-1/10W J	USM	CX-SNAJ305
X	POWER AMP	R	0127 88-118-390-080		C-RES,S 39-1/10W J	EZSM	CX-NSZ300
X	POWER AMP	R	0127 88-118-390-080	OE	C-RES,S 39-1/10W J	LHSM	CX-NSZ300
X	POWER AMP	R	0127 88-118-390-080	OE	C-RES,S 39-1/10W J	USM	CX-SNAJ300
X	POWER AMP	R	0127 88-118-390-080	OE	C-RES,S 39-1/10W J	USM	CX-SNAJ305
X	POWER AMP	R	0128 88-118-390-080		C-RES,S 39-1/10W J	LHSM	CX-NSZ300
X	POWER AMP	R	0128 88-118-390-080		C-RES,S 39-1/10W J	USM	CX-SNAJ300
X	POWER AMP	R	0128 88-118-390-080		C-RES,S 39-1/10W J	USM	CX-SNAJ305

PARTS LIST

! = Δ SAFTY PARTS
 C = Components marked

All components used on this model at the production line are shown in this service manual.

However, please note that not all components will be available as spare parts for after-sales service.

Components marked S and O are designated as spare parts for service and will be stocked at the spare parts centers.

Components marked X and R are not designated as spare parts for after sales service, and will not be stocked at the spare parts centers.

K NO. = Only use japanese.

! C	UNIT NAME	REF NO.	PARTS CODE	K NO.	DESCRIPTION	SUFFIX	MODEL NAME
X	POWER AMP	R	0128 88-118-390-080		C-RES,S 39-1/10W J	EZSM	CX-NSZ300
X	POWER AMP	R	0128 88-118-390-080	OE	C-RES,S 39-1/10W J	LHSM	CX-NSZ300
X	POWER AMP	R	0128 88-118-390-080	OE	C-RES,S 39-1/10W J	USM	CX-SNAJ300
X	POWER AMP	R	0128 88-118-390-080	OE	C-RES,S 39-1/10W J	USM	CX-SNAJ305
O	POWER AMP	R	0129 87-A00-257-080		RES,M/F 0.15-1W J	USM	CX-SNAJ300
O	POWER AMP	R	0129 87-A00-257-080	OE	RES,M/F 0.15-1W J	USM	CX-SNAJ300
O	POWER AMP	R	0129 87-A00-258-080		RES,M/F 0.22-1W J	EZSM	CX-NSZ300
O	POWER AMP	R	0129 87-A00-262-080		RES,M/F 0.15-2W J	LHSM	CX-NSZ300
O	POWER AMP	R	0129 87-A00-262-080		RES,M/F 0.15-2W J	USM	CX-SNAJ305
O	POWER AMP	R	0129 87-A00-262-080	OE	RES,M/F 0.15-2W J	LHSM	CX-NSZ300
O	POWER AMP	R	0129 87-A00-262-080	OE	RES,M/F 0.15-2W J	USM	CX-SNAJ305
O	POWER AMP	R	0130 87-A00-257-080		RES,M/F 0.15-1W J	USM	CX-SNAJ300
O	POWER AMP	R	0130 87-A00-257-080	OE	RES,M/F 0.15-1W J	USM	CX-SNAJ300
O	POWER AMP	R	0130 87-A00-258-080		RES,M/F 0.22-1W J	EZSM	CX-NSZ300
O	POWER AMP	R	0130 87-A00-262-080		RES,M/F 0.15-2W J	LHSM	CX-NSZ300
O	POWER AMP	R	0130 87-A00-262-080		RES,M/F 0.15-2W J	USM	CX-SNAJ305
O	POWER AMP	R	0130 87-A00-262-080	OE	RES,M/F 0.15-2W J	LHSM	CX-NSZ300
O	POWER AMP	R	0130 87-A00-262-080	OE	RES,M/F 0.15-2W J	USM	CX-SNAJ305
O	POWER AMP	R	0131 87-A00-257-080		RES,M/F 0.15-1W J	USM	CX-SNAJ300
O	POWER AMP	R	0131 87-A00-257-080	OE	RES,M/F 0.15-1W J	USM	CX-SNAJ300
O	POWER AMP	R	0131 87-A00-258-080		RES,M/F 0.22-1W J	EZSM	CX-NSZ300
O	POWER AMP	R	0131 87-A00-262-080		RES,M/F 0.15-2W J	LHSM	CX-NSZ300
O	POWER AMP	R	0131 87-A00-262-080		RES,M/F 0.15-2W J	USM	CX-SNAJ305
O	POWER AMP	R	0131 87-A00-262-080	OE	RES,M/F 0.15-2W J	LHSM	CX-NSZ300
O	POWER AMP	R	0131 87-A00-262-080	OE	RES,M/F 0.15-2W J	USM	CX-SNAJ305
O	POWER AMP	R	0132 87-A00-257-080		RES,M/F 0.15-1W J	USM	CX-SNAJ300
O	POWER AMP	R	0132 87-A00-257-080	OE	RES,M/F 0.15-1W J	USM	CX-SNAJ300
O	POWER AMP	R	0132 87-A00-258-080		RES,M/F 0.22-1W J	EZSM	CX-NSZ300
O	POWER AMP	R	0132 87-A00-262-080		RES,M/F 0.15-2W J	LHSM	CX-NSZ300
O	POWER AMP	R	0132 87-A00-262-080		RES,M/F 0.15-2W J	USM	CX-SNAJ305
O	POWER AMP	R	0132 87-A00-262-080	OE	RES,M/F 0.15-2W J	LHSM	CX-NSZ300
O	POWER AMP	R	0132 87-A00-262-080	OE	RES,M/F 0.15-2W J	USM	CX-SNAJ305
X	POWER AMP	R	0133 88-108-332-080		C-RES,U 3.3K-1/16W J	EZSM	CX-NSZ300
X	POWER AMP	R	0133 88-108-392-080		C-RES,U 3.9K-1/16W J	USM	CX-SNAJ305
X	POWER AMP	R	0133 88-108-392-080	OE	C-RES,U 3.9K-1/16W J	USM	CX-SNAJ305
X	POWER AMP	R	0133 88-108-472-080		C-RES,U 4.7K-1/16W J	LHSM	CX-NSZ300
X	POWER AMP	R	0133 88-108-472-080		C-RES,U 4.7K-1/16W J	USM	CX-SNAJ300
X	POWER AMP	R	0133 88-108-472-080	OE	C-RES,U 4.7K-1/16W J	LHSM	CX-NSZ300
X	POWER AMP	R	0133 88-108-472-080	OE	C-RES,U 4.7K-1/16W J	USM	CX-SNAJ300
X	POWER AMP	R	0134 88-108-332-080		C-RES,U 3.3K-1/16W J	EZSM	CX-NSZ300
X	POWER AMP	R	0134 88-108-392-080		C-RES,U 3.9K-1/16W J	USM	CX-SNAJ305
X	POWER AMP	R	0134 88-108-392-080	OE	C-RES,U 3.9K-1/16W J	USM	CX-SNAJ305
X	POWER AMP	R	0134 88-108-472-080		C-RES,U 4.7K-1/16W J	LHSM	CX-NSZ300
X	POWER AMP	R	0134 88-108-472-080		C-RES,U 4.7K-1/16W J	USM	CX-SNAJ300
X	POWER AMP	R	0134 88-108-472-080	OE	C-RES,U 4.7K-1/16W J	LHSM	CX-NSZ300
X	POWER AMP	R	0134 88-108-472-080	OE	C-RES,U 4.7K-1/16W J	USM	CX-SNAJ300
X	POWER AMP	R	0135 88-108-122-080		C-RES,U 1.2K-1/16W J	USM	CX-SNAJ300
X	POWER AMP	R	0135 88-108-122-080	OE	C-RES,U 1.2K-1/16W J	USM	CX-SNAJ300
X	POWER AMP	R	0135 88-108-152-080		C-RES,U 1.5K-1/16W J	LHSM	CX-NSZ300
X	POWER AMP	R	0135 88-108-152-080		C-RES,U 1.5K-1/16W J	EZSM	CX-NSZ300
X	POWER AMP	R	0135 88-108-152-080	OE	C-RES,U 1.5K-1/16W J	LHSM	CX-NSZ300
X	POWER AMP	R	0135 88-108-182-080		C-RES,U 1.8K-1/16W J	USM	CX-SNAJ305
X	POWER AMP	R	0135 88-108-182-080	OE	C-RES,U 1.8K-1/16W J	USM	CX-SNAJ305
X	POWER AMP	R	0136 88-108-122-080		C-RES,U 1.2K-1/16W J	USM	CX-SNAJ300
X	POWER AMP	R	0136 88-108-122-080	OE	C-RES,U 1.2K-1/16W J	USM	CX-SNAJ300
X	POWER AMP	R	0136 88-108-152-080		C-RES,U 1.5K-1/16W J	LHSM	CX-NSZ300
X	POWER AMP	R	0136 88-108-152-080		C-RES,U 1.5K-1/16W J	EZSM	CX-NSZ300
X	POWER AMP	R	0136 88-108-152-080	OE	C-RES,U 1.5K-1/16W J	LHSM	CX-NSZ300
X	POWER AMP	R	0136 88-108-182-080		C-RES,U 1.8K-1/16W J	USM	CX-SNAJ305
X	POWER AMP	R	0136 88-108-182-080	OE	C-RES,U 1.8K-1/16W J	USM	CX-SNAJ305
X	POWER AMP	R	0137 88-108-101-080		C-RES,U 100-1/16W J	LHSM	CX-NSZ300
X	POWER AMP	R	0137 88-108-101-080		C-RES,U 100-1/16W J	USM	CX-SNAJ300
X	POWER AMP	R	0137 88-108-101-080		C-RES,U 100-1/16W J	USM	CX-SNAJ305
X	POWER AMP	R	0137 88-108-101-080		C-RES,U 100-1/16W J	EZSM	CX-NSZ300
X	POWER AMP	R	0137 88-108-101-080	OE	C-RES,U 100-1/16W J	LHSM	CX-NSZ300
X	POWER AMP	R	0137 88-108-101-080	OE	C-RES,U 100-1/16W J	USM	CX-SNAJ300
X	POWER AMP	R	0137 88-108-101-080	OE	C-RES,U 100-1/16W J	USM	CX-SNAJ305
X	POWER AMP	R	0138 88-108-101-080		C-RES,U 100-1/16W J	LHSM	CX-NSZ300
X	POWER AMP	R	0138 88-108-101-080		C-RES,U 100-1/16W J	USM	CX-SNAJ300
X	POWER AMP	R	0138 88-108-101-080		C-RES,U 100-1/16W J	USM	CX-SNAJ305

PARTS LIST

! = Δ SAFETY PARTS
 C = Components marked

All components used on this model at the production line are shown in this service manual.

However, please note that not all components will be available as spare parts for after-sales service.

Components marked S and O are designated as spare parts for service and will be stocked at the spare parts centers.

Components marked X and R are not designated as spare parts for after sales service, and will not be stocked at the spare parts centers.

K NO. = Only use Japanese.

! C	UNIT NAME	REF NO.	PARTS CODE	K NO.	DESCRIPTION	SUFFIX	MODEL NAME
X	POWER AMP	R	0138 88-108-101-080		C-RES,U 100-1/16W J	EZSM	CX-NSZ300
X	POWER AMP	R	0138 88-108-101-080	OE	C-RES,U 100-1/16W J	LHSM	CX-NSZ300
X	POWER AMP	R	0138 88-108-101-080	OE	C-RES,U 100-1/16W J	USM	CX-SNAJ300
X	POWER AMP	R	0138 88-108-101-080	OE	C-RES,U 100-1/16W J	USM	CX-SNAJ305
X	POWER AMP	R	0141 88-118-102-080		C-RES,S 1K-1/10W J	LHSM	CX-NSZ300
X	POWER AMP	R	0141 88-118-102-080		C-RES,S 1K-1/10W J	USM	CX-SNAJ300
X	POWER AMP	R	0141 88-118-102-080		C-RES,S 1K-1/10W J	USM	CX-SNAJ305
X	POWER AMP	R	0141 88-118-102-080		C-RES,S 1K-1/10W J	EZSM	CX-NSZ300
X	POWER AMP	R	0141 88-118-102-080	OE	C-RES,S 1K-1/10W J	LHSM	CX-NSZ300
X	POWER AMP	R	0141 88-118-102-080	OE	C-RES,S 1K-1/10W J	USM	CX-SNAJ300
X	POWER AMP	R	0141 88-118-102-080	OE	C-RES,S 1K-1/10W J	USM	CX-SNAJ305
X	POWER AMP	R	0142 88-118-102-080		C-RES,S 1K-1/10W J	LHSM	CX-NSZ300
X	POWER AMP	R	0142 88-118-102-080		C-RES,S 1K-1/10W J	USM	CX-SNAJ300
X	POWER AMP	R	0142 88-118-102-080		C-RES,S 1K-1/10W J	USM	CX-SNAJ305
X	POWER AMP	R	0142 88-118-102-080		C-RES,S 1K-1/10W J	EZSM	CX-NSZ300
X	POWER AMP	R	0142 88-118-102-080	OE	C-RES,S 1K-1/10W J	LHSM	CX-NSZ300
X	POWER AMP	R	0142 88-118-102-080	OE	C-RES,S 1K-1/10W J	USM	CX-SNAJ300
X	POWER AMP	R	0142 88-118-102-080	OE	C-RES,S 1K-1/10W J	USM	CX-SNAJ305
X	POWER AMP	R	0151 88-108-473-080		C-RES,U 47K-1/16W J	LHSM	CX-NSZ300
X	POWER AMP	R	0151 88-108-473-080		C-RES,U 47K-1/16W J	USM	CX-SNAJ300
X	POWER AMP	R	0151 88-108-473-080		C-RES,U 47K-1/16W J	USM	CX-SNAJ305
X	POWER AMP	R	0151 88-108-473-080		C-RES,U 47K-1/16W J	EZSM	CX-NSZ300
X	POWER AMP	R	0151 88-108-473-080	OE	C-RES,U 47K-1/16W J	LHSM	CX-NSZ300
X	POWER AMP	R	0151 88-108-473-080	OE	C-RES,U 47K-1/16W J	USM	CX-SNAJ300
X	POWER AMP	R	0151 88-108-473-080	OE	C-RES,U 47K-1/16W J	USM	CX-SNAJ305
X	POWER AMP	R	0152 88-108-473-080		C-RES,U 47K-1/16W J	LHSM	CX-NSZ300
X	POWER AMP	R	0152 88-108-473-080		C-RES,U 47K-1/16W J	USM	CX-SNAJ300
X	POWER AMP	R	0152 88-108-473-080		C-RES,U 47K-1/16W J	USM	CX-SNAJ305
X	POWER AMP	R	0152 88-108-473-080		C-RES,U 47K-1/16W J	EZSM	CX-NSZ300
X	POWER AMP	R	0152 88-108-473-080	OE	C-RES,U 47K-1/16W J	LHSM	CX-NSZ300
X	POWER AMP	R	0152 88-108-473-080	OE	C-RES,U 47K-1/16W J	USM	CX-SNAJ300
X	POWER AMP	R	0152 88-108-473-080	OE	C-RES,U 47K-1/16W J	USM	CX-SNAJ305
X	POWER AMP	R	0153 88-118-390-080		C-RES,S 39-1/10W J	LHSM	CX-NSZ300
X	POWER AMP	R	0153 88-118-390-080		C-RES,S 39-1/10W J	USM	CX-SNAJ300
X	POWER AMP	R	0153 88-118-390-080		C-RES,S 39-1/10W J	USM	CX-SNAJ305
X	POWER AMP	R	0153 88-118-390-080		C-RES,S 39-1/10W J	EZSM	CX-NSZ300
X	POWER AMP	R	0153 88-118-390-080	OE	C-RES,S 39-1/10W J	LHSM	CX-NSZ300
X	POWER AMP	R	0153 88-118-390-080	OE	C-RES,S 39-1/10W J	USM	CX-SNAJ300
X	POWER AMP	R	0153 88-118-390-080	OE	C-RES,S 39-1/10W J	USM	CX-SNAJ305
X	POWER AMP	R	0154 88-118-390-080		C-RES,S 39-1/10W J	LHSM	CX-NSZ300
X	POWER AMP	R	0154 88-118-390-080		C-RES,S 39-1/10W J	USM	CX-SNAJ300
X	POWER AMP	R	0154 88-118-390-080		C-RES,S 39-1/10W J	USM	CX-SNAJ305
X	POWER AMP	R	0154 88-118-390-080		C-RES,S 39-1/10W J	EZSM	CX-NSZ300
X	POWER AMP	R	0154 88-118-390-080	OE	C-RES,S 39-1/10W J	LHSM	CX-NSZ300
X	POWER AMP	R	0154 88-118-390-080	OE	C-RES,S 39-1/10W J	USM	CX-SNAJ300
X	POWER AMP	R	0154 88-118-390-080	OE	C-RES,S 39-1/10W J	USM	CX-SNAJ305
X	POWER AMP	R	0155 88-108-472-080		C-RES,U 4.7K-1/16W J	USM	CX-SNAJ305
X	POWER AMP	R	0155 88-108-472-080	OE	C-RES,U 4.7K-1/16W J	USM	CX-SNAJ305
X	POWER AMP	R	0155 88-108-682-080		C-RES,U 6.8K-1/16W J	EZSM	CX-NSZ300
X	POWER AMP	R	0155 88-108-822-080		C-RES,U 8.2K-1/16W J	LHSM	CX-NSZ300
X	POWER AMP	R	0155 88-108-822-080		C-RES,U 8.2K-1/16W J	USM	CX-SNAJ300
X	POWER AMP	R	0155 88-108-822-080	OE	C-RES,U 8.2K-1/16W J	LHSM	CX-NSZ300
X	POWER AMP	R	0155 88-108-822-080	OE	C-RES,U 8.2K-1/16W J	USM	CX-SNAJ300
X	POWER AMP	R	0156 88-108-472-080		C-RES,U 4.7K-1/16W J	USM	CX-SNAJ305
X	POWER AMP	R	0156 88-108-472-080	OE	C-RES,U 4.7K-1/16W J	USM	CX-SNAJ305
X	POWER AMP	R	0156 88-108-682-080		C-RES,U 6.8K-1/16W J	EZSM	CX-NSZ300
X	POWER AMP	R	0156 88-108-822-080		C-RES,U 8.2K-1/16W J	LHSM	CX-NSZ300
X	POWER AMP	R	0156 88-108-822-080		C-RES,U 8.2K-1/16W J	USM	CX-SNAJ300
X	POWER AMP	R	0156 88-108-822-080	OE	C-RES,U 8.2K-1/16W J	LHSM	CX-NSZ300
X	POWER AMP	R	0156 88-108-822-080	OE	C-RES,U 8.2K-1/16W J	USM	CX-SNAJ300
X	POWER AMP	R	0157 88-108-472-080		C-RES,U 4.7K-1/16W J	LHSM	CX-NSZ300
X	POWER AMP	R	0157 88-108-472-080		C-RES,U 4.7K-1/16W J	USM	CX-SNAJ300
X	POWER AMP	R	0157 88-108-472-080		C-RES,U 4.7K-1/16W J	USM	CX-SNAJ305
X	POWER AMP	R	0157 88-108-472-080		C-RES,U 4.7K-1/16W J	EZSM	CX-NSZ300
X	POWER AMP	R	0157 88-108-472-080	OE	C-RES,U 4.7K-1/16W J	LHSM	CX-NSZ300
X	POWER AMP	R	0157 88-108-472-080	OE	C-RES,U 4.7K-1/16W J	USM	CX-SNAJ300
X	POWER AMP	R	0157 88-108-472-080	OE	C-RES,U 4.7K-1/16W J	USM	CX-SNAJ305
X	POWER AMP	R	0159 88-108-103-080		C-RES,U 10K-1/16W J	LHSM	CX-NSZ300
X	POWER AMP	R	0159 88-108-103-080		C-RES,U 10K-1/16W J	USM	CX-SNAJ300
X	POWER AMP	R	0159 88-108-103-080		C-RES,U 10K-1/16W J	USM	CX-SNAJ305

PARTS LIST

! = Δ SAFTY PARTS
 C = Components marked

All components used on this model at the production line are shown in this service manual.

However, please note that not all components will be available as spare parts for after-sales service.

Components marked S and O are designated as spare parts for service and will be stocked at the spare parts centers.

Components marked X and R are not designated as spare parts for after sales service, and will not be stocked at the spare parts centers.

K NO. = Only use japanese.

! C	UNIT NAME	REF NO.	PARTS CODE	K NO.	DESCRIPTION	SUFFIX	MODEL NAME
X	POWER AMP	R	0170 88-118-271-080	OE	C-RES,S 270-1/10W J	USM	CX-SNAJ300
X	POWER AMP	R	0170 88-118-271-080	OE	C-RES,S 270-1/10W J	USM	CX-SNAJ305
X	POWER AMP	R	0170 88-118-561-080		C-RES,S 560-1/10W J	LHSM	CX-NSZ300
X	POWER AMP	R	0170 88-118-561-080		C-RES,S 560-1/10W J	USM	CX-SNAJ300
X	POWER AMP	R	0170 88-118-561-080		C-RES,S 560-1/10W J	USM	CX-SNAJ305
X	POWER AMP	R	0171 88-118-222-080		C-RES,S 2.2K-1/10W J	EZSM	CX-NSZ300
X	POWER AMP	R	0171 88-118-222-080	OE	C-RES,S 2.2K-1/10W J	LHSM	CX-NSZ300
X	POWER AMP	R	0171 88-118-222-080	OE	C-RES,S 2.2K-1/10W J	USM	CX-SNAJ300
X	POWER AMP	R	0171 88-118-222-080	OE	C-RES,S 2.2K-1/10W J	USM	CX-SNAJ305
X	POWER AMP	R	0171 88-118-562-080		C-RES,S 5.6K-1/10W J	LHSM	CX-NSZ300
X	POWER AMP	R	0171 88-118-562-080		C-RES,S 5.6K-1/10W J	USM	CX-SNAJ300
X	POWER AMP	R	0171 88-118-562-080		C-RES,S 5.6K-1/10W J	USM	CX-SNAJ305
X	POWER AMP	R	0172 88-118-222-080		C-RES,S 2.2K-1/10W J	EZSM	CX-NSZ300
X	POWER AMP	R	0172 88-118-222-080	OE	C-RES,S 2.2K-1/10W J	LHSM	CX-NSZ300
X	POWER AMP	R	0172 88-118-222-080	OE	C-RES,S 2.2K-1/10W J	USM	CX-SNAJ300
X	POWER AMP	R	0172 88-118-222-080	OE	C-RES,S 2.2K-1/10W J	USM	CX-SNAJ305
X	POWER AMP	R	0172 88-118-562-080		C-RES,S 5.6K-1/10W J	LHSM	CX-NSZ300
X	POWER AMP	R	0172 88-118-562-080		C-RES,S 5.6K-1/10W J	USM	CX-SNAJ300
X	POWER AMP	R	0172 88-118-562-080		C-RES,S 5.6K-1/10W J	USM	CX-SNAJ305
X	POWER AMP	R	0173 88-118-152-080		C-RES,S 1.5K-1/10W J	EZSM	CX-NSZ300
X	POWER AMP	R	0173 88-118-152-080	OE	C-RES,S 1.5K-1/10W J	LHSM	CX-NSZ300
X	POWER AMP	R	0173 88-118-152-080	OE	C-RES,S 1.5K-1/10W J	USM	CX-SNAJ300
X	POWER AMP	R	0173 88-118-152-080	OE	C-RES,S 1.5K-1/10W J	USM	CX-SNAJ305
X	POWER AMP	R	0173 88-118-332-080		C-RES,S 3.3K-1/10W J	LHSM	CX-NSZ300
X	POWER AMP	R	0173 88-118-332-080		C-RES,S 3.3K-1/10W J	USM	CX-SNAJ300
X	POWER AMP	R	0173 88-118-332-080		C-RES,S 3.3K-1/10W J	USM	CX-SNAJ305
X	POWER AMP	R	0174 88-118-152-080		C-RES,S 1.5K-1/10W J	EZSM	CX-NSZ300
X	POWER AMP	R	0174 88-118-152-080	OE	C-RES,S 1.5K-1/10W J	LHSM	CX-NSZ300
X	POWER AMP	R	0174 88-118-152-080	OE	C-RES,S 1.5K-1/10W J	USM	CX-SNAJ300
X	POWER AMP	R	0174 88-118-152-080	OE	C-RES,S 1.5K-1/10W J	USM	CX-SNAJ305
X	POWER AMP	R	0174 88-118-332-080		C-RES,S 3.3K-1/10W J	LHSM	CX-NSZ300
X	POWER AMP	R	0174 88-118-332-080		C-RES,S 3.3K-1/10W J	USM	CX-SNAJ300
X	POWER AMP	R	0174 88-118-332-080		C-RES,S 3.3K-1/10W J	USM	CX-SNAJ305
X	POWER AMP	R	0175 88-118-331-080		C-RES,S 330-1/10W J	LHSM	CX-NSZ300
X	POWER AMP	R	0175 88-118-331-080		C-RES,S 330-1/10W J	USM	CX-SNAJ300
X	POWER AMP	R	0175 88-118-331-080		C-RES,S 330-1/10W J	USM	CX-SNAJ305
X	POWER AMP	R	0175 88-118-331-080		C-RES,S 330-1/10W J	EZSM	CX-NSZ300
X	POWER AMP	R	0175 88-118-331-080	OE	C-RES,S 330-1/10W J	LHSM	CX-NSZ300
X	POWER AMP	R	0175 88-118-331-080	OE	C-RES,S 330-1/10W J	USM	CX-SNAJ300
X	POWER AMP	R	0175 88-118-331-080	OE	C-RES,S 330-1/10W J	USM	CX-SNAJ305
X	POWER AMP	R	0176 88-118-331-080		C-RES,S 330-1/10W J	EZSM	CX-NSZ300
X	POWER AMP	R	0176 88-118-331-080	OE	C-RES,S 330-1/10W J	LHSM	CX-NSZ300
X	POWER AMP	R	0176 88-118-331-080	OE	C-RES,S 330-1/10W J	USM	CX-SNAJ300
X	POWER AMP	R	0176 88-118-331-080	OE	C-RES,S 330-1/10W J	USM	CX-SNAJ305
X	POWER AMP	R	0176 88-121-331-080		RES, 330-1/8W J	LHSM	CX-NSZ300
X	POWER AMP	R	0176 88-121-331-080		RES, 330-1/8W J	USM	CX-SNAJ300
X	POWER AMP	R	0176 88-121-331-080		RES, 330-1/8W J	USM	CX-SNAJ305
X	POWER AMP	R	0177 88-128-222-080		C-RES, 2.2K-1/8W J	LHSM	CX-NSZ300
X	POWER AMP	R	0177 88-128-222-080		C-RES, 2.2K-1/8W J	USM	CX-SNAJ300
X	POWER AMP	R	0177 88-128-222-080		C-RES, 2.2K-1/8W J	USM	CX-SNAJ305
X	POWER AMP	R	0177 88-128-222-080	OE	C-RES, 2.2K-1/8W J	EZSM	CX-NSZ300
X	POWER AMP	R	0177 88-128-222-080	OE	C-RES, 2.2K-1/8W J	LHSM	CX-NSZ300
X	POWER AMP	R	0177 88-128-222-080	OE	C-RES, 2.2K-1/8W J	USM	CX-SNAJ300
X	POWER AMP	R	0177 88-128-222-080	OE	C-RES, 2.2K-1/8W J	USM	CX-SNAJ305
X	POWER AMP	R	0178 88-118-103-080		C-RES,S 10K-1/10W J	LHSM	CX-NSZ300
X	POWER AMP	R	0178 88-118-103-080		C-RES,S 10K-1/10W J	USM	CX-SNAJ300
X	POWER AMP	R	0178 88-118-103-080		C-RES,S 10K-1/10W J	USM	CX-SNAJ305
X	POWER AMP	R	0178 88-118-103-080		C-RES,S 10K-1/10W J	EZSM	CX-NSZ300
X	POWER AMP	R	0178 88-118-103-080	OE	C-RES,S 10K-1/10W J	LHSM	CX-NSZ300
X	POWER AMP	R	0178 88-118-103-080	OE	C-RES,S 10K-1/10W J	USM	CX-SNAJ300
X	POWER AMP	R	0178 88-118-103-080	OE	C-RES,S 10K-1/10W J	USM	CX-SNAJ305
X	POWER AMP	R	0179 88-108-103-080		C-RES,U 10K-1/16W J	USM	CX-SNAJ300
X	POWER AMP	R	0179 88-108-103-080		C-RES,U 10K-1/16W J	LHSM	CX-NSZ300
X	POWER AMP	R	0179 88-108-103-080		C-RES,U 10K-1/16W J	USM	CX-SNAJ300
X	POWER AMP	R	0179 88-108-103-080		C-RES,U 10K-1/16W J	USM	CX-SNAJ305
X	POWER AMP	R	0179 88-108-103-080		C-RES,U 10K-1/16W J	EZSM	CX-NSZ300
X	POWER AMP	R	0179 88-108-103-080	OE	C-RES,U 10K-1/16W J	LHSM	CX-NSZ300
X	POWER AMP	R	0179 88-108-103-080	OE	C-RES,U 10K-1/16W J	USM	CX-SNAJ300
X	POWER AMP	R	0179 88-108-103-080	OE	C-RES,U 10K-1/16W J	USM	CX-SNAJ305
X	POWER AMP	R	0180 88-108-103-080		C-RES,U 10K-1/16W J	LHSM	CX-NSZ300
X	POWER AMP	R	0180 88-108-103-080		C-RES,U 10K-1/16W J	USM	CX-SNAJ300

PARTS LIST

! = Δ SAFTY PARTS
 C = Components marked

All components used on this model at the production line are shown in this service manual.

However, please note that not all components will be available as spare parts for after-sales service.

Components marked S and O are designated as spare parts for service and will be stocked at the spare parts centers.

Components marked X and R are not designated as spare parts for after sales service, and will not be stocked at the spare parts centers.

K NO. = Only use japanese.

! C	UNIT NAME	REF NO.	PARTS CODE	K NO.	DESCRIPTION	SUFFIX	MODEL NAME
X	POWER AMP	R	0180 88-108-103-080		C-RES,U 10K-1/16W J	USM	CX-SNAJ305
X	POWER AMP	R	0180 88-108-103-080		C-RES,U 10K-1/16W J	EZSM	CX-NSZ300
X	POWER AMP	R	0180 88-108-103-080	OE	C-RES,U 10K-1/16W J	LHSM	CX-NSZ300
X	POWER AMP	R	0180 88-108-103-080	OE	C-RES,U 10K-1/16W J	USM	CX-SNAJ300
X	POWER AMP	R	0180 88-108-103-080	OE	C-RES,U 10K-1/16W J	USM	CX-SNAJ305
X	POWER AMP	R	0184 88-118-102-080		C-RES,S 1K-1/10W J	LHSM	CX-NSZ300
X	POWER AMP	R	0184 88-118-102-080		C-RES,S 1K-1/10W J	USM	CX-SNAJ300
X	POWER AMP	R	0184 88-118-102-080		C-RES,S 1K-1/10W J	USM	CX-SNAJ305
X	POWER AMP	R	0184 88-118-102-080		C-RES,S 1K-1/10W J	EZSM	CX-NSZ300
X	POWER AMP	R	0184 88-118-102-080	OE	C-RES,S 1K-1/10W J	LHSM	CX-NSZ300
X	POWER AMP	R	0184 88-118-102-080	OE	C-RES,S 1K-1/10W J	USM	CX-SNAJ300
X	POWER AMP	R	0185 88-108-332-080		C-RES,U 3.3K-1/16W J	LHSM	CX-NSZ300
X	POWER AMP	R	0185 88-108-332-080		C-RES,U 3.3K-1/16W J	USM	CX-SNAJ300
X	POWER AMP	R	0185 88-108-332-080		C-RES,U 3.3K-1/16W J	USM	CX-SNAJ305
X	POWER AMP	R	0185 88-108-332-080		C-RES,U 3.3K-1/16W J	EZSM	CX-NSZ300
X	POWER AMP	R	0185 88-108-332-080	OE	C-RES,U 3.3K-1/16W J	LHSM	CX-NSZ300
X	POWER AMP	R	0185 88-108-332-080	OE	C-RES,U 3.3K-1/16W J	USM	CX-SNAJ300
X	POWER AMP	R	0185 88-108-332-080	OE	C-RES,U 3.3K-1/16W J	USM	CX-SNAJ305
X	POWER AMP	R	0186 88-118-222-080		C-RES,S 2.2K-1/10W J	LHSM	CX-NSZ300
X	POWER AMP	R	0186 88-118-222-080		C-RES,S 2.2K-1/10W J	USM	CX-SNAJ300
X	POWER AMP	R	0186 88-118-222-080		C-RES,S 2.2K-1/10W J	USM	CX-SNAJ305
X	POWER AMP	R	0186 88-118-222-080	OE	C-RES,S 2.2K-1/10W J	EZSM	CX-NSZ300
X	POWER AMP	R	0186 88-118-222-080	OE	C-RES,S 2.2K-1/10W J	LHSM	CX-NSZ300
X	POWER AMP	R	0186 88-118-222-080	OE	C-RES,S 2.2K-1/10W J	USM	CX-SNAJ300
X	POWER AMP	R	0186 88-118-222-080	OE	C-RES,S 2.2K-1/10W J	USM	CX-SNAJ305
X	POWER AMP	R	0187 88-118-103-080		C-RES,S 10K-1/10W J	LHSM	CX-NSZ300
X	POWER AMP	R	0187 88-118-103-080		C-RES,S 10K-1/10W J	USM	CX-SNAJ300
X	POWER AMP	R	0187 88-118-103-080		C-RES,S 10K-1/10W J	USM	CX-SNAJ305
X	POWER AMP	R	0187 88-118-103-080		C-RES,S 10K-1/10W J	EZSM	CX-NSZ300
X	POWER AMP	R	0187 88-118-103-080	OE	C-RES,S 10K-1/10W J	LHSM	CX-NSZ300
X	POWER AMP	R	0187 88-118-103-080	OE	C-RES,S 10K-1/10W J	USM	CX-SNAJ300
X	POWER AMP	R	0187 88-118-103-080	OE	C-RES,S 10K-1/10W J	USM	CX-SNAJ305
X	POWER AMP	R	0188 88-118-472-080		C-RES,S 4.7K-1/10W J	LHSM	CX-NSZ300
X	POWER AMP	R	0188 88-118-472-080		C-RES,S 4.7K-1/10W J	USM	CX-SNAJ300
X	POWER AMP	R	0188 88-118-472-080		C-RES,S 4.7K-1/10W J	USM	CX-SNAJ305
X	POWER AMP	R	0188 88-118-472-080		C-RES,S 4.7K-1/10W J	EZSM	CX-NSZ300
X	POWER AMP	R	0188 88-118-472-080	OE	C-RES,S 4.7K-1/10W J	LHSM	CX-NSZ300
X	POWER AMP	R	0188 88-118-472-080	OE	C-RES,S 4.7K-1/10W J	USM	CX-SNAJ300
X	POWER AMP	R	0188 88-118-472-080	OE	C-RES,S 4.7K-1/10W J	USM	CX-SNAJ305
X	POWER AMP	R	0189 88-128-272-080		C-RES, 2.7K-1/8W J	LHSM	CX-NSZ300
X	POWER AMP	R	0189 88-128-272-080		C-RES, 2.7K-1/8W J	USM	CX-SNAJ300
X	POWER AMP	R	0189 88-128-272-080		C-RES, 2.7K-1/8W J	USM	CX-SNAJ305
X	POWER AMP	R	0189 88-128-272-080		C-RES, 2.7K-1/8W J	EZSM	CX-NSZ300
X	POWER AMP	R	0189 88-128-272-080	OE	C-RES, 2.7K-1/8W J	LHSM	CX-NSZ300
X	POWER AMP	R	0189 88-128-272-080	OE	C-RES, 2.7K-1/8W J	USM	CX-SNAJ300
X	POWER AMP	R	0189 88-128-272-080	OE	C-RES, 2.7K-1/8W J	USM	CX-SNAJ305
X	POWER AMP	R	0190 88-128-272-080		C-RES, 2.7K-1/8W J	LHSM	CX-NSZ300
X	POWER AMP	R	0190 88-128-272-080		C-RES, 2.7K-1/8W J	USM	CX-SNAJ300
X	POWER AMP	R	0190 88-128-272-080		C-RES, 2.7K-1/8W J	USM	CX-SNAJ305
X	POWER AMP	R	0190 88-128-272-080	OE	C-RES, 2.7K-1/8W J	EZSM	CX-NSZ300
X	POWER AMP	R	0190 88-128-272-080	OE	C-RES, 2.7K-1/8W J	LHSM	CX-NSZ300
X	POWER AMP	R	0190 88-128-272-080	OE	C-RES, 2.7K-1/8W J	USM	CX-SNAJ300
X	POWER AMP	R	0192 88-128-222-080		C-RES, 2.2K-1/8W J	LHSM	CX-NSZ300
X	POWER AMP	R	0192 88-128-222-080		C-RES, 2.2K-1/8W J	USM	CX-SNAJ300
X	POWER AMP	R	0192 88-128-222-080		C-RES, 2.2K-1/8W J	USM	CX-SNAJ305
X	POWER AMP	R	0192 88-128-222-080		C-RES, 2.2K-1/8W J	EZSM	CX-NSZ300
X	POWER AMP	R	0192 88-128-222-080	OE	C-RES, 2.2K-1/8W J	LHSM	CX-NSZ300
X	POWER AMP	R	0192 88-128-222-080	OE	C-RES, 2.2K-1/8W J	USM	CX-SNAJ300
X	POWER AMP	R	0192 88-128-222-080	OE	C-RES, 2.2K-1/8W J	USM	CX-SNAJ305
X	POWER AMP	R	0193 88-108-103-080		C-RES,U 10K-1/16W J	LHSM	CX-NSZ300
X	POWER AMP	R	0193 88-108-103-080		C-RES,U 10K-1/16W J	USM	CX-SNAJ300
X	POWER AMP	R	0193 88-108-103-080		C-RES,U 10K-1/16W J	USM	CX-SNAJ305
X	POWER AMP	R	0193 88-108-103-080		C-RES,U 10K-1/16W J	EZSM	CX-NSZ300
X	POWER AMP	R	0193 88-108-103-080	OE	C-RES,U 10K-1/16W J	LHSM	CX-NSZ300
X	POWER AMP	R	0193 88-108-103-080	OE	C-RES,U 10K-1/16W J	USM	CX-SNAJ300
X	POWER AMP	R	0193 88-108-103-080	OE	C-RES,U 10K-1/16W J	USM	CX-SNAJ305
X	POWER AMP	R	0194 88-108-103-080		C-RES,U 10K-1/16W J	LHSM	CX-NSZ300
X	POWER AMP	R	0194 88-108-103-080		C-RES,U 10K-1/16W J	USM	CX-SNAJ300

PARTS LIST

! = Δ SAFTY PARTS
 C = Components marked

All components used on this model at the production line are shown in this service manual.

However, please note that not all components will be available as spare parts for after-sales service.

Components marked S and O are designated as spare parts for service and will be stocked at the spare parts centers.

Components marked X and R are not designated as spare parts for after sales service, and will not be stocked at the spare parts centers.

K NO. = Only use japanese.

! C	UNIT NAME	REF NO.	PARTS CODE	K NO.	DESCRIPTION	SUFFIX	MODEL NAME
X	POWER AMP	R	0194 88-108-103-080		C-RES,U 10K-1/16W J	USM	CX-SNAJ305
X	POWER AMP	R	0194 88-108-103-080		C-RES,U 10K-1/16W J	EZSM	CX-NSZ300
X	POWER AMP	R	0194 88-108-103-080	OE	C-RES,U 10K-1/16W J	LHSM	CX-NSZ300
X	POWER AMP	R	0194 88-108-103-080	OE	C-RES,U 10K-1/16W J	USM	CX-SNAJ300
X	POWER AMP	R	0194 88-108-103-080	OE	C-RES,U 10K-1/16W J	USM	CX-SNAJ305
X	POWER AMP	R	0195 88-108-473-080		C-RES,U 47K-1/16W J	LHSM	CX-NSZ300
X	POWER AMP	R	0195 88-108-473-080		C-RES,U 47K-1/16W J	USM	CX-SNAJ300
X	POWER AMP	R	0195 88-108-473-080		C-RES,U 47K-1/16W J	USM	CX-SNAJ305
X	POWER AMP	R	0195 88-108-473-080		C-RES,U 47K-1/16W J	EZSM	CX-NSZ300
X	POWER AMP	R	0195 88-108-473-080	OE	C-RES,U 47K-1/16W J	LHSM	CX-NSZ300
X	POWER AMP	R	0195 88-108-473-080	OE	C-RES,U 47K-1/16W J	USM	CX-SNAJ300
X	POWER AMP	R	0195 88-108-473-080	OE	C-RES,U 47K-1/16W J	USM	CX-SNAJ305
X	POWER AMP	R	0196 88-108-473-080		C-RES,U 47K-1/16W J	LHSM	CX-NSZ300
X	POWER AMP	R	0196 88-108-473-080		C-RES,U 47K-1/16W J	USM	CX-SNAJ300
X	POWER AMP	R	0196 88-108-473-080		C-RES,U 47K-1/16W J	USM	CX-SNAJ305
X	POWER AMP	R	0196 88-108-473-080		C-RES,U 47K-1/16W J	EZSM	CX-NSZ300
X	POWER AMP	R	0196 88-108-473-080	OE	C-RES,U 47K-1/16W J	LHSM	CX-NSZ300
X	POWER AMP	R	0196 88-108-473-080	OE	C-RES,U 47K-1/16W J	USM	CX-SNAJ300
X	POWER AMP	R	0196 88-108-473-080	OE	C-RES,U 47K-1/16W J	USM	CX-SNAJ305
X	POWER AMP	R	0197 88-108-473-080		C-RES,U 47K-1/16W J	LHSM	CX-NSZ300
X	POWER AMP	R	0197 88-108-473-080		C-RES,U 47K-1/16W J	USM	CX-SNAJ300
X	POWER AMP	R	0197 88-108-473-080		C-RES,U 47K-1/16W J	USM	CX-SNAJ305
X	POWER AMP	R	0197 88-108-473-080		C-RES,U 47K-1/16W J	EZSM	CX-NSZ300
X	POWER AMP	R	0197 88-108-473-080	OE	C-RES,U 47K-1/16W J	LHSM	CX-NSZ300
X	POWER AMP	R	0197 88-108-473-080	OE	C-RES,U 47K-1/16W J	USM	CX-SNAJ300
X	POWER AMP	R	0197 88-108-473-080	OE	C-RES,U 47K-1/16W J	USM	CX-SNAJ305
X	POWER AMP	R	0198 88-108-473-080		C-RES,U 47K-1/16W J	LHSM	CX-NSZ300
X	POWER AMP	R	0198 88-108-473-080		C-RES,U 47K-1/16W J	USM	CX-SNAJ300
X	POWER AMP	R	0198 88-108-473-080		C-RES,U 47K-1/16W J	USM	CX-SNAJ305
X	POWER AMP	R	0198 88-108-473-080		C-RES,U 47K-1/16W J	EZSM	CX-NSZ300
X	POWER AMP	R	0198 88-108-473-080	OE	C-RES,U 47K-1/16W J	LHSM	CX-NSZ300
X	POWER AMP	R	0198 88-108-473-080	OE	C-RES,U 47K-1/16W J	USM	CX-SNAJ300
X	POWER AMP	R	0199 88-108-225-080		C-RES,U 2.2M-1/16W J	LHSM	CX-NSZ300
X	POWER AMP	R	0199 88-108-225-080		C-RES,U 2.2M-1/16W J	USM	CX-SNAJ300
X	POWER AMP	R	0199 88-108-225-080		C-RES,U 2.2M-1/16W J	USM	CX-SNAJ305
X	POWER AMP	R	0199 88-108-225-080		C-RES,U 2.2M-1/16W J	EZSM	CX-NSZ300
X	POWER AMP	R	0199 88-108-225-080	OE	C-RES,U 2.2M-1/16W J	LHSM	CX-NSZ300
X	POWER AMP	R	0199 88-108-225-080	OE	C-RES,U 2.2M-1/16W J	USM	CX-SNAJ300
X	POWER AMP	R	0199 88-108-225-080	OE	C-RES,U 2.2M-1/16W J	USM	CX-SNAJ305
O	POWER AMP	R	0243 87-A00-440-050		RES,220-1/2W J RP	LHSM	CX-NSZ300
O	POWER AMP	R	0243 87-A00-440-050		RES,220-1/2W J RP	USM	CX-SNAJ300
O	POWER AMP	R	0243 87-A00-440-050		RES,220-1/2W J RP	USM	CX-SNAJ305
O	POWER AMP	R	0243 87-A00-440-050	OE	RES,220-1/2W J RP	LHSM	CX-NSZ300
O	POWER AMP	R	0243 87-A00-440-050	OE	RES,220-1/2W J RP	USM	CX-SNAJ300
O	POWER AMP	R	0243 87-A00-440-050	OE	RES,220-1/2W J RP	USM	CX-SNAJ305
O	POWER AMP	R	0243 87-A00-999-050		RES,180-1/2W J BLT2J	EZSM	CX-NSZ300
O	POWER AMP	R	0244 87-A00-440-050		RES,220-1/2W J RP	LHSM	CX-NSZ300
O	POWER AMP	R	0244 87-A00-440-050		RES,220-1/2W J RP	USM	CX-SNAJ300
O	POWER AMP	R	0244 87-A00-440-050		RES,220-1/2W J RP	USM	CX-SNAJ305
O	POWER AMP	R	0244 87-A00-440-050	OE	RES,220-1/2W J RP	LHSM	CX-NSZ300
O	POWER AMP	R	0244 87-A00-440-050	OE	RES,220-1/2W J RP	USM	CX-SNAJ300
O	POWER AMP	R	0244 87-A00-440-050	OE	RES,220-1/2W J RP	USM	CX-SNAJ305
O	POWER AMP	R	0245 87-A00-440-050		RES,220-1/2W J RP	USM	CX-SNAJ300
O	POWER AMP	R	0245 87-A00-440-050		RES,220-1/2W J RP	USM	CX-SNAJ305
O	POWER AMP	R	0245 87-A00-440-050		RES,220-1/2W J RP	USM	CX-SNAJ300
O	POWER AMP	R	0245 87-A00-440-050	OE	RES,220-1/2W J RP	USM	CX-SNAJ300
O	POWER AMP	R	0245 87-A00-440-050	OE	RES,220-1/2W J RP	USM	CX-SNAJ305
O	POWER AMP	R	0245 87-A00-441-050		RES,270-1/2W J RP	LHSM	CX-NSZ300
O	POWER AMP	R	0245 87-A00-441-050	OE	RES,270-1/2W J RP	LHSM	CX-NSZ300
O	POWER AMP	R	0245 87-A00-999-050		RES,180-1/2W J BLT2J	EZSM	CX-NSZ300
O	POWER AMP	R	0246 87-A00-440-050		RES,220-1/2W J RP	USM	CX-SNAJ300
O	POWER AMP	R	0246 87-A00-440-050		RES,220-1/2W J RP	USM	CX-SNAJ305
O	POWER AMP	R	0246 87-A00-440-050	OE	RES,220-1/2W J RP	USM	CX-SNAJ300
O	POWER AMP	R	0246 87-A00-440-050	OE	RES,220-1/2W J RP	USM	CX-SNAJ305
O	POWER AMP	R	0246 87-A00-441-050		RES,270-1/2W J RP	LHSM	CX-NSZ300
O	POWER AMP	R	0246 87-A00-441-050	OE	RES,270-1/2W J RP	LHSM	CX-NSZ300
O	POWER AMP	R	0246 87-A00-999-050		RES,180-1/2W J BLT2J	EZSM	CX-NSZ300
X	POWER AMP	R	0247 88-130-100-080		RES,10-1/4W J	LHSM	CX-NSZ300
X	POWER AMP	R	0247 88-130-100-080		RES,10-1/4W J	USM	CX-SNAJ300

PARTS LIST

! = Δ SAFTY PARTS
 C = Components marked

All components used on this model at the production line are shown in this service manual.

However, please note that not all components will be available as spare parts for after-sales service.

Components marked S and O are designated as spare parts for service and will be stocked at the spare parts centers.

Components marked X and R are not designated as spare parts for after sales service, and will not be stocked at the spare parts centers.

K NO. = Only use japanese.

! C	UNIT NAME	REF NO.	PARTS CODE	K NO.	DESCRIPTION	SUFFIX	MODEL NAME
X	POWER AMP	R 0247	88-130-100-080		RES,10-1/4W J	USM	CX-SNAJ305
X	POWER AMP	R 0247	88-130-100-080		RES,10-1/4W J	EZSM	CX-NSZ300
X	POWER AMP	R 0247	88-130-100-080	OE	RES,10-1/4W J	LHSM	CX-NSZ300
X	POWER AMP	R 0247	88-130-100-080	OE	RES,10-1/4W J	USM	CX-SNAJ300
X	POWER AMP	R 0247	88-130-100-080	OE	RES,10-1/4W J	USM	CX-SNAJ305
X	POWER AMP	R 0248	88-130-100-080		RES,10-1/4W J	LHSM	CX-NSZ300
X	POWER AMP	R 0248	88-130-100-080		RES,10-1/4W J	USM	CX-SNAJ300
X	POWER AMP	R 0248	88-130-100-080		RES,10-1/4W J	USM	CX-SNAJ305
X	POWER AMP	R 0248	88-130-100-080		RES,10-1/4W J	EZSM	CX-NSZ300
X	POWER AMP	R 0248	88-130-100-080	OE	RES,10-1/4W J	LHSM	CX-NSZ300
X	POWER AMP	R 0248	88-130-100-080	OE	RES,10-1/4W J	USM	CX-SNAJ300
X	POWER AMP	R 0249	88-128-100-080		C-RES, 10-1/8W J	LHSM	CX-NSZ300
X	POWER AMP	R 0249	88-128-100-080		C-RES, 10-1/8W J	USM	CX-SNAJ300
X	POWER AMP	R 0249	88-128-100-080		C-RES, 10-1/8W J	USM	CX-SNAJ305
X	POWER AMP	R 0249	88-128-100-080		C-RES, 10-1/8W J	EZSM	CX-NSZ300
X	POWER AMP	R 0249	88-128-100-080	OE	C-RES, 10-1/8W J	LHSM	CX-NSZ300
X	POWER AMP	R 0249	88-128-100-080	OE	C-RES, 10-1/8W J	USM	CX-SNAJ300
X	POWER AMP	R 0249	88-128-100-080	OE	C-RES, 10-1/8W J	USM	CX-SNAJ305
X	POWER AMP	R 0250	88-121-100-080		RES,10-1/8W J	LHSM	CX-NSZ300
X	POWER AMP	R 0250	88-121-100-080		RES,10-1/8W J	USM	CX-SNAJ300
X	POWER AMP	R 0250	88-121-100-080		RES,10-1/8W J	USM	CX-SNAJ305
X	POWER AMP	R 0250	88-121-100-080	OE	RES,10-1/8W J	LHSM	CX-NSZ300
X	POWER AMP	R 0250	88-121-100-080	OE	RES,10-1/8W J	USM	CX-SNAJ300
X	POWER AMP	R 0250	88-121-100-080	OE	RES,10-1/8W J	USM	CX-SNAJ305
X	POWER AMP	R 0265	88-128-222-080		C-RES, 2.2K-1/8W J	LHSM	CX-NSZ300
X	POWER AMP	R 0265	88-128-222-080		C-RES, 2.2K-1/8W J	USM	CX-SNAJ300
X	POWER AMP	R 0265	88-128-222-080		C-RES, 2.2K-1/8W J	USM	CX-SNAJ305
X	POWER AMP	R 0265	88-128-222-080		C-RES, 2.2K-1/8W J	EZSM	CX-NSZ300
X	POWER AMP	R 0265	88-128-222-080	OE	C-RES, 2.2K-1/8W J	LHSM	CX-NSZ300
X	POWER AMP	R 0265	88-128-222-080	OE	C-RES, 2.2K-1/8W J	USM	CX-SNAJ300
X	POWER AMP	R 0265	88-128-222-080	OE	C-RES, 2.2K-1/8W J	USM	CX-SNAJ305
X	POWER AMP	R 0266	88-128-222-080		C-RES, 2.2K-1/8W J	LHSM	CX-NSZ300
X	POWER AMP	R 0266	88-128-222-080		C-RES, 2.2K-1/8W J	USM	CX-SNAJ300
X	POWER AMP	R 0266	88-128-222-080		C-RES, 2.2K-1/8W J	USM	CX-SNAJ305
X	POWER AMP	R 0266	88-128-222-080		C-RES, 2.2K-1/8W J	EZSM	CX-NSZ300
X	POWER AMP	R 0266	88-128-222-080	OE	C-RES, 2.2K-1/8W J	LHSM	CX-NSZ300
X	POWER AMP	R 0266	88-128-222-080	OE	C-RES, 2.2K-1/8W J	USM	CX-SNAJ300
X	POWER AMP	R 0266	88-128-222-080	OE	C-RES, 2.2K-1/8W J	USM	CX-SNAJ305
O	POWER AMP	TH 0101	87-A91-042-080		C-THMS,100K 55001	LHSM	CX-NSZ300
O	POWER AMP	TH 0101	87-A91-042-080		C-THMS,100K 55001	USM	CX-SNAJ300
O	POWER AMP	TH 0101	87-A91-042-080		C-THMS,100K 55001	USM	CX-SNAJ305
O	POWER AMP	TH 0101	87-A91-042-080		C-THMS,100K 55001	EZSM	CX-NSZ300
O	POWER AMP	TH 0101	87-A91-042-080	OE	C-THMS,100K 55001	LHSM	CX-NSZ300
O	POWER AMP	TH 0101	87-A91-042-080	OE	C-THMS,100K 55001	USM	CX-SNAJ300
O	POWER AMP	TH 0101	87-A91-042-080	OE	C-THMS,100K 55001	USM	CX-SNAJ305
O	POWER AMP	TH 0102	87-A91-042-080		C-THMS,100K 55001	LHSM	CX-NSZ300
O	POWER AMP	TH 0102	87-A91-042-080		C-THMS,100K 55001	USM	CX-SNAJ300
O	POWER AMP	TH 0102	87-A91-042-080		C-THMS,100K 55001	USM	CX-SNAJ305
O	POWER AMP	TH 0102	87-A91-042-080		C-THMS,100K 55001	EZSM	CX-NSZ300
O	POWER AMP	TH 0102	87-A91-042-080	OE	C-THMS,100K 55001	LHSM	CX-NSZ300
O	POWER AMP	TH 0102	87-A91-042-080	OE	C-THMS,100K 55001	USM	CX-SNAJ300
O	POWER AMP	TH 0102	87-A91-042-080	OE	C-THMS,100K 55001	USM	CX-SNAJ305
X	PRINTED DU		87-056-168-010		SH,CAUTION INF-WARR(EC)	EZSM	CX-NSZ300
X	PRINTED DU		87-B40-085-010		BAG, PV 0.04-200-350 PL	LHSM	CX-NSZ300
X	PRINTED DU		87-B40-085-010		BAG, PV 0.04-200-350 PL	USM	CX-SNAJ300
X	PRINTED DU		87-B40-085-010		BAG, PV 0.04-200-350 PL	USM	CX-SNAJ305
X	PRINTED DU		87-B40-085-010		BAG, PV 0.04-200-350 PL	EZSM	CX-NSZ300
X	PRINTED DU		87-B40-085-010	OE	BAG, PV 0.04-200-350 PL	USM	CX-SNAJ300
X	PRINTED DU		87-B40-085-010	OE	BAG, PV 0.04-200-350 PL	USM	CX-SNAJ305
X	PRINTED DU		87-B50-053-010		WARR-CARD,USA CUST/AV,VISUAL	USM	CX-SNAJ300
X	PRINTED DU		87-B50-053-010		WARR-CARD,USA CUST/AV,VISUAL	USM	CX-SNAJ305
X	PRINTED DU		87-B50-053-010	OE	WARR-CARD,USA CUST/AV,VISUAL	USM	CX-SNAJ300
X	PRINTED DU		87-B50-053-010	OE	WARR-CARD,USA CUST/AV,VISUAL	USM	CX-SNAJ305
X	PRINTED DU		87-B50-056-010		SH,CAUTION AC VOLTAGE	LHSM	CX-NSZ300
X	PRINTED DU		87-B50-079-010		LIST, FACILITY(B)-0007	LHSM	CX-NSZ300
X	PRINTED DU		87-B50-079-010		LIST, FACILITY(B)-0007	EZSM	CX-NSZ300
O	PRINTED DU		8B-NF9-912-010		IB, LH(ESP)M	LHSM	CX-NSZ300
O	PRINTED DU		8B-NF9-913-010		IB, U(ESF)M	USM	CX-SNAJ300

PARTS LIST

! = Δ SAFTY PARTS
 C = Components marked

All components used on this model at the production line are shown in this service manual.

However, please note that not all components will be available as spare parts for after-sales service.

Components marked S and O are designated as spare parts for service and will be stocked at the spare parts centers.

Components marked X and R are not designated as spare parts for after sales service, and will not be stocked at the spare parts centers.

K NO. = Only use japanese.

! C	UNIT NAME	REF NO.	PARTS CODE	K NO.	DESCRIPTION	SUFFIX	MODEL NAME
O	PRINTED DU		8B-NF9-913-010		IB,U (ESF)M	USM	CX-SNAJ305
O	PRINTED DU		8B-NF9-913-010	1A	IB,U (ESF)M	USM	CX-SNAJ300
O	PRINTED DU		8B-NF9-913-010	1A	IB,U (ESF)M	USM	CX-SNAJ305
O	PRINTED DU		8B-NF9-926-010		IB,EZ (9L)M	EZSM	CX-NSZ300
X	PT	*	8B-NF9-641-010		PWB,PT 66-55 2M (MSIA)	LHSM	CX-NSZ300
O	PT	CN 0001	87-A61-110-010		CONN,9P V TID-A	LHSM	CX-NSZ300
S	PT	D 0002	87-A40-291-080		DIODE,1N4148M (CPT)	LHSM	CX-NSZ300
S	PT	D 0003	87-A40-291-080		DIODE,1N4148M (CPT)	LHSM	CX-NSZ300
S	PT	D 0004	87-A40-291-080		DIODE,1N4148M (CPT)	LHSM	CX-NSZ300
S	PT	D 0005	87-A40-291-080		DIODE,1N4148M (CPT)	LHSM	CX-NSZ300
O	PT	PT 0002	8B-NF9-664-010		PT,SUB BNF H (KAMI)	LHSM	CX-NSZ300
O	PT	RY 0001	87-A91-339-010		RELAY,AC DC12V G5PA-2	LHSM	CX-NSZ300
O	PT	S 0001	87-A90-165-010		SW,SL 1-2-3 SWS2301	LHSM	CX-NSZ300
O	PT	T 0001	87-A60-317-010		TERMINAL, 1P MSC	LHSM	CX-NSZ300
O	PT	T 0002	87-A60-317-010		TERMINAL, 1P MSC	LHSM	CX-NSZ300
O	SCREW		87-067-584-010		BVT2+3-6 W/O SLOT	EZSM	CX-NSZ300
O	SCREW		87-067-584-010	OE	BVT2+3-6 W/O SLOT	LHSM	CX-NSZ300
O	SCREW		87-067-584-010	OE	BVT2+3-6 W/O SLOT	USM	CX-SNAJ300
O	SCREW		87-067-584-010	OE	BVT2+3-6 W/O SLOT	USM	CX-SNAJ305
O	SCREW		87-067-641-010		UTT2+3-8 W/O SLOT BLK	LHSM	CX-NSZ300
O	SCREW		87-067-641-010		UTT2+3-8 W/O SLOT BLK	USM	CX-SNAJ300
O	SCREW		87-067-641-010		UTT2+3-8 W/O SLOT BLK	USM	CX-SNAJ305
O	SCREW		87-067-641-010	OE	UTT2+3-8 W/O SLOT BLK	LHSM	CX-NSZ300
O	SCREW		87-067-641-010	OE	UTT2+3-8 W/O SLOT BLK	USM	CX-SNAJ300
O	SCREW		87-067-641-010	OE	UTT2+3-8 W/O SLOT BLK	USM	CX-SNAJ305
O	SCREW		87-067-689-010		BVTT+3-8	LHSM	CX-NSZ300
O	SCREW		87-067-689-010		BVTT+3-8	USM	CX-SNAJ300
O	SCREW		87-067-689-010		BVTT+3-8	USM	CX-SNAJ305
O	SCREW		87-067-689-010		BVTT+3-8	EZSM	CX-NSZ300
O	SCREW		87-067-689-010	OE	BVTT+3-8	LHSM	CX-NSZ300
O	SCREW		87-067-689-010	OE	BVTT+3-8	USM	CX-SNAJ300
O	SCREW		87-067-689-010	OE	BVTT+3-8	USM	CX-SNAJ305
O	SCREW		87-067-703-010		BVT2+3-10 W/O SLOT	LHSM	CX-NSZ300
O	SCREW		87-067-703-010		BVT2+3-10 W/O SLOT	USM	CX-SNAJ300
O	SCREW		87-067-703-010		BVT2+3-10 W/O SLOT	USM	CX-SNAJ305
O	SCREW		87-067-703-010		BVT2+3-10 W/O SLOT	EZSM	CX-NSZ300
O	SCREW		87-067-703-010	OE	BVT2+3-10 W/O SLOT	LHSM	CX-NSZ300
O	SCREW		87-067-703-010	OE	BVT2+3-10 W/O SLOT	USM	CX-SNAJ300
O	SCREW		87-067-703-010	OE	BVT2+3-10 W/O SLOT	USM	CX-SNAJ305
O	SCREW		87-078-200-010		S-SCREW,ITC4-8 R	LHSM	CX-NSZ300
O	SCREW		87-078-200-010		S-SCREW,ITC4-8 R	USM	CX-SNAJ300
O	SCREW		87-078-200-010		S-SCREW,ITC4-8 R	USM	CX-SNAJ305
O	SCREW		87-078-200-010		S-SCREW,ITC4-8 R	EZSM	CX-NSZ300
O	SCREW		87-078-200-010	OE	S-SCREW,ITC4-8 R	LHSM	CX-NSZ300
O	SCREW		87-078-200-010	OE	S-SCREW,ITC4-8 R	USM	CX-SNAJ300
O	SCREW		87-078-200-010	OE	S-SCREW,ITC4-8 R	USM	CX-SNAJ305
O	SCREW		87-721-096-410		QT2+3-10 W/O SLOT	LHSM	CX-NSZ300
O	SCREW		87-721-096-410		QT2+3-10 W/O SLOT	USM	CX-SNAJ300
O	SCREW		87-721-096-410		QT2+3-10 W/O SLOT	USM	CX-SNAJ305
O	SCREW		87-721-096-410		QT2+3-10 W/O SLOT	EZSM	CX-NSZ300
O	SCREW		87-721-096-410	OE	QT2+3-10 W/O SLOT	LHSM	CX-NSZ300
O	SCREW		87-721-096-410	OE	QT2+3-10 W/O SLOT	USM	CX-SNAJ300
O	SCREW		87-721-096-410	OE	QT2+3-10 W/O SLOT	USM	CX-SNAJ305
O	SCREW		87-721-097-410		QT2+3-12 W/O SLOT	LHSM	CX-NSZ300
O	SCREW		87-721-097-410		QT2+3-12 W/O SLOT	USM	CX-SNAJ300
O	SCREW		87-721-097-410		QT2+3-12 W/O SLOT	USM	CX-SNAJ305
O	SCREW		87-721-097-410		QT2+3-12 W/O SLOT	EZSM	CX-NSZ300
O	SCREW		87-721-097-410	OE	QT2+3-12 W/O SLOT	LHSM	CX-NSZ300
O	SCREW		87-721-097-410	OE	QT2+3-12 W/O SLOT	USM	CX-SNAJ300
O	SCREW		87-721-097-410	OE	QT2+3-12 W/O SLOT	USM	CX-SNAJ305
O	SCREW		87-721-097-410	OE	QT2+3-12 W/O SLOT	LHSM	CX-NSZ300
O	SCREW		87-721-097-410	OE	QT2+3-12 W/O SLOT	USM	CX-SNAJ300
O	SCREW		87-721-097-410	OE	QT2+3-12 W/O SLOT	USM	CX-SNAJ305
X	TAPE		M8-ZZM-392-030		ZZM-3 PR1NM	LHSM	CX-NSZ300
X	TAPE		M8-ZZM-392-030		ZZM-3 PR1NM	USM	CX-SNAJ300

PARTS LIST

! = Δ SAFTY PARTS
 C = Components marked

All components used on this model at the production line are shown in this service manual.

However, please note that not all components will be available as spare parts for after-sales service.

Components marked S and O are designated as spare parts for service and will be stocked at the spare parts centers.

Components marked X and R are not designated as spare parts for after sales service, and will not be stocked at the spare parts centers.

K NO. = Only use japanese.

! C	UNIT NAME	REF NO.	PARTS CODE	K NO.	DESCRIPTION	SUFFIX	MODEL NAME
X	TAPE		M8-ZZM-392-030		ZZM-3 PR1NM	USM	CX-SNAJ305
!	X	TAPE	M8-ZZM-392-030		ZZM-3 PR1NM	EZSM	CX-NSZ300
!	X	TAPE	M8-ZZM-392-030	--	ZZM-3 PR1NM	LHSM	CX-NSZ300
!	X	TAPE	M8-ZZM-392-030	--	ZZM-3 PR1NM	USM	CX-SNAJ300
!	X	TAPE	M8-ZZM-392-030	--	ZZM-3 PR1NM	USM	CX-SNAJ305
O	TAPE DECK	C 0301	87-012-274-080		C-CAP,U 1000P-50 K B	LHSM	CX-NSZ300
O	TAPE DECK	C 0301	87-012-274-080		C-CAP,U 1000P-50 K B	USM	CX-SNAJ300
O	TAPE DECK	C 0301	87-012-274-080		C-CAP,U 1000P-50 K B	USM	CX-SNAJ305
O	TAPE DECK	C 0301	87-012-275-080		C-CAP,U 1200P-50 K B GRM	EZSM	CX-NSZ300
O	TAPE DECK	C 0301	87-012-275-080	OE	C-CAP,U 1200P-50 K B GRM	LHSM	CX-NSZ300
O	TAPE DECK	C 0301	87-012-275-080	OE	C-CAP,U 1200P-50 K B GRM	USM	CX-SNAJ300
O	TAPE DECK	C 0301	87-012-275-080	OE	C-CAP,U 1200P-50 K B GRM	USM	CX-SNAJ305
O	TAPE DECK	C 0302	87-012-274-080		C-CAP,U 1000P-50 K B	LHSM	CX-NSZ300
O	TAPE DECK	C 0302	87-012-274-080		C-CAP,U 1000P-50 K B	USM	CX-SNAJ300
O	TAPE DECK	C 0302	87-012-274-080		C-CAP,U 1000P-50 K B	USM	CX-SNAJ305
O	TAPE DECK	C 0302	87-012-275-080		C-CAP,U 1200P-50 K B GRM	EZSM	CX-NSZ300
O	TAPE DECK	C 0302	87-012-275-080	OE	C-CAP,U 1200P-50 K B GRM	LHSM	CX-NSZ300
O	TAPE DECK	C 0302	87-012-275-080	OE	C-CAP,U 1200P-50 K B GRM	USM	CX-SNAJ300
O	TAPE DECK	C 0302	87-012-275-080	OE	C-CAP,U 1200P-50 K B GRM	USM	CX-SNAJ305
O	TAPE DECK	C 0303	87-012-275-080		C-CAP,U 1200P-50 K B GRM	LHSM	CX-NSZ300
O	TAPE DECK	C 0303	87-012-275-080		C-CAP,U 1200P-50 K B GRM	USM	CX-SNAJ300
O	TAPE DECK	C 0303	87-012-275-080		C-CAP,U 1200P-50 K B GRM	USM	CX-SNAJ305
O	TAPE DECK	C 0303	87-012-275-080	OE	C-CAP,U 1200P-50 K B GRM	LHSM	CX-NSZ300
O	TAPE DECK	C 0303	87-012-275-080	OE	C-CAP,U 1200P-50 K B GRM	USM	CX-SNAJ300
O	TAPE DECK	C 0303	87-012-275-080	OE	C-CAP,U 1200P-50 K B GRM	USM	CX-SNAJ305
O	TAPE DECK	C 0304	87-012-275-080		C-CAP,U 1200P-50 K B GRM	LHSM	CX-NSZ300
O	TAPE DECK	C 0304	87-012-275-080		C-CAP,U 1200P-50 K B GRM	USM	CX-SNAJ300
O	TAPE DECK	C 0304	87-012-275-080		C-CAP,U 1200P-50 K B GRM	USM	CX-SNAJ305
O	TAPE DECK	C 0304	87-012-275-080		C-CAP,U 1200P-50 K B GRM	EZSM	CX-NSZ300
O	TAPE DECK	C 0304	87-012-275-080	OE	C-CAP,U 1200P-50 K B GRM	LHSM	CX-NSZ300
O	TAPE DECK	C 0304	87-012-275-080	OE	C-CAP,U 1200P-50 K B GRM	USM	CX-SNAJ300
O	TAPE DECK	C 0304	87-012-275-080	OE	C-CAP,U 1200P-50 K B GRM	USM	CX-SNAJ305
O	TAPE DECK	C 0307	87-A12-062-080		CAP,E 100-10 SMG	LHSM	CX-NSZ300
O	TAPE DECK	C 0307	87-A12-062-080		CAP,E 100-10 SMG	USM	CX-SNAJ300
O	TAPE DECK	C 0307	87-A12-062-080		CAP,E 100-10 SMG	USM	CX-SNAJ305
O	TAPE DECK	C 0307	87-A12-062-080		CAP,E 100-10 SMG	EZSM	CX-NSZ300
O	TAPE DECK	C 0307	87-A12-062-080	OE	CAP,E 100-10 SMG	LHSM	CX-NSZ300
O	TAPE DECK	C 0307	87-A12-062-080	OE	CAP,E 100-10 SMG	USM	CX-SNAJ300
O	TAPE DECK	C 0307	87-A12-062-080	OE	CAP,E 100-10 SMG	USM	CX-SNAJ305
O	TAPE DECK	C 0308	87-A12-062-080		CAP,E 100-10 SMG	LHSM	CX-NSZ300
O	TAPE DECK	C 0308	87-A12-062-080		CAP,E 100-10 SMG	USM	CX-SNAJ300
O	TAPE DECK	C 0308	87-A12-062-080		CAP,E 100-10 SMG	USM	CX-SNAJ305
O	TAPE DECK	C 0308	87-A12-062-080	OE	CAP,E 100-10 SMG	EZSM	CX-NSZ300
O	TAPE DECK	C 0308	87-A12-062-080	OE	CAP,E 100-10 SMG	LHSM	CX-NSZ300
O	TAPE DECK	C 0308	87-A12-062-080	OE	CAP,E 100-10 SMG	USM	CX-SNAJ300
O	TAPE DECK	C 0308	87-A12-062-080	OE	CAP,E 100-10 SMG	USM	CX-SNAJ305
O	TAPE DECK	C 0309	87-012-188-080		C-CAP,U 47P-50 J CH	LHSM	CX-NSZ300
O	TAPE DECK	C 0309	87-012-188-080		C-CAP,U 47P-50 J CH	USM	CX-SNAJ300
O	TAPE DECK	C 0309	87-012-188-080		C-CAP,U 47P-50 J CH	USM	CX-SNAJ305
O	TAPE DECK	C 0309	87-012-188-080	OE	C-CAP,U 47P-50 J CH	EZSM	CX-NSZ300
O	TAPE DECK	C 0309	87-012-188-080	OE	C-CAP,U 47P-50 J CH	LHSM	CX-NSZ300
O	TAPE DECK	C 0309	87-012-188-080	OE	C-CAP,U 47P-50 J CH	USM	CX-SNAJ300
O	TAPE DECK	C 0310	87-012-188-080		C-CAP,U 47P-50 J CH	LHSM	CX-NSZ300
O	TAPE DECK	C 0310	87-012-188-080		C-CAP,U 47P-50 J CH	USM	CX-SNAJ300
O	TAPE DECK	C 0310	87-012-188-080		C-CAP,U 47P-50 J CH	USM	CX-SNAJ305
O	TAPE DECK	C 0310	87-012-188-080		C-CAP,U 47P-50 J CH	EZSM	CX-NSZ300
O	TAPE DECK	C 0310	87-012-188-080	OE	C-CAP,U 47P-50 J CH	LHSM	CX-NSZ300
O	TAPE DECK	C 0310	87-012-188-080	OE	C-CAP,U 47P-50 J CH	USM	CX-SNAJ300
O	TAPE DECK	C 0310	87-012-188-080	OE	C-CAP,U 47P-50 J CH	USM	CX-SNAJ305
O	TAPE DECK	C 0313	87-012-284-080		C-CAP,U 6800P-50 K B GRM	LHSM	CX-NSZ300
O	TAPE DECK	C 0313	87-012-284-080		C-CAP,U 6800P-50 K B GRM	USM	CX-SNAJ300
O	TAPE DECK	C 0313	87-012-284-080		C-CAP,U 6800P-50 K B GRM	USM	CX-SNAJ305
O	TAPE DECK	C 0313	87-012-284-080		C-CAP,U 6800P-50 K B GRM	EZSM	CX-NSZ300
O	TAPE DECK	C 0313	87-012-284-080	OE	C-CAP,U 6800P-50 K B GRM	LHSM	CX-NSZ300
O	TAPE DECK	C 0313	87-012-284-080	OE	C-CAP,U 6800P-50 K B GRM	USM	CX-SNAJ300
O	TAPE DECK	C 0313	87-012-284-080	OE	C-CAP,U 6800P-50 K B GRM	USM	CX-SNAJ305
O	TAPE DECK	C 0314	87-012-284-080		C-CAP,U 6800P-50 K B GRM	LHSM	CX-NSZ300
O	TAPE DECK	C 0314	87-012-284-080		C-CAP,U 6800P-50 K B GRM	USM	CX-SNAJ300

PARTS LIST

! = Δ SAFTY PARTS
 C = Components marked

All components used on this model at the production line are shown in this service manual.

However, please note that not all components will be available as spare parts for after-sales service.

Components marked S and O are designated as spare parts for service and will be stocked at the spare parts centers.

Components marked X and R are not designated as spare parts for after sales service, and will not be stocked at the spare parts centers.

K NO. = Only use japanese.

! C	UNIT NAME	REF NO.	PARTS CODE	K NO.	DESCRIPTION	SUFFIX	MODEL NAME	
O	TAPE DECK	C	0314	87-012-284-080		C-CAP,U 6800P-50 K B GRM	USM	CX-SNAJ305
O	TAPE DECK	C	0314	87-012-284-080		C-CAP,U 6800P-50 K B GRM	EZSM	CX-NSZ300
O	TAPE DECK	C	0314	87-012-284-080	OE	C-CAP,U 6800P-50 K B GRM	LHSM	CX-NSZ300
O	TAPE DECK	C	0314	87-012-284-080	OE	C-CAP,U 6800P-50 K B GRM	USM	CX-SNAJ300
O	TAPE DECK	C	0314	87-012-284-080	OE	C-CAP,U 6800P-50 K B GRM	USM	CX-SNAJ305
O	TAPE DECK	C	0315	87-A12-062-080		CAP,E 100-10 SMG	LHSM	CX-NSZ300
O	TAPE DECK	C	0315	87-A12-062-080		CAP,E 100-10 SMG	USM	CX-SNAJ300
O	TAPE DECK	C	0315	87-A12-062-080		CAP,E 100-10 SMG	USM	CX-SNAJ305
O	TAPE DECK	C	0315	87-A12-062-080		CAP,E 100-10 SMG	EZSM	CX-NSZ300
O	TAPE DECK	C	0315	87-A12-062-080	OE	CAP,E 100-10 SMG	LHSM	CX-NSZ300
O	TAPE DECK	C	0315	87-A12-062-080	OE	CAP,E 100-10 SMG	USM	CX-SNAJ300
O	TAPE DECK	C	0315	87-A12-062-080	OE	CAP,E 100-10 SMG	USM	CX-SNAJ305
O	TAPE DECK	C	0317	87-A12-085-080		CAP,E 0.33-50 SMG	USM	CX-SNAJ300
O	TAPE DECK	C	0317	87-A12-085-080		CAP,E 0.33-50 SMG	USM	CX-SNAJ305
O	TAPE DECK	C	0317	87-A12-085-080	OE	CAP,E 0.33-50 SMG	EZSM	CX-NSZ300
O	TAPE DECK	C	0317	87-A12-085-080	OE	CAP,E 0.33-50 SMG	LHSM	CX-NSZ300
O	TAPE DECK	C	0317	87-A12-085-080	OE	CAP,E 0.33-50 SMG	USM	CX-SNAJ300
O	TAPE DECK	C	0317	87-A12-085-080	OE	CAP,E 0.33-50 SMG	USM	CX-SNAJ305
O	TAPE DECK	C	0318	87-A12-085-080		CAP,E 0.33-50 SMG	LHSM	CX-NSZ300
O	TAPE DECK	C	0318	87-A12-085-080		CAP,E 0.33-50 SMG	USM	CX-SNAJ300
O	TAPE DECK	C	0318	87-A12-085-080		CAP,E 0.33-50 SMG	USM	CX-SNAJ305
O	TAPE DECK	C	0318	87-A12-085-080	OE	CAP,E 0.33-50 SMG	EZSM	CX-NSZ300
O	TAPE DECK	C	0318	87-A12-085-080	OE	CAP,E 0.33-50 SMG	LHSM	CX-NSZ300
O	TAPE DECK	C	0318	87-A12-085-080	OE	CAP,E 0.33-50 SMG	USM	CX-SNAJ300
O	TAPE DECK	C	0318	87-A12-085-080	OE	CAP,E 0.33-50 SMG	USM	CX-SNAJ305
O	TAPE DECK	C	0326	87-010-787-080		C-CAP,U 0.022-25 K B	LHSM	CX-NSZ300
O	TAPE DECK	C	0326	87-010-787-080		C-CAP,U 0.022-25 K B	USM	CX-SNAJ300
O	TAPE DECK	C	0326	87-010-787-080		C-CAP,U 0.022-25 K B	USM	CX-SNAJ305
O	TAPE DECK	C	0326	87-010-787-080		C-CAP,U 0.022-25 K B	EZSM	CX-NSZ300
O	TAPE DECK	C	0326	87-010-787-080	OE	C-CAP,U 0.022-25 K B	LHSM	CX-NSZ300
O	TAPE DECK	C	0326	87-010-787-080	OE	C-CAP,U 0.022-25 K B	USM	CX-SNAJ300
O	TAPE DECK	C	0326	87-010-787-080	OE	C-CAP,U 0.022-25 K B	USM	CX-SNAJ305
O	TAPE DECK	C	0327	87-010-831-080		C-CAP,U 0.1-16 Z F	LHSM	CX-NSZ300
O	TAPE DECK	C	0327	87-010-831-080		C-CAP,U 0.1-16 Z F	USM	CX-SNAJ300
O	TAPE DECK	C	0327	87-010-831-080		C-CAP,U 0.1-16 Z F	USM	CX-SNAJ305
O	TAPE DECK	C	0327	87-010-831-080	OE	C-CAP,U 0.1-16 Z F	LHSM	CX-NSZ300
O	TAPE DECK	C	0327	87-010-831-080	OE	C-CAP,U 0.1-16 Z F	USM	CX-SNAJ300
O	TAPE DECK	C	0327	87-010-831-080	OE	C-CAP,U 0.1-16 Z F	USM	CX-SNAJ305
O	TAPE DECK	C	0350	87-012-286-080		C-CAP,U 0.01-25 K B	EZSM	CX-NSZ300
O	TAPE DECK	C	0360	87-A12-087-080		CAP,E 1-50 SMG	LHSM	CX-NSZ300
O	TAPE DECK	C	0360	87-A12-087-080		CAP,E 1-50 SMG	USM	CX-SNAJ300
O	TAPE DECK	C	0360	87-A12-087-080		CAP,E 1-50 SMG	USM	CX-SNAJ305
O	TAPE DECK	C	0360	87-A12-087-080		CAP,E 1-50 SMG	USM	CX-SNAJ300
O	TAPE DECK	C	0360	87-A12-087-080		CAP,E 1-50 SMG	EZSM	CX-NSZ300
O	TAPE DECK	C	0360	87-A12-087-080	OE	CAP,E 1-50 SMG	LHSM	CX-NSZ300
O	TAPE DECK	C	0360	87-A12-087-080	OE	CAP,E 1-50 SMG	USM	CX-SNAJ300
O	TAPE DECK	C	0360	87-A12-087-080	OE	CAP,E 1-50 SMG	USM	CX-SNAJ305
O	TAPE DECK	C	0399	87-A10-039-080		C-CAP,U 470P-50 J CH	LHSM	CX-NSZ300
O	TAPE DECK	C	0399	87-A10-039-080		C-CAP,U 470P-50 J CH	USM	CX-SNAJ300
O	TAPE DECK	C	0399	87-A10-039-080		C-CAP,U 470P-50 J CH	USM	CX-SNAJ305
O	TAPE DECK	C	0399	87-A10-039-080	OE	C-CAP,U 470P-50 J CH	EZSM	CX-NSZ300
O	TAPE DECK	C	0399	87-A10-039-080	OE	C-CAP,U 470P-50 J CH	LHSM	CX-NSZ300
O	TAPE DECK	C	0399	87-A10-039-080	OE	C-CAP,U 470P-50 J CH	USM	CX-SNAJ300
O	TAPE DECK	C	0401	87-A12-083-080		CAP,E 0.1-50 SMG	LHSM	CX-NSZ300
O	TAPE DECK	C	0401	87-A12-083-080		CAP,E 0.1-50 SMG	USM	CX-SNAJ300
O	TAPE DECK	C	0401	87-A12-083-080		CAP,E 0.1-50 SMG	USM	CX-SNAJ305
O	TAPE DECK	C	0401	87-A12-083-080		CAP,E 0.1-50 SMG	USM	CX-SNAJ300
O	TAPE DECK	C	0401	87-A12-083-080		CAP,E 0.1-50 SMG	EZSM	CX-NSZ300
O	TAPE DECK	C	0401	87-A12-083-080	OE	CAP,E 0.1-50 SMG	LHSM	CX-NSZ300
O	TAPE DECK	C	0401	87-A12-083-080	OE	CAP,E 0.1-50 SMG	USM	CX-SNAJ300
O	TAPE DECK	C	0401	87-A12-083-080	OE	CAP,E 0.1-50 SMG	USM	CX-SNAJ305
O	TAPE DECK	C	0402	87-A12-083-080		CAP,E 0.1-50 SMG	LHSM	CX-NSZ300
O	TAPE DECK	C	0402	87-A12-083-080		CAP,E 0.1-50 SMG	USM	CX-SNAJ300
O	TAPE DECK	C	0402	87-A12-083-080		CAP,E 0.1-50 SMG	USM	CX-SNAJ305
O	TAPE DECK	C	0402	87-A12-083-080		CAP,E 0.1-50 SMG	USM	CX-SNAJ300
O	TAPE DECK	C	0402	87-A12-083-080		CAP,E 0.1-50 SMG	EZSM	CX-NSZ300
O	TAPE DECK	C	0402	87-A12-083-080	OE	CAP,E 0.1-50 SMG	LHSM	CX-NSZ300
O	TAPE DECK	C	0402	87-A12-083-080	OE	CAP,E 0.1-50 SMG	USM	CX-SNAJ300
O	TAPE DECK	C	0402	87-A12-083-080	OE	CAP,E 0.1-50 SMG	USM	CX-SNAJ305
O	TAPE DECK	C	0403	87-012-193-080		C-CAP,U 82P-50 J CH	LHSM	CX-NSZ300

PARTS LIST

! = Δ SAFTY PARTS
 C = Components marked

All components used on this model at the production line are shown in this service manual.

However, please note that not all components will be available as spare parts for after-sales service.

Components marked S and O are designated as spare parts for service and will be stocked at the spare parts centers.

Components marked X and R are not designated as spare parts for after sales service, and will not be stocked at the spare parts centers.

K NO. = Only use japanese.

! C	UNIT NAME	REF NO.	PARTS CODE	K NO.	DESCRIPTION	SUFFIX	MODEL NAME
O	TAPE DECK	C	0403 87-012-193-080		C-CAP,U 82P-50 J CH	USM	CX-SNAJ300
O	TAPE DECK	C	0403 87-012-193-080		C-CAP,U 82P-50 J CH	USM	CX-SNAJ305
O	TAPE DECK	C	0403 87-012-193-080		C-CAP,U 82P-50 J CH	EZSM	CX-NSZ300
O	TAPE DECK	C	0403 87-012-193-080	OE	C-CAP,U 82P-50 J CH	LHSM	CX-NSZ300
O	TAPE DECK	C	0403 87-012-193-080	OE	C-CAP,U 82P-50 J CH	USM	CX-SNAJ300
O	TAPE DECK	C	0403 87-012-193-080	OE	C-CAP,U 82P-50 J CH	USM	CX-SNAJ305
O	TAPE DECK	C	0404 87-012-193-080		C-CAP,U 82P-50 J CH	LHSM	CX-NSZ300
O	TAPE DECK	C	0404 87-012-193-080		C-CAP,U 82P-50 J CH	USM	CX-SNAJ300
O	TAPE DECK	C	0404 87-012-193-080		C-CAP,U 82P-50 J CH	USM	CX-SNAJ305
O	TAPE DECK	C	0404 87-012-193-080		C-CAP,U 82P-50 J CH	EZSM	CX-NSZ300
O	TAPE DECK	C	0404 87-012-193-080	OE	C-CAP,U 82P-50 J CH	LHSM	CX-NSZ300
O	TAPE DECK	C	0404 87-012-193-080	OE	C-CAP,U 82P-50 J CH	USM	CX-SNAJ300
O	TAPE DECK	C	0404 87-012-193-080	OE	C-CAP,U 82P-50 J CH	USM	CX-SNAJ305
O	TAPE DECK	C	0405 87-012-286-080		C-CAP,U 0.01-25 K B	LHSM	CX-NSZ300
O	TAPE DECK	C	0405 87-012-286-080		C-CAP,U 0.01-25 K B	USM	CX-SNAJ300
O	TAPE DECK	C	0405 87-012-286-080		C-CAP,U 0.01-25 K B	USM	CX-SNAJ305
O	TAPE DECK	C	0405 87-012-286-080		C-CAP,U 0.01-25 K B	LHSM	CX-NSZ300
O	TAPE DECK	C	0405 87-012-286-080		C-CAP,U 0.01-25 K B	USM	CX-SNAJ300
O	TAPE DECK	C	0405 87-012-286-080		C-CAP,U 0.01-25 K B	USM	CX-SNAJ305
O	TAPE DECK	C	0405 87-012-286-080	OE	C-CAP,U 0.01-25 K B	LHSM	CX-NSZ300
O	TAPE DECK	C	0405 87-012-286-080	OE	C-CAP,U 0.01-25 K B	USM	CX-SNAJ300
O	TAPE DECK	C	0405 87-012-286-080	OE	C-CAP,U 0.01-25 K B	USM	CX-SNAJ305
O	TAPE DECK	C	0406 87-012-286-080		C-CAP,U 0.01-25 K B	LHSM	CX-NSZ300
O	TAPE DECK	C	0406 87-012-286-080		C-CAP,U 0.01-25 K B	USM	CX-SNAJ300
O	TAPE DECK	C	0406 87-012-286-080		C-CAP,U 0.01-25 K B	USM	CX-SNAJ305
O	TAPE DECK	C	0406 87-012-286-080		C-CAP,U 0.01-25 K B	EZSM	CX-NSZ300
O	TAPE DECK	C	0406 87-012-286-080	OE	C-CAP,U 0.01-25 K B	LHSM	CX-NSZ300
O	TAPE DECK	C	0406 87-012-286-080	OE	C-CAP,U 0.01-25 K B	USM	CX-SNAJ300
O	TAPE DECK	C	0406 87-012-286-080	OE	C-CAP,U 0.01-25 K B	USM	CX-SNAJ305
O	TAPE DECK	C	0407 87-012-286-080		C-CAP,U 0.01-25 K B	LHSM	CX-NSZ300
O	TAPE DECK	C	0407 87-012-286-080		C-CAP,U 0.01-25 K B	USM	CX-SNAJ300
O	TAPE DECK	C	0407 87-012-286-080		C-CAP,U 0.01-25 K B	USM	CX-SNAJ305
O	TAPE DECK	C	0407 87-012-286-080		C-CAP,U 0.01-25 K B	EZSM	CX-NSZ300
O	TAPE DECK	C	0407 87-012-286-080	OE	C-CAP,U 0.01-25 K B	LHSM	CX-NSZ300
O	TAPE DECK	C	0407 87-012-286-080	OE	C-CAP,U 0.01-25 K B	USM	CX-SNAJ300
O	TAPE DECK	C	0407 87-012-286-080	OE	C-CAP,U 0.01-25 K B	USM	CX-SNAJ305
O	TAPE DECK	C	0408 87-012-286-080		C-CAP,U 0.01-25 K B	LHSM	CX-NSZ300
O	TAPE DECK	C	0408 87-012-286-080		C-CAP,U 0.01-25 K B	USM	CX-SNAJ300
O	TAPE DECK	C	0408 87-012-286-080		C-CAP,U 0.01-25 K B	USM	CX-SNAJ305
O	TAPE DECK	C	0408 87-012-286-080		C-CAP,U 0.01-25 K B	EZSM	CX-NSZ300
O	TAPE DECK	C	0408 87-012-286-080	OE	C-CAP,U 0.01-25 K B	LHSM	CX-NSZ300
O	TAPE DECK	C	0408 87-012-286-080	OE	C-CAP,U 0.01-25 K B	USM	CX-SNAJ300
O	TAPE DECK	C	0408 87-012-286-080	OE	C-CAP,U 0.01-25 K B	USM	CX-SNAJ305
O	TAPE DECK	C	0409 87-012-278-080		C-CAP,U 2200P-50 K B	LHSM	CX-NSZ300
O	TAPE DECK	C	0409 87-012-278-080		C-CAP,U 2200P-50 K B	USM	CX-SNAJ300
O	TAPE DECK	C	0409 87-012-278-080		C-CAP,U 2200P-50 K B	USM	CX-SNAJ305
O	TAPE DECK	C	0409 87-012-278-080		C-CAP,U 2200P-50 K B	EZSM	CX-NSZ300
O	TAPE DECK	C	0409 87-012-278-080	OE	C-CAP,U 2200P-50 K B	LHSM	CX-NSZ300
O	TAPE DECK	C	0409 87-012-278-080	OE	C-CAP,U 2200P-50 K B	USM	CX-SNAJ300
O	TAPE DECK	C	0409 87-012-278-080	OE	C-CAP,U 2200P-50 K B	USM	CX-SNAJ305
O	TAPE DECK	C	0410 87-012-278-080		C-CAP,U 2200P-50 K B	LHSM	CX-NSZ300
O	TAPE DECK	C	0410 87-012-278-080		C-CAP,U 2200P-50 K B	USM	CX-SNAJ300
O	TAPE DECK	C	0410 87-012-278-080		C-CAP,U 2200P-50 K B	USM	CX-SNAJ305
O	TAPE DECK	C	0410 87-012-278-080	OE	C-CAP,U 2200P-50 K B	LHSM	CX-NSZ300
O	TAPE DECK	C	0410 87-012-278-080	OE	C-CAP,U 2200P-50 K B	USM	CX-SNAJ300
O	TAPE DECK	C	0410 87-012-278-080	OE	C-CAP,U 2200P-50 K B	USM	CX-SNAJ305
O	TAPE DECK	C	0411 87-A12-091-080		CAP,E 10-50 SMG	LHSM	CX-NSZ300
O	TAPE DECK	C	0411 87-A12-091-080		CAP,E 10-50 SMG	USM	CX-SNAJ300
O	TAPE DECK	C	0411 87-A12-091-080		CAP,E 10-50 SMG	USM	CX-SNAJ305
O	TAPE DECK	C	0411 87-A12-091-080		CAP,E 10-50 SMG	EZSM	CX-NSZ300
O	TAPE DECK	C	0411 87-A12-091-080	OE	CAP,E 10-50 SMG	LHSM	CX-NSZ300
O	TAPE DECK	C	0411 87-A12-091-080	OE	CAP,E 10-50 SMG	USM	CX-SNAJ300
O	TAPE DECK	C	0411 87-A12-091-080	OE	CAP,E 10-50 SMG	USM	CX-SNAJ305
O	TAPE DECK	C	0412 87-A12-091-080		CAP,E 10-50 SMG	LHSM	CX-NSZ300
O	TAPE DECK	C	0412 87-A12-091-080		CAP,E 10-50 SMG	USM	CX-SNAJ300
O	TAPE DECK	C	0412 87-A12-091-080		CAP,E 10-50 SMG	USM	CX-SNAJ305
O	TAPE DECK	C	0412 87-A12-091-080		CAP,E 10-50 SMG	EZSM	CX-NSZ300
O	TAPE DECK	C	0412 87-A12-091-080	OE	CAP,E 10-50 SMG	LHSM	CX-NSZ300
O	TAPE DECK	C	0412 87-A12-091-080	OE	CAP,E 10-50 SMG	USM	CX-SNAJ300
O	TAPE DECK	C	0412 87-A12-091-080	OE	CAP,E 10-50 SMG	USM	CX-SNAJ305
O	TAPE DECK	C	0412 87-A12-091-080		CAP,E 10-50 SMG	LHSM	CX-NSZ300
O	TAPE DECK	C	0452 87-A12-069-080		CAP,E 22-25 SMG	LHSM	CX-NSZ300

PARTS LIST

! = Δ SAFTY PARTS
 C = Components marked

All components used on this model at the production line are shown in this service manual.

However, please note that not all components will be available as spare parts for after-sales service.

Components marked S and O are designated as spare parts for service and will be stocked at the spare parts centers.

Components marked X and R are not designated as spare parts for after sales service, and will not be stocked at the spare parts centers.

K NO. = Only use japanese.

! C	UNIT NAME	REF NO.	PARTS CODE	K NO.	DESCRIPTION	SUFFIX	MODEL NAME
O	TAPE DECK	C	0452 87-A12-069-080		CAP,E 22-25 SMG	USM	CX-SNAJ300
O	TAPE DECK	C	0452 87-A12-069-080		CAP,E 22-25 SMG	USM	CX-SNAJ305
O	TAPE DECK	C	0452 87-A12-069-080		CAP,E 22-25 SMG	EZSM	CX-NSZ300
O	TAPE DECK	C	0452 87-A12-069-080	OE	CAP,E 22-25 SMG	LHSM	CX-NSZ300
O	TAPE DECK	C	0452 87-A12-069-080	OE	CAP,E 22-25 SMG	USM	CX-SNAJ300
O	TAPE DECK	C	0452 87-A12-069-080	OE	CAP,E 22-25 SMG	USM	CX-SNAJ305
O	TAPE DECK	C	0453 87-012-279-080		C-CAP,U 2700P-50 K B GRM	LHSM	CX-NSZ300
O	TAPE DECK	C	0453 87-012-279-080		C-CAP,U 2700P-50 K B GRM	USM	CX-SNAJ300
O	TAPE DECK	C	0453 87-012-279-080		C-CAP,U 2700P-50 K B GRM	USM	CX-SNAJ305
O	TAPE DECK	C	0453 87-012-279-080		C-CAP,U 2700P-50 K B GRM	EZSM	CX-NSZ300
O	TAPE DECK	C	0453 87-012-279-080	OE	C-CAP,U 2700P-50 K B GRM	LHSM	CX-NSZ300
O	TAPE DECK	C	0453 87-012-279-080	OE	C-CAP,U 2700P-50 K B GRM	USM	CX-SNAJ300
O	TAPE DECK	C	0453 87-012-279-080	OE	C-CAP,U 2700P-50 K B GRM	USM	CX-SNAJ305
O	TAPE DECK	C	0453 87-012-279-080	OE	C-CAP,U 2700P-50 K B GRM	USM	CX-SNAJ300
O	TAPE DECK	C	0453 87-012-279-080	OE	C-CAP,U 2700P-50 K B GRM	USM	CX-SNAJ305
O	TAPE DECK	C	0454 87-012-279-080		C-CAP,U 2700P-50 K B GRM	LHSM	CX-NSZ300
O	TAPE DECK	C	0454 87-012-279-080		C-CAP,U 2700P-50 K B GRM	USM	CX-SNAJ300
O	TAPE DECK	C	0454 87-012-279-080		C-CAP,U 2700P-50 K B GRM	USM	CX-SNAJ305
O	TAPE DECK	C	0454 87-012-279-080		C-CAP,U 2700P-50 K B GRM	LHSM	CX-NSZ300
O	TAPE DECK	C	0454 87-012-279-080		C-CAP,U 2700P-50 K B GRM	USM	CX-SNAJ300
O	TAPE DECK	C	0454 87-012-279-080		C-CAP,U 2700P-50 K B GRM	USM	CX-SNAJ305
O	TAPE DECK	C	0454 87-012-279-080	OE	C-CAP,U 2700P-50 K B GRM	LHSM	CX-NSZ300
O	TAPE DECK	C	0454 87-012-279-080	OE	C-CAP,U 2700P-50 K B GRM	USM	CX-SNAJ300
O	TAPE DECK	C	0454 87-012-279-080	OE	C-CAP,U 2700P-50 K B GRM	USM	CX-SNAJ305
O	TAPE DECK	C	0455 87-012-279-080		C-CAP,U 2700P-50 K B GRM	LHSM	CX-NSZ300
O	TAPE DECK	C	0455 87-012-279-080		C-CAP,U 2700P-50 K B GRM	USM	CX-SNAJ300
O	TAPE DECK	C	0455 87-012-279-080		C-CAP,U 2700P-50 K B GRM	USM	CX-SNAJ305
O	TAPE DECK	C	0455 87-012-279-080		C-CAP,U 2700P-50 K B GRM	EZSM	CX-NSZ300
O	TAPE DECK	C	0455 87-012-279-080	OE	C-CAP,U 2700P-50 K B GRM	LHSM	CX-NSZ300
O	TAPE DECK	C	0455 87-012-279-080	OE	C-CAP,U 2700P-50 K B GRM	USM	CX-SNAJ300
O	TAPE DECK	C	0455 87-012-279-080	OE	C-CAP,U 2700P-50 K B GRM	USM	CX-SNAJ305
O	TAPE DECK	C	0456 87-012-286-080		C-CAP,U 0.01-25 K B	LHSM	CX-NSZ300
O	TAPE DECK	C	0456 87-012-286-080		C-CAP,U 0.01-25 K B	USM	CX-SNAJ300
O	TAPE DECK	C	0456 87-012-286-080		C-CAP,U 0.01-25 K B	USM	CX-SNAJ305
O	TAPE DECK	C	0456 87-012-286-080		C-CAP,U 0.01-25 K B	EZSM	CX-NSZ300
O	TAPE DECK	C	0456 87-012-286-080	OE	C-CAP,U 0.01-25 K B	LHSM	CX-NSZ300
O	TAPE DECK	C	0456 87-012-286-080	OE	C-CAP,U 0.01-25 K B	USM	CX-SNAJ300
O	TAPE DECK	C	0456 87-012-286-080	OE	C-CAP,U 0.01-25 K B	USM	CX-SNAJ305
O	TAPE DECK	C	0457 87-A12-361-080		CAP,M 5600P-100 J CP	LHSM	CX-NSZ300
O	TAPE DECK	C	0457 87-A12-361-080		CAP,M 5600P-100 J CP	USM	CX-SNAJ300
O	TAPE DECK	C	0457 87-A12-361-080		CAP,M 5600P-100 J CP	USM	CX-SNAJ305
O	TAPE DECK	C	0457 87-A12-361-080		CAP,M 5600P-100 J CP	EZSM	CX-NSZ300
O	TAPE DECK	C	0457 87-A12-361-080	OE	CAP,M 5600P-100 J CP	LHSM	CX-NSZ300
O	TAPE DECK	C	0457 87-A12-361-080	OE	CAP,M 5600P-100 J CP	USM	CX-SNAJ300
O	TAPE DECK	C	0457 87-A12-361-080	OE	CAP,M 5600P-100 J CP	USM	CX-SNAJ305
O	TAPE DECK	C	0458 87-012-274-080		C-CAP,U 1000P-50 K B	LHSM	CX-NSZ300
O	TAPE DECK	C	0458 87-012-274-080		C-CAP,U 1000P-50 K B	USM	CX-SNAJ300
O	TAPE DECK	C	0458 87-012-274-080		C-CAP,U 1000P-50 K B	USM	CX-SNAJ305
O	TAPE DECK	C	0458 87-012-274-080		C-CAP,U 1000P-50 K B	USM	CX-NSZ300
O	TAPE DECK	C	0458 87-012-274-080	OE	C-CAP,U 1000P-50 K B	LHSM	CX-NSZ300
O	TAPE DECK	C	0458 87-012-274-080	OE	C-CAP,U 1000P-50 K B	USM	CX-SNAJ300
O	TAPE DECK	C	0458 87-012-274-080	OE	C-CAP,U 1000P-50 K B	USM	CX-SNAJ305
O	TAPE DECK	C	0459 87-010-175-080		C-CAP,S 560P-50 J SL	LHSM	CX-NSZ300
O	TAPE DECK	C	0459 87-010-175-080		C-CAP,S 560P-50 J SL	USM	CX-SNAJ300
O	TAPE DECK	C	0459 87-010-175-080		C-CAP,S 560P-50 J SL	USM	CX-SNAJ305
O	TAPE DECK	C	0459 87-012-271-080		C-CAP,U 560P-50 K B	EZSM	CX-NSZ300
O	TAPE DECK	C	0459 87-012-271-080	OE	C-CAP,U 560P-50 K B	LHSM	CX-NSZ300
O	TAPE DECK	C	0459 87-012-271-080	OE	C-CAP,U 560P-50 K B	USM	CX-SNAJ300
O	TAPE DECK	C	0459 87-012-271-080	OE	C-CAP,U 560P-50 K B	USM	CX-SNAJ305
O	TAPE DECK	C	0460 87-010-831-080		C-CAP,U 0.1-16 Z F	LHSM	CX-NSZ300
O	TAPE DECK	C	0460 87-010-831-080		C-CAP,U 0.1-16 Z F	USM	CX-SNAJ300
O	TAPE DECK	C	0460 87-010-831-080		C-CAP,U 0.1-16 Z F	USM	CX-SNAJ305
O	TAPE DECK	C	0460 87-010-831-080		C-CAP,U 0.1-16 Z F	USM	CX-NSZ300
O	TAPE DECK	C	0460 87-010-831-080	OE	C-CAP,U 0.1-16 Z F	LHSM	CX-NSZ300
O	TAPE DECK	C	0460 87-010-831-080	OE	C-CAP,U 0.1-16 Z F	USM	CX-SNAJ300
O	TAPE DECK	C	0460 87-010-831-080	OE	C-CAP,U 0.1-16 Z F	USM	CX-SNAJ305
O	TAPE DECK	C	0461 87-012-158-080		C-CAP,S 390P-50 J CH GRM	LHSM	CX-NSZ300
O	TAPE DECK	C	0461 87-012-158-080		C-CAP,S 390P-50 J CH GRM	USM	CX-SNAJ300
O	TAPE DECK	C	0461 87-012-158-080		C-CAP,S 390P-50 J CH GRM	USM	CX-SNAJ305
O	TAPE DECK	C	0461 87-012-158-080		C-CAP,S 390P-50 J CH GRM	EZSM	CX-NSZ300
O	TAPE DECK	C	0461 87-012-158-080	OE	C-CAP,S 390P-50 J CH GRM	LHSM	CX-NSZ300
O	TAPE DECK	C	0461 87-012-158-080	OE	C-CAP,S 390P-50 J CH GRM	USM	CX-SNAJ300
O	TAPE DECK	C	0461 87-012-158-080	OE	C-CAP,S 390P-50 J CH GRM	USM	CX-SNAJ305
O	TAPE DECK	C	0461 87-012-158-080	OE	C-CAP,S 390P-50 J CH GRM	USM	CX-NSZ300
O	TAPE DECK	C	0462 87-012-158-080		C-CAP,S 390P-50 J CH GRM	LHSM	CX-NSZ300

PARTS LIST

! = Δ SAFTY PARTS
 C = Components marked

All components used on this model at the production line are shown in this service manual.

However, please note that not all components will be available as spare parts for after-sales service.

Components marked S and O are designated as spare parts for service and will be stocked at the spare parts centers.

Components marked X and R are not designated as spare parts for after sales service, and will not be stocked at the spare parts centers.

K NO. = Only use japanese.

! C	UNIT NAME	REF NO.	PARTS CODE	K NO.	DESCRIPTION	SUFFIX	MODEL NAME
O	TAPE DECK	C 0462	87-012-158-080		C-CAP,S 390P-50 J CH GRM	USM	CX-SNAJ300
O	TAPE DECK	C 0462	87-012-158-080		C-CAP,S 390P-50 J CH GRM	USM	CX-SNAJ305
O	TAPE DECK	C 0462	87-012-158-080		C-CAP,S 390P-50 J CH GRM	EZSM	CX-NSZ300
O	TAPE DECK	C 0462	87-012-158-080	OE	C-CAP,S 390P-50 J CH GRM	LHSM	CX-NSZ300
O	TAPE DECK	C 0462	87-012-158-080	OE	C-CAP,S 390P-50 J CH GRM	USM	CX-SNAJ300
O	TAPE DECK	C 0462	87-012-158-080	OE	C-CAP,S 390P-50 J CH GRM	USM	CX-SNAJ305
O	TAPE DECK	C 0470	87-018-127-080		CAP,TC U 470P-50 K B UP050	LHSM	CX-NSZ300
O	TAPE DECK	C 0470	87-018-127-080		CAP,TC U 470P-50 K B UP050	USM	CX-SNAJ300
O	TAPE DECK	C 0470	87-018-127-080		CAP,TC U 470P-50 K B UP050	USM	CX-SNAJ305
O	TAPE DECK	C 0470	87-018-127-080		CAP,TC U 470P-50 K B UP050	EZSM	CX-NSZ300
O	TAPE DECK	C 0470	87-018-127-080	OE	CAP,TC U 470P-50 K B UP050	LHSM	CX-NSZ300
O	TAPE DECK	C 0470	87-018-127-080	OE	CAP,TC U 470P-50 K B UP050	USM	CX-SNAJ300
O	TAPE DECK	C 0470	87-018-127-080	OE	CAP,TC U 470P-50 K B UP050	USM	CX-SNAJ305
X	TAPE DECK	CLP0302	87-A60-884-010		PIN,DIA1 COATING-SHS	LHSM	CX-NSZ300
X	TAPE DECK	CLP0302	87-A60-884-010		PIN,DIA1 COATING-SHS	USM	CX-SNAJ300
X	TAPE DECK	CLP0302	87-A60-884-010		PIN,DIA1 COATING-SHS	USM	CX-SNAJ305
X	TAPE DECK	CLP0302	87-A60-884-010		PIN,DIA1 COATING-SHS	EZSM	CX-NSZ300
X	TAPE DECK	CLP0302	87-A60-884-010	OE	PIN,DIA1 COATING-SHS	LHSM	CX-NSZ300
X	TAPE DECK	CLP0302	87-A60-884-010	OE	PIN,DIA1 COATING-SHS	USM	CX-SNAJ300
X	TAPE DECK	CLP0302	87-A60-884-010	OE	PIN,DIA1 COATING-SHS	USM	CX-SNAJ305
O	TAPE DECK	CN 0301	87-A60-620-010		CONN,3P V 2MM JMT	LHSM	CX-NSZ300
O	TAPE DECK	CN 0301	87-A60-620-010		CONN,3P V 2MM JMT	USM	CX-SNAJ300
O	TAPE DECK	CN 0301	87-A60-620-010		CONN,3P V 2MM JMT	USM	CX-SNAJ305
O	TAPE DECK	CN 0301	87-A60-620-010		CONN,3P V 2MM JMT	EZSM	CX-NSZ300
O	TAPE DECK	CN 0301	87-A60-620-010	OE	CONN,3P V 2MM JMT	LHSM	CX-NSZ300
O	TAPE DECK	CN 0301	87-A60-620-010	OE	CONN,3P V 2MM JMT	USM	CX-SNAJ300
O	TAPE DECK	CN 0301	87-A60-620-010	OE	CONN,3P V 2MM JMT	USM	CX-SNAJ305
O	TAPE DECK	CN 0351	87-A60-625-010		CONN,8P V 2MM JMT	LHSM	CX-NSZ300
O	TAPE DECK	CN 0351	87-A60-625-010		CONN,8P V 2MM JMT	USM	CX-SNAJ300
O	TAPE DECK	CN 0351	87-A60-625-010		CONN,8P V 2MM JMT	USM	CX-SNAJ305
O	TAPE DECK	CN 0351	87-A60-625-010		CONN,8P V 2MM JMT	EZSM	CX-NSZ300
O	TAPE DECK	CN 0351	87-A60-625-010	OE	CONN,8P V 2MM JMT	LHSM	CX-NSZ300
O	TAPE DECK	CN 0351	87-A60-625-010	OE	CONN,8P V 2MM JMT	USM	CX-SNAJ300
O	TAPE DECK	CN 0351	87-A60-625-010	OE	CONN,8P V 2MM JMT	USM	CX-SNAJ305
S	TAPE DECK	D 0401	87-A40-291-080		DIODE,1N4148M (CPT)	LHSM	CX-NSZ300
S	TAPE DECK	D 0401	87-A40-291-080		DIODE,1N4148M (CPT)	USM	CX-SNAJ300
S	TAPE DECK	D 0401	87-A40-291-080		DIODE,1N4148M (CPT)	USM	CX-SNAJ305
S	TAPE DECK	D 0401	87-A40-291-080		DIODE,1N4148M (CPT)	EZSM	CX-NSZ300
S	TAPE DECK	D 0401	87-A40-291-080	OE	DIODE,1N4148M (CPT)	LHSM	CX-NSZ300
S	TAPE DECK	D 0401	87-A40-291-080	OE	DIODE,1N4148M (CPT)	USM	CX-SNAJ300
S	TAPE DECK	D 0401	87-A40-291-080	OE	DIODE,1N4148M (CPT)	USM	CX-SNAJ305
S	TAPE DECK	D 0401	87-A40-291-080	OE	DIODE,1N4148M (CPT)	USM	CX-NSZ300
S	TAPE DECK	D 0401	87-A40-291-080	OE	DIODE,1N4148M (CPT)	USM	CX-SNAJ300
S	TAPE DECK	D 0401	87-A40-291-080	OE	DIODE,1N4148M (CPT)	USM	CX-SNAJ305
X	TAPE DECK	FB 0301	88-100-000-010		PLATING-JW, 0.58 SN95	LHSM	CX-NSZ300
X	TAPE DECK	FB 0301	88-100-000-010		PLATING-JW, 0.58 SN95	USM	CX-SNAJ300
X	TAPE DECK	FB 0301	88-100-000-010		PLATING-JW, 0.58 SN95	USM	CX-SNAJ305
X	TAPE DECK	FB 0301	88-100-000-010		PLATING-JW, 0.58 SN95	EZSM	CX-NSZ300
X	TAPE DECK	FB 0301	88-100-000-010	OE	PLATING-JW, 0.58 SN95	LHSM	CX-NSZ300
X	TAPE DECK	FB 0301	88-100-000-010	OE	PLATING-JW, 0.58 SN95	USM	CX-SNAJ300
X	TAPE DECK	FB 0301	88-100-000-010	OE	PLATING-JW, 0.58 SN95	USM	CX-SNAJ305
X	TAPE DECK	FB 0302	88-108-000-080		C-JUMPER,U	LHSM	CX-NSZ300
X	TAPE DECK	FB 0302	88-108-000-080		C-JUMPER,U	USM	CX-SNAJ300
X	TAPE DECK	FB 0302	88-108-000-080		C-JUMPER,U	USM	CX-SNAJ305
X	TAPE DECK	FB 0302	88-108-000-080	OE	C-JUMPER,U	LHSM	CX-NSZ300
X	TAPE DECK	FB 0302	88-108-000-080	OE	C-JUMPER,U	USM	CX-SNAJ300
X	TAPE DECK	FB 0302	88-108-000-080	OE	C-JUMPER,U	USM	CX-SNAJ305
S	TAPE DECK	IC 0301	87-A21-419-040		C-IC,NJM14558MD-TE2	EZSM	CX-NSZ300
S	TAPE DECK	IC 0301	87-A21-419-040		C-IC,NJM14558MD-TE2	LHSM	CX-NSZ300
S	TAPE DECK	IC 0301	87-A21-419-040	OE	C-IC,NJM14558MD-TE2	USM	CX-SNAJ300
S	TAPE DECK	IC 0301	87-A21-419-040	OE	C-IC,NJM14558MD-TE2	USM	CX-SNAJ305
O	S TAPE DECK	IC 0301	87-A21-419-040	OE	C-IC,NJM14558MD-TE2	LHSM	CX-NSZ300
O	S TAPE DECK	IC 0301	87-A21-419-040		C-IC,NJM14558MD-TE2	USM	CX-SNAJ300
O	S TAPE DECK	IC 0301	87-A21-419-040		C-IC,NJM14558MD-TE2	USM	CX-SNAJ305
S	TAPE DECK	IC 0401	87-A21-893-040		C-IC,NJM14558V-TE2	EZSM	CX-NSZ300
S	TAPE DECK	IC 0401	87-A21-893-040	1A	C-IC,NJM14558V-TE2	LHSM	CX-NSZ300
S	TAPE DECK	IC 0401	87-A21-893-040	1A	C-IC,NJM14558V-TE2	USM	CX-SNAJ300
S	TAPE DECK	IC 0401	87-A21-893-040	1A	C-IC,NJM14558V-TE2	USM	CX-SNAJ305
O	S TAPE DECK	IC 0401	87-A21-893-040		C-IC,NJM14558V-TE2	LHSM	CX-NSZ300
O	S TAPE DECK	IC 0401	87-A21-893-040		C-IC,NJM14558V-TE2	USM	CX-SNAJ300
O	S TAPE DECK	IC 0401	87-A21-893-040		C-IC,NJM14558V-TE2	USM	CX-SNAJ305
X	TAPE DECK	JR 0302	88-129-000-080		C-JUMPER,3216	LHSM	CX-NSZ300

PARTS LIST

! = Δ SAFTY PARTS
 C = Components marked

All components used on this model at the production line are shown in this service manual.

However, please note that not all components will be available as spare parts for after-sales service.

Components marked S and O are designated as spare parts for service and will be stocked at the spare parts centers.

Components marked X and R are not designated as spare parts for after sales service, and will not be stocked at the spare parts centers.

K NO. = Only use japanese.

! C	UNIT NAME	REF NO.	PARTS CODE	K NO.	DESCRIPTION	SUFFIX	MODEL NAME
X	TAPE DECK	JR 0302	88-129-000-080		C-JUMPER, 3216	USM	CX-SNAJ300
X	TAPE DECK	JR 0302	88-129-000-080		C-JUMPER, 3216	USM	CX-SNAJ305
X	TAPE DECK	JR 0302	88-129-000-080		C-JUMPER, 3216	EZSM	CX-NSZ300
X	TAPE DECK	JR 0302	88-129-000-080	OE	C-JUMPER, 3216	USM	CX-SNAJ300
X	TAPE DECK	JR 0302	88-129-000-080	OE	C-JUMPER, 3216	USM	CX-SNAJ305
X	TAPE DECK	JR 0305	88-108-000-080		C-JUMPER, U	LHSM	CX-NSZ300
X	TAPE DECK	JR 0305	88-108-000-080		C-JUMPER, U	USM	CX-SNAJ300
X	TAPE DECK	JR 0305	88-108-000-080		C-JUMPER, U	USM	CX-SNAJ305
X	TAPE DECK	JR 0305	88-108-000-080		C-JUMPER, U	EZSM	CX-NSZ300
X	TAPE DECK	JR 0305	88-108-000-080	OE	C-JUMPER, U	LHSM	CX-NSZ300
X	TAPE DECK	JR 0305	88-108-000-080	OE	C-JUMPER, U	USM	CX-SNAJ300
X	TAPE DECK	JR 0305	88-108-000-080	OE	C-JUMPER, U	USM	CX-SNAJ305
X	TAPE DECK	JR 0306	88-108-000-080		C-JUMPER, U	LHSM	CX-NSZ300
X	TAPE DECK	JR 0306	88-108-000-080		C-JUMPER, U	USM	CX-SNAJ300
X	TAPE DECK	JR 0306	88-108-000-080		C-JUMPER, U	USM	CX-SNAJ305
X	TAPE DECK	JR 0306	88-108-000-080	OE	C-JUMPER, U	LHSM	CX-NSZ300
X	TAPE DECK	JR 0306	88-108-000-080	OE	C-JUMPER, U	USM	CX-SNAJ300
X	TAPE DECK	JR 0306	88-108-000-080	OE	C-JUMPER, U	USM	CX-SNAJ305
X	TAPE DECK	JR 0307	88-108-000-080		C-JUMPER, U	LHSM	CX-NSZ300
X	TAPE DECK	JR 0307	88-108-000-080		C-JUMPER, U	USM	CX-SNAJ300
X	TAPE DECK	JR 0307	88-108-000-080		C-JUMPER, U	USM	CX-SNAJ305
X	TAPE DECK	JR 0307	88-108-000-080		C-JUMPER, U	EZSM	CX-NSZ300
X	TAPE DECK	JR 0307	88-108-000-080	OE	C-JUMPER, U	LHSM	CX-NSZ300
X	TAPE DECK	JR 0307	88-108-000-080	OE	C-JUMPER, U	USM	CX-SNAJ300
X	TAPE DECK	JR 0307	88-108-000-080	OE	C-JUMPER, U	USM	CX-SNAJ305
X	TAPE DECK	JR 0401	88-129-000-080		C-JUMPER, 3216	LHSM	CX-NSZ300
X	TAPE DECK	JR 0401	88-129-000-080		C-JUMPER, 3216	USM	CX-SNAJ300
X	TAPE DECK	JR 0401	88-129-000-080		C-JUMPER, 3216	USM	CX-SNAJ305
X	TAPE DECK	JR 0401	88-129-000-080		C-JUMPER, 3216	EZSM	CX-NSZ300
X	TAPE DECK	JR 0401	88-129-000-080	OE	C-JUMPER, 3216	USM	CX-SNAJ300
X	TAPE DECK	JR 0401	88-129-000-080	OE	C-JUMPER, 3216	USM	CX-SNAJ305
X	TAPE DECK	JR 0402	88-108-000-080		C-JUMPER, U	LHSM	CX-NSZ300
X	TAPE DECK	JR 0402	88-108-000-080		C-JUMPER, U	USM	CX-SNAJ300
X	TAPE DECK	JR 0402	88-108-000-080		C-JUMPER, U	USM	CX-SNAJ305
X	TAPE DECK	JR 0402	88-108-000-080		C-JUMPER, U	EZSM	CX-NSZ300
X	TAPE DECK	JR 0402	88-108-000-080	OE	C-JUMPER, U	LHSM	CX-NSZ300
X	TAPE DECK	JR 0402	88-108-000-080	OE	C-JUMPER, U	USM	CX-SNAJ300
X	TAPE DECK	JR 0402	88-108-000-080	OE	C-JUMPER, U	USM	CX-SNAJ305
X	TAPE DECK	JR 0403	88-129-000-080		C-JUMPER, 3216	LHSM	CX-NSZ300
X	TAPE DECK	JR 0403	88-129-000-080		C-JUMPER, 3216	USM	CX-SNAJ300
X	TAPE DECK	JR 0403	88-129-000-080		C-JUMPER, 3216	USM	CX-SNAJ305
X	TAPE DECK	JR 0403	88-129-000-080		C-JUMPER, 3216	EZSM	CX-NSZ300
X	TAPE DECK	JR 0403	88-129-000-080	OE	C-JUMPER, 3216	USM	CX-SNAJ300
X	TAPE DECK	JR 0403	88-129-000-080	OE	C-JUMPER, 3216	USM	CX-SNAJ305
X	TAPE DECK	JR 0404	88-128-150-080		C-RES, 15-1/8W J	LHSM	CX-NSZ300
X	TAPE DECK	JR 0404	88-128-150-080		C-RES, 15-1/8W J	USM	CX-SNAJ300
X	TAPE DECK	JR 0404	88-128-150-080		C-RES, 15-1/8W J	USM	CX-SNAJ305
X	TAPE DECK	JR 0404	88-128-150-080		C-RES, 15-1/8W J	EZSM	CX-NSZ300
X	TAPE DECK	JR 0404	88-128-150-080	OE	C-RES, 15-1/8W J	USM	CX-SNAJ300
X	TAPE DECK	JR 0404	88-128-150-080	OE	C-RES, 15-1/8W J	USM	CX-SNAJ305
O	TAPE DECK	L 0451	87-007-342-010		COIL, OSC 85KHZ BIAS	LHSM	CX-NSZ300
O	TAPE DECK	L 0451	87-007-342-010		COIL, OSC 85KHZ BIAS	USM	CX-SNAJ300
O	TAPE DECK	L 0451	87-007-342-010		COIL, OSC 85KHZ BIAS	USM	CX-SNAJ305
O	TAPE DECK	L 0451	87-007-342-010		COIL, OSC 85KHZ BIAS	EZSM	CX-NSZ300
O	TAPE DECK	L 0451	87-007-342-010	OE	COIL, OSC 85KHZ BIAS	LHSM	CX-NSZ300
O	TAPE DECK	L 0451	87-007-342-010	OE	COIL, OSC 85KHZ BIAS	USM	CX-SNAJ300
O	TAPE DECK	L 0451	87-007-342-010	OE	COIL, OSC 85KHZ BIAS	USM	CX-SNAJ305
S	TAPE DECK	Q 0301	87-A30-091-080		FET, 2SJ460	LHSM	CX-NSZ300
S	TAPE DECK	Q 0301	87-A30-091-080		FET, 2SJ460	USM	CX-SNAJ300
S	TAPE DECK	Q 0301	87-A30-091-080		FET, 2SJ460	USM	CX-SNAJ305
S	TAPE DECK	Q 0301	87-A30-091-080	1E	FET, 2SJ460	LHSM	CX-NSZ300
S	TAPE DECK	Q 0301	87-A30-091-080	1E	FET, 2SJ460	USM	CX-SNAJ300
S	TAPE DECK	Q 0301	87-A30-091-080	1E	FET, 2SJ460	USM	CX-SNAJ305
S	TAPE DECK	Q 0302	87-A30-091-080		FET, 2SJ460	LHSM	CX-NSZ300
S	TAPE DECK	Q 0302	87-A30-091-080		FET, 2SJ460	USM	CX-SNAJ300
S	TAPE DECK	Q 0302	87-A30-091-080		FET, 2SJ460	USM	CX-SNAJ305
S	TAPE DECK	Q 0302	87-A30-091-080		FET, 2SJ460	EZSM	CX-NSZ300
S	TAPE DECK	Q 0302	87-A30-091-080	1E	FET, 2SJ460	LHSM	CX-NSZ300

PARTS LIST

! = Δ SAFTY PARTS
 C = Components marked

All components used on this model at the production line are shown in this service manual.

However, please note that not all components will be available as spare parts for after-sales service.

Components marked S and O are designated as spare parts for service and will be stocked at the spare parts centers.

Components marked X and R are not designated as spare parts for after sales service, and will not be stocked at the spare parts centers.

K NO. = Only use japanese.

! C	UNIT NAME	REF NO.	PARTS CODE	K NO.	DESCRIPTION	SUFFIX	MODEL NAME	
S	TAPE DECK	Q	0302	87-A30-091-080	1E	FET, 2SJ460	USM	CX-SNAJ300
S	TAPE DECK	Q	0302	87-A30-091-080	1E	FET, 2SJ460	USM	CX-SNAJ305
S	TAPE DECK	Q	0303	87-A30-090-080		FET, 2SK2541	LHSM	CX-NSZ300
S	TAPE DECK	Q	0303	87-A30-090-080		FET, 2SK2541	USM	CX-SNAJ300
S	TAPE DECK	Q	0303	87-A30-090-080		FET, 2SK2541	USM	CX-SNAJ305
S	TAPE DECK	Q	0303	87-A30-090-080		FET, 2SK2541	EZSM	CX-NSZ300
S	TAPE DECK	Q	0303	87-A30-090-080	0E	FET, 2SK2541	LHSM	CX-NSZ300
S	TAPE DECK	Q	0303	87-A30-090-080	0E	FET, 2SK2541	USM	CX-SNAJ300
S	TAPE DECK	Q	0303	87-A30-090-080	0E	FET, 2SK2541	USM	CX-SNAJ305
S	TAPE DECK	Q	0304	87-A30-090-080		FET, 2SK2541	LHSM	CX-NSZ300
S	TAPE DECK	Q	0304	87-A30-090-080		FET, 2SK2541	USM	CX-SNAJ300
S	TAPE DECK	Q	0304	87-A30-090-080		FET, 2SK2541	USM	CX-SNAJ305
S	TAPE DECK	Q	0304	87-A30-090-080	0E	FET, 2SK2541	EZSM	CX-NSZ300
S	TAPE DECK	Q	0304	87-A30-090-080	0E	FET, 2SK2541	LHSM	CX-NSZ300
S	TAPE DECK	Q	0304	87-A30-090-080	0E	FET, 2SK2541	USM	CX-SNAJ300
S	TAPE DECK	Q	0304	87-A30-090-080	0E	FET, 2SK2541	USM	CX-SNAJ305
S	TAPE DECK	Q	0305	87-A30-091-080		FET, 2SJ460	LHSM	CX-NSZ300
S	TAPE DECK	Q	0305	87-A30-091-080		FET, 2SJ460	USM	CX-SNAJ300
S	TAPE DECK	Q	0305	87-A30-091-080		FET, 2SJ460	USM	CX-SNAJ305
S	TAPE DECK	Q	0305	87-A30-091-080		FET, 2SJ460	EZSM	CX-NSZ300
S	TAPE DECK	Q	0305	87-A30-091-080	1E	FET, 2SJ460	LHSM	CX-NSZ300
S	TAPE DECK	Q	0305	87-A30-091-080	1E	FET, 2SJ460	USM	CX-SNAJ300
S	TAPE DECK	Q	0305	87-A30-091-080	1E	FET, 2SJ460	USM	CX-SNAJ305
S	TAPE DECK	Q	0306	87-A30-062-080		C-TR, KRC104S	LHSM	CX-NSZ300
S	TAPE DECK	Q	0306	87-A30-062-080		C-TR, KRC104S	USM	CX-SNAJ300
S	TAPE DECK	Q	0306	87-A30-062-080		C-TR, KRC104S	USM	CX-SNAJ305
S	TAPE DECK	Q	0306	87-A30-062-080	0E	C-TR, KRC104S	EZSM	CX-NSZ300
S	TAPE DECK	Q	0306	87-A30-062-080	0E	C-TR, KRC104S	LHSM	CX-NSZ300
S	TAPE DECK	Q	0306	87-A30-062-080	0E	C-TR, KRC104S	USM	CX-SNAJ300
S	TAPE DECK	Q	0306	87-A30-062-080	0E	C-TR, KRC104S	USM	CX-SNAJ305
S	TAPE DECK	Q	0307	87-A30-091-080		FET, 2SJ460	LHSM	CX-NSZ300
S	TAPE DECK	Q	0307	87-A30-091-080		FET, 2SJ460	USM	CX-SNAJ300
S	TAPE DECK	Q	0307	87-A30-091-080		FET, 2SJ460	USM	CX-SNAJ305
S	TAPE DECK	Q	0307	87-A30-091-080		FET, 2SJ460	EZSM	CX-NSZ300
S	TAPE DECK	Q	0307	87-A30-091-080	1E	FET, 2SJ460	LHSM	CX-NSZ300
S	TAPE DECK	Q	0307	87-A30-091-080	1E	FET, 2SJ460	USM	CX-SNAJ300
S	TAPE DECK	Q	0307	87-A30-091-080	1E	FET, 2SJ460	USM	CX-SNAJ305
S	TAPE DECK	Q	0308	87-A30-091-080		FET, 2SJ460	LHSM	CX-NSZ300
S	TAPE DECK	Q	0308	87-A30-091-080		FET, 2SJ460	USM	CX-SNAJ300
S	TAPE DECK	Q	0308	87-A30-091-080		FET, 2SJ460	USM	CX-SNAJ305
S	TAPE DECK	Q	0308	87-A30-091-080	1E	FET, 2SJ460	USM	CX-SNAJ305
S	TAPE DECK	Q	0309	87-A30-075-080		C-TR, 2SA1235F	LHSM	CX-NSZ300
S	TAPE DECK	Q	0309	87-A30-075-080		C-TR, 2SA1235F	USM	CX-SNAJ300
S	TAPE DECK	Q	0309	87-A30-075-080		C-TR, 2SA1235F	USM	CX-SNAJ305
S	TAPE DECK	Q	0309	87-A30-075-080		C-TR, 2SA1235F	EZSM	CX-NSZ300
S	TAPE DECK	Q	0309	87-A30-075-080	0E	C-TR, 2SA1235F	LHSM	CX-NSZ300
S	TAPE DECK	Q	0309	87-A30-075-080	0E	C-TR, 2SA1235F	USM	CX-SNAJ300
S	TAPE DECK	Q	0309	87-A30-075-080	0E	C-TR, 2SA1235F	USM	CX-SNAJ305
S	TAPE DECK	Q	0310	87-A30-075-080		C-TR, 2SA1235F	LHSM	CX-NSZ300
S	TAPE DECK	Q	0310	87-A30-075-080		C-TR, 2SA1235F	USM	CX-SNAJ300
S	TAPE DECK	Q	0310	87-A30-075-080		C-TR, 2SA1235F	USM	CX-SNAJ305
S	TAPE DECK	Q	0310	87-A30-075-080		C-TR, 2SA1235F	EZSM	CX-NSZ300
S	TAPE DECK	Q	0310	87-A30-075-080	0E	C-TR, 2SA1235F	LHSM	CX-NSZ300
S	TAPE DECK	Q	0310	87-A30-075-080	0E	C-TR, 2SA1235F	USM	CX-SNAJ300
S	TAPE DECK	Q	0310	87-A30-075-080	0E	C-TR, 2SA1235F	USM	CX-SNAJ305
S	TAPE DECK	Q	0443	87-A30-075-080		C-TR, 2SA1235F	LHSM	CX-NSZ300
S	TAPE DECK	Q	0443	87-A30-075-080		C-TR, 2SA1235F	USM	CX-SNAJ300
S	TAPE DECK	Q	0443	87-A30-075-080		C-TR, 2SA1235F	USM	CX-SNAJ305
S	TAPE DECK	Q	0443	87-A30-075-080	0E	C-TR, 2SA1235F	EZSM	CX-NSZ300
S	TAPE DECK	Q	0443	87-A30-075-080	0E	C-TR, 2SA1235F	LHSM	CX-NSZ300
S	TAPE DECK	Q	0443	87-A30-075-080	0E	C-TR, 2SA1235F	USM	CX-SNAJ300
S	TAPE DECK	Q	0443	87-A30-075-080	0E	C-TR, 2SA1235F	USM	CX-SNAJ305
S	TAPE DECK	Q	0444	87-A30-075-080		C-TR, 2SA1235F	LHSM	CX-NSZ300
S	TAPE DECK	Q	0444	87-A30-075-080		C-TR, 2SA1235F	USM	CX-SNAJ300
S	TAPE DECK	Q	0444	87-A30-075-080		C-TR, 2SA1235F	USM	CX-SNAJ305
S	TAPE DECK	Q	0444	87-A30-075-080		C-TR, 2SA1235F	EZSM	CX-NSZ300
S	TAPE DECK	Q	0444	87-A30-075-080	0E	C-TR, 2SA1235F	LHSM	CX-NSZ300

PARTS LIST

! = Δ SAFTY PARTS
 C = Components marked

All components used on this model at the production line are shown in this service manual.

However, please note that not all components will be available as spare parts for after-sales service.

Components marked S and O are designated as spare parts for service and will be stocked at the spare parts centers.

Components marked X and R are not designated as spare parts for after sales service, and will not be stocked at the spare parts centers.

K NO. = Only use japanese.

! C	UNIT NAME	REF NO.	PARTS CODE	K NO.	DESCRIPTION	SUFFIX	MODEL NAME
S	TAPE DECK	Q	0444 87-A30-075-080	OE	C-TR,2SA1235F	USM	CX-SNAJ300
S	TAPE DECK	Q	0444 87-A30-075-080	OE	C-TR,2SA1235F	USM	CX-SNAJ305
S	TAPE DECK	Q	0451 87-A30-495-080		TR,2SA1981Y	LHSM	CX-NSZ300
S	TAPE DECK	Q	0451 87-A30-495-080		TR,2SA1981Y	USM	CX-SNAJ300
S	TAPE DECK	Q	0451 87-A30-495-080		TR,2SA1981Y	USM	CX-SNAJ305
S	TAPE DECK	Q	0451 87-A30-495-080		TR,2SA1981Y	EZSM	CX-NSZ300
S	TAPE DECK	Q	0451 87-A30-495-080	OE	TR,2SA1981Y	LHSM	CX-NSZ300
S	TAPE DECK	Q	0451 87-A30-495-080	OE	TR,2SA1981Y	USM	CX-SNAJ300
S	TAPE DECK	Q	0451 87-A30-495-080	OE	TR,2SA1981Y	USM	CX-SNAJ305
S	TAPE DECK	Q	0453 87-A30-492-080		TR,2SC5343G	LHSM	CX-NSZ300
S	TAPE DECK	Q	0453 87-A30-492-080		TR,2SC5343G	USM	CX-SNAJ300
S	TAPE DECK	Q	0453 87-A30-492-080		TR,2SC5343G	USM	CX-SNAJ305
S	TAPE DECK	Q	0453 87-A30-615-080		TR,STC250	EZSM	CX-NSZ300
S	TAPE DECK	Q	0453 87-A30-615-080	OE	TR,STC250	LHSM	CX-NSZ300
S	TAPE DECK	Q	0453 87-A30-615-080	OE	TR,STC250	USM	CX-SNAJ300
S	TAPE DECK	Q	0453 87-A30-615-080	OE	TR,STC250	USM	CX-SNAJ305
S	TAPE DECK	Q	0454 87-A30-492-080		TR,2SC5343G	LHSM	CX-NSZ300
S	TAPE DECK	Q	0454 87-A30-492-080		TR,2SC5343G	USM	CX-SNAJ300
S	TAPE DECK	Q	0454 87-A30-492-080		TR,2SC5343G	USM	CX-SNAJ305
S	TAPE DECK	Q	0454 87-A30-615-080		TR,STC250	EZSM	CX-NSZ300
S	TAPE DECK	Q	0454 87-A30-615-080	OE	TR,STC250	LHSM	CX-NSZ300
S	TAPE DECK	Q	0454 87-A30-615-080	OE	TR,STC250	USM	CX-SNAJ300
S	TAPE DECK	Q	0454 87-A30-615-080	OE	TR,STC250	USM	CX-SNAJ305
S	TAPE DECK	Q	0455 87-A30-076-080		C-TR,2SC3052F	EZSM	CX-NSZ300
X	TAPE DECK	R	0301 88-108-393-080		C-RES,U 39K-1/16W J	LHSM	CX-NSZ300
X	TAPE DECK	R	0301 88-108-393-080		C-RES,U 39K-1/16W J	USM	CX-SNAJ300
X	TAPE DECK	R	0301 88-108-393-080		C-RES,U 39K-1/16W J	USM	CX-SNAJ305
X	TAPE DECK	R	0301 88-108-393-080		C-RES,U 39K-1/16W J	EZSM	CX-NSZ300
X	TAPE DECK	R	0301 88-108-393-080	OE	C-RES,U 39K-1/16W J	USM	CX-SNAJ300
X	TAPE DECK	R	0301 88-108-393-080	OE	C-RES,U 39K-1/16W J	USM	CX-SNAJ305
X	TAPE DECK	R	0302 88-108-393-080		C-RES,U 39K-1/16W J	LHSM	CX-NSZ300
X	TAPE DECK	R	0302 88-108-393-080		C-RES,U 39K-1/16W J	USM	CX-SNAJ300
X	TAPE DECK	R	0302 88-108-393-080		C-RES,U 39K-1/16W J	USM	CX-SNAJ305
X	TAPE DECK	R	0302 88-108-393-080		C-RES,U 39K-1/16W J	EZSM	CX-NSZ300
X	TAPE DECK	R	0302 88-108-393-080	OE	C-RES,U 39K-1/16W J	USM	CX-SNAJ300
X	TAPE DECK	R	0302 88-108-393-080	OE	C-RES,U 39K-1/16W J	USM	CX-SNAJ305
X	TAPE DECK	R	0303 88-108-823-080		C-RES,U 82K-1/16W J	LHSM	CX-NSZ300
X	TAPE DECK	R	0303 88-108-823-080		C-RES,U 82K-1/16W J	USM	CX-SNAJ300
X	TAPE DECK	R	0303 88-108-823-080		C-RES,U 82K-1/16W J	USM	CX-SNAJ305
X	TAPE DECK	R	0303 88-108-823-080		C-RES,U 82K-1/16W J	EZSM	CX-NSZ300
X	TAPE DECK	R	0303 88-108-823-080	OE	C-RES,U 82K-1/16W J	USM	CX-SNAJ300
X	TAPE DECK	R	0303 88-108-823-080	OE	C-RES,U 82K-1/16W J	USM	CX-SNAJ305
X	TAPE DECK	R	0304 88-108-823-080		C-RES,U 82K-1/16W J	LHSM	CX-NSZ300
X	TAPE DECK	R	0304 88-108-823-080		C-RES,U 82K-1/16W J	USM	CX-SNAJ300
X	TAPE DECK	R	0304 88-108-823-080		C-RES,U 82K-1/16W J	USM	CX-SNAJ305
X	TAPE DECK	R	0304 88-108-823-080		C-RES,U 82K-1/16W J	EZSM	CX-NSZ300
X	TAPE DECK	R	0304 88-108-823-080	OE	C-RES,U 82K-1/16W J	USM	CX-SNAJ300
X	TAPE DECK	R	0304 88-108-823-080	OE	C-RES,U 82K-1/16W J	USM	CX-SNAJ305
X	TAPE DECK	R	0305 88-108-224-080		C-RES,U 220K-1/16W J	LHSM	CX-NSZ300
X	TAPE DECK	R	0305 88-108-224-080		C-RES,U 220K-1/16W J	USM	CX-SNAJ300
X	TAPE DECK	R	0305 88-108-224-080		C-RES,U 220K-1/16W J	EZSM	CX-NSZ300
X	TAPE DECK	R	0305 88-108-224-080	OE	C-RES,U 220K-1/16W J	USM	CX-SNAJ300
X	TAPE DECK	R	0305 88-108-224-080	OE	C-RES,U 220K-1/16W J	USM	CX-SNAJ305
X	TAPE DECK	R	0306 88-108-682-080		C-RES,U 6.8K-1/16W J	LHSM	CX-NSZ300
X	TAPE DECK	R	0306 88-108-682-080		C-RES,U 6.8K-1/16W J	USM	CX-SNAJ300
X	TAPE DECK	R	0306 88-108-682-080		C-RES,U 6.8K-1/16W J	USM	CX-SNAJ305
X	TAPE DECK	R	0306 88-108-682-080		C-RES,U 6.8K-1/16W J	EZSM	CX-NSZ300
X	TAPE DECK	R	0306 88-108-682-080	OE	C-RES,U 6.8K-1/16W J	USM	CX-SNAJ300
X	TAPE DECK	R	0306 88-108-682-080	OE	C-RES,U 6.8K-1/16W J	USM	CX-SNAJ305
X	TAPE DECK	R	0307 88-108-471-080		C-RES,U 470-1/16W J	LHSM	CX-NSZ300
X	TAPE DECK	R	0307 88-108-471-080		C-RES,U 470-1/16W J	USM	CX-SNAJ300
X	TAPE DECK	R	0307 88-108-471-080		C-RES,U 470-1/16W J	USM	CX-SNAJ305
X	TAPE DECK	R	0307 88-108-471-080		C-RES,U 470-1/16W J	EZSM	CX-NSZ300
X	TAPE DECK	R	0307 88-108-471-080	OE	C-RES,U 470-1/16W J	USM	CX-SNAJ300
X	TAPE DECK	R	0307 88-108-471-080	OE	C-RES,U 470-1/16W J	USM	CX-SNAJ305
X	TAPE DECK	R	0308 88-108-471-080		C-RES,U 470-1/16W J	LHSM	CX-NSZ300
X	TAPE DECK	R	0308 88-108-471-080		C-RES,U 470-1/16W J	USM	CX-SNAJ300
X	TAPE DECK	R	0308 88-108-471-080		C-RES,U 470-1/16W J	USM	CX-SNAJ305
X	TAPE DECK	R	0308 88-108-471-080		C-RES,U 470-1/16W J	EZSM	CX-NSZ300

PARTS LIST

! = Δ SAFTY PARTS
 C = Components marked

All components used on this model at the production line are shown in this service manual.

However, please note that not all components will be available as spare parts for after-sales service.

Components marked S and O are designated as spare parts for service and will be stocked at the spare parts centers.

Components marked X and R are not designated as spare parts for after sales service, and will not be stocked at the spare parts centers.

K NO. = Only use japanese.

! C	UNIT NAME	REF NO.	PARTS CODE	K NO.	DESCRIPTION	SUFFIX	MODEL NAME
X	TAPE DECK	R	0308 88-108-471-080		C-RES,U 470-1/16W J	USM	CX-SNAJ300
X	TAPE DECK	R	0308 88-108-471-080	OE	C-RES,U 470-1/16W J	USM	CX-SNAJ305
X	TAPE DECK	R	0309 88-108-680-080		C-RES,U 68-1/16W J	LHSM	CX-NSZ300
X	TAPE DECK	R	0309 88-108-680-080		C-RES,U 68-1/16W J	USM	CX-SNAJ300
X	TAPE DECK	R	0309 88-108-680-080		C-RES,U 68-1/16W J	USM	CX-SNAJ305
X	TAPE DECK	R	0309 88-108-680-080		C-RES,U 68-1/16W J	EZSM	CX-NSZ300
X	TAPE DECK	R	0309 88-108-680-080	OE	C-RES,U 68-1/16W J	USM	CX-SNAJ300
X	TAPE DECK	R	0309 88-108-680-080	OE	C-RES,U 68-1/16W J	USM	CX-SNAJ305
X	TAPE DECK	R	0310 88-108-680-080		C-RES,U 68-1/16W J	LHSM	CX-NSZ300
X	TAPE DECK	R	0310 88-108-680-080		C-RES,U 68-1/16W J	USM	CX-SNAJ300
X	TAPE DECK	R	0310 88-108-680-080		C-RES,U 68-1/16W J	USM	CX-SNAJ305
X	TAPE DECK	R	0310 88-108-680-080		C-RES,U 68-1/16W J	EZSM	CX-NSZ300
X	TAPE DECK	R	0310 88-108-680-080	OE	C-RES,U 68-1/16W J	USM	CX-SNAJ300
X	TAPE DECK	R	0310 88-108-680-080	OE	C-RES,U 68-1/16W J	USM	CX-SNAJ305
X	TAPE DECK	R	0313 88-108-183-080		C-RES,U 18K-1/16W J	LHSM	CX-NSZ300
X	TAPE DECK	R	0313 88-108-183-080		C-RES,U 18K-1/16W J	USM	CX-SNAJ300
X	TAPE DECK	R	0313 88-108-183-080		C-RES,U 18K-1/16W J	USM	CX-SNAJ305
X	TAPE DECK	R	0313 88-108-183-080		C-RES,U 18K-1/16W J	EZSM	CX-NSZ300
X	TAPE DECK	R	0313 88-108-183-080	OE	C-RES,U 18K-1/16W J	USM	CX-SNAJ300
X	TAPE DECK	R	0313 88-108-183-080	OE	C-RES,U 18K-1/16W J	USM	CX-SNAJ305
X	TAPE DECK	R	0314 88-108-183-080		C-RES,U 18K-1/16W J	LHSM	CX-NSZ300
X	TAPE DECK	R	0314 88-108-183-080		C-RES,U 18K-1/16W J	USM	CX-SNAJ300
X	TAPE DECK	R	0314 88-108-183-080		C-RES,U 18K-1/16W J	USM	CX-SNAJ305
X	TAPE DECK	R	0314 88-108-183-080		C-RES,U 18K-1/16W J	EZSM	CX-NSZ300
X	TAPE DECK	R	0314 88-108-183-080	OE	C-RES,U 18K-1/16W J	USM	CX-SNAJ300
X	TAPE DECK	R	0314 88-108-183-080	OE	C-RES,U 18K-1/16W J	USM	CX-SNAJ305
X	TAPE DECK	R	0315 88-108-394-080		C-RES,U 390K-1/16W J	LHSM	CX-NSZ300
X	TAPE DECK	R	0315 88-108-394-080		C-RES,U 390K-1/16W J	USM	CX-SNAJ300
X	TAPE DECK	R	0315 88-108-394-080		C-RES,U 390K-1/16W J	USM	CX-SNAJ305
X	TAPE DECK	R	0315 88-108-394-080		C-RES,U 390K-1/16W J	EZSM	CX-NSZ300
X	TAPE DECK	R	0315 88-108-394-080	OE	C-RES,U 390K-1/16W J	USM	CX-SNAJ300
X	TAPE DECK	R	0315 88-108-394-080	OE	C-RES,U 390K-1/16W J	USM	CX-SNAJ305
X	TAPE DECK	R	0316 88-108-394-080		C-RES,U 390K-1/16W J	LHSM	CX-NSZ300
X	TAPE DECK	R	0316 88-108-394-080		C-RES,U 390K-1/16W J	USM	CX-SNAJ300
X	TAPE DECK	R	0316 88-108-394-080		C-RES,U 390K-1/16W J	USM	CX-SNAJ305
X	TAPE DECK	R	0316 88-108-394-080		C-RES,U 390K-1/16W J	EZSM	CX-NSZ300
X	TAPE DECK	R	0316 88-108-394-080	OE	C-RES,U 390K-1/16W J	USM	CX-SNAJ300
X	TAPE DECK	R	0316 88-108-394-080	OE	C-RES,U 390K-1/16W J	USM	CX-SNAJ305
X	TAPE DECK	R	0317 88-108-122-080		C-RES,U 1.2K-1/16W J	LHSM	CX-NSZ300
X	TAPE DECK	R	0317 88-108-122-080		C-RES,U 1.2K-1/16W J	USM	CX-SNAJ300
X	TAPE DECK	R	0317 88-108-122-080		C-RES,U 1.2K-1/16W J	USM	CX-SNAJ305
X	TAPE DECK	R	0317 88-108-122-080		C-RES,U 1.2K-1/16W J	EZSM	CX-NSZ300
X	TAPE DECK	R	0317 88-108-122-080	OE	C-RES,U 1.2K-1/16W J	LHSM	CX-NSZ300
X	TAPE DECK	R	0317 88-108-122-080	OE	C-RES,U 1.2K-1/16W J	USM	CX-SNAJ300
X	TAPE DECK	R	0318 88-108-122-080		C-RES,U 1.2K-1/16W J	LHSM	CX-NSZ300
X	TAPE DECK	R	0318 88-108-122-080		C-RES,U 1.2K-1/16W J	USM	CX-SNAJ300
X	TAPE DECK	R	0318 88-108-122-080		C-RES,U 1.2K-1/16W J	USM	CX-SNAJ305
X	TAPE DECK	R	0318 88-108-122-080		C-RES,U 1.2K-1/16W J	EZSM	CX-NSZ300
X	TAPE DECK	R	0318 88-108-122-080	OE	C-RES,U 1.2K-1/16W J	USM	CX-SNAJ300
X	TAPE DECK	R	0318 88-108-122-080	OE	C-RES,U 1.2K-1/16W J	USM	CX-SNAJ305
X	TAPE DECK	R	0319 88-108-472-080		C-RES,U 4.7K-1/16W J	LHSM	CX-NSZ300
X	TAPE DECK	R	0319 88-108-472-080		C-RES,U 4.7K-1/16W J	USM	CX-SNAJ300
X	TAPE DECK	R	0319 88-108-472-080		C-RES,U 4.7K-1/16W J	USM	CX-SNAJ305
X	TAPE DECK	R	0319 88-108-472-080		C-RES,U 4.7K-1/16W J	EZSM	CX-NSZ300
X	TAPE DECK	R	0319 88-108-472-080	OE	C-RES,U 4.7K-1/16W J	USM	CX-SNAJ300
X	TAPE DECK	R	0319 88-108-472-080	OE	C-RES,U 4.7K-1/16W J	USM	CX-SNAJ305
X	TAPE DECK	R	0321 88-108-000-080		C-JUMPER,U	LHSM	CX-NSZ300
X	TAPE DECK	R	0321 88-108-000-080		C-JUMPER,U	USM	CX-SNAJ300
X	TAPE DECK	R	0321 88-108-000-080		C-JUMPER,U	USM	CX-SNAJ305
X	TAPE DECK	R	0321 88-108-000-080	OE	C-JUMPER,U	USM	CX-SNAJ300
X	TAPE DECK	R	0322 88-108-000-080		C-JUMPER,U	LHSM	CX-NSZ300
X	TAPE DECK	R	0322 88-108-000-080		C-JUMPER,U	USM	CX-SNAJ300
X	TAPE DECK	R	0322 88-108-000-080		C-JUMPER,U	USM	CX-SNAJ305
X	TAPE DECK	R	0322 88-108-000-080		C-JUMPER,U	EZSM	CX-NSZ300
X	TAPE DECK	R	0322 88-108-000-080	OE	C-JUMPER,U	LHSM	CX-NSZ300
X	TAPE DECK	R	0322 88-108-000-080	OE	C-JUMPER,U	USM	CX-SNAJ300

PARTS LIST

! = Δ SAFTY PARTS
 C = Components marked

All components used on this model at the production line are shown in this service manual.

However, please note that not all components will be available as spare parts for after-sales service.

Components marked S and O are designated as spare parts for service and will be stocked at the spare parts centers.

Components marked X and R are not designated as spare parts for after sales service, and will not be stocked at the spare parts centers.

K NO. = Only use japanese.

! C	UNIT NAME	REF NO.	PARTS CODE	K NO.	DESCRIPTION	SUFFIX	MODEL NAME	
X	TAPE DECK	R	0322	88-108-000-080	OE	C-JUMPER,U	USM	CX-SNAJ305
X	TAPE DECK	R	0375	88-108-102-080		C-RES,U 1K-1/16W J	LHSM	CX-NSZ300
X	TAPE DECK	R	0375	88-108-102-080		C-RES,U 1K-1/16W J	USM	CX-SNAJ300
X	TAPE DECK	R	0375	88-108-102-080		C-RES,U 1K-1/16W J	USM	CX-SNAJ305
X	TAPE DECK	R	0375	88-108-102-080		C-RES,U 1K-1/16W J	EZSM	CX-NSZ300
X	TAPE DECK	R	0375	88-108-102-080	OE	C-RES,U 1K-1/16W J	LHSM	CX-NSZ300
X	TAPE DECK	R	0375	88-108-102-080	OE	C-RES,U 1K-1/16W J	USM	CX-SNAJ300
X	TAPE DECK	R	0375	88-108-102-080	OE	C-RES,U 1K-1/16W J	USM	CX-SNAJ305
X	TAPE DECK	R	0376	88-108-102-080		C-RES,U 1K-1/16W J	LHSM	CX-NSZ300
X	TAPE DECK	R	0376	88-108-102-080		C-RES,U 1K-1/16W J	USM	CX-SNAJ300
X	TAPE DECK	R	0376	88-108-102-080		C-RES,U 1K-1/16W J	USM	CX-SNAJ305
X	TAPE DECK	R	0376	88-108-102-080		C-RES,U 1K-1/16W J	EZSM	CX-NSZ300
X	TAPE DECK	R	0376	88-108-102-080	OE	C-RES,U 1K-1/16W J	LHSM	CX-NSZ300
X	TAPE DECK	R	0376	88-108-102-080	OE	C-RES,U 1K-1/16W J	USM	CX-SNAJ300
X	TAPE DECK	R	0376	88-108-102-080	OE	C-RES,U 1K-1/16W J	USM	CX-SNAJ305
X	TAPE DECK	R	0376	88-108-102-080	OE	C-RES,U 1K-1/16W J	LHSM	CX-NSZ300
X	TAPE DECK	R	0377	88-121-101-080		RES,100-1/8W J	USM	CX-SNAJ300
X	TAPE DECK	R	0377	88-121-101-080		RES,100-1/8W J	USM	CX-SNAJ305
X	TAPE DECK	R	0377	88-121-101-080		RES,100-1/8W J	EZSM	CX-NSZ300
X	TAPE DECK	R	0377	88-121-101-080	OE	RES,100-1/8W J	USM	CX-SNAJ300
X	TAPE DECK	R	0377	88-121-101-080	OE	RES,100-1/8W J	USM	CX-SNAJ305
X	TAPE DECK	R	0399	88-108-105-080		C-RES,U 1M-1/16W J	LHSM	CX-NSZ300
X	TAPE DECK	R	0399	88-108-105-080		C-RES,U 1M-1/16W J	USM	CX-SNAJ300
X	TAPE DECK	R	0399	88-108-105-080		C-RES,U 1M-1/16W J	USM	CX-SNAJ305
X	TAPE DECK	R	0399	88-108-105-080		C-RES,U 1M-1/16W J	EZSM	CX-NSZ300
X	TAPE DECK	R	0399	88-108-105-080	OE	C-RES,U 1M-1/16W J	LHSM	CX-NSZ300
X	TAPE DECK	R	0399	88-108-105-080	OE	C-RES,U 1M-1/16W J	USM	CX-SNAJ300
X	TAPE DECK	R	0399	88-108-105-080	OE	C-RES,U 1M-1/16W J	USM	CX-SNAJ305
X	TAPE DECK	R	0401	88-108-104-080		C-RES,U 100K-1/16W J	LHSM	CX-NSZ300
X	TAPE DECK	R	0401	88-108-104-080		C-RES,U 100K-1/16W J	USM	CX-SNAJ300
X	TAPE DECK	R	0401	88-108-104-080		C-RES,U 100K-1/16W J	USM	CX-SNAJ305
X	TAPE DECK	R	0401	88-108-104-080		C-RES,U 100K-1/16W J	EZSM	CX-NSZ300
X	TAPE DECK	R	0401	88-108-104-080	OE	C-RES,U 100K-1/16W J	LHSM	CX-NSZ300
X	TAPE DECK	R	0401	88-108-104-080	OE	C-RES,U 100K-1/16W J	USM	CX-SNAJ300
X	TAPE DECK	R	0401	88-108-104-080	OE	C-RES,U 100K-1/16W J	USM	CX-SNAJ305
X	TAPE DECK	R	0402	88-108-104-080		C-RES,U 100K-1/16W J	LHSM	CX-NSZ300
X	TAPE DECK	R	0402	88-108-104-080		C-RES,U 100K-1/16W J	USM	CX-SNAJ300
X	TAPE DECK	R	0402	88-108-104-080		C-RES,U 100K-1/16W J	USM	CX-SNAJ305
X	TAPE DECK	R	0402	88-108-104-080		C-RES,U 100K-1/16W J	EZSM	CX-NSZ300
X	TAPE DECK	R	0402	88-108-104-080	OE	C-RES,U 100K-1/16W J	LHSM	CX-NSZ300
X	TAPE DECK	R	0402	88-108-104-080	OE	C-RES,U 100K-1/16W J	USM	CX-SNAJ300
X	TAPE DECK	R	0402	88-108-104-080	OE	C-RES,U 100K-1/16W J	USM	CX-SNAJ305
X	TAPE DECK	R	0403	88-108-102-080		C-RES,U 1K-1/16W J	LHSM	CX-NSZ300
X	TAPE DECK	R	0403	88-108-102-080		C-RES,U 1K-1/16W J	USM	CX-SNAJ300
X	TAPE DECK	R	0403	88-108-102-080		C-RES,U 1K-1/16W J	USM	CX-SNAJ305
X	TAPE DECK	R	0403	88-108-102-080		C-RES,U 1K-1/16W J	EZSM	CX-NSZ300
X	TAPE DECK	R	0403	88-108-102-080	OE	C-RES,U 1K-1/16W J	LHSM	CX-NSZ300
X	TAPE DECK	R	0403	88-108-102-080	OE	C-RES,U 1K-1/16W J	USM	CX-SNAJ300
X	TAPE DECK	R	0403	88-108-102-080	OE	C-RES,U 1K-1/16W J	USM	CX-SNAJ305
X	TAPE DECK	R	0404	88-108-102-080		C-RES,U 1K-1/16W J	LHSM	CX-NSZ300
X	TAPE DECK	R	0404	88-108-102-080		C-RES,U 1K-1/16W J	USM	CX-SNAJ300
X	TAPE DECK	R	0404	88-108-102-080		C-RES,U 1K-1/16W J	USM	CX-SNAJ305
X	TAPE DECK	R	0404	88-108-102-080		C-RES,U 1K-1/16W J	EZSM	CX-NSZ300
X	TAPE DECK	R	0404	88-108-102-080	OE	C-RES,U 1K-1/16W J	LHSM	CX-NSZ300
X	TAPE DECK	R	0404	88-108-102-080	OE	C-RES,U 1K-1/16W J	USM	CX-SNAJ300
X	TAPE DECK	R	0404	88-108-102-080	OE	C-RES,U 1K-1/16W J	USM	CX-SNAJ305
X	TAPE DECK	R	0405	88-108-823-080		C-RES,U 82K-1/16W J	LHSM	CX-NSZ300
X	TAPE DECK	R	0405	88-108-823-080		C-RES,U 82K-1/16W J	USM	CX-SNAJ300
X	TAPE DECK	R	0405	88-108-823-080		C-RES,U 82K-1/16W J	USM	CX-SNAJ305
X	TAPE DECK	R	0405	88-108-823-080		C-RES,U 82K-1/16W J	EZSM	CX-NSZ300
X	TAPE DECK	R	0405	88-108-823-080	OE	C-RES,U 82K-1/16W J	LHSM	CX-NSZ300
X	TAPE DECK	R	0405	88-108-823-080	OE	C-RES,U 82K-1/16W J	USM	CX-SNAJ300
X	TAPE DECK	R	0405	88-108-823-080	OE	C-RES,U 82K-1/16W J	USM	CX-SNAJ305
X	TAPE DECK	R	0406	88-108-823-080		C-RES,U 82K-1/16W J	LHSM	CX-NSZ300
X	TAPE DECK	R	0406	88-108-823-080		C-RES,U 82K-1/16W J	USM	CX-SNAJ300
X	TAPE DECK	R	0406	88-108-823-080		C-RES,U 82K-1/16W J	USM	CX-SNAJ305
X	TAPE DECK	R	0406	88-108-823-080		C-RES,U 82K-1/16W J	EZSM	CX-NSZ300
X	TAPE DECK	R	0406	88-108-823-080	OE	C-RES,U 82K-1/16W J	USM	CX-SNAJ300
X	TAPE DECK	R	0406	88-108-823-080	OE	C-RES,U 82K-1/16W J	USM	CX-SNAJ305
X	TAPE DECK	R	0407	88-108-102-080		C-RES,U 1K-1/16W J	LHSM	CX-NSZ300
X	TAPE DECK	R	0407	88-108-102-080		C-RES,U 1K-1/16W J	USM	CX-SNAJ300

PARTS LIST

! = Δ SAFTY PARTS
 C = Components marked

All components used on this model at the production line are shown in this service manual.

However, please note that not all components will be available as spare parts for after-sales service.

Components marked S and O are designated as spare parts for service and will be stocked at the spare parts centers.

Components marked X and R are not designated as spare parts for after sales service, and will not be stocked at the spare parts centers.

K NO. = Only use japanese.

! C	UNIT NAME	REF NO.	PARTS CODE	K NO.	DESCRIPTION	SUFFIX	MODEL NAME
X	TAPE DECK	R	0407 88-108-102-080		C-RES,U 1K-1/16W J	USM	CX-SNAJ305
X	TAPE DECK	R	0407 88-108-102-080		C-RES,U 1K-1/16W J	EZSM	CX-NSZ300
X	TAPE DECK	R	0407 88-108-102-080	OE	C-RES,U 1K-1/16W J	LHSM	CX-NSZ300
X	TAPE DECK	R	0407 88-108-102-080	OE	C-RES,U 1K-1/16W J	USM	CX-SNAJ300
X	TAPE DECK	R	0407 88-108-102-080	OE	C-RES,U 1K-1/16W J	USM	CX-SNAJ305
X	TAPE DECK	R	0408 88-108-102-080		C-RES,U 1K-1/16W J	LHSM	CX-NSZ300
X	TAPE DECK	R	0408 88-108-102-080		C-RES,U 1K-1/16W J	USM	CX-SNAJ300
X	TAPE DECK	R	0408 88-108-102-080		C-RES,U 1K-1/16W J	USM	CX-SNAJ305
X	TAPE DECK	R	0408 88-108-102-080		C-RES,U 1K-1/16W J	EZSM	CX-NSZ300
X	TAPE DECK	R	0408 88-108-102-080	OE	C-RES,U 1K-1/16W J	LHSM	CX-NSZ300
X	TAPE DECK	R	0408 88-108-102-080	OE	C-RES,U 1K-1/16W J	USM	CX-SNAJ300
X	TAPE DECK	R	0408 88-108-102-080	OE	C-RES,U 1K-1/16W J	USM	CX-SNAJ305
X	TAPE DECK	R	0409 88-108-122-080		C-RES,U 1.2K-1/16W J	LHSM	CX-NSZ300
X	TAPE DECK	R	0409 88-108-122-080		C-RES,U 1.2K-1/16W J	USM	CX-SNAJ300
X	TAPE DECK	R	0409 88-108-122-080		C-RES,U 1.2K-1/16W J	USM	CX-SNAJ305
X	TAPE DECK	R	0409 88-108-122-080		C-RES,U 1.2K-1/16W J	EZSM	CX-NSZ300
X	TAPE DECK	R	0409 88-108-122-080	OE	C-RES,U 1.2K-1/16W J	USM	CX-SNAJ300
X	TAPE DECK	R	0409 88-108-122-080	OE	C-RES,U 1.2K-1/16W J	USM	CX-SNAJ305
X	TAPE DECK	R	0410 88-108-122-080		C-RES,U 1.2K-1/16W J	LHSM	CX-NSZ300
X	TAPE DECK	R	0410 88-108-122-080		C-RES,U 1.2K-1/16W J	USM	CX-SNAJ300
X	TAPE DECK	R	0410 88-108-122-080		C-RES,U 1.2K-1/16W J	USM	CX-SNAJ305
X	TAPE DECK	R	0410 88-108-122-080		C-RES,U 1.2K-1/16W J	EZSM	CX-NSZ300
X	TAPE DECK	R	0410 88-108-122-080	OE	C-RES,U 1.2K-1/16W J	USM	CX-SNAJ300
X	TAPE DECK	R	0410 88-108-122-080	OE	C-RES,U 1.2K-1/16W J	USM	CX-SNAJ305
X	TAPE DECK	R	0411 88-108-153-080		C-RES,U 15K-1/16W J	LHSM	CX-NSZ300
X	TAPE DECK	R	0411 88-108-153-080		C-RES,U 15K-1/16W J	USM	CX-SNAJ300
X	TAPE DECK	R	0411 88-108-153-080		C-RES,U 15K-1/16W J	USM	CX-SNAJ305
X	TAPE DECK	R	0411 88-108-153-080		C-RES,U 15K-1/16W J	EZSM	CX-NSZ300
X	TAPE DECK	R	0411 88-108-153-080	OE	C-RES,U 15K-1/16W J	USM	CX-SNAJ300
X	TAPE DECK	R	0411 88-108-153-080	OE	C-RES,U 15K-1/16W J	USM	CX-SNAJ305
X	TAPE DECK	R	0412 88-108-153-080		C-RES,U 15K-1/16W J	LHSM	CX-NSZ300
X	TAPE DECK	R	0412 88-108-153-080		C-RES,U 15K-1/16W J	USM	CX-SNAJ300
X	TAPE DECK	R	0412 88-108-153-080		C-RES,U 15K-1/16W J	USM	CX-SNAJ305
X	TAPE DECK	R	0412 88-108-153-080		C-RES,U 15K-1/16W J	EZSM	CX-NSZ300
X	TAPE DECK	R	0412 88-108-153-080	OE	C-RES,U 15K-1/16W J	USM	CX-SNAJ300
X	TAPE DECK	R	0412 88-108-153-080	OE	C-RES,U 15K-1/16W J	USM	CX-SNAJ305
X	TAPE DECK	R	0413 88-108-222-080		C-RES,U 2.2K-1/16W J	LHSM	CX-NSZ300
X	TAPE DECK	R	0413 88-108-222-080		C-RES,U 2.2K-1/16W J	USM	CX-SNAJ300
X	TAPE DECK	R	0413 88-108-222-080		C-RES,U 2.2K-1/16W J	USM	CX-SNAJ305
X	TAPE DECK	R	0413 88-108-222-080		C-RES,U 2.2K-1/16W J	EZSM	CX-NSZ300
X	TAPE DECK	R	0413 88-108-222-080	OE	C-RES,U 2.2K-1/16W J	USM	CX-SNAJ300
X	TAPE DECK	R	0413 88-108-222-080	OE	C-RES,U 2.2K-1/16W J	USM	CX-SNAJ305
X	TAPE DECK	R	0414 88-108-222-080		C-RES,U 2.2K-1/16W J	LHSM	CX-NSZ300
X	TAPE DECK	R	0414 88-108-222-080		C-RES,U 2.2K-1/16W J	USM	CX-SNAJ300
X	TAPE DECK	R	0414 88-108-222-080		C-RES,U 2.2K-1/16W J	USM	CX-SNAJ305
X	TAPE DECK	R	0414 88-108-222-080		C-RES,U 2.2K-1/16W J	EZSM	CX-NSZ300
X	TAPE DECK	R	0414 88-108-222-080	OE	C-RES,U 2.2K-1/16W J	USM	CX-SNAJ300
X	TAPE DECK	R	0414 88-108-222-080	OE	C-RES,U 2.2K-1/16W J	USM	CX-SNAJ305
X	TAPE DECK	R	0415 88-108-681-080		C-RES,U 680-1/16W J	LHSM	CX-NSZ300
X	TAPE DECK	R	0415 88-108-681-080		C-RES,U 680-1/16W J	USM	CX-SNAJ300
X	TAPE DECK	R	0415 88-108-681-080		C-RES,U 680-1/16W J	USM	CX-SNAJ305
X	TAPE DECK	R	0415 88-108-681-080	OE	C-RES,U 680-1/16W J	LHSM	CX-NSZ300
X	TAPE DECK	R	0415 88-108-681-080	OE	C-RES,U 680-1/16W J	USM	CX-SNAJ300
X	TAPE DECK	R	0416 88-108-681-080		C-RES,U 680-1/16W J	LHSM	CX-NSZ300
X	TAPE DECK	R	0416 88-108-681-080		C-RES,U 680-1/16W J	USM	CX-SNAJ300
X	TAPE DECK	R	0416 88-108-681-080		C-RES,U 680-1/16W J	USM	CX-SNAJ305
X	TAPE DECK	R	0416 88-108-681-080		C-RES,U 680-1/16W J	EZSM	CX-NSZ300
X	TAPE DECK	R	0416 88-108-681-080	OE	C-RES,U 680-1/16W J	USM	CX-SNAJ300
X	TAPE DECK	R	0416 88-108-681-080	OE	C-RES,U 680-1/16W J	USM	CX-SNAJ305
X	TAPE DECK	R	0417 88-108-103-080		C-RES,U 10K-1/16W J	LHSM	CX-NSZ300
X	TAPE DECK	R	0417 88-108-103-080		C-RES,U 10K-1/16W J	USM	CX-SNAJ300
X	TAPE DECK	R	0417 88-108-103-080		C-RES,U 10K-1/16W J	USM	CX-SNAJ305
X	TAPE DECK	R	0417 88-108-103-080		C-RES,U 10K-1/16W J	EZSM	CX-NSZ300
X	TAPE DECK	R	0417 88-108-103-080	OE	C-RES,U 10K-1/16W J	LHSM	CX-NSZ300
X	TAPE DECK	R	0417 88-108-103-080	OE	C-RES,U 10K-1/16W J	USM	CX-SNAJ300
X	TAPE DECK	R	0417 88-108-103-080	OE	C-RES,U 10K-1/16W J	USM	CX-SNAJ305
X	TAPE DECK	R	0418 88-108-103-080		C-RES,U 10K-1/16W J	LHSM	CX-NSZ300
X	TAPE DECK	R	0418 88-108-103-080		C-RES,U 10K-1/16W J	USM	CX-SNAJ300
X	TAPE DECK	R	0418 88-108-103-080		C-RES,U 10K-1/16W J	USM	CX-SNAJ305

PARTS LIST

! = Δ SAFTY PARTS
 C = Components marked

All components used on this model at the production line are shown in this service manual.

However, please note that not all components will be available as spare parts for after-sales service.

Components marked S and O are designated as spare parts for service and will be stocked at the spare parts centers.

Components marked X and R are not designated as spare parts for after sales service, and will not be stocked at the spare parts centers.

K NO. = Only use japanese.

! C	UNIT NAME	REF NO.	PARTS CODE	K NO.	DESCRIPTION	SUFFIX	MODEL NAME
X	TAPE DECK	R	0418 88-108-103-080		C-RES,U 10K-1/16W J	EZSM	CX-NSZ300
X	TAPE DECK	R	0418 88-108-103-080	OE	C-RES,U 10K-1/16W J	LHSM	CX-NSZ300
X	TAPE DECK	R	0418 88-108-103-080	OE	C-RES,U 10K-1/16W J	USM	CX-SNAJ300
X	TAPE DECK	R	0418 88-108-103-080	OE	C-RES,U 10K-1/16W J	USM	CX-SNAJ305
X	TAPE DECK	R	0419 88-108-222-080		C-RES,U 2.2K-1/16W J	LHSM	CX-NSZ300
X	TAPE DECK	R	0419 88-108-222-080		C-RES,U 2.2K-1/16W J	USM	CX-SNAJ300
X	TAPE DECK	R	0419 88-108-222-080		C-RES,U 2.2K-1/16W J	USM	CX-SNAJ305
X	TAPE DECK	R	0419 88-108-222-080		C-RES,U 2.2K-1/16W J	EZSM	CX-NSZ300
X	TAPE DECK	R	0419 88-108-222-080	OE	C-RES,U 2.2K-1/16W J	USM	CX-SNAJ300
X	TAPE DECK	R	0419 88-108-222-080	OE	C-RES,U 2.2K-1/16W J	USM	CX-SNAJ305
X	TAPE DECK	R	0420 88-108-222-080		C-RES,U 2.2K-1/16W J	LHSM	CX-NSZ300
X	TAPE DECK	R	0420 88-108-222-080		C-RES,U 2.2K-1/16W J	USM	CX-SNAJ300
X	TAPE DECK	R	0420 88-108-222-080		C-RES,U 2.2K-1/16W J	USM	CX-SNAJ305
X	TAPE DECK	R	0420 88-108-222-080		C-RES,U 2.2K-1/16W J	EZSM	CX-NSZ300
X	TAPE DECK	R	0420 88-108-222-080	OE	C-RES,U 2.2K-1/16W J	USM	CX-SNAJ300
X	TAPE DECK	R	0420 88-108-222-080	OE	C-RES,U 2.2K-1/16W J	USM	CX-SNAJ305
X	TAPE DECK	R	0421 88-108-223-080		C-RES,U 22K-1/16W J	LHSM	CX-NSZ300
X	TAPE DECK	R	0421 88-108-223-080		C-RES,U 22K-1/16W J	USM	CX-SNAJ300
X	TAPE DECK	R	0421 88-108-223-080		C-RES,U 22K-1/16W J	USM	CX-SNAJ305
X	TAPE DECK	R	0421 88-108-223-080		C-RES,U 22K-1/16W J	EZSM	CX-NSZ300
X	TAPE DECK	R	0421 88-108-223-080	OE	C-RES,U 22K-1/16W J	USM	CX-SNAJ300
X	TAPE DECK	R	0421 88-108-223-080	OE	C-RES,U 22K-1/16W J	USM	CX-SNAJ305
X	TAPE DECK	R	0422 88-108-223-080		C-RES,U 22K-1/16W J	USM	CX-SNAJ300
X	TAPE DECK	R	0422 88-108-223-080	OE	C-RES,U 22K-1/16W J	USM	CX-SNAJ305
X	TAPE DECK	R	0422 88-108-223-080		C-RES,U 22K-1/16W J	LHSM	CX-NSZ300
X	TAPE DECK	R	0422 88-108-223-080		C-RES,U 22K-1/16W J	USM	CX-SNAJ300
X	TAPE DECK	R	0422 88-108-223-080		C-RES,U 22K-1/16W J	USM	CX-SNAJ305
X	TAPE DECK	R	0422 88-108-223-080		C-RES,U 22K-1/16W J	EZSM	CX-NSZ300
X	TAPE DECK	R	0422 88-108-223-080	OE	C-RES,U 22K-1/16W J	USM	CX-SNAJ300
X	TAPE DECK	R	0422 88-108-223-080	OE	C-RES,U 22K-1/16W J	USM	CX-SNAJ305
X	TAPE DECK	R	0423 88-108-183-080		C-RES,U 18K-1/16W J	LHSM	CX-NSZ300
X	TAPE DECK	R	0423 88-108-183-080		C-RES,U 18K-1/16W J	USM	CX-SNAJ300
X	TAPE DECK	R	0423 88-108-183-080		C-RES,U 18K-1/16W J	USM	CX-SNAJ305
X	TAPE DECK	R	0423 88-108-183-080	OE	C-RES,U 18K-1/16W J	USM	CX-SNAJ300
X	TAPE DECK	R	0423 88-108-183-080	OE	C-RES,U 18K-1/16W J	USM	CX-SNAJ305
X	TAPE DECK	R	0424 88-108-183-080		C-RES,U 18K-1/16W J	LHSM	CX-NSZ300
X	TAPE DECK	R	0424 88-108-183-080		C-RES,U 18K-1/16W J	USM	CX-SNAJ300
X	TAPE DECK	R	0424 88-108-183-080		C-RES,U 18K-1/16W J	USM	CX-SNAJ305
X	TAPE DECK	R	0424 88-108-183-080		C-RES,U 18K-1/16W J	EZSM	CX-NSZ300
X	TAPE DECK	R	0424 88-108-183-080	OE	C-RES,U 18K-1/16W J	USM	CX-SNAJ300
X	TAPE DECK	R	0424 88-108-183-080	OE	C-RES,U 18K-1/16W J	USM	CX-SNAJ305
X	TAPE DECK	R	0453 88-118-152-080		C-RES,S 1.5K-1/10W J	LHSM	CX-NSZ300
X	TAPE DECK	R	0453 88-118-152-080		C-RES,S 1.5K-1/10W J	USM	CX-SNAJ300
X	TAPE DECK	R	0453 88-118-152-080		C-RES,S 1.5K-1/10W J	USM	CX-SNAJ305
X	TAPE DECK	R	0453 88-118-152-080		C-RES,S 1.5K-1/10W J	EZSM	CX-NSZ300
X	TAPE DECK	R	0453 88-118-152-080	OE	C-RES,S 1.5K-1/10W J	USM	CX-SNAJ300
X	TAPE DECK	R	0453 88-118-152-080	OE	C-RES,S 1.5K-1/10W J	USM	CX-SNAJ305
X	TAPE DECK	R	0454 88-128-829-080		C-RES, 8.2-1/8W J	LHSM	CX-NSZ300
X	TAPE DECK	R	0454 88-128-829-080		C-RES, 8.2-1/8W J	USM	CX-SNAJ300
X	TAPE DECK	R	0454 88-128-829-080		C-RES, 8.2-1/8W J	USM	CX-SNAJ305
X	TAPE DECK	R	0454 88-128-829-080		C-RES, 8.2-1/8W J	EZSM	CX-NSZ300
X	TAPE DECK	R	0454 88-128-829-080	OE	C-RES, 8.2-1/8W J	USM	CX-SNAJ300
X	TAPE DECK	R	0454 88-128-829-080	OE	C-RES, 8.2-1/8W J	USM	CX-SNAJ305
X	TAPE DECK	R	0455 88-108-183-080		C-RES,U 18K-1/16W J	LHSM	CX-NSZ300
X	TAPE DECK	R	0455 88-108-183-080		C-RES,U 18K-1/16W J	USM	CX-SNAJ300
X	TAPE DECK	R	0455 88-108-183-080		C-RES,U 18K-1/16W J	USM	CX-SNAJ305
X	TAPE DECK	R	0455 88-108-183-080		C-RES,U 18K-1/16W J	EZSM	CX-NSZ300
X	TAPE DECK	R	0455 88-108-183-080	OE	C-RES,U 18K-1/16W J	USM	CX-SNAJ300
X	TAPE DECK	R	0455 88-108-183-080	OE	C-RES,U 18K-1/16W J	USM	CX-SNAJ305
X	TAPE DECK	R	0456 88-108-183-080		C-RES,U 18K-1/16W J	LHSM	CX-NSZ300
X	TAPE DECK	R	0456 88-108-183-080		C-RES,U 18K-1/16W J	USM	CX-SNAJ300
X	TAPE DECK	R	0456 88-108-183-080		C-RES,U 18K-1/16W J	USM	CX-SNAJ305
X	TAPE DECK	R	0456 88-108-183-080	OE	C-RES,U 18K-1/16W J	USM	CX-SNAJ300
X	TAPE DECK	R	0457 88-130-100-080		RES,10-1/4W J	LHSM	CX-NSZ300
X	TAPE DECK	R	0457 88-130-100-080		RES,10-1/4W J	USM	CX-SNAJ300
X	TAPE DECK	R	0457 88-130-100-080		RES,10-1/4W J	USM	CX-SNAJ305
X	TAPE DECK	R	0457 88-130-100-080		RES,10-1/4W J	EZSM	CX-NSZ300
X	TAPE DECK	R	0457 88-130-100-080	OE	RES,10-1/4W J	USM	CX-SNAJ300
X	TAPE DECK	R	0457 88-130-100-080	OE	RES,10-1/4W J	USM	CX-SNAJ305

PARTS LIST

! = Δ SAFTY PARTS
 C = Components marked

All components used on this model at the production line are shown in this service manual.

However, please note that not all components will be available as spare parts for after-sales service.

Components marked S and O are designated as spare parts for service and will be stocked at the spare parts centers.

Components marked X and R are not designated as spare parts for after sales service, and will not be stocked at the spare parts centers.

K NO. = Only use japanese.

! C	UNIT NAME	REF NO.	PARTS CODE	K NO.	DESCRIPTION	SUFFIX	MODEL NAME
X	TAPE DECK	R 0458	88-121-104-080		RES,100K-1/8W J	LHSM	CX-NSZ300
X	TAPE DECK	R 0458	88-121-104-080		RES,100K-1/8W J	USM	CX-SNAJ300
X	TAPE DECK	R 0458	88-121-104-080		RES,100K-1/8W J	USM	CX-SNAJ305
X	TAPE DECK	R 0458	88-121-104-080		RES,100K-1/8W J	EZSM	CX-NSZ300
X	TAPE DECK	R 0458	88-121-104-080	OE	RES,100K-1/8W J	USM	CX-SNAJ300
X	TAPE DECK	R 0458	88-121-104-080	OE	RES,100K-1/8W J	USM	CX-SNAJ305
X	TAPE DECK	R 0459	88-128-100-080		C-RES, 10-1/8W J	LHSM	CX-NSZ300
X	TAPE DECK	R 0459	88-128-100-080		C-RES, 10-1/8W J	USM	CX-SNAJ300
X	TAPE DECK	R 0459	88-128-100-080		C-RES, 10-1/8W J	USM	CX-SNAJ305
X	TAPE DECK	R 0459	88-128-150-080		C-RES, 15-1/8W J	EZSM	CX-NSZ300
X	TAPE DECK	R 0459	88-128-150-080	OE	C-RES, 15-1/8W J	USM	CX-SNAJ300
X	TAPE DECK	R 0459	88-128-150-080	OE	C-RES, 15-1/8W J	USM	CX-SNAJ305
X	TAPE DECK	R 0460	88-130-150-080		RES,15-1/4W J	LHSM	CX-NSZ300
X	TAPE DECK	R 0460	88-130-150-080		RES,15-1/4W J	USM	CX-SNAJ300
X	TAPE DECK	R 0460	88-130-150-080		RES,15-1/4W J	USM	CX-SNAJ305
X	TAPE DECK	R 0460	88-140-100-080		RES,10-1/2W J	EZSM	CX-NSZ300
X	TAPE DECK	R 0460	88-140-100-080	OE	RES,10-1/2W J	USM	CX-SNAJ300
X	TAPE DECK	R 0460	88-140-100-080	OE	RES,10-1/2W J	USM	CX-SNAJ305
X	TAPE DECK	R 0461	88-108-103-080		C-RES,U 10K-1/16W J	EZSM	CX-NSZ300
X	TAPE DECK	R 0462	88-108-471-080		C-RES,U 470-1/16W J	EZSM	CX-NSZ300
O	TAPE DECK	SFR0451	87-024-435-080		SFR,33K H RH063MC	LHSM	CX-NSZ300
O	TAPE DECK	SFR0451	87-024-435-080		SFR,33K H RH063MC	USM	CX-SNAJ300
O	TAPE DECK	SFR0451	87-024-435-080		SFR,33K H RH063MC	USM	CX-SNAJ305
O	TAPE DECK	SFR0451	87-024-435-080		SFR,33K H RH063MC	EZSM	CX-NSZ300
O	TAPE DECK	SFR0451	87-024-435-080	OE	SFR,33K H RH063MC	LHSM	CX-NSZ300
O	TAPE DECK	SFR0451	87-024-435-080	OE	SFR,33K H RH063MC	USM	CX-SNAJ300
O	TAPE DECK	SFR0451	87-024-435-080	OE	SFR,33K H RH063MC	USM	CX-SNAJ305
O	TAPE DECK	SFR0452	87-024-435-080		SFR,33K H RH063MC	LHSM	CX-NSZ300
O	TAPE DECK	SFR0452	87-024-435-080		SFR,33K H RH063MC	USM	CX-SNAJ300
O	TAPE DECK	SFR0452	87-024-435-080		SFR,33K H RH063MC	USM	CX-SNAJ305
O	TAPE DECK	SFR0452	87-024-435-080		SFR,33K H RH063MC	EZSM	CX-NSZ300
O	TAPE DECK	SFR0452	87-024-435-080	OE	SFR,33K H RH063MC	LHSM	CX-NSZ300
O	TAPE DECK	SFR0452	87-024-435-080	OE	SFR,33K H RH063MC	USM	CX-SNAJ300
O	TAPE DECK	SFR0452	87-024-435-080	OE	SFR,33K H RH063MC	USM	CX-SNAJ305
O	TUNER (FM FE)	C 0901	87-018-145-080	OE	CAP,TC U 6.8P-50 K CH UP050	USM	CX-SNAJ300
O	TUNER (FM FE)	C 0901	87-018-145-080	OE	CAP,TC U 6.8P-50 K CH UP050	USM	CX-SNAJ305
O	TUNER (FM FE)	C 0901	87-018-148-080		CAP,TC U 12P-50 J CH UP050	LHSM	CX-NSZ300
O	TUNER (FM FE)	C 0901	87-018-148-080		CAP,TC U 12P-50 J CH UP050	USM	CX-SNAJ300
O	TUNER (FM FE)	C 0901	87-018-148-080		CAP,TC U 12P-50 J CH UP050	USM	CX-SNAJ305
O	TUNER (FM FE)	C 0904	87-012-286-080		C-CAP,U 0.01-25 K B	LHSM	CX-NSZ300
O	TUNER (FM FE)	C 0904	87-012-286-080		C-CAP,U 0.01-25 K B	USM	CX-SNAJ300
O	TUNER (FM FE)	C 0904	87-012-286-080		C-CAP,U 0.01-25 K B	USM	CX-SNAJ305
O	TUNER (FM FE)	C 0904	87-012-286-080	OE	C-CAP,U 0.01-25 K B	USM	CX-SNAJ300
O	TUNER (FM FE)	C 0904	87-012-286-080	OE	C-CAP,U 0.01-25 K B	USM	CX-SNAJ305
O	TUNER (FM FE)	C 0905	87-012-286-080		C-CAP,U 0.01-25 K B	LHSM	CX-NSZ300
O	TUNER (FM FE)	C 0905	87-012-286-080		C-CAP,U 0.01-25 K B	USM	CX-SNAJ300
O	TUNER (FM FE)	C 0905	87-012-286-080		C-CAP,U 0.01-25 K B	USM	CX-SNAJ305
O	TUNER (FM FE)	C 0905	87-012-286-080	OE	C-CAP,U 0.01-25 K B	USM	CX-SNAJ300
O	TUNER (FM FE)	C 0905	87-012-286-080	OE	C-CAP,U 0.01-25 K B	USM	CX-SNAJ305
O	TUNER (FM FE)	C 0907	87-012-286-080		C-CAP,U 0.01-25 K B	LHSM	CX-NSZ300
O	TUNER (FM FE)	C 0907	87-012-286-080		C-CAP,U 0.01-25 K B	USM	CX-SNAJ300
O	TUNER (FM FE)	C 0907	87-012-286-080		C-CAP,U 0.01-25 K B	USM	CX-SNAJ305
O	TUNER (FM FE)	C 0907	87-012-286-080	OE	C-CAP,U 0.01-25 K B	USM	CX-SNAJ300
O	TUNER (FM FE)	C 0907	87-012-286-080	OE	C-CAP,U 0.01-25 K B	USM	CX-SNAJ305
O	TUNER (FM FE)	C 0908	87-A10-915-080		C-CAP,U 1000P-25 J CH	LHSM	CX-NSZ300
O	TUNER (FM FE)	C 0908	87-A10-915-080		C-CAP,U 1000P-25 J CH	USM	CX-SNAJ300
O	TUNER (FM FE)	C 0908	87-A10-915-080		C-CAP,U 1000P-25 J CH	USM	CX-SNAJ305
O	TUNER (FM FE)	C 0908	87-A10-915-080	OE	C-CAP,U 1000P-25 J CH	USM	CX-SNAJ300
O	TUNER (FM FE)	C 0908	87-A10-915-080	OE	C-CAP,U 1000P-25 J CH	USM	CX-SNAJ305
O	TUNER (FM FE)	C 0909	87-012-286-080		C-CAP,U 0.01-25 K B	LHSM	CX-NSZ300
O	TUNER (FM FE)	C 0909	87-012-286-080		C-CAP,U 0.01-25 K B	USM	CX-SNAJ300
O	TUNER (FM FE)	C 0909	87-012-286-080		C-CAP,U 0.01-25 K B	USM	CX-SNAJ305
O	TUNER (FM FE)	C 0909	87-012-286-080	OE	C-CAP,U 0.01-25 K B	USM	CX-SNAJ300
O	TUNER (FM FE)	C 0909	87-012-286-080	OE	C-CAP,U 0.01-25 K B	USM	CX-SNAJ305
O	TUNER (FM FE)	C 0910	87-012-174-080		C-CAP,U 12P-50 J CH	LHSM	CX-NSZ300
O	TUNER (FM FE)	C 0910	87-012-174-080		C-CAP,U 12P-50 J CH	USM	CX-SNAJ300
O	TUNER (FM FE)	C 0910	87-012-174-080		C-CAP,U 12P-50 J CH	USM	CX-SNAJ305
O	TUNER (FM FE)	C 0910	87-012-174-080	OE	C-CAP,U 12P-50 J CH	USM	CX-SNAJ300
O	TUNER (FM FE)	C 0910	87-012-174-080	OE	C-CAP,U 12P-50 J CH	USM	CX-SNAJ305
O	TUNER (FM FE)	C 0911	87-012-170-080		C-CAP,U 8P-50 D CH	LHSM	CX-NSZ300

PARTS LIST

! = Δ SAFTY PARTS
 C = Components marked

All components used on this model at the production line are shown in this service manual.

However, please note that not all components will be available as spare parts for after-sales service.

Components marked S and O are designated as spare parts for service and will be stocked at the spare parts centers.

Components marked X and R are not designated as spare parts for after sales service, and will not be stocked at the spare parts centers.

K NO. = Only use japanese.

! C	UNIT NAME	REF NO.	PARTS CODE	K NO.	DESCRIPTION	SUFFIX	MODEL NAME
O	TUNER (FM FE)	C	0911 87-012-170-080		C-CAP,U 8P-50 D CH	USM	CX-SNAJ300
O	TUNER (FM FE)	C	0911 87-012-170-080		C-CAP,U 8P-50 D CH	USM	CX-SNAJ305
O	TUNER (FM FE)	C	0911 87-012-170-080	OE	C-CAP,U 8P-50 D CH	USM	CX-SNAJ300
O	TUNER (FM FE)	C	0911 87-012-170-080	OE	C-CAP,U 8P-50 D CH	USM	CX-SNAJ305
O	TUNER (FM FE)	C	0912 87-012-195-080		C-CAP,U 100P-50 J CH	LHSM	CX-NSZ300
O	TUNER (FM FE)	C	0912 87-012-195-080		C-CAP,U 100P-50 J CH	USM	CX-SNAJ300
O	TUNER (FM FE)	C	0912 87-012-195-080		C-CAP,U 100P-50 J CH	USM	CX-SNAJ305
O	TUNER (FM FE)	C	0912 87-012-195-080	OE	C-CAP,U 100P-50 J CH	USM	CX-SNAJ300
O	TUNER (FM FE)	C	0912 87-012-195-080	OE	C-CAP,U 100P-50 J CH	USM	CX-SNAJ305
O	TUNER (FM FE)	C	0913 87-012-286-080		C-CAP,U 0.01-25 K B	LHSM	CX-NSZ300
O	TUNER (FM FE)	C	0913 87-012-286-080		C-CAP,U 0.01-25 K B	USM	CX-SNAJ300
O	TUNER (FM FE)	C	0913 87-012-286-080	OE	C-CAP,U 0.01-25 K B	USM	CX-SNAJ305
O	TUNER (FM FE)	C	0913 87-012-286-080	OE	C-CAP,U 0.01-25 K B	USM	CX-SNAJ300
O	TUNER (FM FE)	C	0914 87-012-164-080		C-CAP,U 2P-50 C CH	LHSM	CX-NSZ300
O	TUNER (FM FE)	C	0914 87-012-164-080		C-CAP,U 2P-50 C CH	USM	CX-SNAJ300
O	TUNER (FM FE)	C	0914 87-012-164-080		C-CAP,U 2P-50 C CH	USM	CX-SNAJ305
O	TUNER (FM FE)	C	0914 87-012-166-080	OE	C-CAP,U 4P-50 C CH	USM	CX-SNAJ300
O	TUNER (FM FE)	C	0914 87-012-166-080	OE	C-CAP,U 4P-50 C CH	USM	CX-SNAJ305
O	TUNER (FM FE)	C	0915 87-012-174-080		C-CAP,U 12P-50 J CH	LHSM	CX-NSZ300
O	TUNER (FM FE)	C	0915 87-012-174-080		C-CAP,U 12P-50 J CH	USM	CX-SNAJ300
O	TUNER (FM FE)	C	0915 87-012-174-080	OE	C-CAP,U 12P-50 J CH	USM	CX-SNAJ305
O	TUNER (FM FE)	C	0915 87-012-174-080	OE	C-CAP,U 12P-50 J CH	USM	CX-SNAJ300
O	TUNER (FM FE)	C	0916 87-012-180-080		C-CAP,U 22P-50 J CH	LHSM	CX-NSZ300
O	TUNER (FM FE)	C	0916 87-012-180-080		C-CAP,U 22P-50 J CH	USM	CX-SNAJ300
O	TUNER (FM FE)	C	0916 87-012-180-080		C-CAP,U 22P-50 J CH	USM	CX-SNAJ305
O	TUNER (FM FE)	C	0916 87-012-180-080	OE	C-CAP,U 22P-50 J CH	USM	CX-SNAJ300
O	TUNER (FM FE)	C	0916 87-012-180-080	OE	C-CAP,U 22P-50 J CH	USM	CX-SNAJ305
O	TUNER (FM FE)	C	0917 87-012-186-080		C-CAP,U 39P-50 J CH	LHSM	CX-NSZ300
O	TUNER (FM FE)	C	0917 87-012-186-080		C-CAP,U 39P-50 J CH	USM	CX-SNAJ300
O	TUNER (FM FE)	C	0917 87-012-186-080	OE	C-CAP,U 39P-50 J CH	USM	CX-SNAJ305
O	TUNER (FM FE)	C	0917 87-012-186-080	OE	C-CAP,U 39P-50 J CH	USM	CX-SNAJ300
O	TUNER (FM FE)	C	0918 87-A10-039-080		C-CAP,U 470P-50 J CH	LHSM	CX-NSZ300
O	TUNER (FM FE)	C	0918 87-A10-039-080		C-CAP,U 470P-50 J CH	USM	CX-SNAJ300
O	TUNER (FM FE)	C	0918 87-A10-039-080		C-CAP,U 470P-50 J CH	USM	CX-SNAJ305
O	TUNER (FM FE)	C	0918 87-A10-039-080	OE	C-CAP,U 470P-50 J CH	USM	CX-SNAJ300
O	TUNER (FM FE)	C	0918 87-A10-039-080	OE	C-CAP,U 470P-50 J CH	USM	CX-SNAJ305
O	TUNER (FM FE)	C	0921 87-012-195-080		C-CAP,U 100P-50 J CH	LHSM	CX-NSZ300
O	TUNER (FM FE)	C	0921 87-012-195-080		C-CAP,U 100P-50 J CH	USM	CX-SNAJ300
O	TUNER (FM FE)	C	0921 87-012-195-080	OE	C-CAP,U 100P-50 J CH	USM	CX-SNAJ305
O	TUNER (FM FE)	C	0921 87-012-195-080	OE	C-CAP,U 100P-50 J CH	USM	CX-SNAJ300
O	TUNER (FM FE)	C	0922 87-012-174-080		C-CAP,U 12P-50 J CH	LHSM	CX-NSZ300
O	TUNER (FM FE)	C	0922 87-012-174-080		C-CAP,U 12P-50 J CH	USM	CX-SNAJ300
O	TUNER (FM FE)	C	0922 87-012-174-080		C-CAP,U 12P-50 J CH	USM	CX-SNAJ305
O	TUNER (FM FE)	C	0922 87-012-174-080	OE	C-CAP,U 12P-50 J CH	USM	CX-SNAJ300
O	TUNER (FM FE)	C	0922 87-012-174-080	OE	C-CAP,U 12P-50 J CH	USM	CX-SNAJ305
O	TUNER (FM FE)	D	0902 87-A40-128-080		C-VARI-CAP,HVU202A	LHSM	CX-NSZ300
O	TUNER (FM FE)	D	0902 87-A40-128-080		C-VARI-CAP,HVU202A	USM	CX-SNAJ300
O	TUNER (FM FE)	D	0902 87-A40-128-080	OE	C-VARI-CAP,HVU202A	USM	CX-SNAJ305
O	TUNER (FM FE)	D	0902 87-A40-128-080	OE	C-VARI-CAP,HVU202A	USM	CX-SNAJ300
O	TUNER (FM FE)	D	0903 87-A40-128-080		C-VARI-CAP,HVU202A	LHSM	CX-NSZ300
O	TUNER (FM FE)	D	0903 87-A40-128-080		C-VARI-CAP,HVU202A	USM	CX-SNAJ300
O	TUNER (FM FE)	D	0903 87-A40-128-080		C-VARI-CAP,HVU202A	USM	CX-SNAJ305
O	TUNER (FM FE)	D	0903 87-A40-128-080	OE	C-VARI-CAP,HVU202A	USM	CX-SNAJ300
O	TUNER (FM FE)	D	0903 87-A40-128-080	OE	C-VARI-CAP,HVU202A	USM	CX-SNAJ305
O	TUNER (FM FE)	L	0902 88-ZA1-602-110		COIL, FM-RF-U2 2G	LHSM	CX-NSZ300
O	TUNER (FM FE)	L	0902 88-ZA1-602-110		COIL, FM-RF-U2 2G	USM	CX-SNAJ300
O	TUNER (FM FE)	L	0902 88-ZA1-602-110	OE	COIL, FM-RF-U2 2G	USM	CX-SNAJ305
O	TUNER (FM FE)	L	0902 88-ZA1-602-110	OE	COIL, FM-RF-U2 2G	USM	CX-SNAJ300
O	TUNER (FM FE)	L	0903 88-ZA1-601-010		COIL, FM-RF-U1 2G	LHSM	CX-NSZ300
O	TUNER (FM FE)	L	0903 88-ZA1-601-010		COIL, FM-RF-U1 2G	USM	CX-SNAJ300
O	TUNER (FM FE)	L	0903 88-ZA1-601-010		COIL, FM-RF-U1 2G	USM	CX-SNAJ305
O	TUNER (FM FE)	L	0903 88-ZA1-601-010	OE	COIL, FM-RF-U1 2G	USM	CX-SNAJ300
O	TUNER (FM FE)	L	0903 88-ZA1-601-010	OE	COIL, FM-RF-U1 2G	USM	CX-SNAJ305
O	TUNER (FM FE)	L	0904 87-005-847-080		COIL, 2.2UH K CECS	LHSM	CX-NSZ300

PARTS LIST

! = Δ SAFTY PARTS
 C = Components marked

All components used on this model at the production line are shown in this service manual.

However, please note that not all components will be available as spare parts for after-sales service.

Components marked S and O are designated as spare parts for service and will be stocked at the spare parts centers.

Components marked X and R are not designated as spare parts for after sales service, and will not be stocked at the spare parts centers.

K NO. = Only use japanese.

! C	UNIT NAME	REF NO.	PARTS CODE	K NO.	DESCRIPTION	SUFFIX	MODEL NAME
O	TUNER (FM FE)	L 0904	87-005-847-080		COIL, 2.2UH K CECS	USM	CX-SNAJ300
O	TUNER (FM FE)	L 0904	87-005-847-080		COIL, 2.2UH K CECS	USM	CX-SNAJ305
O	TUNER (FM FE)	L 0904	87-005-847-080	OE	COIL, 2.2UH K CECS	USM	CX-SNAJ300
O	TUNER (FM FE)	L 0904	87-005-847-080	OE	COIL, 2.2UH K CECS	USM	CX-SNAJ305
O	TUNER (FM FE)	L 0905	88-ZA1-624-010		COIL, FM IFT 7-6.2 (COILS)	LHSM	CX-NSZ300
O	TUNER (FM FE)	L 0905	88-ZA1-624-010		COIL, FM IFT 7-6.2 (COILS)	USM	CX-SNAJ300
O	TUNER (FM FE)	L 0905	88-ZA1-624-010		COIL, FM IFT 7-6.2 (COILS)	USM	CX-SNAJ305
O	TUNER (FM FE)	L 0905	88-ZA1-624-010	OE	COIL, FM IFT 7-6.2 (COILS)	USM	CX-SNAJ300
O	TUNER (FM FE)	L 0905	88-ZA1-624-010	OE	COIL, FM IFT 7-6.2 (COILS)	USM	CX-SNAJ305
O	TUNER (FM FE)	L 0906	88-ZA1-603-010		COIL, FM-OSC-U 2G	LHSM	CX-NSZ300
O	TUNER (FM FE)	L 0906	88-ZA1-603-010		COIL, FM-OSC-U 2G	USM	CX-SNAJ300
O	TUNER (FM FE)	L 0906	88-ZA1-603-010	OE	COIL, FM-OSC-U 2G	USM	CX-SNAJ305
O	TUNER (FM FE)	L 0906	88-ZA1-603-010	OE	COIL, FM-OSC-U 2G	USM	CX-SNAJ305
S	TUNER (FM FE)	Q 0901	89-503-602-080		C-FET, 2SK360E	LHSM	CX-NSZ300
S	TUNER (FM FE)	Q 0901	89-503-602-080		C-FET, 2SK360E	USM	CX-SNAJ300
S	TUNER (FM FE)	Q 0901	89-503-602-080		C-FET, 2SK360E	USM	CX-SNAJ305
S	TUNER (FM FE)	Q 0901	89-503-602-080	1A	C-FET, 2SK360E	USM	CX-SNAJ300
S	TUNER (FM FE)	Q 0901	89-503-602-080	1A	C-FET, 2SK360E	USM	CX-SNAJ305
S	TUNER (FM FE)	Q 0902	87-A30-521-080		C-TR, 2SC5345S(O)	LHSM	CX-NSZ300
S	TUNER (FM FE)	Q 0902	87-A30-521-080		C-TR, 2SC5345S(O)	USM	CX-SNAJ300
S	TUNER (FM FE)	Q 0902	87-A30-521-080		C-TR, 2SC5345S(O)	USM	CX-SNAJ305
S	TUNER (FM FE)	Q 0902	89-327-143-080	OE	C-TR, 2SC27140	USM	CX-SNAJ300
S	TUNER (FM FE)	Q 0902	89-327-143-080	OE	C-TR, 2SC27140	USM	CX-SNAJ305
S	TUNER (FM FE)	Q 0903	87-A30-521-080		C-TR, 2SC5345S(O)	LHSM	CX-NSZ300
S	TUNER (FM FE)	Q 0903	87-A30-521-080		C-TR, 2SC5345S(O)	USM	CX-SNAJ300
S	TUNER (FM FE)	Q 0903	87-A30-521-080		C-TR, 2SC5345S(O)	USM	CX-SNAJ305
S	TUNER (FM FE)	Q 0903	89-327-143-080	OE	C-TR, 2SC27140	USM	CX-SNAJ300
S	TUNER (FM FE)	Q 0903	89-327-143-080	OE	C-TR, 2SC27140	USM	CX-SNAJ305
X	TUNER (FM FE)	R 0903	88-108-221-080		C-RES, U 220-1/16W J	LHSM	CX-NSZ300
X	TUNER (FM FE)	R 0903	88-108-221-080		C-RES, U 220-1/16W J	USM	CX-SNAJ300
X	TUNER (FM FE)	R 0903	88-108-221-080		C-RES, U 220-1/16W J	USM	CX-SNAJ305
X	TUNER (FM FE)	R 0903	88-108-471-080	OE	C-RES, U 470-1/16W J	USM	CX-SNAJ300
X	TUNER (FM FE)	R 0903	88-108-471-080	OE	C-RES, U 470-1/16W J	USM	CX-SNAJ305
X	TUNER (FM FE)	R 0904	88-108-473-080		C-RES, U 47K-1/16W J	LHSM	CX-NSZ300
X	TUNER (FM FE)	R 0904	88-108-473-080		C-RES, U 47K-1/16W J	USM	CX-SNAJ300
X	TUNER (FM FE)	R 0904	88-108-473-080		C-RES, U 47K-1/16W J	USM	CX-SNAJ305
X	TUNER (FM FE)	R 0904	88-108-473-080	OE	C-RES, U 47K-1/16W J	USM	CX-SNAJ300
X	TUNER (FM FE)	R 0904	88-108-473-080	OE	C-RES, U 47K-1/16W J	USM	CX-SNAJ305
X	TUNER (FM FE)	R 0905	88-108-564-080		C-RES, U 560K-1/16W J	LHSM	CX-NSZ300
X	TUNER (FM FE)	R 0905	88-108-564-080		C-RES, U 560K-1/16W J	USM	CX-SNAJ300
X	TUNER (FM FE)	R 0905	88-108-564-080		C-RES, U 560K-1/16W J	USM	CX-SNAJ305
X	TUNER (FM FE)	R 0905	88-108-564-080	OE	C-RES, U 560K-1/16W J	USM	CX-SNAJ300
X	TUNER (FM FE)	R 0905	88-108-564-080	OE	C-RES, U 560K-1/16W J	USM	CX-SNAJ305
X	TUNER (FM FE)	R 0907	88-108-472-080		C-RES, U 4.7K-1/16W J	LHSM	CX-NSZ300
X	TUNER (FM FE)	R 0907	88-108-472-080		C-RES, U 4.7K-1/16W J	USM	CX-SNAJ300
X	TUNER (FM FE)	R 0907	88-108-472-080		C-RES, U 4.7K-1/16W J	USM	CX-SNAJ305
X	TUNER (FM FE)	R 0907	88-108-472-080	OE	C-RES, U 4.7K-1/16W J	USM	CX-SNAJ300
X	TUNER (FM FE)	R 0907	88-108-472-080	OE	C-RES, U 4.7K-1/16W J	USM	CX-SNAJ305
X	TUNER (FM FE)	R 0908	88-108-121-080		C-RES, U 120-1/16W J	LHSM	CX-NSZ300
X	TUNER (FM FE)	R 0908	88-108-121-080		C-RES, U 120-1/16W J	USM	CX-SNAJ300
X	TUNER (FM FE)	R 0908	88-108-121-080		C-RES, U 120-1/16W J	USM	CX-SNAJ305
X	TUNER (FM FE)	R 0908	88-108-121-080	OE	C-RES, U 120-1/16W J	USM	CX-SNAJ300
X	TUNER (FM FE)	R 0908	88-108-121-080	OE	C-RES, U 120-1/16W J	USM	CX-SNAJ305
X	TUNER (FM FE)	R 0909	88-108-473-080		C-RES, U 47K-1/16W J	LHSM	CX-NSZ300
X	TUNER (FM FE)	R 0909	88-108-473-080		C-RES, U 47K-1/16W J	USM	CX-SNAJ300
X	TUNER (FM FE)	R 0909	88-108-473-080		C-RES, U 47K-1/16W J	USM	CX-SNAJ305
X	TUNER (FM FE)	R 0909	88-108-473-080	OE	C-RES, U 47K-1/16W J	USM	CX-SNAJ300
X	TUNER (FM FE)	R 0909	88-108-473-080	OE	C-RES, U 47K-1/16W J	USM	CX-SNAJ305
X	TUNER (FM FE)	R 0910	88-108-472-080		C-RES, U 4.7K-1/16W J	LHSM	CX-NSZ300
X	TUNER (FM FE)	R 0910	88-108-472-080		C-RES, U 4.7K-1/16W J	USM	CX-SNAJ300
X	TUNER (FM FE)	R 0910	88-108-472-080		C-RES, U 4.7K-1/16W J	USM	CX-SNAJ305
X	TUNER (FM FE)	R 0910	88-108-822-080	OE	C-RES, U 8.2K-1/16W J	USM	CX-SNAJ300
X	TUNER (FM FE)	R 0910	88-108-822-080	OE	C-RES, U 8.2K-1/16W J	USM	CX-SNAJ305
X	TUNER (FM FE)	R 0911	88-108-101-080		C-RES, U 100-1/16W J	LHSM	CX-NSZ300
X	TUNER (FM FE)	R 0911	88-108-101-080		C-RES, U 100-1/16W J	USM	CX-SNAJ300
X	TUNER (FM FE)	R 0911	88-108-101-080		C-RES, U 100-1/16W J	USM	CX-SNAJ305
X	TUNER (FM FE)	R 0911	88-108-101-080	OE	C-RES, U 100-1/16W J	USM	CX-SNAJ300
X	TUNER (FM FE)	R 0911	88-108-101-080	OE	C-RES, U 100-1/16W J	USM	CX-SNAJ305
X	TUNER (FM FE)	SH 0901	88-ZA1-605-010		SHLD-CASE, IFT CAP-CASE	LHSM	CX-NSZ300

PARTS LIST

! = Δ SAFTY PARTS
 C = Components marked

All components used on this model at the production line are shown in this service manual.

However, please note that not all components will be available as spare parts for after-sales service.

Components marked S and O are designated as spare parts for service and will be stocked at the spare parts centers.

Components marked X and R are not designated as spare parts for after sales service, and will not be stocked at the spare parts centers.

K NO. = Only use japanese.

! C	UNIT NAME	REF NO.	PARTS CODE	K NO.	DESCRIPTION	SUFFIX	MODEL NAME
X	TUNER (FM FE)	SH 0901	88-ZA1-605-010		SHLD-CASE, IFT CAP-CASE	USM	CX-SNAJ300
X	TUNER (FM FE)	SH 0901	88-ZA1-605-010		SHLD-CASE, IFT CAP-CASE	USM	CX-SNAJ305
X	TUNER (FM FE)	SH 0901	88-ZA1-605-010	--	SHLD-CASE, IFT CAP-CASE	USM	CX-SNAJ300
X	TUNER (FM FE)	SH 0901	88-ZA1-605-010	--	SHLD-CASE, IFT CAP-CASE	USM	CX-SNAJ305
O	TUNER (IF)	C 0771	87-A12-062-080		CAP,E 100-10 SMG	LHSM	CX-NSZ300
O	TUNER (IF)	C 0771	87-A12-062-080		CAP,E 100-10 SMG	USM	CX-SNAJ300
O	TUNER (IF)	C 0771	87-A12-062-080		CAP,E 100-10 SMG	USM	CX-SNAJ305
O	TUNER (IF)	C 0771	87-A12-062-080		CAP,E 100-10 SMG	EZSM	CX-NSZ300
O	TUNER (IF)	C 0771	87-A12-062-080	OE	CAP,E 100-10 SMG	USM	CX-SNAJ300
O	TUNER (IF)	C 0771	87-A12-062-080	OE	CAP,E 100-10 SMG	USM	CX-SNAJ305
O	TUNER (IF)	C 0772	87-012-286-080		C-CAP,U 0.01-25 K B	LHSM	CX-NSZ300
O	TUNER (IF)	C 0772	87-012-286-080		C-CAP,U 0.01-25 K B	USM	CX-SNAJ300
O	TUNER (IF)	C 0772	87-012-286-080		C-CAP,U 0.01-25 K B	USM	CX-SNAJ305
O	TUNER (IF)	C 0772	87-012-286-080		C-CAP,U 0.01-25 K B	EZSM	CX-NSZ300
O	TUNER (IF)	C 0772	87-012-286-080	OE	C-CAP,U 0.01-25 K B	USM	CX-SNAJ300
O	TUNER (IF)	C 0772	87-012-286-080	OE	C-CAP,U 0.01-25 K B	USM	CX-SNAJ305
O	TUNER (IF)	C 0779	87-010-949-080		C-CAP,S 0.01-50 J B	EZSM	CX-NSZ300
O	TUNER (IF)	C 0780	87-010-949-080		C-CAP,S 0.01-50 J B	EZSM	CX-NSZ300
X	TUNER (IF)	C 0781	88-108-000-080		C-JUMPER,U	LHSM	CX-NSZ300
X	TUNER (IF)	C 0781	88-108-000-080		C-JUMPER,U	USM	CX-SNAJ300
X	TUNER (IF)	C 0781	88-108-000-080		C-JUMPER,U	USM	CX-SNAJ305
X	TUNER (IF)	C 0781	88-108-000-080		C-JUMPER,U	EZSM	CX-NSZ300
X	TUNER (IF)	C 0781	88-108-000-080	OE	C-JUMPER,U	USM	CX-SNAJ300
X	TUNER (IF)	C 0781	88-108-000-080	OE	C-JUMPER,U	USM	CX-SNAJ305
O	TUNER (IF)	C 0782	87-012-286-080		C-CAP,U 0.01-25 K B	LHSM	CX-NSZ300
O	TUNER (IF)	C 0782	87-012-286-080		C-CAP,U 0.01-25 K B	USM	CX-SNAJ300
O	TUNER (IF)	C 0782	87-012-286-080		C-CAP,U 0.01-25 K B	USM	CX-SNAJ305
O	TUNER (IF)	C 0782	87-012-286-080		C-CAP,U 0.01-25 K B	EZSM	CX-NSZ300
O	TUNER (IF)	C 0782	87-012-286-080	OE	C-CAP,U 0.01-25 K B	USM	CX-SNAJ300
O	TUNER (IF)	C 0782	87-012-286-080	OE	C-CAP,U 0.01-25 K B	USM	CX-SNAJ305
O	TUNER (IF)	C 0783	87-012-286-080		C-CAP,U 0.01-25 K B	LHSM	CX-NSZ300
O	TUNER (IF)	C 0783	87-012-286-080		C-CAP,U 0.01-25 K B	USM	CX-SNAJ300
O	TUNER (IF)	C 0783	87-012-286-080		C-CAP,U 0.01-25 K B	USM	CX-SNAJ305
O	TUNER (IF)	C 0783	87-012-286-080		C-CAP,U 0.01-25 K B	EZSM	CX-NSZ300
O	TUNER (IF)	C 0783	87-012-286-080	OE	C-CAP,U 0.01-25 K B	USM	CX-SNAJ300
O	TUNER (IF)	C 0783	87-012-286-080	OE	C-CAP,U 0.01-25 K B	USM	CX-SNAJ305
O	TUNER (IF)	C 0784	87-012-286-080		C-CAP,U 0.01-25 K B	LHSM	CX-NSZ300
O	TUNER (IF)	C 0784	87-012-286-080		C-CAP,U 0.01-25 K B	USM	CX-SNAJ300
O	TUNER (IF)	C 0784	87-012-286-080		C-CAP,U 0.01-25 K B	USM	CX-SNAJ305
O	TUNER (IF)	C 0784	87-012-286-080		C-CAP,U 0.01-25 K B	EZSM	CX-NSZ300
O	TUNER (IF)	C 0784	87-012-286-080	OE	C-CAP,U 0.01-25 K B	USM	CX-SNAJ300
O	TUNER (IF)	C 0784	87-012-286-080	OE	C-CAP,U 0.01-25 K B	USM	CX-SNAJ305
O	TUNER (IF)	C 0785	87-012-286-080		C-CAP,U 0.01-25 K B	LHSM	CX-NSZ300
O	TUNER (IF)	C 0785	87-012-286-080		C-CAP,U 0.01-25 K B	USM	CX-SNAJ300
O	TUNER (IF)	C 0785	87-012-286-080		C-CAP,U 0.01-25 K B	USM	CX-SNAJ305
O	TUNER (IF)	C 0785	87-012-286-080		C-CAP,U 0.01-25 K B	EZSM	CX-NSZ300
O	TUNER (IF)	C 0785	87-012-286-080	OE	C-CAP,U 0.01-25 K B	USM	CX-SNAJ300
O	TUNER (IF)	C 0785	87-012-286-080	OE	C-CAP,U 0.01-25 K B	USM	CX-SNAJ305
O	TUNER (IF)	C 0786	87-012-286-080		C-CAP,U 0.01-25 K B	LHSM	CX-NSZ300
O	TUNER (IF)	C 0786	87-012-286-080		C-CAP,U 0.01-25 K B	USM	CX-SNAJ300
O	TUNER (IF)	C 0786	87-012-286-080		C-CAP,U 0.01-25 K B	USM	CX-SNAJ305
O	TUNER (IF)	C 0786	87-012-286-080	OE	C-CAP,U 0.01-25 K B	USM	CX-NSZ300
O	TUNER (IF)	C 0788	87-012-167-080		C-CAP,U 5P-50 C CH	LHSM	CX-NSZ300
O	TUNER (IF)	C 0788	87-012-167-080		C-CAP,U 5P-50 C CH	USM	CX-SNAJ300
O	TUNER (IF)	C 0788	87-012-167-080		C-CAP,U 5P-50 C CH	USM	CX-SNAJ305
O	TUNER (IF)	C 0788	87-012-167-080		C-CAP,U 5P-50 C CH	EZSM	CX-NSZ300
O	TUNER (IF)	C 0788	87-012-167-080	OE	C-CAP,U 5P-50 C CH	USM	CX-SNAJ300
O	TUNER (IF)	C 0788	87-012-167-080	OE	C-CAP,U 5P-50 C CH	USM	CX-SNAJ305
O	TUNER (IF)	C 0789	87-016-118-080		C-CAP,U 0.022-25 J B GRM	EZSM	CX-NSZ300
O	TUNER (IF)	C 0789	87-A12-052-080		C-CAP,S 0.033-25 J B	LHSM	CX-NSZ300
O	TUNER (IF)	C 0789	87-A12-052-080		C-CAP,S 0.033-25 J B	USM	CX-SNAJ300
O	TUNER (IF)	C 0789	87-A12-052-080		C-CAP,S 0.033-25 J B	USM	CX-SNAJ305
O	TUNER (IF)	C 0789	87-A12-052-080	OE	C-CAP,S 0.033-25 J B	USM	CX-SNAJ300
O	TUNER (IF)	C 0789	87-A12-052-080	OE	C-CAP,S 0.033-25 J B	USM	CX-SNAJ305
O	TUNER (IF)	C 0790	87-016-118-080		C-CAP,U 0.022-25 J B GRM	EZSM	CX-NSZ300
O	TUNER (IF)	C 0790	87-A12-052-080		C-CAP,S 0.033-25 J B	LHSM	CX-NSZ300
O	TUNER (IF)	C 0790	87-A12-052-080		C-CAP,S 0.033-25 J B	USM	CX-SNAJ300
O	TUNER (IF)	C 0790	87-A12-052-080		C-CAP,S 0.033-25 J B	USM	CX-SNAJ305

PARTS LIST

! = Δ SAFTY PARTS
 C = Components marked

All components used on this model at the production line are shown in this service manual.

However, please note that not all components will be available as spare parts for after-sales service.

Components marked S and O are designated as spare parts for service and will be stocked at the spare parts centers.

Components marked X and R are not designated as spare parts for after sales service, and will not be stocked at the spare parts centers.

K NO. = Only use japanese.

! C	UNIT NAME	REF NO.	PARTS CODE	K NO.	DESCRIPTION	SUFFIX	MODEL NAME
	O TUNER (IF)	C	0790 87-A12-052-080	OE	C-CAP,S 0.033-25 J B	USM	CX-SNAJ300
	O TUNER (IF)	C	0790 87-A12-052-080	OE	C-CAP,S 0.033-25 J B	USM	CX-SNAJ305
	O TUNER (IF)	C	0791 87-010-831-080		C-CAP,U 0.1-16 Z F	LHSM	CX-NSZ300
	O TUNER (IF)	C	0791 87-010-831-080		C-CAP,U 0.1-16 Z F	USM	CX-SNAJ300
	O TUNER (IF)	C	0791 87-010-831-080		C-CAP,U 0.1-16 Z F	USM	CX-SNAJ305
	O TUNER (IF)	C	0791 87-010-831-080		C-CAP,U 0.1-16 Z F	EZSM	CX-NSZ300
	O TUNER (IF)	C	0791 87-010-831-080	OE	C-CAP,U 0.1-16 Z F	USM	CX-SNAJ300
	O TUNER (IF)	C	0791 87-010-831-080	OE	C-CAP,U 0.1-16 Z F	USM	CX-SNAJ305
	O TUNER (IF)	C	0792 87-012-286-080		C-CAP,U 0.01-25 K B	LHSM	CX-NSZ300
	O TUNER (IF)	C	0792 87-012-286-080		C-CAP,U 0.01-25 K B	USM	CX-SNAJ300
	O TUNER (IF)	C	0792 87-012-286-080		C-CAP,U 0.01-25 K B	USM	CX-SNAJ305
	O TUNER (IF)	C	0792 87-012-286-080	OE	C-CAP,U 0.01-25 K B	USM	CX-SNAJ300
	O TUNER (IF)	C	0793 87-A12-090-080		CAP,E 4.7-50 SMG	LHSM	CX-NSZ300
	O TUNER (IF)	C	0793 87-A12-090-080		CAP,E 4.7-50 SMG	USM	CX-SNAJ300
	O TUNER (IF)	C	0793 87-A12-090-080		CAP,E 4.7-50 SMG	USM	CX-SNAJ305
	O TUNER (IF)	C	0793 87-A12-090-080		CAP,E 4.7-50 SMG	EZSM	CX-NSZ300
	O TUNER (IF)	C	0793 87-A12-090-080	OE	CAP,E 4.7-50 SMG	USM	CX-SNAJ300
	O TUNER (IF)	C	0793 87-A12-090-080	OE	CAP,E 4.7-50 SMG	USM	CX-SNAJ305
	O TUNER (IF)	C	0795 87-012-286-080		C-CAP,U 0.01-25 K B	LHSM	CX-NSZ300
	O TUNER (IF)	C	0795 87-012-286-080		C-CAP,U 0.01-25 K B	USM	CX-SNAJ300
	O TUNER (IF)	C	0795 87-012-286-080		C-CAP,U 0.01-25 K B	USM	CX-SNAJ305
	O TUNER (IF)	C	0795 87-012-286-080		C-CAP,U 0.01-25 K B	EZSM	CX-NSZ300
	O TUNER (IF)	C	0795 87-012-286-080	OE	C-CAP,U 0.01-25 K B	USM	CX-SNAJ300
	O TUNER (IF)	C	0795 87-012-286-080	OE	C-CAP,U 0.01-25 K B	USM	CX-SNAJ305
	O TUNER (IF)	C	0796 87-012-286-080		C-CAP,U 0.01-25 K B	LHSM	CX-NSZ300
	O TUNER (IF)	C	0796 87-012-286-080		C-CAP,U 0.01-25 K B	USM	CX-SNAJ300
	O TUNER (IF)	C	0796 87-012-286-080		C-CAP,U 0.01-25 K B	USM	CX-SNAJ305
	O TUNER (IF)	C	0796 87-012-286-080		C-CAP,U 0.01-25 K B	EZSM	CX-NSZ300
	O TUNER (IF)	C	0796 87-012-286-080	OE	C-CAP,U 0.01-25 K B	USM	CX-SNAJ300
	O TUNER (IF)	C	0796 87-012-286-080	OE	C-CAP,U 0.01-25 K B	USM	CX-SNAJ305
	O TUNER (IF)	C	0797 87-A12-091-080		CAP,E 10-50 SMG	LHSM	CX-NSZ300
	O TUNER (IF)	C	0797 87-A12-091-080		CAP,E 10-50 SMG	USM	CX-SNAJ300
	O TUNER (IF)	C	0797 87-A12-091-080		CAP,E 10-50 SMG	USM	CX-SNAJ305
	O TUNER (IF)	C	0797 87-A12-091-080		CAP,E 10-50 SMG	EZSM	CX-NSZ300
	O TUNER (IF)	C	0797 87-A12-091-080	OE	CAP,E 10-50 SMG	USM	CX-SNAJ300
	O TUNER (IF)	C	0797 87-A12-091-080	OE	CAP,E 10-50 SMG	USM	CX-SNAJ305
	O TUNER (IF)	C	0798 87-012-286-080		C-CAP,U 0.01-25 K B	LHSM	CX-NSZ300
	O TUNER (IF)	C	0798 87-012-286-080		C-CAP,U 0.01-25 K B	USM	CX-SNAJ300
	O TUNER (IF)	C	0798 87-012-286-080		C-CAP,U 0.01-25 K B	USM	CX-SNAJ305
	O TUNER (IF)	C	0798 87-012-286-080	OE	C-CAP,U 0.01-25 K B	USM	CX-SNAJ300
	O TUNER (IF)	C	0799 87-010-265-080		CAP,E 33-16 M 11L SME	EZSM	CX-NSZ300
	O TUNER (IF)	C	0799 87-A12-093-080		CAP,E 33-50 SMG	LHSM	CX-NSZ300
	O TUNER (IF)	C	0799 87-A12-093-080		CAP,E 33-50 SMG	USM	CX-SNAJ300
	O TUNER (IF)	C	0799 87-A12-093-080		CAP,E 33-50 SMG	USM	CX-SNAJ305
	O TUNER (IF)	C	0799 87-A12-093-080	OE	CAP,E 33-50 SMG	USM	CX-SNAJ300
	O TUNER (IF)	C	0799 87-A12-093-080	OE	CAP,E 33-50 SMG	USM	CX-SNAJ305
	O TUNER (IF)	C	0800 87-010-829-080		C-CAP,U 0.047-16 Z F	LHSM	CX-NSZ300
	O TUNER (IF)	C	0800 87-010-829-080		C-CAP,U 0.047-16 Z F	USM	CX-SNAJ300
	O TUNER (IF)	C	0800 87-010-829-080		C-CAP,U 0.047-16 Z F	USM	CX-SNAJ305
	O TUNER (IF)	C	0800 87-010-829-080		C-CAP,U 0.047-16 Z F	EZSM	CX-NSZ300
	O TUNER (IF)	C	0800 87-010-829-080	OE	C-CAP,U 0.047-16 Z F	USM	CX-SNAJ300
	O TUNER (IF)	C	0800 87-010-829-080	OE	C-CAP,U 0.047-16 Z F	USM	CX-SNAJ305
	O TUNER (IF)	C	0801 87-A12-089-080		CAP,E 3.3-50 SMG	LHSM	CX-NSZ300
	O TUNER (IF)	C	0801 87-A12-089-080		CAP,E 3.3-50 SMG	USM	CX-SNAJ300
	O TUNER (IF)	C	0801 87-A12-089-080		CAP,E 3.3-50 SMG	USM	CX-SNAJ305
	O TUNER (IF)	C	0801 87-A12-089-080		CAP,E 3.3-50 SMG	EZSM	CX-NSZ300
	O TUNER (IF)	C	0801 87-A12-089-080	OE	CAP,E 3.3-50 SMG	USM	CX-SNAJ300
	O TUNER (IF)	C	0801 87-A12-089-080	OE	CAP,E 3.3-50 SMG	USM	CX-SNAJ305
	O TUNER (IF)	C	0802 87-010-829-080		C-CAP,U 0.047-16 Z F	LHSM	CX-NSZ300
	O TUNER (IF)	C	0802 87-010-829-080		C-CAP,U 0.047-16 Z F	USM	CX-SNAJ300
	O TUNER (IF)	C	0802 87-010-829-080		C-CAP,U 0.047-16 Z F	USM	CX-SNAJ305
	O TUNER (IF)	C	0802 87-010-829-080		C-CAP,U 0.047-16 Z F	EZSM	CX-NSZ300
	O TUNER (IF)	C	0802 87-010-829-080	OE	C-CAP,U 0.047-16 Z F	USM	CX-SNAJ300
	O TUNER (IF)	C	0802 87-010-829-080	OE	C-CAP,U 0.047-16 Z F	USM	CX-SNAJ305
	O TUNER (IF)	C	0803 87-010-787-080		C-CAP,U 0.022-25 K B	LHSM	CX-NSZ300
	O TUNER (IF)	C	0803 87-010-787-080		C-CAP,U 0.022-25 K B	USM	CX-SNAJ300

PARTS LIST

! = Δ SAFTY PARTS
 C = Components marked

All components used on this model at the production line are shown in this service manual.

However, please note that not all components will be available as spare parts for after-sales service.

Components marked S and O are designated as spare parts for service and will be stocked at the spare parts centers.

Components marked X and R are not designated as spare parts for after sales service, and will not be stocked at the spare parts centers.

K NO. = Only use japanese.

! C	UNIT NAME	REF NO.	PARTS CODE	K NO.	DESCRIPTION	SUFFIX	MODEL NAME
O	TUNER (IF)	C	0803 87-010-787-080		C-CAP,U 0.022-25 K B	USM	CX-SNAJ305
O	TUNER (IF)	C	0803 87-010-787-080		C-CAP,U 0.022-25 K B	EZSM	CX-NSZ300
O	TUNER (IF)	C	0803 87-010-787-080	OE	C-CAP,U 0.022-25 K B	USM	CX-SNAJ300
O	TUNER (IF)	C	0803 87-010-787-080	OE	C-CAP,U 0.022-25 K B	USM	CX-SNAJ305
O	TUNER (IF)	C	0804 87-A12-062-080		CAP,E 100-10 SMG	LHSM	CX-NSZ300
O	TUNER (IF)	C	0804 87-A12-062-080		CAP,E 100-10 SMG	USM	CX-SNAJ300
O	TUNER (IF)	C	0804 87-A12-062-080		CAP,E 100-10 SMG	USM	CX-SNAJ305
O	TUNER (IF)	C	0804 87-A12-062-080		CAP,E 100-10 SMG	EZSM	CX-NSZ300
O	TUNER (IF)	C	0804 87-A12-062-080	OE	CAP,E 100-10 SMG	USM	CX-SNAJ300
O	TUNER (IF)	C	0804 87-A12-062-080	OE	CAP,E 100-10 SMG	USM	CX-SNAJ305
O	TUNER (IF)	C	0807 87-A12-086-080		CAP,E 0.47-50 SMG	LHSM	CX-NSZ300
O	TUNER (IF)	C	0807 87-A12-086-080		CAP,E 0.47-50 SMG	USM	CX-SNAJ300
O	TUNER (IF)	C	0807 87-A12-086-080		CAP,E 0.47-50 SMG	USM	CX-SNAJ305
O	TUNER (IF)	C	0807 87-A12-086-080		CAP,E 0.47-50 SMG	EZSM	CX-NSZ300
O	TUNER (IF)	C	0807 87-A12-086-080	OE	CAP,E 0.47-50 SMG	USM	CX-SNAJ300
O	TUNER (IF)	C	0807 87-A12-086-080	OE	CAP,E 0.47-50 SMG	USM	CX-SNAJ305
O	TUNER (IF)	C	0808 87-A12-087-080		CAP,E 1-50 SMG	LHSM	CX-NSZ300
O	TUNER (IF)	C	0808 87-A12-087-080		CAP,E 1-50 SMG	USM	CX-SNAJ300
O	TUNER (IF)	C	0808 87-A12-087-080		CAP,E 1-50 SMG	USM	CX-SNAJ305
O	TUNER (IF)	C	0808 87-A12-087-080		CAP,E 1-50 SMG	EZSM	CX-NSZ300
O	TUNER (IF)	C	0808 87-A12-087-080	OE	CAP,E 1-50 SMG	USM	CX-SNAJ300
O	TUNER (IF)	C	0808 87-A12-087-080	OE	CAP,E 1-50 SMG	USM	CX-SNAJ305
O	TUNER (IF)	C	0809 87-A12-087-080		CAP,E 1-50 SMG	LHSM	CX-NSZ300
O	TUNER (IF)	C	0809 87-A12-087-080		CAP,E 1-50 SMG	USM	CX-SNAJ300
O	TUNER (IF)	C	0809 87-A12-087-080		CAP,E 1-50 SMG	USM	CX-SNAJ305
O	TUNER (IF)	C	0809 87-A12-087-080		CAP,E 1-50 SMG	EZSM	CX-NSZ300
O	TUNER (IF)	C	0809 87-A12-087-080	OE	CAP,E 1-50 SMG	USM	CX-SNAJ300
O	TUNER (IF)	C	0809 87-A12-087-080	OE	CAP,E 1-50 SMG	USM	CX-SNAJ305
O	TUNER (IF)	C	0810 87-010-831-080		C-CAP,U 0.1-16 Z F	LHSM	CX-NSZ300
O	TUNER (IF)	C	0810 87-010-831-080		C-CAP,U 0.1-16 Z F	USM	CX-SNAJ300
O	TUNER (IF)	C	0810 87-010-831-080		C-CAP,U 0.1-16 Z F	USM	CX-SNAJ305
O	TUNER (IF)	C	0810 87-010-831-080	OE	C-CAP,U 0.1-16 Z F	USM	CX-SNAJ300
O	TUNER (IF)	C	0810 87-010-831-080	OE	C-CAP,U 0.1-16 Z F	USM	CX-SNAJ305
O	TUNER (IF)	C	0814 87-012-286-080		C-CAP,U 0.01-25 K B	LHSM	CX-NSZ300
O	TUNER (IF)	C	0814 87-012-286-080		C-CAP,U 0.01-25 K B	USM	CX-SNAJ300
O	TUNER (IF)	C	0814 87-012-286-080		C-CAP,U 0.01-25 K B	USM	CX-SNAJ305
O	TUNER (IF)	C	0814 87-012-286-080		C-CAP,U 0.01-25 K B	EZSM	CX-NSZ300
O	TUNER (IF)	C	0814 87-012-286-080	OE	C-CAP,U 0.01-25 K B	USM	CX-SNAJ300
O	TUNER (IF)	C	0814 87-012-286-080	OE	C-CAP,U 0.01-25 K B	USM	CX-SNAJ305
O	TUNER (IF)	C	0815 87-A12-086-080		CAP,E 0.47-50 SMG	LHSM	CX-NSZ300
O	TUNER (IF)	C	0815 87-A12-086-080		CAP,E 0.47-50 SMG	USM	CX-SNAJ300
O	TUNER (IF)	C	0815 87-A12-086-080		CAP,E 0.47-50 SMG	USM	CX-SNAJ305
O	TUNER (IF)	C	0815 87-A12-086-080		CAP,E 0.47-50 SMG	EZSM	CX-NSZ300
O	TUNER (IF)	C	0815 87-A12-086-080	OE	CAP,E 0.47-50 SMG	USM	CX-SNAJ300
O	TUNER (IF)	C	0815 87-A12-086-080	OE	CAP,E 0.47-50 SMG	USM	CX-SNAJ305
O	TUNER (IF)	C	0816 87-A12-086-080		CAP,E 0.47-50 SMG	LHSM	CX-NSZ300
O	TUNER (IF)	C	0816 87-A12-086-080		CAP,E 0.47-50 SMG	USM	CX-SNAJ300
O	TUNER (IF)	C	0816 87-A12-086-080		CAP,E 0.47-50 SMG	USM	CX-SNAJ305
O	TUNER (IF)	C	0816 87-A12-086-080		CAP,E 0.47-50 SMG	EZSM	CX-NSZ300
O	TUNER (IF)	C	0816 87-A12-086-080	OE	CAP,E 0.47-50 SMG	USM	CX-SNAJ300
O	TUNER (IF)	C	0816 87-A12-086-080	OE	CAP,E 0.47-50 SMG	USM	CX-SNAJ305
X	TUNER (IF)	C	0822 88-108-000-080		C-JUMPER,U	LHSM	CX-NSZ300
O	TUNER (IF)	C	0816 87-A12-086-080	OE	CAP,E 0.47-50 SMG	USM	CX-SNAJ300
O	TUNER (IF)	C	0816 87-A12-086-080	OE	CAP,E 0.47-50 SMG	USM	CX-SNAJ305
O	TUNER (IF)	C	0818 87-012-276-080		C-CAP,U 1500P-50 K B	EZSM	CX-NSZ300
O	TUNER (IF)	C	0821 87-A12-091-080		CAP,E 10-50 SMG	LHSM	CX-NSZ300
O	TUNER (IF)	C	0821 87-A12-091-080		CAP,E 10-50 SMG	USM	CX-SNAJ300
O	TUNER (IF)	C	0821 87-A12-091-080		CAP,E 10-50 SMG	USM	CX-SNAJ305
O	TUNER (IF)	C	0821 87-A12-091-080		CAP,E 10-50 SMG	EZSM	CX-NSZ300
O	TUNER (IF)	C	0821 87-A12-091-080	OE	CAP,E 10-50 SMG	USM	CX-SNAJ300
O	TUNER (IF)	C	0821 87-A12-091-080	OE	CAP,E 10-50 SMG	USM	CX-SNAJ305
X	TUNER (IF)	C	0822 88-108-000-080		C-JUMPER,U	LHSM	CX-NSZ300
X	TUNER (IF)	C	0822 88-108-000-080		C-JUMPER,U	USM	CX-SNAJ300
X	TUNER (IF)	C	0822 88-108-000-080		C-JUMPER,U	USM	CX-SNAJ305
X	TUNER (IF)	C	0822 88-108-000-080	OE	C-JUMPER,U	USM	CX-SNAJ300
X	TUNER (IF)	C	0822 88-108-000-080	OE	C-JUMPER,U	USM	CX-SNAJ305
O	TUNER (IF)	C	0823 87-010-177-080	OE	C-CAP,S 820P-50 J SL C2012	USM	CX-SNAJ300
O	TUNER (IF)	C	0823 87-010-177-080	OE	C-CAP,S 820P-50 J SL C2012	USM	CX-SNAJ305
O	TUNER (IF)	C	0823 87-012-349-080		C-CAP,S 1000P-50 J CH GRM	EZSM	CX-NSZ300
O	TUNER (IF)	C	0823 87-A10-978-080		C-CAP,U 820P-25 J CH	LHSM	CX-NSZ300
O	TUNER (IF)	C	0823 87-A10-978-080		C-CAP,U 820P-25 J CH	USM	CX-SNAJ300

PARTS LIST

! = Δ SAFTY PARTS
 C = Components marked

All components used on this model at the production line are shown in this service manual.

However, please note that not all components will be available as spare parts for after-sales service.

Components marked S and O are designated as spare parts for service and will be stocked at the spare parts centers.

Components marked X and R are not designated as spare parts for after sales service, and will not be stocked at the spare parts centers.

K NO. = Only use japanese.

! C	UNIT NAME	REF NO.	PARTS CODE	K NO.	DESCRIPTION	SUFFIX	MODEL NAME
O	TUNER (IF)	C 0823	87-A10-978-080		C-CAP,U 820P-25 J CH	USM	CX-SNAJ305
O	TUNER (IF)	C 0824	87-A12-090-080		CAP,E 4.7-50 SMG	LHSM	CX-NSZ300
O	TUNER (IF)	C 0824	87-A12-090-080		CAP,E 4.7-50 SMG	USM	CX-SNAJ300
O	TUNER (IF)	C 0824	87-A12-090-080		CAP,E 4.7-50 SMG	USM	CX-SNAJ305
O	TUNER (IF)	C 0824	87-A12-090-080		CAP,E 4.7-50 SMG	EZSM	CX-NSZ300
O	TUNER (IF)	C 0824	87-A12-090-080		OE CAP,E 4.7-50 SMG	USM	CX-SNAJ300
O	TUNER (IF)	C 0824	87-A12-090-080		OE CAP,E 4.7-50 SMG	USM	CX-SNAJ305
O	TUNER (IF)	C 0825	87-010-596-080		C-CAP,S 0.047-16 K R C2012	EZSM	CX-NSZ300
O	TUNER (IF)	C 0825	87-010-596-080		OE C-CAP,S 0.047-16 K R C2012	USM	CX-SNAJ300
O	TUNER (IF)	C 0825	87-010-596-080		OE C-CAP,S 0.047-16 K R C2012	USM	CX-SNAJ305
O	TUNER (IF)	C 0825	87-010-829-080		C-CAP,U 0.047-16 Z F	LHSM	CX-NSZ300
O	TUNER (IF)	C 0825	87-010-829-080		C-CAP,U 0.047-16 Z F	USM	CX-SNAJ300
O	TUNER (IF)	C 0825	87-010-829-080		C-CAP,U 0.047-16 Z F	USM	CX-SNAJ305
S	TUNER (IF)	D 0801	87-A40-291-080		DIODE,1N4148M (CPT)	EZSM	CX-NSZ300
X	TUNER (IF)	D 0801	88-100-000-010		PLATING-JW, 0.58 SN95	LHSM	CX-NSZ300
X	TUNER (IF)	D 0801	88-100-000-010		PLATING-JW, 0.58 SN95	USM	CX-SNAJ300
X	TUNER (IF)	D 0801	88-100-000-010		PLATING-JW, 0.58 SN95	USM	CX-SNAJ305
X	TUNER (IF)	D 0801	88-100-000-010		OE PLATING-JW, 0.58 SN95	USM	CX-SNAJ300
X	TUNER (IF)	D 0801	88-100-000-010		OE PLATING-JW, 0.58 SN95	USM	CX-SNAJ305
S	TUNER (IF)	D 0803	87-A40-291-080		DIODE,1N4148M (CPT)	LHSM	CX-NSZ300
S	TUNER (IF)	D 0803	87-A40-291-080		DIODE,1N4148M (CPT)	USM	CX-SNAJ300
S	TUNER (IF)	D 0803	87-A40-291-080		DIODE,1N4148M (CPT)	USM	CX-SNAJ305
S	TUNER (IF)	D 0803	87-A40-291-080		OE DIODE,1N4148M (CPT)	EZSM	CX-NSZ300
S	TUNER (IF)	D 0803	87-A40-291-080		OE DIODE,1N4148M (CPT)	USM	CX-SNAJ300
S	TUNER (IF)	D 0803	87-A40-291-080		OE DIODE,1N4148M (CPT)	USM	CX-SNAJ305
S	TUNER (IF)	IC 0801	87-A21-695-010		IC,LA1845L	LHSM	CX-NSZ300
S	TUNER (IF)	IC 0801	87-A21-695-010		IC,LA1845L	USM	CX-SNAJ300
S	TUNER (IF)	IC 0801	87-A21-695-010		IC,LA1845L	USM	CX-SNAJ305
S	TUNER (IF)	IC 0801	87-A21-695-010		IC,LA1845L	EZSM	CX-NSZ300
S	TUNER (IF)	IC 0801	87-A21-695-010	1C	IC,LA1845L	USM	CX-SNAJ300
S	TUNER (IF)	IC 0801	87-A21-695-010	1C	IC,LA1845L	USM	CX-SNAJ305
X	TUNER (IF)	JR 0781	88-129-000-080		C-JUMPER,3216	LHSM	CX-NSZ300
X	TUNER (IF)	JR 0781	88-129-000-080		C-JUMPER,3216	USM	CX-SNAJ300
X	TUNER (IF)	JR 0781	88-129-000-080		C-JUMPER,3216	USM	CX-SNAJ305
X	TUNER (IF)	JR 0781	88-129-000-080		C-JUMPER,3216	USM	CX-SNAJ300
X	TUNER (IF)	JR 0781	88-129-000-080		OE C-JUMPER,3216	EZSM	CX-NSZ300
X	TUNER (IF)	JR 0781	88-129-000-080		OE C-JUMPER,3216	USM	CX-SNAJ300
X	TUNER (IF)	JR 0781	88-129-000-080		OE C-JUMPER,3216	USM	CX-SNAJ305
X	TUNER (IF)	JR 0785	88-108-000-080		C-JUMPER,U	LHSM	CX-NSZ300
X	TUNER (IF)	JR 0785	88-108-000-080		C-JUMPER,U	USM	CX-SNAJ300
X	TUNER (IF)	JR 0785	88-108-000-080		C-JUMPER,U	USM	CX-SNAJ305
X	TUNER (IF)	JR 0785	88-108-000-080		C-JUMPER,U	USM	CX-NSZ300
X	TUNER (IF)	JR 0785	88-108-000-080		OE C-JUMPER,U	LHSM	CX-SNAJ300
X	TUNER (IF)	JR 0785	88-108-000-080		OE C-JUMPER,U	USM	CX-SNAJ305
X	TUNER (IF)	JR 0785	88-108-000-080		OE C-JUMPER,U	USM	CX-NSZ300
X	TUNER (IF)	JR 0786	88-108-000-080		C-JUMPER,U	LHSM	CX-NSZ300
X	TUNER (IF)	JR 0786	88-108-000-080		C-JUMPER,U	USM	CX-SNAJ300
X	TUNER (IF)	JR 0786	88-108-000-080		C-JUMPER,U	USM	CX-SNAJ305
X	TUNER (IF)	JR 0786	88-108-000-080		C-JUMPER,U	EZSM	CX-NSZ300
X	TUNER (IF)	JR 0786	88-108-000-080		OE C-JUMPER,U	USM	CX-SNAJ300
X	TUNER (IF)	JR 0786	88-108-000-080		OE C-JUMPER,U	USM	CX-SNAJ305
X	TUNER (IF)	JR 0786	88-108-000-080		OE C-JUMPER,U	LHSM	CX-NSZ300
X	TUNER (IF)	JR 0792	88-108-000-080		C-JUMPER,U	USM	CX-SNAJ300
X	TUNER (IF)	JR 0792	88-108-000-080		C-JUMPER,U	USM	CX-SNAJ305
X	TUNER (IF)	JR 0792	88-108-000-080		C-JUMPER,U	EZSM	CX-NSZ300
X	TUNER (IF)	JR 0792	88-108-000-080		OE C-JUMPER,U	USM	CX-SNAJ300
X	TUNER (IF)	JR 0792	88-108-000-080		OE C-JUMPER,U	USM	CX-SNAJ305
X	TUNER (IF)	JR 0795	88-129-000-080		C-JUMPER,3216	LHSM	CX-NSZ300
X	TUNER (IF)	JR 0795	88-129-000-080		C-JUMPER,3216	USM	CX-SNAJ300
X	TUNER (IF)	JR 0795	88-129-000-080		C-JUMPER,3216	USM	CX-SNAJ305
X	TUNER (IF)	JR 0795	88-129-000-080		OE C-JUMPER,3216	EZSM	CX-NSZ300
X	TUNER (IF)	JR 0795	88-129-000-080		OE C-JUMPER,3216	USM	CX-SNAJ300
X	TUNER (IF)	JR 0795	88-129-000-080		OE C-JUMPER,3216	USM	CX-SNAJ305
X	TUNER (IF)	JR 0795	88-129-000-080		OE C-JUMPER,3216	LHSM	CX-NSZ300
X	TUNER (IF)	JR 0797	88-108-000-080		C-JUMPER,U	USM	CX-SNAJ300
X	TUNER (IF)	JR 0797	88-108-000-080		C-JUMPER,U	USM	CX-SNAJ305
X	TUNER (IF)	JR 0797	88-108-000-080		C-JUMPER,U	EZSM	CX-NSZ300
X	TUNER (IF)	JR 0797	88-108-000-080		OE C-JUMPER,U	USM	CX-SNAJ300
X	TUNER (IF)	JR 0797	88-108-000-080		OE C-JUMPER,U	USM	CX-SNAJ305
X	TUNER (IF)	JR 0801	88-108-000-080		C-JUMPER,U	LHSM	CX-NSZ300
X	TUNER (IF)	JR 0801	88-108-000-080		C-JUMPER,U	USM	CX-SNAJ300
X	TUNER (IF)	JR 0801	88-108-000-080		C-JUMPER,U	USM	CX-SNAJ305

PARTS LIST

! = Δ SAFTY PARTS
 C = Components marked

All components used on this model at the production line are shown in this service manual.

However, please note that not all components will be available as spare parts for after-sales service.

Components marked S and O are designated as spare parts for service and will be stocked at the spare parts centers.

Components marked X and R are not designated as spare parts for after sales service, and will not be stocked at the spare parts centers.

K NO. = Only use japanese.

! C	UNIT NAME	REF NO.	PARTS CODE	K NO.	DESCRIPTION	SUFFIX	MODEL NAME
X	TUNER (IF)	JR 0801	88-108-000-080		C-JUMPER,U	EZSM	CX-NSZ300
X	TUNER (IF)	JR 0801	88-108-000-080	OE	C-JUMPER,U	USM	CX-SNAJ300
X	TUNER (IF)	JR 0801	88-108-000-080	OE	C-JUMPER,U	USM	CX-SNAJ305
O	TUNER (IF)	L 0801	87-A50-608-010		COIL, FM DET-N(TOK)	LHSM	CX-NSZ300
O	TUNER (IF)	L 0801	87-A50-608-010		COIL, FM DET-N(TOK)	USM	CX-SNAJ300
O	TUNER (IF)	L 0801	87-A50-608-010		COIL, FM DET-N(TOK)	USM	CX-SNAJ305
O	TUNER (IF)	L 0801	87-A50-608-010		COIL, FM DET-N(TOK)	EZSM	CX-NSZ300
O	TUNER (IF)	L 0801	87-A50-608-010	OE	COIL, FM DET-N(TOK)	USM	CX-SNAJ300
O	TUNER (IF)	L 0801	87-A50-608-010	OE	COIL, FM DET-N(TOK)	USM	CX-SNAJ305
O	TUNER (IF)	L 0802	87-A91-551-010		FLTR, PCFJZH-450 L(TOK)	LHSM	CX-NSZ300
O	TUNER (IF)	L 0802	87-A91-551-010		FLTR, PCFJZH-450 L(TOK)	USM	CX-SNAJ300
O	TUNER (IF)	L 0802	87-A91-551-010		FLTR, PCFJZH-450 L(TOK)	USM	CX-SNAJ305
O	TUNER (IF)	L 0802	87-A91-551-010	1A	FLTR, PCFJZH-450 L(TOK)	EZSM	CX-NSZ300
O	TUNER (IF)	L 0802	87-A91-551-010	1A	FLTR, PCFJZH-450 L(TOK)	USM	CX-SNAJ300
O	TUNER (IF)	L 0811	87-005-847-080		COIL, 2.2UH K CECS	LHSM	CX-NSZ300
O	TUNER (IF)	L 0811	87-005-847-080		COIL, 2.2UH K CECS	USM	CX-SNAJ300
O	TUNER (IF)	L 0811	87-005-847-080		COIL, 2.2UH K CECS	USM	CX-SNAJ305
O	TUNER (IF)	L 0811	87-005-847-080		COIL, 2.2UH K CECS	EZSM	CX-NSZ300
O	TUNER (IF)	L 0811	87-005-847-080	OE	COIL, 2.2UH K CECS	USM	CX-SNAJ300
O	TUNER (IF)	L 0811	87-005-847-080	OE	COIL, 2.2UH K CECS	USM	CX-SNAJ305
X	TUNER (IF)	R 0789	88-108-473-080		C-RES,U 47K-1/16W J	EZSM	CX-NSZ300
O	TUNER (IF)	R 0790	87-012-286-080		C-CAP,U 0.01-25 K B	LHSM	CX-NSZ300
O	TUNER (IF)	R 0790	87-012-286-080		C-CAP,U 0.01-25 K B	USM	CX-SNAJ300
O	TUNER (IF)	R 0790	87-012-286-080		C-CAP,U 0.01-25 K B	USM	CX-SNAJ305
O	TUNER (IF)	R 0790	87-012-286-080		C-CAP,U 0.01-25 K B	EZSM	CX-NSZ300
O	TUNER (IF)	R 0790	87-012-286-080	OE	C-CAP,U 0.01-25 K B	USM	CX-SNAJ300
O	TUNER (IF)	R 0790	87-012-286-080	OE	C-CAP,U 0.01-25 K B	USM	CX-SNAJ305
X	TUNER (IF)	R 0791	88-108-102-080		C-RES,U 1K-1/16W J	LHSM	CX-NSZ300
X	TUNER (IF)	R 0791	88-108-102-080		C-RES,U 1K-1/16W J	USM	CX-SNAJ300
X	TUNER (IF)	R 0791	88-108-102-080		C-RES,U 1K-1/16W J	USM	CX-SNAJ305
X	TUNER (IF)	R 0791	88-108-102-080	OE	C-RES,U 1K-1/16W J	USM	CX-SNAJ300
X	TUNER (IF)	R 0791	88-108-102-080	OE	C-RES,U 1K-1/16W J	USM	CX-SNAJ305
X	TUNER (IF)	R 0793	88-108-000-080		C-JUMPER,U	LHSM	CX-NSZ300
X	TUNER (IF)	R 0793	88-108-000-080		C-JUMPER,U	USM	CX-SNAJ300
X	TUNER (IF)	R 0793	88-108-000-080		C-JUMPER,U	USM	CX-SNAJ305
X	TUNER (IF)	R 0793	88-108-000-080	OE	C-JUMPER,U	USM	CX-SNAJ300
X	TUNER (IF)	R 0793	88-108-000-080	OE	C-JUMPER,U	USM	CX-SNAJ305
X	TUNER (IF)	R 0793	88-108-221-080		C-RES,U 220-1/16W J	EZSM	CX-NSZ300
X	TUNER (IF)	R 0795	88-108-000-080		C-JUMPER,U	LHSM	CX-NSZ300
X	TUNER (IF)	R 0795	88-108-000-080		C-JUMPER,U	USM	CX-SNAJ300
X	TUNER (IF)	R 0795	88-108-000-080		C-JUMPER,U	USM	CX-SNAJ305
X	TUNER (IF)	R 0795	88-108-000-080		C-JUMPER,U	EZSM	CX-NSZ300
X	TUNER (IF)	R 0795	88-108-000-080	OE	C-JUMPER,U	USM	CX-SNAJ300
X	TUNER (IF)	R 0795	88-108-000-080	OE	C-JUMPER,U	USM	CX-SNAJ305
X	TUNER (IF)	R 0801	88-108-103-080		C-RES,U 10K-1/16W J	LHSM	CX-NSZ300
X	TUNER (IF)	R 0801	88-108-103-080		C-RES,U 10K-1/16W J	USM	CX-SNAJ300
X	TUNER (IF)	R 0801	88-108-103-080		C-RES,U 10K-1/16W J	USM	CX-SNAJ305
X	TUNER (IF)	R 0801	88-108-103-080		C-RES,U 10K-1/16W J	EZSM	CX-NSZ300
X	TUNER (IF)	R 0801	88-108-103-080	OE	C-RES,U 10K-1/16W J	USM	CX-SNAJ300
X	TUNER (IF)	R 0801	88-108-103-080	OE	C-RES,U 10K-1/16W J	USM	CX-SNAJ305
X	TUNER (IF)	R 0802	88-108-223-080		C-RES,U 22K-1/16W J	LHSM	CX-NSZ300
X	TUNER (IF)	R 0802	88-108-223-080		C-RES,U 22K-1/16W J	USM	CX-SNAJ300
X	TUNER (IF)	R 0802	88-108-223-080		C-RES,U 22K-1/16W J	USM	CX-SNAJ305
X	TUNER (IF)	R 0802	88-108-223-080		C-RES,U 22K-1/16W J	EZSM	CX-NSZ300
X	TUNER (IF)	R 0802	88-108-223-080	OE	C-RES,U 22K-1/16W J	USM	CX-SNAJ300
X	TUNER (IF)	R 0802	88-108-223-080	OE	C-RES,U 22K-1/16W J	USM	CX-SNAJ305
X	TUNER (IF)	R 0803	88-128-183-080		C-RES, 18K-1/8W J	LHSM	CX-NSZ300
X	TUNER (IF)	R 0803	88-128-183-080		C-RES, 18K-1/8W J	USM	CX-SNAJ300
X	TUNER (IF)	R 0803	88-128-183-080		C-RES, 18K-1/8W J	USM	CX-SNAJ305
X	TUNER (IF)	R 0803	88-128-183-080	OE	C-RES, 18K-1/8W J	USM	CX-NSZ300
X	TUNER (IF)	R 0803	88-128-183-080	OE	C-RES, 18K-1/8W J	USM	CX-SNAJ300
X	TUNER (IF)	R 0804	88-108-000-080		C-JUMPER,U	LHSM	CX-NSZ300
X	TUNER (IF)	R 0804	88-108-000-080		C-JUMPER,U	USM	CX-SNAJ300
X	TUNER (IF)	R 0804	88-108-000-080		C-JUMPER,U	USM	CX-SNAJ305
X	TUNER (IF)	R 0804	88-108-000-080		C-JUMPER,U	EZSM	CX-NSZ300
X	TUNER (IF)	R 0804	88-108-000-080	OE	C-JUMPER,U	USM	CX-SNAJ300
X	TUNER (IF)	R 0804	88-108-000-080	OE	C-JUMPER,U	USM	CX-SNAJ305

PARTS LIST

! = Δ SAFTY PARTS
 C = Components marked

All components used on this model at the production line are shown in this service manual.

However, please note that not all components will be available as spare parts for after-sales service.

Components marked S and O are designated as spare parts for service and will be stocked at the spare parts centers.

Components marked X and R are not designated as spare parts for after sales service, and will not be stocked at the spare parts centers.

K NO. = Only use japanese.

! C	UNIT NAME	REF NO.	PARTS CODE	K NO.	DESCRIPTION	SUFFIX	MODEL NAME
X	TUNER (IF)	R	0805 88-108-332-080		C-RES,U 3.3K-1/16W J	LHSM	CX-NSZ300
X	TUNER (IF)	R	0805 88-108-332-080		C-RES,U 3.3K-1/16W J	USM	CX-SNAJ300
X	TUNER (IF)	R	0805 88-108-332-080		C-RES,U 3.3K-1/16W J	USM	CX-SNAJ305
X	TUNER (IF)	R	0805 88-108-332-080		C-RES,U 3.3K-1/16W J	EZSM	CX-NSZ300
X	TUNER (IF)	R	0805 88-108-332-080	OE	C-RES,U 3.3K-1/16W J	USM	CX-SNAJ300
X	TUNER (IF)	R	0805 88-108-332-080	OE	C-RES,U 3.3K-1/16W J	USM	CX-SNAJ305
X	TUNER (IF)	R	0806 88-108-682-080		C-RES,U 6.8K-1/16W J	LHSM	CX-NSZ300
X	TUNER (IF)	R	0806 88-108-682-080		C-RES,U 6.8K-1/16W J	USM	CX-SNAJ300
X	TUNER (IF)	R	0806 88-108-682-080		C-RES,U 6.8K-1/16W J	USM	CX-SNAJ305
X	TUNER (IF)	R	0806 88-108-682-080		C-RES,U 6.8K-1/16W J	EZSM	CX-NSZ300
X	TUNER (IF)	R	0806 88-108-682-080	OE	C-RES,U 6.8K-1/16W J	USM	CX-SNAJ300
X	TUNER (IF)	R	0806 88-108-682-080	OE	C-RES,U 6.8K-1/16W J	USM	CX-SNAJ305
X	TUNER (IF)	R	0809 88-108-102-080		C-RES,U 1K-1/16W J	LHSM	CX-NSZ300
X	TUNER (IF)	R	0809 88-108-102-080		C-RES,U 1K-1/16W J	USM	CX-SNAJ300
X	TUNER (IF)	R	0809 88-108-102-080		C-RES,U 1K-1/16W J	USM	CX-SNAJ305
X	TUNER (IF)	R	0809 88-108-102-080		C-RES,U 1K-1/16W J	EZSM	CX-NSZ300
X	TUNER (IF)	R	0809 88-108-102-080	OE	C-RES,U 1K-1/16W J	USM	CX-SNAJ300
X	TUNER (IF)	R	0809 88-108-102-080	OE	C-RES,U 1K-1/16W J	USM	CX-SNAJ305
X	TUNER (IF)	R	0810 88-108-102-080		C-RES,U 1K-1/16W J	LHSM	CX-NSZ300
X	TUNER (IF)	R	0810 88-108-102-080		C-RES,U 1K-1/16W J	USM	CX-SNAJ300
X	TUNER (IF)	R	0810 88-108-102-080		C-RES,U 1K-1/16W J	USM	CX-SNAJ305
X	TUNER (IF)	R	0810 88-108-102-080		C-RES,U 1K-1/16W J	EZSM	CX-NSZ300
X	TUNER (IF)	R	0810 88-108-102-080	OE	C-RES,U 1K-1/16W J	USM	CX-SNAJ300
X	TUNER (IF)	R	0810 88-108-102-080	OE	C-RES,U 1K-1/16W J	USM	CX-SNAJ305
X	TUNER (IF)	R	0811 88-108-000-080		C-JUMPER,U	LHSM	CX-NSZ300
X	TUNER (IF)	R	0811 88-108-000-080		C-JUMPER,U	USM	CX-SNAJ300
X	TUNER (IF)	R	0811 88-108-000-080		C-JUMPER,U	USM	CX-SNAJ305
X	TUNER (IF)	R	0811 88-108-000-080		C-JUMPER,U	EZSM	CX-NSZ300
X	TUNER (IF)	R	0811 88-108-000-080	OE	C-JUMPER,U	USM	CX-SNAJ300
X	TUNER (IF)	R	0811 88-108-000-080	OE	C-JUMPER,U	USM	CX-SNAJ305
X	TUNER (IF)	R	0812 88-108-000-080		C-JUMPER,U	LHSM	CX-NSZ300
X	TUNER (IF)	R	0812 88-108-000-080		C-JUMPER,U	USM	CX-SNAJ300
X	TUNER (IF)	R	0812 88-108-000-080		C-JUMPER,U	USM	CX-SNAJ305
X	TUNER (IF)	R	0812 88-108-000-080		C-JUMPER,U	EZSM	CX-NSZ300
X	TUNER (IF)	R	0812 88-108-000-080	OE	C-JUMPER,U	USM	CX-SNAJ300
X	TUNER (IF)	R	0812 88-108-000-080	OE	C-JUMPER,U	USM	CX-SNAJ305
X	TUNER (IF)	R	0813 88-108-224-080		C-RES,U 220K-1/16W J	LHSM	CX-NSZ300
X	TUNER (IF)	R	0813 88-108-224-080		C-RES,U 220K-1/16W J	USM	CX-SNAJ300
X	TUNER (IF)	R	0813 88-108-224-080		C-RES,U 220K-1/16W J	USM	CX-SNAJ305
X	TUNER (IF)	R	0813 88-108-224-080		C-RES,U 220K-1/16W J	EZSM	CX-NSZ300
X	TUNER (IF)	R	0813 88-108-224-080	OE	C-RES,U 220K-1/16W J	USM	CX-SNAJ300
X	TUNER (IF)	R	0813 88-108-224-080	OE	C-RES,U 220K-1/16W J	USM	CX-SNAJ305
X	TUNER (IF)	R	0814 88-108-105-080		C-RES,U 1M-1/16W J	LHSM	CX-NSZ300
X	TUNER (IF)	R	0814 88-108-105-080		C-RES,U 1M-1/16W J	USM	CX-SNAJ300
X	TUNER (IF)	R	0814 88-108-105-080		C-RES,U 1M-1/16W J	USM	CX-SNAJ305
X	TUNER (IF)	R	0814 88-108-105-080		C-RES,U 1M-1/16W J	EZSM	CX-NSZ300
X	TUNER (IF)	R	0814 88-108-105-080	OE	C-RES,U 1M-1/16W J	USM	CX-SNAJ300
X	TUNER (IF)	R	0814 88-108-105-080	OE	C-RES,U 1M-1/16W J	USM	CX-SNAJ305
X	TUNER (IF)	R	0814 88-108-222-080		C-RES,U 2.2K-1/16W J	EZSM	CX-NSZ300
X	TUNER (IF)	R	0815 88-121-682-080		RES,6.8K-1/8W J	LHSM	CX-NSZ300
X	TUNER (IF)	R	0815 88-121-682-080		RES,6.8K-1/8W J	USM	CX-SNAJ300
X	TUNER (IF)	R	0815 88-121-682-080		RES,6.8K-1/8W J	EZSM	CX-NSZ300
X	TUNER (IF)	R	0815 88-121-682-080	OE	RES,6.8K-1/8W J	USM	CX-SNAJ300
X	TUNER (IF)	R	0815 88-121-682-080	OE	RES,6.8K-1/8W J	USM	CX-SNAJ305
X	TUNER (IF)	R	0818 88-108-103-080		C-RES,U 10K-1/16W J	LHSM	CX-NSZ300
X	TUNER (IF)	R	0818 88-108-103-080		C-RES,U 10K-1/16W J	USM	CX-SNAJ300
X	TUNER (IF)	R	0818 88-108-103-080		C-RES,U 10K-1/16W J	USM	CX-SNAJ305
X	TUNER (IF)	R	0818 88-108-103-080		C-RES,U 10K-1/16W J	EZSM	CX-NSZ300
X	TUNER (IF)	R	0818 88-108-103-080	OE	C-RES,U 10K-1/16W J	USM	CX-SNAJ300
X	TUNER (IF)	R	0818 88-108-103-080	OE	C-RES,U 10K-1/16W J	USM	CX-SNAJ305
X	TUNER (IF)	R	0821 88-108-000-080		C-JUMPER,U	LHSM	CX-NSZ300
X	TUNER (IF)	R	0821 88-108-000-080		C-JUMPER,U	USM	CX-SNAJ300
X	TUNER (IF)	R	0821 88-108-000-080		C-JUMPER,U	USM	CX-SNAJ305
X	TUNER (IF)	R	0821 88-108-000-080		C-JUMPER,U	EZSM	CX-NSZ300
X	TUNER (IF)	R	0821 88-108-000-080	OE	C-JUMPER,U	USM	CX-SNAJ300
X	TUNER (IF)	R	0821 88-108-000-080	OE	C-JUMPER,U	USM	CX-SNAJ305
X	TUNER (IF)	R	0823 88-108-333-080		C-RES,U 33K-1/16W J	LHSM	CX-NSZ300
X	TUNER (IF)	R	0823 88-108-333-080		C-RES,U 33K-1/16W J	USM	CX-SNAJ300
X	TUNER (IF)	R	0823 88-108-333-080		C-RES,U 33K-1/16W J	USM	CX-SNAJ305
X	TUNER (IF)	R	0823 88-108-333-080		C-RES,U 33K-1/16W J	EZSM	CX-NSZ300
X	TUNER (IF)	R	0823 88-108-333-080	OE	C-RES,U 33K-1/16W J	USM	CX-SNAJ300

PARTS LIST

! = Δ SAFTY PARTS
 C = Components marked

All components used on this model at the production line are shown in this service manual.

However, please note that not all components will be available as spare parts for after-sales service.

Components marked S and O are designated as spare parts for service and will be stocked at the spare parts centers.

Components marked X and R are not designated as spare parts for after sales service, and will not be stocked at the spare parts centers.

K NO. = Only use japanese.

! C	UNIT NAME	REF NO.	PARTS CODE	K NO.	DESCRIPTION	SUFFIX	MODEL NAME	
X	TUNER (IF)	R	0823	88-108-333-080	OE	C-RES,U 33K-1/16W J	USM	CX-SNAJ305
X	TUNER (IF)	R	0823	88-108-473-080		C-RES,U 47K-1/16W J	EZSM	CX-NSZ300
X	TUNER (IF)	R	0824	88-108-102-080		C-RES,U 1K-1/16W J	LHSM	CX-NSZ300
X	TUNER (IF)	R	0824	88-108-102-080		C-RES,U 1K-1/16W J	USM	CX-SNAJ300
X	TUNER (IF)	R	0824	88-108-102-080		C-RES,U 1K-1/16W J	USM	CX-SNAJ305
X	TUNER (IF)	R	0824	88-108-102-080	OE	C-RES,U 1K-1/16W J	USM	CX-SNAJ300
X	TUNER (IF)	R	0824	88-108-102-080	OE	C-RES,U 1K-1/16W J	USM	CX-SNAJ305
X	TUNER (IF)	R	0825	88-108-473-080		C-RES,U 47K-1/16W J	LHSM	CX-NSZ300
X	TUNER (IF)	R	0825	88-108-473-080		C-RES,U 47K-1/16W J	USM	CX-SNAJ300
X	TUNER (IF)	R	0825	88-108-473-080		C-RES,U 47K-1/16W J	USM	CX-SNAJ305
X	TUNER (IF)	R	0825	88-108-473-080	OE	C-RES,U 47K-1/16W J	USM	CX-SNAJ300
X	TUNER (IF)	R	0825	88-108-473-080	OE	C-RES,U 47K-1/16W J	USM	CX-SNAJ305
X	TUNER (IF)	R	0826	88-108-223-080		C-RES,U 22K-1/16W J	LHSM	CX-NSZ300
X	TUNER (IF)	R	0826	88-108-223-080		C-RES,U 22K-1/16W J	USM	CX-SNAJ300
X	TUNER (IF)	R	0826	88-108-223-080		C-RES,U 22K-1/16W J	USM	CX-SNAJ305
X	TUNER (IF)	R	0826	88-108-223-080	OE	C-RES,U 22K-1/16W J	EZSM	CX-NSZ300
X	TUNER (IF)	R	0826	88-108-223-080	OE	C-RES,U 22K-1/16W J	USM	CX-SNAJ300
X	TUNER (IF)	R	0826	88-108-223-080	OE	C-RES,U 22K-1/16W J	USM	CX-SNAJ305
O	TUNER (PLL)	C	0971	87-A12-067-080		CAP,E 330-16 SMG	LHSM	CX-NSZ300
O	TUNER (PLL)	C	0971	87-A12-067-080		CAP,E 330-16 SMG	USM	CX-SNAJ300
O	TUNER (PLL)	C	0971	87-A12-067-080		CAP,E 330-16 SMG	USM	CX-SNAJ305
O	TUNER (PLL)	C	0971	87-A12-067-080	OE	CAP,E 330-16 SMG	USM	CX-NSZ300
O	TUNER (PLL)	C	0971	87-A12-067-080	OE	CAP,E 330-16 SMG	USM	CX-SNAJ305
O	TUNER (PLL)	C	0972	87-A12-090-080		CAP,E 4.7-50 SMG	LHSM	CX-NSZ300
O	TUNER (PLL)	C	0972	87-A12-090-080		CAP,E 4.7-50 SMG	USM	CX-SNAJ300
O	TUNER (PLL)	C	0972	87-A12-090-080		CAP,E 4.7-50 SMG	USM	CX-SNAJ305
O	TUNER (PLL)	C	0972	87-A12-090-080		CAP,E 4.7-50 SMG	EZSM	CX-NSZ300
O	TUNER (PLL)	C	0972	87-A12-090-080	OE	CAP,E 4.7-50 SMG	USM	CX-SNAJ300
O	TUNER (PLL)	C	0972	87-A12-090-080	OE	CAP,E 4.7-50 SMG	USM	CX-SNAJ305
O	TUNER (PLL)	C	0973	87-012-286-080		C-CAP,U 0.01-25 K B	LHSM	CX-NSZ300
O	TUNER (PLL)	C	0973	87-012-286-080		C-CAP,U 0.01-25 K B	USM	CX-SNAJ300
O	TUNER (PLL)	C	0973	87-012-286-080		C-CAP,U 0.01-25 K B	USM	CX-SNAJ305
O	TUNER (PLL)	C	0973	87-012-286-080		C-CAP,U 0.01-25 K B	EZSM	CX-NSZ300
O	TUNER (PLL)	C	0973	87-012-286-080	OE	C-CAP,U 0.01-25 K B	USM	CX-SNAJ300
O	TUNER (PLL)	C	0973	87-012-286-080	OE	C-CAP,U 0.01-25 K B	USM	CX-SNAJ305
O	TUNER (PLL)	C	0974	87-012-286-080		C-CAP,U 0.01-25 K B	LHSM	CX-NSZ300
O	TUNER (PLL)	C	0974	87-012-286-080		C-CAP,U 0.01-25 K B	USM	CX-SNAJ300
O	TUNER (PLL)	C	0974	87-012-286-080		C-CAP,U 0.01-25 K B	USM	CX-SNAJ305
O	TUNER (PLL)	C	0974	87-012-286-080		C-CAP,U 0.01-25 K B	EZSM	CX-NSZ300
O	TUNER (PLL)	C	0974	87-012-286-080	OE	C-CAP,U 0.01-25 K B	USM	CX-SNAJ300
O	TUNER (PLL)	C	0974	87-012-286-080	OE	C-CAP,U 0.01-25 K B	USM	CX-SNAJ305
O	TUNER (PLL)	C	0979	87-012-195-080		C-CAP,U 100P-50 J CH	LHSM	CX-NSZ300
O	TUNER (PLL)	C	0979	87-012-195-080		C-CAP,U 100P-50 J CH	USM	CX-SNAJ300
O	TUNER (PLL)	C	0979	87-012-195-080		C-CAP,U 100P-50 J CH	USM	CX-SNAJ305
O	TUNER (PLL)	C	0979	87-012-195-080		C-CAP,U 100P-50 J CH	EZSM	CX-NSZ300
O	TUNER (PLL)	C	0979	87-012-195-080	OE	C-CAP,U 100P-50 J CH	USM	CX-SNAJ300
O	TUNER (PLL)	C	0979	87-012-195-080	OE	C-CAP,U 100P-50 J CH	USM	CX-SNAJ305
O	TUNER (PLL)	C	0981	87-A12-071-080		CAP,E 47-25 SMG	LHSM	CX-NSZ300
O	TUNER (PLL)	C	0981	87-A12-071-080		CAP,E 47-25 SMG	USM	CX-SNAJ300
O	TUNER (PLL)	C	0981	87-A12-071-080		CAP,E 47-25 SMG	USM	CX-SNAJ305
O	TUNER (PLL)	C	0981	87-A12-071-080	OE	CAP,E 47-25 SMG	USM	CX-NSZ300
O	TUNER (PLL)	C	0981	87-A12-071-080	OE	CAP,E 47-25 SMG	USM	CX-SNAJ305
O	TUNER (PLL)	C	0982	87-010-831-080		C-CAP,U 0.1-16 Z F	LHSM	CX-NSZ300
O	TUNER (PLL)	C	0982	87-010-831-080		C-CAP,U 0.1-16 Z F	USM	CX-SNAJ300
O	TUNER (PLL)	C	0982	87-010-831-080		C-CAP,U 0.1-16 Z F	USM	CX-SNAJ305
O	TUNER (PLL)	C	0982	87-010-831-080		C-CAP,U 0.1-16 Z F	EZSM	CX-NSZ300
O	TUNER (PLL)	C	0982	87-010-831-080	OE	C-CAP,U 0.1-16 Z F	USM	CX-SNAJ300
O	TUNER (PLL)	C	0982	87-010-831-080	OE	C-CAP,U 0.1-16 Z F	USM	CX-SNAJ305
O	TUNER (PLL)	C	0983	87-012-286-080		C-CAP,U 0.01-25 K B	LHSM	CX-NSZ300
O	TUNER (PLL)	C	0983	87-012-286-080		C-CAP,U 0.01-25 K B	USM	CX-SNAJ300
O	TUNER (PLL)	C	0983	87-012-286-080		C-CAP,U 0.01-25 K B	USM	CX-SNAJ305
O	TUNER (PLL)	C	0983	87-012-286-080		C-CAP,U 0.01-25 K B	EZSM	CX-NSZ300
O	TUNER (PLL)	C	0983	87-012-286-080	OE	C-CAP,U 0.01-25 K B	USM	CX-SNAJ300
O	TUNER (PLL)	C	0983	87-012-286-080	OE	C-CAP,U 0.01-25 K B	USM	CX-SNAJ305
O	TUNER (PLL)	C	0984	87-012-286-080		C-CAP,U 0.01-25 K B	LHSM	CX-NSZ300
O	TUNER (PLL)	C	0984	87-012-286-080		C-CAP,U 0.01-25 K B	USM	CX-SNAJ300
O	TUNER (PLL)	C	0984	87-012-286-080		C-CAP,U 0.01-25 K B	USM	CX-SNAJ305
O	TUNER (PLL)	C	0984	87-012-286-080		C-CAP,U 0.01-25 K B	EZSM	CX-NSZ300

PARTS LIST

! = Δ SAFTY PARTS
 C = Components marked

All components used on this model at the production line are shown in this service manual.

However, please note that not all components will be available as spare parts for after-sales service.

Components marked S and O are designated as spare parts for service and will be stocked at the spare parts centers.

Components marked X and R are not designated as spare parts for after sales service, and will not be stocked at the spare parts centers.

K NO. = Only use japanese.

! C	UNIT NAME	REF NO.	PARTS CODE	K NO.	DESCRIPTION	SUFFIX	MODEL NAME
O	TUNER (PLL)	C	0984 87-012-286-080	OE	C-CAP,U 0.01-25 K B	USM	CX-SNAJ300
O	TUNER (PLL)	C	0984 87-012-286-080	OE	C-CAP,U 0.01-25 K B	USM	CX-SNAJ305
O	TUNER (PLL)	C	0985 87-012-195-080		C-CAP,U 100P-50 J CH	EZSM	CX-NSZ300
O	TUNER (PLL)	C	0987 87-012-286-080		C-CAP,U 0.01-25 K B	LHSM	CX-NSZ300
O	TUNER (PLL)	C	0987 87-012-286-080		C-CAP,U 0.01-25 K B	USM	CX-SNAJ300
O	TUNER (PLL)	C	0987 87-012-286-080		C-CAP,U 0.01-25 K B	USM	CX-SNAJ305
O	TUNER (PLL)	C	0987 87-012-286-080		C-CAP,U 0.01-25 K B	EZSM	CX-NSZ300
O	TUNER (PLL)	C	0987 87-012-286-080	OE	C-CAP,U 0.01-25 K B	USM	CX-SNAJ300
O	TUNER (PLL)	C	0987 87-012-286-080	OE	C-CAP,U 0.01-25 K B	USM	CX-SNAJ305
O	TUNER (PLL)	C	0989 87-012-286-080		C-CAP,U 0.01-25 K B	EZSM	CX-NSZ300
O	TUNER (PLL)	C	0991 87-012-176-080		C-CAP,U 15P-50 J CH	LHSM	CX-NSZ300
O	TUNER (PLL)	C	0991 87-012-176-080		C-CAP,U 15P-50 J CH	USM	CX-SNAJ300
O	TUNER (PLL)	C	0991 87-012-176-080		C-CAP,U 15P-50 J CH	USM	CX-SNAJ305
O	TUNER (PLL)	C	0991 87-012-176-080		C-CAP,U 15P-50 J CH	EZSM	CX-NSZ300
O	TUNER (PLL)	C	0991 87-012-176-080	OE	C-CAP,U 15P-50 J CH	USM	CX-SNAJ300
O	TUNER (PLL)	C	0991 87-012-176-080	OE	C-CAP,U 15P-50 J CH	USM	CX-SNAJ305
O	TUNER (PLL)	C	0992 87-012-176-080		C-CAP,U 15P-50 J CH	LHSM	CX-NSZ300
O	TUNER (PLL)	C	0992 87-012-176-080		C-CAP,U 15P-50 J CH	USM	CX-SNAJ300
O	TUNER (PLL)	C	0992 87-012-176-080		C-CAP,U 15P-50 J CH	USM	CX-SNAJ305
O	TUNER (PLL)	C	0992 87-012-176-080		C-CAP,U 15P-50 J CH	EZSM	CX-NSZ300
O	TUNER (PLL)	C	0992 87-012-176-080	OE	C-CAP,U 15P-50 J CH	USM	CX-SNAJ300
O	TUNER (PLL)	C	0992 87-012-176-080	OE	C-CAP,U 15P-50 J CH	USM	CX-SNAJ305
O	TUNER (PLL)	C	0993 87-012-274-080		C-CAP,U 1000P-50 K B	LHSM	CX-NSZ300
O	TUNER (PLL)	C	0993 87-012-274-080		C-CAP,U 1000P-50 K B	USM	CX-SNAJ300
O	TUNER (PLL)	C	0993 87-012-274-080		C-CAP,U 1000P-50 K B	USM	CX-SNAJ305
O	TUNER (PLL)	C	0993 87-012-274-080		C-CAP,U 1000P-50 K B	EZSM	CX-NSZ300
O	TUNER (PLL)	C	0993 87-012-274-080	OE	C-CAP,U 1000P-50 K B	USM	CX-SNAJ300
O	TUNER (PLL)	C	0993 87-012-274-080	OE	C-CAP,U 1000P-50 K B	USM	CX-SNAJ305
O	TUNER (PLL)	C	0995 87-012-274-080		C-CAP,U 1000P-50 K B	LHSM	CX-NSZ300
O	TUNER (PLL)	C	0995 87-012-274-080		C-CAP,U 1000P-50 K B	USM	CX-SNAJ300
O	TUNER (PLL)	C	0995 87-012-274-080		C-CAP,U 1000P-50 K B	USM	CX-SNAJ305
O	TUNER (PLL)	C	0995 87-012-274-080	OE	C-CAP,U 1000P-50 K B	USM	CX-SNAJ300
O	TUNER (PLL)	C	0995 87-012-274-080	OE	C-CAP,U 1000P-50 K B	USM	CX-SNAJ305
O	TUNER (PLL)	C	0997 87-010-831-080		C-CAP,U 0.1-16 Z F	LHSM	CX-NSZ300
O	TUNER (PLL)	C	0997 87-010-831-080		C-CAP,U 0.1-16 Z F	USM	CX-SNAJ300
O	TUNER (PLL)	C	0997 87-010-831-080		C-CAP,U 0.1-16 Z F	USM	CX-SNAJ305
O	TUNER (PLL)	C	0997 87-010-831-080		C-CAP,U 0.1-16 Z F	EZSM	CX-NSZ300
O	TUNER (PLL)	C	0997 87-010-831-080	OE	C-CAP,U 0.1-16 Z F	USM	CX-SNAJ300
O	TUNER (PLL)	C	0997 87-010-831-080	OE	C-CAP,U 0.1-16 Z F	USM	CX-SNAJ305
O	TUNER (PLL)	C	0998 87-A12-071-080		CAP,E 47-25 SMG	LHSM	CX-NSZ300
O	TUNER (PLL)	C	0998 87-A12-071-080		CAP,E 47-25 SMG	USM	CX-SNAJ300
O	TUNER (PLL)	C	0998 87-A12-071-080		CAP,E 47-25 SMG	USM	CX-SNAJ305
O	TUNER (PLL)	C	0998 87-A12-071-080		CAP,E 47-25 SMG	EZSM	CX-NSZ300
O	TUNER (PLL)	C	0998 87-A12-071-080	OE	CAP,E 47-25 SMG	USM	CX-SNAJ300
O	TUNER (PLL)	C	0998 87-A12-071-080	OE	CAP,E 47-25 SMG	USM	CX-SNAJ305
O	TUNER (PLL)	C	0999 87-A11-155-080		CAP,TC U 0.01-16 Z F	LHSM	CX-NSZ300
O	TUNER (PLL)	C	0999 87-A11-155-080		CAP,TC U 0.01-16 Z F	USM	CX-SNAJ300
O	TUNER (PLL)	C	0999 87-A11-155-080		CAP,TC U 0.01-16 Z F	USM	CX-SNAJ305
O	TUNER (PLL)	C	0999 87-A11-155-080		CAP,TC U 0.01-16 Z F	EZSM	CX-NSZ300
O	TUNER (PLL)	C	0999 87-A11-155-080	OE	CAP,TC U 0.01-16 Z F	USM	CX-SNAJ300
O	TUNER (PLL)	C	0999 87-A11-155-080	OE	CAP,TC U 0.01-16 Z F	USM	CX-SNAJ305
S	TUNER (PLL)	D	0804 87-A40-291-080		DIODE,1N4148M (CPT)	LHSM	CX-NSZ300
S	TUNER (PLL)	D	0804 87-A40-291-080		DIODE,1N4148M (CPT)	USM	CX-SNAJ300
S	TUNER (PLL)	D	0804 87-A40-291-080		DIODE,1N4148M (CPT)	USM	CX-SNAJ305
S	TUNER (PLL)	D	0991 87-017-149-080		ZENER,HZS6A2L	LHSM	CX-NSZ300
S	TUNER (PLL)	D	0991 87-017-149-080		ZENER,HZS6A2L	USM	CX-SNAJ300
S	TUNER (PLL)	D	0991 87-017-149-080		ZENER,HZS6A2L	USM	CX-SNAJ305
S	TUNER (PLL)	D	0991 87-017-149-080		ZENER,HZS6A2L	EZSM	CX-NSZ300
S	TUNER (PLL)	D	0991 87-017-149-080	OE	ZENER,HZS6A2L	USM	CX-SNAJ300
S	TUNER (PLL)	D	0991 87-017-149-080	OE	ZENER,HZS6A2L	USM	CX-SNAJ305
S	TUNER (PLL)	D	0992 87-A40-291-080		DIODE,1N4148M (CPT)	EZSM	CX-NSZ300
S	TUNER (PLL)	D	0994 87-A40-291-080		DIODE,1N4148M (CPT)	EZSM	CX-NSZ300
S	TUNER (PLL)	D	0994 87-A40-291-080		DIODE,1N4148M (CPT)	USM	CX-SNAJ300
S	TUNER (PLL)	D	0994 87-A40-291-080	OE	DIODE,1N4148M (CPT)	USM	CX-SNAJ305
S	TUNER (PLL)	IC	0991 87-070-127-110		IC,LC72131D	LHSM	CX-NSZ300
S	TUNER (PLL)	IC	0991 87-070-127-110		IC,LC72131D	USM	CX-SNAJ300
S	TUNER (PLL)	IC	0991 87-070-127-110		IC,LC72131D	USM	CX-SNAJ305
S	TUNER (PLL)	IC	0991 87-070-127-110	1C	IC,LC72131D	USM	CX-SNAJ300
S	TUNER (PLL)	IC	0991 87-070-127-110	1C	IC,LC72131D	USM	CX-SNAJ305

PARTS LIST

! = Δ SAFTY PARTS
 C = Components marked

All components used on this model at the production line are shown in this service manual.

However, please note that not all components will be available as spare parts for after-sales service.

Components marked S and O are designated as spare parts for service and will be stocked at the spare parts centers.

Components marked X and R are not designated as spare parts for after sales service, and will not be stocked at the spare parts centers.

K NO. = Only use japanese.

! C	UNIT NAME	REF NO.	PARTS CODE	K NO.	DESCRIPTION	SUFFIX	MODEL NAME
S	TUNER (PLL)	IC 0991	87-A21-928-010		IC,LC72131D-N	EZSM	CX-NSZ300
X	TUNER (PLL)	JR 0971	88-129-000-080		C-JUMPER, 3216	LHSM	CX-NSZ300
X	TUNER (PLL)	JR 0971	88-129-000-080		C-JUMPER, 3216	USM	CX-SNAJ300
X	TUNER (PLL)	JR 0971	88-129-000-080		C-JUMPER, 3216	USM	CX-SNAJ305
X	TUNER (PLL)	JR 0971	88-129-000-080		C-JUMPER, 3216	EZSM	CX-NSZ300
X	TUNER (PLL)	JR 0971	88-129-000-080	OE	C-JUMPER, 3216	USM	CX-SNAJ300
X	TUNER (PLL)	JR 0971	88-129-000-080	OE	C-JUMPER, 3216	USM	CX-SNAJ305
X	TUNER (PLL)	JR 0972	88-108-000-080		C-JUMPER, U	LHSM	CX-NSZ300
X	TUNER (PLL)	JR 0972	88-108-000-080		C-JUMPER, U	USM	CX-SNAJ300
X	TUNER (PLL)	JR 0972	88-108-000-080		C-JUMPER, U	USM	CX-SNAJ305
X	TUNER (PLL)	JR 0972	88-108-000-080		C-JUMPER, U	USM	CX-NSZ300
X	TUNER (PLL)	JR 0972	88-108-000-080	OE	C-JUMPER, U	USM	CX-SNAJ300
X	TUNER (PLL)	JR 0972	88-108-000-080	OE	C-JUMPER, U	USM	CX-SNAJ305
X	TUNER (PLL)	JR 0973	88-129-000-080		C-JUMPER, 3216	LHSM	CX-NSZ300
X	TUNER (PLL)	JR 0973	88-129-000-080		C-JUMPER, 3216	USM	CX-SNAJ300
X	TUNER (PLL)	JR 0973	88-129-000-080		C-JUMPER, 3216	USM	CX-SNAJ305
X	TUNER (PLL)	JR 0973	88-129-000-080		C-JUMPER, 3216	EZSM	CX-NSZ300
X	TUNER (PLL)	JR 0973	88-129-000-080	OE	C-JUMPER, 3216	USM	CX-SNAJ300
X	TUNER (PLL)	JR 0973	88-129-000-080	OE	C-JUMPER, 3216	USM	CX-SNAJ305
X	TUNER (PLL)	JR 0974	88-108-000-080		C-JUMPER, U	LHSM	CX-NSZ300
X	TUNER (PLL)	JR 0974	88-108-000-080		C-JUMPER, U	USM	CX-SNAJ300
X	TUNER (PLL)	JR 0974	88-108-000-080	OE	C-JUMPER, U	USM	CX-SNAJ305
X	TUNER (PLL)	JR 0974	88-108-000-080	OE	C-JUMPER, U	USM	CX-NSZ300
X	TUNER (PLL)	JR 0974	88-108-000-080	OE	C-JUMPER, U	USM	CX-SNAJ300
X	TUNER (PLL)	JR 0974	88-108-000-080	OE	C-JUMPER, U	USM	CX-SNAJ305
X	TUNER (PLL)	JR 0976	88-108-000-080		C-JUMPER, U	LHSM	CX-NSZ300
X	TUNER (PLL)	JR 0976	88-108-000-080		C-JUMPER, U	USM	CX-SNAJ300
X	TUNER (PLL)	JR 0976	88-108-000-080		C-JUMPER, U	USM	CX-SNAJ305
X	TUNER (PLL)	JR 0976	88-108-000-080		C-JUMPER, U	EZSM	CX-NSZ300
X	TUNER (PLL)	JR 0976	88-108-000-080	OE	C-JUMPER, U	USM	CX-SNAJ300
X	TUNER (PLL)	JR 0976	88-108-000-080	OE	C-JUMPER, U	USM	CX-SNAJ305
X	TUNER (PLL)	JR 0976	88-108-000-080	OE	C-JUMPER, U	USM	CX-NSZ300
X	TUNER (PLL)	JR 0977	88-108-000-080		C-JUMPER, U	LHSM	CX-NSZ300
X	TUNER (PLL)	JR 0977	88-108-000-080		C-JUMPER, U	USM	CX-SNAJ300
X	TUNER (PLL)	JR 0977	88-108-000-080		C-JUMPER, U	USM	CX-SNAJ305
X	TUNER (PLL)	JR 0977	88-108-000-080		C-JUMPER, U	USM	CX-NSZ300
X	TUNER (PLL)	JR 0977	88-108-000-080	OE	C-JUMPER, U	USM	CX-SNAJ300
X	TUNER (PLL)	JR 0977	88-108-000-080	OE	C-JUMPER, U	USM	CX-SNAJ305
X	TUNER (PLL)	JR 0988	88-108-000-080		C-JUMPER, U	LHSM	CX-NSZ300
X	TUNER (PLL)	JR 0988	88-108-000-080		C-JUMPER, U	USM	CX-SNAJ300
X	TUNER (PLL)	JR 0988	88-108-000-080		C-JUMPER, U	USM	CX-SNAJ305
X	TUNER (PLL)	JR 0988	88-108-000-080		C-JUMPER, U	EZSM	CX-NSZ300
X	TUNER (PLL)	JR 0988	88-108-000-080	OE	C-JUMPER, U	USM	CX-SNAJ300
X	TUNER (PLL)	JR 0988	88-108-000-080	OE	C-JUMPER, U	USM	CX-SNAJ305
X	TUNER (PLL)	JR 0991	88-108-000-080		C-JUMPER, U	LHSM	CX-NSZ300
X	TUNER (PLL)	JR 0991	88-108-000-080		C-JUMPER, U	USM	CX-SNAJ300
X	TUNER (PLL)	JR 0991	88-108-000-080		C-JUMPER, U	USM	CX-SNAJ305
X	TUNER (PLL)	JR 0991	88-108-000-080		C-JUMPER, U	EZSM	CX-NSZ300
X	TUNER (PLL)	JR 0991	88-108-000-080	OE	C-JUMPER, U	USM	CX-SNAJ300
X	TUNER (PLL)	JR 0991	88-108-000-080	OE	C-JUMPER, U	USM	CX-SNAJ305
S	TUNER (PLL)	Q 0981	87-A30-234-080		TR,CSC4115BC	LHSM	CX-NSZ300
S	TUNER (PLL)	Q 0981	87-A30-234-080		TR,CSC4115BC	USM	CX-SNAJ300
S	TUNER (PLL)	Q 0981	87-A30-234-080		TR,CSC4115BC	USM	CX-SNAJ305
S	TUNER (PLL)	Q 0981	87-A30-234-080		TR,CSC4115BC	EZSM	CX-NSZ300
S	TUNER (PLL)	Q 0981	87-A30-234-080	OE	TR,CSC4115BC	USM	CX-SNAJ300
S	TUNER (PLL)	Q 0981	87-A30-234-080	OE	TR,CSC4115BC	USM	CX-SNAJ305
X	TUNER (PLL)	R 0973	88-108-102-080		C-RES,U 1K-1/16W J	EZSM	CX-NSZ300
X	TUNER (PLL)	R 0975	88-108-562-080		C-RES,U 5.6K-1/16W J	LHSM	CX-NSZ300
X	TUNER (PLL)	R 0975	88-108-562-080		C-RES,U 5.6K-1/16W J	USM	CX-SNAJ300
X	TUNER (PLL)	R 0975	88-108-562-080		C-RES,U 5.6K-1/16W J	USM	CX-SNAJ305
X	TUNER (PLL)	R 0975	88-108-562-080		C-RES,U 5.6K-1/16W J	EZSM	CX-NSZ300
X	TUNER (PLL)	R 0975	88-108-562-080	OE	C-RES,U 5.6K-1/16W J	USM	CX-SNAJ300
X	TUNER (PLL)	R 0975	88-108-562-080	OE	C-RES,U 5.6K-1/16W J	USM	CX-SNAJ305
X	TUNER (PLL)	R 0976	88-108-102-080		C-RES,U 1K-1/16W J	LHSM	CX-NSZ300
X	TUNER (PLL)	R 0976	88-108-102-080		C-RES,U 1K-1/16W J	USM	CX-SNAJ300
X	TUNER (PLL)	R 0976	88-108-102-080		C-RES,U 1K-1/16W J	USM	CX-SNAJ305
X	TUNER (PLL)	R 0976	88-108-102-080		C-RES,U 1K-1/16W J	EZSM	CX-NSZ300
X	TUNER (PLL)	R 0976	88-108-102-080	OE	C-RES,U 1K-1/16W J	USM	CX-SNAJ300
X	TUNER (PLL)	R 0976	88-108-102-080	OE	C-RES,U 1K-1/16W J	USM	CX-SNAJ305
X	TUNER (PLL)	R 0977	88-108-102-080		C-RES,U 1K-1/16W J	LHSM	CX-NSZ300
X	TUNER (PLL)	R 0977	88-108-102-080		C-RES,U 1K-1/16W J	USM	CX-SNAJ300

PARTS LIST

! = Δ SAFTY PARTS
 C = Components marked

All components used on this model at the production line are shown in this service manual.

However, please note that not all components will be available as spare parts for after-sales service.

Components marked S and O are designated as spare parts for service and will be stocked at the spare parts centers.

Components marked X and R are not designated as spare parts for after sales service, and will not be stocked at the spare parts centers.

K NO. = Only use japanese.

! C	UNIT NAME	REF NO.	PARTS CODE	K NO.	DESCRIPTION	SUFFIX	MODEL NAME
X	TUNER (PLL)	R	0977 88-108-102-080		C-RES,U 1K-1/16W J	USM	CX-SNAJ305
X	TUNER (PLL)	R	0977 88-108-102-080		C-RES,U 1K-1/16W J	EZSM	CX-NSZ300
X	TUNER (PLL)	R	0977 88-108-102-080	OE	C-RES,U 1K-1/16W J	USM	CX-SNAJ300
X	TUNER (PLL)	R	0977 88-108-102-080	OE	C-RES,U 1K-1/16W J	USM	CX-SNAJ305
X	TUNER (PLL)	R	0978 88-108-681-080		C-RES,U 680-1/16W J	LHSM	CX-NSZ300
X	TUNER (PLL)	R	0978 88-108-681-080		C-RES,U 680-1/16W J	USM	CX-SNAJ300
X	TUNER (PLL)	R	0978 88-108-681-080		C-RES,U 680-1/16W J	USM	CX-SNAJ305
X	TUNER (PLL)	R	0978 88-108-681-080		C-RES,U 680-1/16W J	EZSM	CX-NSZ300
X	TUNER (PLL)	R	0978 88-108-681-080	OE	C-RES,U 680-1/16W J	USM	CX-SNAJ300
X	TUNER (PLL)	R	0978 88-108-681-080	OE	C-RES,U 680-1/16W J	USM	CX-SNAJ305
X	TUNER (PLL)	R	0980 88-108-684-080		C-RES,U 680K-1/16W J	LHSM	CX-NSZ300
X	TUNER (PLL)	R	0980 88-108-684-080		C-RES,U 680K-1/16W J	USM	CX-SNAJ300
X	TUNER (PLL)	R	0980 88-108-684-080		C-RES,U 680K-1/16W J	USM	CX-SNAJ305
X	TUNER (PLL)	R	0980 88-108-684-080		C-RES,U 680K-1/16W J	EZSM	CX-NSZ300
X	TUNER (PLL)	R	0980 88-108-684-080	OE	C-RES,U 680K-1/16W J	USM	CX-SNAJ300
X	TUNER (PLL)	R	0980 88-108-684-080	OE	C-RES,U 680K-1/16W J	USM	CX-SNAJ305
X	TUNER (PLL)	R	0981 88-121-471-080		RES,470-1/8W J	LHSM	CX-NSZ300
X	TUNER (PLL)	R	0981 88-121-471-080		RES,470-1/8W J	USM	CX-SNAJ300
X	TUNER (PLL)	R	0981 88-121-471-080		RES,470-1/8W J	USM	CX-SNAJ305
X	TUNER (PLL)	R	0981 88-121-471-080		RES,470-1/8W J	EZSM	CX-NSZ300
X	TUNER (PLL)	R	0981 88-121-471-080	OE	RES,470-1/8W J	USM	CX-SNAJ300
X	TUNER (PLL)	R	0981 88-121-471-080	OE	RES,470-1/8W J	USM	CX-SNAJ305
X	TUNER (PLL)	R	0982 88-108-103-080		C-RES,U 10K-1/16W J	EZSM	CX-NSZ300
X	TUNER (PLL)	R	0982 88-108-822-080		C-RES,U 8.2K-1/16W J	LHSM	CX-NSZ300
X	TUNER (PLL)	R	0982 88-108-822-080		C-RES,U 8.2K-1/16W J	USM	CX-SNAJ300
X	TUNER (PLL)	R	0982 88-108-822-080		C-RES,U 8.2K-1/16W J	USM	CX-SNAJ305
X	TUNER (PLL)	R	0982 88-108-822-080	OE	C-RES,U 8.2K-1/16W J	USM	CX-SNAJ300
X	TUNER (PLL)	R	0982 88-108-822-080	OE	C-RES,U 8.2K-1/16W J	USM	CX-SNAJ305
X	TUNER (PLL)	R	0983 88-108-101-080		C-RES,U 100-1/16W J	LHSM	CX-NSZ300
X	TUNER (PLL)	R	0983 88-108-101-080		C-RES,U 100-1/16W J	USM	CX-SNAJ300
X	TUNER (PLL)	R	0983 88-108-101-080		C-RES,U 100-1/16W J	USM	CX-SNAJ305
X	TUNER (PLL)	R	0983 88-108-101-080	OE	C-RES,U 100-1/16W J	EZSM	CX-NSZ300
X	TUNER (PLL)	R	0983 88-108-101-080	OE	C-RES,U 100-1/16W J	USM	CX-SNAJ300
X	TUNER (PLL)	R	0983 88-108-101-080	OE	C-RES,U 100-1/16W J	USM	CX-SNAJ305
X	TUNER (PLL)	R	0984 88-121-181-080		RES,180-1/8W J	LHSM	CX-NSZ300
X	TUNER (PLL)	R	0984 88-121-181-080		RES,180-1/8W J	USM	CX-SNAJ300
X	TUNER (PLL)	R	0984 88-121-181-080		RES,180-1/8W J	USM	CX-SNAJ305
X	TUNER (PLL)	R	0984 88-121-181-080		RES,180-1/8W J	EZSM	CX-NSZ300
X	TUNER (PLL)	R	0984 88-121-181-080	OE	RES,180-1/8W J	USM	CX-SNAJ300
X	TUNER (PLL)	R	0984 88-121-181-080	OE	RES,180-1/8W J	USM	CX-SNAJ305
X	TUNER (PLL)	R	0985 88-121-471-080		RES,470-1/8W J	LHSM	CX-NSZ300
X	TUNER (PLL)	R	0985 88-121-471-080		RES,470-1/8W J	USM	CX-SNAJ300
X	TUNER (PLL)	R	0985 88-121-471-080		RES,470-1/8W J	USM	CX-SNAJ305
X	TUNER (PLL)	R	0985 88-121-471-080		RES,470-1/8W J	EZSM	CX-NSZ300
X	TUNER (PLL)	R	0985 88-121-471-080	OE	RES,470-1/8W J	USM	CX-SNAJ300
X	TUNER (PLL)	R	0985 88-121-471-080	OE	RES,470-1/8W J	USM	CX-SNAJ305
X	TUNER (PLL)	R	0986 88-108-222-080		C-RES,U 2.2K-1/16W J	LHSM	CX-NSZ300
X	TUNER (PLL)	R	0986 88-108-222-080		C-RES,U 2.2K-1/16W J	USM	CX-SNAJ300
X	TUNER (PLL)	R	0986 88-108-222-080		C-RES,U 2.2K-1/16W J	USM	CX-SNAJ305
X	TUNER (PLL)	R	0986 88-108-222-080		C-RES,U 2.2K-1/16W J	EZSM	CX-NSZ300
X	TUNER (PLL)	R	0986 88-108-222-080	OE	C-RES,U 2.2K-1/16W J	USM	CX-SNAJ300
X	TUNER (PLL)	R	0986 88-108-222-080	OE	C-RES,U 2.2K-1/16W J	USM	CX-SNAJ305
X	TUNER (PLL)	R	0987 88-121-472-080		RES,4.7K-1/8W J	LHSM	CX-NSZ300
X	TUNER (PLL)	R	0987 88-121-472-080		RES,4.7K-1/8W J	USM	CX-SNAJ300
X	TUNER (PLL)	R	0987 88-121-472-080		RES,4.7K-1/8W J	USM	CX-SNAJ305
X	TUNER (PLL)	R	0987 88-121-472-080		RES,4.7K-1/8W J	EZSM	CX-NSZ300
X	TUNER (PLL)	R	0987 88-121-472-080	OE	RES,4.7K-1/8W J	USM	CX-SNAJ300
X	TUNER (PLL)	R	0987 88-121-472-080	OE	RES,4.7K-1/8W J	USM	CX-SNAJ305
X	TUNER (PLL)	R	0988 88-108-103-080		C-RES,U 10K-1/16W J	LHSM	CX-NSZ300
X	TUNER (PLL)	R	0988 88-108-103-080		C-RES,U 10K-1/16W J	USM	CX-SNAJ300
X	TUNER (PLL)	R	0988 88-108-103-080		C-RES,U 10K-1/16W J	USM	CX-SNAJ305
X	TUNER (PLL)	R	0988 88-108-103-080	OE	C-RES,U 10K-1/16W J	EZSM	CX-NSZ300
X	TUNER (PLL)	R	0988 88-108-103-080	OE	C-RES,U 10K-1/16W J	USM	CX-SNAJ300
X	TUNER (PLL)	R	0989 88-121-102-080		RES,1K-1/8W J	LHSM	CX-NSZ300
X	TUNER (PLL)	R	0989 88-121-102-080		RES,1K-1/8W J	USM	CX-SNAJ300
X	TUNER (PLL)	R	0989 88-121-102-080		RES,1K-1/8W J	USM	CX-SNAJ305
X	TUNER (PLL)	R	0989 88-121-102-080		RES,1K-1/8W J	EZSM	CX-NSZ300
X	TUNER (PLL)	R	0989 88-121-102-080	OE	RES,1K-1/8W J	USM	CX-SNAJ300
X	TUNER (PLL)	R	0989 88-121-102-080	OE	RES,1K-1/8W J	USM	CX-SNAJ305

PARTS LIST

! = Δ SAFTY PARTS
 C = Components marked

All components used on this model at the production line are shown in this service manual.

However, please note that not all components will be available as spare parts for after-sales service.

Components marked S and O are designated as spare parts for service and will be stocked at the spare parts centers.

Components marked X and R are not designated as spare parts for after sales service, and will not be stocked at the spare parts centers.

K NO. = Only use japanese.

! C	UNIT NAME	REF NO.	PARTS CODE	K NO.	DESCRIPTION	SUFFIX	MODEL NAME
X	TUNER (PLL)	R	0990 88-108-563-080		C-RES,U 56K-1/16W J	LHSM	CX-NSZ300
X	TUNER (PLL)	R	0990 88-108-563-080		C-RES,U 56K-1/16W J	USM	CX-SNAJ300
X	TUNER (PLL)	R	0990 88-108-563-080		C-RES,U 56K-1/16W J	USM	CX-SNAJ305
X	TUNER (PLL)	R	0990 88-108-563-080		C-RES,U 56K-1/16W J	EZSM	CX-NSZ300
X	TUNER (PLL)	R	0990 88-108-563-080	OE	C-RES,U 56K-1/16W J	USM	CX-SNAJ300
X	TUNER (PLL)	R	0990 88-108-563-080	OE	C-RES,U 56K-1/16W J	USM	CX-SNAJ305
O	TUNER (PLL)	R	0991 87-012-195-080		C-CAP,U 100P-50 J CH	LHSM	CX-NSZ300
O	TUNER (PLL)	R	0991 87-012-195-080		C-CAP,U 100P-50 J CH	USM	CX-SNAJ300
O	TUNER (PLL)	R	0991 87-012-195-080		C-CAP,U 100P-50 J CH	USM	CX-SNAJ305
O	TUNER (PLL)	R	0991 87-012-195-080		C-CAP,U 100P-50 J CH	EZSM	CX-NSZ300
O	TUNER (PLL)	R	0991 87-012-195-080	OE	C-CAP,U 100P-50 J CH	USM	CX-SNAJ300
O	TUNER (PLL)	R	0991 87-012-195-080	OE	C-CAP,U 100P-50 J CH	USM	CX-SNAJ305
X	TUNER (PLL)	R	0992 88-108-103-080		C-RES,U 10K-1/16W J	LHSM	CX-NSZ300
X	TUNER (PLL)	R	0992 88-108-103-080		C-RES,U 10K-1/16W J	USM	CX-SNAJ300
X	TUNER (PLL)	R	0992 88-108-103-080		C-RES,U 10K-1/16W J	USM	CX-SNAJ305
X	TUNER (PLL)	R	0992 88-108-103-080		C-RES,U 10K-1/16W J	EZSM	CX-NSZ300
X	TUNER (PLL)	R	0992 88-108-103-080	OE	C-RES,U 10K-1/16W J	USM	CX-SNAJ300
X	TUNER (PLL)	R	0992 88-108-103-080	OE	C-RES,U 10K-1/16W J	USM	CX-SNAJ305
O	TUNER (PLL)	R	0993 87-012-195-080		C-CAP,U 100P-50 J CH	LHSM	CX-NSZ300
O	TUNER (PLL)	R	0993 87-012-195-080		C-CAP,U 100P-50 J CH	USM	CX-SNAJ300
O	TUNER (PLL)	R	0993 87-012-195-080		C-CAP,U 100P-50 J CH	USM	CX-SNAJ305
O	TUNER (PLL)	R	0993 87-012-195-080		C-CAP,U 100P-50 J CH	EZSM	CX-NSZ300
O	TUNER (PLL)	R	0993 87-012-195-080	OE	C-CAP,U 100P-50 J CH	USM	CX-SNAJ300
O	TUNER (PLL)	R	0993 87-012-195-080	OE	C-CAP,U 100P-50 J CH	USM	CX-SNAJ305
X	TUNER (PLL)	R	0994 88-108-103-080		C-RES,U 10K-1/16W J	LHSM	CX-NSZ300
X	TUNER (PLL)	R	0994 88-108-103-080		C-RES,U 10K-1/16W J	USM	CX-SNAJ300
X	TUNER (PLL)	R	0994 88-108-103-080		C-RES,U 10K-1/16W J	USM	CX-SNAJ305
X	TUNER (PLL)	R	0994 88-108-103-080		C-RES,U 10K-1/16W J	EZSM	CX-NSZ300
X	TUNER (PLL)	R	0994 88-108-103-080	OE	C-RES,U 10K-1/16W J	USM	CX-SNAJ300
X	TUNER (PLL)	R	0994 88-108-103-080	OE	C-RES,U 10K-1/16W J	USM	CX-SNAJ305
O	TUNER (PLL)	R	0995 87-012-195-080		C-CAP,U 100P-50 J CH	LHSM	CX-NSZ300
O	TUNER (PLL)	R	0995 87-012-195-080		C-CAP,U 100P-50 J CH	USM	CX-SNAJ300
O	TUNER (PLL)	R	0995 87-012-195-080		C-CAP,U 100P-50 J CH	USM	CX-SNAJ305
O	TUNER (PLL)	R	0995 87-012-195-080		C-CAP,U 100P-50 J CH	EZSM	CX-NSZ300
O	TUNER (PLL)	R	0995 87-012-195-080	OE	C-CAP,U 100P-50 J CH	USM	CX-SNAJ300
O	TUNER (PLL)	R	0995 87-012-195-080	OE	C-CAP,U 100P-50 J CH	USM	CX-SNAJ305
X	TUNER (PLL)	R	0996 88-108-103-080		C-RES,U 10K-1/16W J	LHSM	CX-NSZ300
X	TUNER (PLL)	R	0996 88-108-103-080		C-RES,U 10K-1/16W J	USM	CX-SNAJ300
X	TUNER (PLL)	R	0996 88-108-103-080		C-RES,U 10K-1/16W J	USM	CX-SNAJ305
X	TUNER (PLL)	R	0996 88-108-103-080		C-RES,U 10K-1/16W J	EZSM	CX-NSZ300
X	TUNER (PLL)	R	0996 88-108-103-080	OE	C-RES,U 10K-1/16W J	USM	CX-SNAJ300
X	TUNER (PLL)	R	0996 88-108-103-080	OE	C-RES,U 10K-1/16W J	USM	CX-SNAJ305
X	TUNER (PLL)	R	0997 88-108-154-080		C-RES,U 150K-1/16W J	LHSM	CX-NSZ300
X	TUNER (PLL)	R	0997 88-108-154-080		C-RES,U 150K-1/16W J	USM	CX-SNAJ300
X	TUNER (PLL)	R	0997 88-108-154-080		C-RES,U 150K-1/16W J	USM	CX-SNAJ305
X	TUNER (PLL)	R	0997 88-108-154-080		C-RES,U 150K-1/16W J	EZSM	CX-NSZ300
X	TUNER (PLL)	R	0997 88-108-154-080	OE	C-RES,U 150K-1/16W J	USM	CX-SNAJ300
X	TUNER (PLL)	R	0997 88-108-154-080	OE	C-RES,U 150K-1/16W J	USM	CX-SNAJ305
X	TUNER (PLL)	R	0998 88-108-102-080		C-RES,U 1K-1/16W J	LHSM	CX-NSZ300
X	TUNER (PLL)	R	0998 88-108-102-080		C-RES,U 1K-1/16W J	USM	CX-SNAJ300
X	TUNER (PLL)	R	0998 88-108-102-080		C-RES,U 1K-1/16W J	USM	CX-SNAJ305
X	TUNER (PLL)	R	0998 88-108-102-080	OE	C-RES,U 1K-1/16W J	USM	CX-NSZ300
X	TUNER (PLL)	R	0999 88-108-103-080		C-RES,U 10K-1/16W J	LHSM	CX-NSZ300
X	TUNER (PLL)	R	0999 88-108-103-080		C-RES,U 10K-1/16W J	USM	CX-SNAJ300
X	TUNER (PLL)	R	0999 88-108-103-080		C-RES,U 10K-1/16W J	USM	CX-SNAJ305
X	TUNER (PLL)	R	0999 88-108-103-080		C-RES,U 10K-1/16W J	EZSM	CX-NSZ300
X	TUNER (PLL)	R	0999 88-108-103-080	OE	C-RES,U 10K-1/16W J	USM	CX-SNAJ300
X	TUNER (PLL)	R	0999 88-108-103-080	OE	C-RES,U 10K-1/16W J	USM	CX-SNAJ305
O	TUNER (PLL)	X	0991 87-A70-306-010		VIB,XTAL 4.500MHZ CSA-309ST	LHSM	CX-NSZ300
O	TUNER (PLL)	X	0991 87-A70-306-010		VIB,XTAL 4.500MHZ CSA-309ST	USM	CX-SNAJ300
O	TUNER (PLL)	X	0991 87-A70-306-010		VIB,XTAL 4.500MHZ CSA-309ST	USM	CX-SNAJ305
O	TUNER (PLL)	X	0992 87-A70-306-010		VIB,XTAL 4.500MHZ CSA-309ST	EZSM	CX-NSZ300
O	TUNER (PLL)	X	0992 87-A70-306-010	1A	VIB,XTAL 4.500MHZ CSA-309ST	USM	CX-SNAJ300
O	TUNER (PLL)	X	0992 87-A70-306-010	1A	VIB,XTAL 4.500MHZ CSA-309ST	USM	CX-SNAJ305
X	TUNER (RDS)	JR	0871 88-108-000-080		C-JUMPER,U	LHSM	CX-NSZ300
X	TUNER (RDS)	JR	0871 88-108-000-080		C-JUMPER,U	USM	CX-SNAJ300
X	TUNER (RDS)	JR	0871 88-108-000-080		C-JUMPER,U	USM	CX-SNAJ305
X	TUNER (RDS)	JR	0871 88-108-000-080		C-JUMPER,U	EZSM	CX-NSZ300

PARTS LIST

! = Δ SAFTY PARTS
 C = Components marked

All components used on this model at the production line are shown in this service manual.

However, please note that not all components will be available as spare parts for after-sales service.

Components marked S and O are designated as spare parts for service and will be stocked at the spare parts centers.

Components marked X and R are not designated as spare parts for after sales service, and will not be stocked at the spare parts centers.

K NO. = Only use japanese.

! C	UNIT NAME	REF NO.	PARTS CODE	K NO.	DESCRIPTION	SUFFIX	MODEL NAME
X	TUNER (RDS)	JR 0871	88-108-000-080	0E	C-JUMPER,U	USM	CX-SNAJ300
X	TUNER (RDS)	JR 0871	88-108-000-080	0E	C-JUMPER,U	USM	CX-SNAJ305
X	TUNER (RDS)	JR 0873	88-108-000-080		C-JUMPER,U	EZSM	CX-NSZ300
X	TUNER (RDS)	JR 0873	88-108-000-080	0E	C-JUMPER,U	USM	CX-SNAJ300
X	TUNER (RDS)	JR 0873	88-108-000-080	0E	C-JUMPER,U	USM	CX-SNAJ305
O	TUNER (RF)	C 0831	87-A12-092-080		CAP,E 22-50 SMG	EZSM	CX-NSZ300
O	TUNER (RF)	C 0842	87-012-286-080		C-CAP,U 0.01-25 K B	LHSM	CX-NSZ300
O	TUNER (RF)	C 0842	87-012-286-080		C-CAP,U 0.01-25 K B	USM	CX-SNAJ300
O	TUNER (RF)	C 0842	87-012-286-080		C-CAP,U 0.01-25 K B	USM	CX-SNAJ305
O	TUNER (RF)	C 0842	87-012-286-080		C-CAP,U 0.01-25 K B	EZSM	CX-NSZ300
O	TUNER (RF)	C 0842	87-012-286-080	0E	C-CAP,U 0.01-25 K B	USM	CX-SNAJ300
O	TUNER (RF)	C 0842	87-012-286-080	0E	C-CAP,U 0.01-25 K B	USM	CX-SNAJ305
X	TUNER (RF)	C 0843	88-108-000-080		C-JUMPER,U	LHSM	CX-NSZ300
X	TUNER (RF)	C 0843	88-108-000-080		C-JUMPER,U	USM	CX-SNAJ300
X	TUNER (RF)	C 0843	88-108-000-080		C-JUMPER,U	USM	CX-SNAJ305
X	TUNER (RF)	C 0843	88-108-000-080		C-JUMPER,U	EZSM	CX-NSZ300
X	TUNER (RF)	C 0843	88-108-000-080	0E	C-JUMPER,U	USM	CX-SNAJ300
X	TUNER (RF)	C 0843	88-108-000-080	0E	C-JUMPER,U	USM	CX-SNAJ305
O	TUNER (RF)	C 0844	87-012-286-080		C-CAP,U 0.01-25 K B	LHSM	CX-NSZ300
O	TUNER (RF)	C 0844	87-012-286-080		C-CAP,U 0.01-25 K B	USM	CX-SNAJ300
O	TUNER (RF)	C 0844	87-012-286-080		C-CAP,U 0.01-25 K B	USM	CX-SNAJ305
O	TUNER (RF)	C 0844	87-012-286-080		C-CAP,U 0.01-25 K B	EZSM	CX-NSZ300
O	TUNER (RF)	C 0844	87-012-286-080	0E	C-CAP,U 0.01-25 K B	USM	CX-SNAJ300
O	TUNER (RF)	C 0844	87-012-286-080	0E	C-CAP,U 0.01-25 K B	USM	CX-SNAJ305
X	TUNER (RF)	C 0845	88-108-000-080		C-JUMPER,U	LHSM	CX-NSZ300
X	TUNER (RF)	C 0845	88-108-000-080		C-JUMPER,U	USM	CX-SNAJ300
X	TUNER (RF)	C 0845	88-108-000-080		C-JUMPER,U	USM	CX-SNAJ305
X	TUNER (RF)	C 0845	88-108-000-080		C-JUMPER,U	EZSM	CX-NSZ300
X	TUNER (RF)	C 0845	88-108-000-080	0E	C-JUMPER,U	USM	CX-SNAJ300
X	TUNER (RF)	C 0845	88-108-000-080	0E	C-JUMPER,U	USM	CX-SNAJ305
X	TUNER (RF)	C 0846	88-108-000-080		C-JUMPER,U	LHSM	CX-NSZ300
X	TUNER (RF)	C 0846	88-108-000-080		C-JUMPER,U	USM	CX-SNAJ300
X	TUNER (RF)	C 0846	88-108-000-080		C-JUMPER,U	USM	CX-SNAJ305
X	TUNER (RF)	C 0846	88-108-000-080		C-JUMPER,U	EZSM	CX-NSZ300
X	TUNER (RF)	C 0846	88-108-000-080	0E	C-JUMPER,U	USM	CX-SNAJ300
X	TUNER (RF)	C 0846	88-108-000-080	0E	C-JUMPER,U	USM	CX-SNAJ305
X	TUNER (RF)	C 0847	88-108-000-080		C-JUMPER,U	LHSM	CX-NSZ300
X	TUNER (RF)	C 0847	88-108-000-080		C-JUMPER,U	USM	CX-SNAJ300
X	TUNER (RF)	C 0847	88-108-000-080		C-JUMPER,U	USM	CX-SNAJ305
X	TUNER (RF)	C 0847	88-108-000-080		C-JUMPER,U	EZSM	CX-NSZ300
X	TUNER (RF)	C 0847	88-108-000-080	0E	C-JUMPER,U	USM	CX-SNAJ300
X	TUNER (RF)	C 0847	88-108-000-080	0E	C-JUMPER,U	USM	CX-SNAJ305
X	TUNER (RF)	C 0848	88-108-000-080		C-JUMPER,U	LHSM	CX-NSZ300
X	TUNER (RF)	C 0848	88-108-000-080		C-JUMPER,U	USM	CX-SNAJ300
X	TUNER (RF)	C 0848	88-108-000-080		C-JUMPER,U	USM	CX-SNAJ305
X	TUNER (RF)	C 0848	88-108-000-080		C-JUMPER,U	EZSM	CX-NSZ300
X	TUNER (RF)	C 0848	88-108-000-080	0E	C-JUMPER,U	USM	CX-SNAJ300
X	TUNER (RF)	C 0848	88-108-000-080	0E	C-JUMPER,U	USM	CX-SNAJ305
X	TUNER (RF)	C 0849	88-108-000-080		C-JUMPER,U	LHSM	CX-NSZ300
X	TUNER (RF)	C 0849	88-108-000-080		C-JUMPER,U	USM	CX-SNAJ300
X	TUNER (RF)	C 0849	88-108-000-080		C-JUMPER,U	USM	CX-SNAJ305
X	TUNER (RF)	C 0849	88-108-000-080	0E	C-JUMPER,U	USM	CX-SNAJ300
O	TUNER (RF)	C 0850	87-A12-071-080		CAP,E 47-25 SMG	LHSM	CX-NSZ300
O	TUNER (RF)	C 0850	87-A12-071-080		CAP,E 47-25 SMG	USM	CX-SNAJ300
O	TUNER (RF)	C 0850	87-A12-071-080		CAP,E 47-25 SMG	USM	CX-SNAJ305
O	TUNER (RF)	C 0850	87-A12-071-080		CAP,E 47-25 SMG	EZSM	CX-NSZ300
O	TUNER (RF)	C 0850	87-A12-071-080	0E	CAP,E 47-25 SMG	USM	CX-SNAJ300
O	TUNER (RF)	C 0850	87-A12-071-080	0E	CAP,E 47-25 SMG	USM	CX-SNAJ305
O	TUNER (RF)	C 0851	87-012-286-080		C-CAP,U 0.01-25 K B	LHSM	CX-NSZ300
O	TUNER (RF)	C 0851	87-012-286-080		C-CAP,U 0.01-25 K B	USM	CX-SNAJ300
O	TUNER (RF)	C 0851	87-012-286-080		C-CAP,U 0.01-25 K B	USM	CX-SNAJ305
O	TUNER (RF)	C 0851	87-012-286-080		C-CAP,U 0.01-25 K B	EZSM	CX-NSZ300
O	TUNER (RF)	C 0851	87-012-286-080	0E	C-CAP,U 0.01-25 K B	USM	CX-SNAJ300
O	TUNER (RF)	C 0851	87-012-286-080	0E	C-CAP,U 0.01-25 K B	USM	CX-SNAJ305
O	TUNER (RF)	C 0852	87-012-286-080		C-CAP,U 0.01-25 K B	LHSM	CX-NSZ300
O	TUNER (RF)	C 0852	87-012-286-080		C-CAP,U 0.01-25 K B	USM	CX-SNAJ300
O	TUNER (RF)	C 0852	87-012-286-080		C-CAP,U 0.01-25 K B	USM	CX-SNAJ305
O	TUNER (RF)	C 0852	87-012-286-080		C-CAP,U 0.01-25 K B	EZSM	CX-NSZ300

PARTS LIST

! = Δ SAFTY PARTS
 C = Components marked

All components used on this model at the production line are shown in this service manual.

However, please note that not all components will be available as spare parts for after-sales service.

Components marked S and O are designated as spare parts for service and will be stocked at the spare parts centers.

Components marked X and R are not designated as spare parts for after sales service, and will not be stocked at the spare parts centers.

K NO. = Only use japanese.

! C	UNIT NAME	REF NO.	PARTS CODE	K NO.	DESCRIPTION	SUFFIX	MODEL NAME
O	TUNER (RF)	C	0852 87-012-286-080	OE	C-CAP,U 0.01-25 K B	USM	CX-SNAJ300
O	TUNER (RF)	C	0852 87-012-286-080	OE	C-CAP,U 0.01-25 K B	USM	CX-SNAJ305
O	TUNER (RF)	C	0853 87-012-286-080		C-CAP,U 0.01-25 K B	LHSM	CX-NSZ300
O	TUNER (RF)	C	0853 87-012-286-080		C-CAP,U 0.01-25 K B	USM	CX-SNAJ300
O	TUNER (RF)	C	0853 87-012-286-080		C-CAP,U 0.01-25 K B	USM	CX-SNAJ305
O	TUNER (RF)	C	0853 87-012-286-080		C-CAP,U 0.01-25 K B	EZSM	CX-NSZ300
O	TUNER (RF)	C	0853 87-012-286-080	OE	C-CAP,U 0.01-25 K B	USM	CX-SNAJ300
O	TUNER (RF)	C	0853 87-012-286-080	OE	C-CAP,U 0.01-25 K B	USM	CX-SNAJ305
O	TUNER (RF)	C	0858 87-010-831-080		C-CAP,U 0.1-16 Z F	LHSM	CX-NSZ300
O	TUNER (RF)	C	0858 87-010-831-080		C-CAP,U 0.1-16 Z F	USM	CX-SNAJ300
O	TUNER (RF)	C	0858 87-010-831-080		C-CAP,U 0.1-16 Z F	USM	CX-SNAJ305
O	TUNER (RF)	C	0858 87-010-831-080		C-CAP,U 0.1-16 Z F	EZSM	CX-NSZ300
O	TUNER (RF)	C	0858 87-010-831-080	OE	C-CAP,U 0.1-16 Z F	USM	CX-SNAJ300
O	TUNER (RF)	C	0858 87-010-831-080	OE	C-CAP,U 0.1-16 Z F	USM	CX-SNAJ305
O	TUNER (RF)	C	0859 87-010-831-080		C-CAP,U 0.1-16 Z F	EZSM	CX-NSZ300
O	TUNER (RF)	C	0860 87-012-286-080		C-CAP,U 0.01-25 K B	LHSM	CX-NSZ300
O	TUNER (RF)	C	0860 87-012-286-080		C-CAP,U 0.01-25 K B	EZSM	CX-NSZ300
O	TUNER (RF)	C	0940 87-012-286-080		C-CAP,U 0.01-25 K B	EZSM	CX-NSZ300
X	TUNER (RF)	C	0940 88-108-000-080		C-JUMPER,U	LHSM	CX-NSZ300
X	TUNER (RF)	C	0940 88-108-000-080		C-JUMPER,U	USM	CX-SNAJ300
X	TUNER (RF)	C	0940 88-108-000-080	OE	C-JUMPER,U	USM	CX-SNAJ305
O	TUNER (RF)	C	0942 87-012-165-080		C-CAP,U 3P-50 C CH	EZSM	CX-NSZ300
O	TUNER (RF)	C	0947 87-012-286-080		C-CAP,U 0.01-25 K B	EZSM	CX-NSZ300
O	TUNER (RF)	C	0948 87-A10-039-080		C-CAP,U 470P-50 J CH	EZSM	CX-NSZ300
O	TUNER (RF)	C	0952 87-012-286-080		C-CAP,U 0.01-25 K B	EZSM	CX-NSZ300
O	TUNER (RF)	C	0957 87-012-174-080		C-CAP,U 12P-50 J CH	EZSM	CX-NSZ300
O	TUNER (RF)	C	0958 87-012-286-080		C-CAP,U 0.01-25 K B	EZSM	CX-NSZ300
O	TUNER (RF)	C	0959 87-010-831-080		C-CAP,U 0.1-16 Z F	LHSM	CX-NSZ300
O	TUNER (RF)	C	0959 87-010-831-080		C-CAP,U 0.1-16 Z F	USM	CX-SNAJ300
O	TUNER (RF)	C	0959 87-010-831-080		C-CAP,U 0.1-16 Z F	USM	CX-SNAJ305
O	TUNER (RF)	C	0959 87-010-831-080	OE	C-CAP,U 0.1-16 Z F	USM	CX-SNAJ300
O	TUNER (RF)	C	0959 87-010-831-080	OE	C-CAP,U 0.1-16 Z F	USM	CX-SNAJ305
O	TUNER (RF)	C	0960 87-010-831-080		C-CAP,U 0.1-16 Z F	LHSM	CX-NSZ300
O	TUNER (RF)	C	0960 87-010-831-080		C-CAP,U 0.1-16 Z F	USM	CX-SNAJ300
O	TUNER (RF)	C	0960 87-010-831-080		C-CAP,U 0.1-16 Z F	USM	CX-SNAJ305
O	TUNER (RF)	C	0960 87-010-831-080	OE	C-CAP,U 0.1-16 Z F	USM	CX-SNAJ300
O	TUNER (RF)	C	0960 87-010-831-080	OE	C-CAP,U 0.1-16 Z F	USM	CX-SNAJ305
O	TUNER (RF)	C	0961 87-012-167-080	OE	C-CAP,U 5P-50 C CH	USM	CX-SNAJ300
O	TUNER (RF)	C	0961 87-012-167-080	OE	C-CAP,U 5P-50 C CH	USM	CX-SNAJ305
O	TUNER (RF)	C	0961 87-012-170-080		C-CAP,U 8P-50 D CH	LHSM	CX-NSZ300
O	TUNER (RF)	C	0961 87-012-170-080		C-CAP,U 8P-50 D CH	USM	CX-SNAJ300
O	TUNER (RF)	C	0961 87-012-170-080		C-CAP,U 8P-50 D CH	USM	CX-SNAJ305
O	TUNER (RF)	C	0962 87-A12-087-080		CAP,E 1-50 SMG	EZSM	CX-NSZ300
O	TUNER (RF)	C	0963 87-015-785-080		C-CAP, 0.1-25 Z F C3216	LHSM	CX-NSZ300
O	TUNER (RF)	C	0963 87-015-785-080		C-CAP, 0.1-25 Z F C3216	USM	CX-SNAJ300
O	TUNER (RF)	C	0963 87-015-785-080		C-CAP, 0.1-25 Z F C3216	USM	CX-SNAJ305
O	TUNER (RF)	C	0963 87-015-785-080		C-CAP, 0.1-25 Z F C3216	EZSM	CX-NSZ300
O	TUNER (RF)	C	0963 87-015-785-080	OE	C-CAP, 0.1-25 Z F C3216	USM	CX-SNAJ300
O	TUNER (RF)	C	0963 87-015-785-080	OE	C-CAP, 0.1-25 Z F C3216	USM	CX-SNAJ305
O	TUNER (RF)	CF	0831 87-008-261-010		FLTR,CF SFE10.7MA5	LHSM	CX-NSZ300
O	TUNER (RF)	CF	0831 87-008-261-010		FLTR,CF SFE10.7MA5	USM	CX-SNAJ300
O	TUNER (RF)	CF	0831 87-008-261-010		FLTR,CF SFE10.7MA5	USM	CX-SNAJ305
O	TUNER (RF)	CF	0831 87-008-261-010	1A	FLTR,CF SFE10.7MA5	USM	CX-SNAJ300
O	TUNER (RF)	CF	0831 87-008-261-010	1A	FLTR,CF SFE10.7MA5	USM	CX-SNAJ305
O	TUNER (RF)	CF	0831 87-008-423-010		FLTR,CF SFE10.7MS3G-A	EZSM	CX-NSZ300
O	TUNER (RF)	CF	0832 82-785-747-010		CF,MS2 GHY,R	EZSM	CX-NSZ300
O	TUNER (RF)	CF	0832 87-008-261-010		FLTR,CF SFE10.7MA5	LHSM	CX-NSZ300
O	TUNER (RF)	CF	0832 87-008-261-010		FLTR,CF SFE10.7MA5	USM	CX-SNAJ300
O	TUNER (RF)	CF	0832 87-008-261-010		FLTR,CF SFE10.7MA5	USM	CX-SNAJ305
O	TUNER (RF)	CF	0832 87-008-261-010	1A	FLTR,CF SFE10.7MA5	USM	CX-SNAJ300
O	TUNER (RF)	CF	0832 87-008-261-010	1A	FLTR,CF SFE10.7MA5	USM	CX-SNAJ305
S	TUNER (RF)	D	0942 87-A40-270-080		C-DIODE,MC2838	EZSM	CX-NSZ300
S	TUNER (RF)	D	0944 87-A40-291-080		DIODE,1N4148M (CPT)	EZSM	CX-NSZ300
X	TUNER (RF)	D	0944 88-100-000-010		PLATING-JW, 0.58 SN95	LHSM	CX-NSZ300
X	TUNER (RF)	D	0944 88-100-000-010		PLATING-JW, 0.58 SN95	USM	CX-SNAJ300
X	TUNER (RF)	D	0944 88-100-000-010		PLATING-JW, 0.58 SN95	USM	CX-SNAJ305

PARTS LIST

! = Δ SAFTY PARTS
 C = Components marked

All components used on this model at the production line are shown in this service manual.

However, please note that not all components will be available as spare parts for after-sales service.

Components marked S and O are designated as spare parts for service and will be stocked at the spare parts centers.

Components marked X and R are not designated as spare parts for after sales service, and will not be stocked at the spare parts centers.

K NO. = Only use japanese.

! C	UNIT NAME	REF NO.	PARTS CODE	K NO.	DESCRIPTION	SUFFIX	MODEL NAME
X	TUNER (RF)	D 0944	88-100-000-010	OE	PLATING-JW, 0.58 SN95	USM	CX-SNAJ300
X	TUNER (RF)	D 0944	88-100-000-010	OE	PLATING-JW, 0.58 SN95	USM	CX-SNAJ305
O	TUNER (RF)	FFE0831	A8-6ZA-19H-030		6ZA-1 FEMENM	EZSM	CX-NSZ300
O	TUNER (RF)	J 0831	87-A60-202-010		TERMINAL,ANT 4P MSP-154V-02	LHSM	CX-NSZ300
O	TUNER (RF)	J 0831	87-A60-202-010		TERMINAL,ANT 4P MSP-154V-02	USM	CX-SNAJ300
O	TUNER (RF)	J 0831	87-A60-202-010		TERMINAL,ANT 4P MSP-154V-02	USM	CX-SNAJ305
!	O TUNER (RF)	J 0831	87-A60-202-010	1A	TERMINAL,ANT 4P MSP-154V-02	USM	CX-SNAJ300
!	O TUNER (RF)	J 0831	87-A60-202-010	1A	TERMINAL,ANT 4P MSP-154V-02	USM	CX-SNAJ305
O	TUNER (RF)	J 0832	87-A60-403-010		TERMINAL,ANT PAL 2P HSP-312V05	EZSM	CX-NSZ300
X	TUNER (RF)	JR 0834	88-108-000-080		C-JUMPER,U	LHSM	CX-NSZ300
X	TUNER (RF)	JR 0834	88-108-000-080		C-JUMPER,U	USM	CX-SNAJ300
X	TUNER (RF)	JR 0834	88-108-000-080		C-JUMPER,U	USM	CX-SNAJ305
X	TUNER (RF)	JR 0834	88-108-000-080		C-JUMPER,U	EZSM	CX-NSZ300
X	TUNER (RF)	JR 0834	88-108-000-080	OE	C-JUMPER,U	USM	CX-SNAJ300
X	TUNER (RF)	JR 0834	88-108-000-080	OE	C-JUMPER,U	USM	CX-SNAJ305
X	TUNER (RF)	JR 0835	88-108-000-080		C-JUMPER,U	EZSM	CX-NSZ300
X	TUNER (RF)	JR 0835	88-108-561-080		C-RES,U 560-1/16W J	LHSM	CX-NSZ300
X	TUNER (RF)	JR 0835	88-108-561-080		C-RES,U 560-1/16W J	USM	CX-SNAJ300
X	TUNER (RF)	JR 0835	88-108-561-080		C-RES,U 560-1/16W J	USM	CX-SNAJ305
X	TUNER (RF)	JR 0835	88-108-561-080	OE	C-RES,U 560-1/16W J	USM	CX-SNAJ300
X	TUNER (RF)	JR 0835	88-108-561-080	OE	C-RES,U 560-1/16W J	USM	CX-SNAJ305
X	TUNER (RF)	JR 0851	88-129-000-080	OE	C-JUMPER,3216	LHSM	CX-NSZ300
X	TUNER (RF)	JR 0851	88-129-000-080		C-JUMPER,3216	USM	CX-SNAJ300
X	TUNER (RF)	JR 0851	88-129-000-080		C-JUMPER,3216	USM	CX-SNAJ305
X	TUNER (RF)	JR 0851	88-129-000-080		C-JUMPER,3216	EZSM	CX-NSZ300
X	TUNER (RF)	JR 0851	88-129-000-080	OE	C-JUMPER,3216	USM	CX-SNAJ300
X	TUNER (RF)	JR 0851	88-129-000-080	OE	C-JUMPER,3216	USM	CX-SNAJ305
X	TUNER (RF)	JR 0942	88-108-000-080		C-JUMPER,U	EZSM	CX-NSZ300
X	TUNER (RF)	JR 0943	88-108-000-080		C-JUMPER,U	LHSM	CX-NSZ300
X	TUNER (RF)	JR 0943	88-108-000-080		C-JUMPER,U	USM	CX-SNAJ300
X	TUNER (RF)	JR 0943	88-108-000-080	OE	C-JUMPER,U	USM	CX-SNAJ305
X	TUNER (RF)	JR 0944	88-108-000-080		C-JUMPER,U	EZSM	CX-NSZ300
X	TUNER (RF)	JR 0946	88-108-000-080		C-JUMPER,U	LHSM	CX-NSZ300
X	TUNER (RF)	JR 0946	88-108-000-080		C-JUMPER,U	USM	CX-SNAJ300
X	TUNER (RF)	JR 0946	88-108-000-080		C-JUMPER,U	USM	CX-SNAJ305
X	TUNER (RF)	JR 0946	88-108-000-080	OE	C-JUMPER,U	USM	CX-SNAJ300
X	TUNER (RF)	JR 0946	88-108-000-080	OE	C-JUMPER,U	USM	CX-SNAJ305
X	TUNER (RF)	JR 0947	88-108-000-080		C-JUMPER,U	EZSM	CX-NSZ300
X	TUNER (RF)	JR 0948	88-108-000-080		C-JUMPER,U	EZSM	CX-NSZ300
X	TUNER (RF)	JR 0950	88-108-000-080		C-JUMPER,U	EZSM	CX-NSZ300
X	TUNER (RF)	JR 0951	88-108-000-080		C-JUMPER,U	LHSM	CX-NSZ300
X	TUNER (RF)	JR 0951	88-108-000-080		C-JUMPER,U	USM	CX-SNAJ300
X	TUNER (RF)	JR 0951	88-108-000-080		C-JUMPER,U	USM	CX-SNAJ305
X	TUNER (RF)	JR 0951	88-108-000-080	OE	C-JUMPER,U	USM	CX-SNAJ300
X	TUNER (RF)	JR 0951	88-108-000-080	OE	C-JUMPER,U	USM	CX-SNAJ305
X	TUNER (RF)	JR 0952	88-108-000-080		C-JUMPER,U	LHSM	CX-NSZ300
X	TUNER (RF)	JR 0952	88-108-000-080		C-JUMPER,U	USM	CX-SNAJ300
X	TUNER (RF)	JR 0952	88-108-000-080		C-JUMPER,U	USM	CX-SNAJ305
X	TUNER (RF)	JR 0952	88-108-000-080	OE	C-JUMPER,U	EZSM	CX-NSZ300
X	TUNER (RF)	JR 0952	88-108-000-080	OE	C-JUMPER,U	USM	CX-SNAJ300
X	TUNER (RF)	JR 0954	88-108-000-080		C-JUMPER,U	LHSM	CX-NSZ300
X	TUNER (RF)	JR 0954	88-108-000-080		C-JUMPER,U	USM	CX-SNAJ300
X	TUNER (RF)	JR 0954	88-108-000-080		C-JUMPER,U	USM	CX-SNAJ305
X	TUNER (RF)	JR 0954	88-108-000-080		C-JUMPER,U	USM	CX-SNAJ300
X	TUNER (RF)	JR 0954	88-108-000-080	OE	C-JUMPER,U	USM	CX-SNAJ300
X	TUNER (RF)	JR 0954	88-108-000-080	OE	C-JUMPER,U	USM	CX-SNAJ305
X	TUNER (RF)	JR 0955	88-108-000-080		C-JUMPER,U	LHSM	CX-NSZ300
X	TUNER (RF)	JR 0955	88-108-000-080		C-JUMPER,U	USM	CX-SNAJ300
X	TUNER (RF)	JR 0955	88-108-000-080		C-JUMPER,U	USM	CX-SNAJ305
X	TUNER (RF)	JR 0955	88-108-000-080	OE	C-JUMPER,U	USM	CX-SNAJ300
X	TUNER (RF)	JR 0955	88-108-000-080	OE	C-JUMPER,U	USM	CX-SNAJ305
X	TUNER (RF)	JR 0956	88-108-000-080		C-JUMPER,U	EZSM	CX-NSZ300
X	TUNER (RF)	JR 0958	88-108-000-080		C-JUMPER,U	EZSM	CX-NSZ300
X	TUNER (RF)	JR 0962	88-108-000-080		C-JUMPER,U	EZSM	CX-NSZ300
X	TUNER (RF)	JR 0963	88-108-000-080		C-JUMPER,U	EZSM	CX-NSZ300
X	TUNER (RF)	JR 0964	88-129-000-080		C-JUMPER,3216	LHSM	CX-NSZ300
X	TUNER (RF)	JR 0964	88-129-000-080		C-JUMPER,3216	USM	CX-SNAJ300
X	TUNER (RF)	JR 0964	88-129-000-080		C-JUMPER,3216	USM	CX-SNAJ305

PARTS LIST

! = Δ SAFTY PARTS
 C = Components marked

All components used on this model at the production line are shown in this service manual.

However, please note that not all components will be available as spare parts for after-sales service.

Components marked S and O are designated as spare parts for service and will be stocked at the spare parts centers.

Components marked X and R are not designated as spare parts for after sales service, and will not be stocked at the spare parts centers.

K NO. = Only use japanese.

! C	UNIT NAME	REF NO.	PARTS CODE	K NO.	DESCRIPTION	SUFFIX	MODEL NAME
X	TUNER (RF)	JR 0964	88-129-000-080	0E	C-JUMPER, 3216	USM	CX-SNAJ300
X	TUNER (RF)	JR 0964	88-129-000-080	0E	C-JUMPER, 3216	USM	CX-SNAJ305
O	TUNER (RF)	L 0832	87-005-847-080		COIL, 2.2UH K CECS	LHSM	CX-NSZ300
O	TUNER (RF)	L 0832	87-005-847-080		COIL, 2.2UH K CECS	USM	CX-SNAJ300
O	TUNER (RF)	L 0832	87-005-847-080		COIL, 2.2UH K CECS	USM	CX-SNAJ305
O	TUNER (RF)	L 0832	87-005-847-080		COIL, 2.2UH K CECS	EZSM	CX-NSZ300
O	TUNER (RF)	L 0832	87-005-847-080	0E	COIL, 2.2UH K CECS	USM	CX-SNAJ300
O	TUNER (RF)	L 0832	87-005-847-080	0E	COIL, 2.2UH K CECS	USM	CX-SNAJ305
O	TUNER (RF)	L 0941	87-A50-020-010		COIL, ANT LW (COI) 252KHZ	EZSM	CX-NSZ300
O	TUNER (RF)	L 0942	87-A50-019-010		COIL, OSC LW (COI) 856KHZ	EZSM	CX-NSZ300
O	TUNER (RF)	L 0951	8A-NF8-667-010		COIL, AM PACK 4 (TOK)	LHSM	CX-NSZ300
O	TUNER (RF)	L 0951	8A-NF8-667-010		COIL, AM PACK 4 (TOK)	USM	CX-SNAJ300
O	TUNER (RF)	L 0951	8A-NF8-667-010		COIL, AM PACK 4 (TOK)	USM	CX-SNAJ305
O	TUNER (RF)	L 0951	8A-NF8-667-010	1C	COIL, AM PACK 4 (TOK)	USM	CX-SNAJ300
O	TUNER (RF)	L 0951	8A-NF8-667-010	1C	COIL, AM PACK 4 (TOK)	USM	CX-SNAJ305
O	TUNER (RF)	L 0951	8A-NF8-668-010		COIL, AM PACK 2 (TOK)	EZSM	CX-NSZ300
S	TUNER (RF)	Q 0835	89-327-143-080		C-TR, 2SC27140	LHSM	CX-NSZ300
S	TUNER (RF)	Q 0835	89-327-143-080		C-TR, 2SC27140	USM	CX-SNAJ300
S	TUNER (RF)	Q 0835	89-327-143-080		C-TR, 2SC27140	USM	CX-SNAJ305
S	TUNER (RF)	Q 0835	89-327-143-080		C-TR, 2SC27140	EZSM	CX-NSZ300
S	TUNER (RF)	Q 0835	89-327-143-080	0E	C-TR, 2SC27140	USM	CX-SNAJ300
S	TUNER (RF)	Q 0835	89-327-143-080	0E	C-TR, 2SC27140	USM	CX-SNAJ305
S	TUNER (RF)	Q 0836	87-A30-489-080		C-TR, KRA107S	LHSM	CX-NSZ300
S	TUNER (RF)	Q 0836	87-A30-489-080		C-TR, KRA107S	USM	CX-SNAJ300
S	TUNER (RF)	Q 0836	87-A30-489-080		C-TR, KRA107S	USM	CX-SNAJ305
S	TUNER (RF)	Q 0836	87-A30-489-080		C-TR, KRA107S	EZSM	CX-NSZ300
S	TUNER (RF)	Q 0836	87-A30-489-080	0E	C-TR, KRA107S	USM	CX-SNAJ300
S	TUNER (RF)	Q 0836	87-A30-489-080	0E	C-TR, KRA107S	USM	CX-SNAJ305
S	TUNER (RF)	Q 0948	87-A30-086-040		C-TR, CSD1306E	EZSM	CX-NSZ300
S	TUNER (RF)	Q 0951	87-A30-484-080		C-TR, KRA102S	EZSM	CX-NSZ300
S	TUNER (RF)	Q 0952	87-A30-086-040		C-TR, CSD1306E	EZSM	CX-NSZ300
S	TUNER (RF)	Q 0953	89-503-602-080		C-FET, 2SK360E	EZSM	CX-NSZ300
X	TUNER (RF)	R 0832	88-108-391-080		C-RES, U 390-1/16W J	LHSM	CX-NSZ300
X	TUNER (RF)	R 0832	88-108-391-080		C-RES, U 390-1/16W J	USM	CX-SNAJ300
X	TUNER (RF)	R 0832	88-108-391-080		C-RES, U 390-1/16W J	USM	CX-SNAJ305
X	TUNER (RF)	R 0832	88-108-391-080		C-RES, U 390-1/16W J	EZSM	CX-NSZ300
X	TUNER (RF)	R 0832	88-108-391-080	0E	C-RES, U 390-1/16W J	USM	CX-SNAJ300
X	TUNER (RF)	R 0832	88-108-391-080	0E	C-RES, U 390-1/16W J	USM	CX-SNAJ305
X	TUNER (RF)	R 0836	88-108-102-080		C-RES, U 1K-1/16W J	LHSM	CX-NSZ300
X	TUNER (RF)	R 0836	88-108-102-080		C-RES, U 1K-1/16W J	USM	CX-SNAJ300
X	TUNER (RF)	R 0836	88-108-102-080		C-RES, U 1K-1/16W J	USM	CX-SNAJ305
X	TUNER (RF)	R 0836	88-108-102-080		C-RES, U 1K-1/16W J	EZSM	CX-NSZ300
X	TUNER (RF)	R 0836	88-108-102-080	0E	C-RES, U 1K-1/16W J	USM	CX-SNAJ300
X	TUNER (RF)	R 0839	88-108-151-080		C-RES, U 150-1/16W J	EZSM	CX-NSZ300
X	TUNER (RF)	R 0840	88-108-221-080		C-RES, U 220-1/16W J	LHSM	CX-NSZ300
X	TUNER (RF)	R 0840	88-108-221-080		C-RES, U 220-1/16W J	USM	CX-SNAJ300
X	TUNER (RF)	R 0840	88-108-221-080		C-RES, U 220-1/16W J	USM	CX-SNAJ305
X	TUNER (RF)	R 0840	88-108-221-080		C-RES, U 220-1/16W J	EZSM	CX-NSZ300
X	TUNER (RF)	R 0840	88-108-221-080	0E	C-RES, U 220-1/16W J	USM	CX-SNAJ300
X	TUNER (RF)	R 0840	88-108-221-080	0E	C-RES, U 220-1/16W J	USM	CX-SNAJ305
X	TUNER (RF)	R 0850	88-108-103-080		C-RES, U 10K-1/16W J	LHSM	CX-NSZ300
X	TUNER (RF)	R 0850	88-108-103-080		C-RES, U 10K-1/16W J	USM	CX-SNAJ300
X	TUNER (RF)	R 0850	88-108-103-080		C-RES, U 10K-1/16W J	USM	CX-SNAJ305
X	TUNER (RF)	R 0850	88-108-103-080		C-RES, U 10K-1/16W J	EZSM	CX-NSZ300
X	TUNER (RF)	R 0850	88-108-103-080	0E	C-RES, U 10K-1/16W J	USM	CX-SNAJ300
X	TUNER (RF)	R 0850	88-108-103-080	0E	C-RES, U 10K-1/16W J	USM	CX-SNAJ305
X	TUNER (RF)	R 0851	88-108-000-080		C-JUMPER, U	LHSM	CX-NSZ300
X	TUNER (RF)	R 0851	88-108-000-080		C-JUMPER, U	USM	CX-SNAJ300
X	TUNER (RF)	R 0851	88-108-000-080		C-JUMPER, U	USM	CX-SNAJ305
X	TUNER (RF)	R 0851	88-108-470-080		C-RES, U 47-1/16W J	EZSM	CX-NSZ300
X	TUNER (RF)	R 0852	88-108-103-080		C-RES, U 10K-1/16W J	LHSM	CX-NSZ300
X	TUNER (RF)	R 0852	88-108-103-080		C-RES, U 10K-1/16W J	USM	CX-SNAJ300
X	TUNER (RF)	R 0852	88-108-103-080		C-RES, U 10K-1/16W J	USM	CX-SNAJ305
X	TUNER (RF)	R 0852	88-108-103-080	0E	C-RES, U 10K-1/16W J	USM	CX-SNAJ300
X	TUNER (RF)	R 0852	88-108-103-080	0E	C-RES, U 10K-1/16W J	USM	CX-SNAJ305
X	TUNER (RF)	R 0853	88-108-102-080		C-RES, U 1K-1/16W J	LHSM	CX-NSZ300
X	TUNER (RF)	R 0853	88-108-102-080		C-RES, U 1K-1/16W J	USM	CX-SNAJ300

PARTS LIST

! = Δ SAFTY PARTS
 C = Components marked

All components used on this model at the production line are shown in this service manual.

However, please note that not all components will be available as spare parts for after-sales service.

Components marked S and O are designated as spare parts for service and will be stocked at the spare parts centers.

Components marked X and R are not designated as spare parts for after sales service, and will not be stocked at the spare parts centers.

K NO. = Only use japanese.

! C	UNIT NAME	REF NO.	PARTS CODE	K NO.	DESCRIPTION	SUFFIX	MODEL NAME
X	TUNER (RF)	R	0853 88-108-102-080		C-RES,U 1K-1/16W J	USM	CX-SNAJ305
X	TUNER (RF)	R	0853 88-108-102-080		C-RES,U 1K-1/16W J	EZSM	CX-NSZ300
X	TUNER (RF)	R	0853 88-108-102-080	OE	C-RES,U 1K-1/16W J	USM	CX-SNAJ300
X	TUNER (RF)	R	0853 88-108-102-080	OE	C-RES,U 1K-1/16W J	USM	CX-SNAJ305
X	TUNER (RF)	R	0854 88-108-331-080		C-RES,U 330-1/16W J	LHSM	CX-NSZ300
X	TUNER (RF)	R	0854 88-108-331-080		C-RES,U 330-1/16W J	USM	CX-SNAJ300
X	TUNER (RF)	R	0854 88-108-331-080		C-RES,U 330-1/16W J	USM	CX-SNAJ305
X	TUNER (RF)	R	0854 88-108-331-080		C-RES,U 330-1/16W J	EZSM	CX-NSZ300
X	TUNER (RF)	R	0854 88-108-331-080	OE	C-RES,U 330-1/16W J	USM	CX-SNAJ300
X	TUNER (RF)	R	0854 88-108-331-080	OE	C-RES,U 330-1/16W J	USM	CX-SNAJ305
X	TUNER (RF)	R	0855 88-108-183-080		C-RES,U 18K-1/16W J	LHSM	CX-NSZ300
X	TUNER (RF)	R	0855 88-108-183-080		C-RES,U 18K-1/16W J	USM	CX-SNAJ300
X	TUNER (RF)	R	0855 88-108-183-080		C-RES,U 18K-1/16W J	USM	CX-SNAJ305
X	TUNER (RF)	R	0855 88-108-183-080		C-RES,U 18K-1/16W J	EZSM	CX-NSZ300
X	TUNER (RF)	R	0855 88-108-183-080	OE	C-RES,U 18K-1/16W J	USM	CX-SNAJ300
X	TUNER (RF)	R	0855 88-108-183-080	OE	C-RES,U 18K-1/16W J	USM	CX-SNAJ305
X	TUNER (RF)	R	0856 88-108-103-080		C-RES,U 10K-1/16W J	LHSM	CX-NSZ300
X	TUNER (RF)	R	0856 88-108-103-080		C-RES,U 10K-1/16W J	USM	CX-SNAJ300
X	TUNER (RF)	R	0856 88-108-103-080		C-RES,U 10K-1/16W J	USM	CX-SNAJ305
X	TUNER (RF)	R	0856 88-108-103-080		C-RES,U 10K-1/16W J	EZSM	CX-NSZ300
X	TUNER (RF)	R	0856 88-108-103-080	OE	C-RES,U 10K-1/16W J	USM	CX-SNAJ300
X	TUNER (RF)	R	0856 88-108-103-080	OE	C-RES,U 10K-1/16W J	USM	CX-SNAJ305
X	TUNER (RF)	R	0857 88-108-181-080		C-RES,U 180-1/16W J	LHSM	CX-NSZ300
X	TUNER (RF)	R	0857 88-108-181-080		C-RES,U 180-1/16W J	USM	CX-SNAJ300
X	TUNER (RF)	R	0857 88-108-181-080		C-RES,U 180-1/16W J	USM	CX-SNAJ305
X	TUNER (RF)	R	0857 88-108-181-080		C-RES,U 180-1/16W J	EZSM	CX-NSZ300
X	TUNER (RF)	R	0857 88-108-181-080	OE	C-RES,U 180-1/16W J	USM	CX-SNAJ300
X	TUNER (RF)	R	0857 88-108-181-080	OE	C-RES,U 180-1/16W J	USM	CX-SNAJ305
X	TUNER (RF)	R	0858 88-108-101-080		C-RES,U 100-1/16W J	LHSM	CX-NSZ300
X	TUNER (RF)	R	0858 88-108-101-080		C-RES,U 100-1/16W J	USM	CX-SNAJ300
X	TUNER (RF)	R	0858 88-108-101-080	OE	C-RES,U 100-1/16W J	USM	CX-SNAJ305
X	TUNER (RF)	R	0858 88-108-101-080	OE	C-RES,U 100-1/16W J	USM	CX-SNAJ300
X	TUNER (RF)	R	0860 88-108-271-080		C-RES,U 270-1/16W J	EZSM	CX-NSZ300
X	TUNER (RF)	R	0860 88-108-101-080		C-RES,U 100-1/16W J	LHSM	CX-NSZ300
X	TUNER (RF)	R	0860 88-108-101-080		C-RES,U 100-1/16W J	USM	CX-SNAJ300
X	TUNER (RF)	R	0860 88-108-101-080		C-RES,U 100-1/16W J	USM	CX-SNAJ305
X	TUNER (RF)	R	0860 88-108-101-080		C-RES,U 100-1/16W J	EZSM	CX-NSZ300
X	TUNER (RF)	R	0860 88-108-101-080	OE	C-RES,U 100-1/16W J	USM	CX-SNAJ300
X	TUNER (RF)	R	0860 88-108-101-080	OE	C-RES,U 100-1/16W J	USM	CX-SNAJ305
X	TUNER (RF)	R	0921 88-108-000-080	OE	C-JUMPER,U	USM	CX-SNAJ300
X	TUNER (RF)	R	0921 88-108-000-080	OE	C-JUMPER,U	USM	CX-SNAJ305
X	TUNER (RF)	R	0921 88-108-151-080		C-RES,U 150-1/16W J	LHSM	CX-NSZ300
X	TUNER (RF)	R	0921 88-108-151-080		C-RES,U 150-1/16W J	USM	CX-SNAJ300
X	TUNER (RF)	R	0921 88-108-151-080		C-RES,U 150-1/16W J	USM	CX-SNAJ305
X	TUNER (RF)	R	0921 88-108-151-080		C-RES,U 150-1/16W J	USM	CX-NSZ300
X	TUNER (RF)	R	0944 88-108-101-080		C-RES,U 100-1/16W J	EZSM	CX-NSZ300
X	TUNER (RF)	R	0945 88-108-104-080		C-RES,U 100K-1/16W J	LHSM	CX-NSZ300
X	TUNER (RF)	R	0945 88-108-104-080		C-RES,U 100K-1/16W J	USM	CX-SNAJ300
X	TUNER (RF)	R	0945 88-108-104-080		C-RES,U 100K-1/16W J	USM	CX-SNAJ305
X	TUNER (RF)	R	0945 88-108-104-080		C-RES,U 100K-1/16W J	EZSM	CX-NSZ300
X	TUNER (RF)	R	0945 88-108-104-080	OE	C-RES,U 100K-1/16W J	USM	CX-SNAJ300
X	TUNER (RF)	R	0945 88-108-104-080	OE	C-RES,U 100K-1/16W J	USM	CX-SNAJ305
X	TUNER (RF)	R	0947 88-108-183-080		C-RES,U 18K-1/16W J	EZSM	CX-NSZ300
X	TUNER (RF)	R	0948 88-108-472-080		C-RES,U 4.7K-1/16W J	EZSM	CX-NSZ300
X	TUNER (RF)	R	0952 88-108-562-080		C-RES,U 5.6K-1/16W J	EZSM	CX-NSZ300
X	TUNER (RF)	R	0954 88-108-222-080		C-RES,U 2.2K-1/16W J	EZSM	CX-NSZ300
X	TUNER (RF)	R	0956 88-108-471-080		C-RES,U 470-1/16W J	EZSM	CX-NSZ300
X	TUNER (RF)	R	0958 88-108-472-080		C-RES,U 4.7K-1/16W J	EZSM	CX-NSZ300
X	TUNER (RF)	R	0959 88-108-103-080		C-RES,U 10K-1/16W J	EZSM	CX-NSZ300
X	TUNER (RF)	R	0962 88-121-221-080		RES,220-1/8W J	LHSM	CX-NSZ300
X	TUNER (RF)	R	0962 88-121-221-080		RES,220-1/8W J	USM	CX-SNAJ300
X	TUNER (RF)	R	0962 88-121-221-080		RES,220-1/8W J	USM	CX-SNAJ305
X	TUNER (RF)	R	0962 88-121-221-080	OE	RES,220-1/8W J	USM	CX-SNAJ300
X	TUNER (RF)	R	0962 88-121-221-080	OE	RES,220-1/8W J	USM	CX-SNAJ305
X	TUNER (RF)	R	0963 88-108-330-080		C-RES,U 33-1/16W J	LHSM	CX-NSZ300
X	TUNER (RF)	R	0963 88-108-330-080		C-RES,U 33-1/16W J	USM	CX-SNAJ300
X	TUNER (RF)	R	0963 88-108-330-080		C-RES,U 33-1/16W J	USM	CX-SNAJ305
X	TUNER (RF)	R	0963 88-108-330-080		C-RES,U 33-1/16W J	USM	CX-SNAJ300
X	TUNER (RF)	R	0963 88-108-330-080	OE	C-RES,U 33-1/16W J	USM	CX-SNAJ300
X	TUNER (RF)	R	0963 88-108-330-080	OE	C-RES,U 33-1/16W J	USM	CX-SNAJ305

PARTS LIST

! = \triangle SAFTY PARTS
 C = Components marked

All components used on this model at the production line are shown in this service manual.

However, please note that not all components will be available as spare parts for after-sales service.

Components marked S and O are designated as spare parts for service and will be stocked at the spare parts centers.

Components marked X and R are not designated as spare parts for after sales service, and will not be stocked at the spare parts centers.

K NO. = Only use japanese.

! C	UNIT NAME	REF NO.	PARTS CODE	K NO.	DESCRIPTION	SUFFIX	MODEL NAME
X	TUNER (RF)	R 0964	88-108-330-080		C-RES,U 33-1/16W J	EZSM	CX-NSZ300
X	TUNER (RF)	R 0969	88-108-102-080		C-RES,U 1K-1/16W J	EZSM	CX-NSZ300
O	TUNER (RF)	TC 0942	87-A91-774-080		TRIMMER, PLY 30P 6.8X5.4 CDYL	EZSM	CX-NSZ300

SCHEMATIC DIAGRAM - 1 (MAIN) <U>

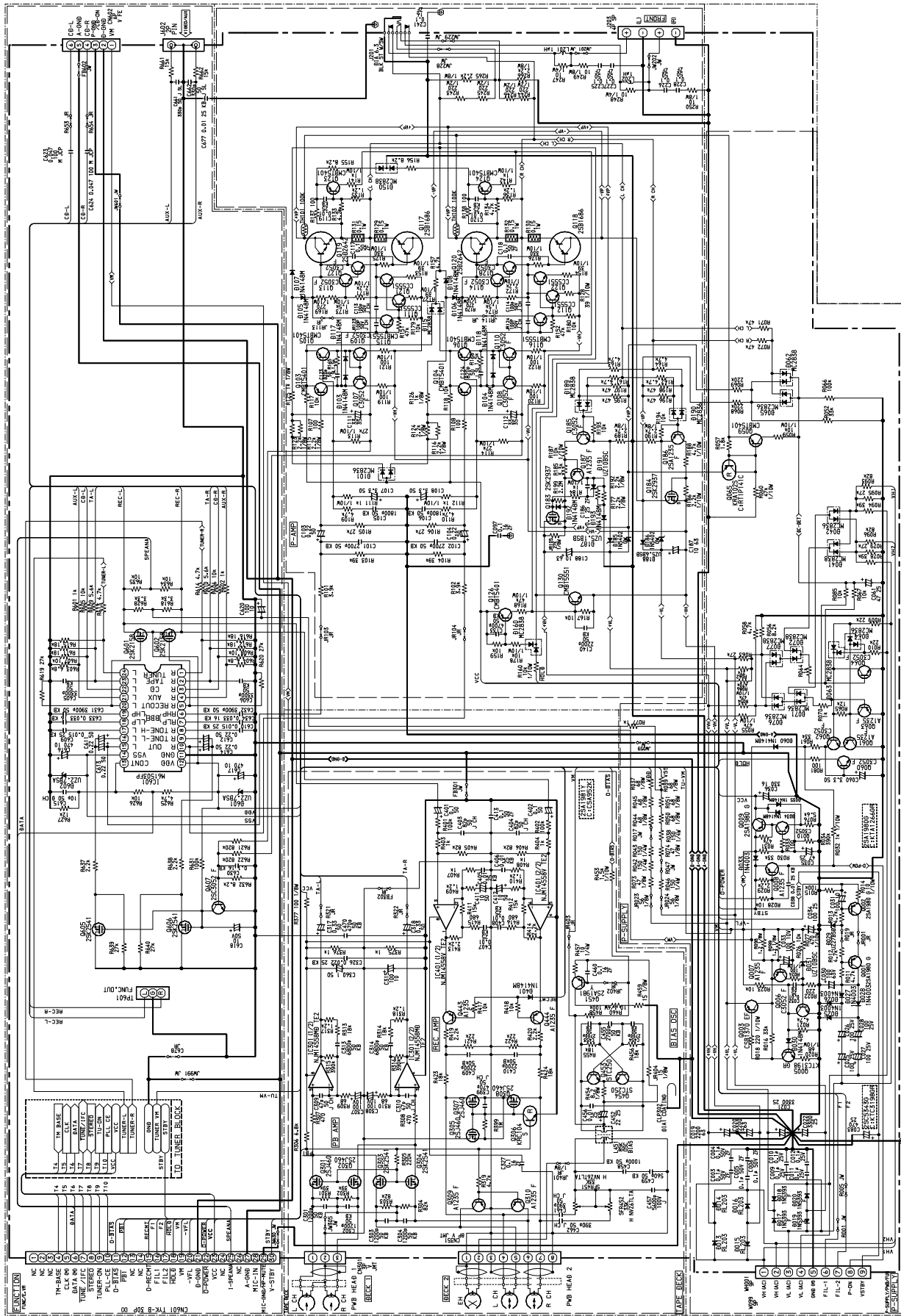

SCHEMATIC DIAGRAM - 2 (MAIN) <LH>

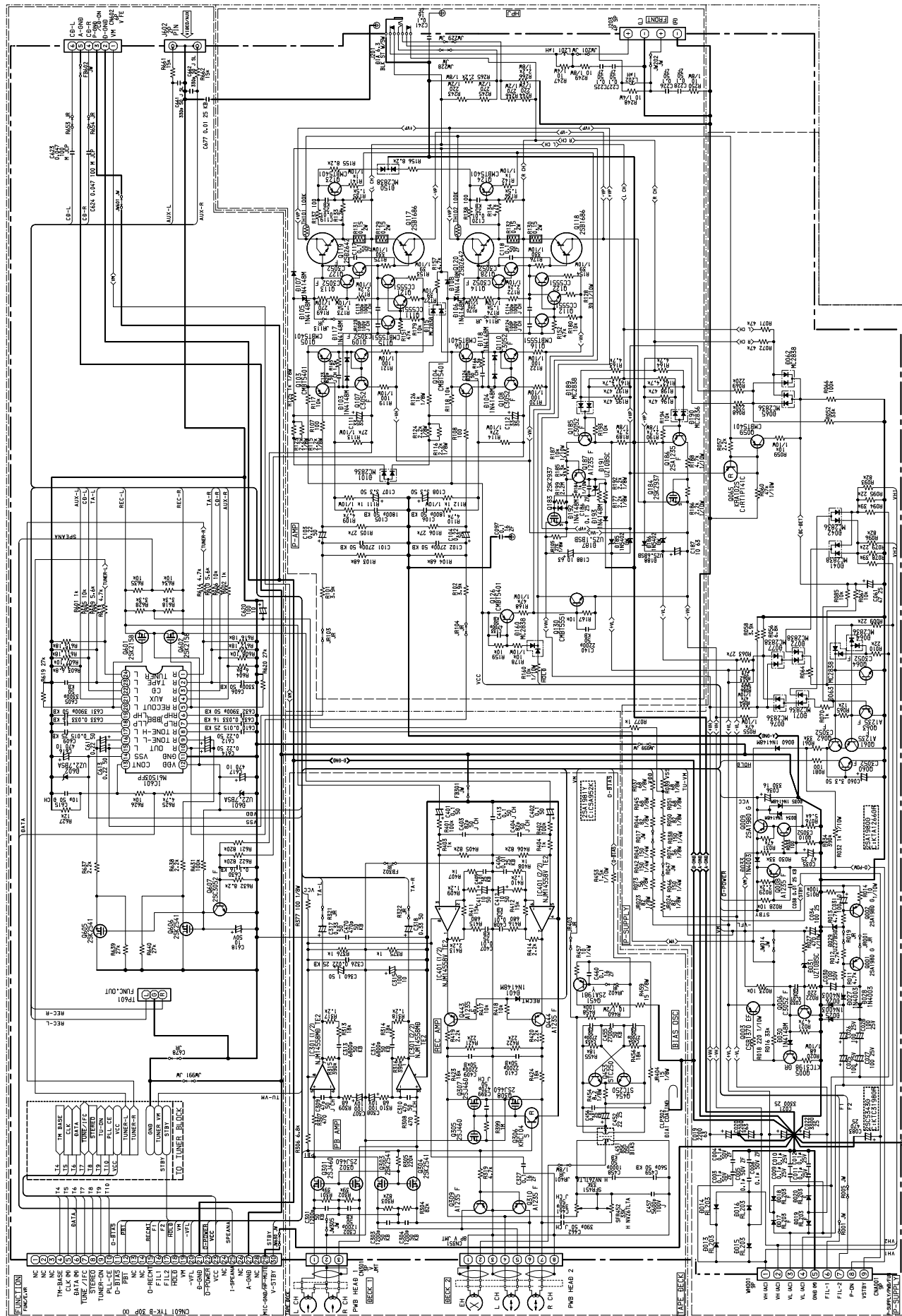

14	TRIMMER	T1	100 P
15	TRIMMER	T2	100 P
16	TRIMMER	T3	100 P
17	TRIMMER	T4	100 P
18	TRIMMER	T5	100 P
19	TRIMMER	T6	100 P
20	TRIMMER	T7	100 P
21	TRIMMER	T8	100 P
22	TRIMMER	T9	100 P
23	TRIMMER	T10	100 P
24	TRIMMER	T11	100 P
25	TRIMMER	T12	100 P
26	TRIMMER	T13	100 P
27	TRIMMER	T14	100 P
28	TRIMMER	T15	100 P
29	TRIMMER	T16	100 P
30	TRIMMER	T17	100 P
31	TRIMMER	T18	100 P
32	TRIMMER	T19	100 P
33	TRIMMER	T20	100 P
34	TRIMMER	T21	100 P
35	TRIMMER	T22	100 P
36	TRIMMER	T23	100 P
37	TRIMMER	T24	100 P
38	TRIMMER	T25	100 P
39	TRIMMER	T26	100 P
40	TRIMMER	T27	100 P
41	TRIMMER	T28	100 P
42	TRIMMER	T29	100 P
43	TRIMMER	T30	100 P
44	TRIMMER	T31	100 P
45	TRIMMER	T32	100 P
46	TRIMMER	T33	100 P
47	TRIMMER	T34	100 P
48	TRIMMER	T35	100 P
49	TRIMMER	T36	100 P
50	TRIMMER	T37	100 P
51	TRIMMER	T38	100 P
52	TRIMMER	T39	100 P
53	TRIMMER	T40	100 P
54	TRIMMER	T41	100 P
55	TRIMMER	T42	100 P
56	TRIMMER	T43	100 P
57	TRIMMER	T44	100 P
58	TRIMMER	T45	100 P
59	TRIMMER	T46	100 P
60	TRIMMER	T47	100 P
61	TRIMMER	T48	100 P
62	TRIMMER	T49	100 P
63	TRIMMER	T50	100 P
64	TRIMMER	T51	100 P
65	TRIMMER	T52	100 P
66	TRIMMER	T53	100 P
67	TRIMMER	T54	100 P
68	TRIMMER	T55	100 P
69	TRIMMER	T56	100 P
70	TRIMMER	T57	100 P
71	TRIMMER	T58	100 P
72	TRIMMER	T59	100 P
73	TRIMMER	T60	100 P
74	TRIMMER	T61	100 P
75	TRIMMER	T62	100 P
76	TRIMMER	T63	100 P
77	TRIMMER	T64	100 P
78	TRIMMER	T65	100 P
79	TRIMMER	T66	100 P
80	TRIMMER	T67	100 P
81	TRIMMER	T68	100 P
82	TRIMMER	T69	100 P
83	TRIMMER	T70	100 P
84	TRIMMER	T71	100 P
85	TRIMMER	T72	100 P
86	TRIMMER	T73	100 P
87	TRIMMER	T74	100 P
88	TRIMMER	T75	100 P
89	TRIMMER	T76	100 P
90	TRIMMER	T77	100 P
91	TRIMMER	T78	100 P
92	TRIMMER	T79	100 P
93	TRIMMER	T80	100 P
94	TRIMMER	T81	100 P
95	TRIMMER	T82	100 P
96	TRIMMER	T83	100 P
97	TRIMMER	T84	100 P
98	TRIMMER	T85	100 P
99	TRIMMER	T86	100 P
100	TRIMMER	T87	100 P

SCHEMATIC DIAGRAM - 3 (MAIN) <EZ>

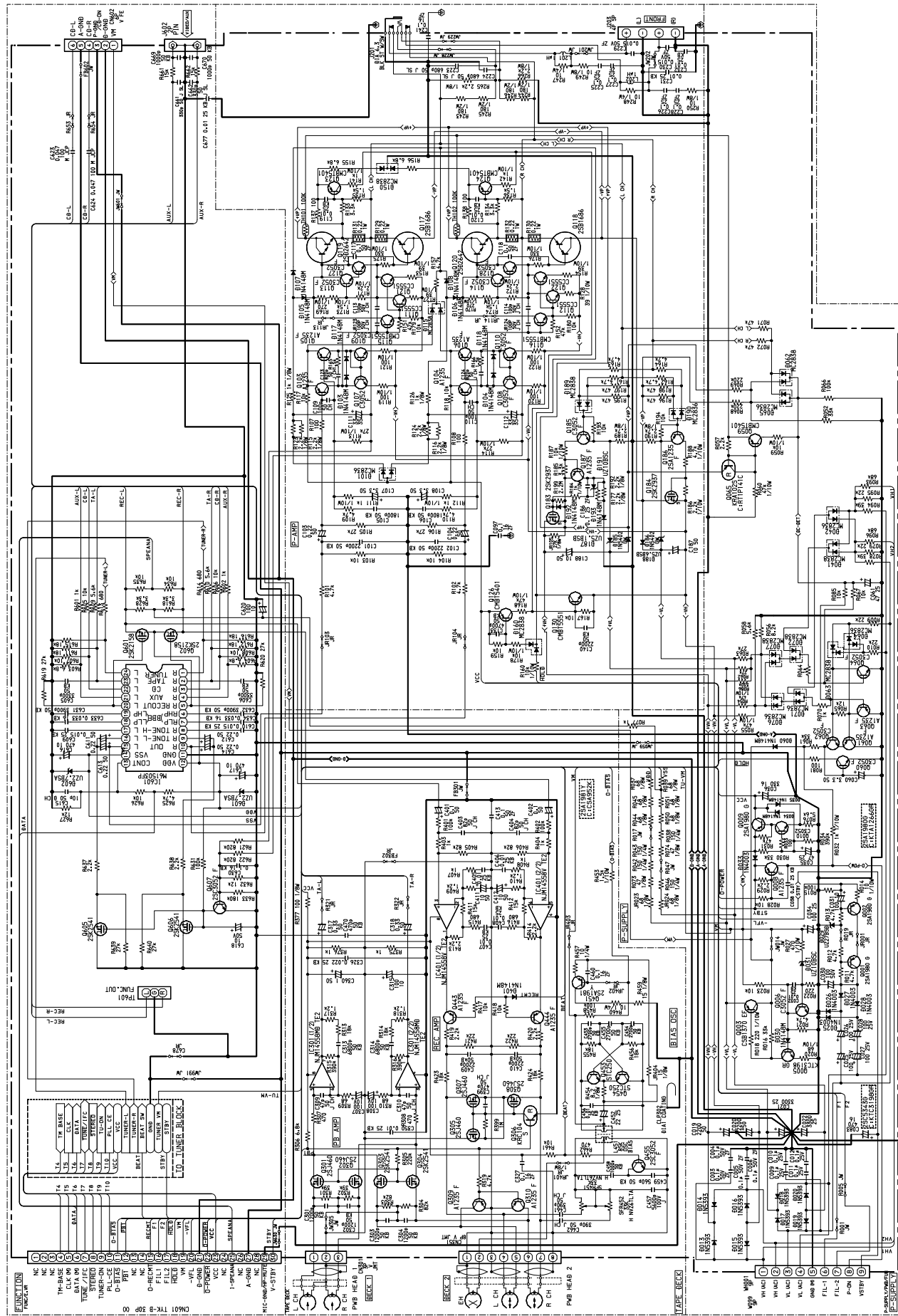

SCHEMATIC DIAGRAM - 4 (TUNER) <U>

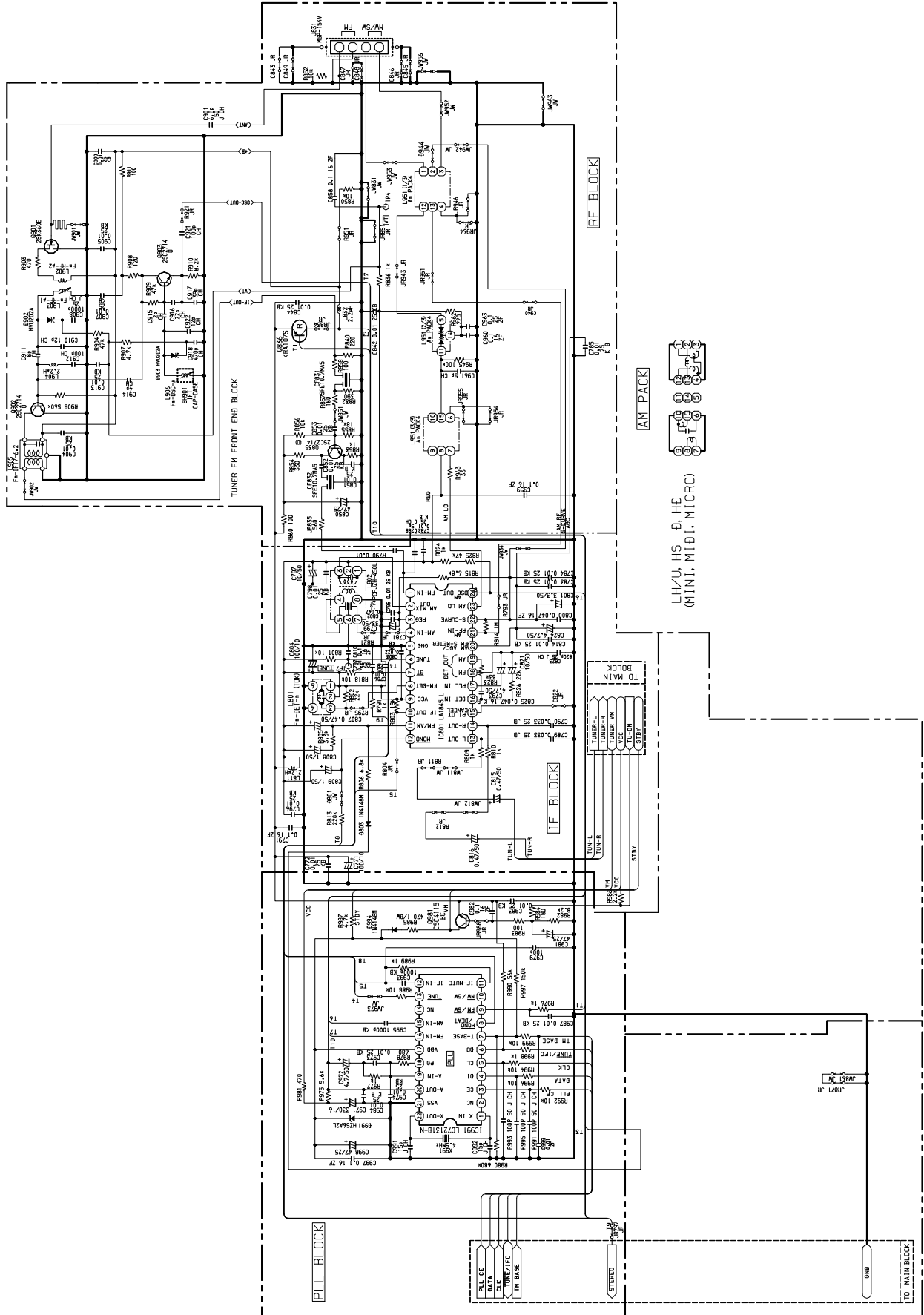

SCHEMATIC DIAGRAM - 5 (TUNER) <LH>

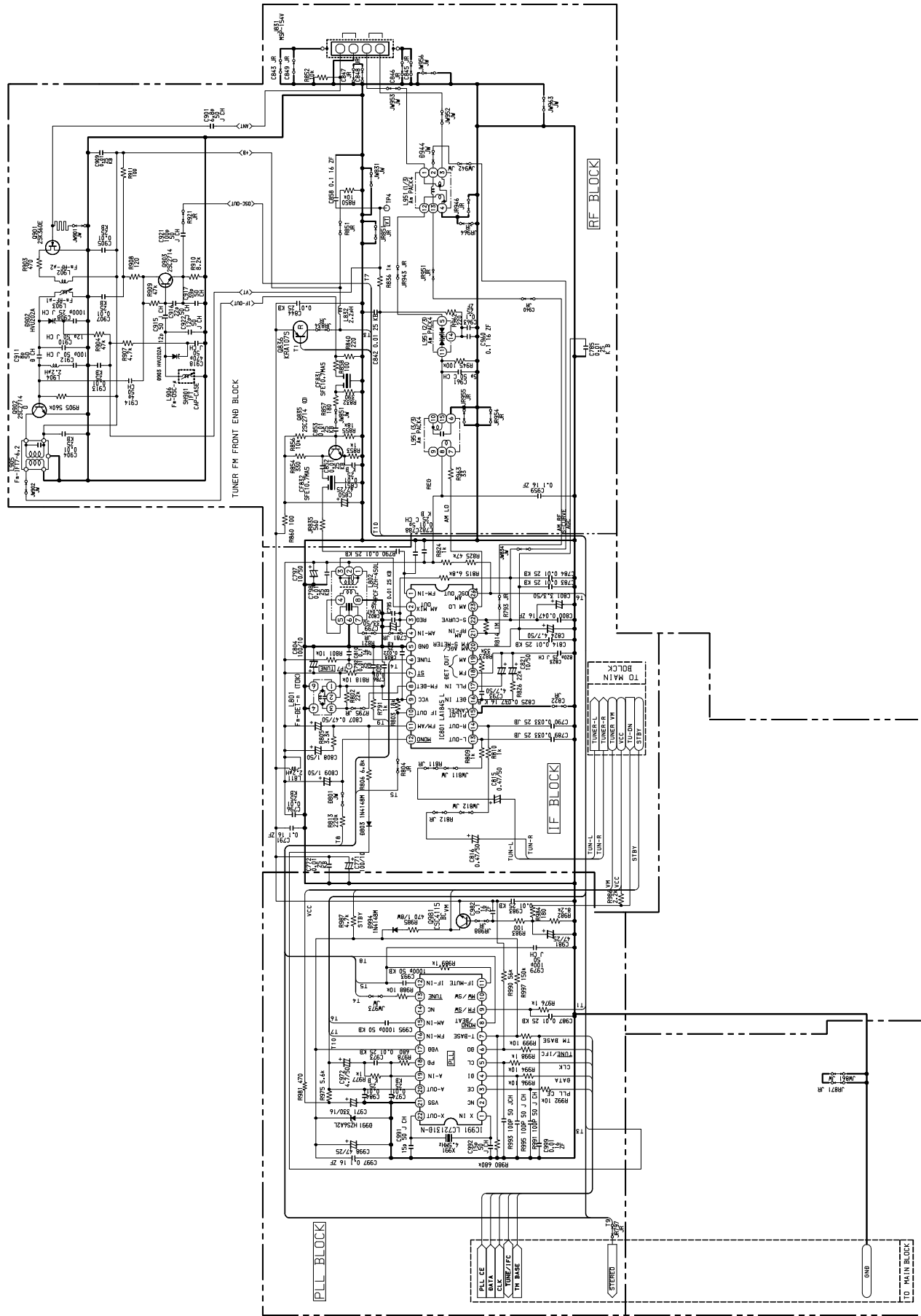

SCHEMATIC DIAGRAM - 6 (TUNER) <EZ>

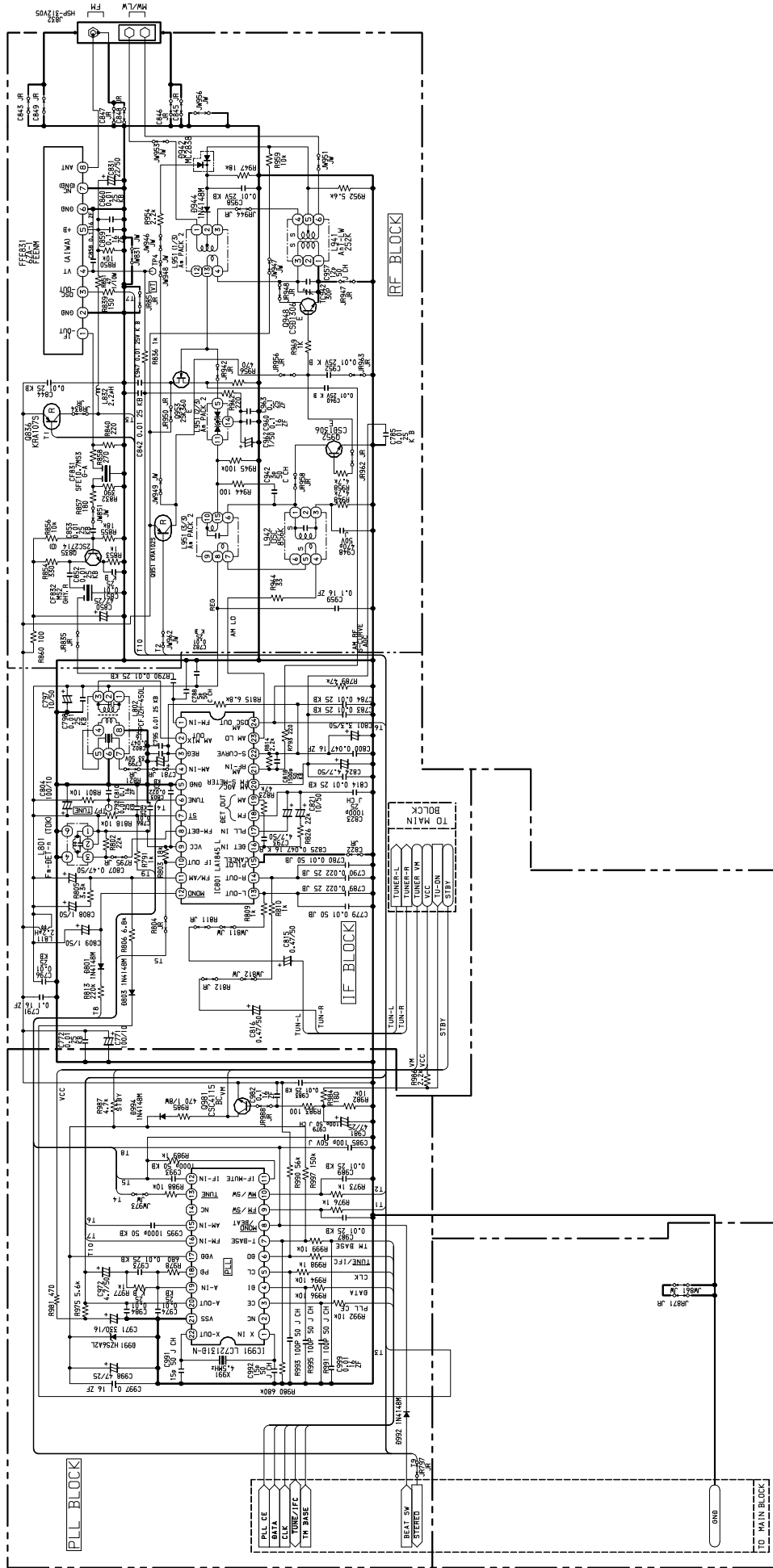

SCHEMATIC DIAGRAM - 7 (FRONT) <U>

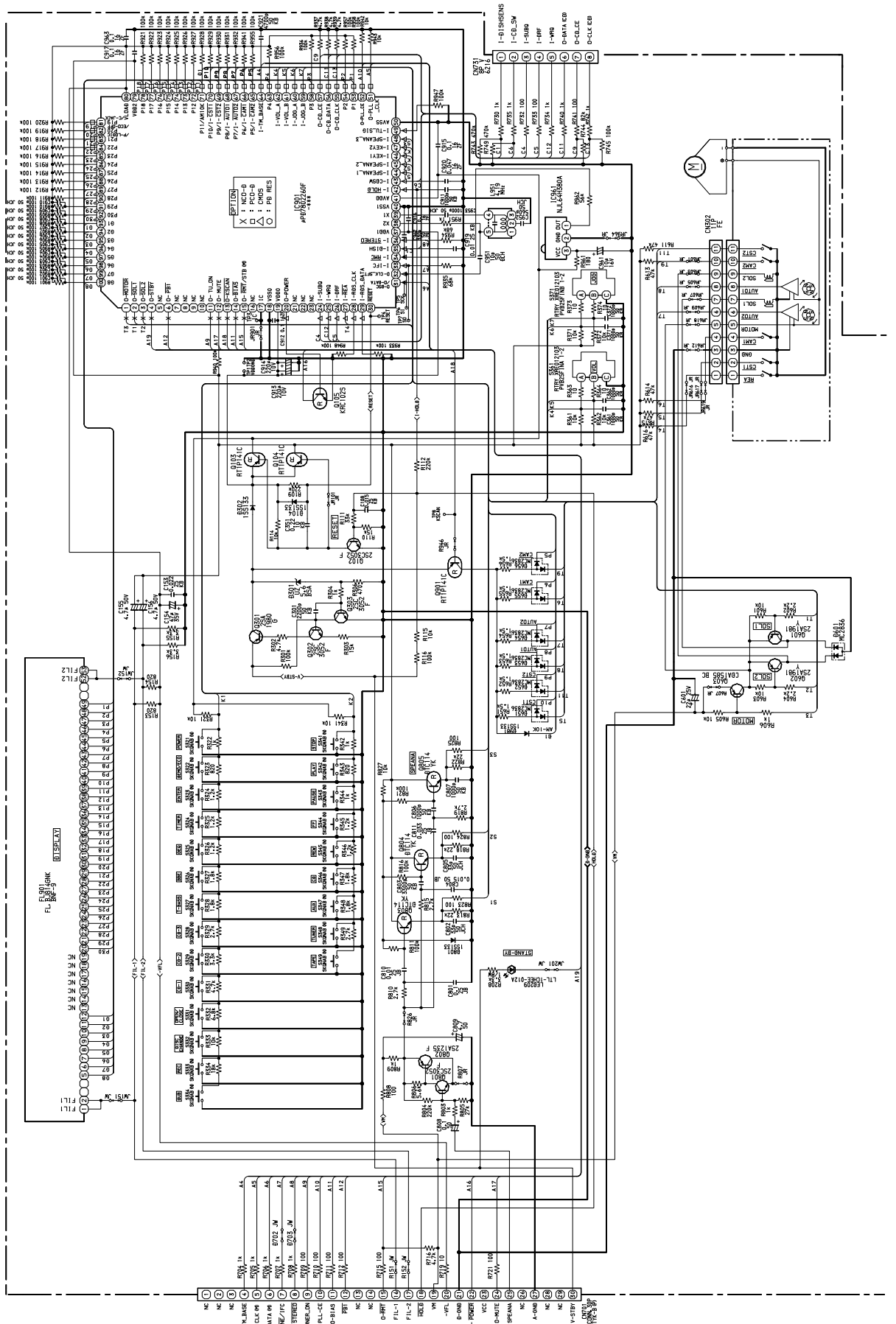

SCHEMATIC DIAGRAM - 8 (FRONT) <LH>

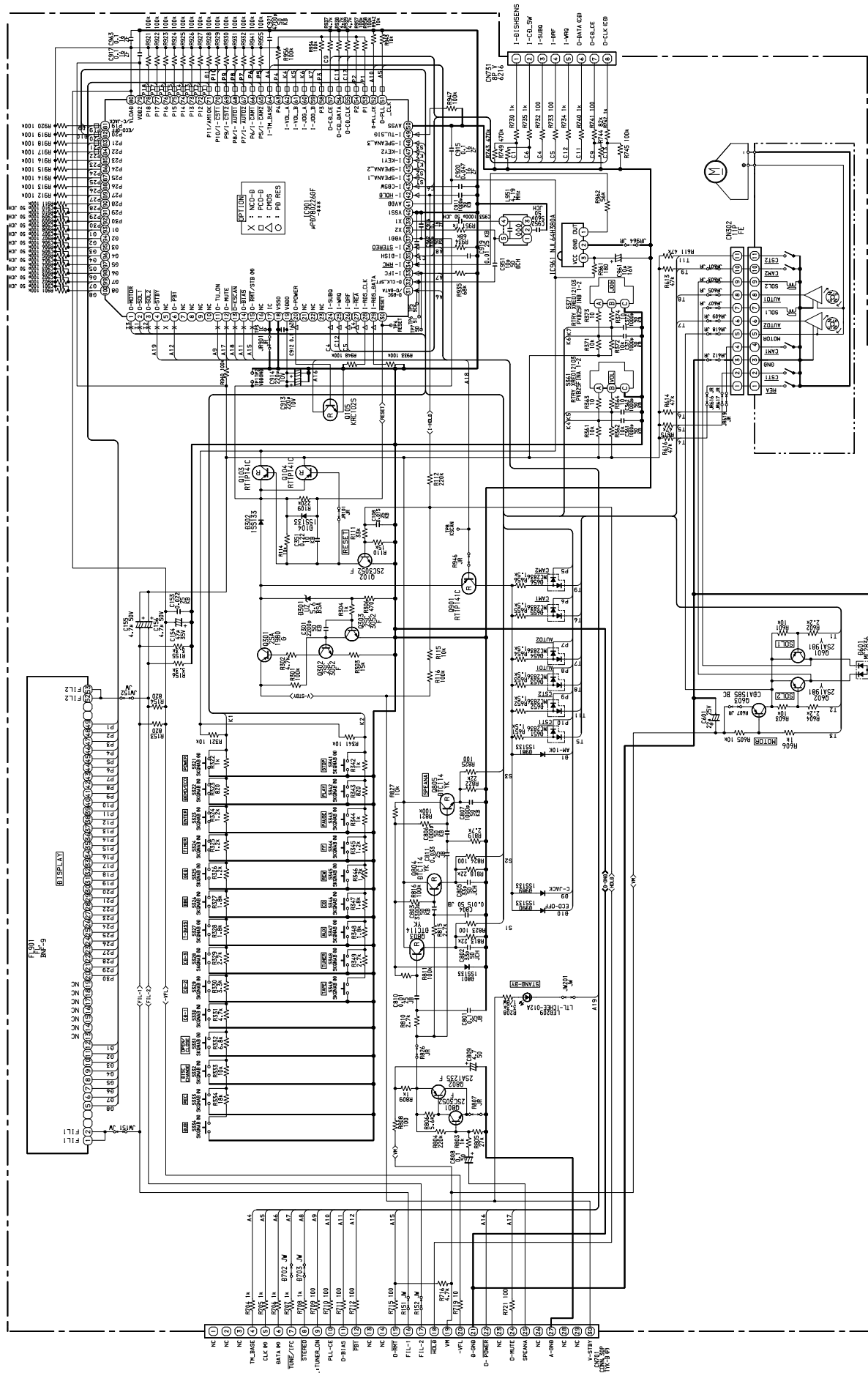

SCHEMATIC DIAGRAM - 9 (FRONT) <EZ>

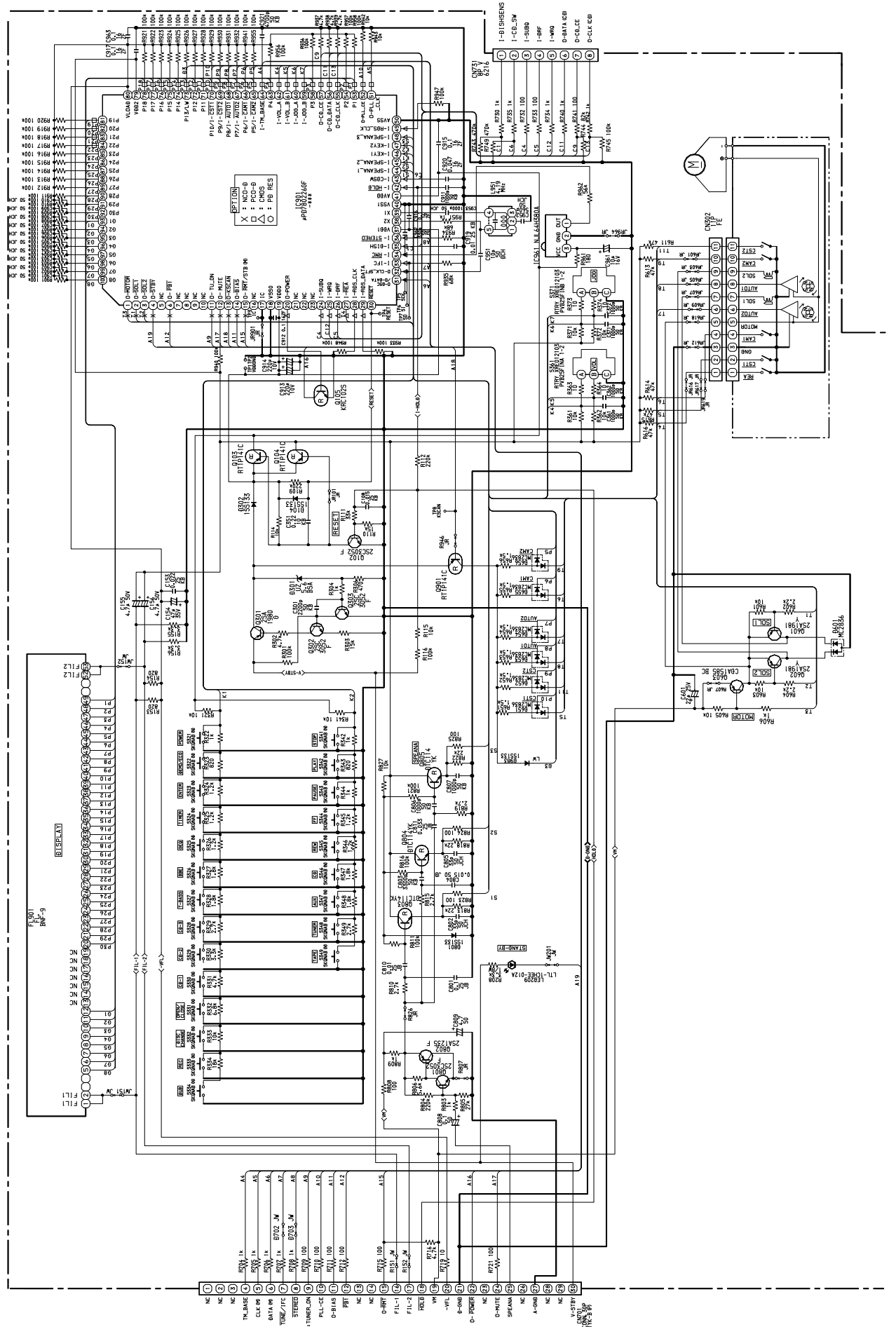

SCHEMATIC DIAGRAM - 10 (PT) <U>

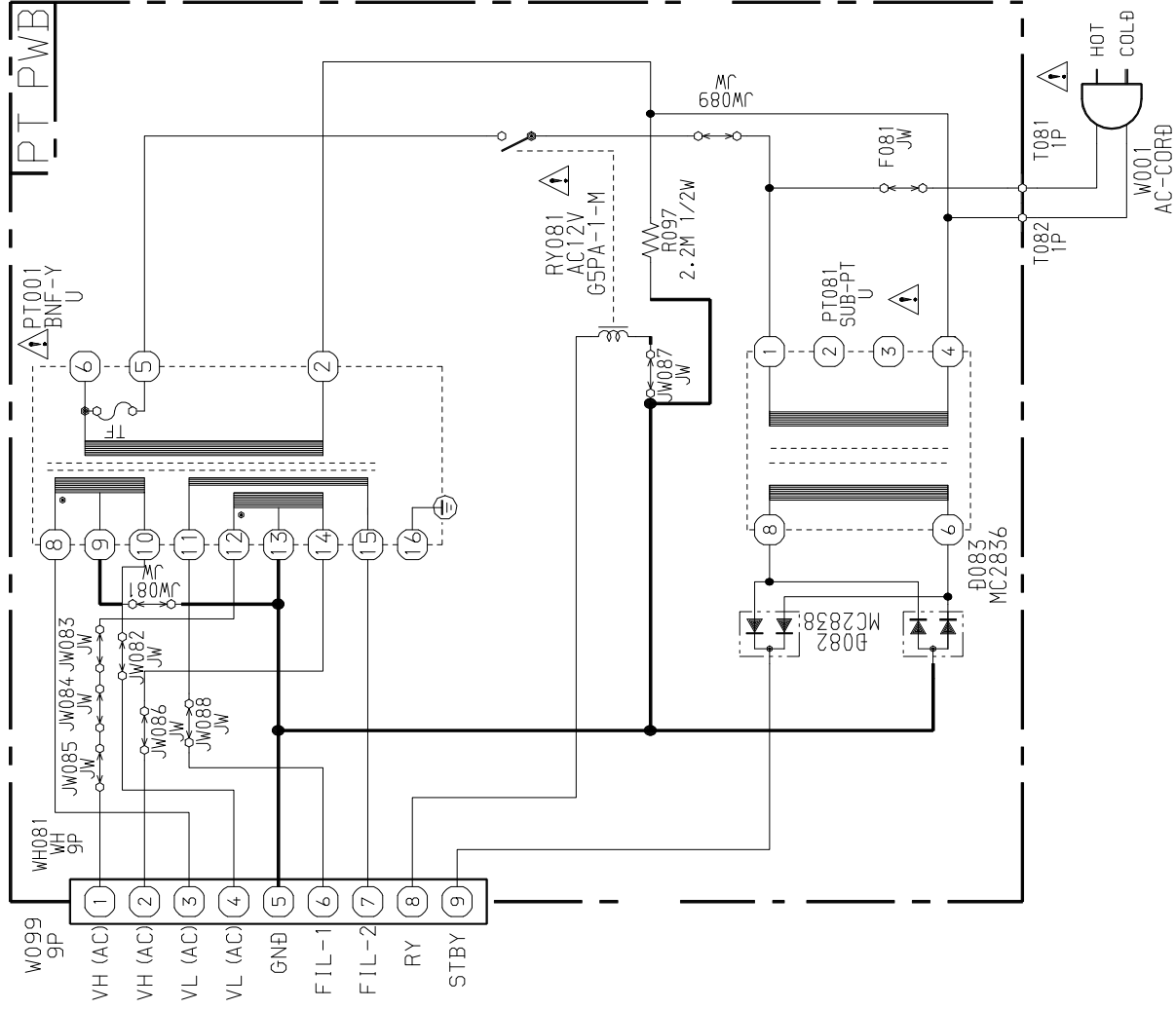

SCHEMATIC DIAGRAM - 11 (PT) <LH>

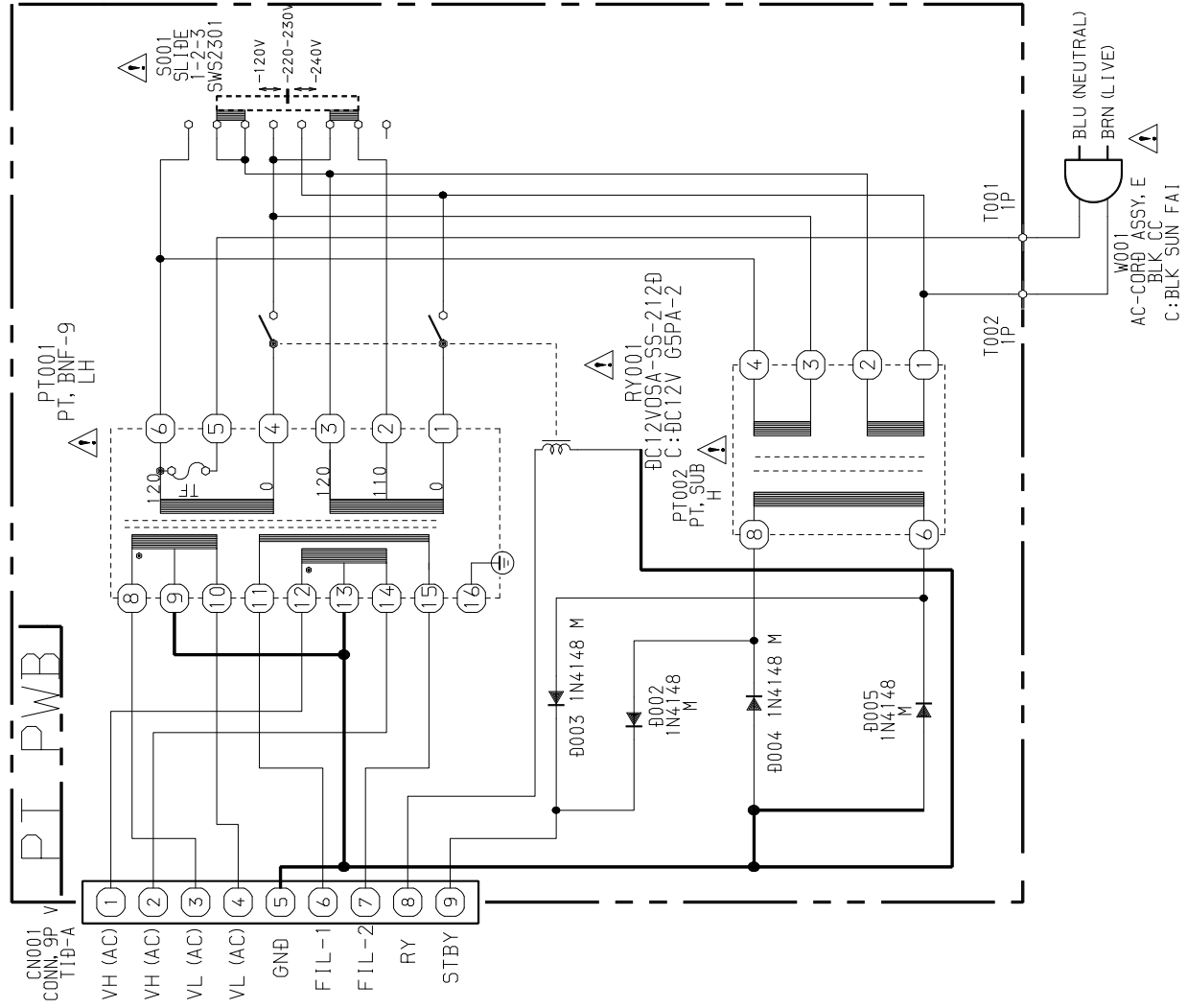

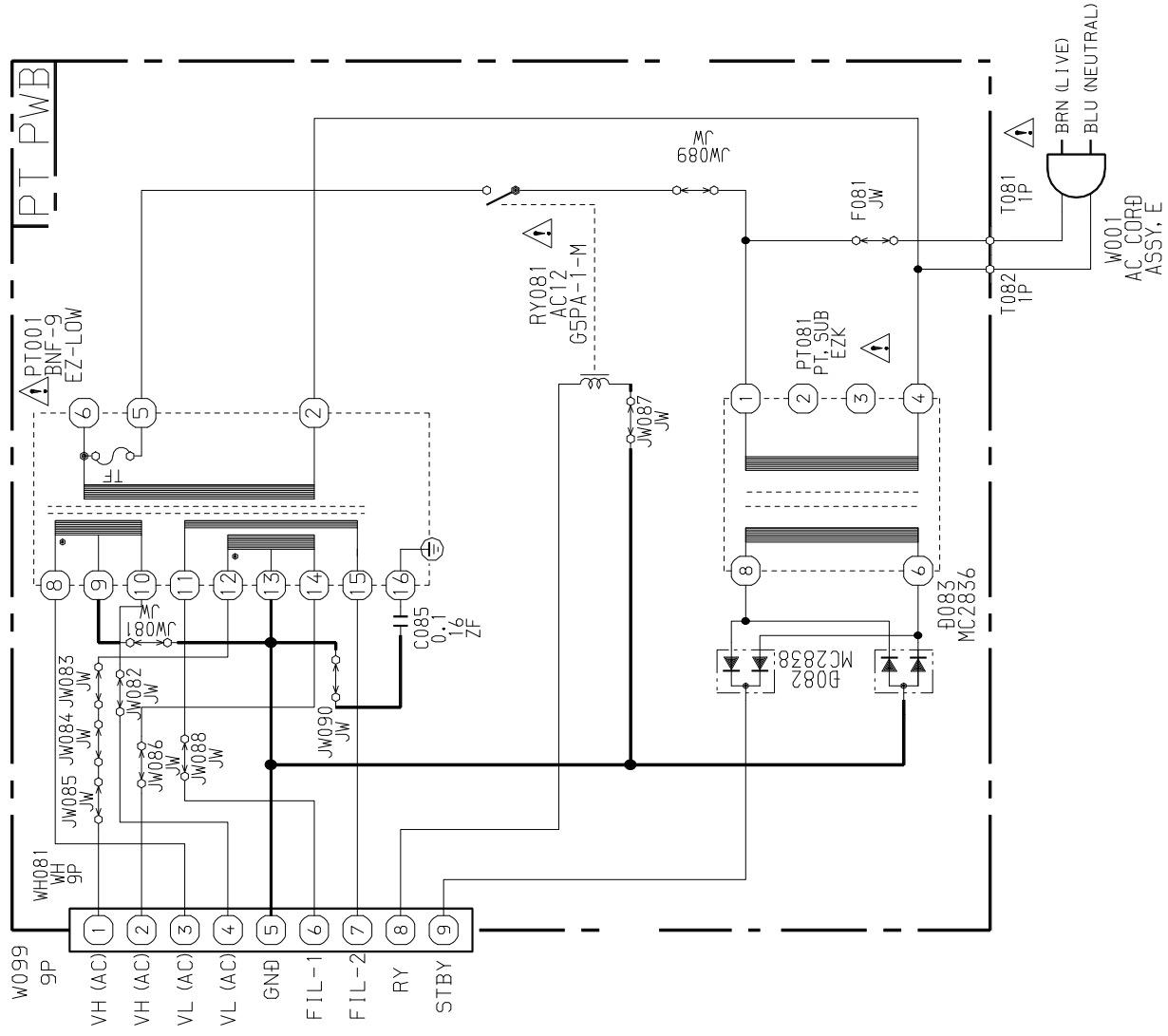



アイワ株式会社 〒110-8710 東京都台東区池之端1-2-11 ☎03(3827)3111 (代表)
AIWA CO.,LTD. 2-11, IKENOHATA 1-CHOME, TAITO-KU, TOKYO 110, JAPAN TEL:03 (3827) 3111