



NSX-SZ70

EZ,HS,K

NSX-SZ72

EZ

NSX-SZ73

EZ

NSX-SZ71

LH

SERVICE MANUAL

COMPACT DISC
STEREO CASSETTE RECEIVER

BASIC CD MECHANISM: AZG-1 ZD3RDM
BASIC TAPE MECHANISM: 2ZM-3MK2 PR4NM

- Replace this Service manual with "Revision Publishing" when it is issued.

aiwa

S/M Code No. 09-002-425-3T3

SIMPLE

DATA

ELECTRICAL MAIN PARTS LIST - 1/8

NOTE: The characters in the suffix column indicate the part usage.

70HSXXC
70KXXD
70EZXXE
72EZXXF
73EZXXG
71LHXXH

REF.NO	PARTS NO.	KANRI NO.	DESCRIPTION	SUFFIX
C	503		CAP,E 0.1-50 SME	.B.....I.K.....
C	504		C-CAP,S 220P-50 CH	.B.....I.K.....
C	521		CHIP CAP 1000P	ABC.....IJK.....
C	606		CAP,E 100-16	ABC.....IJK.....
C	601		CAP,CHIP 4700P	ABC.....IJK.....
C	609		CHIP CAPACITOR,0.1-25	ABC.....IJK.....
C	603		CHIP CAP 68P	ABC.....IJK.....
C	602		CAP,E 10-50	A.C.....J.....
C	604		CAP,E 0.33-50	ABC.....IJK.....
C	652		C-CAP,S 2700P-50 B	ABC.....IJK.....
C	653		C-CAP,S 0.015-50 B	ABC.....IJK.....
FB	601		FILTER, EMI BL OIRNI	ABC.....IJK.....
J	601		JACK,6.3 BLK MONO W/SW V KM	ABC.....IJK.....
Q	502		C-TR,2SA1235F	ABC.....IJK.....
Q	501		C-TR,2SC3052F	ABC.....IJK.....
Q	601		C-FET,2SK2158	A.C.....J.....
VR	501		VR,RTRY 10K15AX1 1 V XV0121PVN	.B.....I.K.....
C	1		87-010-387-080	ABCDEFG.IJK.....
C	6		87-A10-627-000	ABCDEFG.IJK.....
C	7		87-A10-627-000	ABCDEFG.IJK.....
C	8		87-A11-148-080	ABCDEFG.IJK.....
C	9		87-A11-148-080	ABCDEFG.IJK.....
C	4		87-A11-148-080	ABCDEFG.IJK.....
C	5		87-A11-148-080	ABCDEFG.IJK.....
C	16		87-010-403-080	ABCDEFG.IJK.....
C	13		87-016-520-000	...DEFG.IJ.....
C	12		87-016-520-000	...DEFG.IJ.....
C	13		87-016-657-090	ABC.....K.....
C	12		87-016-657-090	ABC.....K.....
C	11		87-A11-148-080	ABCDEFG.IJK.....
C	10		87-A11-148-080	ABCDEFG.IJK.....
CN	2		87-A61-108-010	ABCDEFG.IJK.....
CN	1		87-A61-110-010	ABCDEFG.IJK.....
D	2		87-A40-547-090	ABC.....K.....
D	1		87-A40-548-090	ABCDEFG.IJK.....
D	18		87-020-465-080	ABCDEFG.IJK.....
D	19		87-020-465-080	ABCDEFG.IJK.....
D	20		87-020-465-080	ABCDEFG.IJK.....
D	21		87-020-465-080	ABCDEFG.IJK.....
PT	2		8A-NF8-661-010	...DEFG.IJ.....
PT	2		8A-NF8-662-010	...DEFG.IJ.....
PT	2		8A-NF8-673-010	ABC.....K.....
Q	1		87-026-245-080	ABCDEFG.IJK.....
Q	2		87-A30-198-080	ABCDEFG.IJK.....
RY	2		87-A90-976-010	...DEFG.IJ.....
RY	1		87-A91-281-010	ABC.....K.....
S	1		87-A90-165-010	AB.....K.....
T	2		87-A60-317-010	ABCDEFG.IJK.....
T	1		87-A60-317-010	ABCDEFG.IJK.....
C	101		87-010-183-080	ABCDEFG.IJK.....
C	102		87-010-183-080	ABCDEFG.IJK.....
C	107		87-010-405-080	ABCDEFG.IJK.....
C	108		87-010-405-080	ABCDEFG.IJK.....
C	104		87-010-545-080	ABCDEFG.IJK.....
C	103		87-010-545-080	ABCDEFG.IJK.....
C	111		87-010-179-080	...DEFG.IJK.....
C	112		87-010-179-080	...DEFG.IJK.....
C	119		87-010-197-080	ABCDEFG.IJK.....
C	116		87-010-866-080	ABCDEFG.IJK.....
C	115		87-010-866-080	ABCDEFG.IJK.....
C	120		87-010-197-080	ABCDEFG.IJK.....
C	133		87-010-190-080	ABCDEFG.IJK.....
C	153		87-010-188-080	ABCDEFG.IJK.....
C	206		87-010-180-080	ABCDEFG.IJK.....
C	205		87-010-180-080	ABCDEFG.IJK.....
C	209		87-010-187-080	ABCDEFG.IJK.....
C	208		87-010-401-080	ABCDEFG.IJK.....
C	207		87-010-401-080	ABCDEFG.IJK.....
C	202		87-A10-300-080	ABCDEFG.IJK.....
C	204		87-A10-300-080	ABCDEFG.IJK.....
C	201		87-A10-300-080	ABCDEFG.IJK.....
C	203		87-A10-300-080	ABCDEFG.IJK.....
C	216		87-010-179-080	...DEFG.IJK.....
C	215		87-010-179-080	...DEFG.IJK.....
C	210		87-010-187-080	ABCDEFG.IJK.....
C	212		87-010-402-080	ABCDEFG.IJK.....

ELECTRICAL MAIN PARTS LIST - 2/8

C	211	87-010-402-080	CAP, ELECT 2.2-50V	ABCDEF G. IJK.....
C	217	87-010-403-080	CAP, ELECT 3.3-50V	ABCDEF G. IJK.....
C	218	87-010-403-080	CAP, ELECT 3.3-50V	ABCDEF G. IJK.....
C	216	87-012-140-080	CAP 470P	ABCDEF G. IJK.....
C	215	87-012-140-080	CAP 470P	ABCDEF G. IJK.....
C	223	87-010-197-080	CAP, CHIP 0.01 DM	ABCDEF G. IJK.....
C	224	87-010-197-080	CAP, CHIP 0.01 DM	ABCDEF G. IJK.....
C	258	87-010-190-080	S CHIP F 0.01	ABCDEF G. IJK.....
C	257	87-010-190-080	S CHIP F 0.01	ABCDEF G. IJK.....
C	255	87-010-190-080	S CHIP F 0.01	ABCDEF G. IJK.....
C	256	87-010-190-080	S CHIP F 0.01	ABCDEF G. IJK.....
C	252	87-010-196-080	CHIP CAPACITOR, 0.1-25	ABCDEF G. IJK.....
C	251	87-010-196-080	CHIP CAPACITOR, 0.1-25	ABCDEF G. IJK.....
C	401	87-010-260-080	CAP, ELECT 47-25V	ABCDEF G. IJK.....
CN	101	87-A61-011-010	CONN, 13P H BLK TAC-L13P-A3	ABCDEF G. IJK.....
CN	102	87-A61-011-010	CONN, 13P H BLK TAC-L13P-A3	ABCDEF G. IJK.....
CNA	101	8A-NF8-656-010	CONN ASSY, 5P TID-A 400	ABCDEF G. IJK.....
D	101	87-A40-269-080	C-DIODE, MC2836	ABCDEF G. IJK.....
D	103	87-A40-313-080	C-DIODE, MC 2840	ABCDEF G. IJK.....
D	150	87-A40-270-080	C-DIODE, MC2838	ABCDEF G. IJK.....
D	204	87-020-465-080	DIODE, 1SS133 (110MA)	ABCDEF G. IJK.....
D	201	87-A40-269-080	C-DIODE, MC2836	ABCDEF G. IJK.....
D	203	87-A40-313-080	C-DIODE, MC 2840	ABCDEF G. IJK.....
D	403	87-017-978-080	DIODE, 1N4003	ABCDEF G. IJK.....
D	402	87-017-978-080	DIODE, 1N4003	ABCDEF G. IJK.....
D	401	87-A40-270-080	C-DIODE, MC2838	ABCDEF G. IJK.....
IC	101	87-A21-398-010	IC, STK490-110	...DEF G. IJ.....
IC	101	87-A21-418-010	IC, STK490-340	ABC.....K.....
IC	201	87-A21-396-010	IC, STK490-040	...DEF G. IJ.....
IC	201	87-A21-397-010	IC, STK490-070	ABC.....K.....
J	201	87-A61-148-010	JACK, PIN 4P R/W BLUE	ABCDEF G. IJK.....
L	251	87-A50-610-010	COIL, 1UH K(MDEC)	ABCDEF G. IJK.....
L	252	87-A50-610-010	COIL, 1UH K(MDEC)	ABCDEF G. IJK.....
Q	102	87-A30-107-070	C-TR, CMBT5401	ABCDEF G. IJK.....
Q	101	87-A30-107-070	C-TR, CMBT5401	ABCDEF G. IJK.....
Q	151	87-A30-106-070	C-TR, CMBT5551	ABCDEF G. IJK.....
Q	150	87-A30-107-070	C-TR, CMBT5401	ABCDEF G. IJK.....
Q	203	87-A30-075-080	C-TR, 2SA1235F	ABCDEF G. IJK.....
Q	204	87-A30-075-080	C-TR, 2SA1235F	ABCDEF G. IJK.....
Q	202	87-A30-107-070	C-TR, CMBT5401	ABCDEF G. IJK.....
Q	201	87-A30-107-070	C-TR, CMBT5401	ABCDEF G. IJK.....
Q	401	87-A30-075-080	C-TR, 2SA1235F	ABCDEF G. IJK.....
Q	402	87-A30-075-080	C-TR, 2SA1235F	ABCDEF G. IJK.....
R	129	87-A00-262-080	RES, M/F 0.15-2W J	ABCDEF G. IJK.....
R	130	87-A00-262-080	RES, M/F 0.15-2W J	ABCDEF G. IJK.....
R	231	87-A00-258-080	RES, M/F 0.22-1W J	ABCDEF G. IJK.....
R	232	87-A00-258-080	RES, M/F 0.22-1W J	ABCDEF G. IJK.....
WH	101	87-A90-459-010	HLDR, WIRE 2.5-5P	ABCDEF G. IJK.....
C	101	87-010-190-080	S CHIP F 0.01	ABC.....IJK.....
C	103	87-010-312-080	C-CAP, S 15P-50 CH	ABC.....IJK.....
C	105	87-010-406-040	CAP, E 22-50 SME	ABC.....IJK.....
C	106	87-010-493-040	CAP, E 0.47-50 GAS	ABC.....IJK.....
C	104	87-012-157-080	C-CAP, S 330P-50 CH	ABC.....IJK.....
C	107	87-A10-189-040	CAP, E 220-10	ABC.....IJK.....
C	108	87-A10-189-040	CAP, E 220-10	ABC.....IJK.....
C	110	87-010-178-080	CHIP CAP 1000P	ABC.....IJK.....
C	119	87-010-498-040	CAP, E 10-16 GAS	ABC.....IJK.....
C	118	87-012-145-080	CAP, CHIP S 270P CH	ABC.....IJK.....
C	112	87-012-368-080	C-CAP, S 0.1-50 F	ABC.....IJK.....
C	123	87-012-393-080	C-CAP, S 0.22-16 R K	ABC.....IJK.....
C	182	87-010-178-080	CHIP CAP 1000P	ABC.....IJK.....
C	181	87-010-180-080	C-CER 1500P	ABC.....IJK.....
C	181	87-010-322-080	C-CAP, S 100P-50 CH	ABC.....IJK.....
C	183	87-012-156-080	C-CAP, S 220P-50 CH	ABC.....IJK.....
C	206	87-012-156-080	C-CAP, S 220P-50 CH	ABC.....IJK.....
C	202	87-012-157-080	C-CAP, S 330P-50 CH	ABC.....IJK.....
C	204	87-012-157-080	C-CAP, S 330P-50 CH	ABC.....IJK.....
C	205	87-012-157-080	C-CAP, S 330P-50 CH	ABC.....IJK.....
C	203	87-012-157-080	C-CAP, S 330P-50 CH	ABC.....IJK.....
C	211	87-012-140-080	CAP 470P	ABC.....IJK.....
C	222	87-010-404-040	CAP, E 4.7-50 SME	ABC.....IJK.....
C	223	87-010-408-040	CAP, E 47-50 SME	ABC.....IJK.....
C	221	87-010-421-040	CAP, E 4.7-50 5L	ABC.....IJK.....
C	224	87-012-369-080	C-CAP, S 0.047-50F	ABC.....IJK.....
C	383	87-010-196-080	CHIP CAPACITOR, 0.1-25	ABC.....IJK.....
C	387	87-010-196-080	CHIP CAPACITOR, 0.1-25	ABC.....IJK.....
C	382	87-010-320-080	CHIP CAP 68P	ABC.....IJK.....
C	392	87-010-320-080	CHIP CAP 68P	ABC.....IJK.....
C	701	87-010-260-040	CAP, E 47-25 SME	ABC.....IJK.....
CN	104	87-099-017-010	CONN, 15P 6216 V	ABC.....IJK.....
CN	102	8A-NF7-605-010	CONN ASSY, 4P V 80MM	ABC.....IJK.....
CN	901	87-A60-138-010	CONN, 13P V FE	ABC.....IJK.....
CON	101	87-099-720-010	CONN, 30P TYK-B (P)	ABC.....IJK.....
D	108	87-A40-752-080	ZENER, UZ6.2BSC	ABC.....IJK.....
D	383	87-020-465-080	DIODE, 1SS133 (110MA)	ABC.....IJK.....
D	382	87-020-465-080	DIODE, 1SS133 (110MA)	ABC.....IJK.....
D	384	87-020-465-080	DIODE, 1SS133 (110MA)	ABC.....IJK.....

ELECTRICAL MAIN PARTS LIST - 3/8

D	385	87-A40-802-080	ZENER, UZ5.1BSC	ABC.....IJK.....
D	701	87-A40-269-080	C-DIODE, MC2836	ABC.....IJK.....
FL	201	8A-NF7-601-010	FL, BJ754GNK	ABC.....IJK.....
IC	101	8A-NF6-605-010	C-IC, LC876572V-XXXJ.....
IC	101	8A-NF6-605-130	C-IC, LC876572V5P39I.K.....
IC	101	8A-NF6-610-010	C-IC, LC876564V-XXXI.K.....
IC	101	8A-NF6-610-030	C-IC, LC87654V-5P35	ABC.....IJK.....
IC	251	87-A21-482-010	IC, RPM6938-H4	ABC.....IJK.....
IC	380	87-A21-577-040	C-IC, M61506FP	ABC.....IJK.....
IC	402	87-070-289-040	IC, BU 2092F	ABC.....IJK.....
IC	401	87-A21-021-040	C-IC, BU2099FV	ABC.....IJK.....
L	101	87-A50-333-010	COIL, OSC 9.43MHZ	ABC.....IJK.....
LED	402	87-017-733-080	LED, SEL1250SM	ABC.....IJK.....
LED	404	87-017-733-080	LED, SEL1250SM	ABC.....IJK.....
LED	403	87-017-733-080	LED, SEL1250SM	ABC.....IJK.....
LED	401	87-017-733-080	LED, SEL1250SM	ABC.....IJK.....
LED	405	87-017-733-080	LED, SEL1250SM	ABC.....IJK.....
LED	416	87-A40-619-080	LED, SLR-56PT-TE7-W GRN	ABC.....IJK.....
LED	417	87-A40-619-080	LED, SLR-56PT-TE7-W GRN	ABC.....IJK.....
LED	418	87-A40-619-080	LED, SLR-56PT-TE7-W GRN	ABC.....IJK.....
LED	419	87-A40-619-080	LED, SLR-56PT-TE7-W GRN	ABC.....IJK.....
LED	424	87-A40-317-080	LED, SLR-342VCT31 RED	ABC.....IJK.....
LED	423	87-A40-317-080	LED, SLR-342VCT31 RED	ABC.....IJK.....
LED	422	87-A40-317-080	LED, SLR-342VCT31 RED	ABC.....IJK.....
LED	421	87-A40-619-080	LED, SLR-56PT-TE7-W GRN	ABC.....IJK.....
LED	420	87-A40-619-080	LED, SLR-56PT-TE7-W GRN	ABC.....IJK.....
LED	441	87-A40-563-010	LED, SEL6515C-LF62 PGRN	ABC.....IJK.....
LED	445	87-A40-563-010	LED, SEL6515C-LF62 PGRN	ABC.....IJK.....
LED	444	87-A40-563-010	LED, SEL6515C-LF62 PGRN	ABC.....IJK.....
LED	443	87-A40-563-010	LED, SEL6515C-LF62 PGRN	ABC.....IJK.....
LED	442	87-A40-563-010	LED, SEL6515C-LF62 PGRN	ABC.....IJK.....
LED	440	87-A40-563-010	LED, SEL6515C-LF62 PGRN	ABC.....IJK.....
LED	454	87-A40-678-010	LED, SELU1E10CXM BLUE-DEF	ABC.....IJK.....
LED	455	87-A40-678-010	LED, SELU1E10CXM BLUE-DEF	ABC.....IJK.....
LED	499	87-017-733-080	LED, SEL1250SM	ABC.....IJK.....
Q	107	87-026-610-080	TR, KTC3198GR	ABC.....IJK.....
Q	103	87-A30-073-080	C-TR, RT1N 141C	ABC.....IJK.....
Q	105	87-A30-074-080	C-TR, RT1P 141C	ABC.....IJK.....
Q	104	87-A30-074-080	C-TR, RT1P 141C	ABC.....IJK.....
Q	108	87-A30-074-080	C-TR, RT1P 141C	ABC.....IJK.....
Q	102	87-A30-076-080	C-TR, 2SC3052F	ABC.....IJK.....
Q	101	87-A30-087-080	C-FET, 2SK2158	ABC.....IJK.....
Q	705	87-A30-318-080	TR, CSA952K	ABC.....IJK.....
Q	704	87-A30-318-080	TR, CSA952K	ABC.....IJK.....
Q	701	87-A30-329-080	TR, CD1585BC	ABC.....IJK.....
S	101	87-A91-709-010	SW, RTRY 1-2-24 RE012103 PV	ABC.....IJK.....
S	102	87-A91-710-010	SW, RTRY 1-2-12 RE012103 PV	ABC.....IJK.....
S	346	87-A91-024-180	SW, TACT KSH0611BT	ABC.....IJK.....
S	345	87-A91-024-180	SW, TACT KSH0611BT	ABC.....IJK.....
S	347	87-A91-024-180	SW, TACT KSH0611BT	ABC.....IJK.....
S	349	87-A91-024-180	SW, TACT KSH0611BT	ABC.....IJK.....
S	353	87-A91-024-180	SW, TACT KSH0611BT	ABC.....IJK.....
S	355	87-A91-024-180	SW, TACT KSH0611BT	ABC.....IJK.....
S	351	87-A91-024-180	SW, TACT KSH0611BT	ABC.....IJK.....
S	350	87-A91-024-180	SW, TACT KSH0611BT	ABC.....IJK.....
S	354	87-A91-024-180	SW, TACT KSH0611BT	ABC.....IJK.....
S	352	87-A91-024-180	SW, TACT KSH0611BT	ABC.....IJK.....
C	802	87-010-168-080	CAP, CHIP 150P	ABC.....K.....
C	804	87-010-187-080	CAP, CHIP S5600P	ABC.....K.....
C	808	87-010-196-080	CHIP CAPACITOR, 0.1-25	ABC.....K.....
C	806	87-010-401-040	CAP, E 1-50 SME	ABC.....K.....
C	809	87-012-155-080	C-CAP 180P-50CH	ABC.....K.....
C	810	87-010-263-040	CAP, E 100-10	ABC.....K.....
C	812	87-010-405-040	CAP, E 10-50	ABC.....K.....
C	811	87-010-545-040	CAP, E 0.22-50 SME	ABC.....K.....
D	801	87-A40-748-080	ZENER, UZ5.6BSA	ABC.....K.....
FB	801	87-008-372-080	FILTER, EMI BL OIRNI	ABC.....K.....
IC	801	87-A21-051-040	C-IC, BU9990-03FS	ABC.....K.....
L	802	87-005-847-080	COIL, 2.2UH (CECS)	ABC.....K.....
L	801	87-A50-093-010	COIL, CLOCK 5.76MHZ	ABC.....K.....
C	309	87-010-196-080	CHIP CAPACITOR, 0.1-25	ABCDEFG.IJK.....
C	301	87-010-318-080	C-CAP, S 47P-50 CH	ABCDEFG.IJK.....
C	302	87-010-318-080	C-CAP, S 47P-50 CH	ABCDEFG.IJK.....
C	306	87-012-157-080	C-CAP, S 330P-50 CH	ABCDEFG.IJK.....
C	305	87-012-157-080	C-CAP, S 330P-50 CH	ABCDEFG.IJK.....
C	303	87-012-157-080	C-CAP, S 330P-50 CH	ABCDEFG.IJK.....
C	304	87-012-157-080	C-CAP, S 330P-50 CH	ABCDEFG.IJK.....
C	316	87-010-179-080	CAP, CHIP S B1200P	ABCDEFG.IJK.....
C	315	87-010-179-080	CAP, CHIP S B1200P	ABCDEFG.IJK.....
C	314	87-010-179-080	CAP, CHIP S B1200P	ABCDEFG.IJK.....
C	313	87-010-179-080	CAP, CHIP S B1200P	ABCDEFG.IJK.....
C	313	87-010-181-080	CAP, CHIP S 1800P	...DEFG.IJ.....
C	314	87-010-181-080	CAP, CHIP S 1800P	...DEFG.IJ.....
C	310	87-010-196-080	CHIP CAPACITOR, 0.1-25	ABCDEFG.IJK.....
C	311	87-010-198-080	CAP, CHIP 0.022	ABCDEFG.IJK.....
C	312	87-010-198-080	CAP, CHIP 0.022	ABCDEFG.IJK.....
C	319	87-012-141-080	CHIP-CAPACITOR, 0.22-16F	...DEFG.IJ.....

ELECTRICAL MAIN PARTS LIST - 4/8

C	318	87-A10-201-080	C-CAP,S0.33-16 KB	...DEFG.IJ
C	317	87-A10-201-080	C-CAP,S0.33-16 KB	...DEFG.IJ
C	324	87-010-260-080	CAP, ELECT 47-25V	ABCDEFG.IJK
C	325	87-010-370-080	CAP,E 330-6.3 SME	ABCDEFG.IJK
C	327	87-010-404-080	CAP, ELECT 4.7-50V	ABCDEFG.IJK
C	328	87-010-404-080	CAP, ELECT 4.7-50V	ABCDEFG.IJK
C	321	87-012-141-080	CHIP-CAPACITOR,0.22-16F	...DEFG.IJ
C	320	87-012-141-080	CHIP-CAPACITOR,0.22-16F	...DEFG.IJ
C	322	87-012-141-080	CHIP-CAPACITOR,0.22-16F	...DEFG.IJ
C	322	87-012-142-080	CAP, S 0.33-16	ABC.....K
C	321	87-012-142-080	CAP, S 0.33-16	ABC.....K
C	335	87-010-401-080	CAP, ELECT 1-50V	ABCDEFG.IJK
C	336	87-010-401-080	CAP, ELECT 1-50V	ABCDEFG.IJK
C	354	87-010-175-080	CAP 560P	ABCDEFG.IJK
C	355	87-010-178-080	CHIP CAP 1000P	ABCDEFG.IJK
C	358	87-010-183-080	C-CAP,S 2700P-50 B	ABCDEFG.IJK
C	359	87-010-183-080	C-CAP,S 2700P-50 B	ABCDEFG.IJK
C	357	87-010-197-080	CAP, CHIP 0.01 DM	ABCDEFG.IJK
C	356	87-010-260-080	CAP, ELECT 47-25V	ABCDEFG.IJK
C	352	87-012-140-080	CAP 470P	ABCDEFG.IJK
C	351	87-012-140-080	CAP 470P	ABCDEFG.IJK
C	360	87-010-183-080	C-CAP,S 2700P-50 B	ABCDEFG.IJK
C	363	87-A10-292-080	CAP,M 5600P-50 J	ABCDEFG.IJK
C	379	87-010-382-080	CAP, ELECT 22-25V	ABC.....K
C	375	87-010-545-080	CAP, ELECT 0.22-50V	...DEFG.IJ
C	376	87-010-545-080	CAP, ELECT 0.22-50V	...DEFG.IJ
C	374	87-016-083-080	C-CAP,S 0.15-16 RK	ABC.....K
C	373	87-016-083-080	C-CAP,S 0.15-16 RK	ABC.....K
C	385	87-010-184-080	CHIP CAPACITOR 3300P(K)	...DEFG.IJ
C	381	87-010-197-080	CAP, CHIP 0.01 DM	ABCDEFG.IJK
C	383	87-010-197-080	CAP, CHIP 0.01 DM	ABCDEFG.IJK
C	382	87-010-312-080	C-CAP,S 15P-50 CH	ABC.....K
C	380	87-010-382-080	CAP, ELECT 22-25V	ABC.....K
C	384	87-010-402-080	CAP, ELECT 2.2-50V	ABCDEFG.IJK
C	387	87-012-145-080	CAP, CHIP S 270P CH	ABCDEFG.IJK
C	388	87-012-156-080	C-CAP,S 220P-50 CH	ABCDEFG.IJK
C	394	87-010-319-080	C-CAP,S 56P-50 CH	ABC.....K
C	392	87-010-319-080	C-CAP,S 56P-50 CH	ABC.....K
C	393	87-010-319-080	C-CAP,S 56P-50 CH	ABC.....K
C	391	87-010-319-080	C-CAP,S 56P-50 CH	ABC.....K
CN	301	87-A60-620-010	CONN,3P V 2MM JMT	ABCDEFG.IJK
CN	351	87-A60-625-010	CONN,8P V 2MM JMT	ABCDEFG.IJK
D	353	87-020-465-080	DIODE,1SS133 (110MA)	ABCDEFG.IJK
D	352	87-020-465-080	DIODE,1SS133 (110MA)	ABCDEFG.IJK
FB	301	87-008-372-080	FILTER, EMI BL OIRNI	...DEFG.IJ
IC	302	87-A20-355-010	IC,CXA1553P	...DEFG.IJ
IC	303	87-A20-783-040	C-IC,BA7762AFS	ABCDEFG.IJK
L	302	87-A50-049-010	COIL,TRAP 85K(COI)	ABCDEFG
L	301	87-A50-049-010	COIL,TRAP 85K(COI)	ABCDEFG
L	301	87-A50-625-010	COIL,TRAP 85KHZ (SANWA)IJK
L	302	87-A50-625-010	COIL,TRAP 85KHZ (SANWA)IJK
L	351	87-007-342-010	COIL,OSC 85K BIAS	ABCDEFG.IJK
Q	357	87-026-609-080	TR,KTA1266GR	ABCDEFG.IJK
QQ	359	87-026-610-080	TR,KTC3198GR	ABCDEFG.IJK
QQ	358	87-026-610-080	TR,KTC3198GR	ABCDEFG.IJK
QQ	354	87-A30-087-080	C-FET,2SK2158	ABCDEFG.IJK
QQ	351	87-A30-087-080	C-FET,2SK2158	ABCDEFG.IJK
QQ	353	87-A30-087-080	C-FET,2SK2158	ABCDEFG.IJK
QQ	355	87-A30-105-080	C-TR,RT1P 441C	ABCDEFG.IJK
Q	361	87-A30-076-080	C-TR,2SC3052F	ABCDEFG.IJK
Q	383	87-A30-075-080	C-TR,2SA1235F	ABC.....K
Q	381	87-A30-076-080	C-TR,2SC3052F	ABCDEFG.IJK
Q	382	87-A30-076-080	C-TR,2SC3052F	ABCDEFG.IJK
SFR	303	87-A90-557-080	SFR,33K H HOKU	...DEFG.IJ
SFR	302	87-A90-557-080	SFR,33K H HOKU	...DEFG.IJ
SFR	301	87-A90-557-080	SFR,33K H HOKU	...DEFG.IJ
SFR	304	87-A90-557-080	SFR,33K H HOKU	...DEFG.IJ
SFR	351	87-A90-433-080	SFR,50K H NVZ6TLTA	ABCDEFG.IJK
SFR	352	87-A90-433-080	SFR,50K H NVZ6TLTA	ABCDEFG.IJK
C	104	87-010-196-080	CHIP CAPACITOR,0.1-25	ABCDEFG.IJK
C	105	87-010-196-080	CHIP CAPACITOR,0.1-25	ABCDEFG.IJK
C	115	87-010-546-080	CAP, ELECT 0.33-50V	ABCDEFG.IJK
C	116	87-010-546-080	CAP, ELECT 0.33-50V	ABCDEFG.IJK
C	122	87-010-545-080	CAP, ELECT 0.22-50V	ABCDEFG.IJK
C	121	87-010-545-080	CAP, ELECT 0.22-50V	ABCDEFG.IJK
C	161	87-010-176-080	C-CAP,S 680P-50 SL	...DEFG.IJ
C	162	87-010-176-080	C-CAP,S 680P-50 SL	...DEFG.IJ
C	173	87-012-368-080	C-CAP,S 0.1-50 F	ABCDEFG.IJK
C	172	87-012-368-080	C-CAP,S 0.1-50 F	ABCDEFG.IJK
C	171	87-012-368-080	C-CAP,S 0.1-50 F	ABCDEFG.IJK
C	174	87-012-368-080	C-CAP,S 0.1-50 F	ABCDEFG.IJK
CN	101	87-A60-996-010	CONN,13P V BLK TAC-L13X-A3	ABCDEFG.IJK
J	102	87-A60-238-010	TERMINAL,SP 4P (MSC)	ABCDEFG.IJK
J	101	87-A60-483-010	JACK,DIA6.3 BLK ST W/S KM	ABCDEFG.IJK
L	102	87-A50-610-010	COIL,1UH K(MDEC)	ABCDEFG.IJK
L	101	87-A50-610-010	COIL,1UH K(MDEC)	ABCDEFG.IJK
Q	104	87-A30-076-080	C-TR,2SC3052F	ABCDEFG.IJK

ELECTRICAL MAIN PARTS LIST - 5/8

Q	101	87-A30-076-080	C-TR,2SC3052F	ABCDEF.G.IJK.....
Q	109	87-A30-076-080	C-TR,2SC3052F	ABCDEF.G.IJK.....
Q	103	87-A30-076-080	C-TR,2SC3052F	ABCDEF.G.IJK.....
Q	102	87-A30-076-080	C-TR,2SC3052F	ABCDEF.G.IJK.....
Q	108	87-A30-076-080	C-TR,2SC3052F	ABCDEF.G.IJK.....
Q	107	87-A30-076-080	C-TR,2SC3052F	ABCDEF.G.IJK.....
Q	106	87-A30-269-040	C-FET,2SJ461-T1	ABCDEF.G.IJK.....
Q	105	87-A30-269-040	C-FET,2SJ461-T1	ABCDEF.G.IJK.....
Q	113	87-A30-075-080	C-TR,2SA1235F	ABCDEF.G.IJK.....
Q	110	87-A30-076-080	C-TR,2SC3052F	ABCDEF.G.IJK.....
R	164	87-A00-441-050	RES,270-1/2W J RP	ABCDEF.G.IJK.....
R	162	87-A00-441-050	RES,270-1/2W J RP	ABCDEF.G.IJK.....
R	163	87-A00-441-050	RES,270-1/2W J RP	ABCDEF.G.IJK.....
R	161	87-A00-441-050	RES,270-1/2W J RP	ABCDEF.G.IJK.....
C	974	87-010-197-080	CAP,CHIP 0.01 DM	ABCDEF.G.IJK.....
C	973	87-010-197-080	CAP,CHIP 0.01 DM	ABCDEF.G.IJK.....
C	971	87-010-381-080	CAP,ELECT 330-16V	ABCDEF.G.IJK.....
C	972	87-010-404-080	CAP,ELECT 4.7-50V	ABCDEF.G.IJK.....
C	982	87-010-196-080	CHIP CAPACITOR,0.1-25	ABCDEF.G.IJK.....
C	983	87-010-197-080	CAP,CHIP 0.01 DM	ABCDEF.G.IJK.....
C	987	87-010-197-080	CAP,CHIP 0.01 DM	ABCDEF.G.IJK.....
C	984	87-010-197-080	CAP,CHIP 0.01 DM	ABCDEF.G.IJK.....
C	981	87-010-260-080	CAP,ELECT 47-25V	ABCDEF.G.IJK.....
C	993	87-010-178-080	CHIP CAP 1000P	ABCDEF.G.IJK.....
C	995	87-010-178-080	CHIP CAP 1000P	ABCDEF.G.IJK.....
C	997	87-010-196-080	CHIP CAPACITOR,0.1-25	ABCDEF.G.IJK.....
C	998	87-010-260-080	CAP,ELECT 47-25V	ABCDEF.G.IJK.....
C	991	87-010-312-080	C-CAP,S 15P-50 CH	ABCDEF.G.IJK.....
C	992	87-010-312-080	C-CAP,S 15P-50 CH	ABCDEF.G.IJK.....
C	999	87-A11-155-080	CAP,TC U 0.01-16 Z F	ABCDEF.G.IJK.....
D	804	87-020-465-080	DIODE,1SS133 (110MA)	ABCDEF.G.IJK.....
D	991	87-017-149-080	ZENER,HZS6A2L	ABCDEF.G.IJK.....
IC	991	87-070-127-110	IC,LC72131 D	ABCDEF.G.IJK.....
Q	981	87-A30-234-080	TR,CSC4115BC	ABCDEF.G.IJK.....
R	993	87-010-322-080	C-CAP,S 100P-50 CH	ABCDEF.G.IJK.....
R	995	87-010-322-080	C-CAP,S 100P-50 CH	ABCDEF.G.IJK.....
R	991	87-010-322-080	C-CAP,S 100P-50 CH	ABCDEF.G.IJK.....
X	991	87-A70-061-010	VIB,XTAL 4.500MHZ CSA-309	ABCDEF.G.IJK.....
C	779	87-010-182-080	C-CAP,S 2200P-50 B	A..DEFG.IJ.....
C	773	87-010-184-080	CHIP CAPACITOR 3300P(K)	..DEFG.IJK.....
C	774	87-010-184-080	CHIP CAPACITOR 3300P(K)	..DEFG.IJK.....
C	771	87-010-263-080	CAP,ELECT 100-10V	ABCDEF.G.IJK.....
C	779	87-010-426-080	C-CAP,S 0.012-25 B	.BC.....K.....
C	788	87-010-149-080	C-CAP,S 5P-50 CH	ABCDEF.G.IJK.....
C	780	87-010-182-080	C-CAP,S 2200P-50 B	A..DEFG.IJ.....
C	780	87-010-426-080	C-CAP,S 0.012-25 B	.BC.....K.....
C	789	87-A10-592-080	C-CAP,S 0.015-50 J B	ABCDEF.G.IJK.....
C	791	87-010-196-080	CHIP CAPACITOR,0.1-25	ABCDEF.G.IJK.....
C	793	87-010-404-080	CAP,ELECT 4.7-50V	ABCDEF.G.IJK.....
C	797	87-010-405-080	CAP,ELECT 10-50V	ABCDEF.G.IJK.....
C	799	87-010-407-080	CAP,ELECT 33-50V	ABCDEF.G.IJK.....
C	790	87-A10-592-080	C-CAP,S 0.015-50 J B	ABCDEF.G.IJK.....
C	803	87-010-198-080	CAP,CHIP 0.022	ABCDEF.G.IJK.....
C	804	87-010-263-080	CAP,ELECT 100-10V	ABCDEF.G.IJK.....
C	807	87-010-400-080	CAP,ELECT 0.47-50V	ABCDEF.G.IJK.....
C	809	87-010-401-080	CAP,ELECT 1-50V	ABCDEF.G.IJK.....
C	808	87-010-401-080	CAP,ELECT 1-50V	ABCDEF.G.IJK.....
C	801	87-010-403-080	CAP,ELECT 3.3-50V	ABCDEF.G.IJK.....
C	800	87-012-369-080	C-CAP,S 0.047-50F	ABCDEF.G.IJK.....
C	802	87-012-369-080	C-CAP,S 0.047-50F	ABCDEF.G.IJK.....
C	819	87-010-179-080	CAP,CHIP S B1200P	..DEFG.IJK.....
C	810	87-010-196-080	CHIP CAPACITOR,0.1-25	ABCDEF.G.IJK.....
C	811	87-010-403-080	CAP,ELECT 3.3-50V	ABCDEF.G.IJK.....
C	815	87-010-403-080	CAP,ELECT 3.3-50V	ABCDEF.G.IJK.....
C	816	87-010-403-080	CAP,ELECT 3.3-50V	ABCDEF.G.IJK.....
C	812	87-010-403-080	CAP,ELECT 3.3-50V	ABCDEF.G.IJK.....
C	823	87-010-177-080	C-CAP,S 820P-50 SL	ABC.....K.....
C	820	87-010-179-080	CAP,CHIP S B1200P	..DEFG.IJK.....
C	824	87-010-405-080	CAP,ELECT 10-50V	ABCDEF.G.IJK.....
C	821	87-010-405-080	CAP,ELECT 10-50V	ABCDEF.G.IJK.....
C	825	87-010-596-080	CAP,S 0.047-16	ABCDEF.G.IJK.....
C	823	87-012-349-080	C-CAP,S 1000P-50 CH	..DEFG.IJ.....
D	803	87-020-465-080	DIODE,1SS133 (110MA)	ABCDEF.G.IJK.....
IC	801	87-A21-560-010	IC,LA1844L-A	ABCDEF.G.IJK.....
L	801	87-A50-608-010	COIL,FM DET-N(TOK)	ABCDEF.G.IJK.....
L	802	87-A91-551-010	FLTR,PCFJZH-450 L(TOK)	.BCDEF.G.IJK.....
L	802	87-A91-552-010	FLTR,CFMT-450AL (TOK)	A.....
L	811	87-005-847-080	COIL,2.2UH(CECS)	ABCDEF.G.IJK.....
L	821	87-A50-027-010	COIL,1 POLE MPX(TOK)	A..DEFG.IJ.....
L	822	87-A50-027-010	COIL,1 POLE MPX(TOK)	A..DEFG.IJ.....
L	821	87-A50-209-010	COIL,1POLE MPX(MIT)	.BC.....K.....
L	822	87-A50-209-010	COIL,1POLE MPX(MIT)	.BC.....K.....
Q	801	87-A30-076-080	C-TR,2SC3052F	ABCDEF.G.IJK.....
Q	802	87-A30-076-080	C-TR,2SC3052F	ABCDEF.G.IJK.....
R	790	87-010-197-080	CAP,CHIP 0.01 DM	ABCDEF.G.IJK.....
C	869	87-010-197-080	CAP,CHIP 0.01 DMFG..J.....
C	875	87-010-196-080	CHIP CAPACITOR,0.1-25FG..J.....

ELECTRICAL MAIN PARTS LIST - 6/8

C	877	87-010-197-080	CAP, CHIP 0.01 DMFG..J
C	879	87-010-314-080	C-CAP,S 22P-50VFG..J
C	878	87-010-316-080	C-CAP,S 33P-50 CHFG..J
C	874	87-010-405-080	CAP, ELECT 10-50VFG..J
C	876	87-010-405-080	CAP, ELECT 10-50VFG..J
C	873	87-012-140-080	CAP 470PFG..J
C	872	87-012-156-080	C-CAP,S 220P-50 CHFG..J
C	871	87-012-156-080	C-CAP,S 220P-50 CHFG..J
C	870	87-018-131-080	CAP, CER 1000P-50VFG..J
IC	861	87-A20-440-040	C-IC,BU1920FSFG..J
L	861	87-005-847-080	COIL, 2.2UH(CECS)FG..J
Q	863	87-A30-076-080	C-TR,2SC3052FFG..J
Q	861	87-A30-076-080	C-TR,2SC3052FFG..J
X	861	87-A70-091-010	VIB,XTAL 4.332MHZ CSA-309FG..J
C	818	87-010-180-080	C-CER 1500P	...DEFG.IJ
C	831	87-010-406-080	CAP, ELECT 22-50	...DEFG.IJ
C	846	87-010-190-080	S CHIP F 0.01	ABCDEFG.IJK
C	847	87-010-190-080	S CHIP F 0.01	ABCDEFG.IJK
C	843	87-010-190-080	S CHIP F 0.01	ABCDEFG.IJK
C	848	87-010-190-080	S CHIP F 0.01	ABCDEFG.IJK
C	845	87-010-190-080	S CHIP F 0.01	ABCDEFG.IJK
C	849	87-010-190-080	S CHIP F 0.01	ABCDEFG.IJK
C	844	87-010-197-080	CAP, CHIP 0.01 DM	ABCDEFG.IJK
C	842	87-010-197-080	CAP, CHIP 0.01 DM	ABCDEFG.IJK
C	851	87-010-197-080	CAP, CHIP 0.01 DM	ABCDEFG.IJK
C	853	87-010-197-080	CAP, CHIP 0.01 DM	ABCDEFG.IJK
C	852	87-010-197-080	CAP, CHIP 0.01 DM	ABCDEFG.IJK
C	850	87-010-260-080	CAP, ELECT 47-25V	ABCDEFG.IJK
C	860	87-010-197-080	CAP, CHIP 0.01 DM	ABCDEFG.IJK
C	948	87-010-148-080	CAP, CHIP S 75P SL	A.....
C	942	87-010-149-080	C-CAP,S 5P-50 CH	...DEFG.IJ
C	941	87-010-314-080	C-CAP,S 22P-50V	A.....
C	946	87-010-971-080	C-CAP,S 4700P-50 B J	A.....
C	948	87-012-140-080	CAP 470P	...DEFG.IJ
C	956	87-010-263-080	CAP, ELECT 100-10V	A.....
C	957	87-010-311-080	CAP 12P	...DEFG.IJ
C	954	87-010-400-080	CAP, ELECT 0.47-50V	A.....
C	961	87-010-152-080	C-CAP,S 8P-50 CH	.BC.....K
C	960	87-010-196-080	CHIP CAPACITOR,0.1-25	ABCDEFG.IJK
C	962	87-010-401-080	CAP, ELECT 1-50V	A..DEFG.IJ
C	964	87-010-854-080	C-CAP,S 560PCH	A.....
C	963	87-015-785-080	CHIP CAPACITOR, 0.1FZ-25Z	ABCDEFG.IJK
CF	832	82-785-747-010	CF MS2 GHY R	...DEFG.IJ
CF	832	87-008-261-010	FILTER, SFE10.7MA5-A	ABC.....K
CF	831	87-008-261-010	FILTER, SFE10.7MA5-A	ABC.....K
CF	831	87-008-423-010	CERAMIC FILTER, SFE10.7	...DEFG.IJ
D	944	87-020-465-080	DIODE,1SS133 (110MA)	A..DEFG.IJ
D	942	87-A40-270-080	C-DIODE,MC2838	...DEFG.IJ
D	951	87-A40-618-080	VARI-CAP,SVC 348 (S/T)	A.....
FFE	831	A8-6ZA-191-130	6ZA-1 FEENMIJ
FFE	831	A8-6ZA-19C-170	6ZA-1 YFEENC	...DEFG
FFE	831	A8-8ZA-190-030	8ZA-1 FEUNM	ABC.....
FFE	831	A8-8ZA-191-030	8ZA-1 YFEUNMK
FFE	831	A8-8ZA-193-070	8ZA-1 YFEUNC
J	831	87-A60-202-010	TERMINAL,ANT 4P MSP-154V-02	ABC.....K
J	832	87-A60-403-010	TERMINAL,ANT PAL 2P HSP-312V05	...DEFG.IJ
J	940	81-754-629-010	CONNECTOR, 2P	A.....
L	832	87-005-847-080	COIL, 2.2UH(CECS)	ABCDEFG.IJK
L	942	87-A50-019-010	COIL,OSC LW(COI)	...DEFG.IJ
L	941	87-A50-020-010	COIL,ANT LW(COI)	...DEFG.IJ
L	941	87-A50-022-010	COIL,ANT SW(COI)	A.....
L	944	87-A50-159-010	COIL,10MH K C2B	A.....
L	943	87-A50-522-080	COIL,1MH K CEC	A.....
L	942	87-A50-550-010	COIL,OSC SW-2N(COI)	A.....
L	952	87-A50-430-010	COIL,ANT MW(3BSW)	A.....
L	953	87-A50-431-010	COIL,OSC MW(3BSW)	A.....
L	951	8A-NF8-667-010	COIL,AM PACK 4(TOK)	.BC.....K
L	951	8A-NF8-668-010	COIL,AM PACK 2(TOK)	...DEFG.IJ
Q	836	87-A30-072-080	C-TR,RT1P 144C	ABCDEFG.IJK
Q	835	89-327-143-080	TR,2SC2714 (0.1W)	ABCDEFG.IJK
Q	942	87-A30-075-080	C-TR,2SA1235F	A.....
Q	943	87-A30-075-080	C-TR,2SA1235F	A.....
Q	944	87-A30-076-080	C-TR,2SC3052F	A.....
Q	945	87-A30-076-080	C-TR,2SC3052F	A.....
Q	949	87-A30-076-080	C-TR,2SC3052F	A.....
Q	948	87-A30-086-070	C-TR,CSD1306E	A..DEFG.IJ
Q	951	87-A30-074-080	C-TR,RT1P 141C	A..DEFG.IJ
Q	952	87-A30-086-070	C-TR,CSD1306E	A..DEFG.IJ
Q	953	89-503-602-080	C-FET,2SK360E	A..DEFG.IJ
TC	942	87-011-253-080	TRIMER,30P LAR	A..DEFG.IJ
TC	941	87-011-254-080	TRIMER,20P LAR	A.....
		87-A91-711-010	FAN, 3110GL-B4W-B34-H02 -400MM	ABC.....IJK
C	3	87-012-368-080	C-CAP,S 0.1-50 F	ABCDEFG.IJK
C	4	87-012-368-080	C-CAP,S 0.1-50 F	ABCDEFG.IJK
C	25	87-010-405-080	CAP, ELECT 10-50V	ABC.....K
C	27	87-010-405-080	CAP, ELECT 10-50V	ABC.....K
C	28	87-010-406-080	CAP, ELECT 22-50	ABCDEFG.IJK

ELECTRICAL MAIN PARTS LIST - 7/8

C	26	87-010-406-080	CAP, ELECT 22-50	ABCDEF G. IJK.
C	22	87-016-658-000	CAP, E 4700-35 M SMG	ABCDEF G. IJK.
C	21	87-016-658-000	CAP, E 4700-35 M SMG	ABCDEF G. IJK.
C	32	87-010-197-080	CAP, CHIP 0.01 DM	ABCDEF G. IJK.
C	31	87-010-263-080	CAP, ELECT 100-10V	ABCDEF G. IJK.
C	36	87-010-381-080	CAP, ELECT 330-16V	ABCDEF G. IJK.
C	34	87-010-384-080	CAP, ELECT 100-25V	ABCDEF G. IJK.
C	38	87-010-394-080	CAP ELECT220-35V	ABCDEF G. IJK.
C	39	87-010-394-080	CAP ELECT220-35V	ABCDEF G. IJK.
C	40	87-010-197-080	CAP, CHIP 0.01 DM	ABCDEF G. IJK.
C	60	87-010-403-080	CAP, ELECT 3.3-50V	ABCDEF G. IJK.
C	81	87-010-260-080	CAP, ELECT 47-25V IJK.
C	82	87-010-380-080	CAP, ELECT 47-16V	ABC..... K
C	80	87-010-401-080	CAP, ELECT 1-50V	ABC..... IJK
CN	1	87-A60-996-010	CONN, 13P V BLK TAC-L13X-A3	ABCDEF G. IJK.
CN	91	87-A60-109-010	CONN, 2P V S2M-2W	ABC..... IJK
CNA	2	8A-NF6-630-010	CONN ASSY, 3P (VM) ANF-6	ABC..... IJK
CNA	1	8A-NF8-653-010	CONN ASSY, 9P TID-A(480)	ABCDEF G. IJK.
D	1	87-017-654-060	DIODE, GBU6J	ABCDEF G. IJK.
D	28	87-A40-553-080	DIODE, 1N4003 LES	ABCDEF G. IJK.
D	26	87-A40-553-080	DIODE, 1N4003 LES	ABCDEF G. IJK.
D	27	87-A40-553-080	DIODE, 1N4003 LES	ABCDEF G. IJK.
D	25	87-A40-553-080	DIODE, 1N4003 LES	ABCDEF G. IJK.
D	29	87-A40-781-080	ZENER, UZ36BSA	ABCDEF G. IJK.
D	31	87-A40-764-080	ZENER, UZ10BSC	ABCDEF G. IJK.
D	64	87-A40-269-080	C-DIODE, MC2836	ABCDEF G. IJK.
D	63	87-A40-270-080	C-DIODE, MC2838	ABCDEF G. IJK.
D	62	87-A40-313-080	C-DIODE, MC 2840	ABCDEF G. IJK.
D	61	87-A40-313-080	C-DIODE, MC 2840	ABCDEF G. IJK.
D	65	87-A40-768-080	ZENER, UZ16BSA	ABCDEF G. IJK.
D	84	87-020-465-080	DIODE, 1SS133 (110MA)	ABCDEF G. IJK.
D	85	87-020-465-080	DIODE, 1SS133 (110MA)	ABCDEF G. IJK.
Q	5	87-026-610-080	TR, KTC3198GR	ABCDEF G. IJK.
Q	9	87-A30-318-080	TR, CSA952K	ABCDEF G. IJK.
Q	13	89-213-702-010	TR, 2SB1370 (1.8W)	ABCDEF G. IJK.
Q	14	89-213-702-010	TR, 2SB1370 (1.8W)	ABCDEF G. IJK.
Q	84	87-026-609-080	TR, KTA1266GR	ABCDEF G. IJK.
Q	83	87-A30-075-080	C-TR, 2SA1235F	ABCDEF G. IJK.
Q	81	87-A30-076-080	C-TR, 2SC3052F	ABCDEF G. IJK.
WH	1	87-A90-510-010	HLDR, WIRE 2.5-9P	ABCDEF G. IJK.
C	609	87-010-181-080	CAP, CHIP S 1800P	ABCDEF G. IJK.
C	610	87-010-181-080	CAP, CHIP S 1800P	ABCDEF G. IJK.
C	616	87-010-184-080	CHIP CAPACITOR 3300P(K)	ABCDEF G. IJK.
C	613	87-010-197-080	CAP, CHIP 0.01 DM	ABCDEF G. IJK.
C	619	87-010-263-080	CAP, ELECT 100-10V	ABCDEF G. IJK.
C	618	87-010-401-080	CAP, ELECT 1-50V	ABCDEF G. IJK.
C	611	87-010-956-080	CHIP-CAP, S 0.068-25B	ABCDEF G. IJK.
C	617	87-012-369-080	C-CAP, S 0.047-50F	ABCDEF G. IJK.
C	612	87-016-369-080	C-CAP, S 0.033-25 B K	ABCDEF G. IJK.
C	614	87-016-669-080	C-CAP, S 0.1-25 K B	ABCDEF G. IJK.
C	621	87-010-197-080	CAP, CHIP 0.01 DM	ABCDEF G. IJK.
C	627	87-010-400-080	CAP, ELECT 0.47-50V	ABCDEF G. IJK.
C	628	87-010-400-080	CAP, ELECT 0.47-50V	ABCDEF G. IJK.
C	623	87-010-401-080	CAP, ELECT 1-50V	ABCDEF G. IJK.
C	624	87-010-401-080	CAP, ELECT 1-50V	ABCDEF G. IJK.
C	620	87-016-669-080	C-CAP, S 0.1-25 K B	ABCDEF G. IJK.
C	629	87-A10-354-080	C-CAP, S 0.047-50 K B	ABCDEF G. IJK.
C	626	87-A10-354-080	C-CAP, S 0.047-50 K B	ABCDEF G. IJK.
C	632	87-010-185-080	C-CAP, S 3900P-50 B	ABCDEF G. IJK.
C	631	87-010-185-080	C-CAP, S 3900P-50 B	ABCDEF G. IJK.
C	634	87-010-196-080	CHIP CAPACITOR, 0.1-25	ABCDEF G. IJK.
C	630	87-010-383-080	CAP, ELECT 33-25V	ABCDEF G. IJK.
C	639	87-010-405-080	CAP, ELECT 10-50V	ABCDEF G. IJK.
C	636	87-A10-307-080	CAP, M 0.1-50 J	ABCDEF G. IJK.
C	635	87-A10-307-080	CAP, M 0.1-50 J	ABCDEF G. IJK.
C	638	87-A10-307-080	CAP, M 0.1-50 J	ABCDEF G. IJK.
C	637	87-A10-307-080	CAP, M 0.1-50 J	ABCDEF G. IJK.
C	643	87-010-196-080	CHIP CAPACITOR, 0.1-25	ABCDEF G. IJK.
C	641	87-010-401-080	CAP, ELECT 1-50V	ABCDEF G. IJK.
C	642	87-010-401-080	CAP, ELECT 1-50V	ABCDEF G. IJK.
C	644	87-010-401-080	CAP, ELECT 1-50V	ABCDEF G. IJK.
C	679	87-010-196-080	CHIP CAPACITOR, 0.1-25	ABCDEF G. IJK.
C	673	87-010-197-080	CAP, CHIP 0.01 DM	ABCDEF G. IJK.
C	672	87-010-322-080	C-CAP, S 100P-50 CH	ABCDEF G. IJK.
C	671	87-010-322-080	C-CAP, S 100P-50 CH	ABCDEF G. IJK.
C	682	87-010-196-080	CHIP CAPACITOR, 0.1-25	ABCDEF G. IJK.
C	680	87-010-197-080	CAP, CHIP 0.01 DM	ABCDEF G. IJK.
CN	602	87-099-194-010	CONN, 6P 6216V	ABCDEF G. IJK.
CN	601	87-099-719-010	CONN, 30P TYK-B(X)	ABCDEF G. IJK.
D	603	87-020-465-080	DIODE, 1SS133 (110MA)	ABCDEF G. IJK.
D	602	87-A40-745-080	ZENER, UZ4.7BSA	ABCDEF G. IJK.
IC	601	87-A21-452-010	C-IC, BD3876KS2 K
IC	601	87-A21-452-030	C-IC, BD3876KS2	ABCDEF G. IJ.
J	601	87-A60-885-010	JACK, PIN 6P R/W MSC	ABCDEF G. IJK.
Q	601	87-026-610-080	TR, KTC3198GR	ABCDEF G. IJK.
Q	608	87-A30-075-080	C-TR, 2SA1235F	ABCDEF G. IJK.
Q	609	87-A30-075-080	C-TR, 2SA1235F	ABCDEF G. IJK.

ELECTRICAL MAIN PARTS LIST - 8/8

Q	607	87-A30-075-080	C-TR, 2SA1235F	ABCDEFGH.IJK.....
Q	606	87-A30-086-040	C-TR, CSD1306E	ABCDEFGH.IJK.....
Q	605	87-A30-086-040	C-TR, CSD1306E	ABCDEFGH.IJK.....
Q	603	87-A30-087-080	C-FET, 2SK2158EFG.IJ.....
Q	602	87-A30-269-040	C-FET, 2SJ461-T1FG..J.....
C	507	87-010-177-080	C-CAP, S 820P-50 SL	A.C..FG..J.....
C	506	87-010-184-080	CHIP CAPACITOR 3300P(K)	A.C..FG..J.....
C	501	87-010-263-080	CAP, ELECT 100-10V	A.C..FG..J.....
C	503	87-012-393-080	C-CAP, S 0.22-16 R K	A.C..FG..J.....
C	504	87-012-393-080	C-CAP, S 0.22-16 R K	A.C..FG..J.....
C	509	87-016-081-080	C-CAP, S 0.1-16 RK	A.C..FG..J.....
C	508	87-016-081-080	C-CAP, S 0.1-16 RK	A.C..FG..J.....
C	511	87-010-177-080	C-CAP, S 820P-50 SL	A.C..FG..J.....
C	518	87-010-183-080	C-CAP, S 2700P-50 B	A.C..FG..J.....
C	517	87-010-183-080	C-CAP, S 2700P-50 B	A.C..FG..J.....
C	510	87-010-184-080	CHIP CAPACITOR 3300P(K)	A.C..FG..J.....
C	514	87-010-374-080	CAP, ELECT 47-10V	A.C..FG..J.....
C	516	87-010-401-080	CAP, ELECT 1-50V	A.C..FG..J.....
C	515	87-010-401-080	CAP, ELECT 1-50V	A.C..FG..J.....
C	513	87-010-544-080	CAP, ELECT 0.1-50V	A.C..FG..J.....
C	512	87-012-393-080	C-CAP, S 0.22-16 R K	A.C..FG..J.....
C	535	87-010-178-080	CHIP CAP 1000P	A.C..FG..J.....
C	536	87-010-196-080	CHIP CAPACITOR, 0.1-25	ABCDEFGH.IJK.....
C	538	87-010-318-080	C-CAP, S 47P-50 CH	A.C..FG..J.....
C	531	87-010-405-080	CAP, ELECT 10-50V	A.C..FG..J.....
C	534	87-012-156-080	C-CAP, S 220P-50 CH	A.C..FG..J.....
C	541	87-010-178-080	CHIP CAP 1000P	A.C..FG..J.....
D	501	87-A40-747-080	ZENER, UZ5.1BSB	A.C..FG..J.....
FB	501	87-008-372-080	FILTER, EMI BL OIRNI	A.C..FG..J.....
IC	501	87-A21-018-040	C-IC, M65849BFP631D	A.C..FG..J.....
Q	532	87-A30-075-080	C-TR, 2SA1235F	A.C..FG..J.....
Q	531	87-A30-076-080	C-TR, 2SC3052F	A.C..FG..J.....

MECHANICAL PARTS LIST - 1/2

NOTE: The characters in the suffix column indicate the part usage.

```

70HS .....XX.....C.....
70K .....XX.....D.....
70EZ .....XX.....E.....
72EZ .....XX.....F.....
73EZ .....XX.....G.....
71LH .....XX.....H.....

```

REF.NO	PARTS NO.	KANRI NO.	DESCRIPTION	SUFFIX
	87-CE3-023-010		BADGE,AIWA 30N SILV	ABC....HIJK.....
	8A-NF7-001-010		CABI,FR UD.....
	8A-NF7-003-010		BOX,CASS 1	ABC....HIJK.....
	8A-NF7-004-010		BOX,CASS 2	ABC....HIJK.....
	8A-NF7-005-010		PANEL,TRAY U	ABCDEFGHIJK.....
	8A-NF7-006-010		WINDOW,DISP U
	8A-NF7-008-010		PANEL,CD	ABC....HIJK.....
	8A-NF7-010-010		WINDOW,CASS 1	ABC....HIJK.....
	8A-NF7-011-010		WINDOW,CASS 2	ABC....HIJK.....
	8A-NF7-012-010		PANEL,DIRECT	ABC....HIJK.....
	8A-NF7-020-010		PANEL,ASSY FR U	.B....H.K.....
	8A-NF7-053-010		COVER, REAR H	ABC....H.K.....
	8A-NF7-054-010		COVER, REAR EZ
	8A-NF7-057-010		COVER, REAR UI
	8A-NF7-061-010		PANEL,REAR USM
	8A-NF7-063-010		PANEL,REAR EZSM
	8A-NF7-064-010		PANEL,REAR KSM
	8A-NF7-071-010		PANEL,REAR US
	8A-NF7-076-010		PANEL,REAR EZSM72
	8A-NF7-077-010		PANEL,REAR EZSM73
	8A-NF7-078-010		PANEL,REAR USFD
	8A-NF7-081-010		CABI,FR HR	A.C.....
	8A-NF7-082-010		CABI,FR EZJ.....
	8A-NF7-083-010		CABI,FR LH	.B....H.K.....
	8A-NF7-084-010		CABI,FR KI.....
	8A-NF7-089-010		WINDOW,DISP LHKH.....
	8A-NF7-090-010		WINDOW,DISP HA	.B....K.....
	8A-NF7-091-010		WINDOW,DISP HR	A.C....I.....
	8A-NF7-093-010		WINDOW,DISP LH
	8A-NF7-095-010		WINDOW,DISP EZ73J.....
	8A-NF7-096-010		WINDOW,DISP LH73
	8A-NF7-100-010		WINDOW,DISP EZ72
	8A-NF7-101-010		PANEL,ASSY FR HR	A.C.....
	8A-NF7-103-010		PANEL,ASSY FR EZJ.....
	8A-NF7-105-010		PANEL,ASSY FR KI.....
	8A-NF7-112-010		PANEL,RIGHT V-2	ABCDEFGHIJK.....
	8A-NF7-124-010		COVER, REAR H20 EZIJ.....
	8A-NF7-128-010		COVER, REAR STEEL UM
	8A-NF7-129-010		COVER, REAR STEEL UJ
	8A-NF7-130-010		COVER, REAR STEEL UI
	8A-NF7-141-010		PANEL,REAR HRJSM-F	A.....
	8A-NF7-142-010		PANEL,REAR EZSM-FI.....
	8A-NF7-143-010		PANEL,REAR KSM-F
	8A-NF7-144-010		PANEL,REAR LHSM-F
	8A-NF7-144-110		PANEL,REAR LHSM-F
	8A-NF7-145-010		PANEL,REAR EZSE-F
	8A-NF7-146-010		PANEL,REAR KSE-F
	8A-NF7-147-010		PANEL,REAR LHSM73-F
	8A-NF7-147-110		PANEL,REAR LHSM73-F
	8A-NF7-148-010		PANEL,REAR EZSE73-F
	8A-NF7-150-010		PANEL,REAR HRS-F
	8A-NF7-151-010		PANEL,REAR LHS-F
	8A-NF7-152-010		PANEL,REAR HASM-F	.B.....
	8A-NF7-153-010		PANEL,REAR EZSE72-F
	8A-NF7-154-010		PANEL,REAR LHSFD-F
	8A-NF7-155-010		PANEL,REAR HSSM-F	.C.....
	8A-NF7-156-010		PANEL,REAR HASC1M-FK.....
	8A-NF7-157-010		PANEL,REAR LH-F W/O SPCH.....
	8A-NF7-158-010		PANEL,REAR EZSM72-F
	8A-NF7-159-010		PANEL,REAR EZSM73-FJ.....
	8A-NF7-160-010		PANEL,REAR HRSM-F
	8A-NF8-005-010		PANEL, TOP	ABCDEFGHIJK.....
	8A-NF8-006-010		WINDOW, TOP	ABCDEFGHIJK.....
	8A-NF8-007-010		PANEL, LEFT V-2	ABCDEFGHIJK.....
	8A-NF7-015-010		KNOB,RTRY MIC	.B....HI.K.....
	8A-NF7-021-010		KEY,BBE	ABC....HIJK.....
	8A-NF7-022-010		KEY,SPICE	ABC....H.K.....
	8A-NF7-023-010		KEY,ENTER	ABC....HIJK.....
	8A-NF7-024-010		KEY,SURROUND	A.C.....J.....
	8A-NF7-026-010		KEY,ASSY OPE	ABC....HIJK.....
	8A-NF7-029-010		KEY,GEQ	ABC....HIJK.....
	8A-NF7-033-010		KEY,RDSJ.....
	8A-NF7-034-010		KEY,MIC	A.C.....J.....
	8A-NF7-035-010		KEY,ASSY FUN	ABC....HIJK.....
	8A-NF7-041-010		KEY,ASSY CD	ABC....HIJK.....
	8A-NF7-046-010		KEY,KARAOKE	ABC....H.K.....

MECHANICAL PARTS LIST - 2/2

	8A-NF7-047-010	KEY, DOLBY IJ
	8A-NF7-048-010	KNOB, RTRY ASSY JOG	ABC.... H
	8A-NF7-048-110	KNOB, RTRY ASSY JOG IJK
	8A-NF7-049-010	KNOB, RTRY ASSY VOL	ABC.... HIJK
	81-532-080-010	LABEL, CASS. COMPT	ABC.... HIJK
	86-NF6-061-010	REFLECTOR, CASS	ABC.... HIJK
	87-NF6-615-010	CONN ASSY, 3P PB	ABCDEFGHIJK
	87-NF6-616-010	CONN ASSY, 8P RPB	ABCDEFGHIJK
	84-ZG1-245-210	CAP, OPTICAL	ABCDEFGHIJK
	82-NF5-218-010	SPR-T, EJECT 1 (SIN)	ABCDEFGHIJK
	82-NF5-219-010	SPR-T, EJECT 2 (SIN)	ABCDEFGHIJK
	82-NF5-229-010	PLATE, LOCK	ABC.... HIJK
	85-NF7-599-010	PVC W 3.2-8-0.3 IJK
	86-NF9-224-010	SPR-C, LOCK	ABC.... HIJK
	87-085-221-010	FOOT, H13.5	ABCDEFGHIJK
	87-NF4-216-010	HLDR, LOCK 1	ABC.... HIJK
	87-NF4-217-110	HLDR, LOCK 2	ABC.... HIJK
	87-NF4-221-010	HLDR, CABLE	ABCDEFGHIJK
	8A-NF6-217-010	HLDR, PWB PT	ABC.... H . K
	8A-NF6-219-010	HLDR, FAN	ABC.... H . K
	8A-NF7-207-010	HLDR, HT L	ABCDEFGHIJK
	8A-NF7-208-010	HLDR, HT R	ABCDEFGHIJK
	8A-NF7-209-010	HLDR, PWB-M BTM	ABCDEFGHIJK
	8A-NF7-225-010	HLDR, PWB PT 85S	... DEFG. IJ
	8A-NF7-226-010	HLDR, IC2-T2	ABC.... HIJK
	8A-NF7-249-010	HLDR, FAN H20 IJ
	8Z-NB8-240-010	COVER, PL	ABCDEFGHIJK
	8Z-NB8-254-010	COVER, PL M3	ABCDEFGHIJK
	8Z-NF6-210-010	DMPR, 150 N	ABC.... HIJK
*	8A-NF8-206-010	HLDR, PWB M	ABCDEFGHIJK
	87-067-579-010	TAPPING SCREW, BVT2+3-8	ABCDEFGHIJK
	87-067-581-010	TAPPING SCREW, BVT2+3-15	ABCDEFGHIJK
	87-067-584-010	TAPPING SCREW, BVT2+3-6 IJK
	87-067-641-010	UTT2+3-8 (W/O SLOT) BL	ABCDEFGHIJK
	87-067-688-010	BVTT+3-6	ABCDEFGHIJK
	87-067-689-010	TAPPING SCREW, BVTT+3-8	ABC.... IJK
	87-067-703-010	TAPPING SCREW, BVT2+3-10	ABCDEFGHIJK
	87-078-191-010	S-SCREW, IT+4-10	ABCDEFGHIJK
	87-721-097-410	QT2+3-12 GLD	ABCDEFGHIJK
	87-723-096-410	QT2+3-10W/O SLOT BL	ABCDEFGHIJK
	87-NF4-224-010	S-SCREW, IT3B+3-8 CU	ABCDEFGHIJK
	87-067-579-010	TAPPING SCREW, BVT2+3-8 H
	87-067-581-010	TAPPING SCREW, BVT2+3-15 H
	87-067-584-010	TAPPING SCREW, BVT2+3-6 H
	87-067-641-010	UTT2+3-8 (W/O SLOT) BL H
	87-067-688-010	BVTT+3-6 H
	87-067-689-010	TAPPING SCREW, BVTT+3-8 H
	87-067-703-010	TAPPING SCREW, BVT2+3-10 H
	87-721-097-410	QT2+3-12 GLD H
	87-723-096-410	QT2+3-10W/O SLOT BL H
	87-NF5-203-110	GUIDE, FL (*)	ABC.... HIJK
	8A-NF7-213-010	GUIDE, FUN	ABC.... HIJK
	8A-NF7-214-010	GUIDE, OPE	ABC.... HIJK
	87-067-001-010	FW, 3.1-5.4-1	ABCDEFGHIJK
	87-067-703-010	TAPPING SCREW, BVT2+3-10	... DEFG
	85-NF5-617-010	CABLE, FFC 6P-1.25	ABCDEFGHIJK
	85-NF5-618-010	CABLE, FFC 13P-1.25	ABC.... HIJK
	87-085-185-010	BUSHING, AC CORD (E)	ABCDEFGHIJK
	87-085-189-010	BUSHING, CORD (U) D
	87-099-811-010	PLUG, ADPTR CONV (K) K
	87-A11-112-080	CAP, TC U 1000P-50 J CH K
	87-A11-144-080	CAP, TC U 0.1-50 K B K
	87-A80-105-010	AC CORD ASSY, AZ	.. B
	87-A80-155-010	AC CORD ASSY, HS TS	.. C
	88-915-111-110	FF-CABLE, 15P 1.25	ABC.... HIJK
	87-A11-121-080	CAP, TC U 1200P-50 K B IJK
	87-A11-121-080	CAP, TC U 1200P-50 K B IJK
	87-020-465-080	DIODE, 1SS133 (110MA) IJK
	87-A40-234-080	ZENER, MTZJ5.6A IJK
	87-A40-747-080	ZENER, UZ5.1BSB IJK
PT	101	8A-NF7-621-010	PT, ANF-7 U
PT	101	8A-NF7-622-010	PT, ANF-7 H
PT	101	8A-NF7-623-010	PT, ANF-7 EZK
W	101	87-A80-092-010	AC CORD ASSY, E BLK SUN FAI
W	101	87-A80-110-010	AC CORD ASSY, U SPT-2W
W	101	87-A80-157-010	AC CORD ASSY, E BLK CC
WH	101	87-A90-459-010	HLDR, WIRE 2.5-5P
		87-A91-711-010	FAN, 3110GL-B4W-B34-H02 -400MM
WH	1	87-A90-510-010	HLDR, WIRE 2.5-9P

ACCESSORIES / PACKAGE LIST - 1/1

NOTE: The characters in the suffix column indicate the part usage.

70HSXX.....	C.....
70KXX.....	D.....
70EZXX.....	E.....
72EZXX.....	F.....
73EZXX.....	G.....
71LHXX.....	H.....

REF.NO	PARTS NO.	KANRI NO.	DESCRIPTION	SUFFIX
	8A-NF7-901-010	IB,H(ECA)M		A.....
	8A-NF7-901-110	IB,H(ECA)M	
	8A-NF7-902-010	IB,LH(ESP)M		.B.....
	8A-NF7-903-010	IB,U(ESF)M	
	8A-NF7-905-010	IB,K(E)E	D.....
	8A-NF7-906-010	IB,EZ(9L)E 70(NO RDS)	E.....
	8A-NF7-907-010	IB,EZ(9L)E 72&73(RDS)	FG.....
	8A-NF7-911-010	IB,H(ECA)I	
	8A-NF7-912-010	IB,LH(ESP)M 73	
	8A-NF7-913-010	IB,U(ESF)I	
	8A-NF7-915-010	IB,K(E)M	
	8A-NF7-916-010	IB,EZ(9L)M 70(NO RDS)	I.....
	8A-NF7-917-010	IB,EZ(9L)M 72,73(RDS)	J.....
	8A-NF7-922-010	IB,LH(ESP)I 70	
	8A-NF7-930-010	IB,HA-KIT (ARG)	K.....
	8A-NF7-932-010	IB,LH-KIT (BRA)	H.....
	87-006-225-010	AM LOOP ANT NC2		.BCDEFGHIJK.....
	87-006-226-010	AM-LOOPANT C0		A.....
	87-006-268-010	AM-LOOP ANT NC (UN)	
	87-043-115-010	ANT,FEEDER FM		ABC....H..K.....
	87-A90-118-010	ANT,WIRE FM (Z)		...DEFG.IJ.....
	87-A90-119-010	ANT,WIRE SW(5M)		A.....
	87-A91-017-010	PLUG,CONVERSION JT-0476		A.....
	8Z-NF8-702-010	RC UNIT,RC-ZAS01		ABCDEFGHIJK.....

SCHEMATIC DIAGRAM - 1 (MAIN 1/3: AMP)

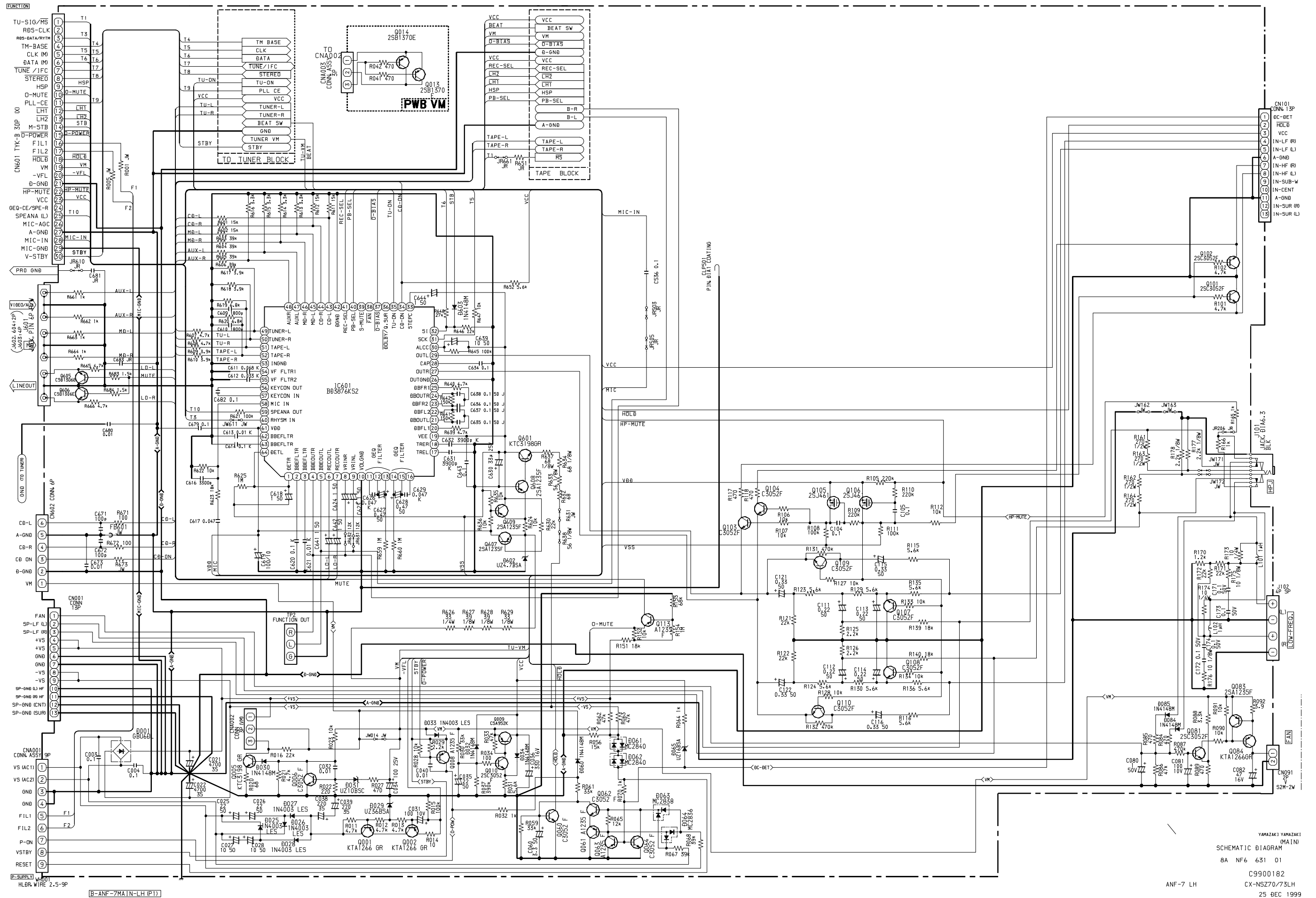

YAMAZAKI YAMAZAKI
 (MAIN)
 SCHEMATIC DIAGRAM
 8A NF6 631 01
 C9900182
 ANF-7 LH CX-NS270/73LH
 25 DEC 1999

SCHEMATIC DIAGRAM – 2 (MAIN 2/3: DECK)

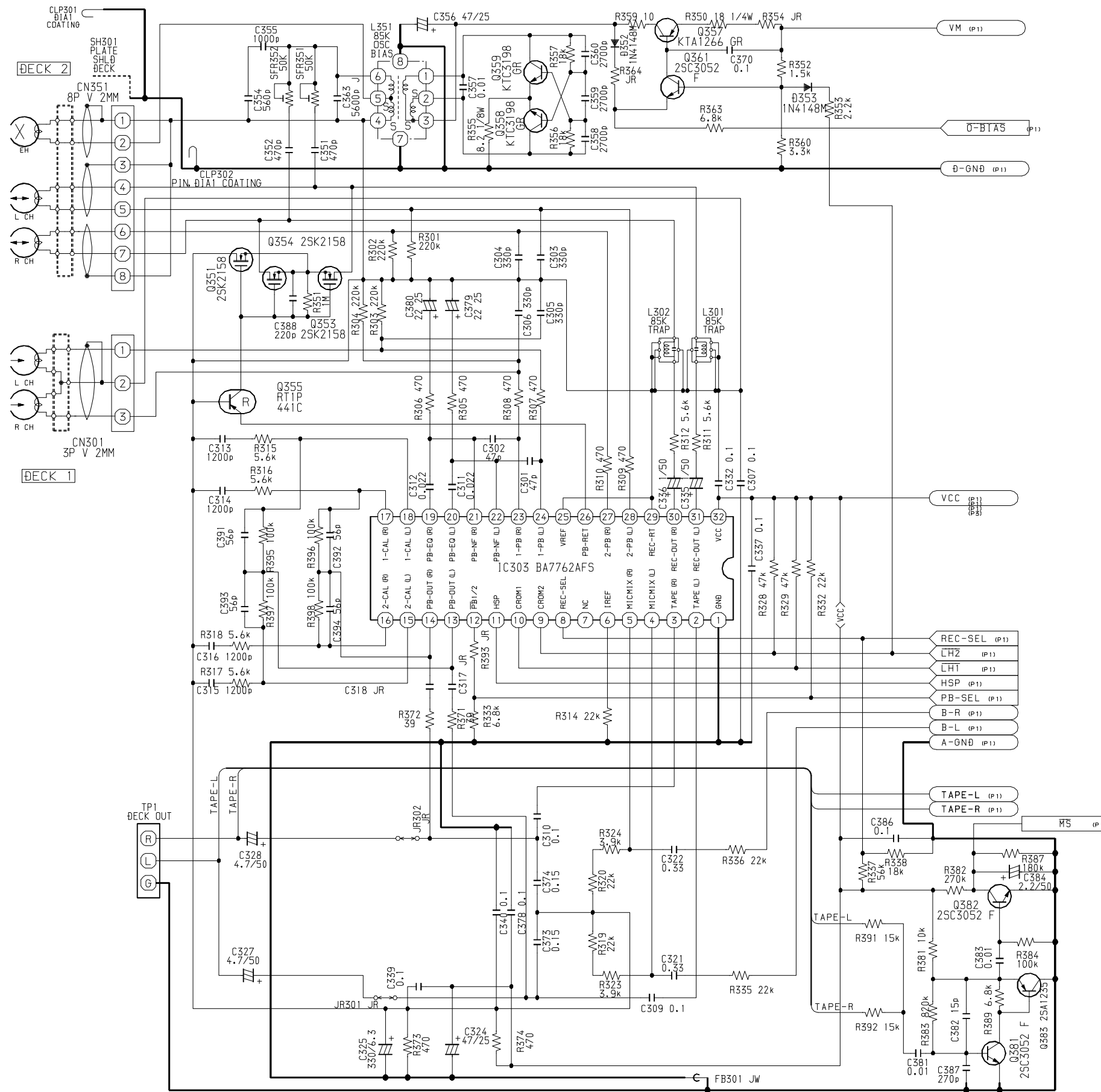

B-ANF-7MAIN-U (P2)

YAMAZAKI YAMAZAKI
 SCHEMATIC DIAGRAM (DECK)
 8A NF6 631 01
 C9900172
 CX-NAJ70U
 24 DEC 1999

ANF-7 U

SCHEMATIC DIAGRAM – 3 (MAIN 3/3: TUNER)

IFT COIL

	PARTS NO./ PARTS CODE		
	U/LH, EZ, K, G, V	HE/HR/HC	D/HD
1ST	87-A91-551-01 FLTR, PCFJZH-450 L (TOK)	87-A91-552-01 FLTR, CFMT-450AL (TOK)	87-A91-553-01 FLTR, PCFMT-040L (TOK)
2ND			
3RD			

AM PACK

	PARTS NO./ PARTS CODE	
	U/LH, D/HD, V	EZ, K, G
1ST	8A-NF8-667-01 COIL, AM PACK4 (TOK)	8A-NF8-668-01 COIL, AM PACK (TOK)
2ND		
3RD		

*EXCEPT SW BAND MODEL (HE/HR/HC)

* LA1843 USING...
L801 FM DET (TOK) & R802 4.7K MUST USE.
LA1844 USING...
L801 FM DET-N (TOK) & R802 22K MUST USE.

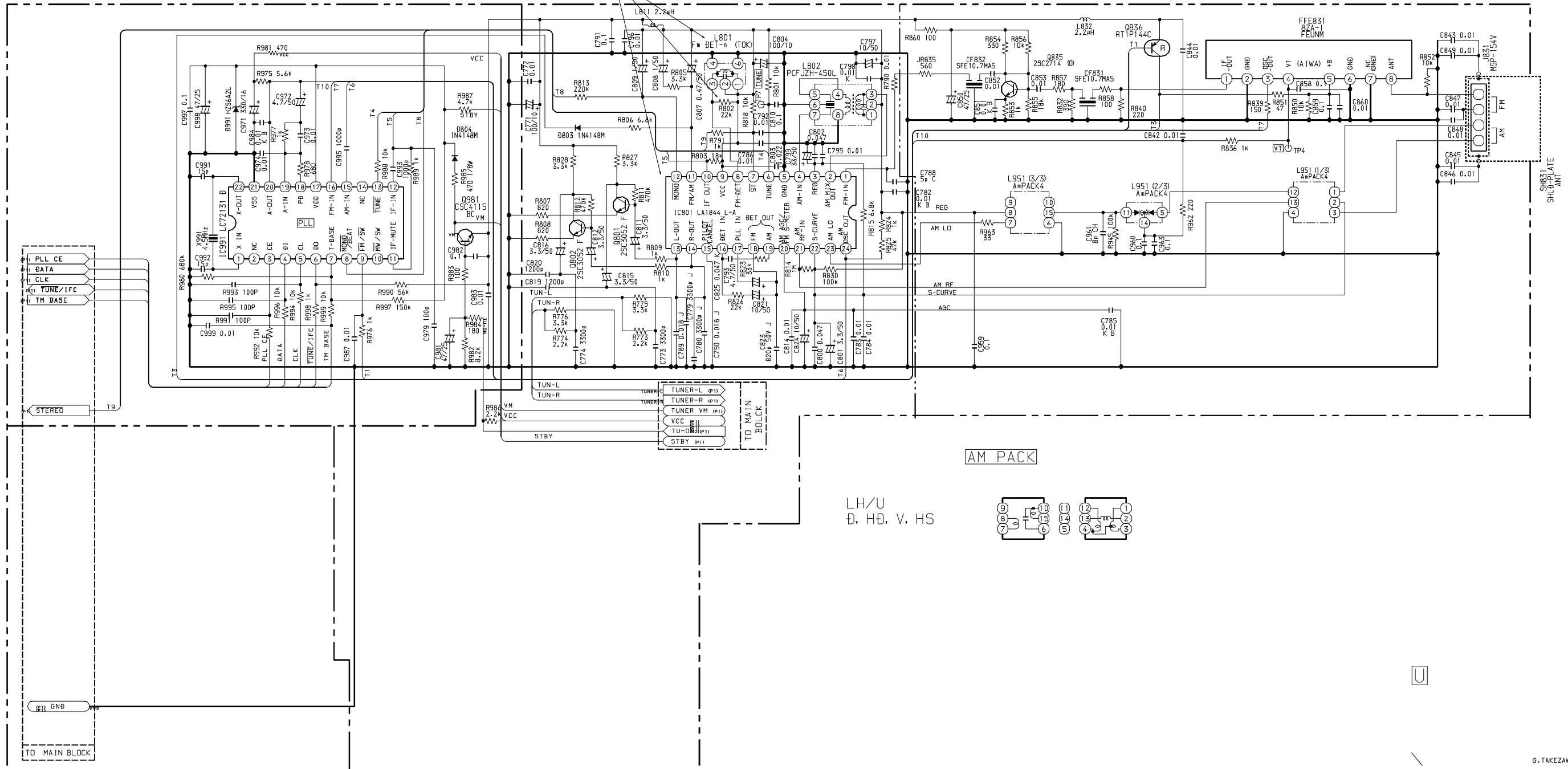

AM PACK

LH/U
D, HD, V, HS

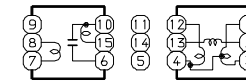

B-ANF-7MAIN-U (P3)

G. TAKEZAWA
(TUNER)
SCHEMATIC DIAGRAM

8A NF6 631 01

C9900178

ANF-7 U

CX-NAJ70U

24 DEC 1999

SCHEMATIC DIAGRAM - 4 (FRONT)

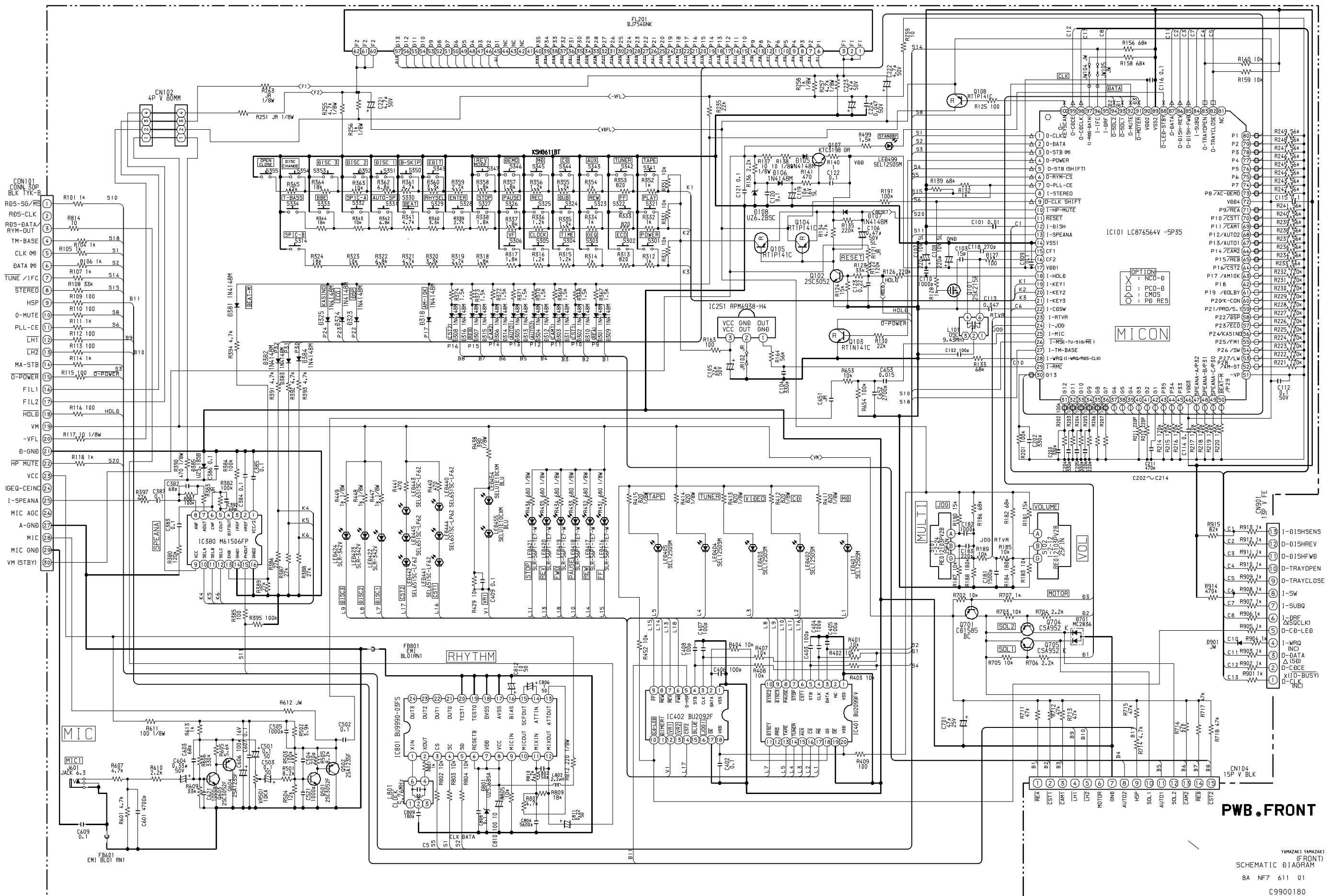

PWB.FRONT

YAMAZAKI YAMAZAKI
 SCHEMATIC DIAGRAM
 BA NF7 611 01
 C9900180
 CX-NS770/73 LH
 25 DEC 1999

[B-ANF-7FR-LH]

SCHEMATIC DIAGRAM - 5 (AMP)

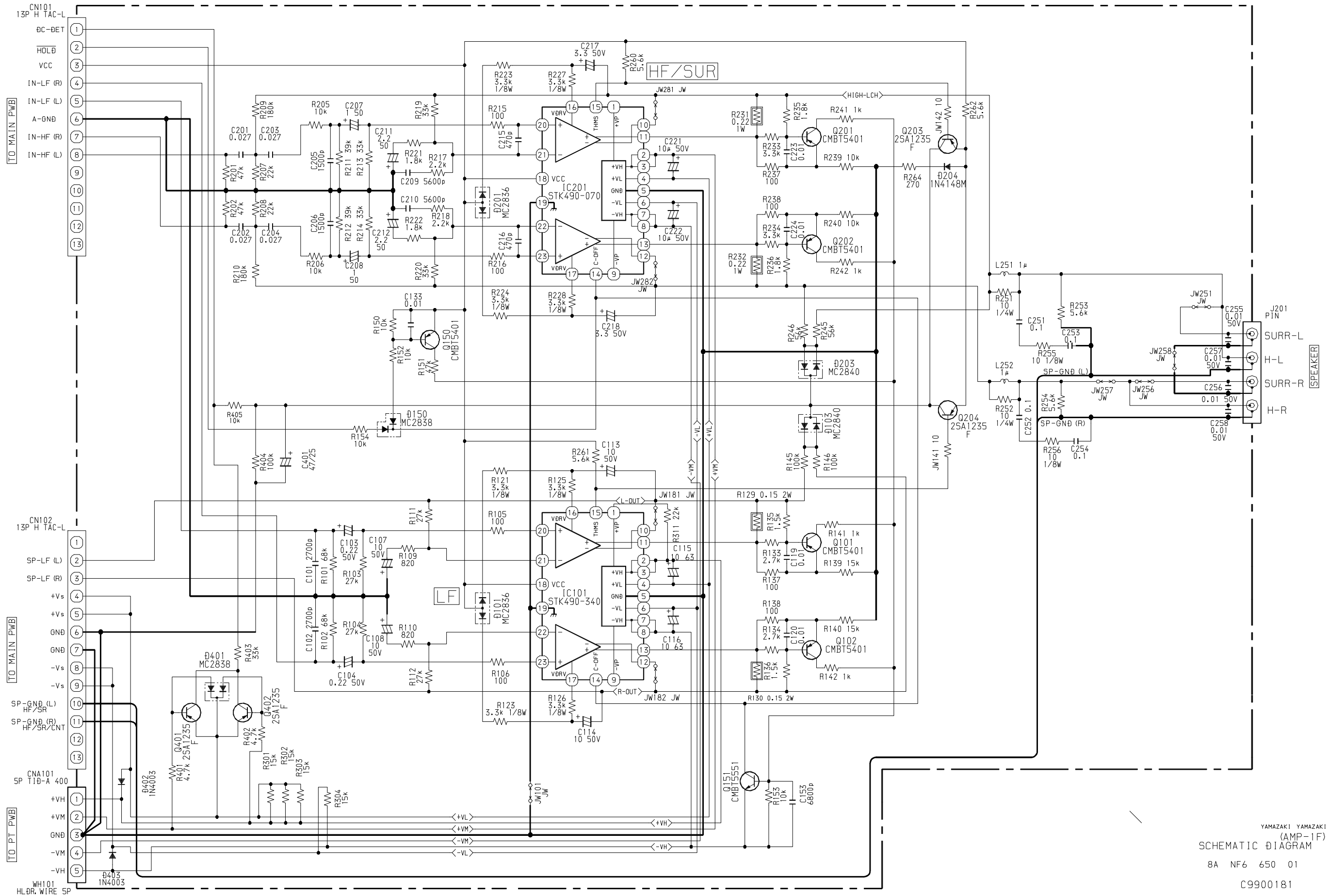

YAMAZAKI YAMAZAKI
(AMP-1F)
SCHEMATIC DIAGRAM

8A NF6 650 01

C9900181

ANF-7 H

CX-NS270 H

25 DEC 1999

B-ANF-7AMP-1F-H

SCHEMATIC DIAGRAM - 6 (PT)

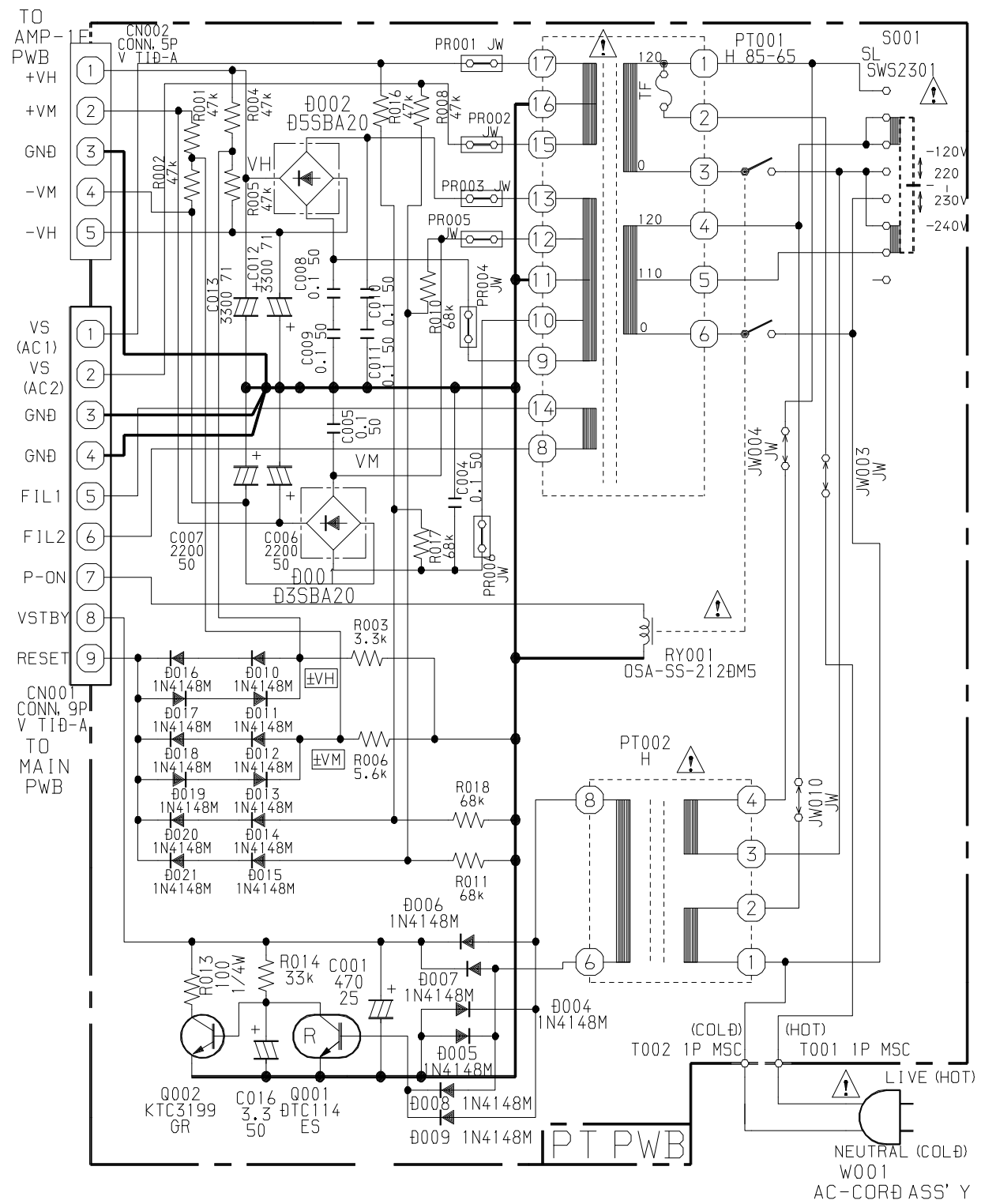

YAMAZAKI YAMAZAKI
SCHEMATIC DIAGRAM (PT)

8A NFV 610 01

C9900179

ANF-7 H

CX-NSZ70 H

25 DEC 1999

B-ANF-7PT-H

アイワ株式会社 〒110-8710 東京都台東区池之端1-2-11 ☎03(3827)3111 (代表)
AIWA CO.,LTD. 2-11, IKENOHATA 1-CHOME, TAITO-KU, TOKYO 110, JAPAN TEL:03 (3827) 3111