

aiwa



XR-AVH1200

COMPACT DISC STEREO SYSTEM

• TYPE: HR

SIMPLE MANUAL

TYPE	AMPLIFIER	CASSETTE DECK	GRAPHIC EQUALIZER	CD PLAYER	SPEAKERS
HR	MX-SNAVH1200	FX-SNH1100	GE-SNAVH1200	DX-SNH1100	SX-NAVH1200 SX-CR677

• Replace this Service Manual with "Revision Publishing" when it is issued.

S/M Code No. 09-995-411-7T1

MANUAL
SERVICE

ELECTRICAL MAIN PARTS LIST - 1/8 (MX-SNAVH1200)

NOTE: The characters in the suffix column indicate the part usage.

HSM	REF.NO	PARTS NO.	DESCRIPTION	SUFFIX
			XX.....A.....	
			KANRI	
			NO.	
C	209	87-010-071-040	CAP,E 1-50 M 5L SRE	A.....
C	201	87-010-192-080	C-CAP,S 0.022-50 F	A.....
C	205	87-010-194-080	CAP,CHIP 0.047	A.....
C	207	87-010-194-080	CAP,CHIP 0.047	A.....
C	202	87-010-264-040	CAP,E 100-10 5L	A.....
C	206	87-010-405-040	CAP,E 10-50	A.....
C	204	87-010-981-040	CAP,E 22-35 5L SRE	A.....
C	203	87-016-081-080	C-CAP,S 0.1-16 RK	A.....
C	208	87-A10-189-040	CAP,E 220-10	A.....
C	211	87-012-140-080	CAP 470P	A.....
C	222	87-010-401-040	CAP,E 1-50 SME	A.....
C	220	87-016-669-080	C-CAP,S 0.1-25 K B	A.....
C	221	87-016-669-080	C-CAP,S 0.1-25 K B	A.....
C	241	87-010-178-080	CHIP CAP 1000P	A.....
C	248	87-010-192-080	C-CAP,S 0.022-50 F	A.....
C	243	87-010-314-080	C-CAP,S 22P-50V	A.....
C	244	87-010-316-080	C-CAP,S 33P-50 CH	A.....
C	242	87-010-318-080	C-CAP,S 47P-50 CH	A.....
C	247	87-016-669-080	C-CAP,S 0.1-25 K B	A.....
C	251	87-010-197-080	CAP,CHIP 0.01 DM	A.....
C	254	87-010-197-080	CAP,CHIP 0.01 DM	A.....
C	252	87-010-197-080	CAP,CHIP 0.01 DM	A.....
C	255	87-018-134-080	CAPACITOR,TC-U 0.01-16	A.....
C	253	87-A10-189-040	CAP,E 220-10	A.....
D	201	87-017-931-080	ZENER,MTZJ5.6B	A.....
D	205	87-020-465-080	DIODE,1SS133 (110MA)	A.....
D	203	87-020-465-080	DIODE,1SS133 (110MA)	A.....
D	202	87-A40-468-080	C-DIODE,HSM2836CTR	A.....
D	241	87-020-465-080	DIODE,1SS133 (110MA)	A.....
IC	202	87-A20-914-010	IC,SPS-442-1-F	A.....
IC	201	8Z-SP1-605-010	IC,UPD780228GF-034-3BA	A.....
LED	201	87-A40-589-040	LED,SLR-56VCT31 RED	A.....
Q	201	87-A30-087-080	C-FET,2SK2158	A.....
Q	220	87-A30-071-080	C-TR,RT1N 144C	A.....
Q	241	87-026-263-080	C-TR,RN1410	A.....
Q	240	87-A30-074-080	C-TR,RT1P 141C	A.....
SW	201	87-A91-342-010	SW,RTRY EC16B24104W/O D L20	A.....
X	201	87-A70-075-080	VIB,CER 4.19MHZ CRHF	A.....
C	608	87-010-166-080	C-CAP,S 100P-50 SL	A.....
C	604	87-010-166-080	C-CAP,S 100P-50 SL	A.....
C	602	87-010-176-080	C-CAP,S 680P-50 SL	A.....
C	603	87-010-186-080	CAP,CHIP 4700P	A.....
C	605	87-010-321-080	CHIP CAPACITOR,82P(J)	A.....
C	601	87-010-405-040	CAP,E 10-50	A.....
C	606	87-010-490-040	CAP,ELECT 0.1-50	A.....
C	609	87-010-545-040	CAP,E 0.22-50 SME	A.....
C	610	87-010-177-080	C-CAP,S 820P-50 SL	A.....
C	614	87-010-248-040	CAP,E 220-10 SME	A.....
C	615	87-010-498-040	CAP,E 10-16 GAS	A.....
C	611	87-010-981-040	CAP,E 22-35 5L SRE	A.....
C	619	87-016-526-080	C-CAP,S 0.47-16 BK	A.....
CN	601	87-099-199-010	CONN,6P 6216 H	A.....
D	600	87-020-465-080	DIODE,1SS133 (110MA)	A.....
FB	601	87-008-372-080	FILTER,EMI BL OIRNI	A.....
IC	601	87-017-888-080	IC,NJM4558MD	A.....
J	602	87-A60-651-010	JACK,3.5MONO	A.....
J	601	87-A60-651-010	JACK,3.5MONO	A.....
Q	600	87-A30-087-080	C-FET,2SK2158	A.....
C	801	87-010-170-080	S CHIP SL 220P(K)	A.....
C	802	87-010-176-080	C-CAP,S 680P-50 SL	A.....
C	803	87-010-187-080	CAP CHIP S5600P	A.....
C	807	87-010-196-080	CHIP CAPACITOR,0.1-25	A.....
C	804	87-010-213-080	C-CAP,S 0.015-50 B	A.....
C	806	87-010-494-040	CAP,E 1-50 GAS	A.....
C	809	87-012-155-080	C-CAP 180P-50CH	A.....
C	810	87-010-264-040	CAP,E 100-10 5L	A.....
C	811	87-010-552-040	CAP,E 22-16 GAS	A.....
C	812	87-010-560-040	CAP,E 10-50 GAS	A.....
C	821	87-010-318-080	C-CAP,S 47P-50 CH	A.....
C	822	87-010-318-080	C-CAP,S 47P-50 CH	A.....
C	823	87-010-318-080	C-CAP,S 47P-50 CH	A.....
J	801	87-017-931-080	ZENER,MTZJ5.6B	A.....
IC	801	87-A21-051-040	C-IC,BU9990-03FS	A.....
L	801	87-A50-093-010	COIL,CLOCK 5.76MHZ	A.....
Q	831	87-A30-075-080	C-TR,2SA1235F	A.....
Q	832	87-A30-087-080	C-FET,2SK2158	A.....
C	504	87-010-180-080	C-CER 1500P	A.....
C	503	87-010-180-080	C-CER 1500P	A.....
C	513	87-010-404-080	CAP,ELECT 4.7-50V	A.....
C	514	87-010-404-080	CAP,ELECT 4.7-50V	A.....
C	512	87-010-405-080	CAP,ELECT 10-50V	A.....
C	511	87-010-405-080	CAP,ELECT 10-50V	A.....
C	519	87-012-142-080	CAP,S 0.33-16	A.....
C	522	87-010-183-080	C-CAP,S 2700P-50 B	A.....
C	526	87-010-404-080	CAP,ELECT 4.7-50V	A.....
C	525	87-010-404-080	CAP,ELECT 4.7-50V	A.....

ELECTRICAL MAIN PARTS LIST - 2/8 (MX-SNAVH1200)

C	521	87-016-083-080	C-CAP,S 0.15-16 RK	A.....
C	520	87-016-669-080	C-CAP,S 0.1-25 K B	A.....
C	523	87-016-669-080	C-CAP,S 0.1-25 K B	A.....
C	535	87-010-195-080	C-CAP,S 0.068-25 F	A.....
C	537	87-010-196-080	CHIP CAPACITOR,0.1-25	A.....
C	533	87-010-263-080	CAP, ELECT 100-10V	A.....
C	532	87-010-263-080	CAP, ELECT 100-10V	A.....
C	538	87-010-404-080	CAP, ELECT 4.7-50V	A.....
C	539	87-010-404-080	CAP, ELECT 4.7-50V	A.....
C	531	87-010-405-080	CAP, ELECT 10-50V	A.....
C	534	87-010-406-080	CAP, ELECT 22-50	A.....
C	536	87-012-142-080	CAP, S 0.33-16	A.....
C	545	87-010-196-080	CHIP CAPACITOR,0.1-25	A.....
C	540	87-010-320-080	CHIP CAP 68P	A.....
C	542	87-010-320-080	CHIP CAP 68P	A.....
C	541	87-010-320-080	CHIP CAP 68P	A.....
C	548	87-010-401-080	CAP, ELECT 1-50V	A.....
C	547	87-010-401-080	CAP, ELECT 1-50V	A.....
D	532	87-A40-002-080	ZENER,MTZJ5.1C	A.....
D	531	87-A40-438-080	ZENER,MTZJ4.7A	A.....
D	501	87-A21-202-040	C-IC,M62445AFP	A.....
IC	501	87-026-609-080	TR,KTA1266GR	A.....
Q	505	87-A30-074-080	C-TR,RT1P 141C	A.....
Q	504	87-A30-257-080	C-TR,2SD1306E	A.....
Q	503	87-A30-257-080	C-TR,2SD1306E	A.....
		87-067-703-010	TAPPING SCREW, BVT2+3-10	A.....
C	109	87-010-196-080	CHIP CAPACITOR,0.1-25	A.....
C	101	87-010-917-090	CAP,E 3300-50 M SMG	A.....
C	102	87-010-917-090	CAP,E 3300-50 M SMG	A.....
C	105	87-012-368-080	C-CAP,S 0.1-50 F	A.....
C	108	87-012-368-080	C-CAP,S 0.1-50 F	A.....
C	106	87-012-368-080	C-CAP,S 0.1-50 F	A.....
C	107	87-012-368-080	C-CAP,S 0.1-50 F	A.....
C	104	87-016-658-090	CAP,E 4700-35 SMG	A.....
C	103	87-016-658-090	CAP,E 4700-35 SMG	A.....
C	111	87-010-196-080	CHIP CAPACITOR,0.1-25	A.....
C	110	87-010-196-080	CHIP CAPACITOR,0.1-25	A.....
C	112	87-010-196-080	CHIP CAPACITOR,0.1-25	A.....
C	113	87-010-247-080	CAP, ELECT 100-50V	A.....
C	116	87-010-247-080	CAP, ELECT 100-50V	A.....
C	119	87-010-260-080	CAP, ELECT 47-25V	A.....
C	118	87-010-263-080	CAP, ELECT 100-10V	A.....
C	114	87-010-385-080	CAP, ELECT 220-25V	A.....
C	115	87-010-385-080	CAP, ELECT 220-25V	A.....
C	117	87-010-430-080	CAP, ELECT 100-63	A.....
C	124	87-010-112-080	CAP, ELECT 100-16V	A.....
C	121	87-010-174-080	CAP CHIP SL470P (K)	A.....
C	125	87-010-235-080	CAP,E 470-16 SME	A.....
C	123	87-010-247-080	CAP, ELECT 100-50V	A.....
C	120	87-010-403-080	CAP, ELECT 3.3-50V	A.....
C	122	87-010-403-080	CAP, ELECT 3.3-50V	A.....
C	130	87-010-399-090	CAP,E 3300-35 SME	A.....
C	131	87-010-399-090	CAP,E 3300-35 SME	A.....
C	133	87-012-368-080	C-CAP,S 0.1-50 F	A.....
C	132	87-012-368-080	C-CAP,S 0.1-50 F	A.....
C	190	87-010-196-080	CHIP CAPACITOR,0.1-25	A.....
C	900	87-010-178-080	CHIP CAP 1000P	A.....
C	907	87-010-190-080	S CHIP F 0.01	A.....
C	908	87-010-190-080	S CHIP F 0.01	A.....
C	903	87-010-196-080	CHIP CAPACITOR,0.1-25	A.....
C	905	87-010-196-080	CHIP CAPACITOR,0.1-25	A.....
C	904	87-010-196-080	CHIP CAPACITOR,0.1-25	A.....
C	906	87-010-196-080	CHIP CAPACITOR,0.1-25	A.....
C	909	87-012-368-080	C-CAP,S 0.1-50 F	A.....
C	911	87-010-190-080	S CHIP F 0.01	A.....
C	912	87-010-190-080	S CHIP F 0.01	A.....
C	910	87-012-368-080	C-CAP,S 0.1-50 F	A.....
C	921	87-012-157-080	C-CAP,S 330P-50 CH	A.....
C	920	87-012-157-080	C-CAP,S 330P-50 CH	A.....
C	922	87-012-157-080	C-CAP,S 330P-50 CH	A.....
C	923	87-012-157-080	C-CAP,S 330P-50 CH	A.....
C	942	87-010-196-080	CHIP CAPACITOR,0.1-25	A.....
C	945	87-010-196-080	CHIP CAPACITOR,0.1-25	A.....
C	941	87-010-196-080	CHIP CAPACITOR,0.1-25	A.....
C	944	87-010-993-080	C-CAP,S 0.056-25 B	A.....
C	943	87-010-993-080	C-CAP,S 0.056-25 B	A.....
C	946	87-010-993-080	C-CAP,S 0.056-25 B	A.....
CN	123	87-049-469-010	CONN,4P V	A.....
CN	121	87-049-919-010	CONN,3P EH V WHT	A.....
CN	131	87-049-919-010	CONN,3P EH V WHT	A.....
CN	903	87-009-063-010	CONNECTOR 11P	A.....
CN	902	87-009-877-010	CONN,9P FG	A.....
CN	905	87-099-198-010	CONN,10P 6216 V	A.....
CN	901	87-099-719-010	CONN,30P TYK-B(X)	A.....
CN	907	87-A60-057-010	CONN,11P V 9604S-11C	A.....
CN	906	87-A60-058-010	CONN,10P V 9604S-10C	A.....
CN	904	87-A60-575-010	CONN,10P H 52303	A.....
D	102	87-017-447-010	DIODE,GBU4DL	A.....
D	103	87-020-465-080	DIODE,1SS133 (110MA)	A.....
D	106	87-070-274-080	DIODE,1N4003 SEM	A.....
D	108	87-070-274-080	DIODE,1N4003 SEM	A.....
D	107	87-070-274-080	DIODE,1N4003 SEM	A.....

ELECTRICAL MAIN PARTS LIST - 3/8 (MX-SNAVH1200)

D	109	87-070-274-080	DIODE,1N4003 SEM	A.....
D	100	87-070-274-080	DIODE,1N4003 SEM	A.....
D	104	87-A40-468-080	C-DIODE,HSM2836CTR	A.....
D	105	87-A40-469-080	C-DIODE,HSM2838CTR	A.....
D	101	87-A40-547-090	DIODE,D5SBA20	A.....
D	113	87-020-465-080	DIODE,1SS133 (110MA)	A.....
D	115	87-A40-004-080	ZENER,MTZJ16A	A.....
D	112	87-A40-345-080	ZENER,MTZJ10C	A.....
D	110	87-A40-435-080	ZENER,MTZJ30D	A.....
D	130	87-017-447-010	DIODE,GBU4DL	A.....
FB	501	87-003-223-010	FERRITE BEAD BLO2RN2	A.....
FB	901	87-008-372-080	FILTER,EMI BL OIRNI	A.....
J	901	87-A60-483-010	JACK,DIA6.3 BLK ST W/S KM	A.....
J	902	87-A60-617-010	TERMINAL,SP 4P (MSC)	A.....
J	903	87-A60-652-010	JACK,PIN 4P ORN/BLK	A.....
J	905	87-A60-658-010	JACK,PIN 6P WHITE/RED	A.....
J	904	87-A60-684-010	JACK,PIN 6P OR/BLK/RED	A.....
L	901	87-003-383-010	COIL,1UH-S	A.....
L	902	87-003-383-010	COIL,1UH-S	A.....
L	911	87-003-383-010	COIL,1UH-S	A.....
L	912	87-003-383-010	COIL,1UH-S	A.....
L	913	87-003-383-010	COIL,1UH-S	A.....
PR	105	87-026-681-080	PROTECTOR,5A 60V 491	A.....
PR	106	87-026-681-080	PROTECTOR,5A 60V 491	A.....
PR	103	87-026-682-080	PROTECTOR,10A 60V491	A.....
PR	104	87-026-682-080	PROTECTOR,10A 60V491	A.....
PR	101	87-A90-195-080	PROTECTOR 7A 125V 49	A.....
PR	102	87-A90-195-080	PROTECTOR 7A 125V 49	A.....
PR	201	87-002-330-080	ICP-N5	A.....
Q	103	87-026-610-080	TR,KTC3198GR	A.....
Q	107	87-A30-075-080	C-TR,2SA1235F	A.....
Q	109	87-A30-075-080	C-TR,2SA1235F	A.....
Q	104	87-A30-076-080	C-TR,2SC3052F	A.....
Q	106	87-A30-076-080	C-TR,2SC3052F	A.....
Q	108	87-A30-076-080	C-TR,2SC3052F	A.....
Q	105	87-A30-083-080	TR,CSD1489B	A.....
Q	112	87-026-609-080	TR,KTA1266GR	A.....
Q	111	87-026-609-080	TR,KTA1266GR	A.....
Q	115	87-026-610-080	TR,KTC3198GR	A.....
Q	114	87-A30-075-080	C-TR,2SA1235F	A.....
Q	110	87-A30-076-080	C-TR,2SC3052F	A.....
Q	117	89-213-702-010	TR,2SB1370 (1.8W)	A.....
Q	116	89-213-702-010	TR,2SB1370 (1.8W)	A.....
R	909	87-A00-440-050	RES,220-1/2W J RP	A.....
R	911	87-A00-440-050	RES,220-1/2W J RP	A.....
R	910	87-A00-440-050	RES,220-1/2W J RP	A.....
R	912	87-A00-440-050	RES,220-1/2W J RP	A.....
R	915	87-A00-527-080	RES,10-1/4W J NAT	A.....
R	914	87-A00-527-080	RES,10-1/4W J NAT	A.....
R	913	87-A00-527-080	RES,10-1/4W J NAT	A.....
R	916	87-A00-527-080	RES,10-1/4W J NAT	A.....
R	941	87-A00-527-080	RES,10-1/4W J NAT	A.....
R	942	87-A00-527-080	RES,10-1/4W J NAT	A.....
R	945	87-A00-527-080	RES,10-1/4W J NAT	A.....
W	101	8Z-SP1-627-010	F-CABLE,7P 2.5 280MM	A.....
WH	101	87-A90-460-010	HLDR,WIRE 2.5-7P	A.....
WH	102	87-A90-460-010	HLDR,WIRE 2.5-7P	A.....
C	202	87-010-322-080	C-CAP,S 100P-50 CH	A.....
C	201	87-010-322-080	C-CAP,S 100P-50 CH	A.....
C	209	87-010-405-080	CAP,ELECT 10-50V	A.....
C	211	87-010-183-080	C-CAP,S 2700P-50 B	A.....
C	212	87-010-183-080	C-CAP,S 2700P-50 B	A.....
C	214	87-010-187-080	CAP CHIP S5600P	A.....
C	213	87-010-187-080	CAP CHIP S5600P	A.....
C	216	87-010-405-080	CAP,ELECT 10-50V	A.....
C	215	87-010-405-080	CAP,ELECT 10-50V	A.....
C	210	87-010-405-080	CAP,ELECT 10-50V	A.....
C	218	87-010-408-080	CAP,ELECT 47-50V	A.....
C	217	87-010-408-080	CAP,ELECT 47-50V	A.....
C	219	87-A10-516-080	C-CAP,S 100P-200 J CH	A.....
C	223	87-010-405-080	CAP,ELECT 10-50V	A.....
C	226	87-010-405-080	CAP,ELECT 10-50V	A.....
C	227	87-010-407-080	CAP,ELECT 33-50V	A.....
C	229	87-010-407-080	CAP,ELECT 33-50V	A.....
C	222	87-016-462-080	C-CAP,S 1-16 F	A.....
C	221	87-016-462-080	C-CAP,S 1-16 F	A.....
C	220	87-A10-516-080	C-CAP,S 100P-200 J CH	A.....
C	231	87-010-186-080	CAP,CHIP 4700P	A.....
C	232	87-010-186-080	CAP,CHIP 4700P	A.....
C	235	87-010-196-080	CHIP CAPACITOR,0.1-25	A.....
C	234	87-010-401-080	CAP,ELECT 1-50V	A.....
C	233	87-010-401-080	CAP,ELECT 1-50V	A.....
C	230	87-010-408-080	CAP,ELECT 47-50V	A.....
C	290	87-010-188-080	CAP,CHIP 6800P	A.....
D	202	87-020-465-080	DIODE,1SS133 (110MA)	A.....
D	207	87-020-465-080	DIODE,1SS133 (110MA)	A.....
D	208	87-020-465-080	DIODE,1SS133 (110MA)	A.....
D	203	87-020-465-080	DIODE,1SS133 (110MA)	A.....
D	201	87-020-465-080	DIODE,1SS133 (110MA)	A.....
D	204	87-020-465-080	DIODE,1SS133 (110MA)	A.....
D	209	87-020-465-080	DIODE,1SS133 (110MA)	A.....
D	219	87-020-465-080	DIODE,1SS133 (110MA)	A.....

ELECTRICAL MAIN PARTS LIST - 4/8 (MX-SNAVH1200)

D	215	87-020-465-080	DIODE,1SS133 (110MA)	A.....
D	218	87-020-465-080	DIODE,1SS133 (110MA)	A.....
D	216	87-020-465-080	DIODE,1SS133 (110MA)	A.....
D	217	87-020-465-080	DIODE,1SS133 (110MA)	A.....
D	210	87-020-465-080	DIODE,1SS133 (110MA)	A.....
D	213	87-070-136-080	ZENER,MTZJ5.1B	A.....
D	214	87-070-136-080	ZENER,MTZJ5.1B	A.....
D	212	87-A40-370-090	DIODE,RK46-P20	A.....
D	211	87-A40-370-090	DIODE,RK46-P20	A.....
D	227	87-020-465-080	DIODE,1SS133 (110MA)	A.....
D	225	87-020-465-080	DIODE,1SS133 (110MA)	A.....
D	221	87-020-465-080	DIODE,1SS133 (110MA)	A.....
D	226	87-020-465-080	DIODE,1SS133 (110MA)	A.....
D	222	87-020-465-080	DIODE,1SS133 (110MA)	A.....
D	220	87-A40-345-080	ZENER,MTZJ10C	A.....
D	223	87-A40-488-080	DIODE,1SS244	A.....
D	224	87-A40-488-080	DIODE,1SS244	A.....
D	296	87-020-465-080	DIODE,1SS133 (110MA)	A.....
Q	204	87-A30-075-080	C-TR,2SA1235F	A.....
Q	201	87-A30-257-080	C-TR,2SD1306E	A.....
Q	202	87-A30-257-080	C-TR,2SD1306E	A.....
Q	207	87-A30-268-040	C-TR,2SA1514K(S)	A.....
Q	208	87-A30-268-040	C-TR,2SA1514K(S)	A.....
Q	209	87-A30-268-040	C-TR,2SA1514K(S)	A.....
Q	211	87-A30-076-080	C-TR,2SC3052F	A.....
Q	214	87-A30-076-080	C-TR,2SC3052F	A.....
Q	212	87-A30-076-080	C-TR,2SC3052F	A.....
Q	213	87-A30-076-080	C-TR,2SC3052F	A.....
Q	216	87-A30-190-080	TR,CC5551	A.....
Q	215	87-A30-190-080	TR,CC5551	A.....
Q	210	87-A30-268-040	C-TR,2SA1514K(S)	A.....
Q	227	87-A30-072-080	C-TR,RT1P 144C	A.....
Q	228	87-A30-073-080	C-TR,RT1N 141C	A.....
Q	226	87-A30-075-080	C-TR,2SA1235F	A.....
Q	225	87-A30-076-080	C-TR,2SC3052F	A.....
Q	222	87-A30-106-070	C-TR,CMBT5551	A.....
Q	221	87-A30-106-070	C-TR,CMBT5551	A.....
Q	229	87-A30-268-040	C-TR,2SA1514K(S)	A.....
Q	230	87-A30-075-080	C-TR,2SA1235F	A.....
Q	291	87-A30-074-080	C-TR,RT1P 141C	A.....
Q	290	87-A30-075-080	C-TR,2SA1235F	A.....
Q	295	87-A30-106-070	C-TR,CMBT5551	A.....
R	238	87-A00-262-080	RES,M/F 0.15-2W J	A.....
R	237	87-A00-262-080	RES,M/F 0.15-2W J	A.....
R	239	87-A00-262-080	RES,M/F 0.15-2W J	A.....
R	240	87-A00-262-080	RES,M/F 0.15-2W J	A.....
TH	201	87-A91-081-080	C-THMS,100K-K 20P	A.....
TH	202	87-A91-081-080	C-THMS,100K-K 20P	A.....
		88-SX1-203-210	GUIDE,FL	A.....
*		8Z-SP1-202-010	GUIDE,LED FUN	A.....
C	101	87-010-196-080	CHIP CAPACITOR,0.1-25	A.....
C	302	87-010-404-040	CAP,E 4.7-50 SME	A.....
C	301	87-010-404-040	CAP,E 4.7-50 SME	A.....
C	345	87-010-175-080	CAP 560P	A.....
C	346	87-010-175-080	CAP 560P	A.....
C	347	87-010-175-080	CAP 560P	A.....
C	342	87-010-175-080	CAP 560P	A.....
C	348	87-010-175-080	CAP 560P	A.....
C	344	87-010-175-080	CAP 560P	A.....
C	349	87-010-175-080	CAP 560P	A.....
C	341	87-010-175-080	CAP 560P	A.....
C	340	87-010-175-080	CAP 560P	A.....
C	343	87-010-175-080	CAP 560P	A.....
CN	101	87-099-720-010	CONN,30P TYK-B(P)	A.....
D	301	87-020-465-080	DIODE,1SS133 (110MA)	A.....
D	305	87-020-465-080	DIODE,1SS133 (110MA)	A.....
D	302	87-020-465-080	DIODE,1SS133 (110MA)	A.....
D	304	87-020-465-080	DIODE,1SS133 (110MA)	A.....
D	303	87-020-465-080	DIODE,1SS133 (110MA)	A.....
FL	301	8Z-SP1-617-010	FL,10-BT-218GK	A.....
LED	307	87-A40-589-040	LED,SLR-56VCT31 RED	A.....
LED	306	87-A40-589-040	LED,SLR-56VCT31 RED	A.....
LED	308	87-A40-589-040	LED,SLR-56VCT31 RED	A.....
LED	309	87-A40-589-040	LED,SLR-56VCT31 RED	A.....
LED	301	87-A40-619-040	LED,SLR-56PT-T31-W GRN	A.....
LED	305	87-A40-619-040	LED,SLR-56PT-T31-W GRN	A.....
LED	303	87-A40-619-040	LED,SLR-56PT-T31-W GRN	A.....
LED	302	87-A40-619-040	LED,SLR-56PT-T31-W GRN	A.....
LED	304	87-A40-619-040	LED,SLR-56PT-T31-W GRN	A.....
LED	310	87-A40-589-040	LED,SLR-56VCT31 RED	A.....
Q	307	87-026-226-080	CHIP-TR,DTA143EK	A.....
Q	305	87-A30-071-080	C-TR,RT1N 144C	A.....
Q	301	87-A30-071-080	C-TR,RT1N 144C	A.....
Q	304	87-A30-071-080	C-TR,RT1N 144C	A.....
Q	302	87-A30-071-080	C-TR,RT1N 144C	A.....
Q	303	87-A30-071-080	C-TR,RT1N 144C	A.....
Q	306	89-112-965-080	TR,2SA1296 (0.75W)	A.....
S	303	87-A90-095-080	SW,TACT EVQ11G04M	A.....
S	306	87-A90-095-080	SW,TACT EVQ11G04M	A.....
S	307	87-A90-095-080	SW,TACT EVQ11G04M	A.....
S	301	87-A90-095-080	SW,TACT EVQ11G04M	A.....
S	308	87-A90-095-080	SW,TACT EVQ11G04M	A.....

ELECTRICAL MAIN PARTS LIST - 5/8 (MX-SNAVH1200)

S	305	87-A90-095-080	SW,TACT	EVQ11G04M	A.....
S	304	87-A90-095-080	SW,TACT	EVQ11G04M	A.....
S	302	87-A90-095-080	SW,TACT	EVQ11G04M	A.....
S	309	87-A90-095-080	SW,TACT	EVQ11G04M	A.....
S	311	87-A90-095-080	SW,TACT	EVQ11G04M	A.....
S	310	87-A90-095-080	SW,TACT	EVQ11G04M	A.....
S	315	87-A90-095-080	SW,TACT	EVQ11G04M	A.....
S	312	87-A90-095-080	SW,TACT	EVQ11G04M	A.....
S	313	87-A90-095-080	SW,TACT	EVQ11G04M	A.....
S	314	87-A90-095-080	SW,TACT	EVQ11G04M	A.....
C	603	87-010-182-080	C-CAP,S	2200P-50 B	A.....
C	604	87-010-182-080	C-CAP,S	2200P-50 B	A.....
C	605	87-010-369-080	C-CAP,S	0.033-25 K B	A.....
C	606	87-010-369-080	C-CAP,S	0.033-25 K B	A.....
C	609	87-010-374-080	CAP, ELECT	47-10V	A.....
C	601	87-010-401-080	CAP, ELECT	1-50V	A.....
C	602	87-010-401-080	CAP, ELECT	1-50V	A.....
C	608	87-010-405-080	CAP, ELECT	10-50V	A.....
C	607	87-010-405-080	CAP, ELECT	10-50V	A.....
C	612	87-010-112-080	CAP, ELECT	100-16V	A.....
C	613	87-010-173-080	C-CAP,S	390P-50 SL	A.....
C	614	87-010-173-080	C-CAP,S	390P-50 SL	A.....
C	610	87-010-374-080	CAP, ELECT	47-10V	A.....
C	611	87-010-405-080	CAP, ELECT	10-50V	A.....
C	668	87-010-190-080	S CHIP F	0.01	A.....
CN	611	87-099-194-010	CONN,6P	6216V	A.....
IC	601	87-A20-804-040	C-IC,NJM2152M		A.....
PIN	612	87-099-568-010	CONN,11P	TUC-P11P-B1	A.....
PIN	611	87-099-570-010	CONN,13P	TUC-P13P-B1	A.....
C	701	87-010-402-080	CAP, ELECT	2.2-50V	A.....
C	702	87-010-402-080	CAP, ELECT	2.2-50V	A.....
C	709	87-010-956-080	CHIP-CAP,S	0.068-25B	A.....
C	708	87-012-365-080	C-CAP,S	0.027-25VBK	A.....
C	707	87-012-365-080	C-CAP,S	0.027-25VBK	A.....
C	706	87-016-460-080	C-CAP,S	0.22-16 B	A.....
C	705	87-016-460-080	C-CAP,S	0.22-16 B	A.....
C	703	87-016-669-080	C-CAP,S	0.1-25 K B	A.....
C	704	87-016-669-080	C-CAP,S	0.1-25 K B	A.....
C	719	87-010-178-080	CHIP CAP	1000P	A.....
C	715	87-010-183-080	C-CAP,S	2700P-50 B	A.....
C	716	87-010-183-080	C-CAP,S	2700P-50 B	A.....
C	718	87-010-188-080	CAP,CHIP	6800P	A.....
C	717	87-010-188-080	CAP,CHIP	6800P	A.....
C	711	87-010-197-080	CAP, CHIP	0.01 DM	A.....
C	712	87-010-197-080	CAP, CHIP	0.01 DM	A.....
C	714	87-010-198-080	CAP, CHIP	0.022	A.....
C	713	87-010-198-080	CAP, CHIP	0.022	A.....
C	710	87-010-956-080	CHIP-CAP,S	0.068-25B	A.....
C	720	87-010-178-080	CHIP CAP	1000P	A.....
C	721	87-010-182-080	C-CAP,S	2200P-50 B	A.....
C	722	87-010-182-080	C-CAP,S	2200P-50 B	A.....
C	731	87-010-112-080	CAP, ELECT	100-16V	A.....
C	738	87-010-196-080	CHIP CAPACITOR,	0.1-25	A.....
C	737	87-010-322-080	C-CAP,S	100P-50 CH	A.....
C	735	87-010-322-080	C-CAP,S	100P-50 CH	A.....
C	736	87-010-322-080	C-CAP,S	100P-50 CH	A.....
C	730	87-010-404-080	CAP, ELECT	4.7-50V	A.....
IC	701	87-A20-869-040	C-IC,M62449FP		A.....
C	701	87-010-260-080	CAP, ELECT	47-25V	A.....
C	702	87-010-404-080	CAP, ELECT	4.7-50V	A.....
C	709	87-012-195-080	C-CAP,U	100P-50CH	A.....
C	704	87-012-286-080	CAP, U	0.01-25	A.....
C	703	87-012-286-080	CAP, U	0.01-25	A.....
C	712	87-010-196-080	CHIP CAPACITOR,	0.1-25	A.....
C	711	87-010-263-080	CAP, ELECT	100-10V	A.....
C	719	87-012-286-080	CAP, U	0.01-25	A.....
C	714	87-012-286-080	CAP, U	0.01-25	A.....
C	717	87-012-286-080	CAP, U	0.01-25	A.....
C	713	87-012-286-080	CAP, U	0.01-25	A.....
C	727	87-010-196-080	CHIP CAPACITOR,	0.1-25	A.....
C	728	87-010-248-080	CAP, ELECT	220-10V	A.....
C	721	87-012-176-080	CAP 15P		A.....
C	722	87-012-176-080	CAP 15P		A.....
C	720	87-012-195-080	C-CAP,U	100P-50CH	A.....
C	725	87-012-274-080	CHIP CAP,U	1000P-50B	A.....
C	723	87-012-274-080	CHIP CAP,U	1000P-50B	A.....
CN	601	87-099-028-010	CONN,11P	6216 H	A.....
D	721	87-A40-234-080	ZENER,MTZJ5.6A		A.....
IC	721	87-070-127-110	IC,LC72131 D		A.....
Q	711	87-A30-196-080	TR,2SC4115SRS		A.....
X	721	87-A70-061-010	VIB,XTAL	4.500MHZ CSA-309	A.....
C	758	87-012-167-080	C-CAP,U	5P-50 CH	A.....
C	757	87-012-188-080	C-CAP,U	47P-50 CH	A.....
C	756	87-012-286-080	CAP, U	0.01-25	A.....
C	755	87-012-286-080	CAP, U	0.01-25	A.....
C	761	87-010-196-080	CHIP CAPACITOR,	0.1-25	A.....
C	769	87-010-260-080	CAP, ELECT	47-25V	A.....
C	763	87-010-829-080	CAP, U	0.047-16	A.....
C	768	87-012-286-080	CAP, U	0.01-25	A.....
C	765	87-012-286-080	CAP, U	0.01-25	A.....
C	766	87-012-286-080	CAP, U	0.01-25	A.....
C	762	87-012-286-080	CAP, U	0.01-25	A.....

ELECTRICAL MAIN PARTS LIST - 6/8 (MX-SNAVH1200)

C	764	87-012-337-080	C-CAP,U 56P-50 CH	A.....
C	774	87-010-263-080	CAP, ELECT 100-10V	A.....
C	777	87-010-400-080	CAP, ELECT 0.47-50V	A.....
C	779	87-010-401-080	CAP, ELECT 1-50V	A.....
C	778	87-010-401-080	CAP, ELECT 1-50V	A.....
C	775	87-010-404-080	CAP, ELECT 4.7-50V	A.....
C	771	87-010-407-080	CAP, ELECT 33-50V	A.....
C	770	87-010-829-080	CAP, U 0.047-16	A.....
C	772	87-010-829-080	CAP, U 0.047-16	A.....
C	773	87-015-785-080	CHIP CAPACITOR, 0.1FZ-25Z	A.....
C	780	87-010-196-080	CHIP CAPACITOR,0.1-25	A.....
C	781	87-010-405-080	CAP, ELECT 10-50V	A.....
C	782	87-010-405-080	CAP, ELECT 10-50V	A.....
C	785	87-010-805-080	CAP, S 1-16	A.....
C	786	87-010-805-080	CAP, S 1-16	A.....
C	789	87-012-275-080	C-CAP,U 1200P-50 B	A.....
C	788	87-012-280-080	CAP, U 3300P-50	A.....
C	787	87-012-280-080	CAP, U 3300P-50	A.....
C	783	87-012-286-080	CAP, U 0.01-25	A.....
C	784	87-012-286-080	CAP, U 0.01-25	A.....
C	796	87-010-403-080	CAP, ELECT 3.3-50V	A.....
C	791	87-010-405-080	CAP, ELECT 10-50V	A.....
C	794	87-010-406-080	CAP, ELECT 22-50	A.....
C	799	87-010-829-080	CAP, U 0.047-16	A.....
C	793	87-012-273-080	C-CAP,U 820P-50 B	A.....
C	790	87-012-275-080	C-CAP,U 1200P-50 B	A.....
C	797	87-012-276-080	CAP, CHIP SS 1500 PBK	A.....
C	798	87-012-276-080	CAP, CHIP SS 1500 PBK	A.....
C	795	87-A10-504-080	C-CAP,U 0.047-16 K B	A.....
D	773	87-020-465-080	DIODE,1SS133 (110MA)	A.....
IC	771	87-A20-913-010	IC,LA1837NL	A.....
L	771	87-A50-266-010	COIL,FM DET-2N(TOK)	A.....
L	772	87-A90-052-010	FLTR,CFMT-450A(TOK)	A.....
L	781	87-005-847-080	COIL,2.2UH(CECS)	A.....
L	791	87-A50-027-010	COIL,1 POLE MPX(TOK)	A.....
L	792	87-A50-027-010	COIL,1 POLE MPX(TOK)	A.....
X	771	87-030-354-010	VIB,CF BFU 450C	A.....
C	819	87-010-197-080	CAP, CHIP 0.01 DM	A.....
C	813	87-010-197-080	CAP, CHIP 0.01 DM	A.....
C	814	87-012-286-080	CAP, U 0.01-25	A.....
C	812	87-012-286-080	CAP, U 0.01-25	A.....
C	829	87-010-196-080	CHIP CAPACITOR,0.1-25	A.....
C	828	87-010-196-080	CHIP CAPACITOR,0.1-25	A.....
C	820	87-010-260-080	CAP, ELECT 47-25V	A.....
C	821	87-012-286-080	CAP, U 0.01-25	A.....
C	823	87-012-286-080	CAP, U 0.01-25	A.....
C	822	87-012-286-080	CAP, U 0.01-25	A.....
C	944	87-010-575-080	C-CAP,S 560P-50 UJ	A.....
C	941	87-012-182-080	C-CAP,U 27P-50 CH	A.....
C	943	87-012-286-080	CAP, U 0.01-25	A.....
C	940	87-012-286-080	CAP, U 0.01-25	A.....
C	945	87-012-286-080	CAP, U 0.01-25	A.....
C	947	87-012-286-080	CAP, U 0.01-25	A.....
C	959	87-010-196-080	CHIP CAPACITOR,0.1-25	A.....
C	956	87-010-263-080	CAP, ELECT 100-10V	A.....
C	954	87-010-400-080	CAP, ELECT 0.47-50V	A.....
C	952	87-012-286-080	CAP, U 0.01-25	A.....
C	953	87-012-286-080	CAP, U 0.01-25	A.....
C	950	87-A10-913-080	C-CAP, 4700P-50 J CH	A.....
C	960	87-010-196-080	CHIP CAPACITOR,0.1-25	A.....
C	962	87-010-401-080	CAP, ELECT 1-50V	A.....
C	964	87-012-170-080	C-CAP,U 8P-50 CH	A.....
CF	802	87-008-261-010	FILTER, SFE10.7MA5-A	A.....
CF	801	87-008-261-010	FILTER, SFE10.7MA5-A	A.....
D	941	87-020-465-080	DIODE,1SS133 (110MA)	A.....
FFE	801	A8-8ZA-190-030	8ZA-1 FEUNM	A.....
J	801	87-A60-657-010	TERMINAL,4P HSP-154V5-02	A.....
U	940	81-754-629-010	CONNECTOR, 2P	A.....
L	832	87-005-847-080	COIL,2.2UH(CECS)	A.....
L	943	87-005-372-080	COIL S 1MHM	A.....
L	941	87-A50-022-010	COIL,ANT SW(COI)	A.....
L	944	87-A50-159-010	COIL,10MH K C2B	A.....
L	942	87-A50-173-010	COIL,OSC SW-N(COI)	A.....
L	981	88-NF8-625-110	COIL,AM PACK3N(TOK)	A.....
Q	806	87-A30-072-080	C-TR,RT1P 144C	A.....
Q	807	87-A30-072-080	C-TR,RT1P 144C	A.....
Q	805	89-327-143-080	TR,2SC2714 (0.1W)	A.....
Q	941	87-A30-074-080	C-TR,RT1P 141C	A.....
Q	942	87-A30-075-080	C-TR,2SA1235F	A.....
Q	943	87-A30-075-080	C-TR,2SA1235F	A.....
Q	945	87-A30-076-080	C-TR,2SC3052F	A.....
Q	949	87-A30-076-080	C-TR,2SC3052F	A.....
Q	944	87-A30-076-080	C-TR,2SC3052F	A.....
Q	946	87-A30-086-070	C-TR,CSD1306E	A.....
Q	948	87-A30-086-070	C-TR,CSD1306E	A.....
Q	947	89-503-602-080	C-FET,2SK360E	A.....
Q	951	87-A30-074-080	C-TR,RT1P 141C	A.....
Q	950	87-A30-086-070	C-TR,CSD1306E	A.....
TC	943	87-011-164-010	CAPACITOR,TRIMMER 30P	A.....
TC	941	87-011-173-010	CERAMIC TRIMMER 20P	A.....
C	802	87-010-176-080	C-CAP,S 680P-50 SL	A.....
C	801	87-010-176-080	C-CAP,S 680P-50 SL	A.....

ELECTRICAL MAIN PARTS LIST - 7/8 (MX-SNAVH1200)

C	809	87-010-196-080	CHIP CAPACITOR,0.1-25	A.....
C	808	87-010-401-080	CAP, ELECT 1-50V	A.....
C	807	87-010-401-080	CAP, ELECT 1-50V	A.....
C	805	87-010-958-080	CHIP -CAP,S 0.01-25BJ	A.....
C	806	87-010-958-080	CHIP -CAP,S 0.01-25BJ	A.....
C	804	87-010-958-080	CHIP -CAP,S 0.01-25BJ	A.....
C	803	87-010-958-080	CHIP -CAP,S 0.01-25BJ	A.....
C	810	87-010-112-080	CAP, ELECT 100-16V	A.....
C	817	87-010-221-080	CAP, ELECT 470-10V	A.....
C	813	87-010-401-080	CAP, ELECT 1-50V	A.....
C	814	87-010-401-080	CAP, ELECT 1-50V	A.....
C	812	87-010-402-080	CAP, ELECT 2.2-50V	A.....
C	811	87-010-402-080	CAP, ELECT 2.2-50V	A.....
C	816	87-010-546-080	CAP, ELECT 0.33-50V	A.....
C	815	87-010-546-080	CAP, ELECT 0.33-50V	A.....
C	819	87-A10-800-080	C-CAP,S 6800P-16 J B CM	A.....
C	818	87-A10-891-080	CAP,E 4.7-25 SME(K)	A.....
C	825	87-010-196-080	CHIP CAPACITOR,0.1-25	A.....
C	821	87-010-196-080	CHIP CAPACITOR,0.1-25	A.....
C	824	87-010-374-080	CAP, ELECT 47-10V	A.....
C	820	87-010-374-080	CAP, ELECT 47-10V	A.....
C	829	87-010-544-080	CAP, ELECT 0.1-50V	A.....
C	823	87-A10-800-080	C-CAP,S 6800P-16 J B CM	A.....
C	822	87-A10-804-080	C-CAP,S 0.1-25 J B	A.....
C	839	87-010-401-080	CAP, ELECT 1-50V	A.....
C	830	87-010-546-080	CAP, ELECT 0.33-50V	A.....
C	831	87-010-971-080	C-CAP,S 4700P-50 B J	A.....
C	837	87-010-971-080	C-CAP,S 4700P-50 B J	A.....
C	838	87-012-349-080	C-CAP,S 1000P-50 CH	A.....
C	832	87-012-349-080	C-CAP,S 1000P-50 CH	A.....
C	840	87-010-401-080	CAP, ELECT 1-50V	A.....
C	846	87-010-404-080	CAP, ELECT 4.7-50V	A.....
C	847	87-010-404-080	CAP, ELECT 4.7-50V	A.....
C	848	87-012-393-080	C-CAP,S 0.22-16 R K	A.....
C	844	87-012-393-080	C-CAP,S 0.22-16 R K	A.....
C	849	87-012-393-080	C-CAP,S 0.22-16 R K	A.....
C	845	87-012-393-080	C-CAP,S 0.22-16 R K	A.....
C	843	87-A10-229-080	C-CAP,S 0.68-10 K W5	A.....
C	841	87-A10-799-080	C-CAP,S 5600P-16 J B CM	A.....
C	842	87-A10-802-080	C-CAP,S 0.047-16 J B CM	A.....
C	850	87-016-081-080	C-CAP,S 0.1-16 RK	A.....
C	854	87-016-081-080	C-CAP,S 0.1-16 RK	A.....
C	857	87-016-081-080	C-CAP,S 0.1-16 RK	A.....
C	853	87-016-081-080	C-CAP,S 0.1-16 RK	A.....
C	856	87-A10-801-080	C-CAP,S 0.022-16 J B CM	A.....
C	855	87-A10-801-080	C-CAP,S 0.022-16 J B CM	A.....
C	851	87-A10-802-080	C-CAP,S 0.047-16 J B CM	A.....
C	852	87-A10-802-080	C-CAP,S 0.047-16 J B CM	A.....
C	866	87-010-194-080	CAP, CHIP 0.047	A.....
C	861	87-010-196-080	CHIP CAPACITOR,0.1-25	A.....
C	863	87-010-263-080	CAP, ELECT 100-10V	A.....
C	865	87-016-460-080	C-CAP,S 0.22-16 B	A.....
C	868	87-A10-060-080	C-CAP,S 0.18-16 K B	A.....
C	867	87-A10-201-080	C-CAP,S 0.33-16 KB	A.....
C	879	87-010-179-080	CAP,CHIP S B1200P	A.....
C	878	87-010-401-080	CAP, ELECT 1-50V	A.....
C	880	87-010-179-080	CAP,CHIP S B1200P	A.....
C	895	87-010-195-080	C-CAP,S 0.068-25 F	A.....
C	896	87-010-260-080	CAP, ELECT 47-25V	A.....
C	894	87-010-263-080	CAP, ELECT 100-10V	A.....
C	892	87-010-401-080	CAP, ELECT 1-50V	A.....
C	893	87-010-401-080	CAP, ELECT 1-50V	A.....
C	891	87-010-401-080	CAP, ELECT 1-50V	A.....
C	890	87-012-358-080	C-CAP,S 0.47-10 F Z	A.....
CN	402	87-099-557-010	CONN,11P TUC-P11X-B1	A.....
CN	401	87-099-559-010	CONN,13P TUC-P13X-B1	A.....
D	802	87-070-136-080	ZENER,MTZJ5.1B	A.....
D	801	87-A40-442-080	ZENER,MTZJ9.1A	A.....
D	891	87-A40-438-080	ZENER,MTZJ4.7A	A.....
D	892	87-A40-438-080	ZENER,MTZJ4.7A	A.....
IC	801	87-A21-097-040	C-IC,M62463AFP	A.....
IC	831	87-A21-015-040	C-IC,M62491FP	A.....
Q	831	87-A30-086-040	C-TR,CSD1306E	A.....
Q	894	87-A30-075-080	C-TR,2SA1235F	A.....
Q	893	87-A30-076-080	C-TR,2SC3052F	A.....
Q	892	87-A30-086-040	C-TR,CSD1306E	A.....
Q	891	87-A30-086-040	C-TR,CSD1306E	A.....
R	807	87-022-214-080	C-RES S100K-1/10WF	A.....
C	952	87-010-263-080	CAP, ELECT 100-10V	A.....
C	953	87-010-380-080	CAP, ELECT 47-16V	A.....
C	951	87-010-401-080	CAP, ELECT 1-50V	A.....
CN	951	87-A60-109-010	CONN,2P V S2M-2W	A.....
D	951	87-020-465-080	DIODE,1SS133 (110MA)	A.....
D	952	87-020-465-080	DIODE,1SS133 (110MA)	A.....
Q	952	87-026-609-080	TR,KTA1266GR	A.....
Q	951	87-A30-076-080	C-TR,2SC3052F	A.....
C	304	87-010-178-080	CHIP CAP 1000P	A.....
C	303	87-010-178-080	CHIP CAP 1000P	A.....
C	308	87-010-322-080	C-CAP,S 100P-50 CH	A.....
C	307	87-010-322-080	C-CAP,S 100P-50 CH	A.....
C	301	87-010-402-080	CAP, ELECT 2.2-50V	A.....
C	302	87-010-402-080	CAP, ELECT 2.2-50V	A.....

ELECTRICAL MAIN PARTS LIST - 8/8 (MX-SNAVH1200)

C	305	87-010-404-080	CAP, ELECT 4.7-50V	A.....
C	306	87-010-404-080	CAP, ELECT 4.7-50V	A.....
C	309	87-010-405-080	CAP, ELECT 10-50V	A.....
C	319	87-010-182-080	C-CAP,S 2200P-50 B	A.....
C	314	87-010-260-080	CAP, ELECT 47-25V	A.....
C	313	87-010-260-080	CAP, ELECT 47-25V	A.....
C	310	87-010-405-080	CAP, ELECT 10-50V	A.....
C	318	87-010-544-080	CAP, ELECT 0.1-50V	A.....
C	317	87-010-544-080	CAP, ELECT 0.1-50V	A.....
C	315	87-A10-596-080	C-CAP,S 100P-100 J CH	A.....
C	316	87-A10-596-080	C-CAP,S 100P-100 J CH	A.....
C	321	87-012-145-080	CAP, CHIP S 270P CH	A.....
C	322	87-012-145-080	CAP, CHIP S 270P CH	A.....
C	324	87-016-462-080	C-CAP,S 1-16 F	A.....
C	323	87-016-462-080	C-CAP,S 1-16 F	A.....
C	352	87-010-178-080	CHIP CAP 1000P	A.....
C	357	87-010-260-080	CAP, ELECT 47-25V	A.....
C	354	87-010-322-080	C-CAP,S 100P-50 CH	A.....
C	351	87-010-402-080	CAP, ELECT 2.2-50V	A.....
C	353	87-010-404-080	CAP, ELECT 4.7-50V	A.....
C	355	87-010-405-080	CAP, ELECT 10-50V	A.....
C	359	87-010-544-080	CAP, ELECT 0.1-50V	A.....
C	358	87-A10-596-080	C-CAP,S 100P-100 J CH	A.....
C	360	87-012-145-080	CAP, CHIP S 270P CH	A.....
C	361	87-016-462-080	C-CAP,S 1-16 F	A.....
C	381	87-010-402-080	CAP, ELECT 2.2-50V	A.....
C	391	87-010-260-080	CAP, ELECT 47-25V	A.....
D	309	87-020-465-080	DIODE,1SS133 (110MA)	A.....
D	307	87-020-465-080	DIODE,1SS133 (110MA)	A.....
D	308	87-020-465-080	DIODE,1SS133 (110MA)	A.....
D	305	87-020-465-080	DIODE,1SS133 (110MA)	A.....
D	302	87-020-465-080	DIODE,1SS133 (110MA)	A.....
D	306	87-020-465-080	DIODE,1SS133 (110MA)	A.....
D	301	87-020-465-080	DIODE,1SS133 (110MA)	A.....
D	310	87-020-465-080	DIODE,1SS133 (110MA)	A.....
D	315	87-020-465-080	DIODE,1SS133 (110MA)	A.....
D	318	87-020-465-080	DIODE,1SS133 (110MA)	A.....
D	317	87-020-465-080	DIODE,1SS133 (110MA)	A.....
D	316	87-020-465-080	DIODE,1SS133 (110MA)	A.....
D	311	87-A40-488-080	DIODE,1SS244	A.....
D	312	87-A40-488-080	DIODE,1SS244	A.....
D	353	87-020-465-080	DIODE,1SS133 (110MA)	A.....
D	355	87-020-465-080	DIODE,1SS133 (110MA)	A.....
D	354	87-020-465-080	DIODE,1SS133 (110MA)	A.....
D	351	87-020-465-080	DIODE,1SS133 (110MA)	A.....
D	356	87-A40-488-080	DIODE,1SS244	A.....
Q	304	87-A30-075-080	C-TR,2SA1235F	A.....
Q	305	87-A30-075-080	C-TR,2SA1235F	A.....
Q	303	87-A30-075-080	C-TR,2SA1235F	A.....
Q	306	87-A30-075-080	C-TR,2SA1235F	A.....
Q	307	87-A30-076-080	C-TR,2SC3052F	A.....
Q	309	87-A30-076-080	C-TR,2SC3052F	A.....
Q	308	87-A30-076-080	C-TR,2SC3052F	A.....
Q	301	87-A30-257-080	C-TR,2SD1306E	A.....
Q	302	87-A30-257-080	C-TR,2SD1306E	A.....
Q	319	87-A30-075-080	C-TR,2SA1235F	A.....
Q	310	87-A30-076-080	C-TR,2SC3052F	A.....
Q	318	87-A30-076-080	C-TR,2SC3052F	A.....
Q	317	87-A30-076-080	C-TR,2SC3052F	A.....
Q	311	87-A30-190-080	TR,CC5551	A.....
Q	312	87-A30-190-080	TR,CC5551	A.....
Q	353	87-A30-075-080	C-TR,2SA1235F	A.....
Q	352	87-A30-075-080	C-TR,2SA1235F	A.....
Q	359	87-A30-076-080	C-TR,2SC3052F	A.....
Q	354	87-A30-076-080	C-TR,2SC3052F	A.....
Q	355	87-A30-076-080	C-TR,2SC3052F	A.....
Q	356	87-A30-190-080	TR,CC5551	A.....
Q	351	87-A30-257-080	C-TR,2SD1306E	A.....
Q	360	87-A30-075-080	C-TR,2SA1235F	A.....
Q	381	87-A30-257-080	C-TR,2SD1306E	A.....
R	332	87-022-050-080	RES,M/F 0.22-1W J	A.....
R	331	87-022-050-080	RES,M/F 0.22-1W J	A.....
R	333	87-022-050-080	RES,M/F 0.22-1W J	A.....
R	334	87-022-050-080	RES,M/F 0.22-1W J	A.....
R	366	87-022-050-080	RES,M/F 0.22-1W J	A.....
R	367	87-022-050-080	RES,M/F 0.22-1W J	A.....
C	138	87-010-387-080	CAP,E 470-25 SME	A.....
C	140	87-A10-480-090	CAP,CER 4700P-250 M E KH	A.....
C	141	87-A10-480-090	CAP,CER 4700P-250 M E KH	A.....
D	118	87-070-345-080	DIODE,IN4148	A.....
D	117	87-070-345-080	DIODE,IN4148	A.....
D	116	87-070-345-080	DIODE,IN4148	A.....
D	119	87-070-345-080	DIODE,IN4148	A.....
D	121	87-070-345-080	DIODE,IN4148	A.....
D	120	87-070-345-080	DIODE,IN4148	A.....
D	122	87-070-345-080	DIODE,IN4148	A.....
PT	102	8Z-NF8-663-010	PT,SUB ZNF-8(H)	A.....
Q	101	87-026-245-080	TR,DTC114ES	A.....
RY	101	87-A91-281-010	RELAY,AC DC12V OSA-SS-212DM5	A.....
S	101	87-036-173-010	SW,SL 2-2-4 SDKG(*)	A.....
T	101	87-A60-317-010	TERMINAL, 1P MSC	A.....
T	102	87-A60-317-010	TERMINAL, 1P MSC	A.....

SCHEMATIC DIAGRAM - 1 (MX-SNAVH1200 : MAIN 1/2)

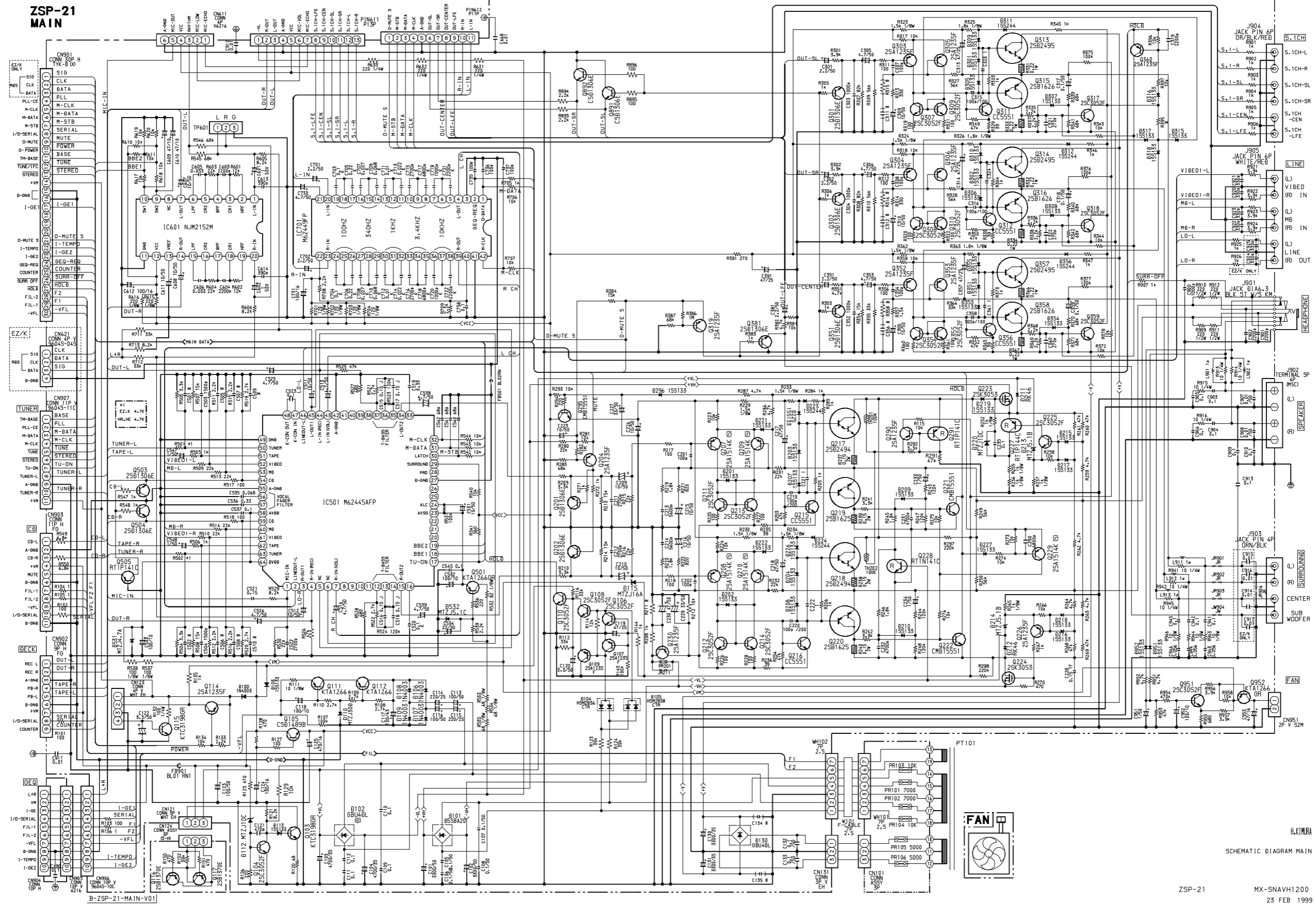

H.KIMURA

SCHEMATIC DIAGRAM MAIN

ZSP-21

MX-SNAVH1200

23 FEB 1999

SCHEMATIC DIAGRAM – 2 (MX-SNAVH1200 : MAIN 2/2 PROLOGIC)

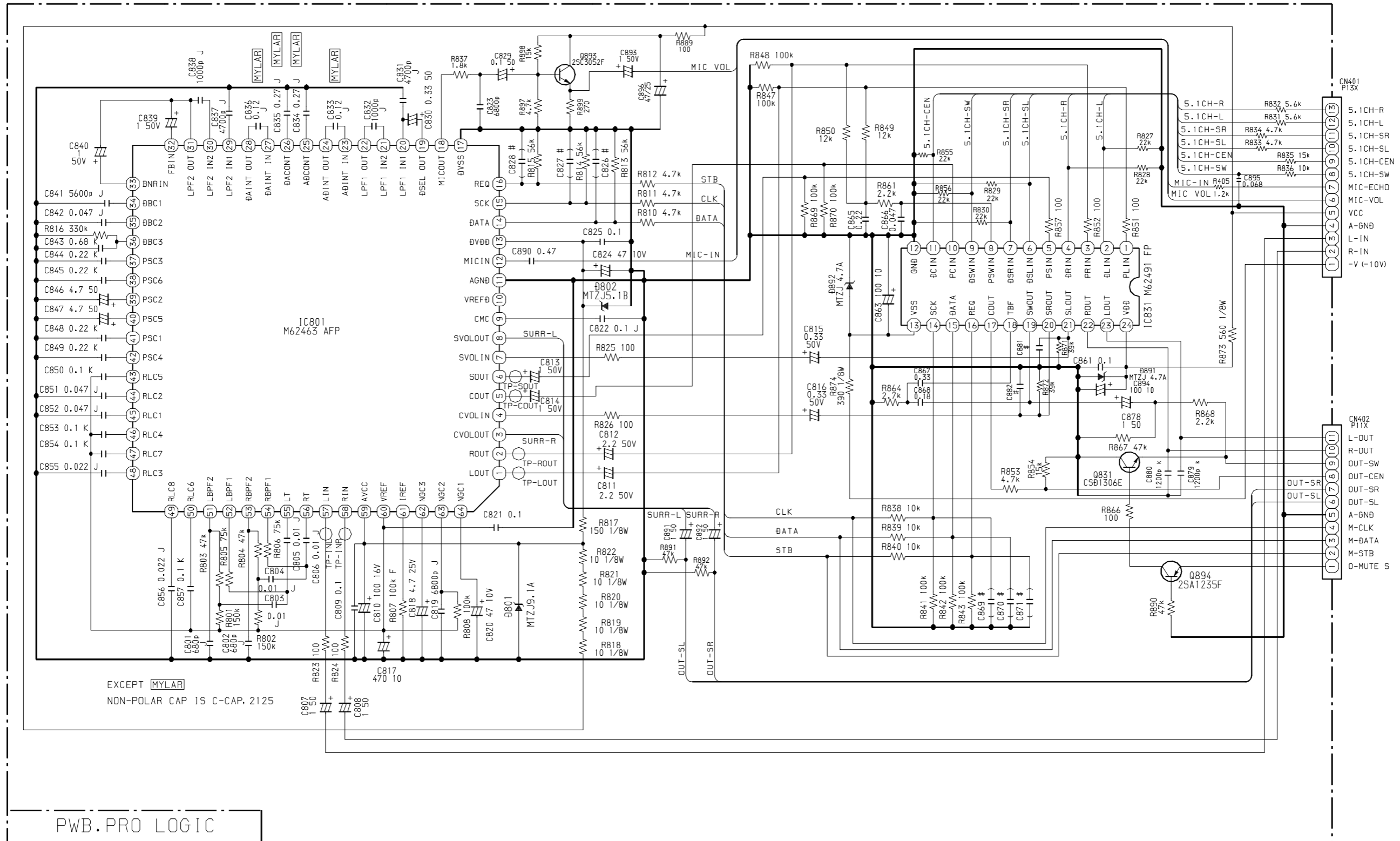

SCHEMATIC DIAGRAM - 3 (MX-SNAVH1200 : FRONT)

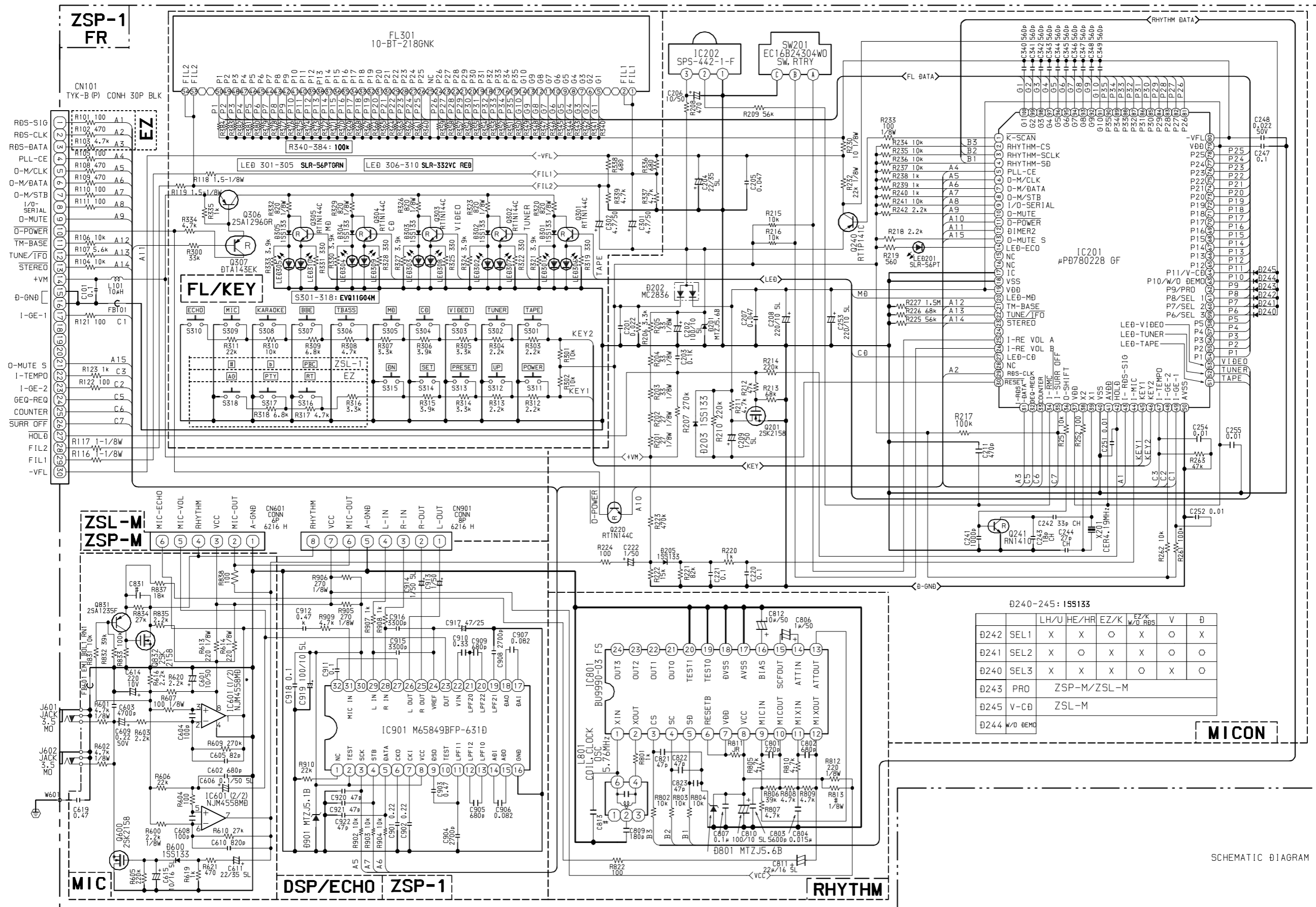

0240-245: 1S5133

	LH/U	HE/HR	EZ/K	EZ/K W/O RBS	V	Ø
0242	SEL1	X	X	○	X	○
0241	SEL2	X	○	X	X	○
0240	SEL3	X	X	X	○	○
0243	PRO	ZSP-M/ZSL-M				
0245	V-CB	ZSL-M				
0244	W/O BEMO					

SCHEMATIC DIAGRAM (FR)

SCHEMATIC DIAGRAM - 4 (MX-SNAVH1200 : TUNER)

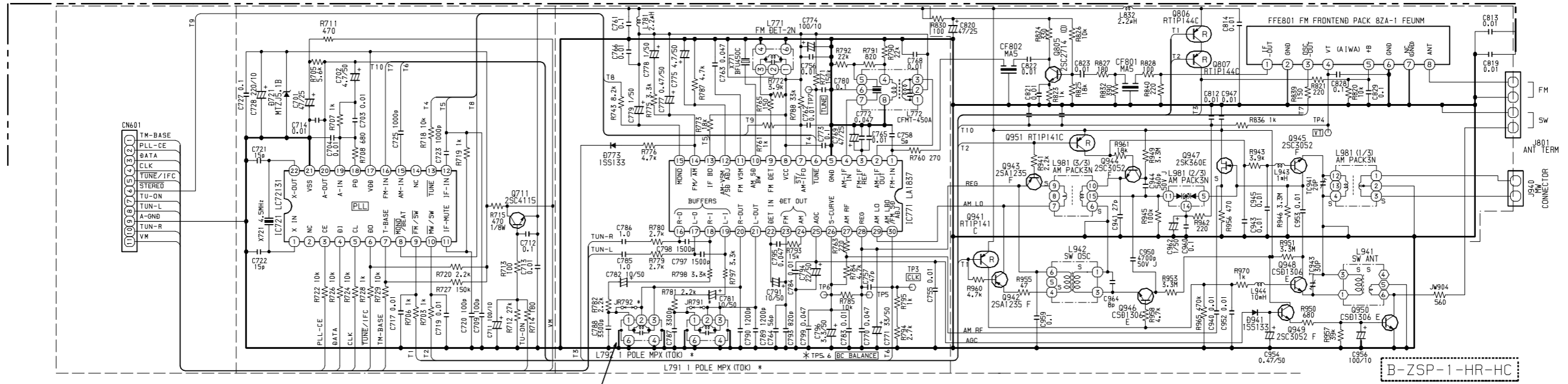

DOLBY MODEL USE L791 792 MPX
OTHERS USE JR791 792

B-ZSP-1-HR-HC

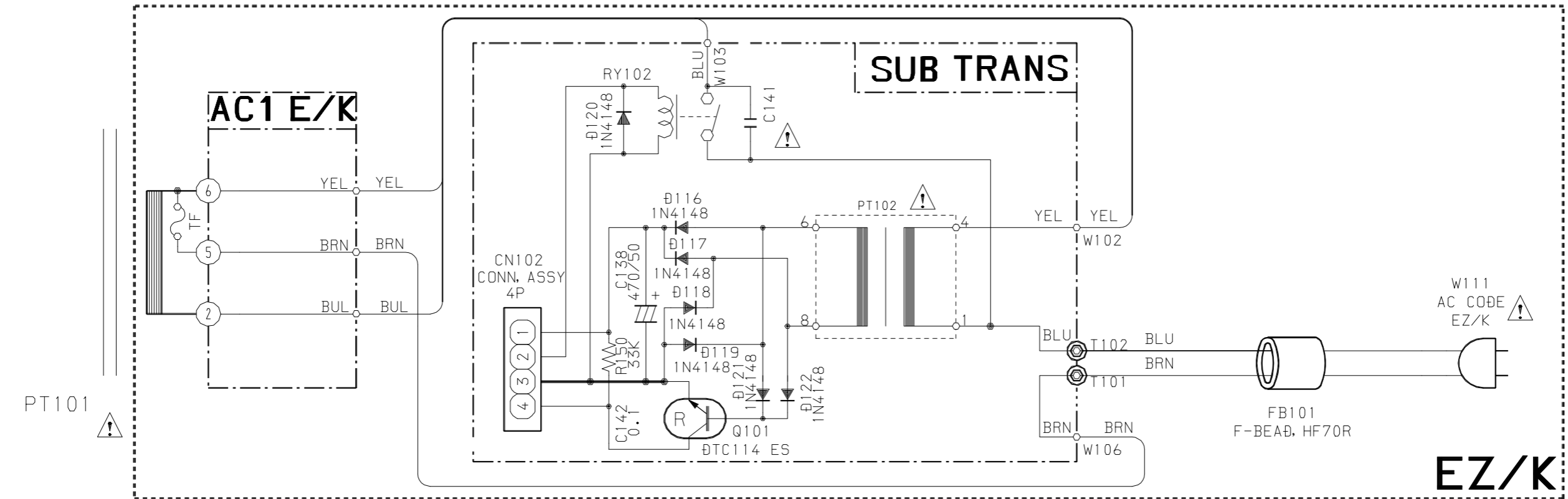
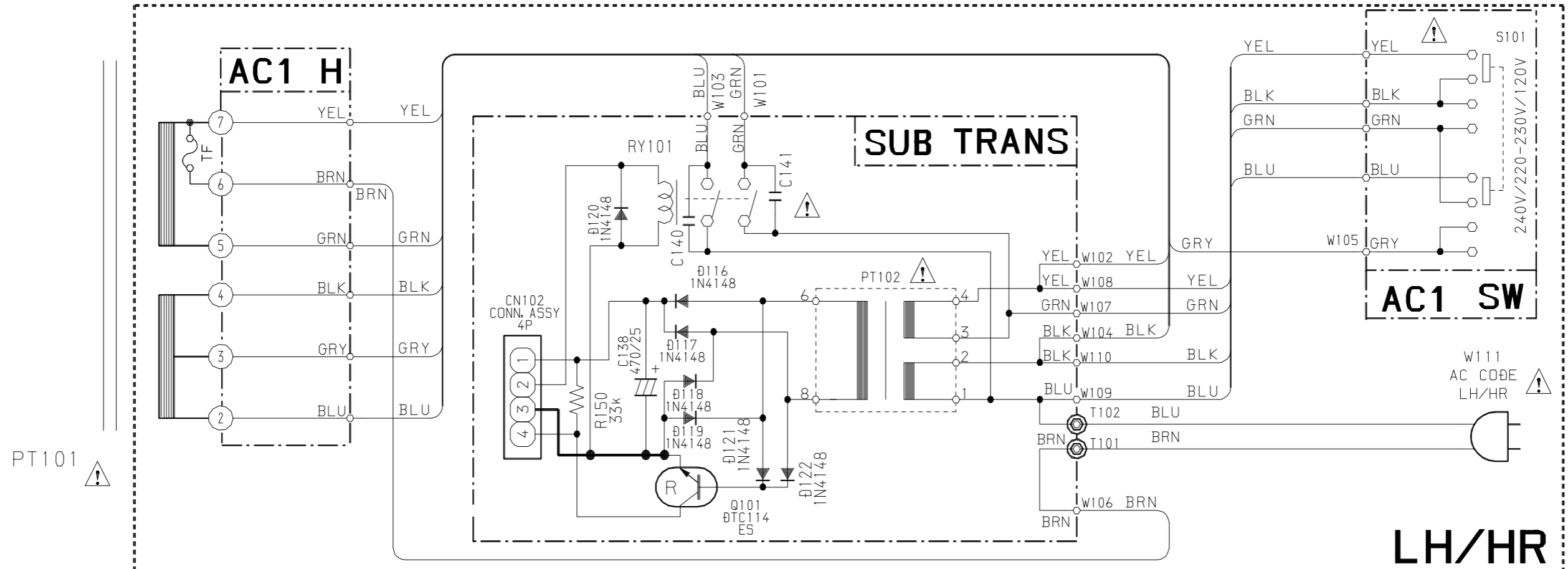

MECHANICAL PARTS LIST - 1/1 (MX-SNAVH1200)

NOTE: The characters in the suffix column indicate the part usage.

REF.NO	PARTS NO.	DESCRIPTION	SUFFIX
HSM	XX.....	A.....
		KANRI	
		NO.	
87-B00-002-010		BADGE,AIWA 30 ABS SIL	A.....
8Z-SP1-002-010		CABI,STEEL	A.....
8Z-SP1-017-010		PANEL,SIDE L	A.....
8Z-SP1-018-010		PANEL,SIDE R	A.....
8Z-SPM-005-010		CABI,FR HR	A.....
8Z-SPM-008-010		PANEL,REAR HR	A.....
8Z-SP1-007-010		KEY,BBE	A.....
8Z-SP1-008-010		KEY,KARAOKE	A.....
8Z-SP1-010-010		KEY,ASSY FUN	A.....
8Z-SP1-011-010		KNOB,RTRY VOL	A.....
8Z-SP1-012-010		RING,VOL	A.....
8Z-SP1-015-010		REFLECTOR,ECO	A.....
8Z-SPM-002-010		WINDOW,DISPLAY	A.....
87-085-213-010		FOOT,H12.5	A.....
88-AR1-203-010		HLDR,TU	A.....
88-SPM-208-010		HLDR,PWB PRO	A.....
8Z-NB8-240-010		COVER, PL	A.....
8Z-SP1-207-010		COVER, FAN	A.....
8Z-SP1-208-010		HLDR,PWB 13.5	A.....
8Z-SP1-209-010		HLDR,PWB ECO	A.....
87-067-641-010		UTT2+3-8(W/O SLOT)BL	A.....
87-067-688-010		BVTT+3-6	A.....
87-067-703-010		TAPPING SCREW, BVT2+3-10	A.....
87-078-019-010		S-SCREW,IT+4-6	A.....
87-081-514-010		VTT+3-12	A.....
87-591-094-410		TAPPING SCREW, QIT+3-6	A.....
87-721-095-410		QT2+3-8GLD W/O SLOT	A.....
87-B10-190-010		BVT2+3-22 W/O SLOT	A.....
87-064-185-010		HLDR,WIRE	A.....
87-085-185-010		BUSHING, AC CORD (E)	A.....
88-906-301-110		FF-CABLE,6P-1.25	A.....
88-910-071-110		FF-CABLE, 10P 1.25 70MM	A.....
88-911-121-110		FF-CABLE,11P 1.25	A.....
C 182		CAP, CER 1000P-50V	A.....
CCM 181		CAP, CER 1000P-50V	A.....
M 101		FAN,F614R-12MC-22-350MM	A.....
PT 101		PT,HE	A.....
Q 217		TR,2SD2494	A.....
Q 218		TR,2SD2494	A.....
Q 219		TR,2SB1625	A.....
Q 220		TR,2SB1625	A.....
Q 223		FET,2SK3053	A.....
Q 224		FET,2SK3053	A.....
Q 316		TR,2SB1626	A.....
Q 315		TR,2SB1626	A.....
Q 313		TR,2SD 2495	A.....
Q 314		TR,2SD 2495	A.....
Q 358		TR,2SB1626	A.....
Q 357		TR,2SD 2495	A.....
W 111		AC-CORD ASSY,E	A.....
		87-067-703-010 TAPPING SCREW, BVT2+3-10	A.....
W 101		8Z-SP1-627-010 F-CABLE,7P 2.5 280MM	A.....
WH 101		87-A90-460-010 HLDR,WIRE 2.5-7P	A.....
WH 102		87-A90-460-010 HLDR,WIRE 2.5-7P	A.....
		88-SX1-203-210 GUIDE,FL	A.....

ELECTRICAL MAIN PARTS LIST - 1/1 (DX-SNH1100)

NOTE: The characters in the suffix column indicate the part usage.

REF.NO	PARTS NO.	NO.	DESCRIPTION	SUFFIX
YJSM	XX	A
YSM	XX	B
		KANRI		
S	101	87-A90-095-080	SW,TACT EVQ11G04M	AB
S	102	87-A90-095-080	SW,TACT EVQ11G04M	AB
		88-SX1-203-210	GUIDE,FL	AB
		8Z-SX1-202-010	GUIDE,LED OPE	AB
		8Z-SX1-203-010	GUIDE,LED DISC	AB
C	2	87-010-072-040	CAP,E 2.2-50 5L	AB
C	5	87-010-190-080	S CHIP F 0.01	AB
C	6	87-010-196-080	CHIP CAPACITOR,0.1-25	AB
C	7	87-010-197-080	CAP,CHIP 0.01 DM	AB
C	4	87-010-246-040	CAP,E 47-35 SME	AB
C	1	87-010-264-040	CAP,E 100-10 5L	AB
C	8	87-010-314-080	C-CAP,S 22P-50V	AB
C	9	87-010-316-080	C-CAP,S 33P-50 CH	AB
C	11	87-010-196-080	CHIP CAPACITOR,0.1-25	AB
C	12	87-010-197-080	CAP,CHIP 0.01 DM	AB
C	10	87-010-315-080	C-CAP,S 27P-50 CH	AB
C	14	87-010-405-040	CAP,E 10-50	AB
C	15	87-010-405-040	CAP,E 10-50	AB
C	202	87-010-197-080	CAP,CHIP 0.01 DM	AB
C	203	87-010-197-080	CAP,CHIP 0.01 DM	AB
C	201	87-018-134-080	CAPACITOR,TC-U 0.01-16	AB
C	252	87-010-178-080	CHIP CAP 1000P	AB
C	255	87-010-178-080	CHIP CAP 1000P	AB
C	251	87-010-178-080	CHIP CAP 1000P	AB
C	254	87-010-178-080	CHIP CAP 1000P	AB
C	253	87-010-178-080	CHIP CAP 1000P	AB
C	256	87-010-178-080	CHIP CAP 1000P	AB
C	304	87-010-196-080	CHIP CAPACITOR,0.1-25	AB
C	305	87-010-197-080	CAP,CHIP 0.01 DM	AB
C	301	87-010-322-080	C-CAP,S 100P-50 CH	AB
C	313	87-010-184-080	CHIP CAPACITOR 3300P(K)	AB
C	314	87-010-402-040	CAP,E 2.2-50 SME	AB
C	312	87-016-462-080	C-CAP,S 1-16 F	AB
C	311	87-016-462-080	C-CAP,S 1-16 F	AB
C	310	87-016-462-080	C-CAP,S 1-16 F	AB
CN	2	87-099-559-010	CONN,13P TUC-P13X-B1	AB
CN	1	87-099-669-010	CONN,8P TUC-P8X-B1	AB
CN	301	87-009-241-010	CONNECTOR, 11P	AB
CN	303	87-099-015-010	CONN,13P 6216V	AB
CN	302	87-099-194-010	CONN,6P 6216V	AB
CN	305	87-099-570-010	CONN,13P TUC-P13P-B1	AB
CN	304	87-099-667-010	CONN,8P TUC-P8P-B1	AB
D	1	87-020-465-080	DIODE,1SS133 (110MA)	AB
D	2	87-070-136-080	ZENER,MTZJ5.1B	AB
D	3	87-070-136-080	ZENER,MTZJ5.1B	AB
FB	303	87-008-372-080	FILTER,EMI BL OIRNI	AB
FB	306	87-008-372-080	FILTER,EMI BL OIRNI	AB
FB	307	87-008-372-080	FILTER,EMI BL OIRNI	AB
FB	301	87-008-372-080	FILTER,EMI BL OIRNI	AB
FB	305	87-008-372-080	FILTER,EMI BL OIRNI	AB
FB	302	87-008-372-080	FILTER,EMI BL OIRNI	AB
FB	304	87-008-372-080	FILTER,EMI BL OIRNI	AB
FL	201	8Z-SX1-608-010	FL,6-BT-303GNK	AB
IC	1	8Z-SX1-607-010	C-IC,UPD78046HGF-024-3B9	AB
L	3	87-005-152-080	COIL,10UH	AB
L	5	87-005-152-080	COIL,10UH	AB
L	1	87-005-152-080	COIL,10UH	AB
L	2	87-005-152-080	COIL,10UH	AB
L	301	87-005-152-080	COIL,10UH	AB
L	302	87-005-165-080	COIL 1UH (H,E)	AB
LED	203	87-A40-263-080	LED,SLH-56PCT31 GRN	AB
LED	204	87-A40-263-080	LED,SLH-56PCT31 GRN	AB
LED	206	87-A40-317-080	LED,SLR-342VCT31 RED	AB
LED	205	87-A40-317-080	LED,SLR-342VCT31 RED	AB
LED	207	87-A40-317-080	LED,SLR-342VCT31 RED	AB
Q	2	87-026-263-080	C-TR,RN1410	AB
Q	302	87-A30-076-080	C-TR,2SC3052F	AB
Q	303	87-A30-076-080	C-TR,2SC3052F	AB
Q	304	87-A30-076-080	C-TR,2SC3052F	AB
S	203	87-A90-095-080	SW,TACT EVQ11G04M	AB
S	207	87-A90-095-080	SW,TACT EVQ11G04M	AB
S	208	87-A90-095-080	SW,TACT EVQ11G04M	AB
S	201	87-A90-095-080	SW,TACT EVQ11G04M	AB
S	204	87-A90-095-080	SW,TACT EVQ11G04M	AB
S	205	87-A90-095-080	SW,TACT EVQ11G04M	AB
S	206	87-A90-095-080	SW,TACT EVQ11G04M	AB
S	202	87-A90-095-080	SW,TACT EVQ11G04M	AB
W	3	88-SX1-610-010	CORD,FG 11P	AB
X	1	87-A70-075-080	VIB,CER 4.19MHZ CRHF	AB

SCHEMATIC DIAGRAM - 6 (DX-SNH1100 : MAIN / FRONT)

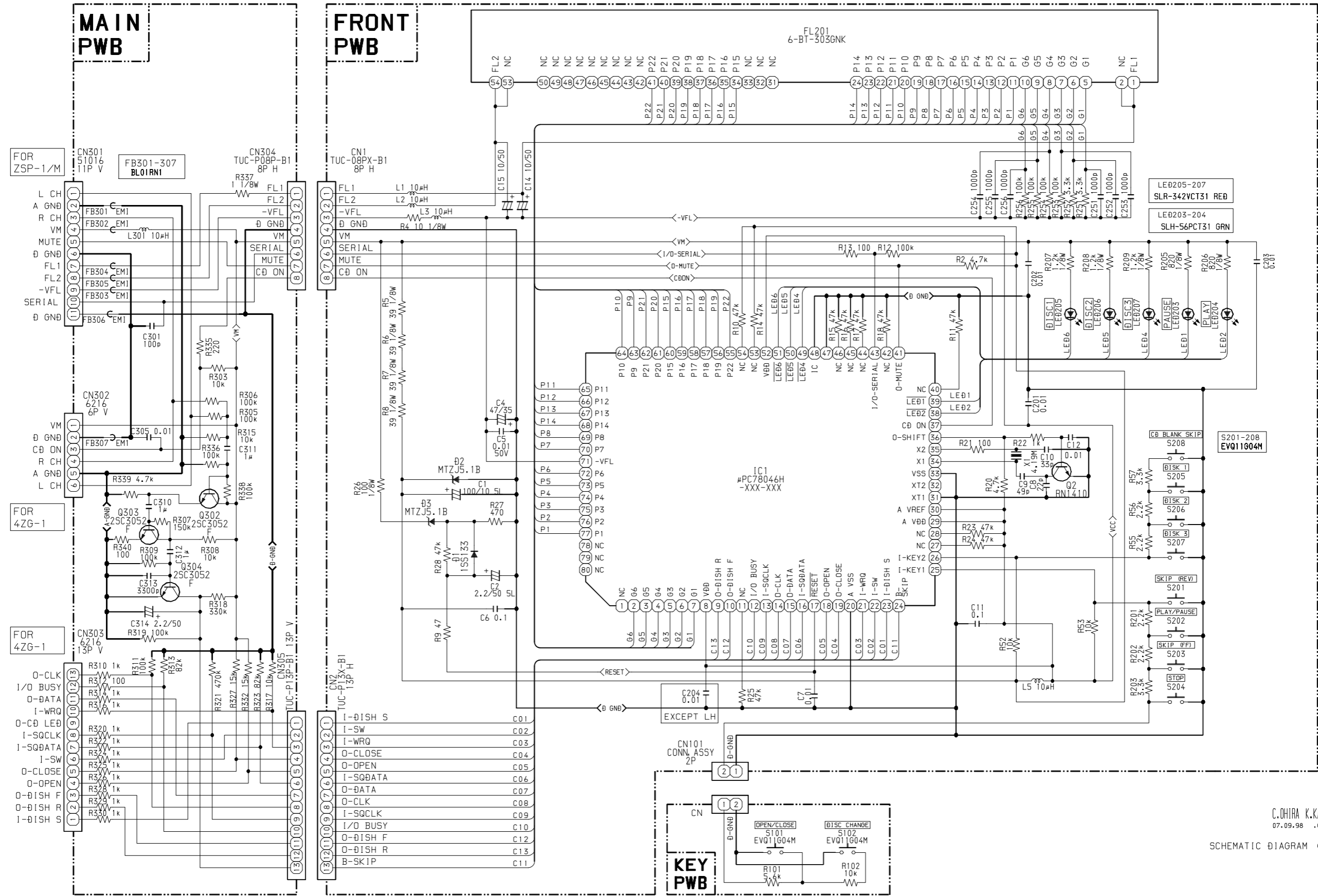

C. OHIRA, K. KASUYA
07.09.98 .09.98

SCHEMATIC DIAGRAM (CD)

ZSX-1FR

ZSX-1 FR

DX-

10 FEB 1999

MECHANICAL PARTS LIST - 1/1 (DX-SNH1100)

NOTE: The characters in the suffix column indicate the part usage.

REF.NO	PARTS NO.	KANRI NO.	DESCRIPTION	SUFFIX	
		XX		A	
		XX		B	
	87-B00-002-010		BADGE,AIWA 30 ABS SIL	AB	
	8Z-SX1-001-010		CABI,FR	AB	
	8Z-SX1-010-010		CABI,REAR YLSM		
	8Z-SX1-011-010		PANEL,SIDE L	AB	
	8Z-SX1-012-010		PANEL,SIDE R	AB	
	8Z-SX1-013-010		CABI,STEEL	AB	
	8Z-SX1-016-010		CABI,REAR YJSM	A	
	8Z-SX1-017-010		CABI,REAR YSM	.B	
	8Z-SX1-021-010		CABI,STEEL		
	8Z-SX1-004-010		KEY,OPEN	AB	
	8Z-SX1-005-010		KEY,DISC	AB	
	8Z-SX1-008-010		KEY,ASSY OPE	AB	
	8Z-SX1-009-010		REFLECTOR,DISC	AB	
	8Z-SX1-002-010		PANEL,TRAY	AB	
	8Z-SX1-003-010		WINDOW,CD	AB	
	84-ZG1-245-210		CAP,OPTICAL	AB	
	8Z-SX1-201-010		HLDR,CD	AB	
	87-067-633-010		TAPPING SCREW, BVT2+3-8		
	87-067-703-010		TAPPING SCREW, BVT2+3-10	AB	
	87-721-097-410		QT2+3-12 GLD	AB	
	87-B10-091-010		UTT2+3-10 W/O BLK	AB	
W	2		88-906-481-110	FF-CABLE, 6P 1.25 480MM	AB
W	1		88-913-121-110	FF-CABLE,P1.25	AB
			88-SX1-203-210	GUIDE,FL	AB
			8Z-SX1-202-010	GUIDE,LED OPE	AB
			8Z-SX1-203-010	GUIDE,LED DISC	AB
W	3		88-SX1-610-010	CORD,FG 11P	AB

ELECTRICAL MAIN PARTS LIST - 1/2 (FX-SNH1100)

NOTE: The characters in the suffix column indicate the part usage.

REF.NO	PARTS NO.	KANRI NO.	DESCRIPTION	SUFFIX
YJSM		XX		A
YSM		XX		B
*	8Z-SW1-203-010		GUIDE,LED OPE	AB
*	8Z-SW1-204-010		GUIDE,LED REC	AB
*	8Z-SW1-205-010		GUIDE,LED CASS 1	AB
*	8Z-SW1-206-010		GUIDE,LED CASS 2	AB
CN	703	87-A60-060-010	CONN,07P V 9604S-07C	AB
CN	701	87-A60-062-010	CONN,05P V 9604S-05C	AB
D	702	87-002-787-080	LED,SEL 6215S RED	AB
D	701	87-070-278-010	LED,SLZ-738A-24-S	AB
D	714	87-070-278-010	LED,SLZ-738A-24-S	AB
D	712	87-A40-496-040	LED,SLR-342MCT31 GRN	AB
D	713	87-A40-496-040	LED,SLR-342MCT31 GRN	AB
D	711	87-A40-496-040	LED,SLR-342MCT31 GRN	AB
S	704	87-A90-095-080	SW,TACT EVQ11G04M	AB
S	702	87-A90-095-080	SW,TACT EVQ11G04M	AB
S	703	87-A90-095-080	SW,TACT EVQ11G04M	AB
S	701	87-A90-095-080	SW,TACT EVQ11G04M	AB
S	713	87-A90-095-080	SW,TACT EVQ11G04M	AB
S	715	87-A90-095-080	SW,TACT EVQ11G04M	AB
S	712	87-A90-095-080	SW,TACT EVQ11G04M	AB
S	714	87-A90-095-080	SW,TACT EVQ11G04M	AB
S	711	87-A90-095-080	SW,TACT EVQ11G04M	AB
C	603	87-010-101-080	CAP, ELECT 220-16	AB
C	609	87-010-196-080	CHIP CAPACITOR,0.1-25	AB
C	605	87-010-198-080	CAP, CHIP 0.022	AB
C	604	87-010-237-080	CAP, ELECT 1000-16V	AB
C	607	87-010-263-080	CAP, ELECT 100-10V	AB
C	602	87-010-381-080	CAP, ELECT 330-16V	AB
C	606	87-010-404-080	CAP, ELECT 4.7-50V	AB
C	601	87-015-997-090	CAP,E 2200-16 SME	AB
C	614	87-010-197-080	CAP, CHIP 0.01 DM	AB
C	611	87-010-312-080	C-CAP,S 15P-50 CH	AB
C	612	87-010-315-080	C-CAP,S 27P-50 CH	AB
C	610	87-010-318-080	C-CAP,S 47P-50 CH	AB
C	613	87-010-404-080	CAP, ELECT 4.7-50V	AB
CN	501	87-099-750-010	CONN,15P V 9604SC	AB
CN	704	87-A60-060-010	CONN,07P V 9604S-07C	AB
CN	702	87-A60-062-010	CONN,05P V 9604S-05C	AB
D	602	87-017-931-080	ZENER,MTZJ5.6B	AB
D	603	87-017-931-080	ZENER,MTZJ5.6B	AB
D	604	87-020-465-080	DIODE,1SS133 (110MA)	AB
FB	301	87-008-372-080	FILTER, EMI BL OIRNI	AB
FB	601	87-008-372-080	FILTER, EMI BL OIRNI	AB
FB	602	87-008-372-080	FILTER, EMI BL OIRNI	AB
FB	603	87-008-372-080	FILTER, EMI BL OIRNI	AB
FB	604	87-A90-923-010	F-BEAD,8-13-14 E1314MRT	.B
IC	601	8Z-SW1-608-040	IC,M38503M4-088FP T4	AB
L	601	87-005-130-080	COIL,10UH	AB
L	603	87-005-130-080	COIL,10UH	AB
Q	603	87-026-263-080	C-TR,RN1410	AB
Q	609	87-A30-071-080	C-TR,RT1N 144C	AB
Q	605	87-A30-073-080	C-TR,RT1N 141C	AB
Q	604	87-A30-073-080	C-TR,RT1N 141C	AB
Q	606	87-A30-074-080	C-TR,RT1P 141C	AB
Q	608	87-A30-076-080	C-TR,2SC3052F	AB
Q	607	87-A30-076-080	C-TR,2SC3052F	AB
Q	602	87-A30-164-080	TR,CSC2001K	AB
Q	601	89-318-155-080	TR,2SC1815 (0.4W)	AB
Q	610	87-A30-076-080	C-TR,2SC3052F	AB
Q	801	87-A30-073-080	C-TR,RT1N 141C	AB
Q	802	87-A30-073-080	C-TR,RT1N 141C	AB
W	601	88-SW1-607-010	CORD,FG9P	AB
X	601	87-A70-120-080	VIB,8.00MHZ MTZ-TF01	AB
C	307	87-010-196-080	CHIP CAPACITOR,0.1-25	AB
C	301	87-010-318-080	C-CAP,S 47P-50 CH	AB
C	302	87-010-318-080	C-CAP,S 47P-50 CH	AB
C	306	87-012-145-080	CAP, CHIP S 270P CH	AB
C	305	87-012-145-080	CAP, CHIP S 270P CH	AB
C	303	87-012-157-080	C-CAP,S 330P-50 CH	AB
C	304	87-012-157-080	C-CAP,S 330P-50 CH	AB
C	313	87-010-180-080	C-CER 1500P	AB
C	314	87-010-180-080	C-CER 1500P	AB
C	311	87-010-198-080	CAP, CHIP 0.022	AB
C	312	87-010-198-080	CAP, CHIP 0.022	AB
C	319	87-012-141-080	CHIP-CAPACITOR,0.22-16F	AB
C	318	87-012-142-080	CAP, S 0.33-16	AB
C	317	87-012-142-080	CAP, S 0.33-16	AB
C	324	87-010-260-080	CAP, ELECT 47-25V	AB
C	325	87-010-370-080	CAP,E 330-6.3 SME	AB
C	327	87-010-404-080	CAP, ELECT 4.7-50V	AB
C	328	87-010-404-080	CAP, ELECT 4.7-50V	AB
C	320	87-012-141-080	CHIP-CAPACITOR,0.22-16F	AB
C	322	87-012-141-080	CHIP-CAPACITOR,0.22-16F	AB
C	321	87-012-141-080	CHIP-CAPACITOR,0.22-16F	AB
C	339	87-010-196-080	CHIP CAPACITOR,0.1-25	AB
C	337	87-010-196-080	CHIP CAPACITOR,0.1-25	AB

ELECTRICAL MAIN PARTS LIST - 2/2 (FX-SNH1100)

C	332	87-010-196-080	CHIP CAPACITOR,0.1-25	AB.....
C	336	87-010-401-080	CAP, ELECT 1-50V	AB.....
C	335	87-010-401-080	CAP, ELECT 1-50V	AB.....
C	340	87-010-196-080	CHIP CAPACITOR,0.1-25	AB.....
C	354	87-010-175-080	CAP 560P	.B.....
C	355	87-010-178-080	CHIP CAP 1000P	AB.....
C	358	87-010-183-080	C-CAP,S 2700P-50 B	AB.....
C	359	87-010-183-080	C-CAP,S 2700P-50 B	AB.....
C	356	87-010-260-080	CAP, ELECT 47-25V	AB.....
C	352	87-012-140-080	CAP 470P	AB.....
C	351	87-012-140-080	CAP 470P	AB.....
C	360	87-010-183-080	C-CAP,S 2700P-50 B	AB.....
C	372	87-010-179-080	CAP,CHIP S B1200P	AB.....
C	374	87-010-179-080	CAP,CHIP S B1200P	AB.....
C	371	87-010-179-080	CAP,CHIP S B1200P	AB.....
C	373	87-010-179-080	CAP,CHIP S B1200P	AB.....
C	370	87-010-196-080	CHIP CAPACITOR,0.1-25	AB.....
C	378	87-010-196-080	CHIP CAPACITOR,0.1-25	AB.....
C	376	87-010-545-080	CAP, ELECT 0.22-50V	AB.....
C	375	87-010-545-080	CAP, ELECT 0.22-50V	AB.....
C	385	87-010-184-080	CHIP CAPACITOR 3300P(K)	AB.....
C	386	87-010-196-080	CHIP CAPACITOR,0.1-25	AB.....
C	382	87-010-318-080	C-CAP,S 47P-50 CH	AB.....
C	384	87-010-403-080	CAP, ELECT 3.3-50V	AB.....
C	399	87-010-197-080	CAP, CHIP 0.01 DM	AB.....
CN	301	87-049-919-010	CONN,3P EH V WHT	AB.....
D	352	87-A40-269-080	C-DIODE,MC2836	AB.....
D	361	87-020-465-080	DIODE,1SS133 (110MA)	AB.....
IC	302	87-A20-355-010	IC,CXA1553P	AB.....
IC	301	87-A20-455-010	IC,HA12211	AB.....
L	302	87-A50-049-010	COIL,TRAP 85K(COI)	AB.....
L	301	87-A50-049-010	COIL,TRAP 85K(COI)	AB.....
L	351	87-007-342-010	COIL,OSC 85K BIAS	AB.....
PIN	301	87-099-827-010	CONN,3P S2M-3W	AB.....
PIN	351	87-099-832-010	CONN,8P S2M-8W	AB.....
Q	359	87-026-610-080	TR,KTC3198GR	AB.....
Q	358	87-026-610-080	TR,KTC3198GR	AB.....
Q	357	87-026-610-080	TR,KTC3198GR	AB.....
Q	355	87-A30-074-080	C-TR,RT1P 141C	AB.....
Q	354	87-A30-087-080	C-FET,2SK2158	AB.....
Q	353	87-A30-087-080	C-FET,2SK2158	AB.....
Q	351	87-A30-087-080	C-FET,2SK2158	AB.....
Q	360	87-A30-073-080	C-TR,RT1N 141C	AB.....
Q	381	87-A30-076-080	C-TR,2SC3052F	AB.....
Q	382	87-A30-076-080	C-TR,2SC3052F	AB.....
SFR	303	87-024-355-080	SFR,33K DIA6 H	AB.....
SFR	302	87-024-355-080	SFR,33K DIA6 H	AB.....
SFR	301	87-024-355-080	SFR,33K DIA6 H	AB.....
SFR	304	87-024-355-080	SFR,33K DIA6 H	AB.....
SFR	305	87-024-356-080	SFR,47K DIA6 H	AB.....
SFR	306	87-024-356-080	SFR,47K DIA6 H	AB.....
SFR	351	87-024-356-080	SFR,47K DIA6 H	AB.....
SFR	352	87-024-356-080	SFR,47K DIA6 H	AB.....
D	501	87-A40-269-080	C-DIODE,MC2836	AB.....
Q	506	87-A30-073-080	C-TR,RT1N 141C	AB.....
Q	502	87-A30-085-070	C-TR,CSA1362GR	AB.....
Q	503	87-A30-085-070	C-TR,CSA1362GR	AB.....
Q	501	89-112-965-080	TR,2SA1296 (0.75W)	AB.....

SCHEMATIC DIAGRAM - 7 (FX-SNH1100 : MAIN / FRONT)

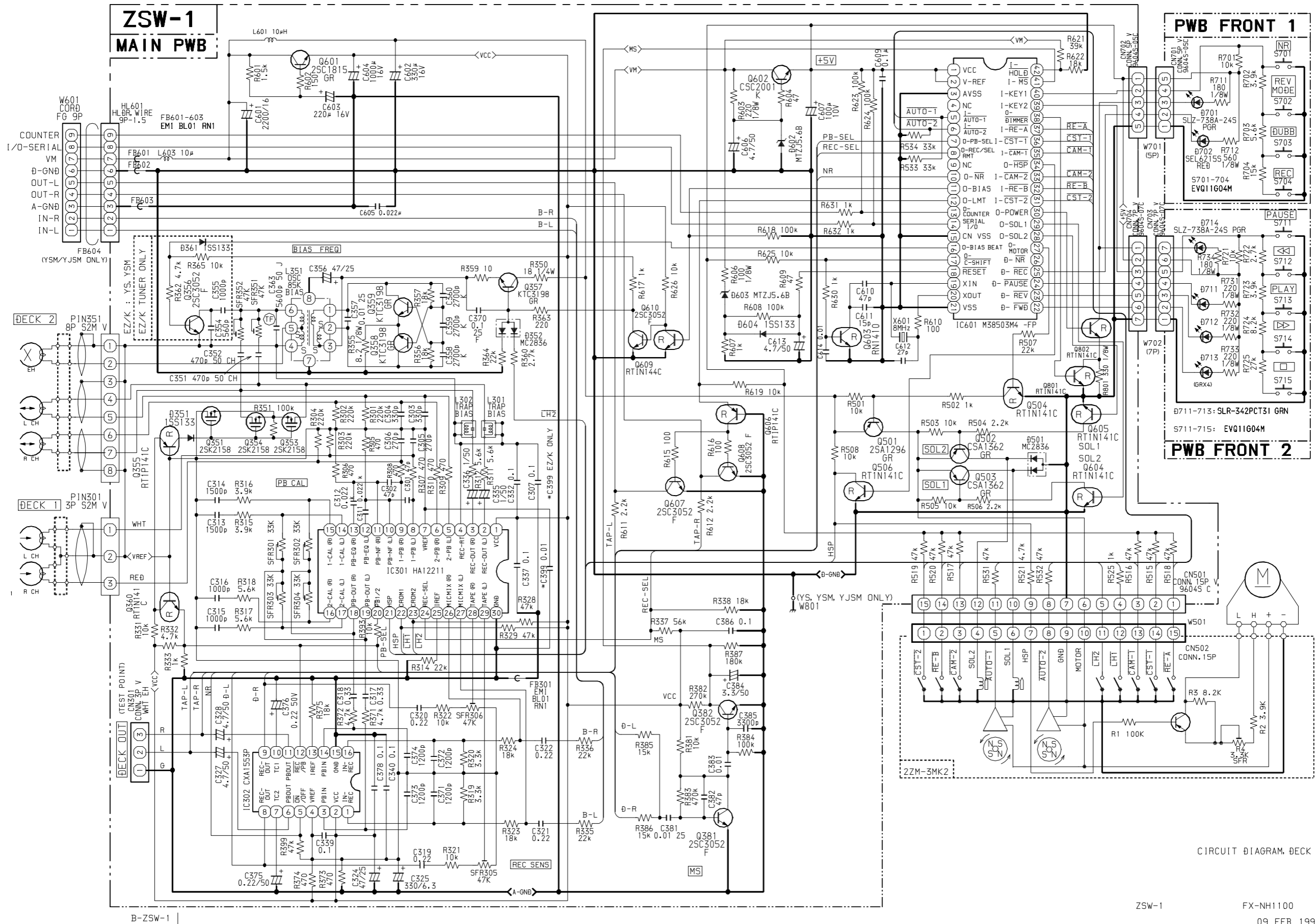

CIRCUIT DIAGRAM, DECK

MECHANICAL PARTS LIST - 1/1 (FX-SNH1100)

NOTE: The characters in the suffix column indicate the part usage.

REF.NO	PARTS NO.	KANRI NO.	DESCRIPTION	SUFFIX
YJSM		XX		A
YSM		XX		B
87-B00-002-010			BADGE,AIWA 30 ABS SIL	AB
8Z-SW1-001-010			CABI,FR	AB
8Z-SW1-002-010			BOX,CASS 1	AB
8Z-SW1-003-010			BOX,CASS 2	AB
8Z-SW1-015-010			CABI,STEEL	AB
8Z-SW1-016-010			PANEL,SIDE L	AB
8Z-SW1-017-010			PANEL,SIDE R	AB
8Z-SW1-018-010			CABI,REAR YLSM	
8Z-SW1-020-010			CABI,REAR YJSM	A
8Z-SW1-022-010			CABI,REAR YSM	.B
8Z-SW1-024-010			CABI,STEEL	
8Z-SW1-011-010			KEY,ASSY REC	AB
8Z-SW1-012-010			KEY,ASSY OPE	AB
81-532-080-010			LABEL, CASS. COMPT	AB
8Z-SW1-004-010			WINDOW,CASS 1	AB
8Z-SW1-005-010			WINDOW,CASS 2	AB
8Z-SW1-013-010			REFLECTOR,CASS 1	AB
86-NF5-618-110			CONN ASSY,8P RPB	AB
82-NF5-218-010			SPR-T,EJECT 1 (SIN)	AB
82-NF5-219-010			SPR-T,EJECT 2 (SIN)	AB
82-NF5-229-010			PLATE,LOCK	AB
86-NF9-224-010			SPR-C,LOCK	AB
87-NF4-216-010			HLDR,LOCK 1	AB
87-NF4-217-110			HLDR,LOCK 2	AB
87-NF8-220-010			DMPR,150	AB
8Z-SW1-201-010			COVER, REFLECTOR 1	AB
8Z-SW1-202-010			COVER, REFLECTOR 2	AB
87-067-579-010			TAPPING SCREW, BVT2+3-8	AB
87-067-633-010			TAPPING SCREW, BVT2+3-8	
87-067-703-010			TAPPING SCREW, BVT2+3-10	AB
87-B10-091-010			UTT2+3-10 W/O BLK	AB
W 501	88-915-161-110		FF-CABLE, 15P 1.25	AB
W 701	88-905-331-110		FF-CABLE, 5P 1.25 330MM	AB
W 702	88-907-301-110		FF-CABLE, 7P 1.25	AB
W 601	88-SW1-607-010		CORD,FG9P	AB

ELECTRICAL MAIN PARTS LIST - 1/1 (GE-SNAVH1200)

NOTE: The characters in the suffix column indicate the part usage.

REF.NO	PARTS NO.	DESCRIPTION	SUFFIX
YSM	XX.....	A.....
		KANRI	
		NO.	
C	304	87-010-182-080	C-CAP,S 2200P-50 B
C	302	87-010-196-080	CHIP CAPACITOR,0.1-25
C	301	87-010-196-080	CHIP CAPACITOR,0.1-25
C	303	87-010-197-080	CAP, CHIP 0.01 DM
L	301	87-003-097-080	COIL,10UH
S	306	87-A90-095-080	SW,TACT EVQ11G04M
S	301	87-A90-095-080	SW,TACT EVQ11G04M
S	307	87-A90-095-080	SW,TACT EVQ11G04M
S	303	87-A90-095-080	SW,TACT EVQ11G04M
S	308	87-A90-095-080	SW,TACT EVQ11G04M
S	305	87-A90-095-080	SW,TACT EVQ11G04M
S	304	87-A90-095-080	SW,TACT EVQ11G04M
S	302	87-A90-095-080	SW,TACT EVQ11G04M
S	309	87-A90-095-080	SW,TACT EVQ11G04M
S	315	87-A90-095-080	SW,TACT EVQ11G04M
S	310	87-A90-095-080	SW,TACT EVQ11G04M
S	311	87-A90-095-080	SW,TACT EVQ11G04M
S	313	87-A90-095-080	SW,TACT EVQ11G04M
S	314	87-A90-095-080	SW,TACT EVQ11G04M
S	312	87-A90-095-080	SW,TACT EVQ11G04M
S	316	87-A91-076-010	SW,RTRY RE0121PVB25FINA1
C	108	87-010-196-080	CHIP CAPACITOR,0.1-25
C	109	87-010-196-080	CHIP CAPACITOR,0.1-25
C	105	87-010-312-080	C-CAP,S 15P-50 CH
C	107	87-010-316-080	C-CAP,S 33P-50 CH
C	106	87-010-320-080	CHIP CAP 68P
C	103	87-010-497-040	CAP,E 4.7-35 GAS
C	101	87-010-550-040	CAP,E 100-6.3 GAS
C	111	87-010-552-040	CAP,E 22-16 GAS
C	110	87-012-368-080	C-CAP,S 0.1-50 F
D	102	87-017-931-080	ZENER,MTZJ5.6B
D	103	87-020-465-080	DIODE,1SS133 (110MA)
D	101	87-070-136-080	ZENER,MTZJ5.1B
FB	101	87-008-372-080	FILTER,EMI BL OIRNI
IC	101	8Z-SU1-603-010	IC,LC866448W-XXXX
L	103	87-005-130-080	COIL,10UH
L	102	87-005-130-080	COIL,10UH
L	101	87-005-152-080	COIL,10UH
L	104	87-005-152-080	COIL,10UH
Q	101	87-026-263-080	C-TR,RN1410
W	101	8Z-SU1-608-010	CORD,52305-101BLK
WH	101	87-A90-882-010	HLDR,WIRE 10P 1.5 51016
X	101	87-A70-070-080	VIB,CER 5.76MHZ CRHF
		88-SU1-201-110	GUIDE,FL
C	203	87-010-404-040	CAP,E 4.7-50 SME
C	205	87-010-405-040	CAP,E 10-50
C	206	87-010-405-040	CAP,E 10-50
C	204	87-010-405-040	CAP,E 10-50
C	201	87-012-140-080	CAP 470P
C	202	87-012-369-080	C-CAP,S 0.047-50F
FL	201	8Z-SU1-605-010	FL,BJ699GK
LED	209	87-A40-317-080	LED,SLR-342VCT31 RED
LED	206	87-A40-380-080	LED,SEL6510C-TP5 GRN
LED	207	87-A40-380-080	LED,SEL6510C-TP5 GRN
LED	203	87-A40-380-080	LED,SEL6510C-TP5 GRN
LED	208	87-A40-380-080	LED,SEL6510C-TP5 GRN
LED	205	87-A40-380-080	LED,SEL6510C-TP5 GRN
LED	204	87-A40-380-080	LED,SEL6510C-TP5 GRN
LED	202	87-A40-380-080	LED,SEL6510C-TP5 GRN
LED	201	87-A40-380-080	LED,SEL6510C-TP5 GRN
LED	215	87-A40-317-080	LED,SLR-342VCT31 RED
LED	210	87-A40-317-080	LED,SLR-342VCT31 RED
LED	216	87-A40-317-080	LED,SLR-342VCT31 RED
LED	212	87-A40-317-080	LED,SLR-342VCT31 RED
LED	214	87-A40-317-080	LED,SLR-342VCT31 RED
LED	211	87-A40-317-080	LED,SLR-342VCT31 RED
LED	213	87-A40-317-080	LED,SLR-342VCT31 RED
C	406	87-010-196-080	CHIP CAPACITOR,0.1-25
C	401	87-010-196-080	CHIP CAPACITOR,0.1-25
C	402	87-010-196-080	CHIP CAPACITOR,0.1-25
C	403	87-010-196-080	CHIP CAPACITOR,0.1-25
C	404	87-010-196-080	CHIP CAPACITOR,0.1-25
C	407	87-012-158-080	C-CAP,S 390P-50 CH
C	405	87-012-358-080	C-CAP,S 0.47-10 F Z
IC	401	87-A21-023-040	C-IC,BA3835F

SCHEMATIC DIAGRAM - 8 (GE-SNAVH1200 : FRONT)

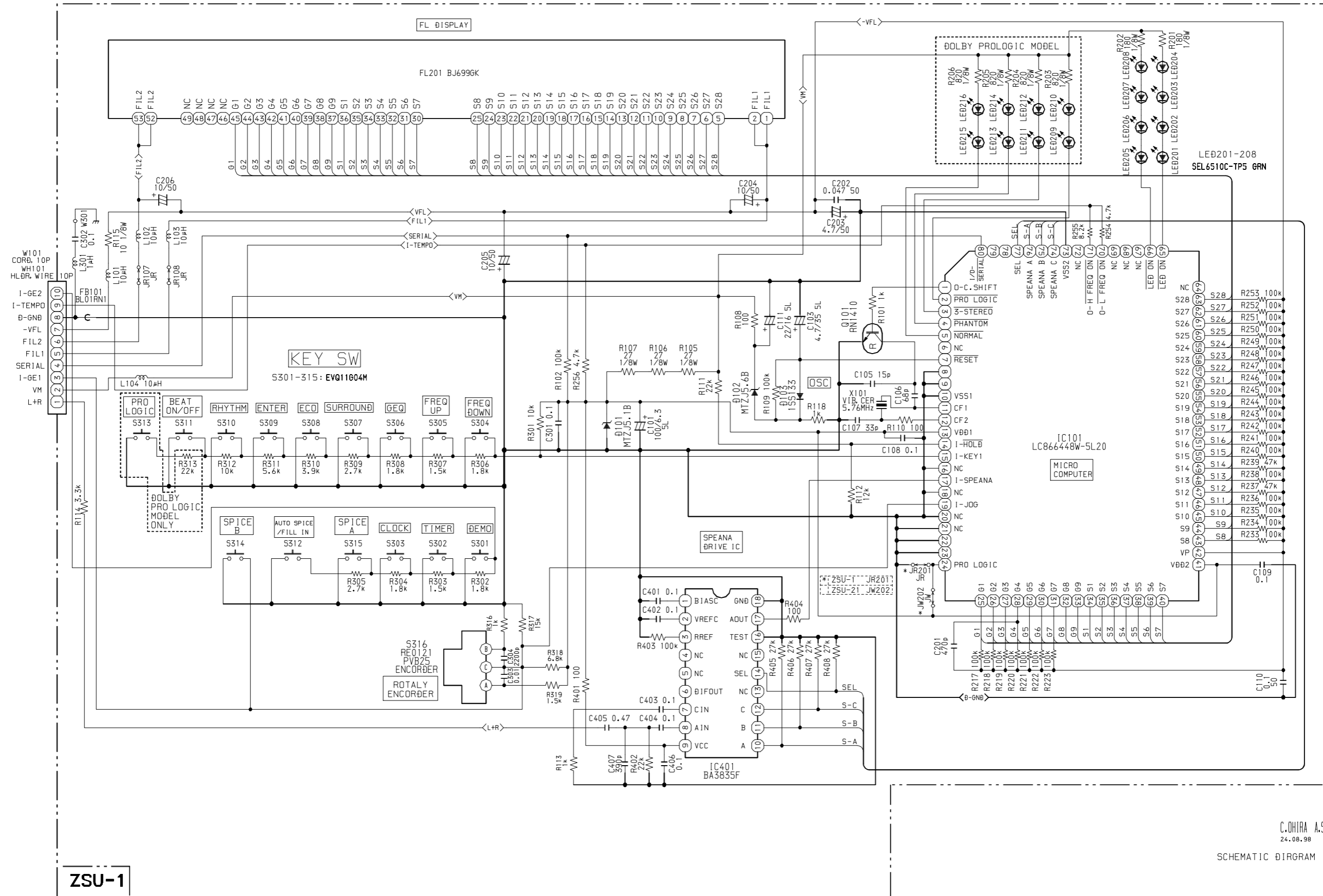

ZSU-1

B-ZSU-1-FR

C. OHIRA A. SAWAMOTO
24.08.98 .08.98
SCHEMATIC DIAGRAM (GEQ)

ZSU-1/M

GE-NH1000
10 FEB 1999

MECHANICAL PARTS LIST - 1/1 (GE-SNAVH1200)

NOTE: The characters in the suffix column indicate the part usage.

REF.NO	PARTS NO.	NO.	DESCRIPTION	SUFFIX
YSM		XX		A
		KANRI		
	87-B00-002-010		BADGE,AIWA 30 ABS SIL	A
	8Z-SU1-002-010		CABI,STEEL	A
	8Z-SUM-001-010		CABI,FR PRO	A
	8Z-SUM-003-010		CABI,REAR YJSNM	A
	8Z-SX1-011-010		PANEL,SIDE L	A
	8Z-SX1-012-010		PANEL,SIDE R	A
	8Z-SU1-005-010		REFLECTOR,JOG	A
	8Z-SU1-006-010		RING,JOG	A
	8Z-SU1-007-010		KNOB,RTRY JOG	A
	8Z-SU1-008-010		KEY,GEQ	A
	8Z-SU1-010-010		KEY,ENTER	A
	8Z-SUM-004-010		KEY,PRO	A
	8Z-SU1-004-010		WINDOW,DISPLAY	A
	87-067-633-010		TAPPING SCREW, BVT2+3-8	A
	87-067-703-010		TAPPING SCREW, BVT2+3-10	A
W 101	8Z-SU1-608-010		CORD,52305-101BLK	A
WH 101	87-A90-882-010		HLDR,WIRE 10P 1.5 51016	A
	88-SU1-201-110		GUIDE,FL	A

ACCESSORIES / PACKAGE LIST - 1/1

NOTE: The characters in the suffix column indicate the part usage.

REF.NO	PARTS NO.	NO.	DESCRIPTION	SUFFIX
HSM		XX		A
		KANRI		
	8Z-SPM-901-010		IB,H(ECA)M	A
	87-043-095-010		WIRE ANTENNA	A
	87-043-115-010		ANT,FEEDER FM	A
	87-A91-017-010		PLUG,CONVERSION JT-0476	A
	8Z-NFV-702-010		RC UNIT,RC-ZAS05	A
ANT 0	87-006-269-010		AM LOOP ANT (UN)	A

サービス技術ニュース	
番号	連絡内容
G- -	
G- -	
G- -	

アイワ株式会社
AIWA CO.,LTD.

9820543

Tokyo Japan