

AKAI SERVICE MANUAL



STEREO RECEIVER

MODEL **AA-A1 / L**



STEREO RECEIVER
MODEL AA-A1/L

SECTION 1	SERVICE MANUAL	3
SECTION 2	PARTS LIST	13

SAFETY INSTRUCTIONS

SAFETY CHECK AFTER SERVICING

Confirm the specified insulation resistance between power cord plug prongs and externally exposed parts of the set is greater than 10 Mohms, but for equipment with external antenna terminals (tuner, receiver, etc.) and is intended for **C** or **A**, specified insulation resistance should be more than 2.2 Mohms (ground terminals, microphone jacks, headphone jacks, line-in-out jacks etc.)

PRECAUTIONS DURING SERVICING

1. Parts identified by the \triangle symbol parts are critical for safety.
Replace only with parts number specified.
2. In addition to safety, other parts and assemblies are specified for conformance with such regulations as those applying to spurious radiation. These must also be replaced only with specified replacements.
Examples: RF converters, tuner units, antenna selector switches, RF cables, noise blocking capacitors, noise blocking filters, etc.
3. Use specified internal wiring. Note especially:
 - 1) Wires covered with PVC tubing
 - 2) Double insulated wires
 - 3) High voltage leads
4. Use specified insulating materials for hazardous live parts. Note especially:
 - 1) Insulation Tape
 - 2) PVC tubing
 - 3) Spacers (Insulating Barriers)
 - 4) Insulation sheets for transistors
 - 5) Plastic screws for fixing microswitch (especially in turntable)
5. When replacing AC primary side components (transformers, power cords, noise blocking capacitors, etc.), wrap ends of wires securely about the terminals before soldering.

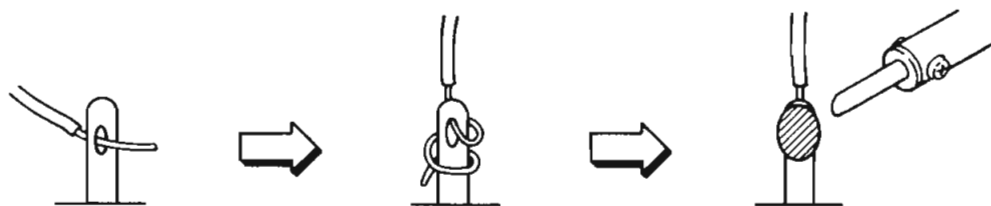

6. Observe that wires do not contact heat producing parts (heatsinks, oxide metal film resistors, fusible resistors, etc.).
7. Check that replaced wires do not contact sharp edged or pointed parts.
8. Also check areas surrounding repaired locations.
9. Use care that foreign objects (screws, solder droplets, etc.) do not remain inside the set.

VOLTAGE CONVERSION

Models for some countries are not equipped with this facility, Each machine is preset at the factory according to its destination, but some machine can be set to 110V, 120V, 220V, or 240V as required.

If the machine's voltage can be converted:

1. Disconnect the power cord.
2. Set the VOLTAGE SELECTOR located on the rear panel, with a screwdriver. Until the correct voltage is indicated.

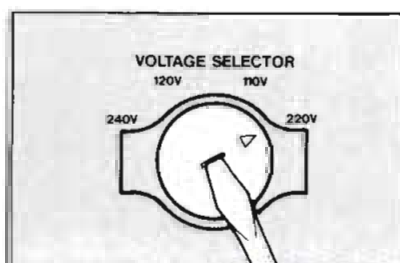

SECTION 1

SERVICE MANUAL

TABLE OF CONTENTS

I.	SPECIFICATIONS	4
II.	DISMANTLING OF UNIT	5
III.	CONTROLS	6
IV.	PRINCIPAL PARTS LOCATION	7
V.	TUNING CORD THREADING	7
VI.	ELECTRICAL ADJUSTMENT	8
	1. ELECTRICAL ADJUSTMENT POINTS	8
	2. CONNECTION OF INSTRUMENTS	8
	3. LW (Model for AA-A1L only) SECTION ADJUSTMENTS (Refer to Figs. 6-1 and 6-3)	9
	4. AM (MW for model AA-A1L) SECTION ADJUSTMENT (Refer to Figs. 6-1 and 6-3)	9
	5. FM SECTION ADJUSTMENTS (Refer to Figs. 6-2 and 6-3)	10
VII.	PC BOARD TITLE AND IDENTIFICATION NUMBERS	11

For basic adjustments, measuring methods, and operating principles, refer to GENERAL TECHNICAL MANUAL.

I. SPECIFICATIONS

FM TUNER SECTION

TUNING FREQUENCY RANGE	87.5MHz to 108.0MHz
USABLE SENSITIVITY (IHF)	12.7dBf (30dB)
QUIETING SENSITIVITY (IHF) (S/N = 50dB)	19.2dBf (Mono) /40.2dBf (Stereo)
CAPTURE RATIO	2.0dB
SELECTIVITY (IHF)	60dB
IMAGE REJECTION	50dB
IF REJECTION	80dB
SPURIOUS REJECTION	80dB
AM SUPPRESSION	50dB
SUB CARRIER SUPPRESSION	55dB
S/N (IHF)	70dB (Mono) /62dB (Stereo)
HARMONIC DISTORTION	0.2% (Mono) /0.4% (Stereo)
STEREO SEPARATION	42dB (1kHz)
FREQUENCY RESPONSE	30Hz to 15kHz \pm 1.0dB

AM TUNER SECTION

AM (MW for AA–A1L) LW (AA–A1L ONLY)

TUNING FREQUENCY RANGE	531kHz to 1,602kHz	160kHz to 340kHz
USABLE SENSITIVITY (IHF)	300 μ V/m (Loop antenna)	800 μ V/m (Loop antenna)
SELECTIVITY (IHF)	30dB	40dB
IMAGE REJECTION	45dB	45dB
IF REJECTION	35dB	35dB
S/N	40dB	35dB
T.H.D.	1.0%	2.5%

AMPLIFIER SECTION

		8 ohms	4 ohms
RATED OUTPUT POWER (2 channels driven)	40Hz to 20kHz	25W x 2/0.3%	25W x 2/0.3%
POWER OUTPUT (by FTC)	40Hz to 20kHz	35W/0.3%	
	1kHz	35W/0.3%	
MUSIC POWER (Both channels)	100W		
POWER BANDWIDTH (IHF)	10Hz to 30kHz/8 ohms (T.H.D. 0.3%)		
S/N	PHONO	70dB	
	AUX/TAPE	90dB	
RESIDUAL NOISE	0.5mV (8 ohms)		
CHANNEL SEPARATION (IHF)	55dB (1kHz)		
DAMPING FACTOR	30 (1kHz, 8 ohms)		
INPUT SENSITIVITY/IMPEDANCE	PHONO(MM)	2mV/47 kohms	
	AUX/TAPE	150mV/47 kohms	
OUTPUT LEVEL/IMPEDANCE	TAPE REC	150mV/1 kohms	
FREQUENCY RESPONSE	PHONO (RIAA Deviation)	\pm 0.5dB	
	AUX/TAPE	5Hz to 80kHz, $-$ 3dB	
TONE CONTROL	BASS	\pm 8dB	
	TREBLE	\pm 8dB	
PHONO MAX. INPUT LEVEL	(MM)	120mV (1kHz)	
SPEAKERS	A or B	4 to 16 ohms	
	A + B	8 to 16 ohms	
FOR USA ONLY	A or B	8 to 16 ohms	
	A + B	8 to 16 ohms	
POWER REQUIREMENTS	120V, 60Hz for USA & Canada 220V, 50Hz for Europe except UK 240V, 50Hz for UK & Australia 110V/120V/220V/240V, 50Hz/60Hz convertible for other countries		
DIMENSIONS	440(W) x 78(H) x 263(D)mm (17.3 x 3.1 x 10.3 inches)		
WEIGHT	4.8kg (10.6 lbs)		

* For improvement purposes, specifications and design are subject to change without notice.

II. DISMANTLING OF UNIT

In case of trouble, etc. necessitating dismantling, please dismantle in the order shown in the photographs. Reassemble in reverse order.

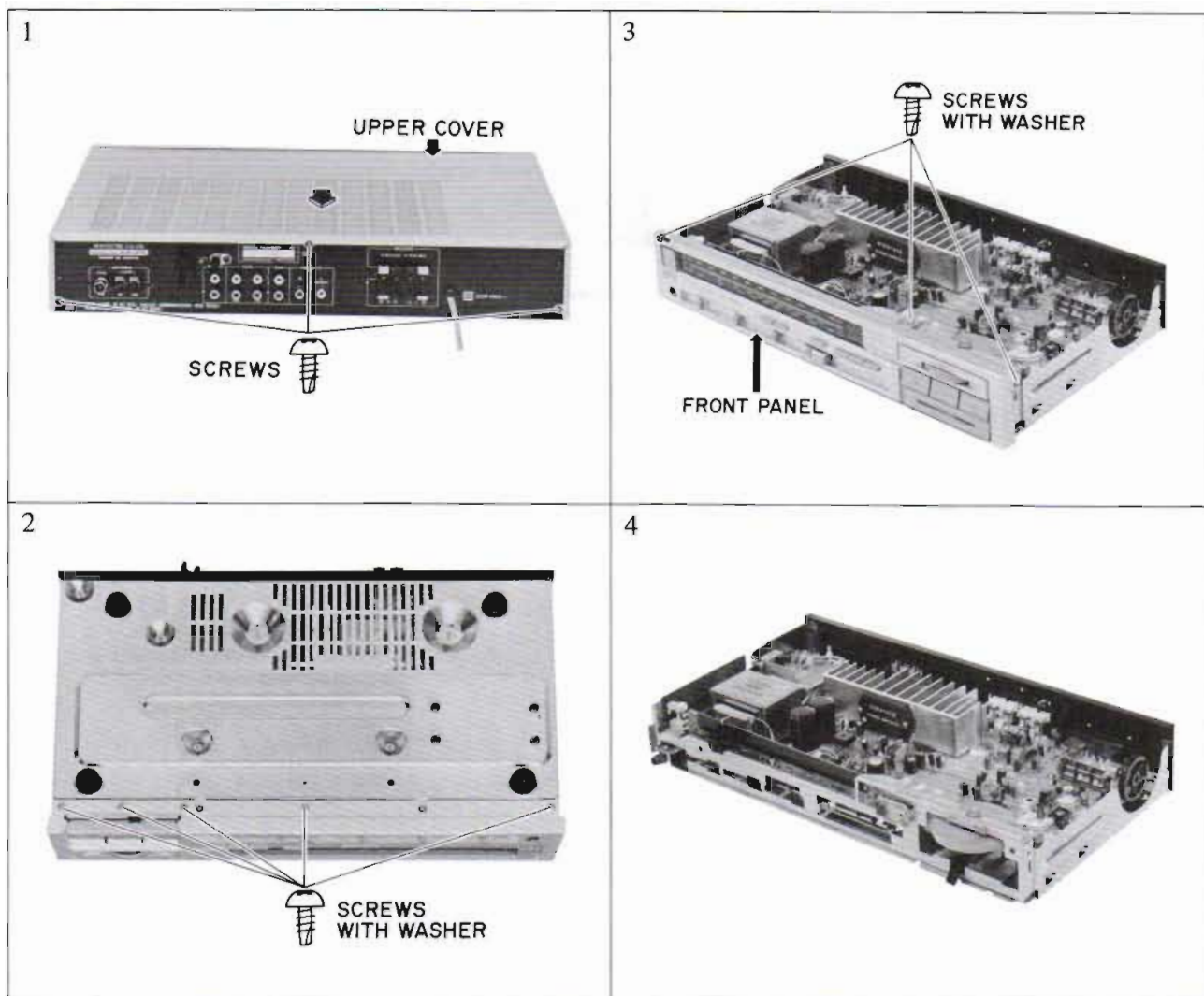

III. CONTROLS

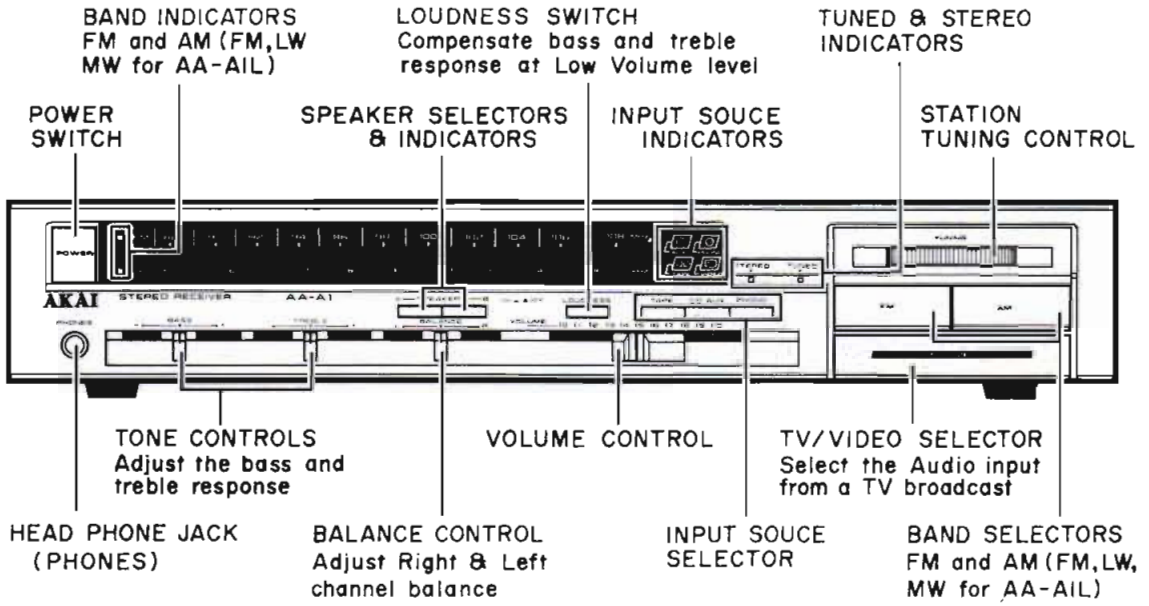

Fig. 3-1 Front View

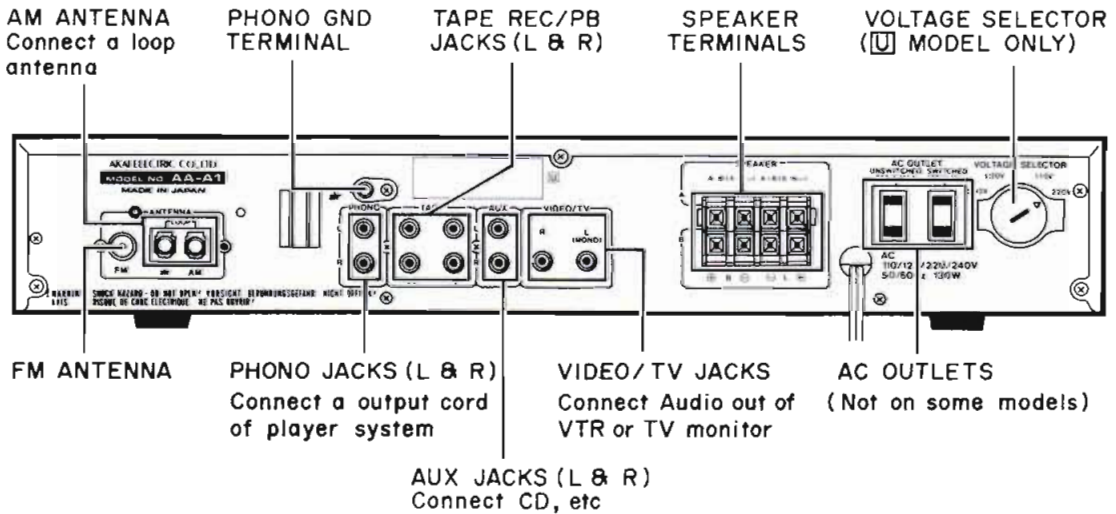

Fig. 3-2 Rear View

VI. ELECTRICAL ADJUSTMENT

6-1. ELECTRICAL ADJUSTMENT POINTS

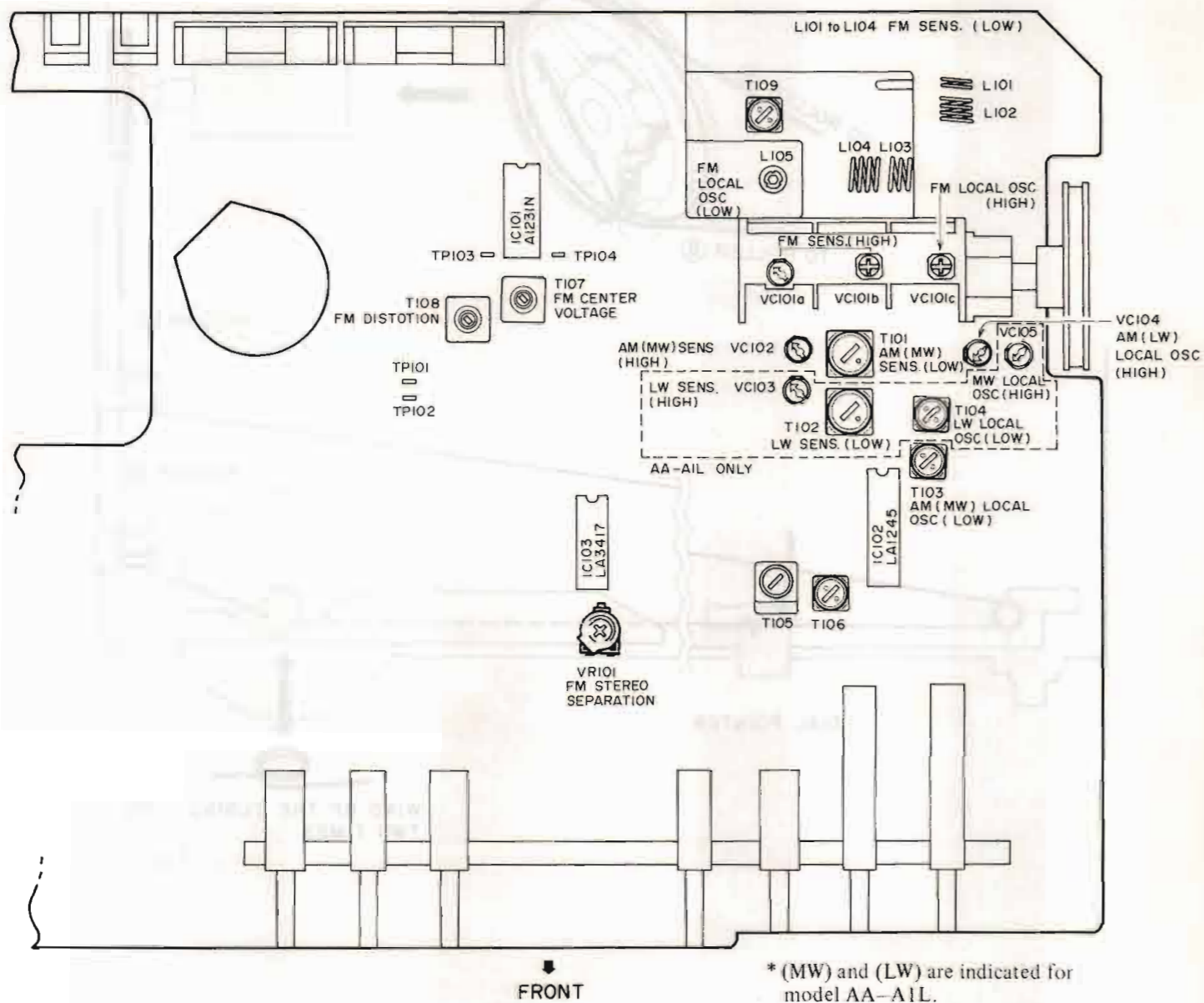

Fig. 6-1 Tuner PCB Adjustment Points

*(MW) and (LW) are indicated for model AA-A1L.

6-2. CONNECTION OF INSTRUMENTS

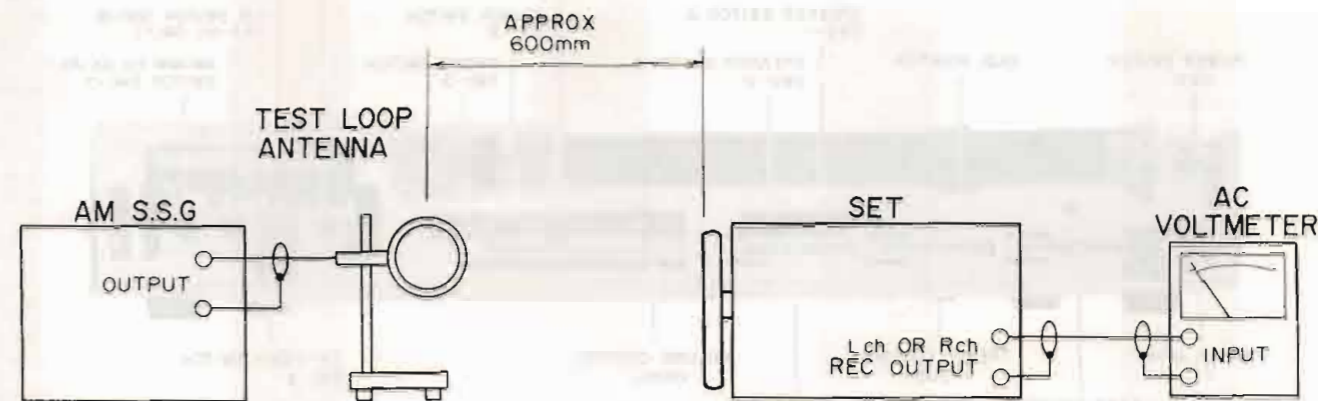

Fig. 6-2 Instruments connection for AM (MW & LW for AA-A1L) Section Adjustment

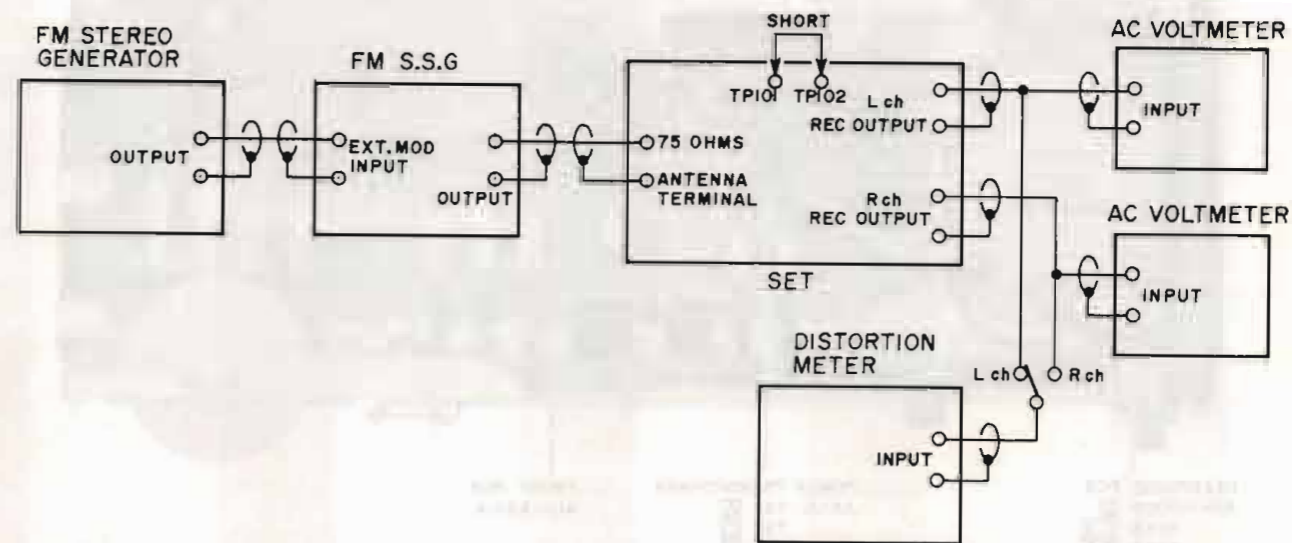
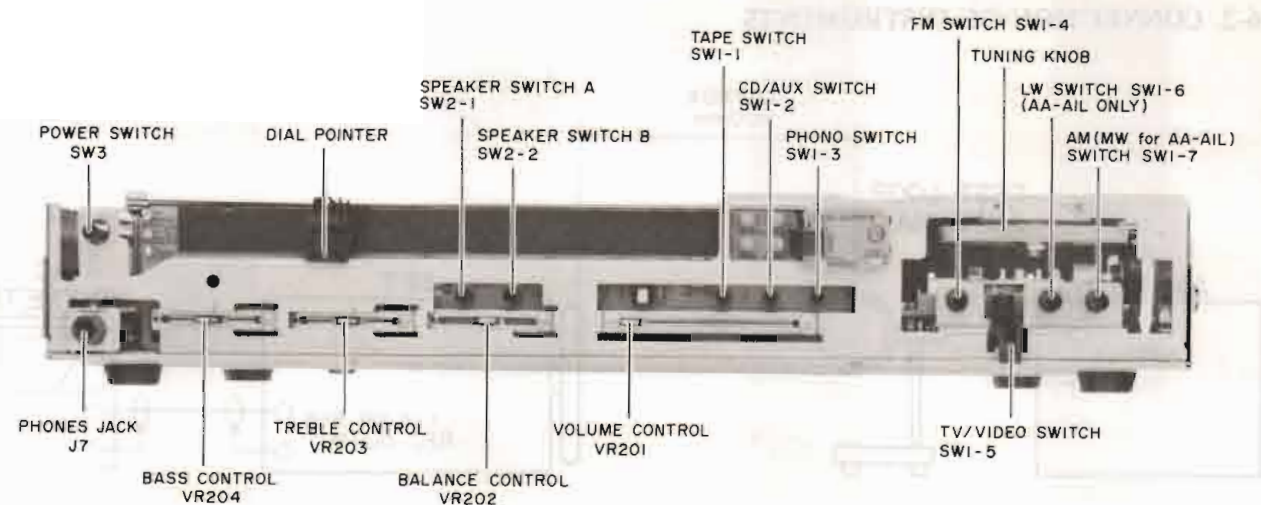

Fig. 6-3 Instruments connection for FM Section Adjustment

IV. PRINCIPAL PARTS LOCATION



* photo used a model AA-A1L

Fig. 4-1 Front View

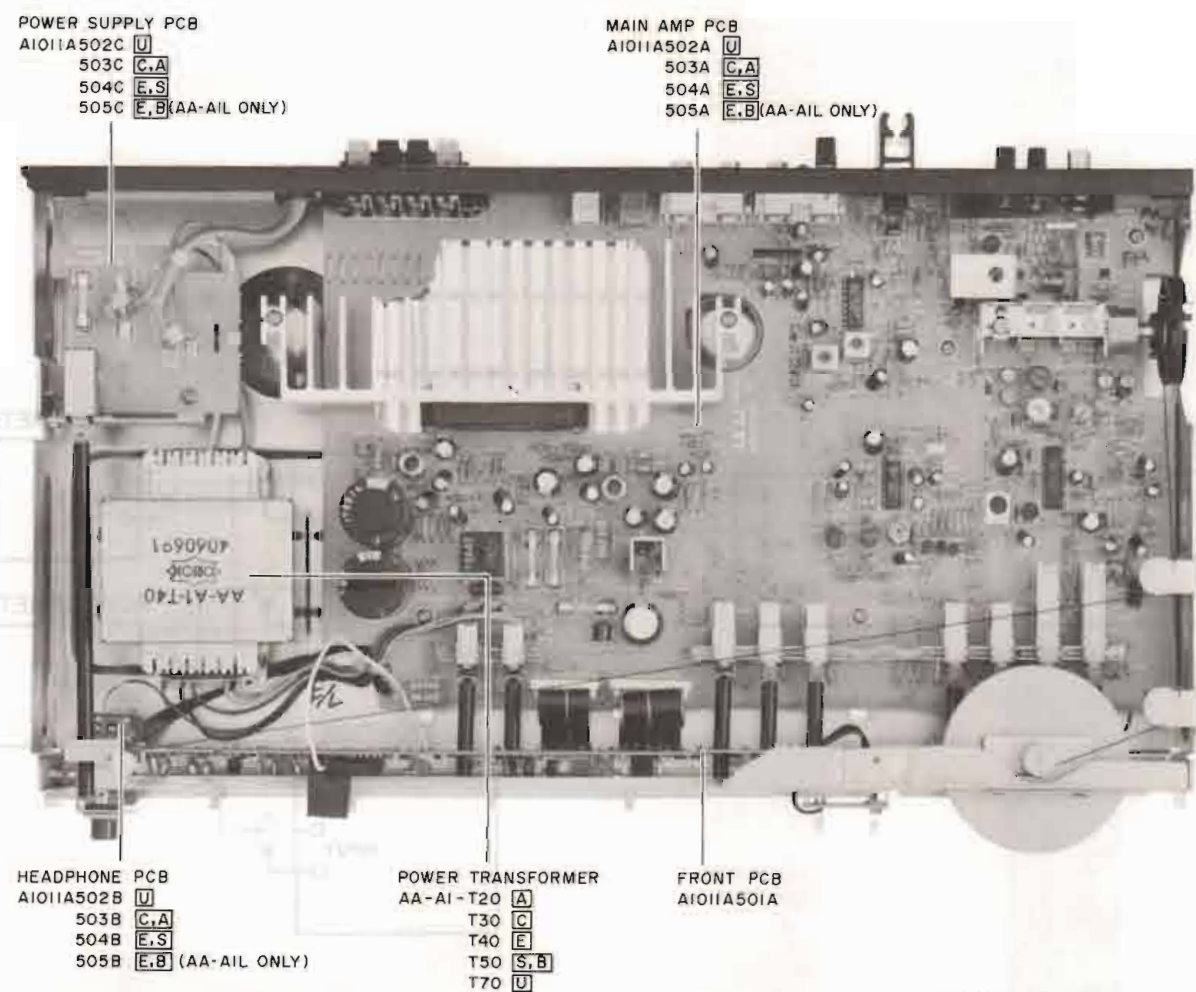

* photo used a model AA-A1L

Fig. 4-1 Top View

V. TUNING CORD THREADING

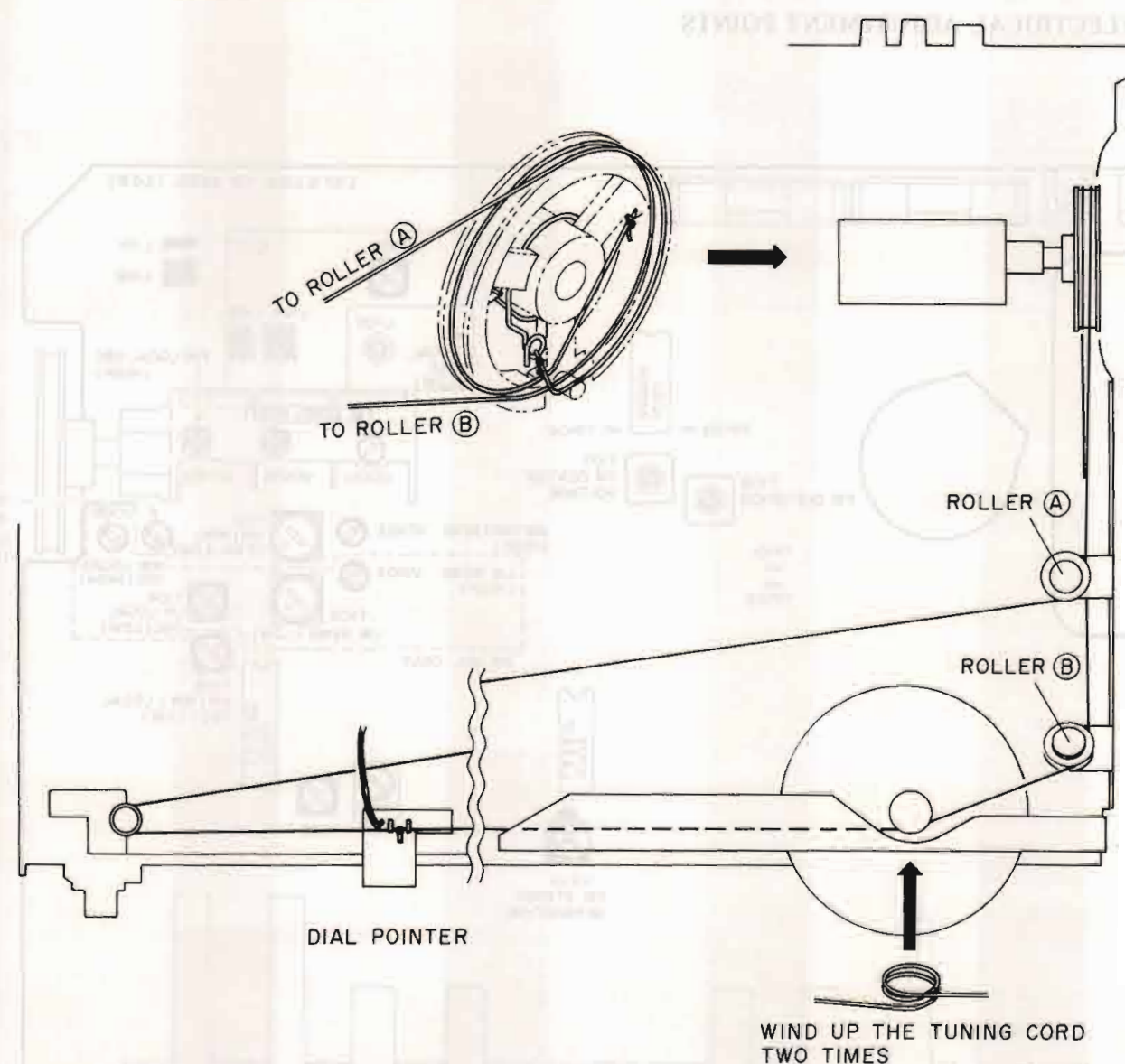

Fig. 5-1

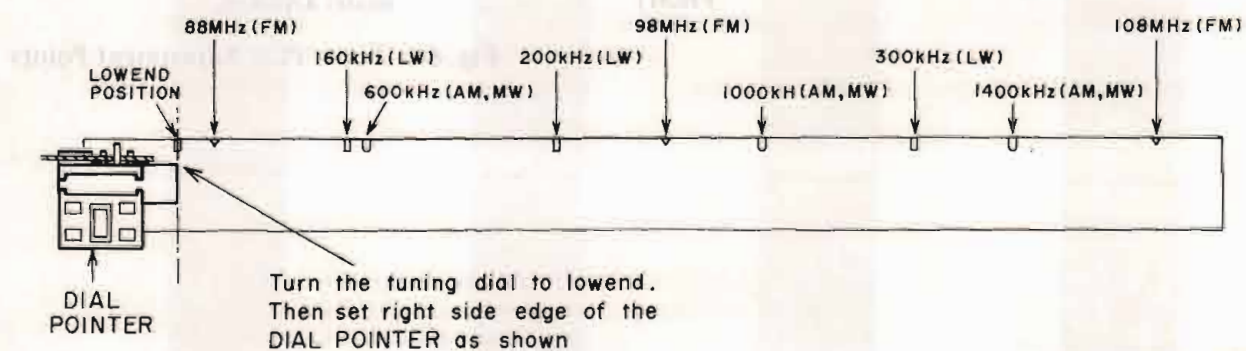

Fig. 5-2

6-3. LW (Model for AA-A1L only) SECTION ADJUSTMENTS (Refer to Figs. 6-1 and 6-3)

NOTE:

1. The internal modulation of S,S,G (Standard Signal Generator) is set to 30% (1kHz) and High Range is within 6dBμ, otherwise Readjust Low and High Range sensitivity.
2. Confirm that the sensitivity margin between Low

Step	Adjustment Item	S.S.G.		SET		Adjustment Part	Result and Remarks
		Frequency	Output	Band SW	Dial Pointer		
1	Local OSC (Low)	140kHz	65dBμ	LW	Low end	T104	• Maximum output level and minimum Distortion.
	Local OSC (High)	360kHz			High end	VC104	• For best Result, Repeat alternatry two or three times.
2	Low Range Sensitivity	160kHz	Less than 65dBμ		Tune in 160kHz	T102	• Within 3% distortion • For best Result, Repeat alternatry two or three times.
	High Range Sensitivity	160kHz			Tune in 300kHz	VC103	
3	Output Level	200kHz	74dBμ	Tune in 200kHz	Confirmation	-11.5±3dBm	
4	Distortion Factor	200kHz	74dBμ	Tune in 200kHz	Confirmation	Less than 3%	

6-4. AM (MW for Model AA-A1L) SECTION ADJUSTMENT (Refer to Figs. 6-1 and 6-3)

NOTE:

1. The internal modulation of S.S.G (Standard Signal Generator) is set to 30% (1kHz).
2. When adjust only MW Section of AA-A1L, adjust the LW Local OSC step 1 and 2) fast then adjust these adjustments.
3. Confirm the sensitivity margin between Low and high Range is within 6dBμ, otherwise Readjust Low and high Range sensitivity.

Step	Adjustment Item	S.S.G.		SET		Adjustment Part	Result and Remarks
		Frequency	Output	Band SW	Dial Pointer		
1	Local OSC (Low)	520kHz	60dBμ	AM or (MW for AA-A1L)	Low end	T103	• Maximum output level and minimum distortion.
	Local OSC (High)	1650kHz			High end	VC104 (for AA-A1) VC105 (for AA-A1L)	• For best Result, Repeat alternatly two or three times.
2	IF	1000kHz	60dBμ		1000kHz	T105 T106	• Maximum output level and minimum distortion.
3	Low Range Sensitivity	600kHz	Less than 60dBμ		Tune in 600kHz	T101	• Maximum output level and minimum distortion.
	High Range Sensitivity	1400kHz			Tune in 1400kHz	VC102	• For best Result, Repeat alternatly two or three times.
4	Output Level	1000kHz	74dBμ	Tune in 1000kHz	Confirmation	-11.5 ±3dBm	
5	Distortion Factor			Confirmation	• Less than 2%		

6-5. FM SECTION ADJUSTMENTS (Refer to Figs. 6-2 and 6-3)

NOTE:

1. The internal modulation of S.S.G. (Standard Signal Generator) is set to 100% 75kHz deviation (1kHz) for [U], [C], [A], [S] models, and set to 100% 45kHz deviation (1kHz) for [E], [B] models.
2. Short between TP101 and TP102, (Release the MUTE)

Step	Adjustment Item	S.S.G.		SET		Adjustment Part	Result and Remarks
		Frequency	Output	Band SW	Dial Pointer		
1	Local OSC (Low)	87.4MHz (MONO)	60dBμ	FM	Low end	L105	<ul style="list-style-type: none"> • Maximum output level and minimum distortion. • For best Result, Repeat alternatly two or three times.
	Local OSC (High)	108.2MHz (MONO)			High end	VC101C	
2	Low Range Sensitivity	88.0MHz (MONO)	Less than 6dBμ		Tune in 88.0MHz	L101 to L104	<ul style="list-style-type: none"> • Less than 3% distortion. • For best Result, Repeat alternatly two or three times.
	High Range Sensitivity	108.0MHz (MONO)			Tune in 108.0MHz	VC101a VC101b	
3	Center Voltage	—	—		Tune only noise	T107	<ul style="list-style-type: none"> • Tune only noise without interference from broadcasting. • Connect a DC Voltmeter between TP103 and TP104. • Set to DC 0±0.025V
4	Distortion Factor (MONO)	98.0MHz (MONO)	60dBμ		Tune in 98.0MHz	T108	<ul style="list-style-type: none"> • Less than 0.3% Distortion. • For best Result, Repeat alternatly with Setp 3 two or three times.
5	Stereo Separation	98.0MHz (Stereo) Output Left CH. only	60dBμ		Tune in 98.0MHz	VR101	<ul style="list-style-type: none"> • Right CH. output level is less than -35dB from left CH. output level. • Confirm R CH. → L CH.
6	Mute Sensitivity	98.0MHz (MONO)	22±12dBμ	Tune in 98.0MHz	Confirmation	<ul style="list-style-type: none"> • Remove a short wire, between TP101 and TP102. • Mute should be operate within 22±12 dBμ output of S.S.G. 	
7	Output Level	98.0MHz (MONO)	60dBμ	Tune in 98.0MHz		<ul style="list-style-type: none"> • Connect a AC millivoltmeter to REC out terminal. • 0±3dBm for [U], [C], [A], [S] models • -3±3dBm for [E], [B] models 	

VII. PC BOARD TITLE AND IDENTIFICATION NUMBERS

PC BOARD TITLE		PC BOARD NUMBER	REMARKS
FRONT	PC BOARD	A1011A501A	
LED (1)	PC BOARD	A1011A501B	
LED (2)	PC BOARD	A1011A501C	
MAIN AMP	PC BOARD	A1011A502A	AA-A1 <input type="checkbox"/> U
	PC BOARD	503A	AA-A1 <input type="checkbox"/> C, A
	PC BOARD	504A	AA-A1 <input type="checkbox"/> E, S
	PD BOARD	505A	AA-A1L <input type="checkbox"/> E, B
HEAD PHONE	PC BOARD	A1011A502B	AA-A1 <input type="checkbox"/> U
	PC BOARD	503B	AA-A1 <input type="checkbox"/> C, A
	PC BOARD	504B	AA-A1 <input type="checkbox"/> E, S
	PC BOARD	505B	AA-A1L <input type="checkbox"/> E, B
POWER SUPPLY	PC BOARD	A1011A502C	
	PC BOARD	503C	
	PC BOARD	504C	
	PC BOARD	505C	

SECTION 2

PARTS LIST

TABLE OF CONTENTS

RECOMMENDED SPARE PARTS LIST	15
1. PC BOARD BLOCK	16
2. MAIN AMP PC BOARD	16
3. FRONT PC BOARD	17
4. LED (1) PC BOARD	17
5. LED (2) PC BOARD	17
6. HEAD PHONE PC BOARD	17
7. POWER SUPPLY PC BOARD	17
8. ASSEMBLY BLOCK	18
9. FINAL ASSEMBLY BLOCK	19
INDEX	20

Resistor and Capacitor which is not listed in this parts list, please refer to COMMON LIST FOR SERVICE PARTS.

ATTENTION

1. When placing an order for parts, be sure to list the parts no., model no., and description of each part. If any of this information is omitted, there are instances in which parts cannot be shipped or the wrong parts will be delivered.
2. Please be careful not to make a mistake in the parts no. If the parts no. is in error, a part different from the one ordered may be delivered.
3. Because part numbers and part definitions and supply in the Preliminary Parts List may have been the subject of changes, please use this parts list for all future reference.

HOW TO USE THIS PARTS LIST

1. This Parts List shows those parts which are considered necessary for repairs. Other parts, such as resistors and capacitors, are shown in the "Common List for Service Parts" from which these parts should be selected and parts.
2. The Recommended Spare Parts List shows those parts in the Parts List which are considered particularly important for service.
3. Parts not shown in the Parts List and "Common List for Service Parts" will not in principle be supplied.

4. How to read the parts list

a) Mechanism Block

b) P.C Board Block

2. HEAD BASE BLOCK

REF. NO.	PART NO.	DESCRIPTION
2-1x	BH-T2023A320A	HEAD BASE BLOCK GX-F66R
2-2	HP-H2206A010A	HEAD R/P PR4-8FU C
2-3	ZS-477876	PAN20x03STL CMT
2-4	ZS-536488	BID20x08STL CMT
2-5	ZG-402895	CS ANGLE ADJUST SPRING

SP (Service Parts) Classification

A small "x" indicates the inability to show that particular part in the Photo or Illustration.

This number corresponds with the individual parts index number in that figure

This number corresponds with the Figure Number

6. SYS. CON. P C BOARD BLOCK

REF. NO.	PART NO.	DESCRIPTION
6-1	BA-T2034A070A	PC SYS CON BLK GX-F44R
6-IC1	EI-324536	IC HD14049BP
6-IC2	EI-336801	IC MB8841-564M
6-IC3	EI-331661	IC SN7405N
6-IC4	EI-336725	IC M54527P
6-TR1to4	ET-200985	TR 2SC2603 F,G
6-TR5to28	ET-554657	TR 2SA733A P,Q
6-D1	ED-318292	D SILICON H 1S2473T-77 T26
6-D2to4	ED-308952	D GERMA V 1K34A-LR F07
6-D5to10	ED-318292	D SILICON H 1S2473T-77 T26
6-X1	EJ-318384	OSC X'TAL NC-18C 3.579545MHZ

SP (Service Parts) Classification

These reference symbols correspond with component symbols in the Schematic Diagrams.

5. The kind of part and its installation position can both be determined by the Part Number. To determine where a part number is listed, utilize the Parts Index at the end of the Parts List. It is necessary first of all to find the Part Number. This can be accomplished by using the Reference Number listed at the right of the part number in the Parts Index.

WARNING

△ INDICATES SAFETY CRITICAL COMPONENTS. FOR CONTINUED SAFETY, REPLACE SAFETY CRITICAL COMPONENTS ONLY WITH MANUFACTURE'S RECOMMENDED PARTS

AVERTISSEMENT

△ IL INDIQUE LES COMPOSANTS CRITIQUES DE SÉCURITÉ. POUR MAINTENIR LE DEGRÉ DE SÉCURITÉ DE L'APPAREIL, NE REMPLACER QUE DES PIÈCES RECOMMANDÉES PAR LE FABRICANT

RECOMMENDED SPARE PARTS

Because, if the parts listed below are on hand, almost any repair can be accomplished, we suggest that you stock these Recommended Spare Parts Items.

“NOTE” N: New Parts
 SYMBOL FOR DESTINATION
 [A] : AAL (U.S.A.)
 [B] : UK (Engalnd)
 [C] : CSA (Canada)
 [E] : CEE (Europe)
 [S] : SAA (Australia)
 [U] : U, T (Universal Area)

REF. NO.	PART NO.	DESCRIPTION
1	N BT-356493	△ TRANS POWER AA-A1-T20 [A]
2	N BT-356492	△ TRANS POWER AA-A1-T30 [C]
3	N BT-356494	△ TRANS POWER AA-A1-T40 [E,L(E)]
4	N BT-356495	△ TRANS POWER AA-A1-T50 [S,L(B)]
5	N BT-356491	△ TRANS POWER AA-A1-T70 [U]
6	EC-356284	C S-FIX H VCT51G136A 7.5-50
7	ED-200213	△ D SILICON DBA40C-K15 200/2.6A
7	ED-345555	△ D SILICON DBB10C 200/1.0A
9	ED-329057	△ D ZENER H HZ11 A1
10	ED-323836	△ D ZENER H HZ16 2
11	N ED-356515	D LED SLP-175D RED
12	N ED-356513	D LED SLP-236F-50U GREEN
13	ED-322773	D LED SLP-255D-01 GREEN
14	N ED-356514	D LED SLP-275D GREEN
15	N ED-356511	D LED SLP-281F-50U GREEN
16	ED-344280	D SILICON H GMA-01-FY2 F05
17	ED-348205	D SILICON V MC931 DOUBLE
18	ED-329056	D ZENER H HZ22 2
19	EE-337976	ANT LOOP LA-200A
20	EE-345556	VC AIR VCR52J517A
21	EF-623103	△ FUSE SEMKO T 1.00A 250V [E,S,L(E)]
22	EF-601301	△ FUSE SEMKO T 2.00A 250V [E,S,L(E)]
23	EF-668474	△ FUSE SEMKO T 400MA 250V [E,S,L(E)]
24	EF-327103	△ FUSE TSC A 250V 0.50A [U]
25	EF-311839	△ FUSE TSC A 250V 1.60A [U]
26	EF-306951	△ FUSE TSC A 250V 2.50A [U]
27	EF-309390	△ FUSE TSC 125V 0.50A [C,A]
28	EF-306956	△ FUSE TSC 125V 2.50A [C,A]
29	EF-323080	△ FUSE TSC 125V 3.15A [C,A]
30	EH-345550	FILTER CE SFE10.7MS2GK-Z
31	EI-352644	△ IC STK4141 (2)
32	EI-322248	IC LA1231N
33	EI-202218	IC LA1245
34	EI-349963	IC LA3410
35	EI-346071	IC M5218L-21
36	EI-337228	IC M5218L0
37	EI-349970	OSC CE CSB456F11 0.456MHz
38	EJ-355012	PHONE J 3P HLJ0541-010 6.3
39	EJ-343362	SOCKET OUTLET S2T732T174 JUC 2X2P
40	EJ-344423	TERMINAL W/SCREW YKD31-0133 P 2P
41	EO-335798	COIL VARI 2 25A-1353-01
42	EO-337599	COIL VARI 2 25A-1354-03
43	ES-337902	△ SW PUSH SDLD1P002 01-1
44	ES-349070	△ SW SELECTOR YKS11-0002 02-4 [U]
45	N ES-356507	SW PUSH ESB-62958 6 THROW [EXCEPT L]
46	N ES-356508	SW PUSH ESB-62959 7 THROW [L]
47	ES-346904	SW PUSH ESB-6413 02-2 S
48	ES-356509	SW PUSH ESB-62957 2 THROW
49	ET-310148	△ TR 2SD612K E,F
50	ET-351853	TR FET 2SK161 Y
51	ET-352408	TR FET 2SK192A GR
52	ET-338410	TR 2SC2878 A,B
53	ET-336869	TR 2SC2999 C,D
54	ET-353366	TR 2SC3112 A,B
55	ET-349081	TR 2SC3383 S,T
56	ET-328265	TR 2SC930 F
57	EV-345784	R S-FIX H RVF8P01 3P 304
58	N EV-356510	VR SLIDE 30P1SV0 W105
59	N EV-356161	VR SLIDE 30P2SV0 C104X2
60	EV-349065	VR SLIDE 60P2SV0H 254X2
61	EF-355398	△ FUSE BET T 2.00A 250V [L(B)]
62	EF-359342	△ FUSE BET T 400MA 250V [L(B)]
63	EF-355226	△ FUSE BET T 1.00A 250V [L(B)]

1. PC BOARD BLOCK

REF. NO.	PART NO.	DESCRIPTION
1-1A	BA-A1011A020A	PC MAIN BLK AA-A1 (U)
1-1B	BA-A1011A020B	PC MAIN BLK AA-A1 (C,A)
1-1C	BA-A1011A020C	PC MAIN BLK AA-A1 (E)
1-1D	BA-A1011A020D	PC MAIN BLK AA-A1 (S)
1-1E	BA-A1011A020E	PC MAIN BLK AA-A1L
1-2A	BA-A1011A030A	PC FRONT BLK AA-A1
1-2B	BA-A1011A030B	PC FRONT BLK AA-A1L

NOTES:

- (1) PC MAIN BLK consists of following PC BOARDS.
 - MAIN AMP PC BOARD
 - HEAD PHONE PC BOARD
 - POWER SUPPLY PC BOARD
- (2) PC FRONT BLK consists of following PC BOARDS.
 - FRONT PC BOARD
 - LED (1) PC BOARD
 - LED (2) PC BOARD

2. MAIN AMP PC BOARD

REF. NO.	PART NO.	DESCRIPTION
MAIN AMP PC BOARD		
2-IC1	EI-346071	IC M5218L-21
2-IC2	EI-352644	△ IC STK4141 (2)
2-IC101	EI-322248	IC LA1231N
2-IC102	EI-202218	IC LA1245
2-IC103	EI-349963	IC LA3410
2-TR2	ET-310148	△ TR 2SD612K E,F
2-TR101	ET-351853	TR FET 2SK161 Y
2-TR102	ET-336869	TR 2SC2999 C,D
2-TR103	ET-328265	TR2SC930F
2-TR104	ET-328265	TR 2SC930 F
2-TR106	ET-338410	TR 2SC2878 A,B [L]
2-TR107	ET-352408	TR FET 2SK192A GR [L]
2-TR108	ET-338410	TR 2SC2878 A,B [L]
2-TR109		
to 111	ET-353366	TR 2SC3112 A,B
2-JR112	ET-349081	TR 2SC3383 S,T [L]
2-D1	ED-344280	D SILICON H GMA-01-FY2 F05
2-D2	ED-329056	D ZENER H HZ22 2
2-D3,4	ED-329057	△ D ZENER H HZ11 A1
2-D5	ED-323836	△ D ZENER H HZ16 2
2-D6	ED-200213	△ D SILICON DBA40C-K15 200/2.6A
2-D7	ED-345555	△ D SILICON DBB10C 200/1.0A
2-D101		
to 103	ED-344280	D SILICON H GMA-01-FY2 F05
2-D104	ED-348205	D SILICON V MC931 DOUBLE
2-D105		
to 107	ED-344280	D SILICON H GMA-01-FY2 F05
2-SW1A	ES-356507	SW PUSH ESB-62958 6 THROW [EXCEPT L]
2-SW1B	ES-356508	SW PUSH ESB-62959 7 THROW [L]
2-SW2	ES-356509	SW PUSH ESB-62957 2 THROW
2-VR101	EV-345784	R S-FIX H RVF8P01 3P 304
2-FL101	EH-345550	FILTER CE SFE10.7MS2GK-KZ
2-FL102	EH-345550	FILTER CE SFE10.7MS2GK-KZ
2-L5	EO-337880	COIL FIX 2 202AK-018 2R2K
2-L101	EO-353912	COIL FIX 2 ANT2
2-L102	EO-354016	COIL FIX 2 RF2
2-L103	EO-349965	COIL FIX 2 ANT
2-L104	EO-349968	COIL FIX 2 RF
2-L105	EO-349969	COIL OSC 2 E502AN-2000012
2-L106	EO-336934	COIL FIX 1 LAL03KH 2R2M
2-L107	EO-337523	COIL FIX 1 L-8 223J
2-L108	EO-337523	COIL FIX 1 L-8 223J
2-T101	EO-337598	COIL VARI 2 25A-1353-01
2-T102	EO-337599	COIL VARI 2 25A-1354-03 [L]
2-T103A	EO-348209	COIL OSC 2 7NR-8646Y 115.0 UH [EXCEPT L]
2-T103B	EO-349456	COIL OSC 2 7NRS-9153Z 150.0UH [L]
2-T104	EO-352089	COIL OSC 2 7BRS-9098X 580.0UH [L]
2-T105	EO-356730	COIL IFT BCFLZ-459A
2-T106	EO-202216	COIL IFT 7MC-6733C 460.0kHz
2-T107	EO-349452	COIL DET 2 78-1045-01
2-T108	EO-349453	COIL DET 2 78-1046-01
2-T109	EO-337640	COIL IFT 119AC-15533X 10.7MHz
2-X101	EI-349970	OSC CE CSB456F11 0.456MHz
2-VC101	EE-345556	VC AIR VCR52J517A
2-VC102		
to 105	EC-356284	C S-FIX H VCT51G136A 7.5-50
2-R19	ER-324480	△ R CB H S10 FS RDS 1/4W 470J
2-R22	ER-324480	△ R CB H S10 FS RDS 1/4W 470J
2-R23,24	ER-311685	△ R CB H S15 FS RDS 1/2W 4R7J
2-R28,29	ER-333067	△ R OMF H S20 FS 2W 821J
2-R31	ER-351221	R OMF H SNP FS 1W 221J
2-R114	ER-324337	R CB H S10 FS RDS 1/4W 560J
2-R115	ER-324337	R CB H S10 FS RDS 1/4W 560J
2-R121	ER-200941	R CB H S10 FS RDS 1/4W 271J
2-R125	ER-314983	R OMF H SNP FS 1W 103J
2-R133		
134	ER-324337	R CB H S10 FS RDS 1/4W 560J
2-R145	ER-324185	△ R CB H S10 FS RDS 1/4W 221J
2-R146	ER-315046	△ R CB H F10 RDS 1/4W 121J
2-R161	ER-324337	△ R CB H S10 FS RDS 1/4W 560J
2-R162	ER-324337	△ R CB H S10 FS RDS 1/4W 560J
2-C26,27	EC-352643	C EC V 472M 40DC
2-C29	EC-325109	C EC V CUT SM 102M 50DC

REF. NO.	PART NO.	DESCRIPTION
2-C30	EC-326583	△ C MMY V CUT CF921 473K 400DC
2-C166	EC-356597	C PP V F05 PP 431J 50DC
2-C167	EC-351129	C PP V F05 PP 271J 50DC [L]
2-C173A	EC-347093	C PP V F05 PP 331J 50DC [U,S]
2-C173B	EC-353044	C PP V F05 PP 511J 50DC [C,A]
2-C173C	EC-551129	C PP V F05 PP 271J 50DC [E,L]
2-C174A	EC-347093	C PP V F05 PP 331J 50DC [U,S]
2-C174B	EC-353044	C PP V F05 PP 511J 50DC [C,A]
2-C174C	EC-351129	C PP V F05 PP 271J 50DC [E,L]
2-C179	EC-356598	C PP V F05 PP 302J 50DC
2-C180	EC-356598	C PP V F05 PP 302J 50DC
2-J1,2	EJ-336905	PIN J AJC-035-ACB P 4P
2-J3	EJ-356505	PIN J 1P
2-J4	EJ-356506	PIN J W/SW 1P
2-TM1	EJ-349061	TERMINAL PUSH YKD21-0025 P 8P
2-TM101	EJ-344423	TERMINAL W/SCREW YKD31-0133 P 2P

ASSEMBLY BLOCK

2-F3	EF-306951	△ FUSE TSC A 250V 2.50A [U]
2-F3B	EF-306956	△ FUSE TSC 125V 2.50A [C,A]
2-F3C	EF-601301	△ FUSE SEMKO T 2.00A 250V [E,S,L(E)]
2-F3D	EF-355398	△ FUSE BET T 2.00A 250V [L(B)]
2-F4A	EF-306951	△ FUSE TSC A 250V 2.50A [U]
2-F4B	EF-306956	△ FUSE TSC 125V 2.50A [C,A]
2-F4C	EF-601301	△ FUSE SEMKO T 2.00A 250V [E,S,L(E)]
2-F4D	EF-355398	△ FUSE BET T 2.00A 250V [L(B)]
2-F5A	EF-327103	△ FUSE TSC A 250V 0.50A [U]
2-F5B	EF-309390	△ FUSE TSC 125V 0.50A [C,A]
2-F5C	EF-668474	△ FUSE SEMKO T 400MA 250V [E,S,L(E)]
2-F5D	EF-359342	△ FUSE BET T 400MA 250V [L(B)]

3. FRONT PC BOARD

REF. NO.	PART NO.	DESCRIPTION
3-IC201	EI-337228	IC M5218L0
3-D201		
to 203	ED-356511	D LED SLP-281F-50U GREEN
3-D204		
to 207	ED-356513	D LED SLP-236F-50U GREEN
3-SW201	ES-346904	SW PUSH ESB-6413 02-2 S
3-VR201	EV-349065	VR SLIDE 60P2SV0H 254X2
3-VR202	EV-356510	VR SLIDE 30P1SV0 W105
3-VR203,		
204	EV-356161	VR SLIDE 30P2SV0 C104X2
3-1	ZW-632226	INSULATOR WASHER (BUSH M)

4. LED (1) PC BOARD

REF. NO.	PART NO.	DESCRIPTION
4-D208	ED-356514	D LED SLP-275D GREEN
4-D209	ED-356515	D LED SLP-175D RED

5. LED (2) PC BOARD

REF. NO.	PART NO.	DESCRIPTION
5-D210	ED-322773	D LED SLP-255D-01 GREEN

6. HEAD PHONE PC BOARD

REF. NO.	PART NO.	DESCRIPTION
6-J7	EJ-355012	PHONE J 3P HLJ0541-010 6.3

7. POWER SUPPLY PC BOARD

REF. NO.	PART NO.	DESCRIPTION
POWER SUPPLY PC BOARD		
7-SW3	ES-337902	△ SW PUSH SDDL1P002 01-1
7-R60	ER-356573	△ R SD ANTI-STATIC 1/2W 225K [C,A]
7-C60A	EC-320548	△ C CE V F 103Z 250AC
7-C60B	EC-338411	△ C CE V FZ 103P 400AC [C,A]
7-C60C	EC-338496	△ C CE V FZ 472P 400AC [E,S,L]
ASSEMBLY BLOCK		
7-F1A	EF-311839	△ FUSE TSC A 250V 1.60A [U]
7-F1B	EF-323080	△ FUSE TSC 125V 3.15A [C,A]
7-F1C	EF-623103	△ FUSE SEMKO T 1.00A 250V [E,S,L(E)]
7-F1D	EF-355226	△ FUSE BET T 1.00A 250V [L(B)]
7-F2	EF-311839	△ FUSE TSC A 250V 1.60A [U]

ASSEMBLY BLOCK

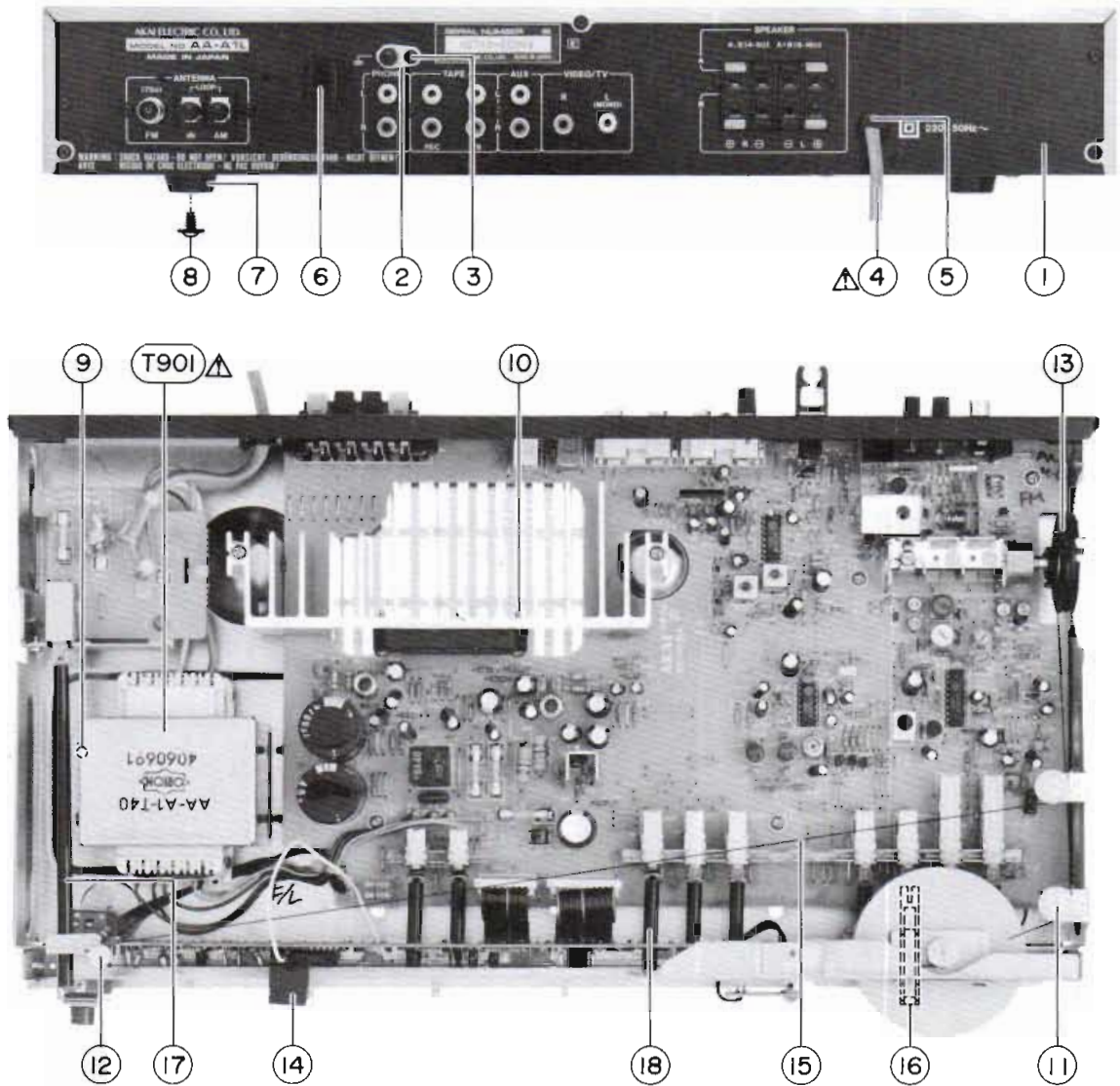

8. ASSEMBLY BLOCK

REF. NO.	PART NO.	DESCRIPTION	REF. NO.	PART NO.	DESCRIPTION
			8-7	SA-202118	FOOT
			8-8	ZS-498273	T2BR30X08STL CMT PW080
			8-9	ZS-300519	ST PAN40X08STL CMT
			8-10	ZS-321279	T2BR30X18STL CMT
			8-11	MZ-307170	PULLEY
			8-12	MR-308836	PULLEY
			8-13	TA-322250	DIAL WHEEL ASSY
			8-14	MD-356482	HOLDER TUNING
			8-15	TA-201961	DIAL STRING TK-1064 (BLACK) D0.5
			8-16	MZ-356474	JOINT (A)
			8-17	MZ-356476	JOINT POWER
			8-18	MZ-356475	JOINT (B)
			8-19x	EE-337976	ANT LOOP LA-200A
			8-20x	EJ-352118	SOCKET COAX PAL B2-714P-900
8-1A	SP-356472A	PANEL REAR AA-A1 (U)	8-T901A	BT-356491	△ TRANS POWER AA-A1-T70 [U]
8-1B	SP-356472G	PANEL REAR AA-A1 (C)	8-T901B	BT-356492	△ TRANS POWER AA-A1-T30 [C]
8-1C	SP-356472B	PANEL REAR AA-A1 (A)	8-T901C	BT-356493	△ TRANS POWER AA-A1-T20 [A]
8-1D	SP-356472C	PANEL REAR AA-A1 (E,V)	8-T901D	BT-356494	△ TRANS POWER AA-A1-T40 [E,L(E)]
8-1E	SP-356472D	PANEL REAR AA-A1 (S)	8-T901E	BT-356495	△ TRANS POWER AA-A1-T50 [S,L(B)]
8-1F	SP-356472F	PANEL REAR AA-A1L (E)	8-SW901x	ES-349070	△ SW SELECTOR YKS11-0002 02-4 [U]
8-1G	SP-356472E	PANEL REAR AA-A1L (B)	8-J901Ax	EJ-343362	△ SOCKET OUTLET S2T732T174 JUC 2X2P [U]
8-2	EJ-329610	TERMINAL W/ SCREW UB-0067 L 1P	8-J901Bx	EJ-349837	△ SOCKET OUTLET S2T732T124 JUC [C,A]
8-3	ZS-319460	T2BR30X06STL BZN PROJECTION			
8-4A	EW-306428	△ AC CORD 2 CORES KP-700A VFF			
8-4B	EW-349427	△ AC ROCRD 2 CORES KP-8W, SPT-2 UC [C]			
8-4C	EW-349428	△ AC CORD 2 CORES KP-8W, SPT-1 UC [A]			
8-4D	EW-336923	△ AC CORD 2 CORES KP-419C, LTCE- 2F EV [E,L(E)]			
8-4E	EW-336924	△ AC CORD 2 CORES KP-560, LTS- 2F S [S]			
8-4F	EW-347025	△ AC COARD 2 CORES LTBS-2F B [L(B)]			
8-5	EZ-631945	STRAIN RELIEF SR-4N-4			
8-6	SZ-332739	HOLDER ANTENNA			

FINAL ASSEMBLY BLOCK

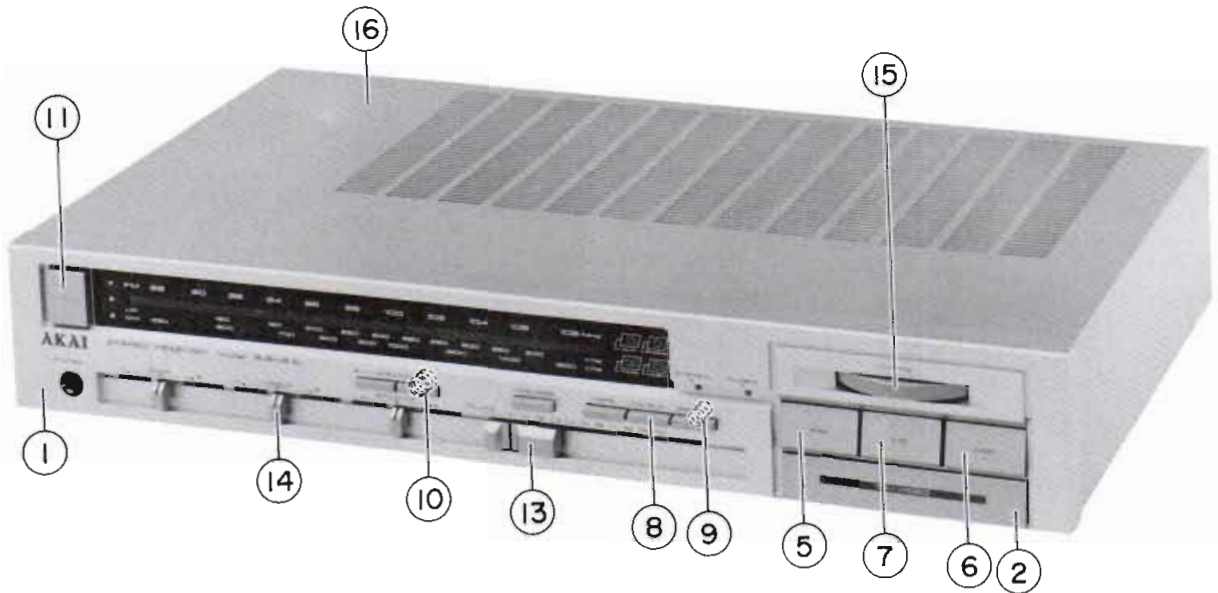

9. FINAL ASSEMBLY BLOCK

REF. NO.	PART NO.	DESCRIPTION
PANEL FRONT BLOCK		
9-1A	BD-A1011A040A	PANEL FRONT BLK AA-A1
9-1B	BD-A1011A040B	PANEL FRONT BLK AA-A1L
9-1C	BD-A1011A040C	PANEL FRONT BLK AA-A1-B
9-1D	BD-A1011A040D	PANEL FRONT BLK AA-A1L-B
9-2	SK-356486	KNOB PUSH (D)
9-2B	SK-356486B	KNOB PUSH (D)-B
9-3x	SK-356485D	KNOB PUSH (C) FM [EXCEPT L]
9-3Bx	SK-356485C	KNOB PUSH (C) FM-B [EXCEPT L]
9-4x	SK-356485	KNOB PUSH (C) AM [EXCEPT L]
9-4Bx	SK-356485B	KNOB PUSH (C) AM-B [EXCEPT L]
9-5	SK-356484E	KNOB PUSH (B) FM [L]
9-5B	SK-356484C	KNOB PUSH (B) FM-B [L]
9-6	SK-356484	KNOB PUSH (B) MW [L]
9-6B	SK-356484B	KNOB PUSH (B) MW-B [L]
9-7	SK-356484F	KNOB PUSH (B) LW [L]
9-7B	SK-356484D	KNOB PUSH (B) LW-B [L]
9-8	SK-356483	KNBO PUSH (A)
9-8B	SK-356483B	KNBO PUSH (A)-B
9-9	ZC-356477	SP PUSH
9-10	ZG-356478	SP PUSH (3)
9-11	SK-343017C	KNOB POWER (2)
9-11B	SK-343017F	KNOB POWER-B

REF. NO.	PART NO.	DESCRIPTION
FINAL ASSEMBLY BLOCK		
9-12x	ZS-308513	T2BR30X12STL CMT PW080 [PANEL FRONT FIX]
9-13	SK-346855B	KNOB SLIDE (B)-S
9-13B	SK-346855	KNOB SLIDE (B)
9-14	SK-346854B	KNOB SLIDE (A)-S
9-14B	SK-346854	KNOB SLIDE (A)
9-15	TA-356496	DIAL TUNING ASSY (4)
9-15B	TA-356803	DIAL TUNING ASSY (5)-B
9-16	SP-356479	COVER UPPER
9-16B	SP-356479B	COVER UPPER-B

NOTE:

PANEL FRONT BLK consists of 9-2, 9-3, 9-4, 9-5, 9-6, 9-7, 9-8, 9-9, 9-10, and 9-11.

SYMBOL FOR COLOR VARIATION

NON : STANDARD COLOR
B or BL : BLACK

INDEX

PART NO.	REF. NO.	PART NO.	REF. NO.	PART NO.	REF. NO.	PART NO.	REF. NO.	PART NO.	REF. NO.
BA-A1011A020A	1-1A	EI-349970	2-X101	MD-356482	8-14				
BA-A1011A020B	1-1B	EI-352644	2-IC2	MR-308836	8-12				
BA-A1011A020C	1-1C	EJ-329610	8-2	MZ-307170	8-11				
BA-A1011A020D	1-1D	EJ-336905	2-J2	MZ-356474	8-16				
BA-A1011A020E	1-1E	EJ-336905	2-J1	MZ-356475	8-18				
BA-A1011A030A	1-2A	EJ-343362	8-J901Ax	MZ-356476	8-17				
BA-A1011A030B	1-2B	EJ-344423	2-TM101	SA-202118	8-7				
BD-A1011A040A	9-1A	EJ-349061	2-TM1	SK-343017C	9-11				
BD-A1011A040B	9-1B	EJ-349837	8-J901Bx	SK-343017F	9-11B				
BT-356491	8-T901A	EJ-352118	8-20x	SK-346854	9-14B				
BT-356492	8-T901B	EJ-355012	6-J7	SK-346854B	9-14				
BT-356493	8-T901C	EJ-356505	2-J3	SK-346855	9-13B				
BT-356494	8-T901D	EJ-356506	2-J4	SK-346855B	9-13				
BT-356495	8-T901E	EO-202216	2-T106	SK-356483	9-8				
EC-320548	7-C60A	EO-336934	2-L106	SK-356483B	9-8B				
EC-325109	2-C29	EO-337523	2-L108	SK-356484	9-6				
EC-326883	2-C30	EO-337523	2-L107	SK-356484B	9-6B				
EC-338411	7-C60B	EO-337598	2-T101	SK-356484C	9-5B				
EC-338496	7-C60C	EO-337599	2-T102	SK-356484D	9-7B				
EC-347093	2-C174A	EO-337640	2-T109	SK-356484E	9-5				
EC-347093	2-C173A	EO-337880	2-L5	SK-356484F	9-7				
EC-351129	2-C167	EO 348209	2-T103A	SK-356485	9-4x				
EC-351129	2-C173C	EO-349452	2-T107	SK-356485B	9-4Bx				
EC-351129	2-C174C	EO-349453	2-T108	SK-356485C	9-3Bx				
EC-352643	2-C27	EO-349456	2-T103B	SK-356485D	9-3x				
EC-352643	2-C26	EO-349965	2-L103	SK-356486	9-2				
EC-353044	2-C173B	EO-349968	2-L104	SK-356486B	9-2B				
EC-353044	2-C174B	EO-349969	2-L105	BD-A1011A040C	9-1C				
EC-356284	2-VC105	EO-352089	2-T104	BD-A1011A040D	9-1D				
EC-356284	2-VC103	EO-353912	2-L101	SP-356472A	8-1A				
EC-356284	2-VC104	EO-354016	2-L102	SP356472B	8-1C				
EC-356284	2-VC102	EO-356730	2-T105	SP-356472C	8-1D				
EC-356597	2-C166	ER-200941	2-R121	SP-356472D	8-1E				
EC-356598	2-C180	ER-311685	2-R23	SP-356472E	8-1G				
EC-356598	2-C179	ER-311685	2-R24	SP-356472F	8-1F				
ED-200213	2-D6	ER-314983	2-R125	SP356472G	8-1B				
ED-322773	5-D210	ER-315046	2-R146	SP-356479	9-16				
ED-323836	2-D5	ER-342885	2-R145	SP-356479B	9-16B				
ED-329056	2-D2	ER-324337	2-R115	SZ-332739	8-6				
ED-329057	2-D4	ER-324337	2-R114	TA-201961	8-15				
ED-329057	2-D3	ER-324337	2-R134	TA-322250	8-13				
ED-344280	2-D1	ER-324337	2-R162	TA-356496	9-15				
ED-344280	2-D103	ER-324337	2-R133	TA-356803	9-15B				
ED-344280	2-D101	ER-324337	2-R161	ZG-356477	9-9				
ED-344280	2-D102	ER-324480	2-R22	ZG-356478	9-10				
ED-344280	2-D106	ER-324480	2-R19	ZS-300519	8-9				
	to 107	ER-333067	2-R29	ZS-308513	9-12x				
ED-345555	2-D7	ER-333067	2-R28	ZS-319460	8-3				
ED-348205	2-D104	ER-351221	2-R31	ZS-321279	8-10				
ED-356511	3-D201	ER-356573	7-R60	ZS-498273	8-8				
ED-356511	3-D202,	ES-337902	7-SW3	ZW-632226	3-1				
	D203	ES-346904	3-SW201	EF-355226	7-F1D				
ED-356513	3-D204	ES-349070	8-SW901x	EF-355398	2-F3D				
ED-356513	3-D205	ES-356507	2-SW1A	EF-355398	2-F4D				
ED-356513	3-D207	ES-356508	2-SW1B	EF-359342	2-F5D				
ED-356513	3-D206	ES-356509	2-SW2						
ED-356514	4-D208	ET-310148	2-TR2						
ED-356515	4-D209	ET-328265	2-TR103						
EE-337976	8-19	ET-328265	2-TR104						
EE-345556	2-VC101	ET-336869	2-TR102						
EF-306951	2-F3A	ET-338410	2-TR106						
EF-306951	2-F4A	ET-338410	2-TR108						
EF-306956	2-F3B	ET-349081	2-TR112						
EF-306956	2-F4B	ET-351853	2-TR101						
EF-309390	2-F5B	ET-352408	2-TR107						
EF-311839	7-F2	ET-353366	2-TR110						
EF-311839	7-F1A	ET-353366	2-TR111						
EF-323080	7-F1B	ET-353366	2-TR109						
EF-327103	2-F5A	EV-345784	2-VR101						
EF-601301	2-F4C	EV-349065	3-VR201						
EF-601301	2-F3C	EV-356161	3-VR204						
EF-623103	7-F1C	EV-356161	3-VR203						
EF-668474	2-F5C	EV-356510	3-VR202						
EH-345550	2-FL102	EW-306428	8-4A						
EH-345550	2-FL101	EW-336923	8-4D						
EI-202218	2-IC102	EW-336924	8-4E						
EI-322248	2-IC101	EW-347025	8-4F						
EI-337228	3-IC201	EW-349427	8-4B						
EI-346071	2-IC1	EW-349428	8-4C						
EI-349963	2-IC103	EZ-631945	8-5						

AKAI ELECTRIC CO., LTD.

12-14, 2-Chome, Higashi-Kojiya, Ohta-Ku, Tokyo, Japan

TEL: Tokyo (742) 5111 CABLE: HIFIAKAI TOKYO TELEX: J26261

Printed No. 850301-K1-2600

Printed Date: March 25, 1985

350 Printed in Japan

AKAI

MODEL AA-A1/L

SCHMATIC DIAGRAM AND PC BOARDS

1. STK4141-II, M5218LO/M5218L-21 1
2. AA-A1 SCHEMATIC DIAGRAM 2
3. AA-A1 MAIN AMP PCB, CONTROL PCB, POWER SUPPLY PCB 3
4. AA-A1L MAIN AMP PCB, CONTROL PCB, POWER SUPPLY PCB 4
5. AA-A1L SCHEMATIC DIAGRAM 5
6. AA-A1/L BLOCK DIAGRAM 6

STK4141-II

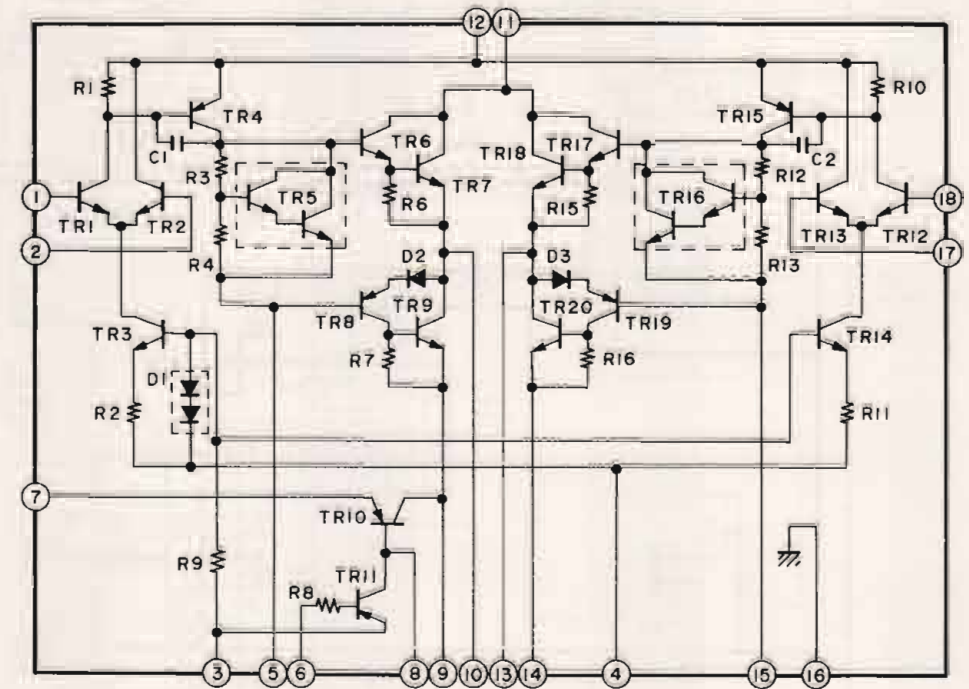

M5218LO/M5218L-21

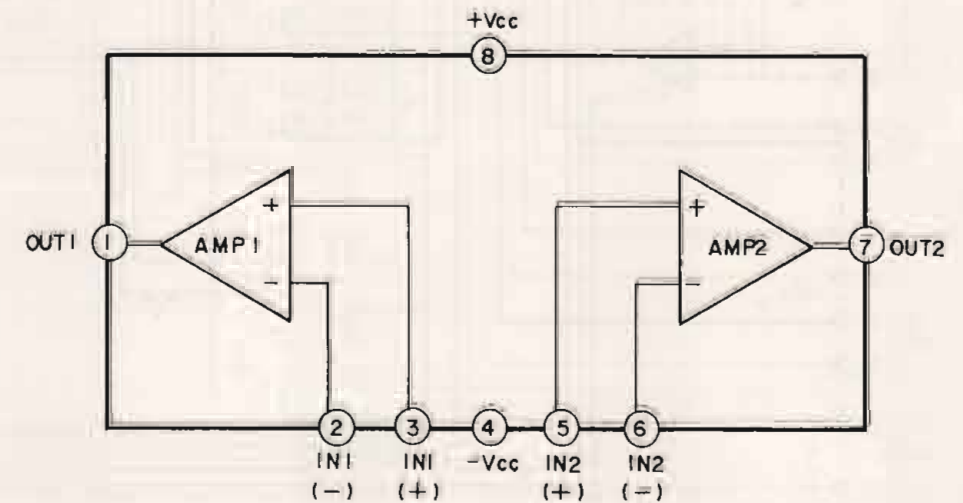

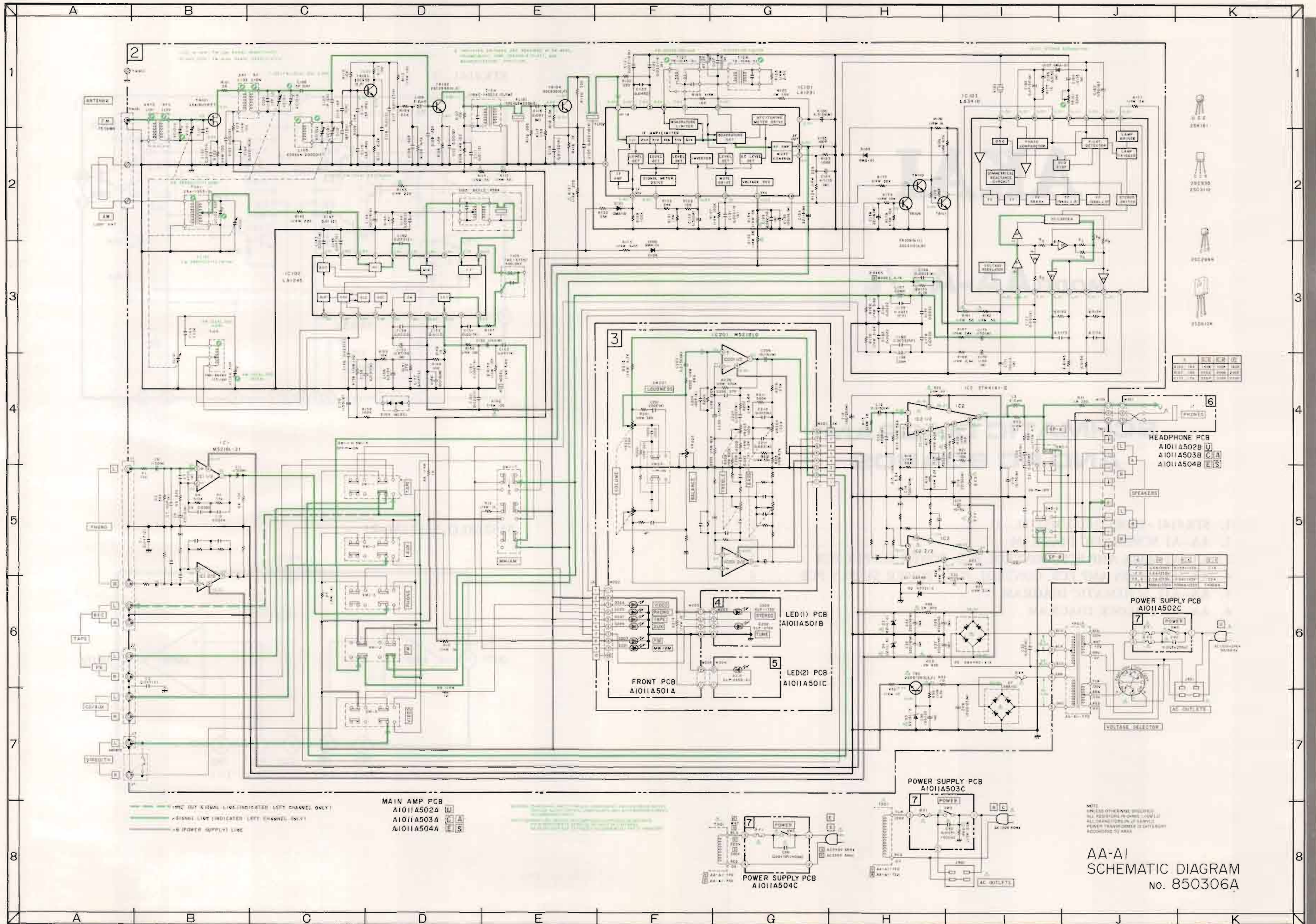

MAIN AMP PCB
 A1011A502A U
 A1011A503A C A
 A1011A504A E S

FRONT PCB
 A1011A501A

LED(1) PCB
 A1011A501B

LED(2) PCB
 A1011A501C

POWER SUPPLY PCB
 A1011A503C

POWER SUPPLY PCB
 A1011A504C

HEADPHONE PCB
 A1011A502B U
 A1011A503B C A
 A1011A504B E S

POWER SUPPLY PCB
 A1011A502C

AA-AI
 SCHEMATIC DIAGRAM
 No. 850306A

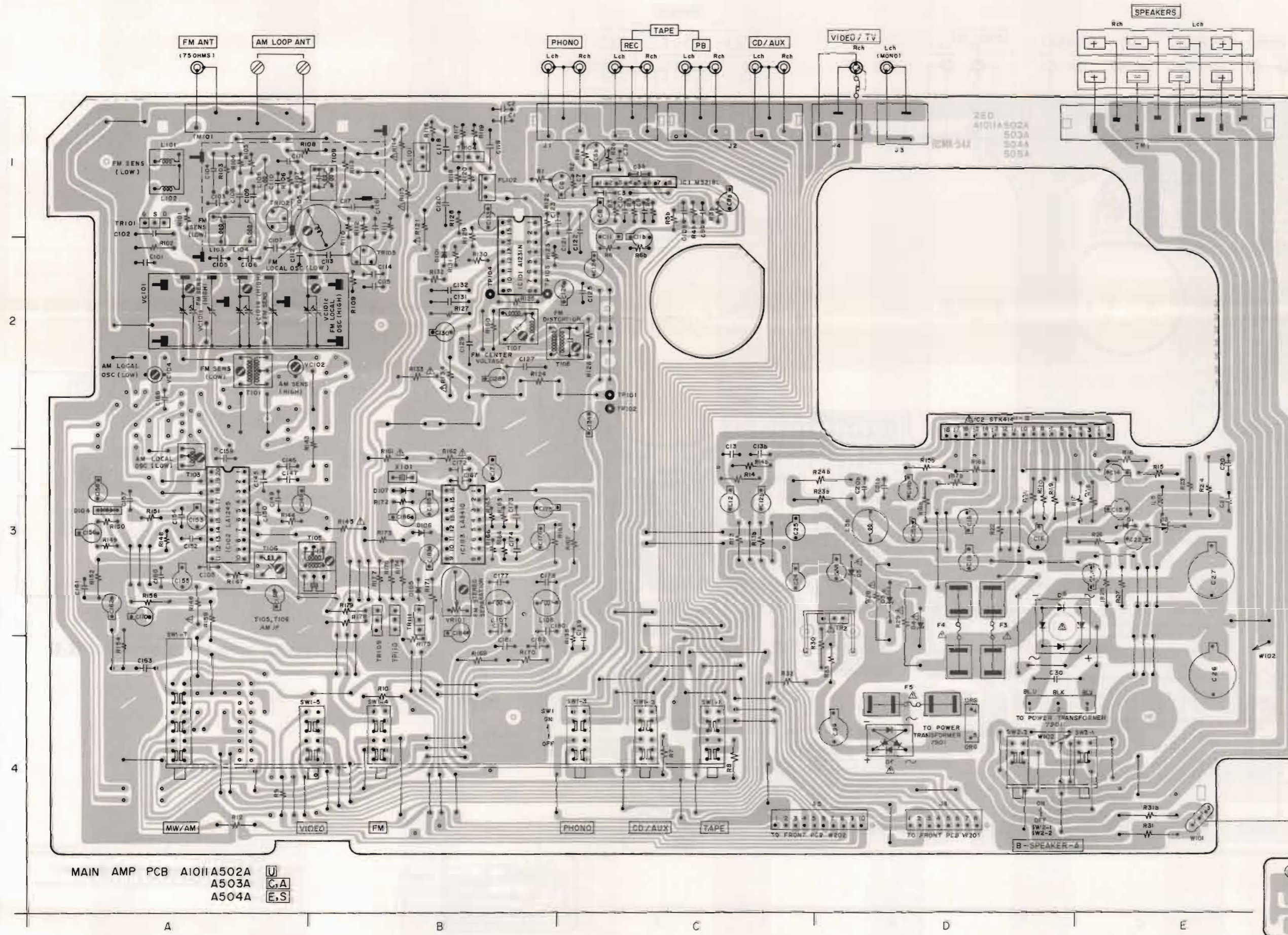

LOCATION OF COMPO:

IC
IC1 --- IC
IC2 --- 2D
IC101 --- 2B
IC102 --- 3A
IC103 --- 3B

TRANSISTOR
TR2 --- 3D
TR101 --- 1A
TR102 --- 1A
TR103 --- 2B
TR104 --- 1B
TR109 --- 3B
TR110 --- 3B
TR111 --- 3B

TERMINAL
J5 --- 4C
J6 --- 4D
W101 --- 4E

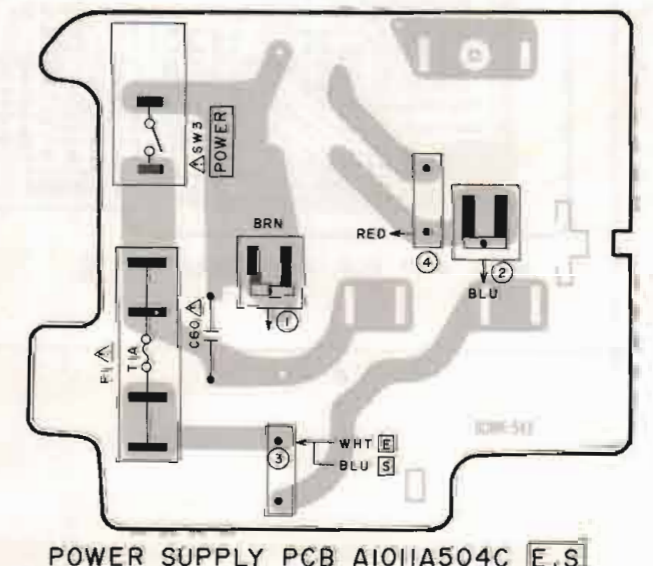
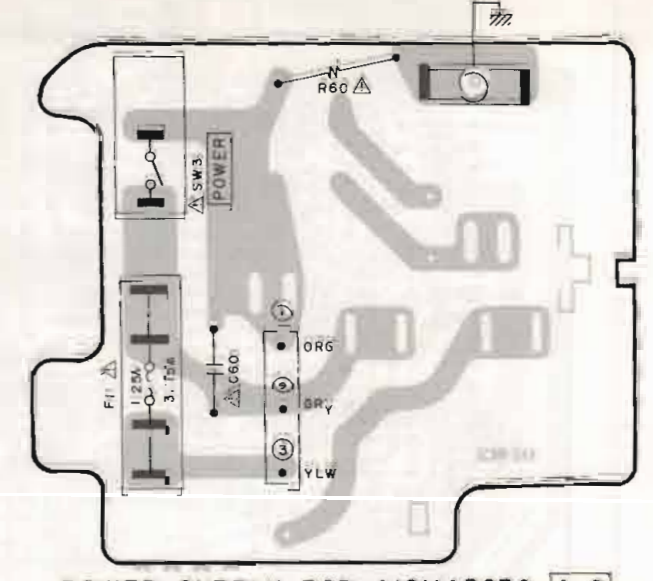
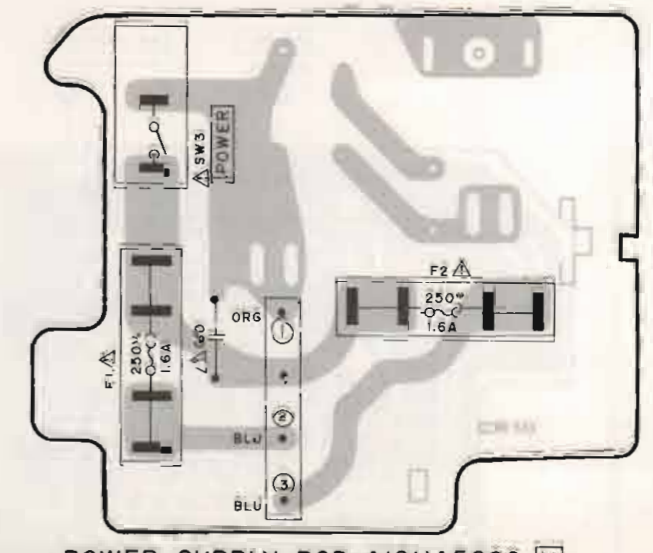

TR2 --- 25D612K (D,E,F)
TR101 --- 25K161 (Y) FET
TR102 --- 25C2999 (G,D)
TR103 --- 25C930 (E,F)
TR104 --- 25C930 (E,F)
TR109 --- 25C3112 (A,B)
TR110 --- 25C3112 (A,B)
TR111 --- 25C3112 (A,B)

LED(2) PCB A1011A501C

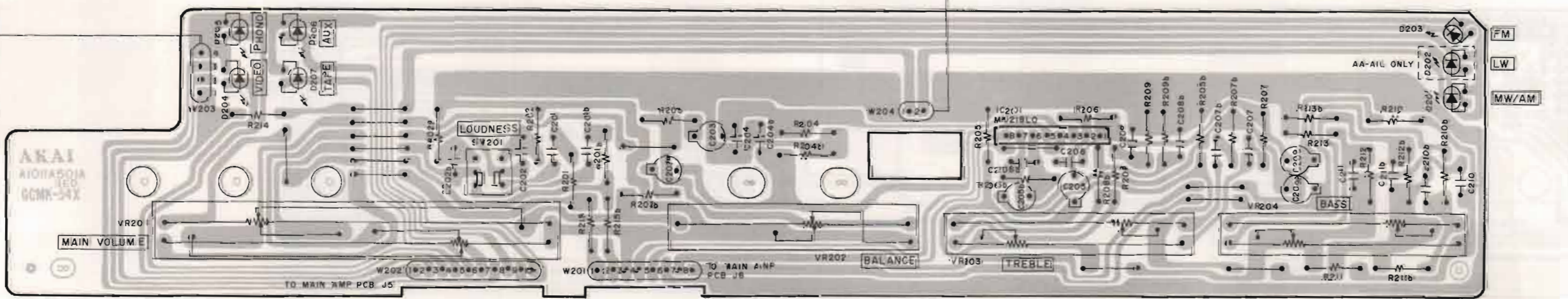
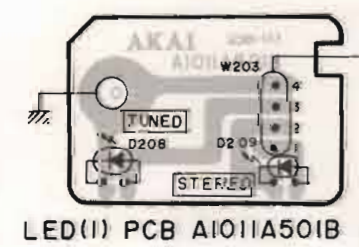

WARNING: INDICATES SAFETY CRITICAL COMPONENTS FOR CONTINUED SAFETY. REPLACE SAFETY CRITICAL COMPONENTS ONLY WITH MANUFACTURER'S RECOMMENDED PARTS.

AVERTISSEMENT: ALL INDIQUE LES COMPOSANTS CRITIQUES DE SECURITE. POUR MAINTENIR LE DEGRE DE SECURITE DE L'APPAREIL, NE REMPLACER QUE DES PIECES RECOMMANDEES PAR LE FABRICANT.

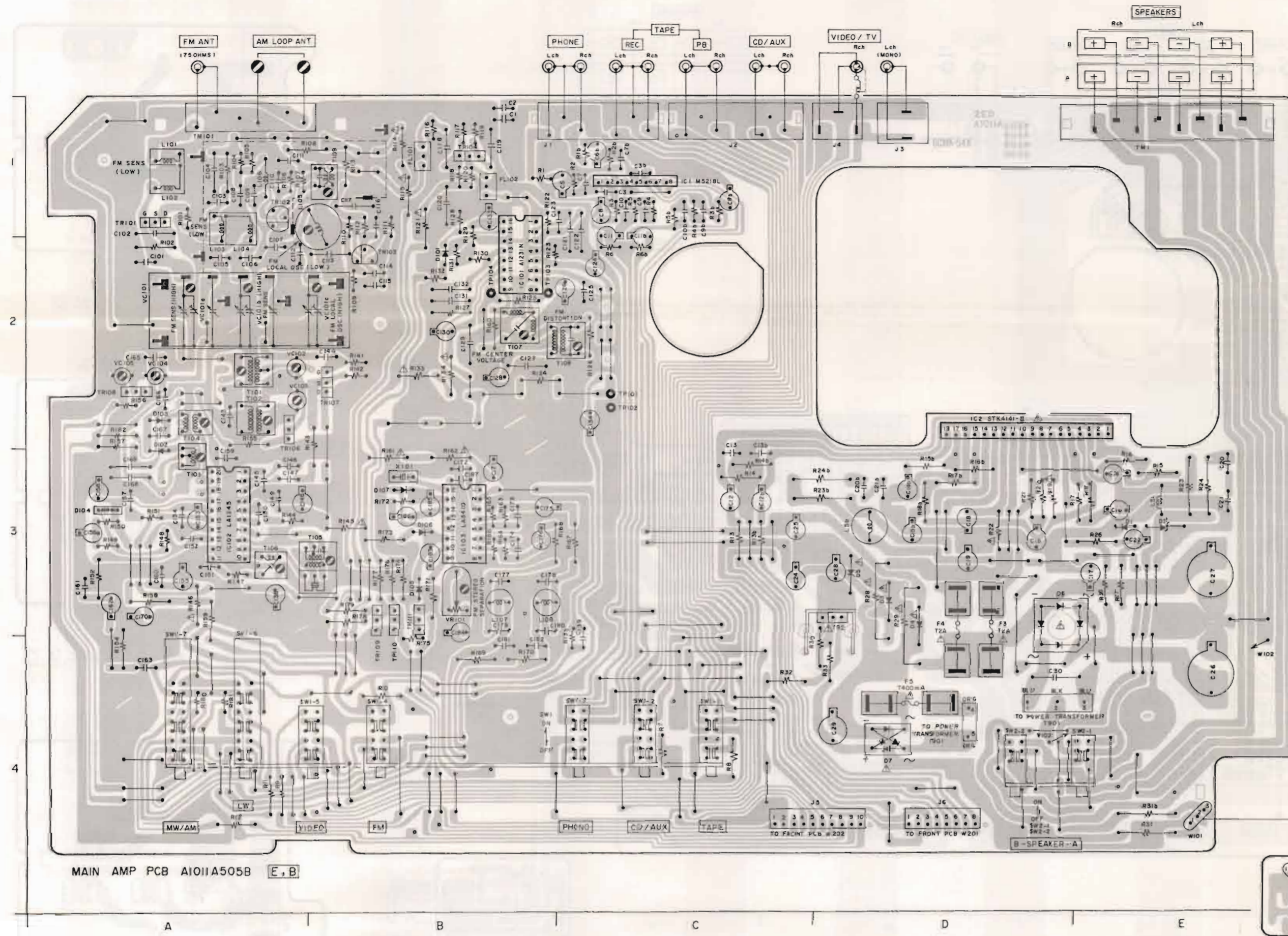

LOCATION OF COMPONENTS

- IC
 IC1 ---- IC
 IC2 ---- 2D
 IC101 ---- 2B
 IC102 ---- 3A
 IC103 ---- 3B
- TRANSISTOR
 TR2 ---- 30
 TR101 ---- 1A
 TR102 ---- 1A
 TR103 ---- 2B
 TR104 ---- 1B
 TR106 ---- 2A
 TR107 ---- 2B
 TR108 ---- 2A
 TR109 ---- 3B
 TR110 ---- 3B
 TR111 ---- 3B
 TR112 ---- 2A



- TERMINAL
 J5 ---- 4C / 4D
 J6 ---- 4D
 W10 ---- 4E

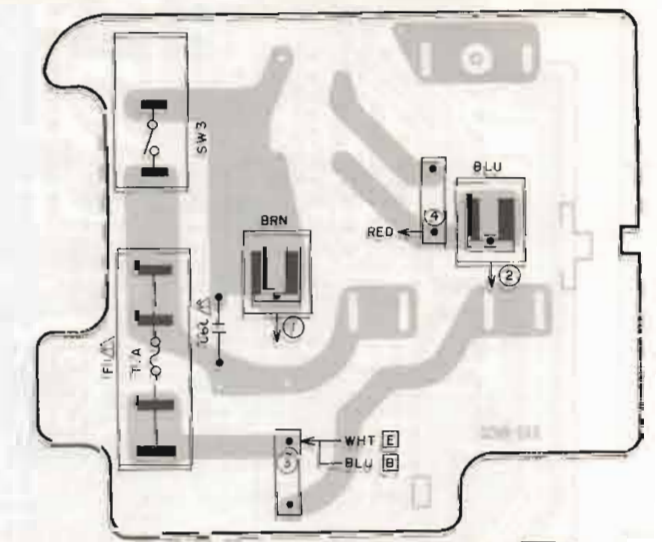

WARNING: Δ INDICATES SAFETY CRITICAL COMPONENTS FOR CONTINUED SAFETY. REPLACE SAFETY CRITICAL COMPONENTS ONLY WITH MANUFACTURER'S RECOMMENDED PARTS.
 AVERTISSEMENT: Δ INDIQUE LES COMPOSANTS CRITIQUES DE SÉCURITÉ. POUR MAINTENIR LE DEGRÉ DE SÉCURITÉ DE L'APPAREIL, NE REMPLACER QUE DES PIÈCES RECOMMANDÉES PAR LE FABRICANT.

- TR2 ---- 2SD612K (D,E,F)
 TR101 ---- 2SK161 (Y) PFT
 TR102 ---- 2SC2999 (C,D)
 TR103, 104 ---- 2SC930 (E,F)
 TR106, 108 ---- 2SC2878 (A,B)
 TR109 ---- 2SK192 (G,R)
 TR110, 111 ---- 2SC312 (A,B)

LED(2) PCB A1011A501C

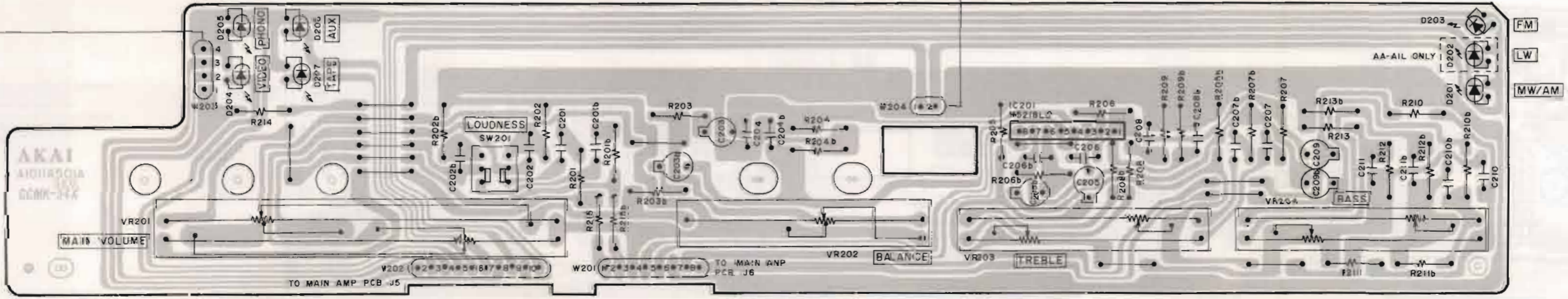
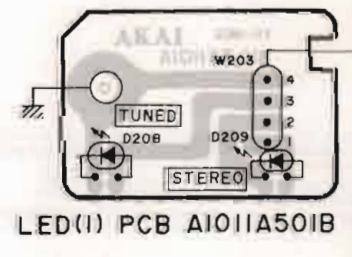
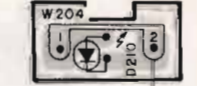

FRONT PCB A1011A501A

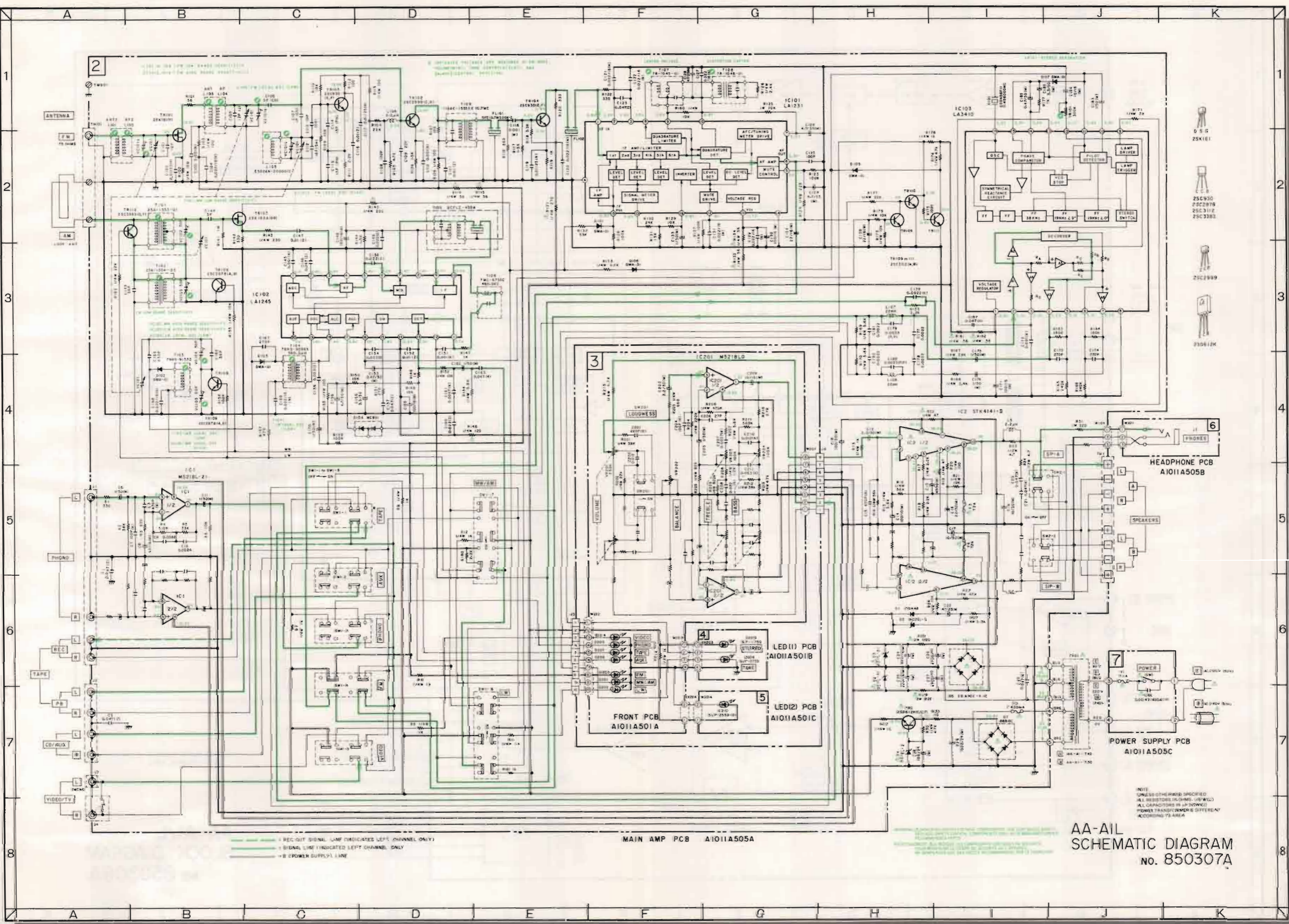

MAIN AMP PCB A1011A505A

AA-A11
SCHEMATIC DIAGRAM
NO. 850307A

NOTE:
UNLESS OTHERWISE SPECIFIED:
ALL RESISTORS IN OHMS, (Ω) W/Ω
ALL CAPACITORS IN μF (μW/μ)
POWER TRANSISTORS ARE DIFFERENT
ACCORDING TO AREA

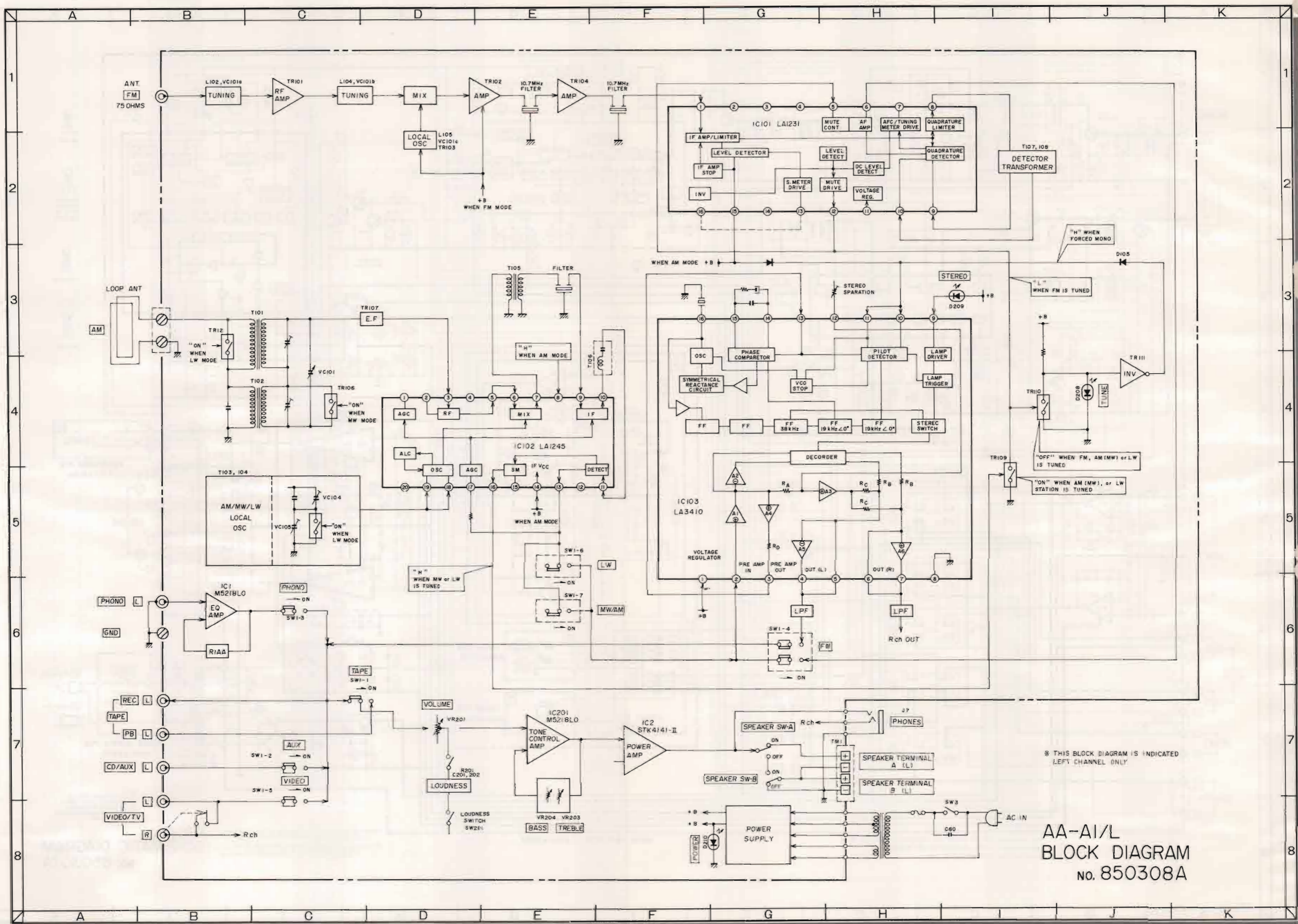

AA-A1/L
 BLOCK DIAGRAM
 No. 850308A