

AKAI  
AA-R32L

AA-R32L

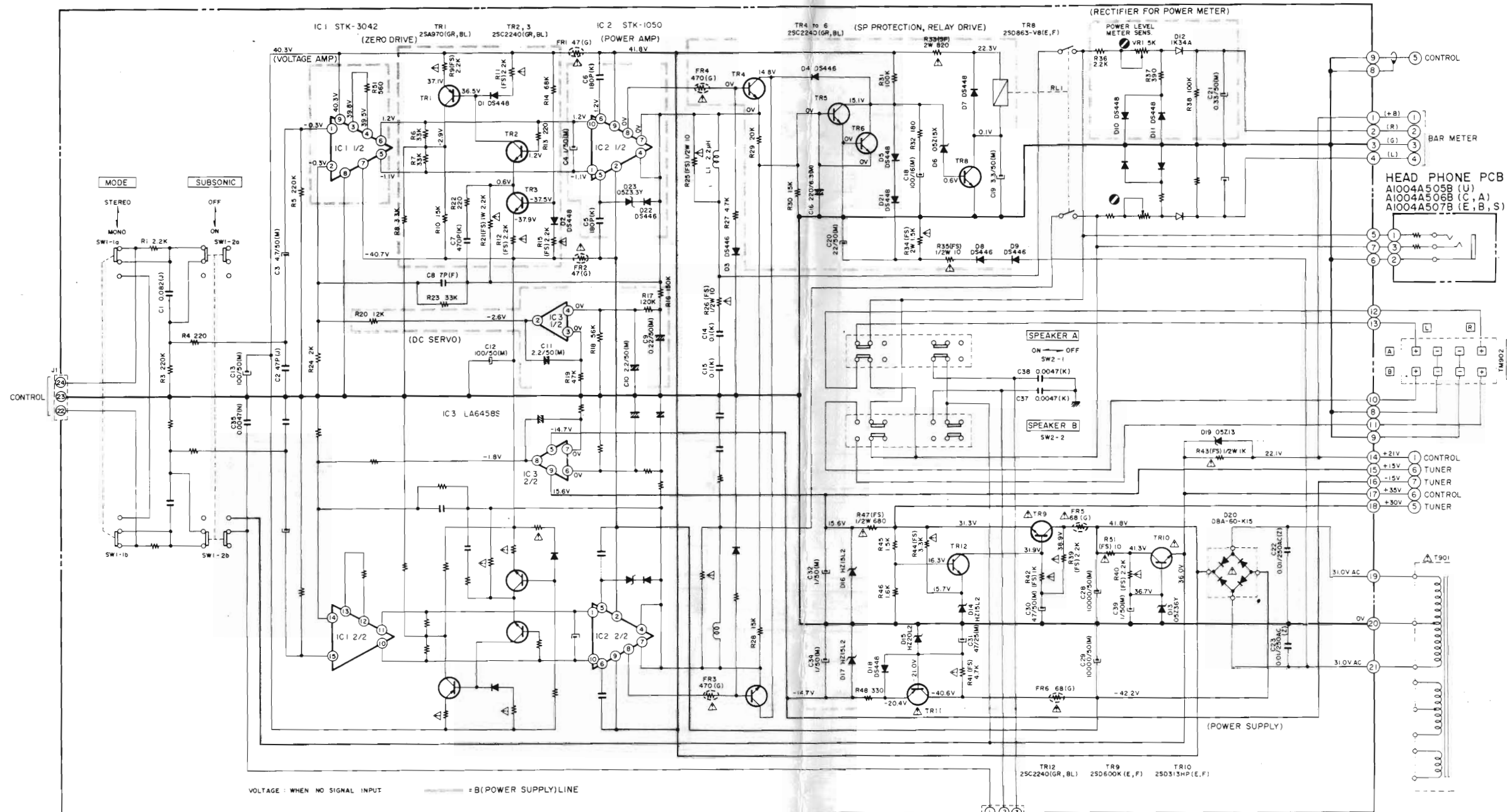

MAIN AMP PCB (U) A1004A505A  
(C,A) A1004A506A  
(E,B,S) A1004A507A

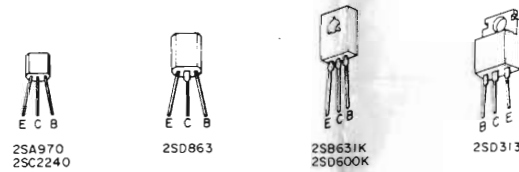

KEY BOARD (1)

WARNING:  $\Delta$  INDICATES SAFETY CRITICAL COMPONENTS. FOR CONTINUED SAFETY, REPLACE SAFETY CRITICAL COMPONENTS ONLY WITH MANUFACTURER'S RECOMMENDED PARTS.

AVERTISSEMENT:  $\Delta$  IL INDIQUE LES COMPOSANTS CRITIQUES DE SECURITE. POUR MAINTENIR LE DEGRE DE SECURITE DE L'APPAREIL, NE REMPLACER QUE DES PIECES RECOMMANDEES PAR LE FABRICANT.

NOTE  
UNLESS OTHERWISE SPECIFIED  
ALL RESISTORS IN OHMS (1/4W) (1/2W)  
ALL CAPACITORS IN  $\mu$ F 50 WV(1)

(RECEIVER)  
AA-R32/L AMP  
SCHEMATIC DIAGRAM  
NO.4-2 821030A

AA-R32

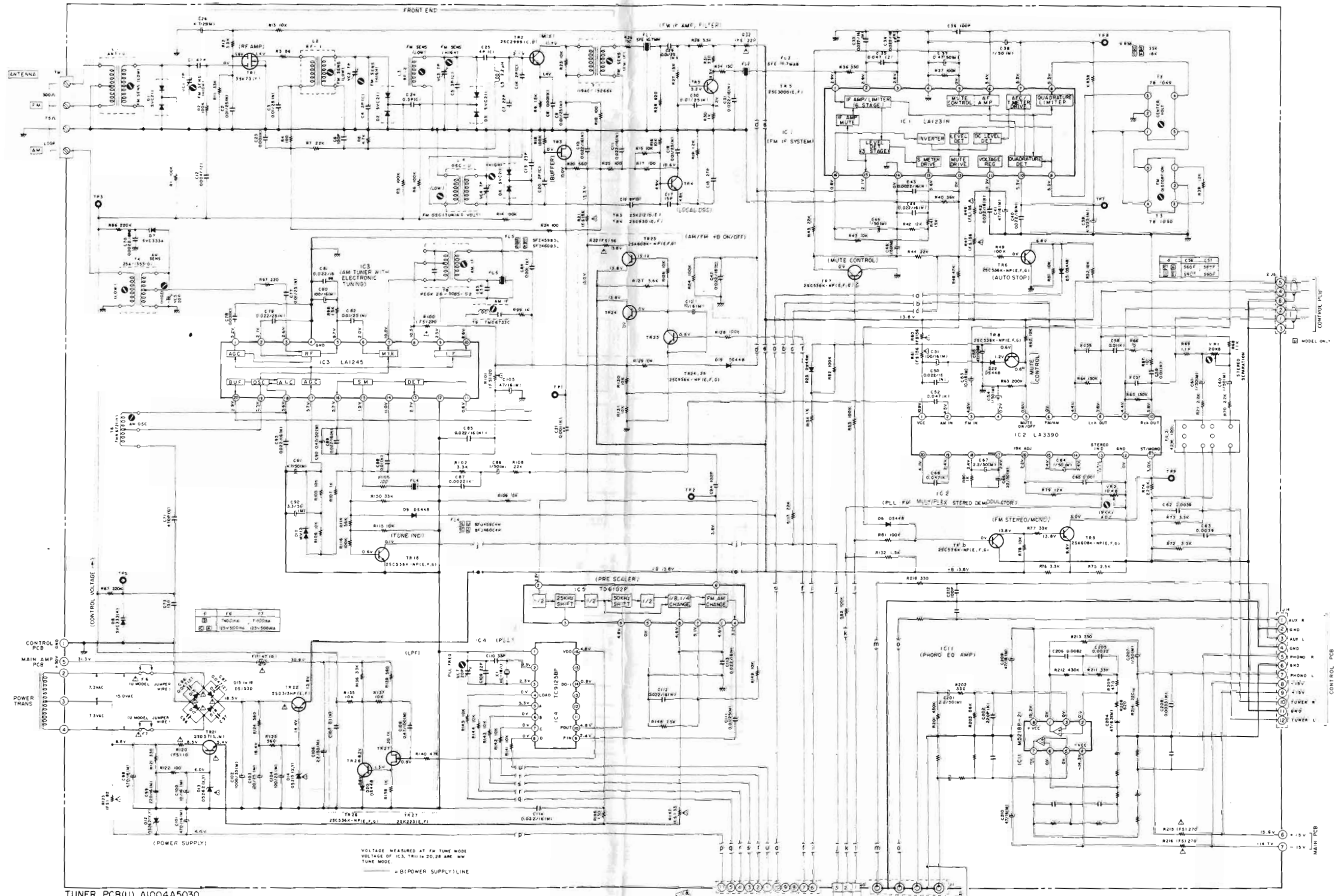

WARNING  $\Delta$  INDICATES SAFETY CRITICAL COMPONENTS FOR CONTINUED SAFETY.  
 REPLACE SAFETY CRITICAL COMPONENTS ONLY WITH MANUFACTURER'S  
 RECOMMENDED PARTS.  
 AVERTISSEMENT  $\Delta$  IL INDIQUE LES COMPOSANTS CRITIQUES DE SECURITE  
 POUR MAINTENIR LE DEGRE DE SECURITE DE L'APPAREIL.  
 NE REMPLACER QUE DES PIECES RECOMMANDEES PAR LE FABRICANT.

- $\Delta$  25K19
- $\Delta$  35K73
- $\Delta$  25K212
- $\Delta$  25K223
- $\Delta$  25C2990
- $\Delta$  25A608K-HP
- $\Delta$  25C236K-HP
- $\Delta$  25C2370
- $\Delta$  25C2370
- $\Delta$  25C1000

(RECEIVER)  
**AA-R32 TUNER**  
 SCHEMATIC DIAGRAM  
 No.4-3 821031 A

AA-R32/L

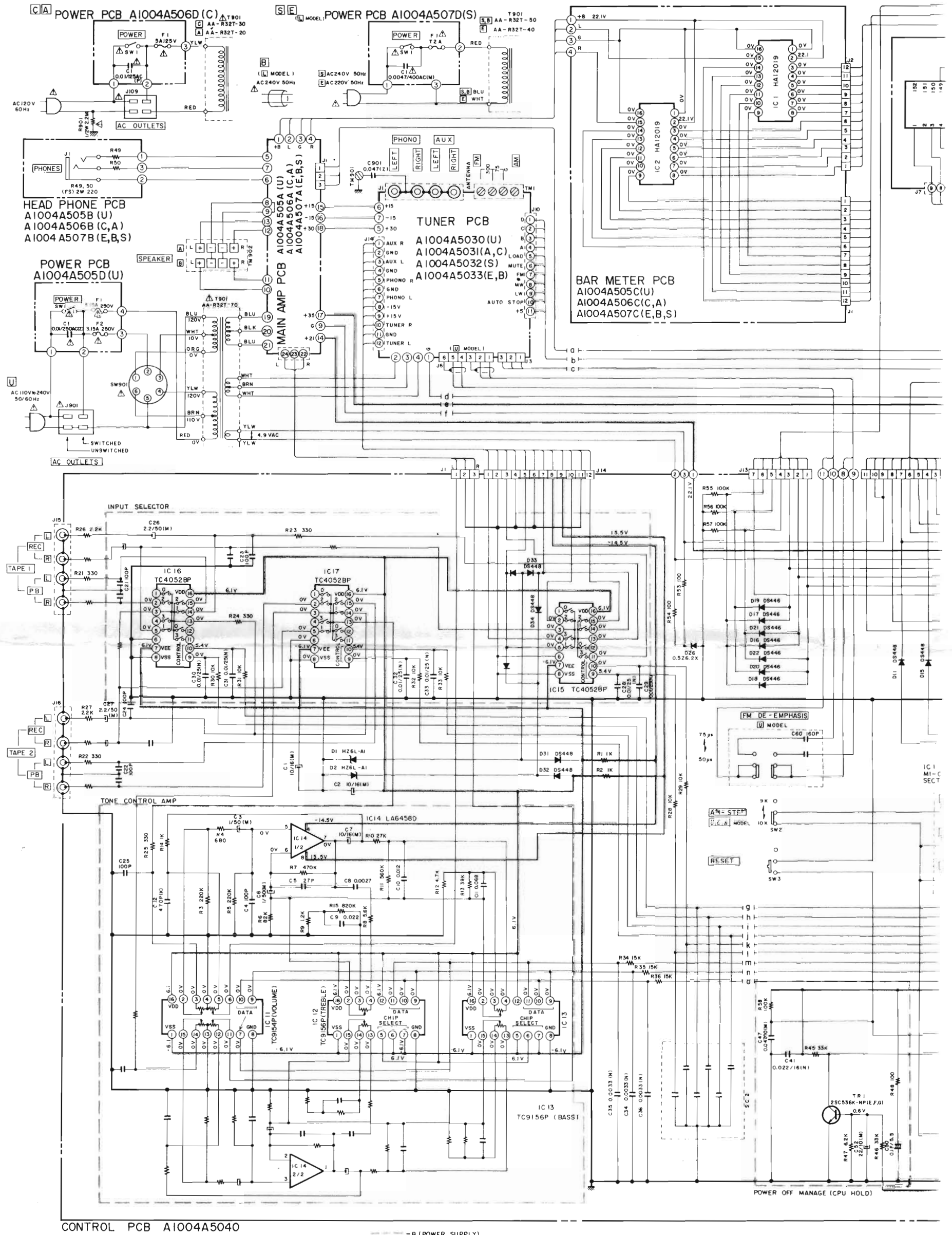

WARNING:  $\Delta$  INDICATES SAFETY CRITICAL COMPONENTS. FOR CONTINUED SAFETY, REPLACE SAFETY CRITICAL COMPONENTS ONLY WITH MANUFACTURER RECOMMENDED PARTS.

AVERTISSEMENT:  $\Delta$  IL INDIQUE LES COMPOSANTS CRITIQUES DE SÉCURITÉ. POUR MAINTENIR LE DEGRÉ DE SÉCURITÉ DE L'APPAREIL, NE REMPLACEZ QUE DES PIÈCES RECOMMANDÉES PAR LE FA

001325



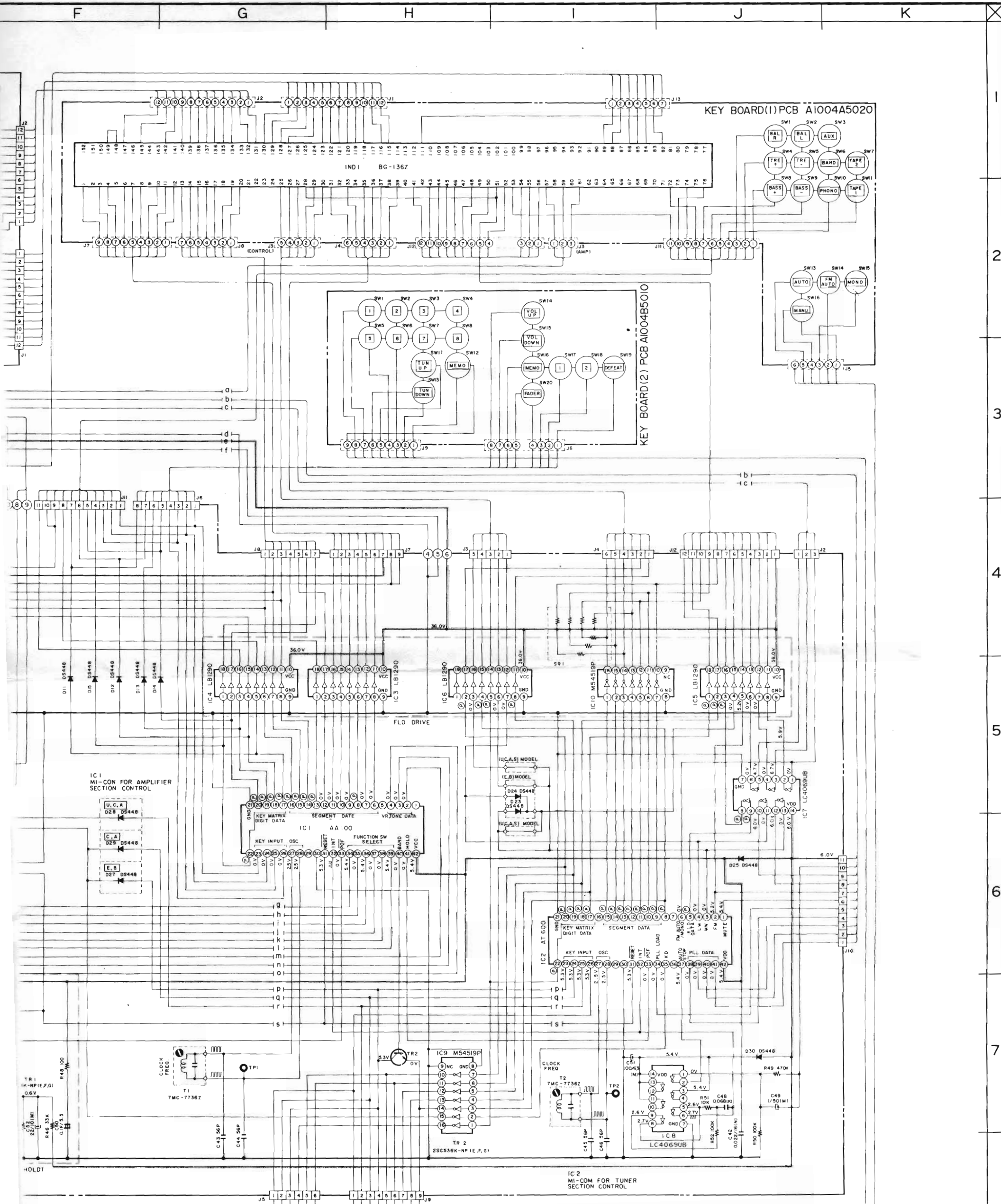

COMPONENTS FOR CONTINUED SAFETY.  
 COMPONENTS ONLY WITH MANUFACTURER'S  
 MARKING.

COMPOSANTS CRITIQUES DE SÉCURITÉ  
 UNiquement de l'appareil.  
 RECOMMANDÉES PAR LE FABRICANT

VOLTAGE MEASURED MODE:  
 AFTER DEPRESSING THE RESET BUTTON.  
 (C) INDICATES THAT TIMING PULSE WILL BE DISPLAYED

NOTE  
 UNLESS OTHERWISE SPECIFIED  
 ALL RESISTORS IN OHMS (1/4W/1J)  
 ALL CAPACITORS IN  $\mu$ F 50WV(1J)

(RECEIVER)  
 AA-R32/L CONNECTION DIAGRAM  
 NO.4-1 821029A

AA-R32L

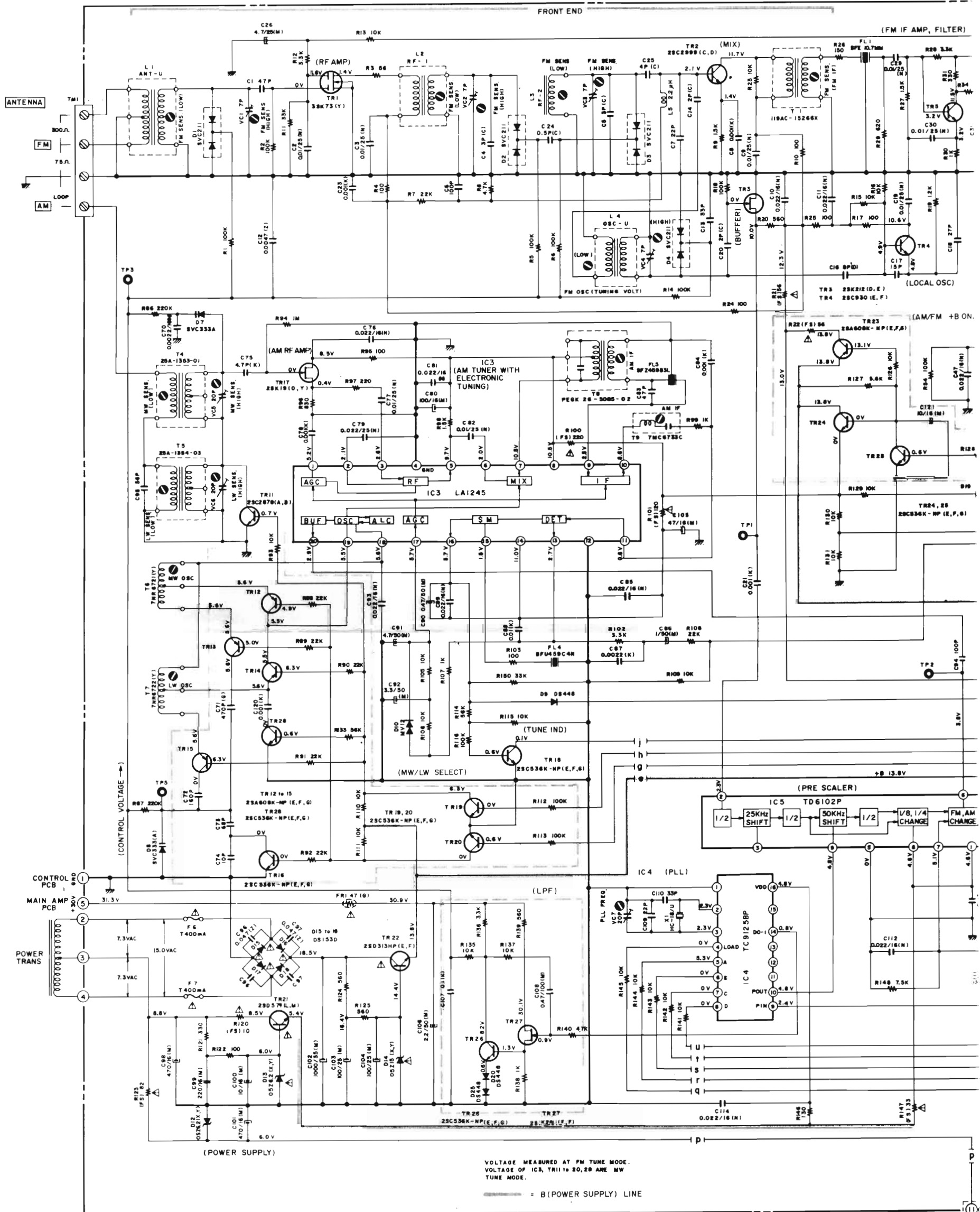

WARNING: Δ INDICATES SAFETY CRITICAL COMPONENTS. FOR CONTINUED SAFETY, REPLACE SAFETY CRITICAL COMPONENTS ONLY WITH MANUFACTURER'S RECOMMENDED PARTS.  
 AVERTISSEMENT: Δ IL INDIQUE LES COMPOSANTS CRITIQUES DE SÉCURITÉ. POUR MAINTENIR LE DEGRÉ DE SÉCURITÉ DE L'APPAREIL, NE REMPLACER QUE DES PIÈCES RECOMMANDÉES PAR LE FABRICANT.



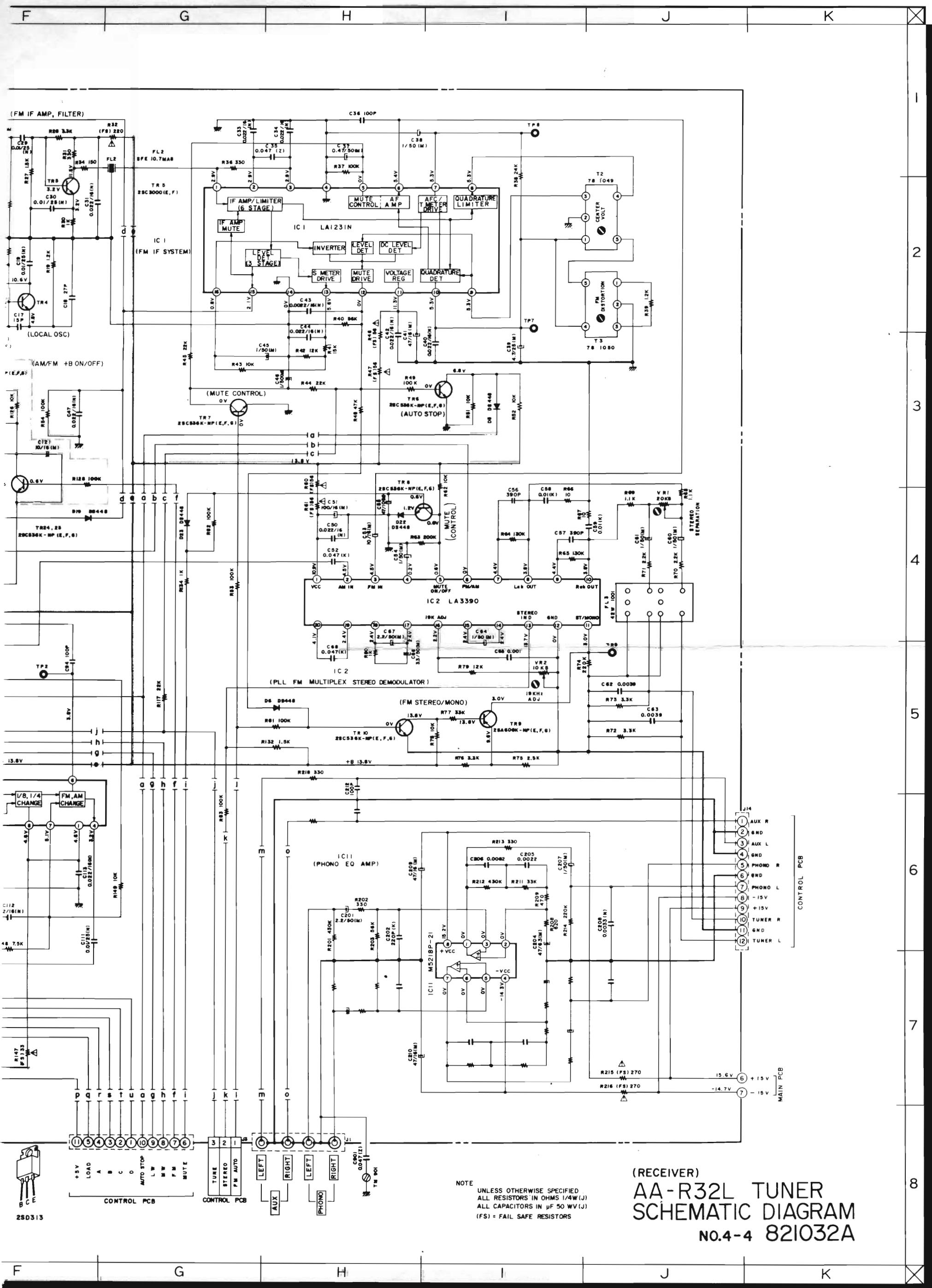

NOTE  
 UNLESS OTHERWISE SPECIFIED  
 ALL RESISTORS IN OHMS 1/4W (J)  
 ALL CAPACITORS IN pF 50 WV (J)  
 (FS) - FAIL SAFE RESISTORS

(RECEIVER)  
**AA-R32L TUNER**  
**SCHEMATIC DIAGRAM**  
 NO.4-4 821032A

1  
 2  
 3  
 4  
 5  
 6  
 7  
 8