

# AKAI SERVICE MANUAL



Free service manuals

Gratiz schema's

Digitized by

www.freeservicemanuals.info

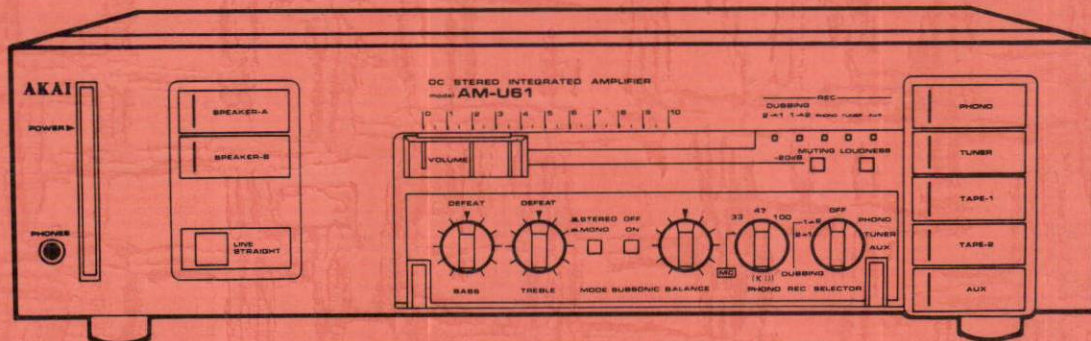
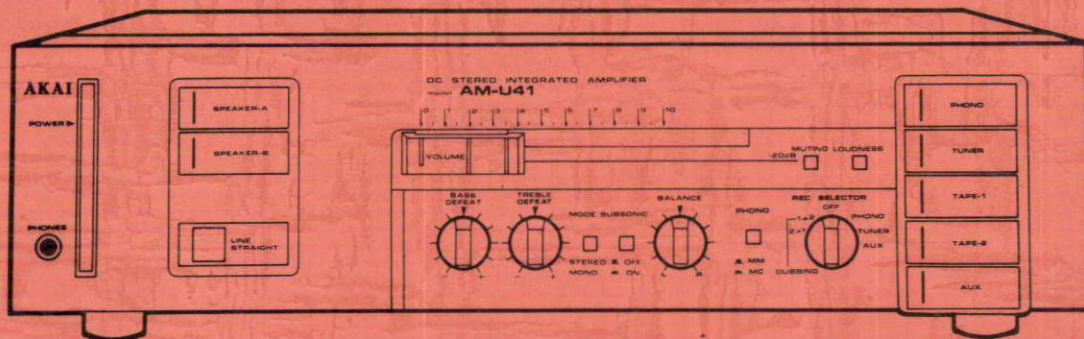
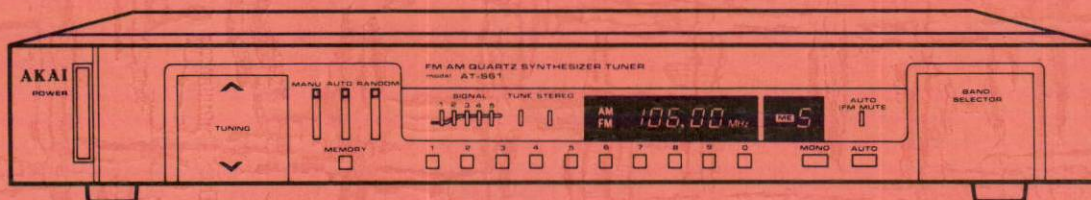

FM AM QUARTZ SYNTHESIZER TUNER

MODEL **AT-S61/L/J**

DC STEREO INTEGRATED AMPLIFIER

**AM-U41**  
MODEL **AM-U61**

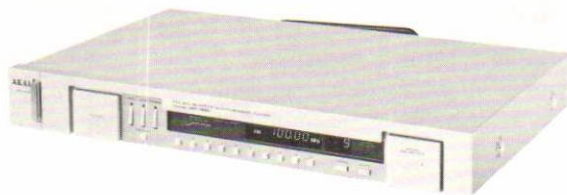

AT-S61/L/J



AM-U41

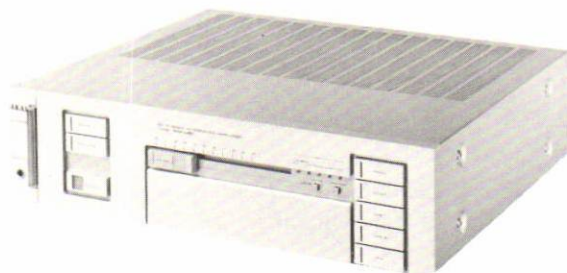

AM-U61

**FM AM QUARTZ SYNTHESIZER TUNER**

**MODEL AT-S61/L/J**

**DC STEREO INTEGRATED AMPLIFIER**

**MODEL AM-U41**

**DC STEREO INTEGRATED AMPLIFIER**

**MODEL AM-U61**

This manual is applicable to both silver and pearl shadow panel models.

**TABLE OF CONTENTS**

<b>SECTION 1</b>	<b>SERVICE MANUAL AT-S61/L/J .....</b>	<b>3</b>
<b>SECTION 2</b>	<b>SERVICE MANUAL AM-U41/AM-U61 .....</b>	<b>25</b>
<b>SECTION 3</b>	<b>PARTS LIST .....</b>	<b>47</b>
<b>SECTION 4</b>	<b>SCHEMATIC DIAGRAM .....</b>	<b>70</b>

www.freeservicemanuals.info

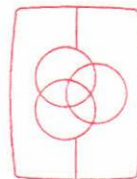

Free service manuals  
Gratis schema's  
Digitized by

## SAFETY INSTRUCTION

### SAFETY CHECK AFTER SERVICING

Confirm the specified insulation resistance between power cord plug prongs and externally exposed parts of the set is greater than 10 Mohms, but for equipment with external antenna terminals (tuner, receiver, etc.) and is intended for **C** or **A**, specified insulation resistance should be more than 2.2 Mohms (ground terminals, microphone jacks, headphone jacks, line-in-out jacks etc.)

### PRECAUTIONS DURING SERVICING

1. Parts identified by the  $\triangle$  symbol parts are critical for safety.  
Replace only with parts number specified.
2. In addition to safety, other parts and assemblies are specified for conformance with such regulations as those applying to spurious radiation. These must also be replaced only with specified replacements.  
Examples: RF converters, tuner units, antenna selector switches, RF cables, noise blocking capacitors, noise blocking filters, etc.
3. Use specified internal wiring. Note especially:
  - 1) Wires covered with PVC tubing
  - 2) Double insulated wires
  - 3) High voltage leads
4. Use specified insulating materials for hazardous live parts. Note especially:
  - 1) Insulation Tape
  - 2) PVC tubing
  - 3) Spacers (Insulating Barriers)
  - 4) Insulation sheets for transistors
5. When replacing AC primary side components (transformers, power cords, noise blocking capacitors, etc.), wrap ends of wires securely about the terminals before soldering.

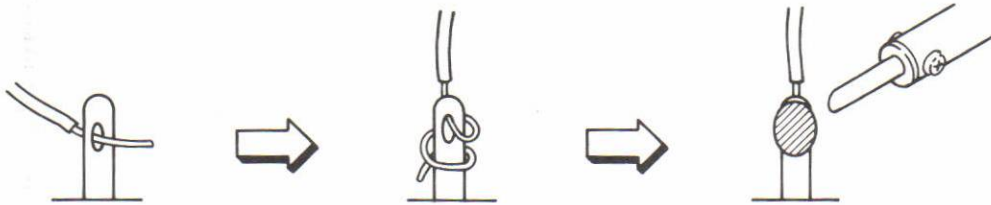

6. Observe that wires do not contact heat producing parts (heatsinks, oxide metal film resistors, fusible resistors, etc.).
7. Check that replaced wires do not contact sharp edged or pointed parts.
8. Also check areas surrounding repaired locations.
9. Use care that foreign objects (screws, solder droplets, etc.) do not remain inside the set.

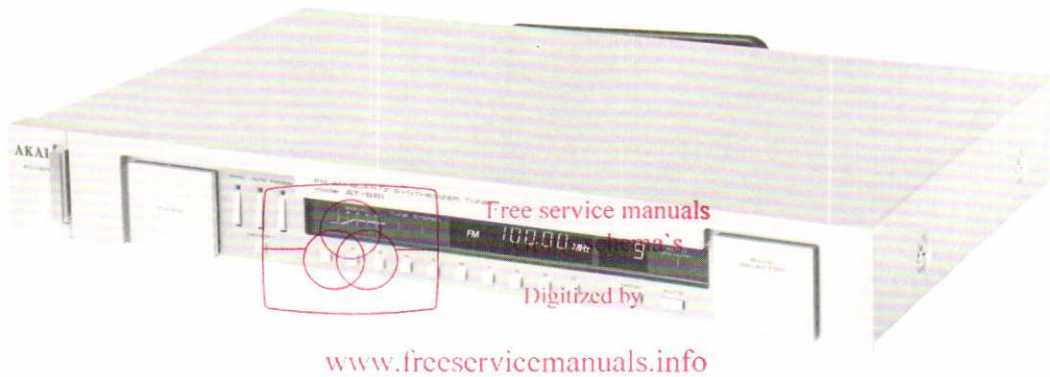

## SECTION 1

**SERVICE MANUAL****MODEL AT-S61/L/J**

This manual is applicable to both silver and pearl shadow panel models.

## TABLE OF CONTENTS

<b>I. SPECIFICATIONS .....</b>	<b>4</b>
<b>II. DISMANTLING OF UNIT .....</b>	<b>5</b>
<b>III. CONTROLS .....</b>	<b>6</b>
<b>IV. PRINCIPAL PARTS LOCATION.....</b>	<b>7</b>
<b>V. VOLTAGE CONVERSION .....</b>	<b>8</b>
<b>VI. OPERATION .....</b>	<b>9</b>
1. FM SYNTHESIZER BLOCK DIAGRAM.....	9
2. FUNCTION OF AT-600 TERMINALS.....	10
3. POWER OFF MANAGE AND RESET CIRCUIT.....	12
4. MUTE CIRCUIT OPERATION.....	12
5. STEREO NOISE REDUCTION CIRCUIT .....	13
6. AUTO STOP SIGNAL DETECTING CIRCUIT .....	14
7. KEY MATRIX.....	15
<b>VII. ELECTRICAL ADJUSTMENT.....</b>	<b>17</b>
1. AM (AT-S61L: MW) SECTION ADJUSTMENT .....	17
2. LW SECTION ADJUSTMENTS.....	18
3. FM SECTION ADJUSTMENT .....	18
<b>VIII. CLASSIFICATION OF VARIOUS P.C BOARDS .....</b>	<b>20</b>
1. P.C BOARD TITLES AND IDENTIFICATION NUMBERS.....	20
2. COMPOSITION OF VARIOUS P.C BOARDS .....	21

For basic adjustment, measuring methods, and operating principles, refer to GENERAL TECHNICAL MANUAL.

## I. SPECIFICATIONS

<b>FM TUNER SECTION</b>	
TUNING FREQUENCY RANGE	87.4 to 108.1 MHz (Except JAPAN) 76 to 90 MHz
SENSITIVITY USABLE (S/N = 30 dB, MONO) QUIETING (S/N = 50 dB, Mono/Stereo)	11.2 dBf 16.2/37.2 dBf
CAPTURE RATIO	1.0 dB
SELECTIVITY ( $\pm 400$ kHz)	75 dB
IMAGE REJECTION	95 dB
IF REJECTION	110 dB
SPURIOUS REJECTION	100 dB
AM SUPPRESSION	65 dB
SUB CARRIER SUPPRESSION	65 dB
S/N (Mono/Stereo)	78/70 dB
T.H.D. ( $\pm 75$ kHz DEVIATION, Mono/Stereo)	0.06/0.09%
STEREO SEPARATION (1 kHz)	55 dB
FREQUENCY RESPONSE	25 Hz to 15 kHz +0.5 dB, -1 dB
OUTPUT LEVEL (FM, 100% MODULATION)	550 mV
ANTENNA INPUT IMPEDANCE	75 ohms

<b>AM TUNER SECTION</b>		
	<b>AM</b>	<b>LW</b>
TUNING FREQUENCY RANGE USA AND CANADA OTHERS	(MW for AT-S61L) 530 to 1610 kHz 522 to 1611 kHz	(AT-S61L only) - 137 to 362 kHz
USABLE SENSITIVITY (LOOP)	300 $\mu$ V/m	800 $\mu$ V/m
SELECTIVITY	35 dB	40 dB
IMAGE REJECTION	45 dB	45 dB
IF REJECTION	65 dB	65 dB
S/N	40 dB	34 dB
T.H.D.	1.0%	2.0%

<b>OUTPUT SECTION</b>	
OUTPUT IMPEDANCE	3.3 k ohms

<b>OTHERS</b>	
POWER REQUIREMENTS	100V, 50/60 Hz for Japan 120V, 60 Hz for USA and Canada 220V, 50 Hz for Europe except UK 240V, 50 Hz for UK and Australia 110V/220V/240V, 50/60 Hz switchable for other countries
POWER CONSUMPTION	13W
DIMENSIONS	440 (W) $\times$ 63 (H) $\times$ 273 (D) mm (17.3 $\times$ 2.5 $\times$ 10.7 inches)
WEIGHT	3.3 kg (7.3 lbs)

\* For improvement purposes, specifications and design are subject to change without notice.

## II. DISMANTLING OF UNIT

AT-S61/L/J

In case of trouble, etc. necessitating dismantling, please dismantle in the order shown in the photographs. Reassemble in reverse order.

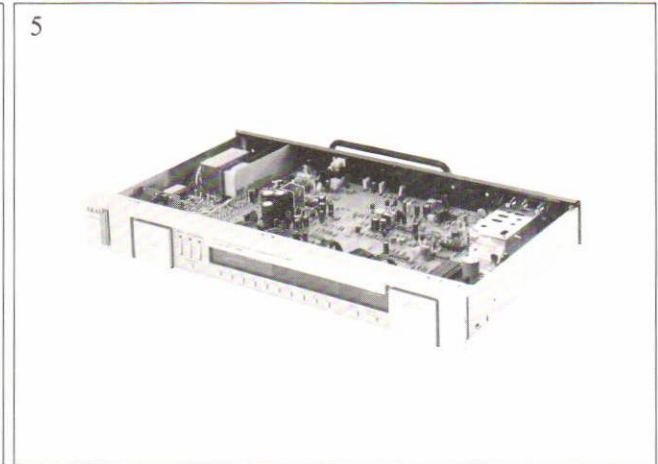
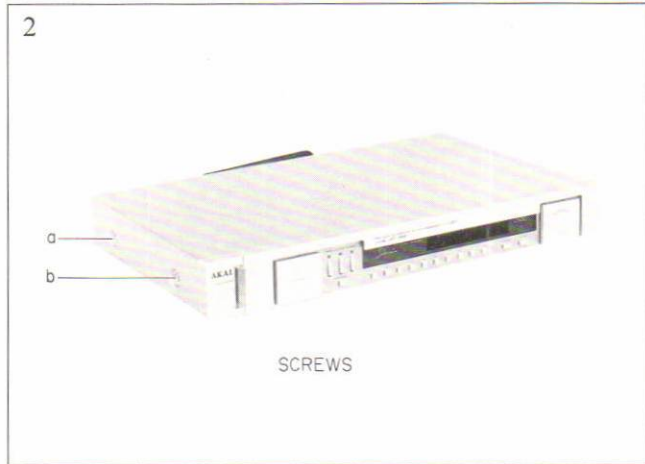
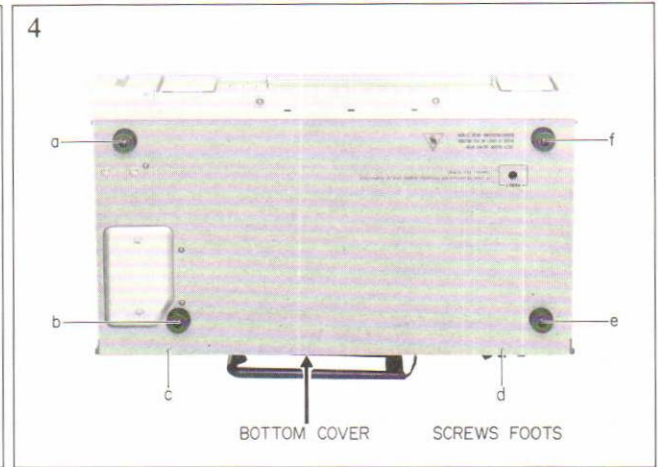
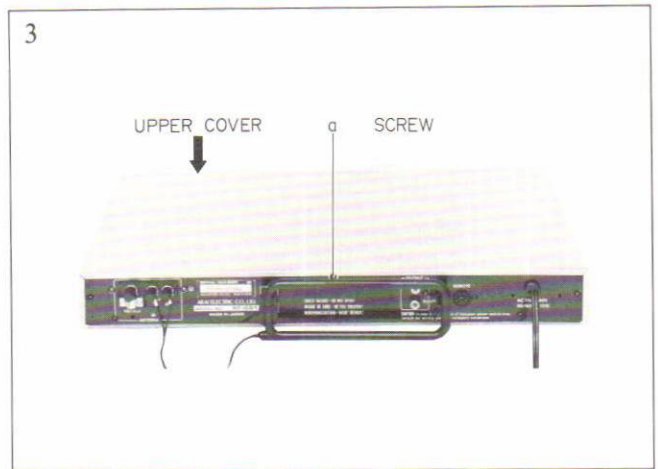
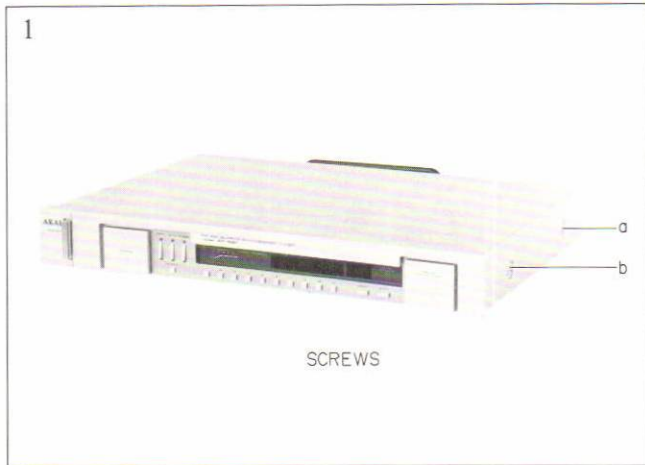

### III. CONTROLS

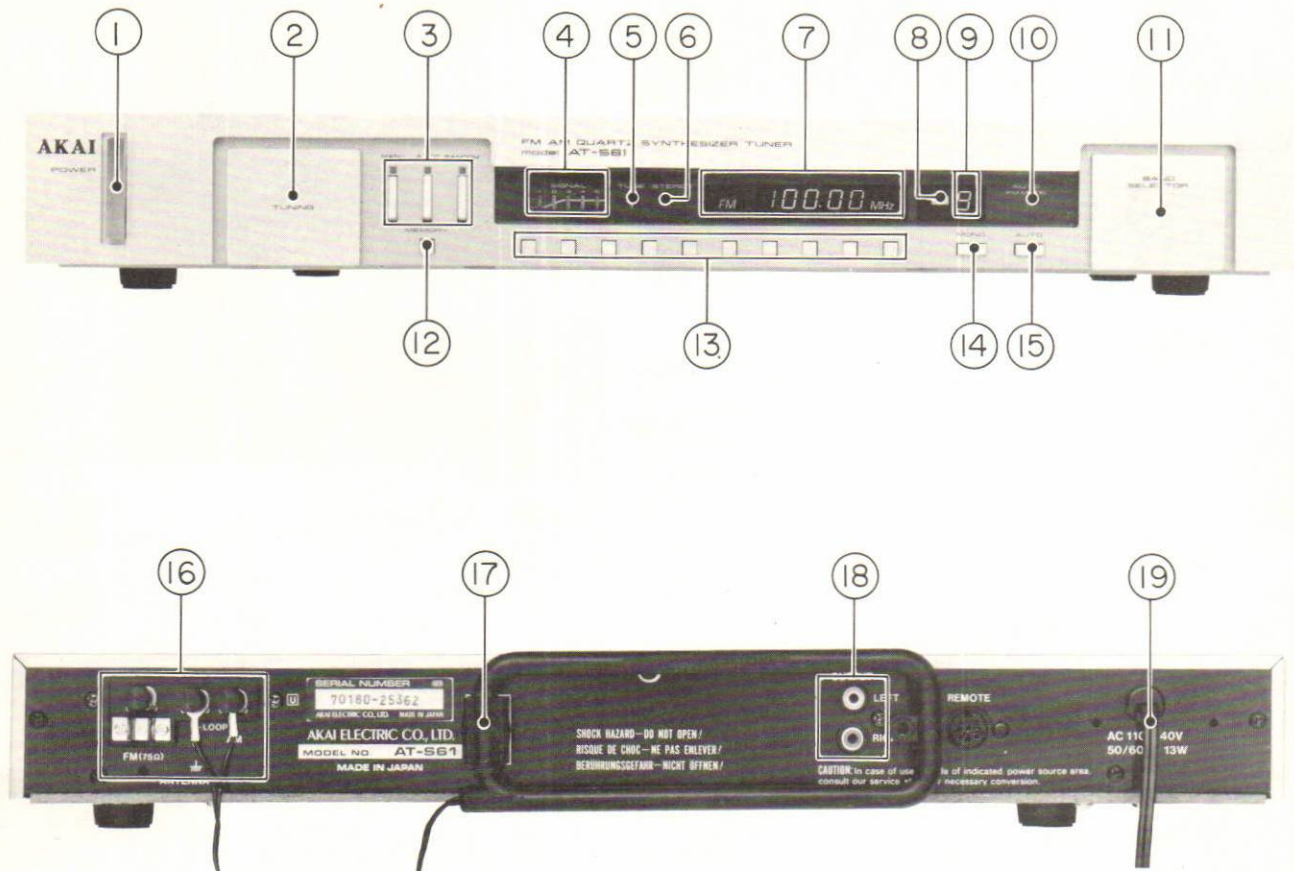
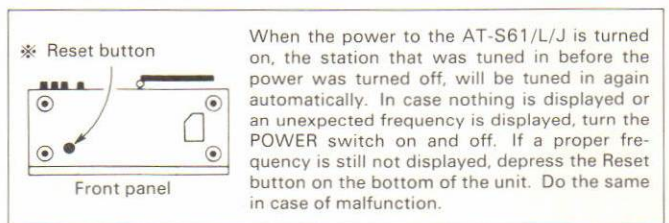

Fig. 1 Controls

1. POWER SWITCH
2. TUNING BUTTON
3. TUNING MODE BUTTONS WITH INDICATORS
4. SIGNAL STRENGTH INDICATORS
5. TUNE INDICATOR
6. STEREO INDICATOR
7. DIGITAL FL DISPLAY
8. MEMORY (ME) INDICATOR
9. PRESET STATION NUMBER DISPLAY
10. AUTO (FM MUTE) INDICATOR
11. BAND SELECTOR
12. MEMORY BUTTON
13. PRESET STATION BUTTONS
14. MONO BUTTON  
(CAL TONE BUTTON JAPAN Model)
15. FM AUTO BUTTON  
(MODE SELECTOR JAPAN Model)
16. FM, AM AND AM LOOP ANTENNA TERMINALS
17. AM LOOP ANTENNA HOLDER
18. OUTPUT JACKS
19. REMOTE JACK
20. POWER CORD



# IV. PRINCIPAL PARTS LOCATION

AT-S61/L/J

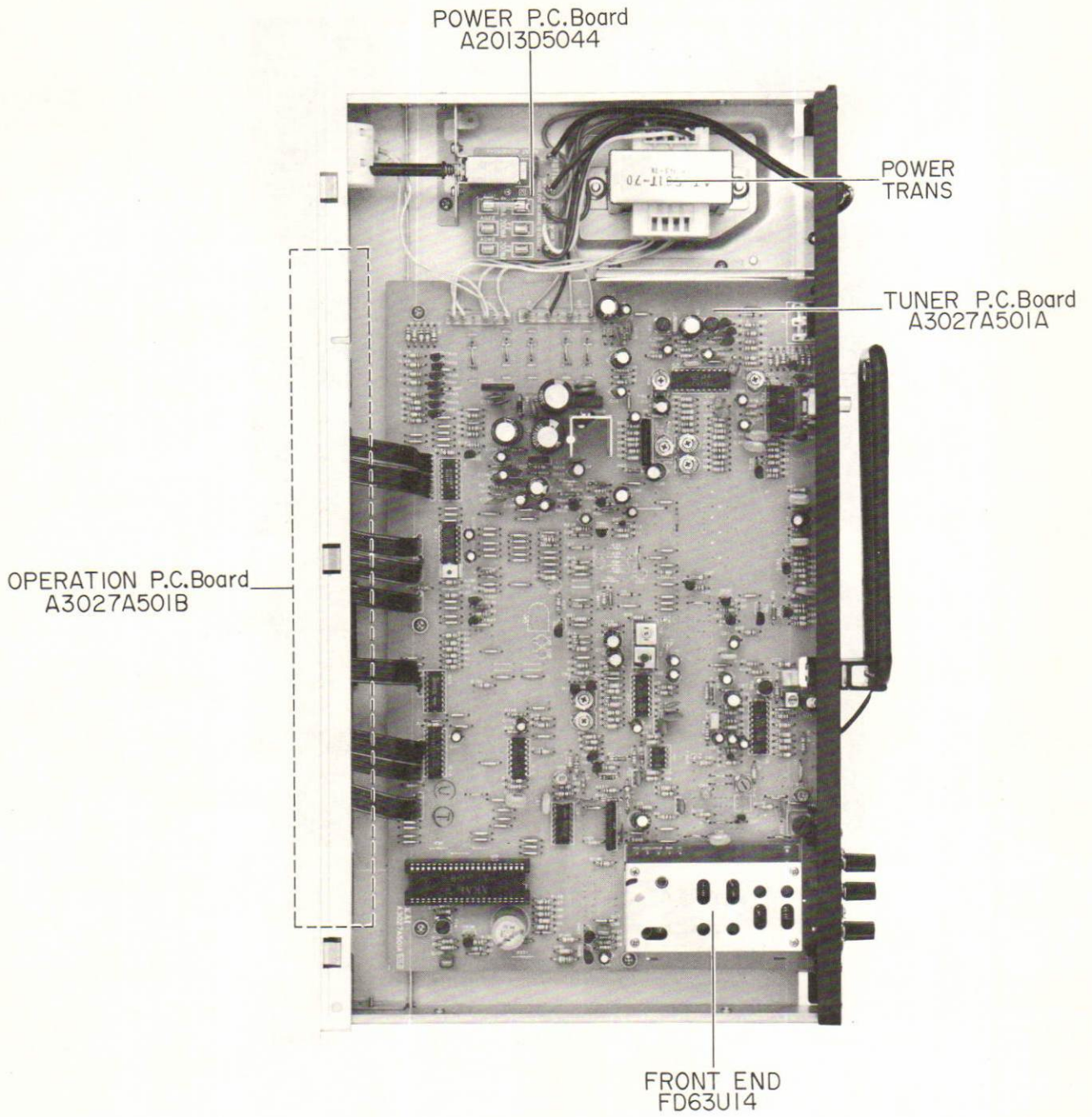
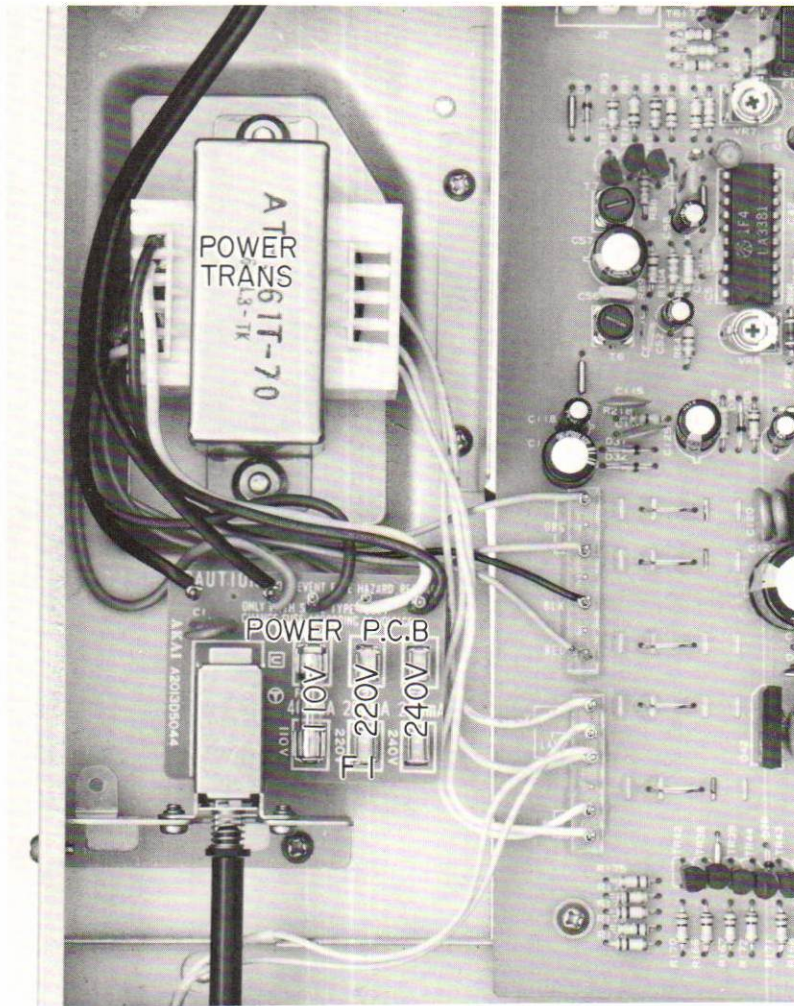

Fig. 2 Top View



## V. VOLTAGE CONVERSION



110V AREA :	250V 400mA
220V AREA :	250V 200mA
240V AREA :	250V 200mA

Fig. 3 Voltage Conversion (U Model Only)

Models for Japan, Canada, USA, Europe, UK and Australia are not equipped with this facility.

Each machine is preset at the factory according to destination, but some machines can be set to 110V, 220V or 240V as required. If voltage change is necessary, this can be accomplished as follows.

1. Disconnect the power cord.
2. Loosen the holding screws and remove the top panel.
3. Remove the Line Voltage Fuse and insert the required Line Voltage Fuse onto the proper Fuse Holder, explicitly following the printed instructions.

# VI. OPERATION

AT-S61/L/J

## 1. FM SYNTHESIZER BLOCK DIAGRAM

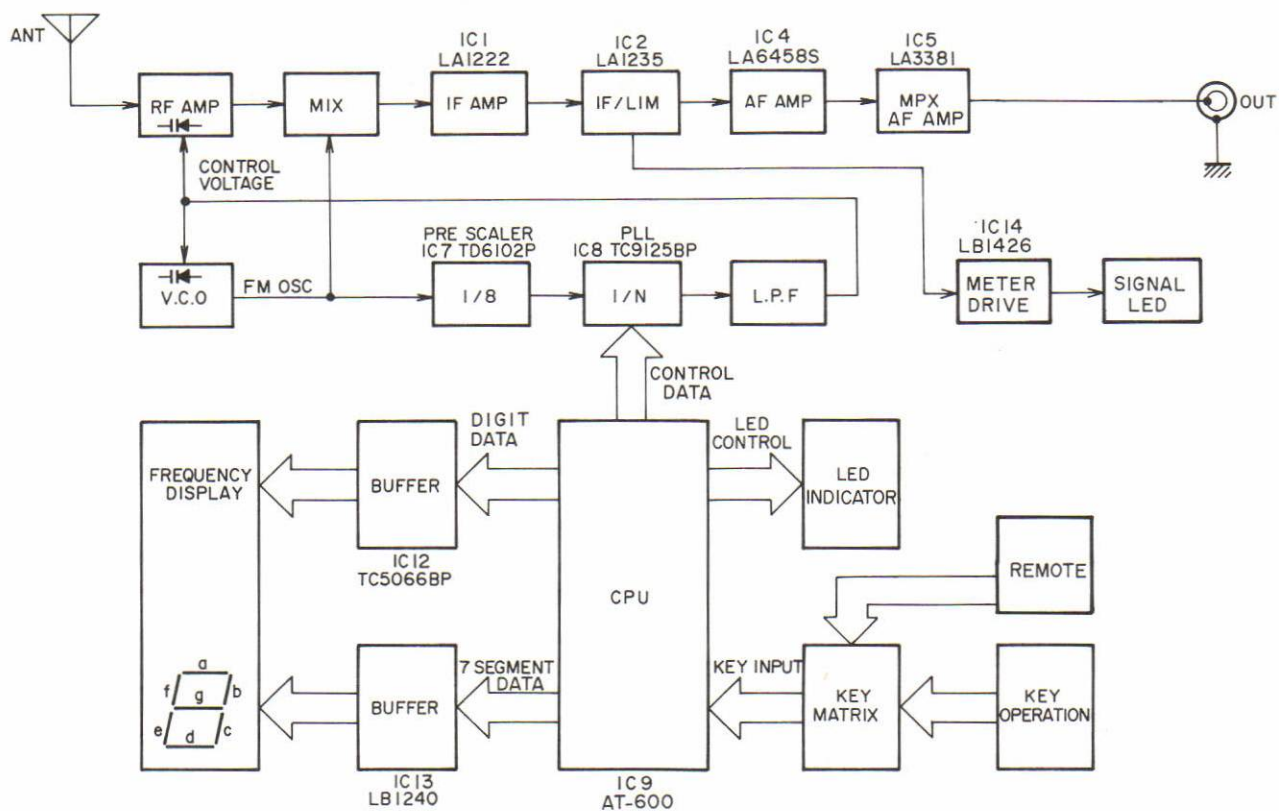
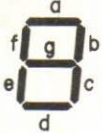

Fig. 4 FM Synthesizer Block Diagram

## 2. FUNCTION OF AT600 TERMINALS

No.	Terminal Description	Function
1	MUTING	H = Muting OFF L = Muting ON
2	FM	H = FM L = MW (AM) or LW
3	MW	H = MW (AM) L = FM or LW
4	LW	H = LW L = FM or MW
5	LED DATA	Light up the LED of MANUAL, AUTO, RANDOM
6	K1 SIGNAL	(1) EXCEPT JAPAN K1 SIGNAL becomes "H" when MONO KEY is depressed, and K1 SIGNAL becomes "L" when AUTO KEY is depressed. K2 SIGNAL is always "L". (2) JAPAN MODEL
7	K2 SIGNAL	K1 SIGNAL is reversed every time MODE KEY is depressed ("H" at MONO), and K2 SIGNAL is reversed every time CAL TONE KEY is depressed ("H" when CAL TONE is ON). When K2 SIGNAL is "H", CAL is displayed on FREQUENCY DISPLAY, and all tuning modes are released. Therefore, any input other than the inputs by CAL TONE KEY and MODE KEY are not mode.
9	a	 <p>Frequency Display Segment Data</p>
10	b	
11	c	
12	d	
13	e	
14	f	
15	g	
16		
8	T6	<b>TIMING CONTROL</b> { Display Digit Select Key Matrix Led Select
17	T5	
18	T4	
19	T3	
20	T2	
22	T1	
21	GND	
23	K1	<b>KEY Input</b> Input...ACTIVE LOW
24	K2	
25	K3	
26	K4	
27	XIN	Connect a OSC Coil.
28	XOUT	
29	CK	CAL TONE Signal (Japan Model only)
30	TEST	
31	RESET	ACTIVE LOW → Reset
32	INT	Interrupt Signal
33	POF	Power OFF manage.
34	PLL LOAD	PLL Load Signal
35	KD	Lock SW input. (Refer to KEY Matrix)
36	NC	
37	AUTO STOP	L = AUTO STOP
38	D	<b>PLL Frequency Data</b>
39	C	
40	B	
41	A	
42	VDD	Power terminal +5V

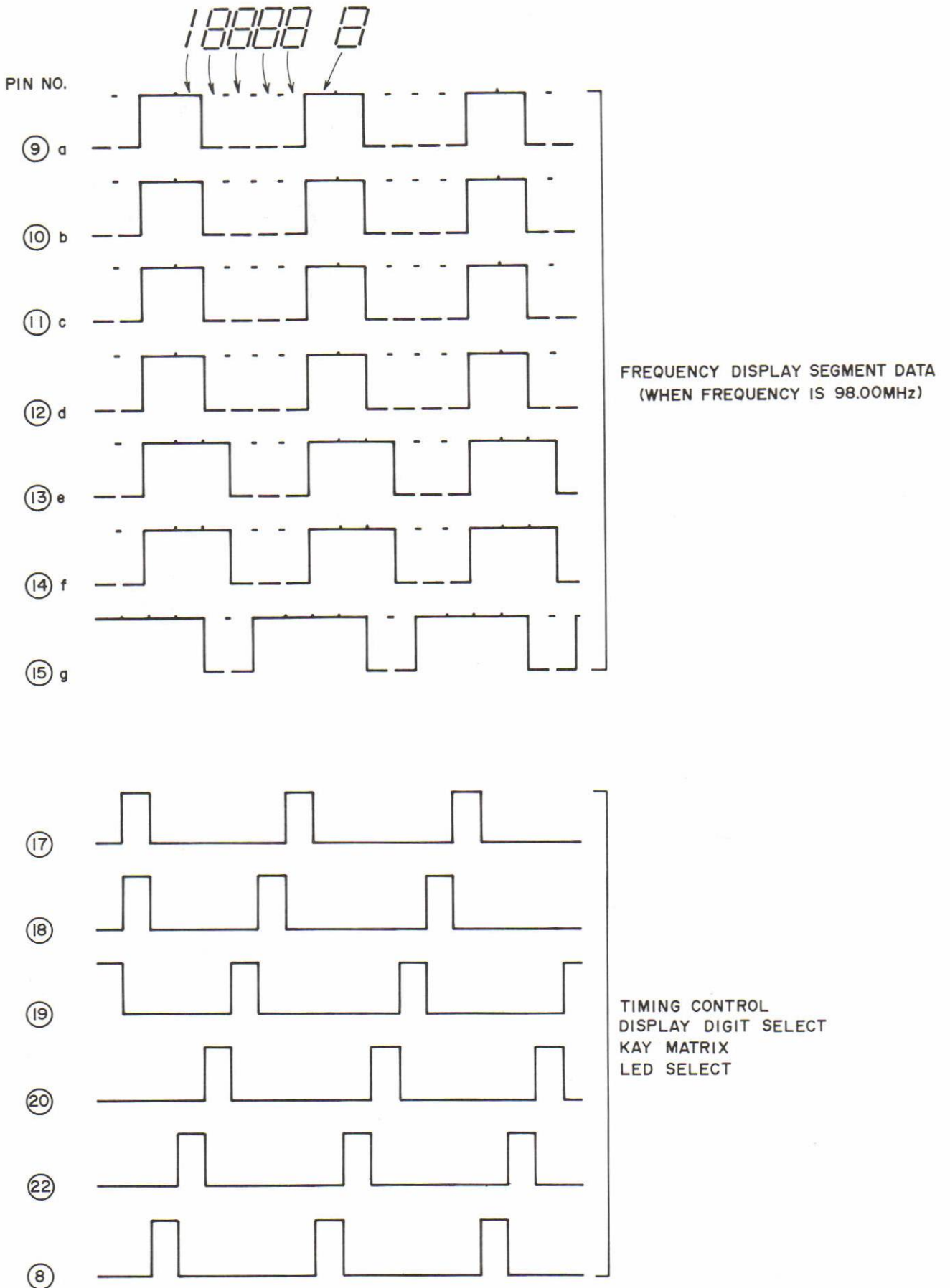

Fig. 5 Waveform of IC9 (AT-600)

### 3. POWER OFF MANAGE AND RESET CIRCUIT

- 1) If power is ON, TR36 is turned ON. At the same time, C106 is charged through D21 and R221. If power is OFF, TR36 is turned OFF, and IC9 ③ becomes "H" by the electric charge of C106 and CPU is set to Hold.
- 2) Memory by Super Capacitor (C106, 0.22F) can be stored for about 20 days.
- 3) If power is ON while Super Capacitor is discharged, malfunction may be caused. In such a case, depress RESET Button (SW1) to reset Mi-Com. Reset operation should be performed while power is ON.

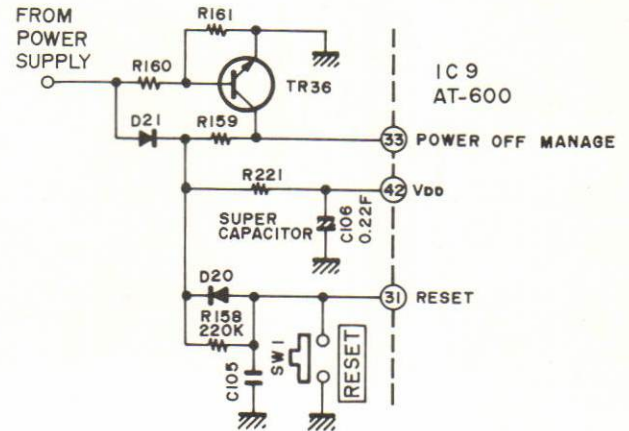

Fig. 6

### 4. MUTE CIRCUIT OPERATION

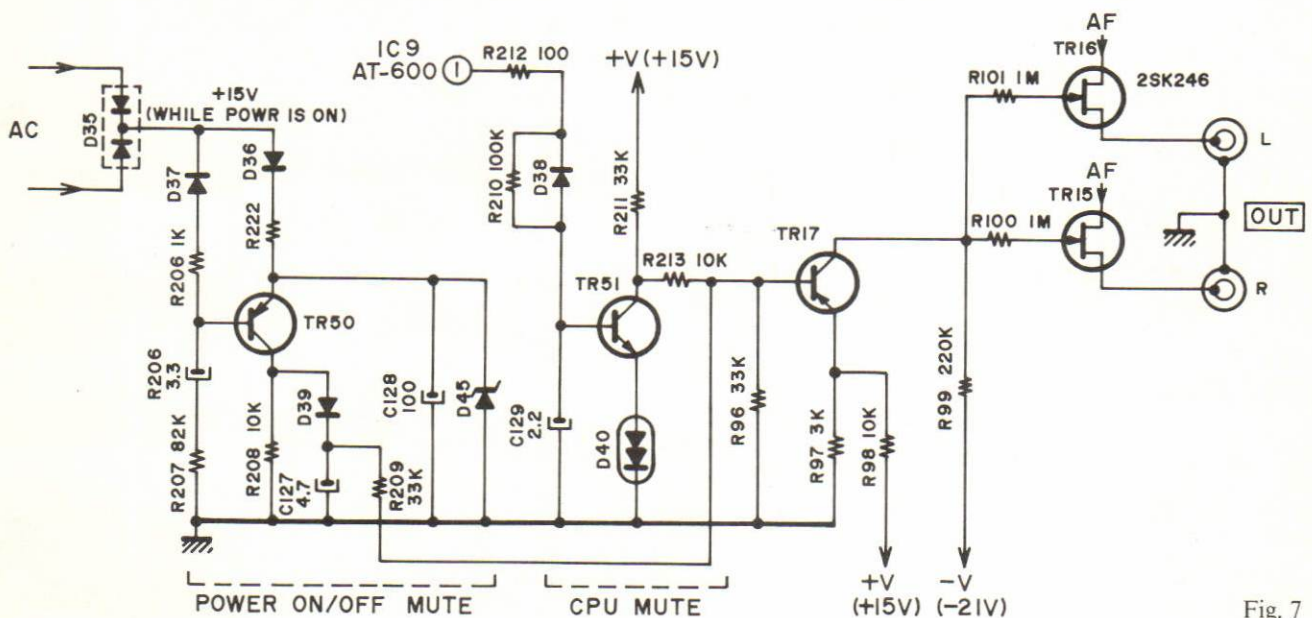

Fig. 7

AT-S61 has two mutes, one at the power ON/OFF operation, and the other by the signal from CPU IC (AT-600).

- 1) When the power switch is turned ON, the DC voltage rectified by D35 is applied to TR50 through D36 and R222. Since TR50 is kept ON until C126 is charged by base current, + voltage is applied to the base of TR17 through D39 and R209. As the base potential of TR17 becomes higher than that of the emitter, it is turned OFF. As - voltage is applied to Gate, TR15 and TR16 are turned OFF and AF signal is not sent to the output terminal. When the charging of C126 is completed, AF signal is output after TR50 → OFF, TR17 → ON and TR15 and TR16 → ON.
- 2) When the power switch is turned OFF, the potential of D35 is lowered faster than other power sources (+15, -21V) since the rectified output of D35 has no smoothing condenser. Moreover, as C126 discharges through R206 and D37, the base potential of TR50 is lowered. On the other hand, the emitter of TR50 comes to have a higher potential due to the electric charge C128, thus causing TR50 to be turned ON. Afterwards, as in the case where power is ON, TR17 → OFF, TR15 and TR16 → OFF, and AF signal is not output. This operation ends when the discharging of C128 is completed.
- 3) Terminal ① of IC9 (AT-600) is "H" at the time of normal reception. At time, TR51 is ON → TR17: ON → TR15 and TR16: ON, and AF signal is output from Line Out.
- 4) Terminal ① of IC9 (AT-600) becomes "L" during scanning when Preset Station Key is depressed at the time of Random Tuning and when Band Selector is depressed. At this time, the base bias is not applied to TR51 and it is turned OFF, while the base potential of TR17 becomes higher than that of the emitter to turn TR17 OFF. On the other hand, minus bias is applied to TR15 and TR16 to turn them OFF, and AF signal is not output.

## 5. STEREO NOISE REDUCTION CIRCUIT

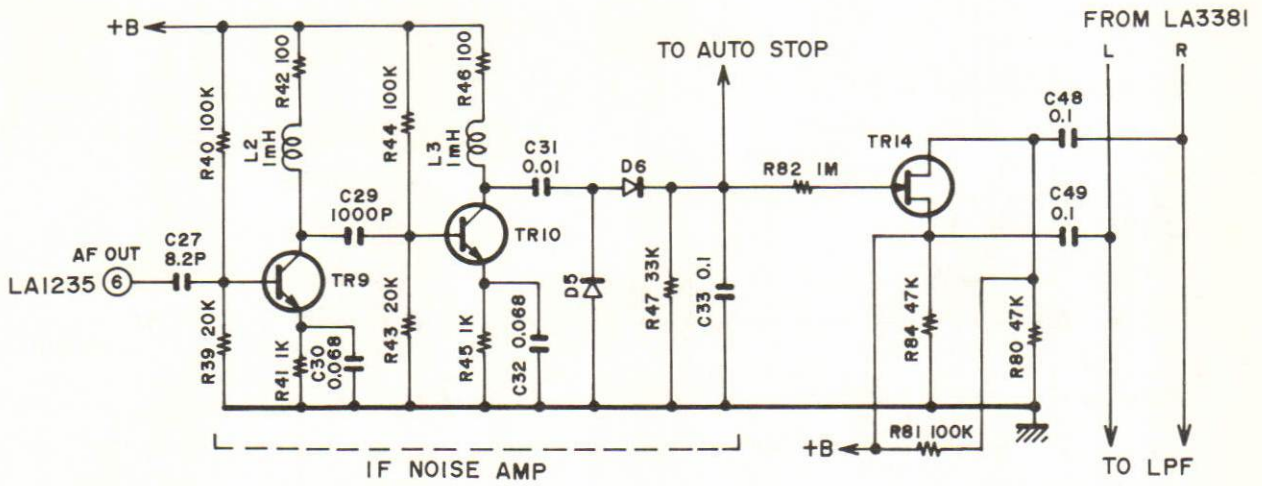

Fig. 8

The noise amplifier is a narrow-band amplifier that amplifies the frequency component of more than 100 kHz, and transforms the output into DC.

To prevent the noise containing a high-band component from increasing at the time of weak electric field, the gate potential of FET is controlled by amplifying the noise and transforming it into DC. Thus, the L-R separation can be deteriorated intentionally to reduce the noise.

## 6. AUTO STOP SIGNAL DETECTING CIRCUIT

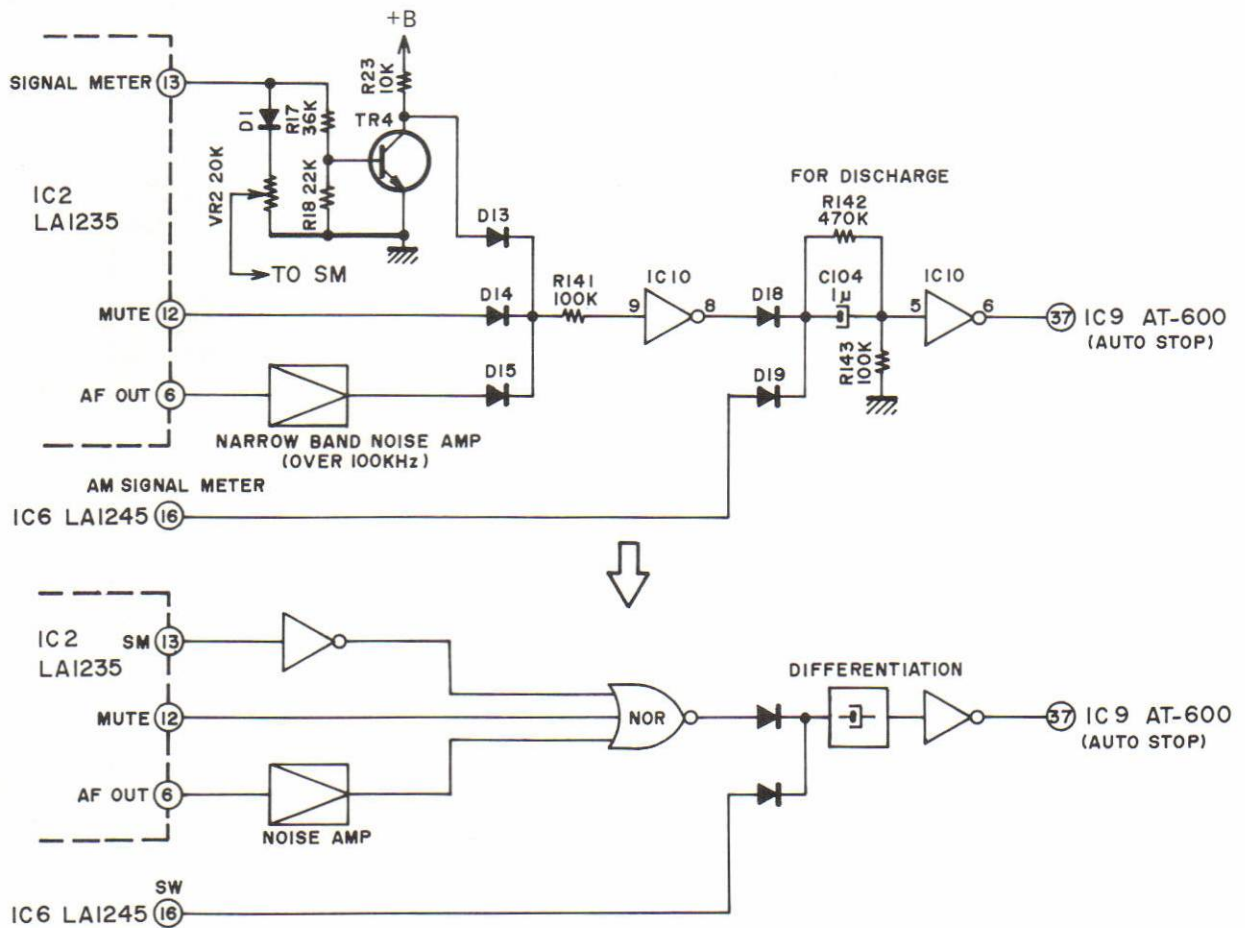

Fig. 9

- 1) During scanning in FM mode IC2 ⑬ is "L" and IC2 ⑫ is "H", and the output of Noise Amp. becomes "H" due to the detuning noise. Since NOR Gate consisting of diode and inverter performs "H" output only when all the inputs are "L", the present output is "L". If a broadcast is received, ⑬ becomes "H", ⑫ becomes "L" and the output of Noise Amp. becomes "L" since detuning noise disappears. Therefore, all the inputs of NOR Gate becomes "L" and the output becomes "H". "H" output of NOR Gate is differentiated and reversed to make ⑳ terminal of IC9 (AT-600) "L" and stop scanning. IC6 ⑯ is always "L" in FM mode. Auto Stop Signal in AM mode uses the signal meter output of IC6 ⑯. IC6 ⑯ is "H" at the time of broadcast reception and is "L" on other occasions. Since IC2 ⑬ is always "H" in AM mode, the output of NOR Gate is "L".

7. KEY MATRIX

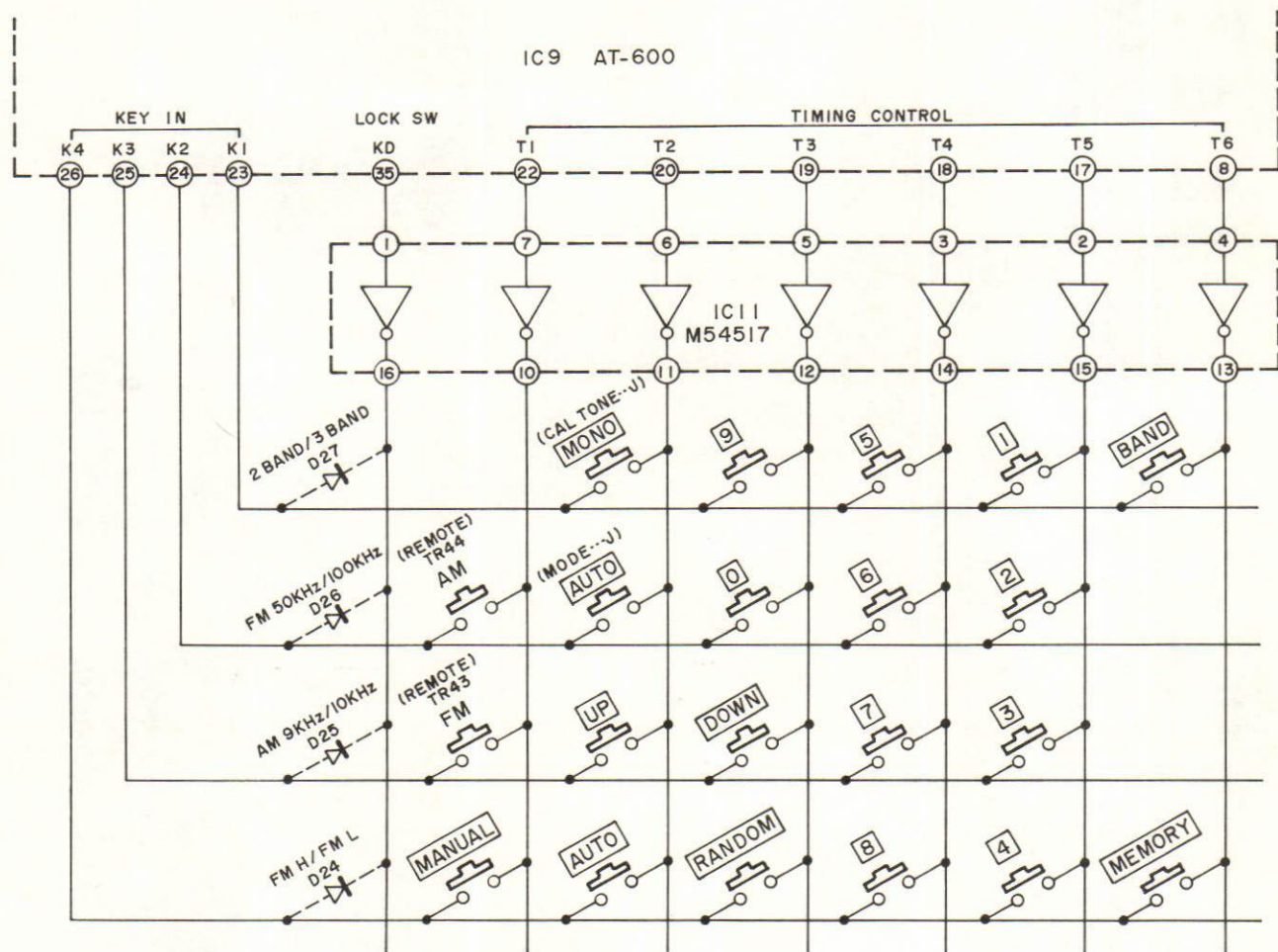

Fig. 10

Destination	AM	FM	Connected Diode
J	522 ~ 1611 kHz ( 9 kHz STEP)	76.00 ~ 90.00 MHz (100 kHz STEP)	D24
C, A	530 ~ 1610 kHz (10 kHz STEP)	87.40 ~ 108.10 MHz (100 kHz STEP)	D25, D26
U, E, S, V	522 ~ 1611 kHz ( 9 kHz STEP)	87.40 ~ 108.10 MHz ( 50 kHz STEP)	None
L BAND	LW 137 ~ 362 kHz (10 kHz STEP) MW 522 ~ 1611 kHz ( 9 kHz STEP)	87.40 ~ 108.10 MHz ( 50 kHz STEP)	D27



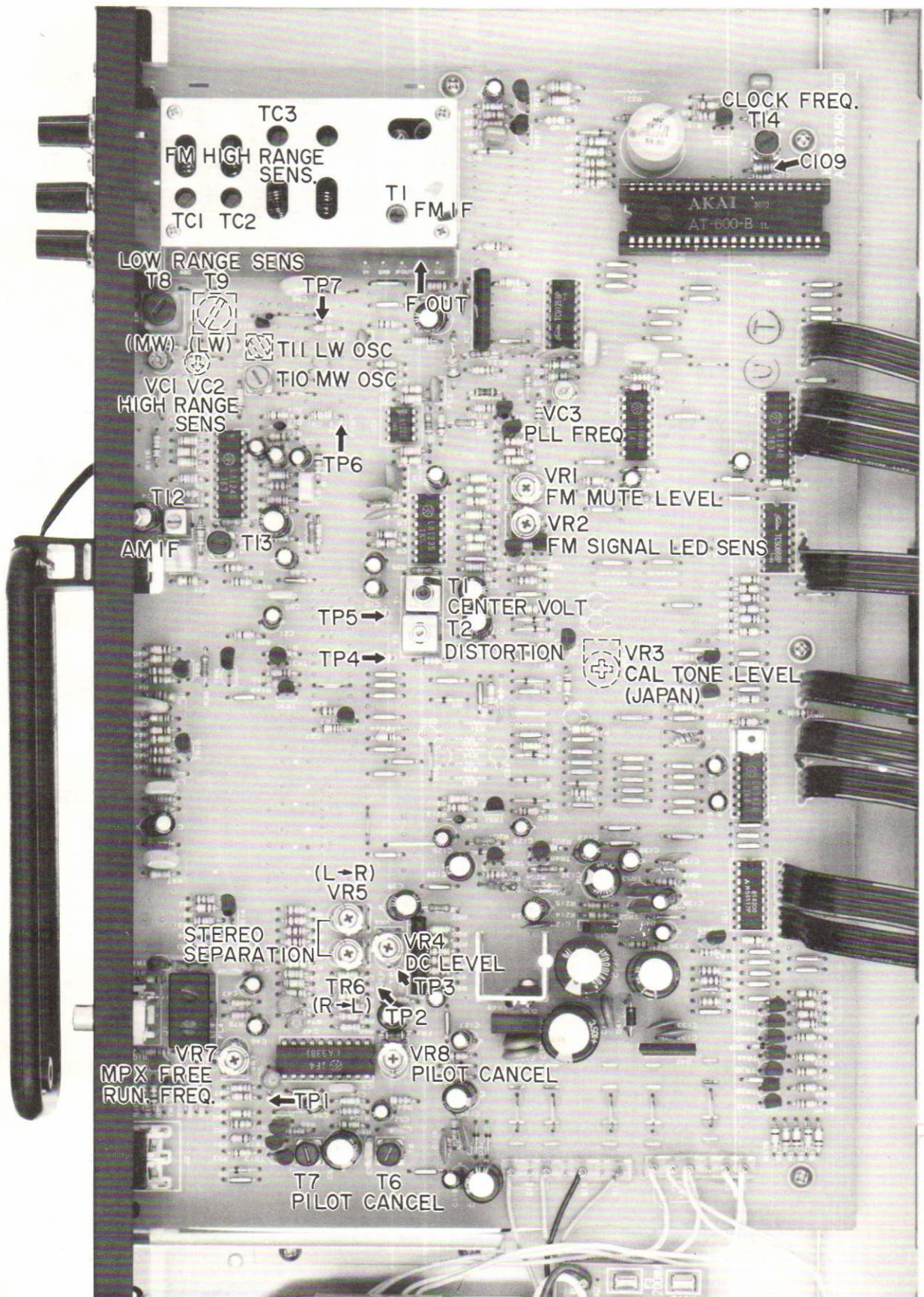

Fig. 11 Tuner P.C Board

## VII. ELECTRICAL ADJUSTMENT

AT-S61/L/J

### 1. AM (AT-S61L: MW) SECTION ADJUSTMENT (Refer to Fig. 4)

Unless otherwise specified, use the adjustment points provided on the Tuner P.C Board. (Fig. 4)

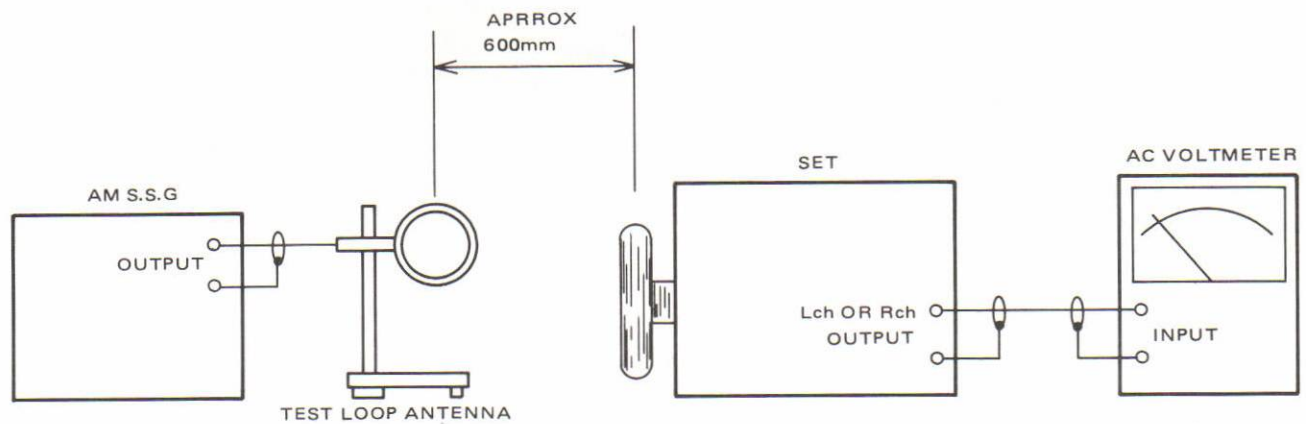
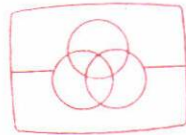

Fig. 12 Instrument Connections for AM Section Adjustment



Free service manuals

Gratis schema's

Digitized by

www.freeservicemanuals.info

STEP	ADJUSTMENT ITEM	ADJUSTMENT POINT	RESULT	REMARKS
1	Clock Frequency	T14 (BLK)	420 kHz	Connect a Frequency Counter between C109 (IC9 Pin 28) and GND on the Tuner P.C Board.
2	PLL Frequency	VC3	Digital Display Indicating Frequency +10.7 MHz	BAND switch to FM. Connect a Frequency Counter between F. OUT and GND on the FRONT END.
3	AM (MW) OSC	T10 (RED)	705 kHz	BAND switch to AM (MW). Short TP7 to GND and connect a Frequency Counter between TP6 and GND on the Tuner P.C Board.
4	OP. AMP. DC Level	VR4	4.80V	BAND switch to AM (MW). Connect a DC Voltmeter between TP3 and GND on the Tuner P.C Board.
5	AM IF Coil	T12 (YLW) T13 (BLK)	Maximum Output	1,000 kHz (1,008 kHz), 50 dB, 400 Hz (30%) input.
6	Low Range Sensitivity	T8	Maximum Output Distortion Factor: Less than 10%	600 kHz (603 kHz), 55 dB, 400 Hz (30%) input.
7	High Range Sensitivity	VC1	Maximum Output Distortion Factor: Less than 10%	1,400 kHz (1,404 kHz), 55 dB, 400 Hz (30%) input.
8				Readjust in Steps 6 and 7.

## 2. LW SECTION ADJUSTMENT (AT-S61L only)

STEP	ADJUSTMENT ITEM	ADJUSTMENT POINT	RESULT	REMARKS
1	LW OSC	T11	525 kHz	BAND switch to LW. Short TP5 to GND and connect a Frequency Counter between TP6 and GND on the Tuner P.C Board.
2	Low Range Sensitivity	T9	Maximum Output Distortion Factor: Less than 10%	164 kHz, 50 dB, 400 Hz (30%) input. (Refer to Fig. 5)
3	High Range Sensitivity	VC2	Maximum Output Distortion Factor: Less than 10%	308 kHz, 50 dB, 400 Hz (30%) input. (Refer to Fig. 5)

## 3. FM SECTION ADJUSTMENT

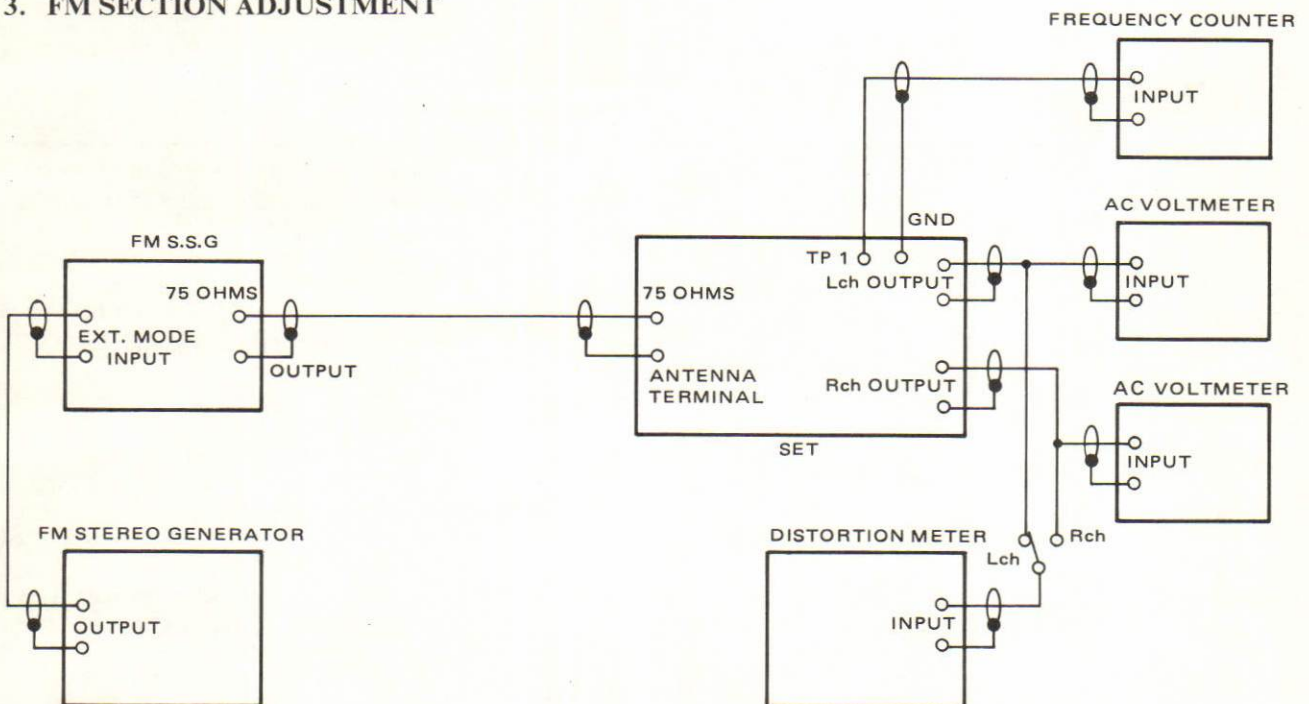

Fig. 13 Instruments Connection for FM Section Adjustment

STEP	ADJUSTMENT ITEM	ADJUSTMENT POINT	RESULT	REMARKS
1	FM IF Coil	T1 (BLK) (Front End)	Maximum Noise Level	BAND switch to FM, and MODE to MONO. Tunes only noise without interference from broadcasting.
2	Center Voltage	T1	Centered Tuning Meter Indication	Connect a Center Tuning Meter between TP4 and TP5 (See Note 1). Tunes only noise without interference from broadcasting.
3	Distortion Factor	T2	Distortion Factor: Less than 0.2%	98 MHz (84 MHz), 60 dB, 1 kHz (Mono 100%) input Less than 0.2% in both channels.
4				Readjust in Steps 2 and 3.
5	MPX Free Running Frequency	VR7	76 kHz $\pm$ 50 Hz	Connect a Frequency Counter between TP1 and GND on the Tuner P.C Board.
6	High Range Sensitivity	TC1, TC2 TC3 (Front End)	Distortion Factor: Less than 3%	MODE switch to MONO. 108 MHz (88 MHz), Less than 6 dB, 1 kHz, (MONO) input.
7	Confirmation of Low Range Sensitivity		Distortion Factor: Less than 3%	88 MHz (76 MHz), Less than 6 dB, 1 kHz, (MONO) input. (See Notes 2, 3)
8	Pilot Signal Cancel	VR8 (T6, T7)	Minimum Output	MODE switch to STEREO. 98 MHz (84 MHz), 60 dB (Stereo), Pilot signal only input.
9	Stereo Separation (Left $\rightarrow$ Right)	VR5	More than 45 dB	98 MHz (84 MHz), 60 dB, 1 kHz (Stereo 100%) Lch input. Minimum Output of Rch.
10	Stereo Separation (Right $\rightarrow$ Left)	VR6	More than 45 dB	98 MHz (84 MHz), 60 dB, 1 kHz (Stereo 100%) Rch input. Minimum output of Lch.
11	Confirmation of Stereo Distortion Factor		Distortion Factor: Less than 0.3%	98 MHz (84 MHz), 60 dB, 1 kHz (Stereo 100%) input. If distortion exceeds 0.5%, first check according to Steps 2, 3, 5, 9 and 10, and then readjust according to Step 1.
12	Signal LED Sensitivity	VR2		98 MHz (84 MHz), 40 dB input. Adjust VR2 to a point where 5th LED of SIGNAL LED light up. (See Note 4)
13	Muting Level	VR1	20 dB $\pm$ 6 dB	MODE switch to STEREO. 98 MHz, 20 dB, 1 kHz (Mono 100%) input. Adjust VR1 until the output signal is reduced to zero. Vary the SSG output by $\pm$ 6 dB and check muting operation.
14	CAL TONE Level	VR3	275 mV	AT-S61J only.

## VIII. CLASSIFICATION OF VARIOUS P.C BOARDS

### 1. P.C BOARD TITLES AND IDENTIFICATION NUMBERS

#### 1) Model AT-S61

P.C BOARD TITLE	P.C BOARD NUMBER	NOTES
TUNER P.C Board	A3027A501A	U
TUNER P.C Board	A3027A502A	E, V, S
TUNER P.C Board	A3027A503A	C, A
OPERATION P.C Board	A3027A501B	U
OPERATION P.C Board	A3027A502B	E, V, S
OPERATION P.C Board	A3027A503B	C, A
POWER P.C Board	A2013D5044	U
POWER P.C Board	A3027D5040	C, A, E, S
POWER P.C Board	A3033D509B	V
FILTER P.C Board	A3033D509A	V

#### 2) Model AT-S61L

P.C BOARD TITLE	P.C BOARD NUMBER	NOTES
TUNER P.C Board	A3027A502A	
OPERATION P.C Board	A3027D502B	
POWER P.C Board	A3027D5050	

#### 3) Model AT-S61J

P.C BOARD TITLE	P.C BOARD NUMBER	NOTES
TUNER P.C Board	A3027A501A	
OPERATION P.C Board	A3027A501B	
POWER P.C Board	A3027D5060	

## 2. COMPOSITION OF VARIOUS P.C BOARDS

1) Model AT-S61 Tuner P.C Board A3027A501A (U), A3027A502A (E, V, S), A3027A503A (C, A) and Operation P.C Board A3027A501B (U), A3027A502B (E, V, S), A3027A503B (C, A)

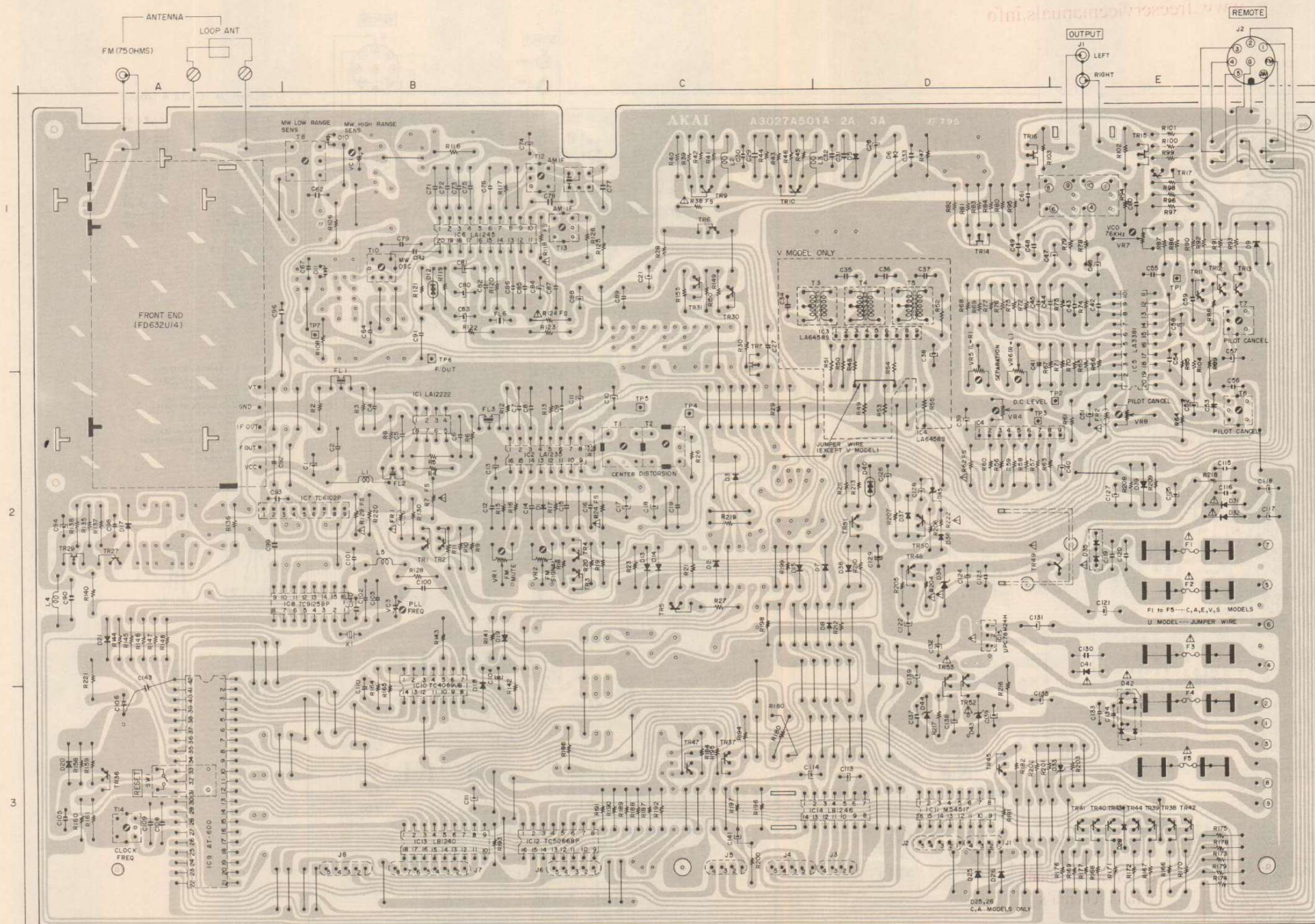

- LOCATION OF IC & TR B TERMINAL
- |                |             |             |
|----------------|-------------|-------------|
| TR1,2--B2      | IC1,2--B2   | J1 to 3--D3 |
| TR3 to 5--C2   | IC4--D2     | J4 to 6--C3 |
| TR6,7,9,10--C1 | IC5--E1     | J7,8--B3    |
| TR11 to 13--E1 | IC6--B1     | J9--C3      |
| TR14--D1       | IC7--A2     |             |
| TR15--E1       | IC8--B2     |             |
| TR16--D1       | IC9--A3     |             |
| TR17--E1       | IC10--B2    |             |
|                | IC11--D3    |             |
|                | IC12,13--B3 |             |
|                | IC14--D3    |             |
|                | IC15--D2    |             |
- 
- |                |
|----------------|
| TR30 31--C1    |
| TR36--A3       |
| TR37--C3       |
| TR38 to 44--E3 |
| TR45--D3       |
| TR46,47--C3    |
| TR48--D2       |
| TR49--E2       |
| TR50,51--D2    |
| TR52,53--D3    |
- 
- |                                  |
|----------------------------------|
| TR1, 6, 17--25A608K-NP (E, F, G) |
| TR2 to 5--25C536K-NP (E, F, G)   |
| TR7, 14 to 16--25K246 (Y)        |
| TR9 to 13--25C536K-NP (E, F, G)  |
- 
- |  |
|--|
| TR26, 27, 31 to 44                         |
| 48, 51, 52--25C536K-NP (E, F, G)           |
| TR30, 46, 48, 49, 50--25A608K-NP (E, F, G) |
| TR46, 53--25D612K (D, E, F)                |
| TR28, 29--25K223 (F)                       |

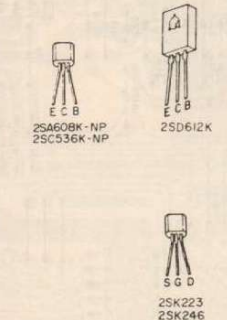

TUNER PCB (U)A3027A501A, (C,A) A3027A503A, (E,V,S) A3027A502A

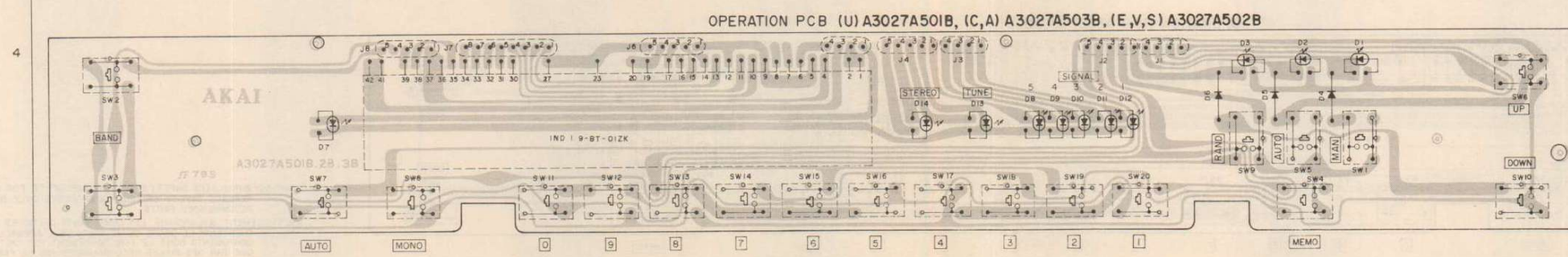

OPERATION PCB (U) A3027A501B, (C,A) A3027A503B, (E,V,S) A3027A502B

WARNING: Δ INDICATES SAFETY CRITICAL COMPONENTS. FOR CONTINUED SAFETY, REPLACE SAFETY CRITICAL COMPONENTS ONLY WITH MANUFACTURER'S RECOMMENDED PARTS

AVERTISSEMENT: Δ IL INDIQUE LES COMPOSANTS CRITIQUES DE SÛRETÉ. POUR MAINTENIR LE DEGRÉ DE SÛRETÉ DE L'APPAREIL NE REMPLACER LES COMPOSANTS DONT LE FONCTIONNEMENT EST CRITIQUE POUR LA SÛRETÉ QUE PAR DES PIÈCES RECOMMANDÉES PAR LE FABRICANT

2) Model AT-S61L Tuner P.C Board A3027A502A and Operation P.C Board A3027A502B

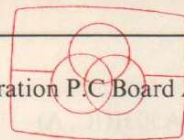

Free service manuals

Gratis schema's

Digitized by

www.freeservicemanuals.info

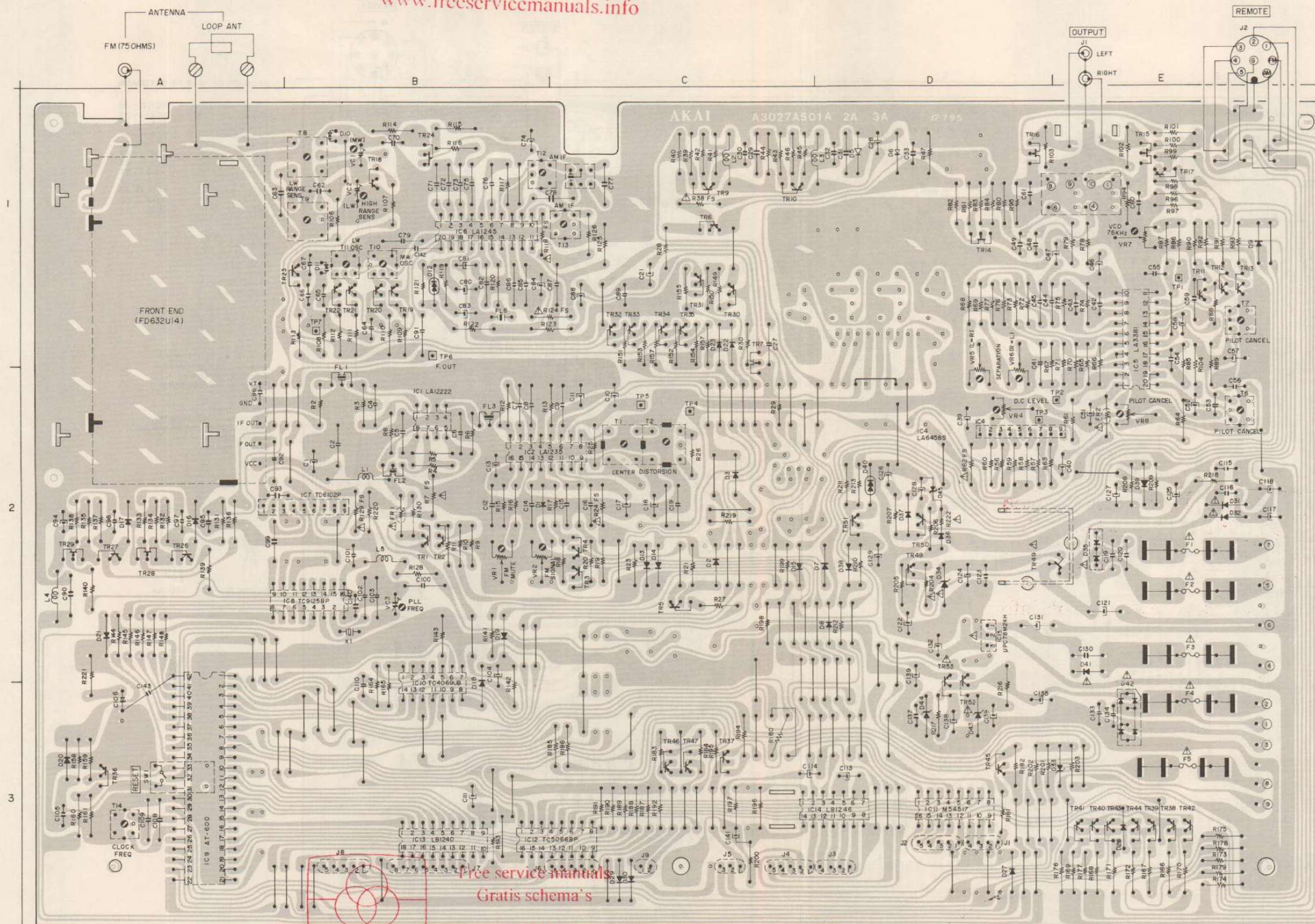

LOCATION OF IC & TR & TERMINAL

- |                |             |             |
|----------------|-------------|-------------|
| TR1,2--B2      | IC1,2--B2   | J1 to 3--D3 |
| TR3 to 5--C2   | IC4--D2     | J4 to 6--C3 |
| TR6,7,9,10--C1 | IC5--E1     | J7,8--B3    |
| TR11 to 13--E1 | IC6--B1     | J9--C3      |
| TR14--D1       | IC7--A2     |             |
| TR15--E1       | IC8--B2     |             |
| TR16--D1       | IC9--A3     |             |
| TR17--E1       | IC10--B2    |             |
| TR18 to 23--B1 | IC11--D3    |             |
| TR24--B1       | IC12,13--B3 |             |
| TR26 to 29--A2 | IC14--D3    |             |
| TR30 to 35--C1 | IC15--D2    |             |
| TR36--A3       |             |             |
| TR37--C3       |             |             |
| TR38 to 44--E3 |             |             |
| TR45--D3       |             |             |
| TR46,47--C3    |             |             |
| TR48--D2       |             |             |
| TR49--E2       |             |             |
| TR50,51--D2    |             |             |
| TR52,53--D3    |             |             |

- TR1,6,17---2SA608K-NP (E,F,G)  
 TR2 to 5---2SC536K-NP (F,G)  
 TR7,14 to 16---2SK246 (Y)  
 TR9 to 13,19,23 2SC536K-NP (F,G)  
 TR18 to 22---2SA608K-NP (E,F,G)  
 TR24---2SK19 (Y)  
 TR26,27,31 to 44  
 48,51,52---2SC536K-NP (F,G)  
 TR30,45,46,47,50---2SA608K-NP (E,F,G)  
 TR49,53---2SD612K (D,E,F)  
 TR28,29---2SK223 (F)

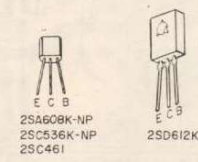

Free service manuals

Gratis schema's

Digitized by

TUNER PCB A3027A502A(E)

www.freeservicemanuals.info

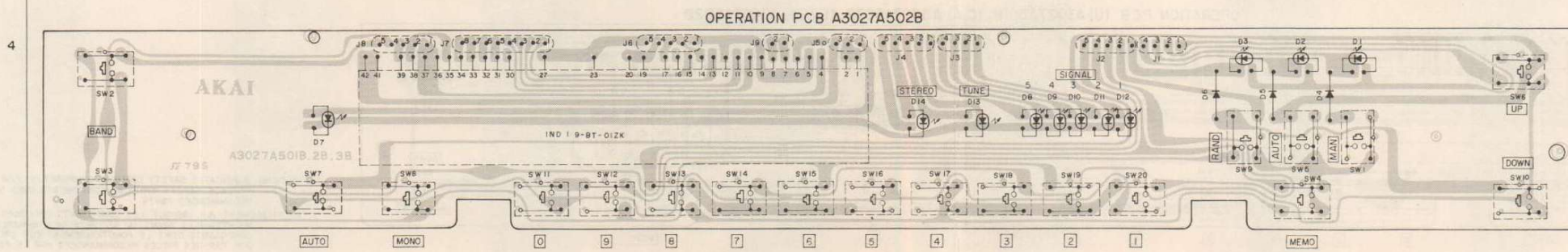

WARNING: Δ INDICATES SAFETY CRITICAL COMPONENTS. FOR CONTINUED SAFETY, REPLACE SAFETY CRITICAL COMPONENTS ONLY WITH MANUFACTURER'S RECOMMENDED PARTS

AVERTISSEMENT: Δ IL INDIQUE LES COMPOSANTS CRITIQUES DE SÛRETÉ. POUR MAINTENIR LE DEGRÉ DE SÛRETÉ DE L'APPAREIL, NE REMPLACER LES COMPOSANTS DONT LE FONCTIONNEMENT EST CRITIQUE POUR LA SÛRETÉ QUE PAR DES PIÈCES RECOMMANDÉES PAR LE FABRICANT

4) Model AT-S61 Power P.C Board A2013D5044 (U)

POWER PCB (U) A2013D5044

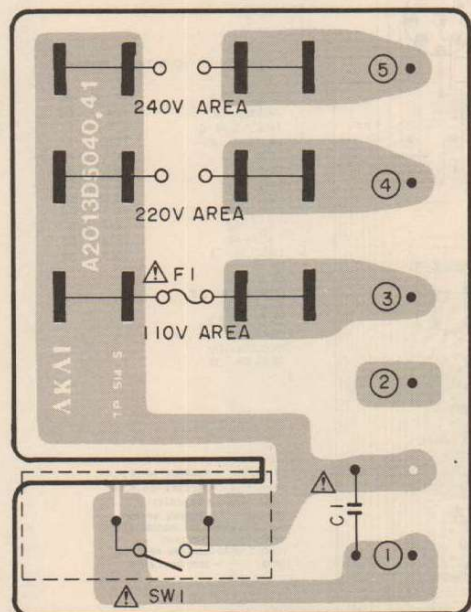

U  
AC 110V to 240V  
50/60Hz

5) Model AT-S61 Power P.C Board (C, A) A3027D5040

C, A  
AC 120V 60Hz

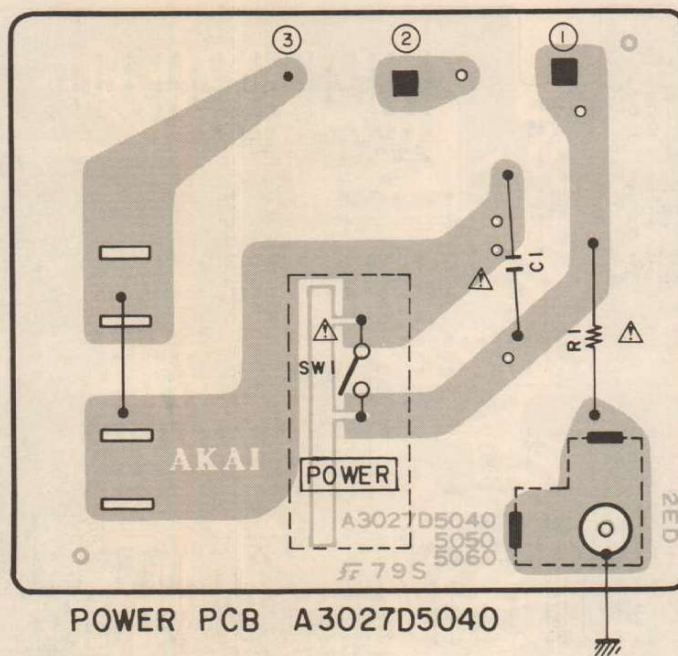

POWER PCB A3027D5040

6) Model AT-S61/L Power P.C Board (E, S) A3027D5040

S AC 240V 50Hz  
E AC 220V 50Hz

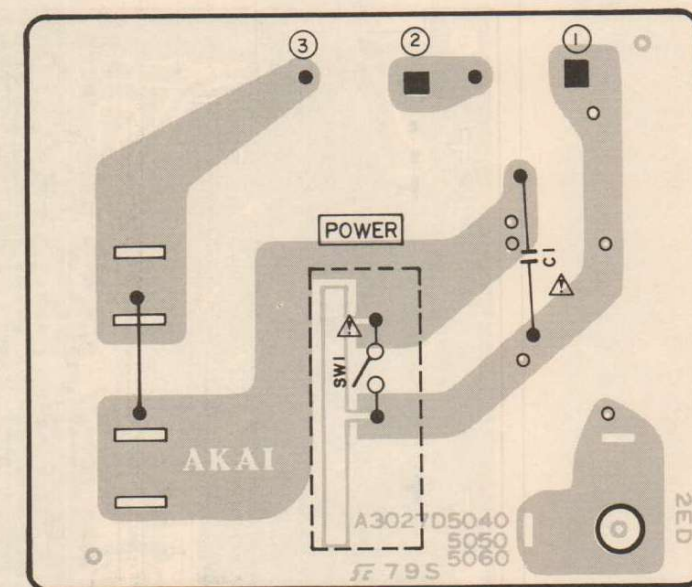

POWER PCB A3027D5040

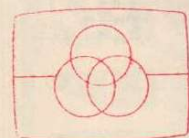

Free service manuals  
Gratis schema's

Digitized by

www.freeservicemanuals.info

WARNING: Δ INDICATES SAFETY CRITICAL COMPONENTS. FOR CONTINUED SAFETY, REPLACE SAFETY CRITICAL COMPONENTS ONLY WITH MANUFACTURER'S RECOMMENDED PARTS.  
AVERTISSEMENT: Δ IL INDIQUE LES COMPOSANTS CRITIQUES DE SÛRETÉ. POUR MAINTENIR LE DEGRÉ DE SÛRETÉ DE L'APPAREIL NE REMPLACER LES COMPOSANTS DONT LE FONCTIONNEMENT EST CRITIQUE POUR LA SÛRETÉ QUE PAR DES PIÈCES RECOMMANDÉES PAR LE FABRICANT

7) Model AT-S61 Power P.C Board A3033D509B and Filter P.C Board A3033D509A (V Model)

FILTER PCB A3033D509A

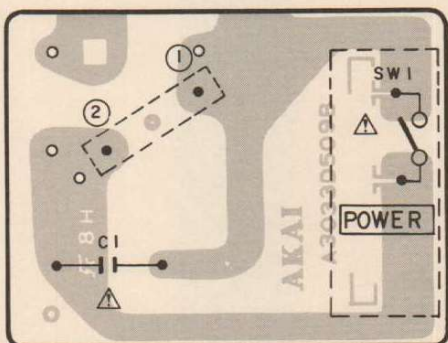

POWER PCB A3033D509B

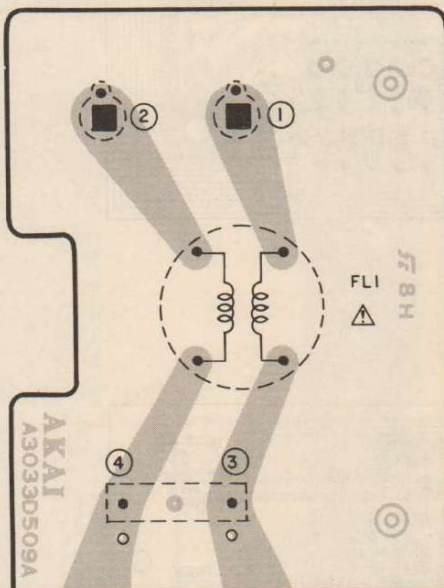

V  
AC 220V 50Hz

8) Model AT-S61L Power P.C Board A3027D5050

B AC 240V 50Hz

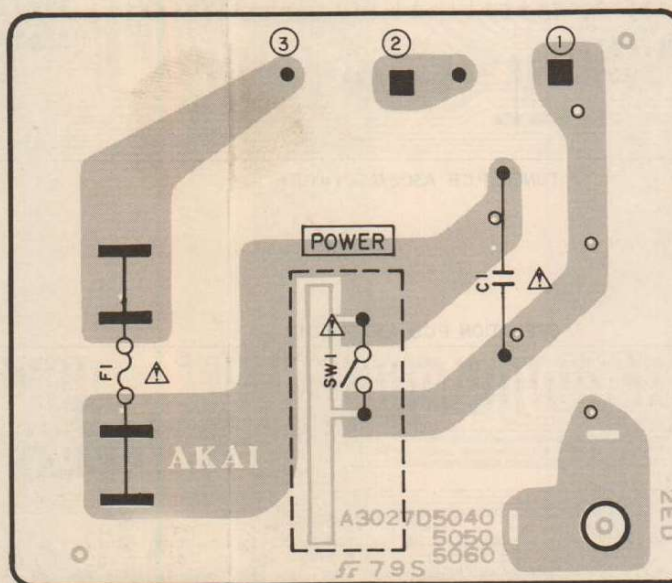

POWER PCB A3027D5050

9) Model AT-S61J Power P.C Board A3027D5060

J AC 100V 50/60Hz

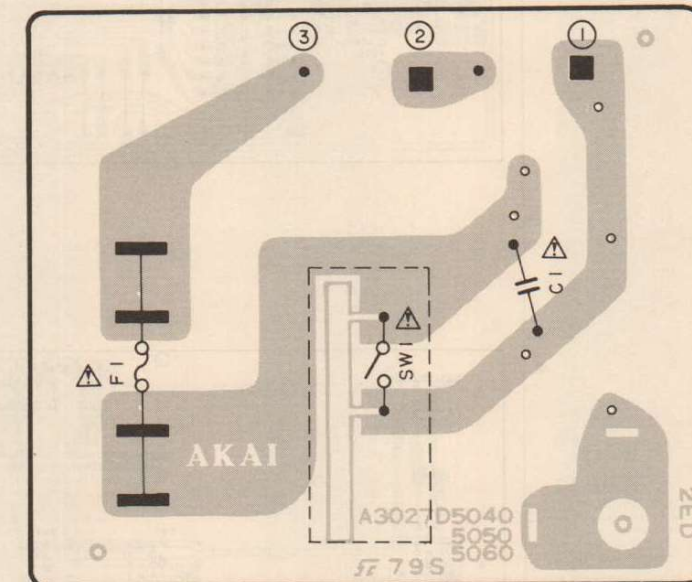

POWER PCB A3027D5060



3) Model AT-S61J Tuner P.C Board A3027A501A and Operation P.C Board A3027A501A

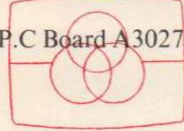

Free service manuals  
Gratis schema's

Digitized by

www.freeservicemanuals.info

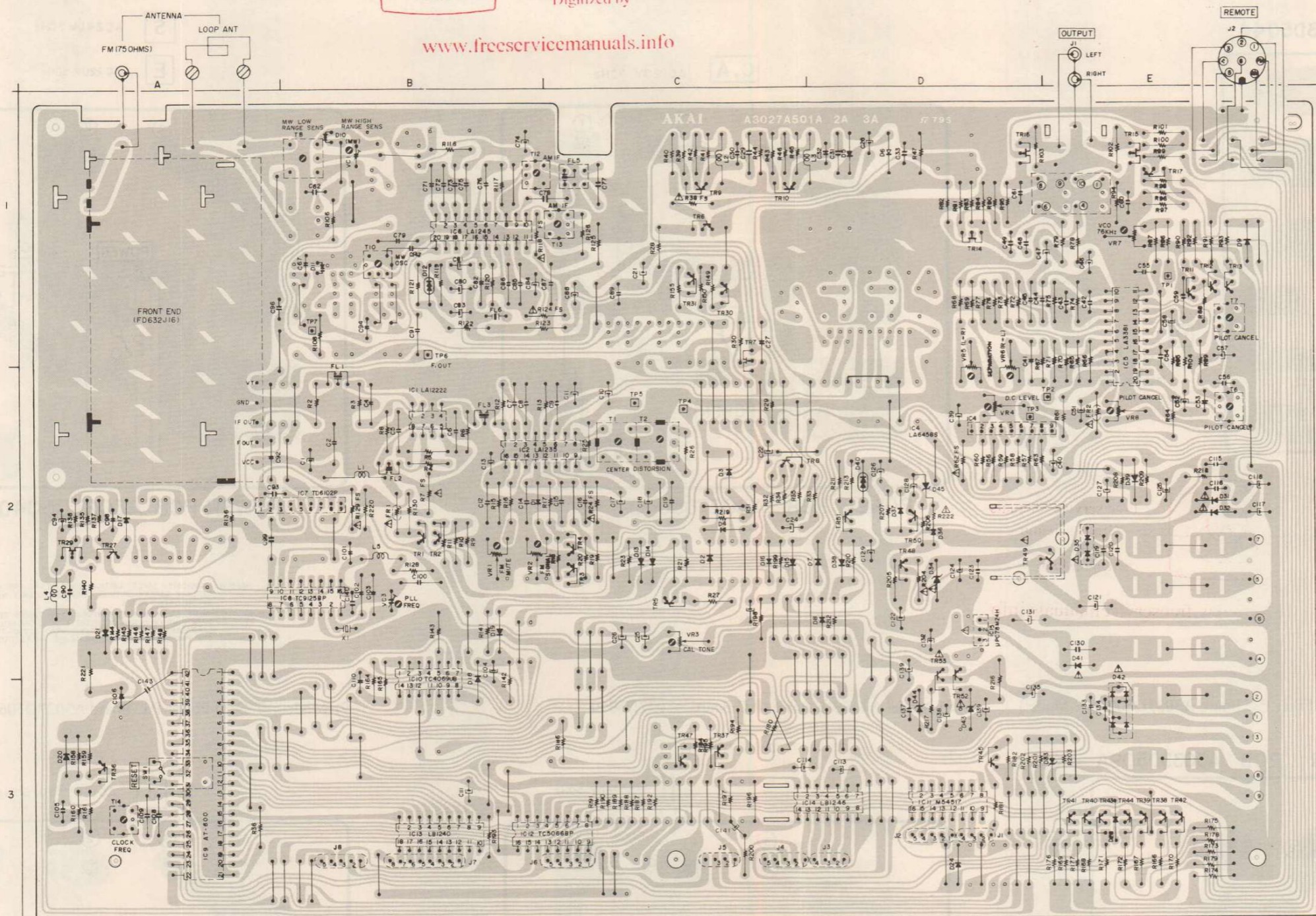

TUNER PCB A3027A501A(U)

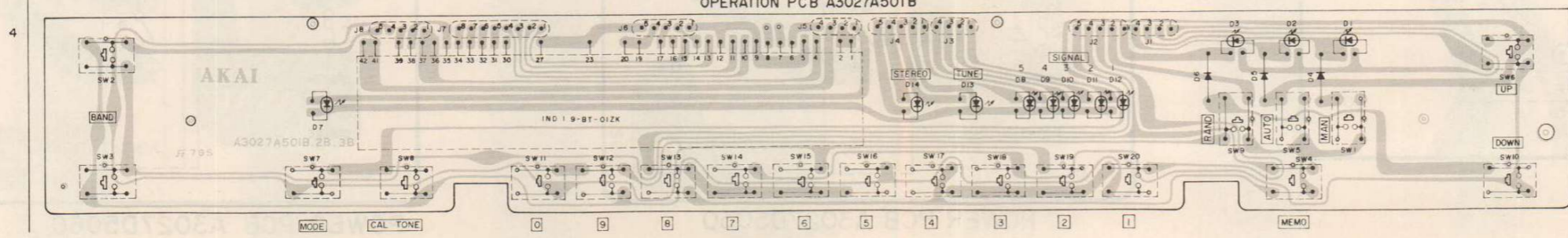

OPERATION PCB A3027A501B

LOCATION OF IC & TR & TERMINAL

- TR1,2--B2
- TR3,5-C2
- TR6,7,9,10-C1
- TR11 to 13--E1
- TR14-D1
- TR15-E1
- TR16-D1
- TR17-E1
- TR8-C2
- TR27-A2
- TR29-A6
- TR30,31-C1
- TR36-A3
- TR37-C3
- TR38 to 44--E3
- TR45-D3
- TR47--C3
- TR48-D2
- TR50,51-D2
- TR52,53-D3
- IC1,2--B2
- IC4--D2
- IC5--E1
- IC6--B1
- IC7--A2
- IC8--B2
- IC9--A3
- IC10--B2
- IC11--D3
- IC12,13--B3
- IC14--D3
- IC15--D2
- J1 to 3-D3
- J4 to 6-C3
- J7,8--B3

- TR1,6,17---2S480K-NP(E,F,G)
- TR2 to 5---2SC36K-NP(F,G)
- TR7,8,10 to 16---2SK246(Y)
- TR9 to 13,---2SC38K-NP(F,G)
- TR27,31,36 to 44,51,52---2SC36K-NP(F,G)
- TR29---2SK223(F)
- TR30,45,47,50---2S460K-NP(E,F,G)
- TR53---2SD12K(D,E,F)

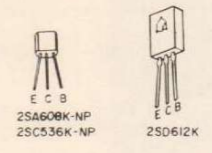

WARNING: Δ INDICATES SAFETY CRITICAL COMPONENTS. FOR CONTINUED SAFETY, REPLACE SAFETY CRITICAL COMPONENTS ONLY WITH MANUFACTURER'S RECOMMENDED PARTS

AVERTISSEMENT: Δ IL INDIQUE LES COMPOSANTS CRITIQUES DE SÛRETÉ. POUR MAINTENIR LE DEGRÉ DE SÛRETÉ DE L'APPAREIL, NE REMPLACER LES COMPOSANTS DONT LE FONCTIONNEMENT EST CRITIQUE POUR LA SÛRETÉ QUE PAR DES PIÈCES RECOMMANDÉES PAR LE FABRICANT



AM-U41

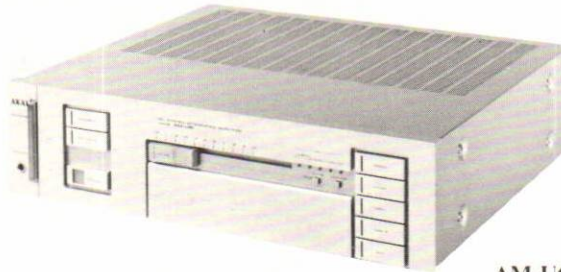

AM-U61

## SECTION 2

**SERVICE MANUAL****MODEL AM-U41, AM-U61**

## TABLE OF CONTENTS

I.	SPECIFICATIONS .....	26
	1) MODEL AM-U41 .....	26
	2) MODEL AM-U61 .....	27
II.	DISMANTLING OF UNIT (AM-U41/61) .....	28
II.	CONTROLS .....	29
	1) MODEL AM-U41 .....	29
	2) MODEL AM-U61 .....	30
IV.	PRINCIPAL PARTS LOCATION.....	31
	1) MODEL AM-U41 .....	31
	2) MODEL AM-U61 .....	32
V.	VOLTAGE CONVERSION (U/T ONLY) .....	33
VI.	DC OFF-SET VOLTAGE ADJUSTMENT (AM-U61 ONLY) .....	33
VII.	CLASSIFICATION OF VARIOUS P.C BOARDS .....	34
	1) P.C BOARD TITLES AND IDENTIFICATION NUMBERS.....	34
	1-1) MODEL AM-U41 .....	34
	1-2) MODEL AM-U61 .....	35
	2) COMPOSITION OF VARIOUS P.C BOARD .....	36

For basic adjustments, measuring methods, and operating principles, refer to GENERAL TECHNICAL MANUAL.

# I. SPECIFICATIONS

AM-U41

## 1. MODEL AM-U41

RATED POWER OUTPUT (2 CHANNELS DRIVEN) 20 to 20,000 Hz 1,000 Hz 1 kHz, 0.7% (DIN)	8 ohms 55W × 2/0.007% 60W × 2/0.007% 65W × 2	4 ohms 60W × 2/0.01% 65W × 2/0.01% 70W × 2
POWER BANDWIDTH (IHF -3 dB, 8 OHMS)	5 Hz to 70 kHz (0.05%)	
SIGNAL TO NOISE RATIO (IHF-A) PHONO (MM/MC) TUNER, TAPE, AUX	86/67 dB 103 dB	
RESIDUAL NOISE (8 OHMS, IHF-A)	110 $\mu$ V	
CHANNEL SEPARATION	60 (1 kHz)/60 (40 Hz)/50 (10 kHz) dB	
DAMPING FACTOR (8 OHMS)	60 (1 kHz)/60 (40 Hz)/52 (12.5 kHz)	
OUTPUT REQUIRED SPEAKER IMPEDANCE	A, B 4 to 16 ohms A + B: 8 to 16 ohms	
INPUT SENSITIVITY/IMPEDANCE PHONO MM PHONO MC TUNER, TAPE, AUX	2.5 mV/47 kohms 0.25 mV/100 ohms 150 mV/47 kohms	
OUTPUT LEVEL/IMPEDANCE TAPE REC	150 mV/1 kohm	
FREQUENCY RESPONSE PHONO (RIAA DEVIATION) TUNER, AUX, TAPE	$\pm$ 0.2 dB 5 Hz to 100 kHz ( $-$ 2 dB)	
TONE CONTROL BASS TREBLE	$\pm$ 8 dB (100 Hz) $\pm$ 8 dB (10 kHz)	
LOUDNESS CONTROL (VOLUME SET AT $-$ 30 dB POSITION)	+10 dB (100 Hz) +6 dB (10 kHz)	
SUBSONIC FILTER	$-$ 6 dB/Oct at 18 Hz	
PHONO MAX. INPUT (1 kHz) MM MC	250 mV 25 mV	
POWER REQUIREMENTS	100V, 50/60 Hz for Japan 120V, 60 Hz for U.S.A. and Canada 220V, 50 Hz for Europe except UK 240V, 50 Hz for UK and Australia 110V/220V/240V, 50/60 Hz switchable for other countries	
POWER CONSUMPTION	250W (U)    150W (J)    170W (A) 270W (C)    440W (B, S)    410W (E, V)	
DIMENSIONS	440 (W) × 120 (H) × 397 (D) mm (17.3 × 4.7 × 15.6 inches)	
WEIGHT	10.4 kg (22.9 lbs)	

\* For improvement purposes, specifications and design are subject to change without notice.

**1. MODEL AM-U61**

RATED POWER OUTPUT (2 CHANNELS DRIVEN) 20 to 20,000 Hz 1,000 Hz 1 kHz, 0.7% (DIN)	8 ohms 75W × 2/0.007% 85W × 2/0.007% 88W × 2	4 ohms 85W × 2/0.01% 85W × 2/0.01% 100W × 2
POWER BANDWIDTH (IHF -3 dB, 8 OHMS)	5 Hz to 70 kHz (0.05%)	
SIGNAL TO NOISE RATIO (IHF-A) PHONO (MM/MC) TUNER, TAPE, AUX	86/67 dB 103 dB	
RESIDUAL NOISE (8 OHMS, IHF-A)	110 μV	
CHANNEL SEPARATION	60 (1 kHz)/60 (40 Hz)/50 (10 kHz) dB	
DAMPING FACTOR (8 OHMS)	60 (1 kHz)/60 (40 Hz)/52 (12.5 kHz)	
OUTPUT REQUIRED SPEAKER IMPEDANCE	A, B 4 to 16 ohms A + B: 8 to 16 ohms	
INPUT SENSITIVITY/IMPEDANCE PHONO MM PHONO MC TUNER, AUX, TAPE PLAY	2.5 mV/33, 47, 100 kohms (switchable) 0.25 mV/100 ohms 150 mV/47 kohms	
OUTPUT LEVEL/IMPEDANCE TAPE REC	150 mV/1 kohm	
FREQUENCY RESPONSE PHONO (RIAA DEVIATION) TUNER, AUX, TAPE PLAY	± 0.2 dB 5 Hz to 100 kHz (-2 dB)	
TONE CONTROL BASS TREBLE	± 8 dB (100 Hz) ± 8 dB (10 kHz)	
LOUDNESS CONTROL (VOLUME SET AT -30 dB POSITION)	+10 dB (100 Hz) +6 dB (10 kHz)	
SUBSONIC FILTER	-6 dB/Oct at 18 Hz	
PHONO MAX. INPUT (1 kHz) MM MC	250 mV 25 mV	
POWER REQUIREMENTS	100V, 50/60 Hz for Japan 120V, 60 Hz for U.S.A. and Canada 220V, 50 Hz for Europe except UK 240V, 50 Hz for UK and Australia 110V/220V/240V, 50/60 Hz switchable for other countries	
POWER CONSUMPTION	300W (U)    200W (J)    220W (A) 350W (C)    650W (B, S)    550W (E, V)	
DIMENSIONS	440 (W) × 120 (H) × 397 (D) mm (17.3 × 4.7 × 15.6 inches)	
WEIGHT	12 kg (26.4 lbs)	

\* For improvement purposes, specifications and design are subject to change without notice.

## II. DISMANTLING OF UNIT

In case of trouble, etc. necessitating dismantling, please dismantle in the order shown in the photographs. Reassemble in reverse order.

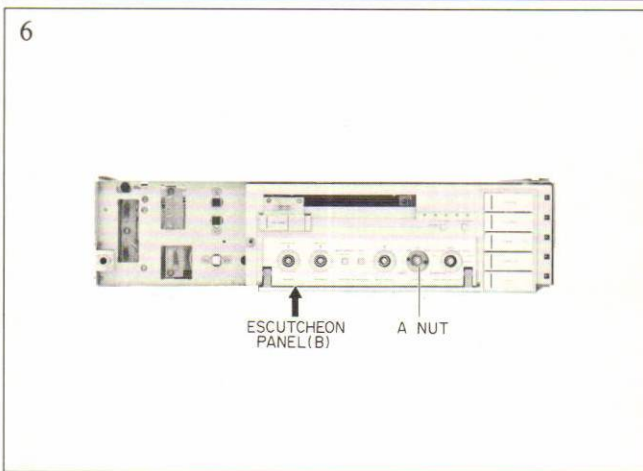
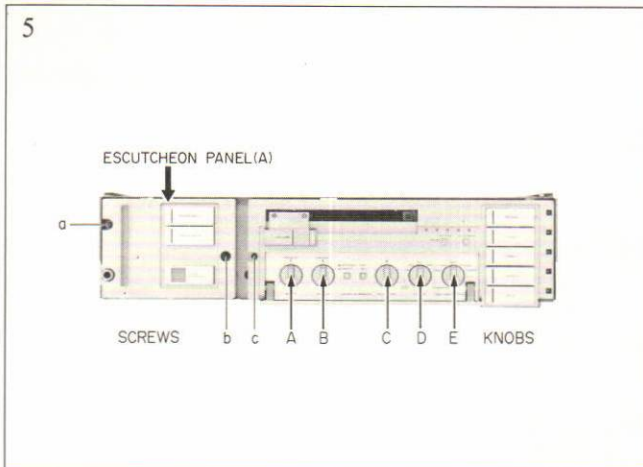
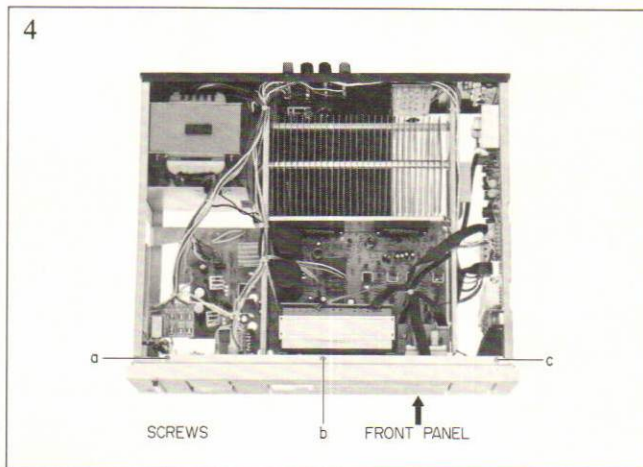
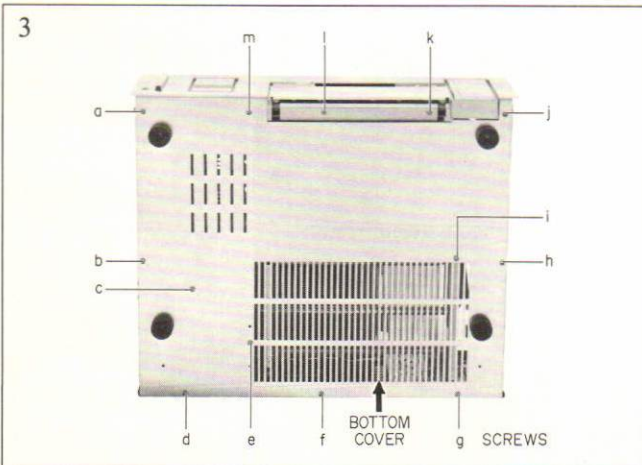
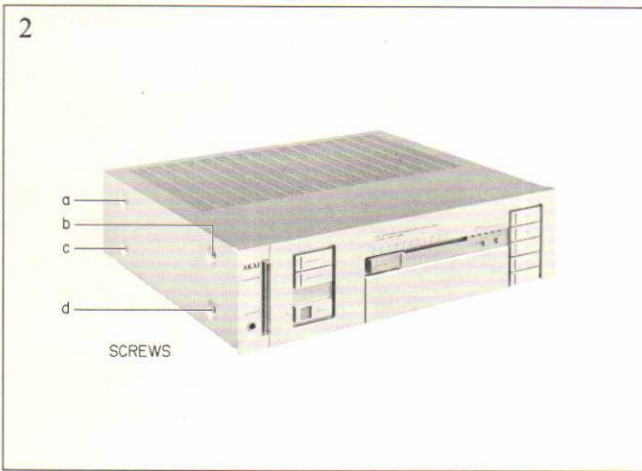
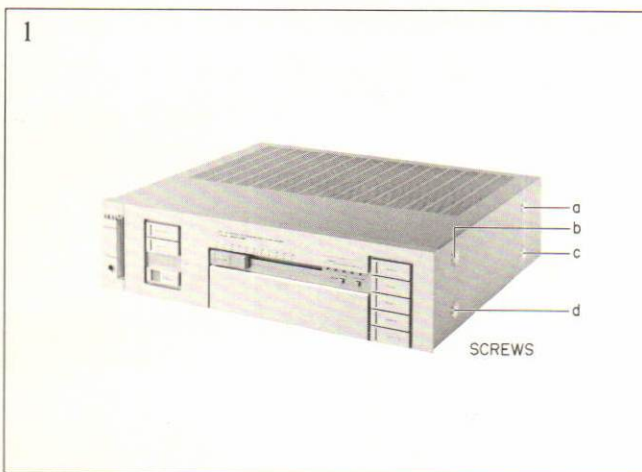

### III. CONTROLS

AM-U41

#### 1) MODEL AM-U41

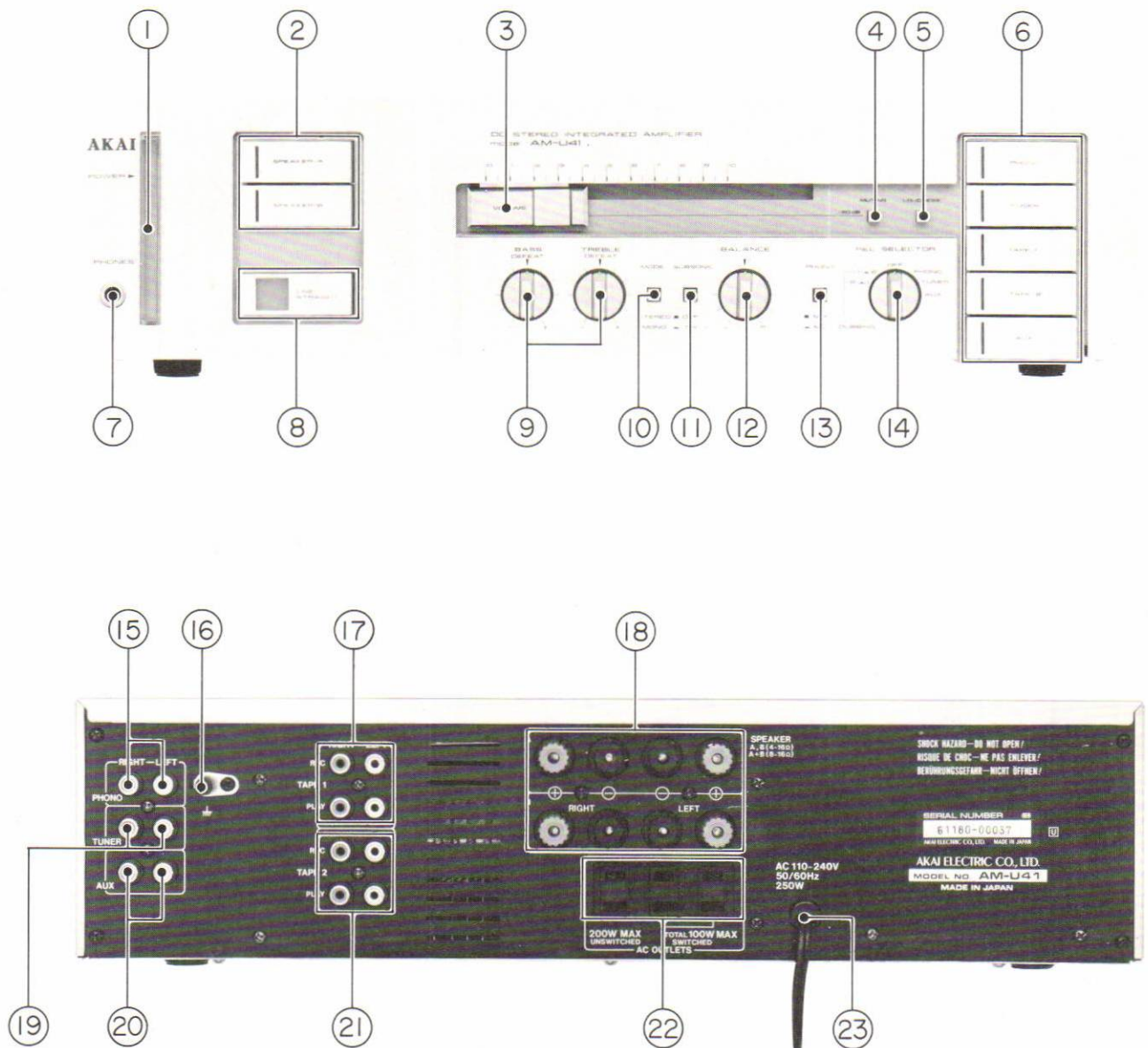

Fig. 1 Controls

- |   |  |
|---|--|
| 1. POWER SWITCH                                   | 13. PHONO SELECTOR   |
| 2. SPEAKER SWITCHES WITH INDICATORS               | 14. RECORDING (REC) SELECTOR   |
| 3. VOLUME CONTROL                                 | 15. PHONO JACKS  |
| 4. MUTING BUTTON                                  | 16. GROUND TERMINAL ( $\perp$ )                                      |
| 5. LOUDNESS BUTTON                                | 17. TAPE 1 REC/PLAY JACKS  |
| 6. INPUT SWITCHES WITH INDICATORS                 | 18. A AND B SPEAKER SYSTEM TERMINALS                                 |
| 7. HEADPHONE JACK (PHONES)                        | 19. TUNER JACKS  |
| 8. LINE STRAIGHT SWITCH WITH INDICATOR            | 20. AUX JACKS  |
| 9. TONE CONTROLS                                  | 21. TAPE 2 REC/PLAY JACKS  |
| 10. MODE SELECTOR                                 | 22. AC OUTLETS (SOME MODELS ARE NOT<br>EQUIPPED WITH THIS FACILITY.) |
| 11. SUBSONIC SWITCH                               | 23. POWER CORD   |
| 12. STEREO BALANCE CONTROL<br>(L: LEFT, R: RIGHT) |  |

## 2) MODEL AM-U61

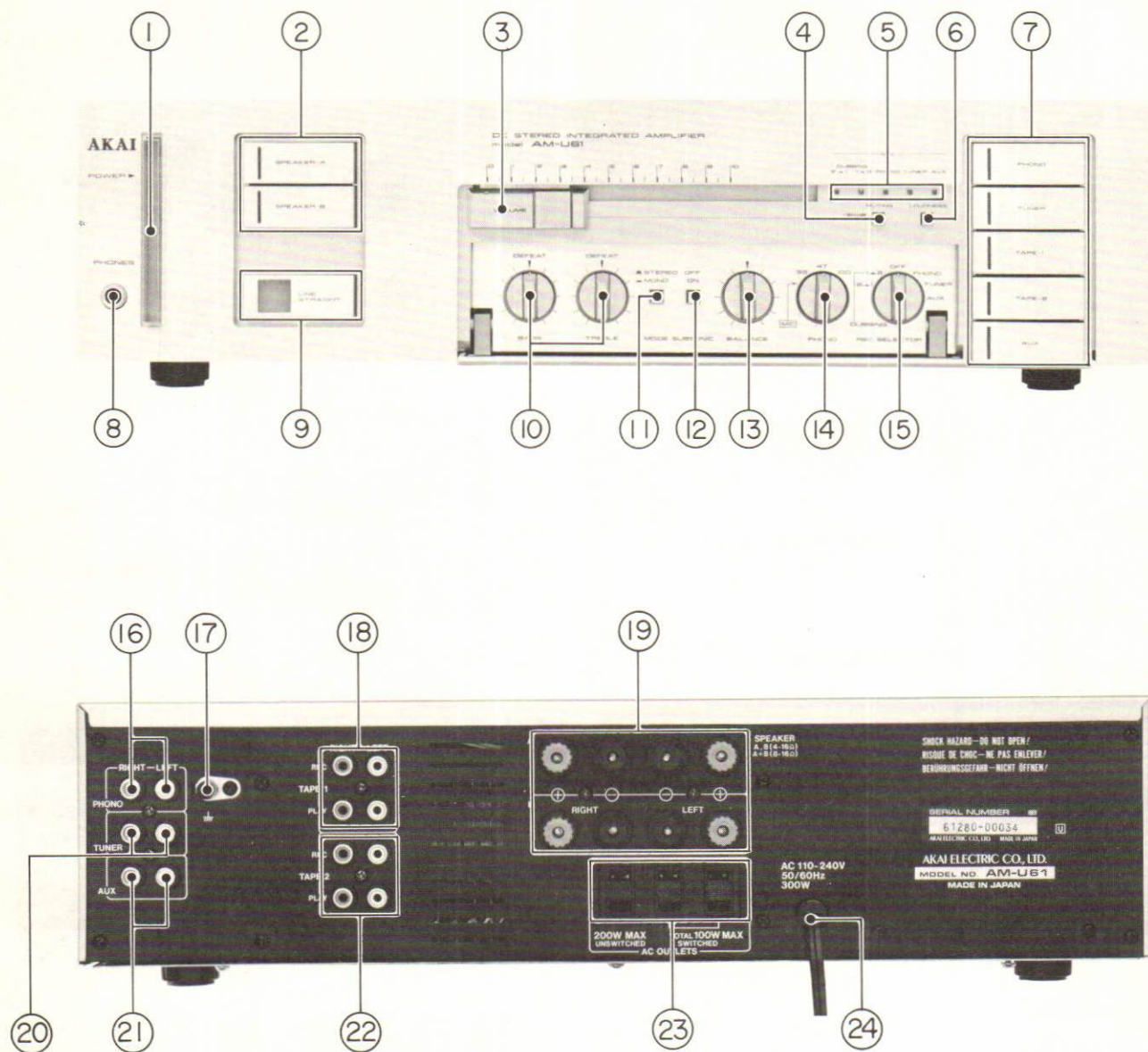

Fig. 2 Controls

- |   |  |
|---|--|
| 1. POWER SWITCH                                   | 14. PHONO SELECTOR   |
| 2. SPEAKERS SWITCHES WITH INDICATORS              | 15. RECORDING (REC) SELECTOR   |
| 3. VOLUME CONTROL                                 | 16. PHONO JACKS  |
| 4. MUTING BUTTON                                  | 17. GROUND TERMINAL ( $\perp$ )                                      |
| 5. RECORDING (REC) INDICATORS                     | 18. TAPE 1 REC/PLAY JACKS  |
| 6. LOUDNESS BUTTON                                | 19. A AND B SPEAKER SYSTEM TERMINALS                                 |
| 7. INPUT SWITCHES WITH INDICATORS                 | 20. TUNER JACKS  |
| 8. HEADPHONE JACK (PHONES)                        | 21. AUX JACKS  |
| 9. LINE STRAIGHT SWITCH WITH INDICATOR            | 22. TAPE 2 REC/PLAY JACKS  |
| 10. TONE CONTROLS                                 | 23. AC OUTLETS (SOME MODELS ARE NOT<br>EQUIPPED WITH THIS FACILITY.) |
| 11. MODE SELECTOR                                 | 24. POWER CORD   |
| 12. SUBSONIC SWITCH                               |  |
| 13. STEREO BALANCE CONTROL<br>(L: LEFT, R: RIGHT) |  |

# IV. PRINCIPAL PARTS LOCATION

AM-U41

## 1) MODEL AM-U41

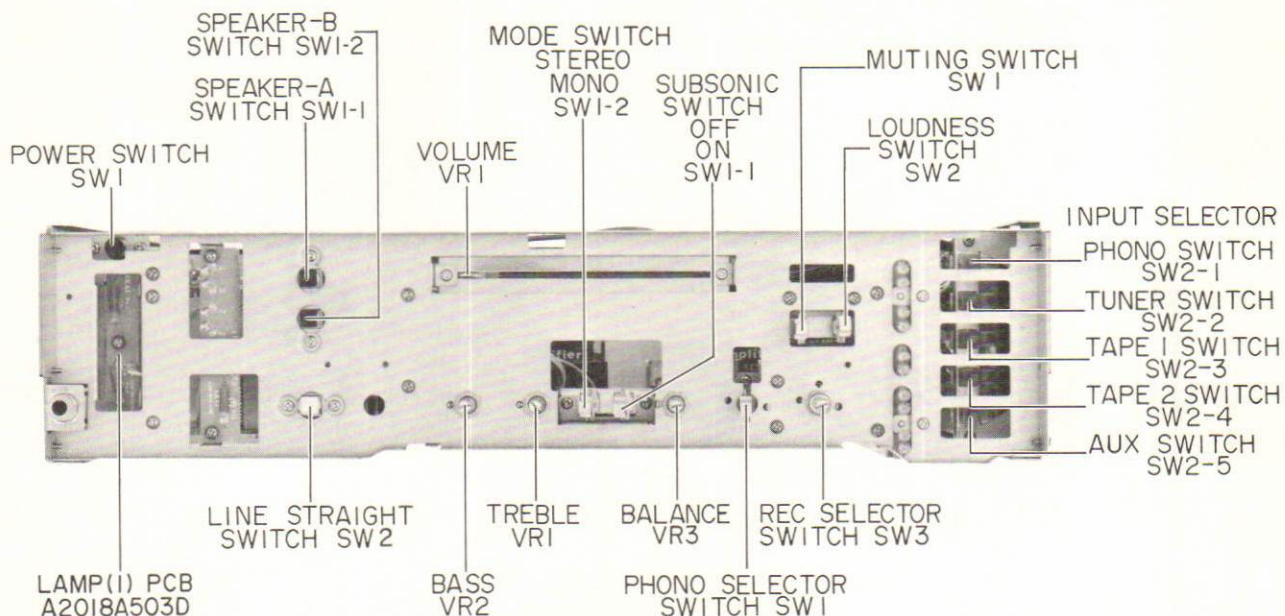

Fig. 3 Front View

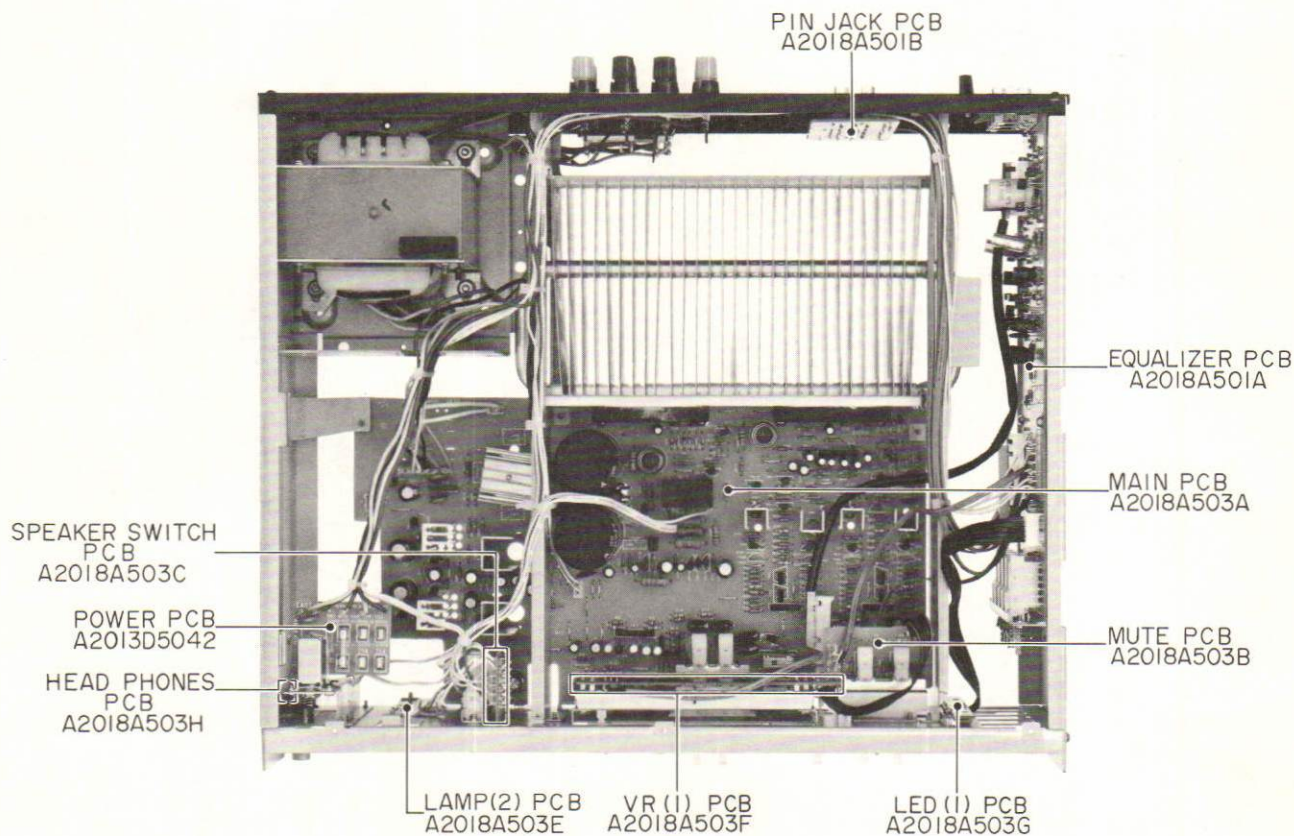

Fig. 4 Top View



2) MODEL AM-U61

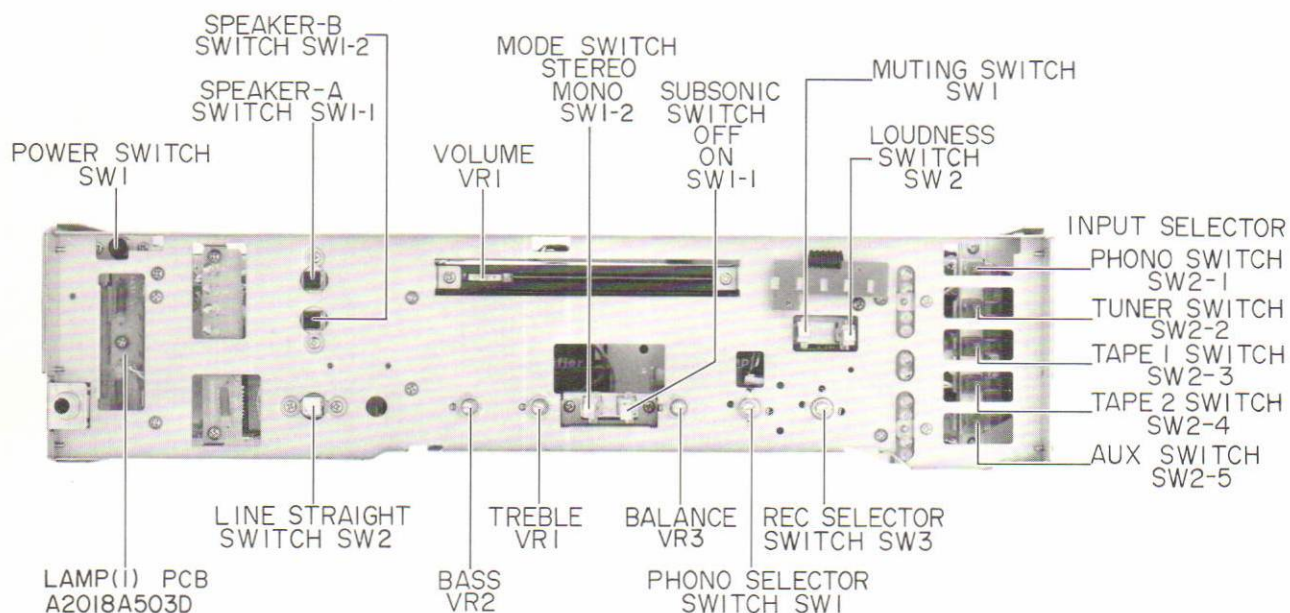

Fig. 5 Front View

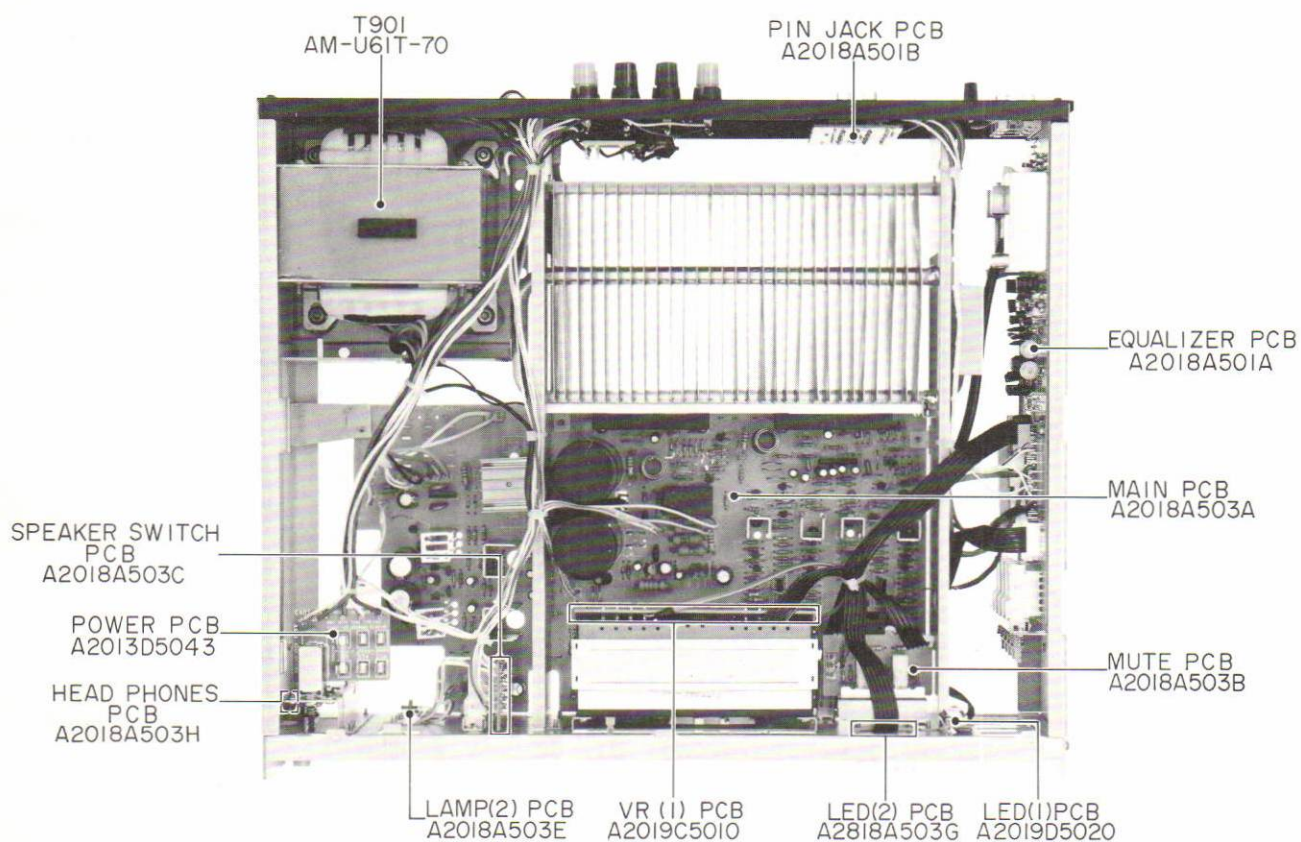

Fig. 6 Top View

## V. VOLTAGE CONVERSION (U/T ONLY)

AM-U41 / AM-U61

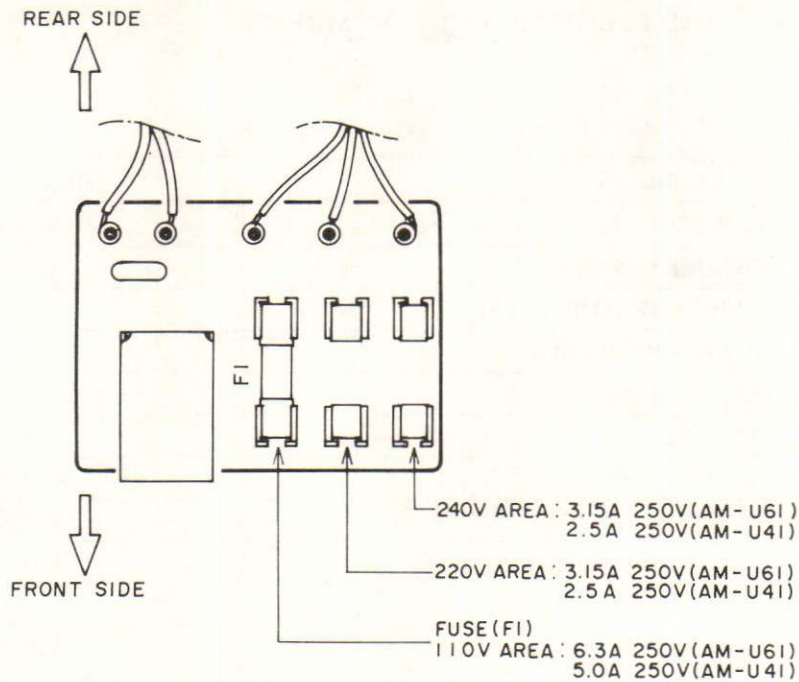

Fig. 7 Voltage Conversion (U Model only)

Models for JAPAN, Canada, U.S.A. Europe, UK and Australia are not equipped with this facility.

Each machine is preset at the factory according to destination, but some machines can be set to 220V or 240V as required.

If voltage change is necessary, this can be accomplished

as follows.

- 1) Disconnect the AC power cord.
- 2) Loosen holding screws and remove upper case.
- 3) Remove existing line voltage fuse in proper fuse holder, explicitly following instructions printed on the rear panel.

## VI. DC OFF-SET VOLTAGE ADJUSTMENT (AM-U61 ONLY)

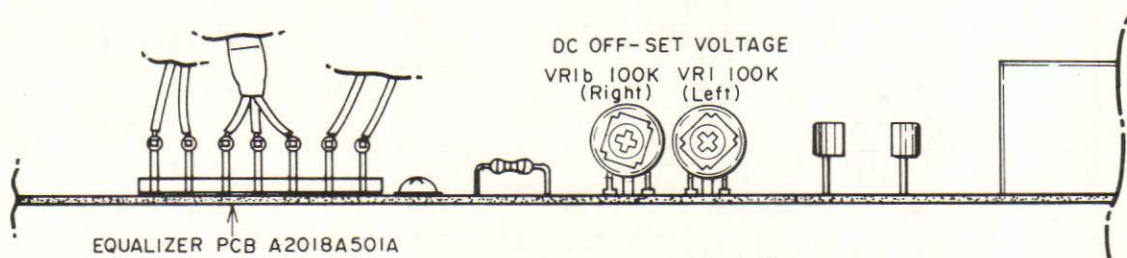

Fig. 8 Equalizer P.C Board A2018A501A

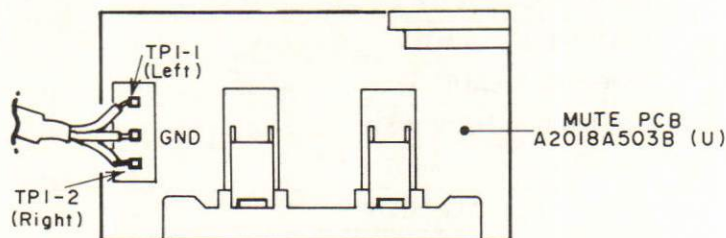

Fig. 9 Mute P.C.B A2018A503B

Set INPUT selector switch to PHONO and PHONO selector switch to MC position. Connect digital voltmeter (or DC voltmeter) to TPI-1 (Left), TPI-2 (Right). Adjust

the VR1 (Left), VR1b (Right) on the Equalizer P.C Board so that the voltmeter reads  $0 \pm 1$  mV.

## VII. CLASSIFICATION OF VARIOUS P.C BOARDS

AM-U41

### 1. P.C BOARD TITLES AND IDENTIFICATION NUMBERS

#### 1) MODEL AM-U41

P.C Board Title	P.C Board Number
POWER P.C Board (U)	A2013D5042
POWER P.C Board (C/A)	A2018D5060
POWER P.C Board (E/V/B/S)	A2018D5072
POWER P.C Board (J)	A2013D5082
EQUALIZER P.C Board	A2018A501A
PIN JACK P.C Board	A2018A501B
MAIN P.C Board (U)	A2018A503A
MAIN P.C Board (J)	A2018A502A
MAIN P.C Board (C/A)	A2018A504A
MAIN P.C Board (E/V/B/S)	A2018A505A
MUTE P.C Board (U)	A2018A503B
MUTE P.C Board (J)	A2018A502B
MUTE P.C Board (C/A)	A2018A504B
MUTE P.C Board (E/V/B/S)	A2018A505B
SPEAKER SW P.C Board (U)	A2018A503C
SPEAKER SW P.C Board (J)	A2018A502C
SPEAKER SW P.C Board (C/A)	A2018A504C
SPEAKER SW P.C Board (E/V/B/S)	A2018A505C
LAMP (1) P.C Board (U)	A2018A503D
LAMP (1) P.C Board (J)	A2018A502D
LAMP (1) P.C Board (C/A)	A2018A504D
LAMP (1) P.C Board (E/V/B/S)	A2018A505D
LAMP (2) P.C Board (U)	A2018A503E
LAMP (2) P.C Board (J)	A2018A502E
LAMP (2) P.C Board (C/A)	A2018A504E
LAMP (2) P.C Board (E/V/B/S)	A2018A505E
VR (1) P.C Board (U)	A2018A503F
VR (1) P.C Board (J)	A2018A502F
VR (1) P.C Board (C/A)	A2018A504F
VR (1) P.C Board (E/V/B/S)	A2018A505F
LED (1) P.C Board (U)	A2018A503G
LED (1) P.C Board (J)	A2018A502G
LED (1) P.C Board (C/A)	A2018A504G
LED (1) P.C Board (E/V/B/S)	A2018A505G
HEADPHONES P.C Board (U)	A2018A503H
HEADPHONES P.C Board (J)	A2018A502H
HEADPHONES P.C Board (C/A)	A2018A504H
HEADPHONES P.C Board (E/V/B/S)	A2018A505H
TERMINAL P.C Board	A2018D5070

### 2. COMPOSITION OF VARIOUS P.C BOARDS

1) Model AM-U41 MAIN P.C Board A2018A503A (U), A2018A502A (J), A2018A504A (C/A), A2018A505A (E/V/B/S)

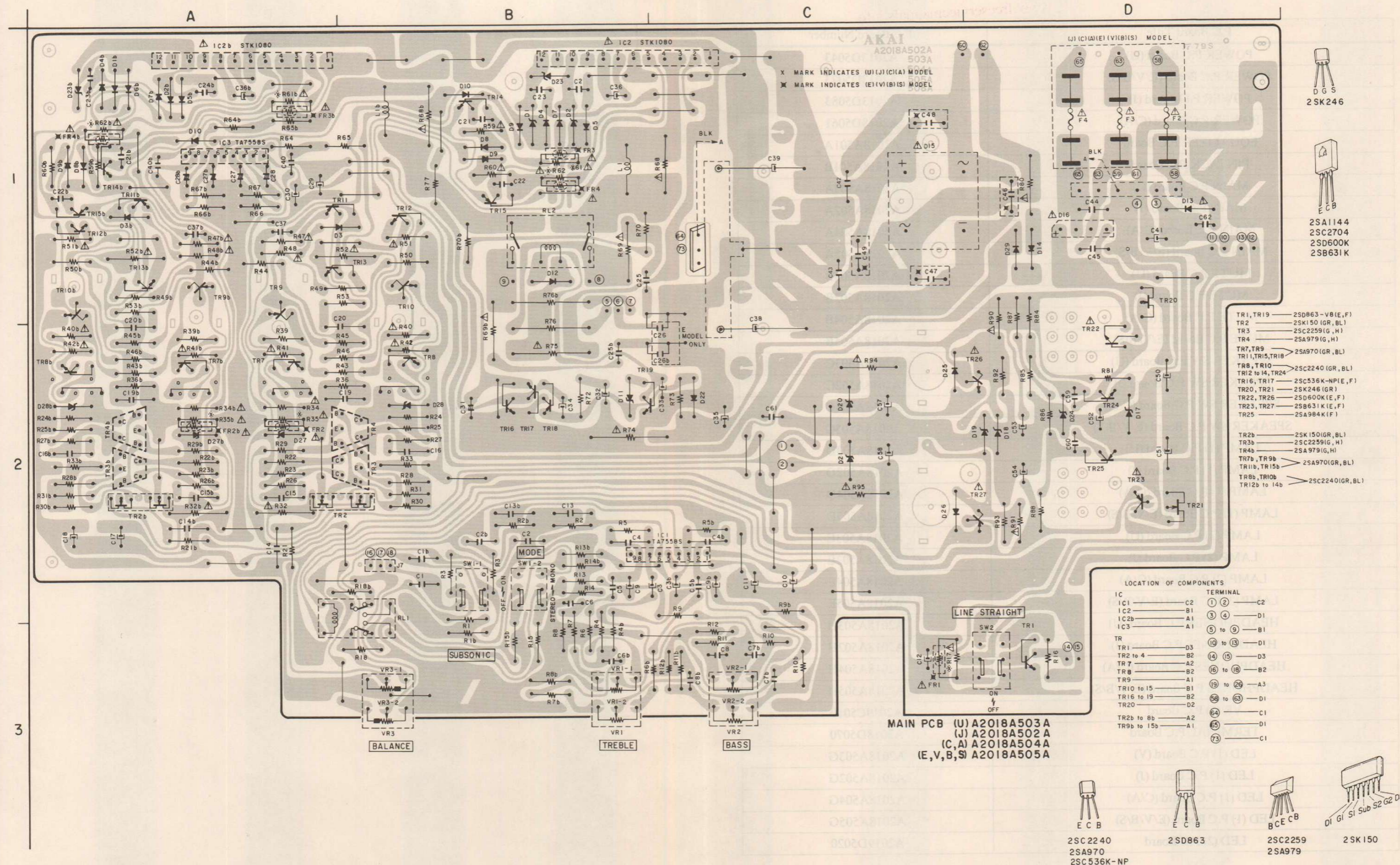

WARNING: Δ INDICATES SAFETY CRITICAL COMPONENTS. FOR CONTINUED SAFETY, REPLACE SAFETY CRITICAL COMPONENTS ONLY WITH MANUFACTURER'S RECOMMENDED PARTS.  
 AVERTISSEMENT: Δ IL INDIQUE LES COMPOSANTS CRITIQUES DE SÛRETÉ. POUR MAINTENIR LE DEGRÉ DE SÛRETÉ DE L'APPAREIL NE REMPLACER LES COMPOSANTS DONT LE FONCTIONNEMENT EST CRITIQUE POUR LA SÛRETÉ QUE PAR DES PIÈCES RECOMMANDÉES PAR LE FABRICANT.

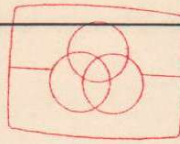
Free service manuals  
Gratis schema's

Digitized by

www.freeservicemanuals.info

## 2) MODEL AM-U61

P.C Board Title	P.C Board Number
POWER P.C Board (U)	A2013D5043
POWER P.C Board (E/V/B/S)	A2013D5073
POWER P.C Board (J)	A2013D5083
POWER P.C Board (C/A)	A2018D5061
EQUALIZER P.C Board	A2018A501A
PIN JACK P.C Board	A2018A501B
MAIN P.C Board (U)	A2018A503A
MAIN P.C Board (J)	A2018A502A
MAIN P.C Board (C/A)	A2018A504A
MAIN P.C Board (E/V/B/S)	A2018A505A
MUTE P.C Board (U)	A2018A503B
MUTE P.C Board (J)	A2018A502B
MUTE P.C Board (C/A)	A2018A504B
MUTE P.C Board (E/V/B/S)	A2018A505B
SPEAKER SW P.C Board (U)	A2018A503C
SPEAKER SW P.C Board (J)	A2018A502C
SPEAKER SW P.C Board (C/A)	A2018A504C
SPEAKER SW P.C Board (E/V/B/S)	A2018A505C
LAMP (1) P.C Board (U)	A2018A503D
LAMP (1) P.C Board (J)	A2018A502D
LAMP (1) P.C Board (C/A)	A2018A504D
LAMP (1) P.C Board (E/V/B/S)	A2018A505D
LAMP (2) P.C Board (U)	A2018A503E
LAMP (2) P.C Board (J)	A2018A502E
LAMP (2) P.C Board (C/A)	A2018A504E
LAMP (2) P.C Board (E/V/B/S)	A2018A505E
HEADPHONES P.C Board (U)	A2018A503H
HEADPHONES P.C Board (J)	A2018A502H
HEADPHONES P.C Board (C/A)	A2018A504H
HEADPHONES P.C Board (E/V/B/S)	A2018A505H
VR (1) P.C Board	A2019C5010
TERMINAL P.C Board	A2018D5070
LED (1) P.C Board (V)	A2018A503G
LED (1) P.C Board (J)	A2018A502G
LED (1) P.C Board (C/A)	A2018A504G
LED (1) P.C Board (E/V/B/S)	A2018A505G
LED (2) P.C Board	A2019D5020

2) Model AM-U61 MAIN P.C Board A2018A503A (U), A2018A502A (J), A2018A504A (C/A), A2018A505A (E/V/B/S)

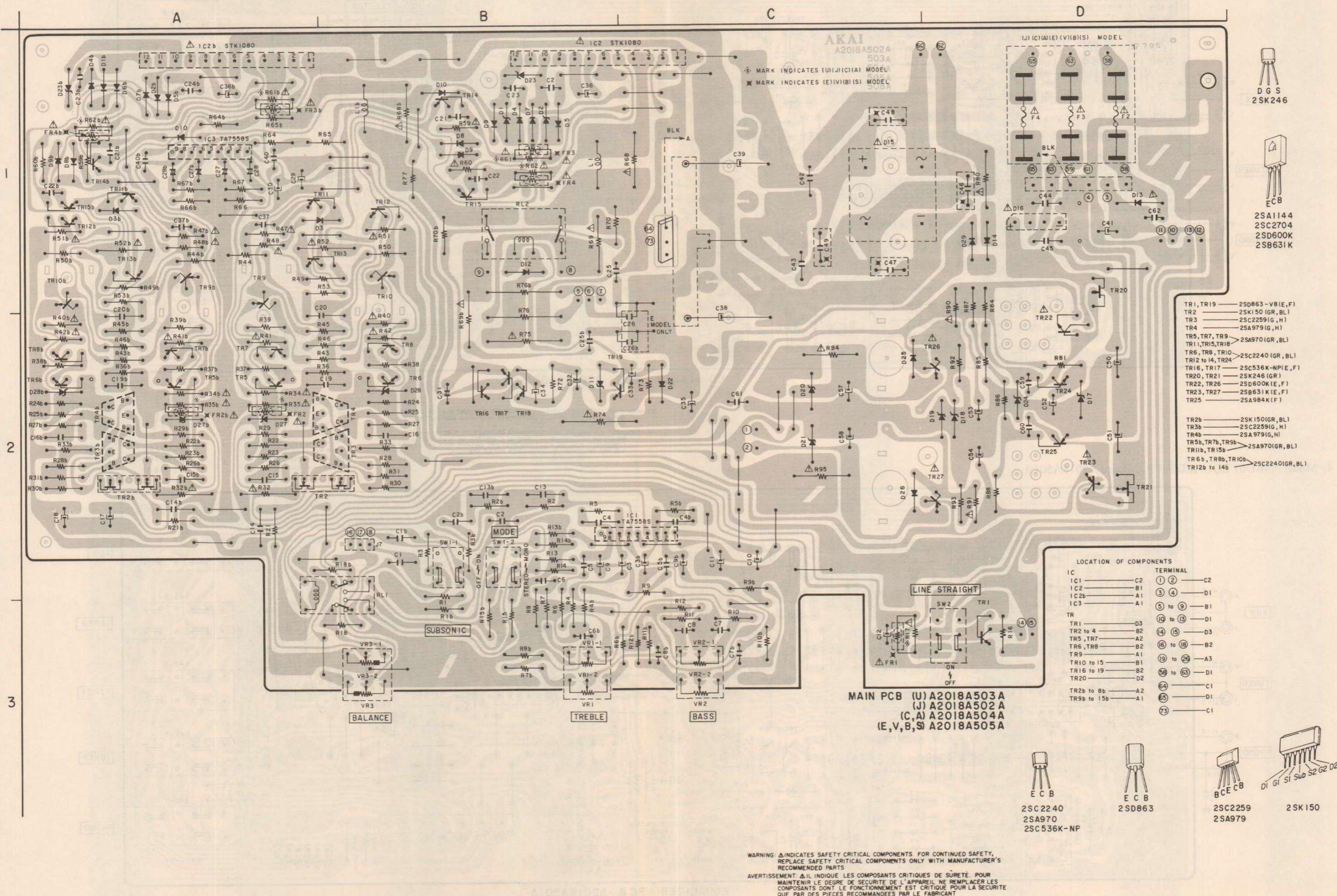

- TR1, TR19 — 2SD863-V8(E,F)
- TR2 — 2SK150 (GR, BL)
- TR3 — 2SC2259(G, H)
- TR4 — 2SA979(G, H)
- TR5, TR7, TR9 — 2SA970(GR, BL)
- TR11, TR15, TR18 — 2SC2240 (GR, BL)
- TR6, TR8, TR10 — 2SC536K-NP(E, F)
- TR12 to 14, TR24 — 2SK246 (GR)
- TR16, TR17 — 2SC536K-NP(E, F)
- TR20, TR21 — 2SK246 (GR)
- TR22, TR26 — 2SD600K(E, F)
- TR23, TR27 — 2SB631K(E, F)
- TR25 — 2SA984K(F)

- TR2b — 2SK150(GR, BL)
- TR3b — 2SC2259(G, H)
- TR4b — 2SA979(G, H)
- TR5b, TR7b, TR9b — 2SA970(GR, BL)
- TR11b, TR15b — 2SC2240(GR, BL)
- TR12b to 14b — 2SK246(GR, BL)

- LOCATION OF COMPONENTS
- |    |                  |          |             |
|----|------------------|----------|-------------|
| IC | IC1 — C2         | TERMINAL | ① ② — C2    |
|    | IC2 — B1         |          | ③ ④ — D1    |
|    | IC2b — A1        |          | ⑤ to ⑨ — B1 |
|    | IC3 — A1         |          | ⑩ to ⑬ — D1 |
| TR | TR1 — D3         |          | ⑭ ⑮ — D3    |
|    | TR2 to 4 — B2    |          | ⑯ to ⑰ — B2 |
|    | TR5, TR7 — A2    |          | ⑱ to ⑳ — A3 |
|    | TR6, TR8 — B2    |          | ㉑ to ㉓ — D1 |
|    | TR9 — A1         |          | ㉔ — C1      |
|    | TR10 to 15 — B1  |          | ㉕ — D1      |
|    | TR16 to 19 — B2  |          | ㉖ — C1      |
|    | TR20 — D2        |          | ㉗ — C1      |
|    | TR2b to 8b — A2  |          |             |
|    | TR9b to 15b — A1 |          |             |

MAIN PCB (U) A2018A503A  
 (J) A2018A502A  
 (C, A) A2018A504A  
 (E, V, B, S) A2018A505A

WARNING: Δ INDICATES SAFETY CRITICAL COMPONENTS. FOR CONTINUED SAFETY, REPLACE SAFETY CRITICAL COMPONENTS ONLY WITH MANUFACTURER'S RECOMMENDED PARTS.  
 AVERTISSEMENT: Δ IL INDIQUE LES COMPOSANTS CRITIQUES DE SÛRETÉ. POUR MAINTENIR LE DEGRÉ DE SÛRETÉ DE L'APPAREIL, NE REMPLACER LES COMPOSANTS DONT LE FONCTIONNEMENT EST CRITIQUE POUR LA SÛRETÉ QUE PAR DES PIÈCES RECOMMANDÉES PAR LE FABRICANT.

- ECB  
2SC2240  
2SA970  
2SC536K-NP
- ECB  
2SD863
- BCECB  
2SC2259  
2SA979
- DI G1 S1 Sub 52 G2 D2  
2SK150

3) Model AM-U41 EQUALIZER P.C Board A2018A501A

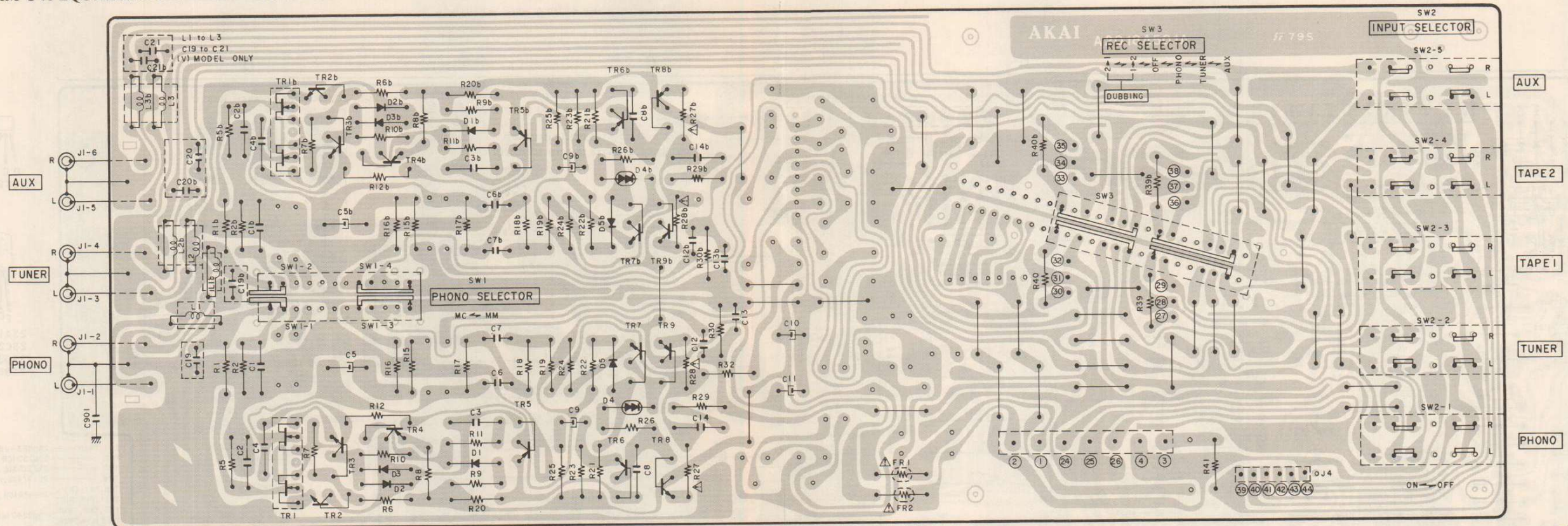

EQUALIZER PCB A2018A501A

WARNING: Δ INDICATES SAFETY CRITICAL COMPONENTS. FOR CONTINUED SAFETY, REPLACE SAFETY CRITICAL COMPONENTS ONLY WITH MANUFACTURER'S RECOMMENDED PARTS.

AVERTISSEMENT: Δ IL INDIQUE LES COMPOSANTS CRITIQUES DE SÛRETÉ. POUR MAINTENIR LE DEGRÉ DE SÛRETÉ DE L'APPAREIL NE REMPLACER LES COMPOSANTS DONT LE FONCTIONNEMENT EST CRITIQUE POUR LA SÛRETÉ QUE PAR DES PIÈCES RECOMMANDÉES PAR LE FABRICANT.

- TR1,1b — 2SK270(GR,BL)
- TR2,2b — 2SC2240(GR,BL)
- TR3,3b — 2SC2240(GR,BL)
- TR7,7b — 2SC2240(GR,BL)
- TR4 to 6 — 2SA970(GR,BL)
- TR8,8b — 2SC2274K(F)
- TR9,9b — 2SA984K(F)

E C B  
2SC2240  
2SA974  
2SA984K

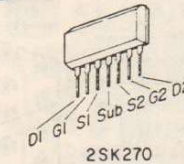

4) Model AM-U61 EQUALIZER P.C Board A2018A501A

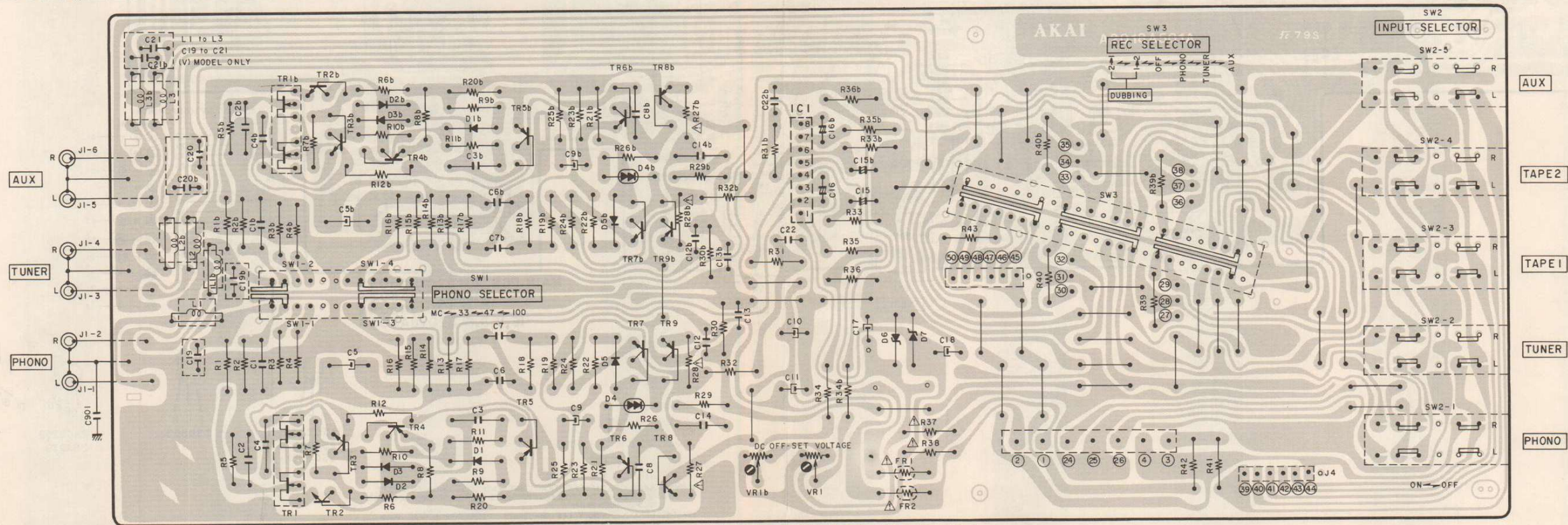

EQUALIZER PCB A2018A501A

5) Model AM-U41/AM-U61 PIN JACK P.C Board A2018A501B (Except V)

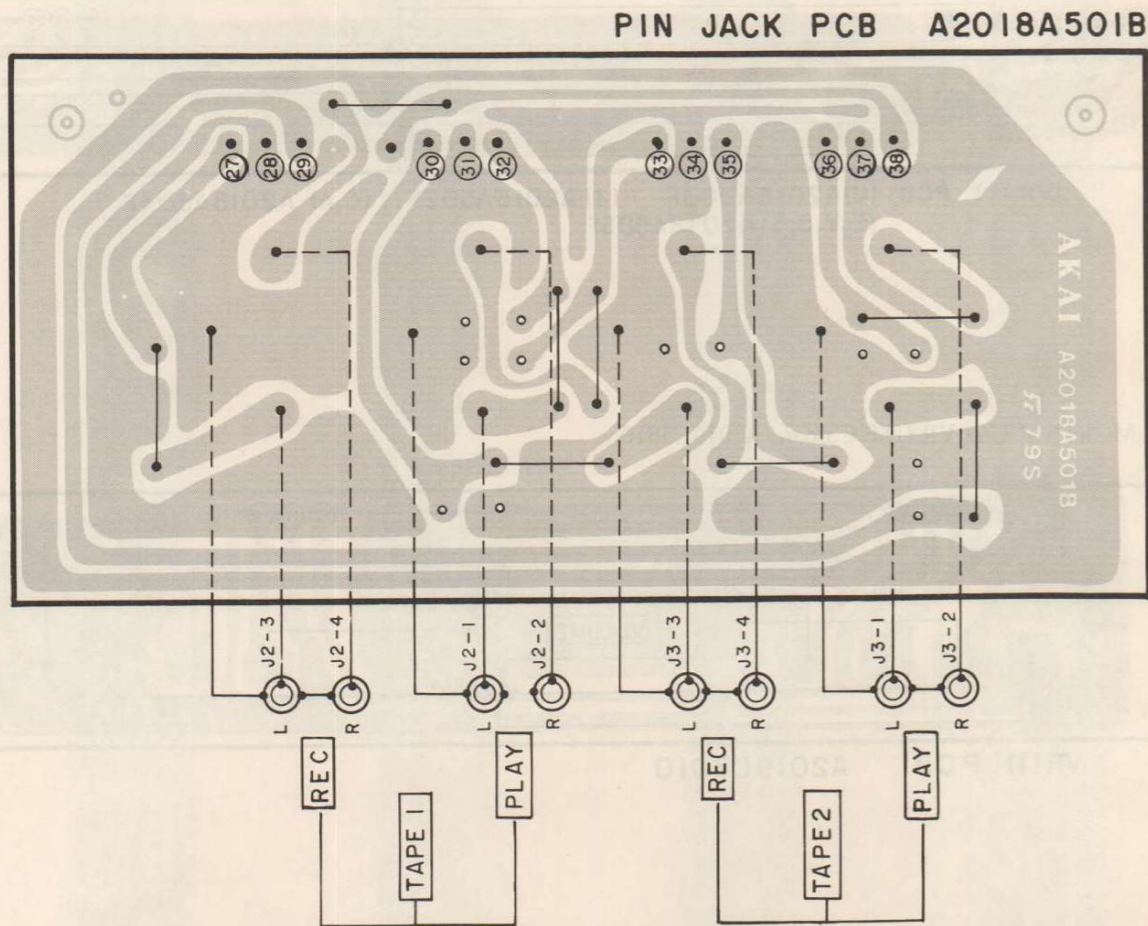

6) Model AM-U41/AM-U61 PIN JACK P.C Board A2018A501B (V only)

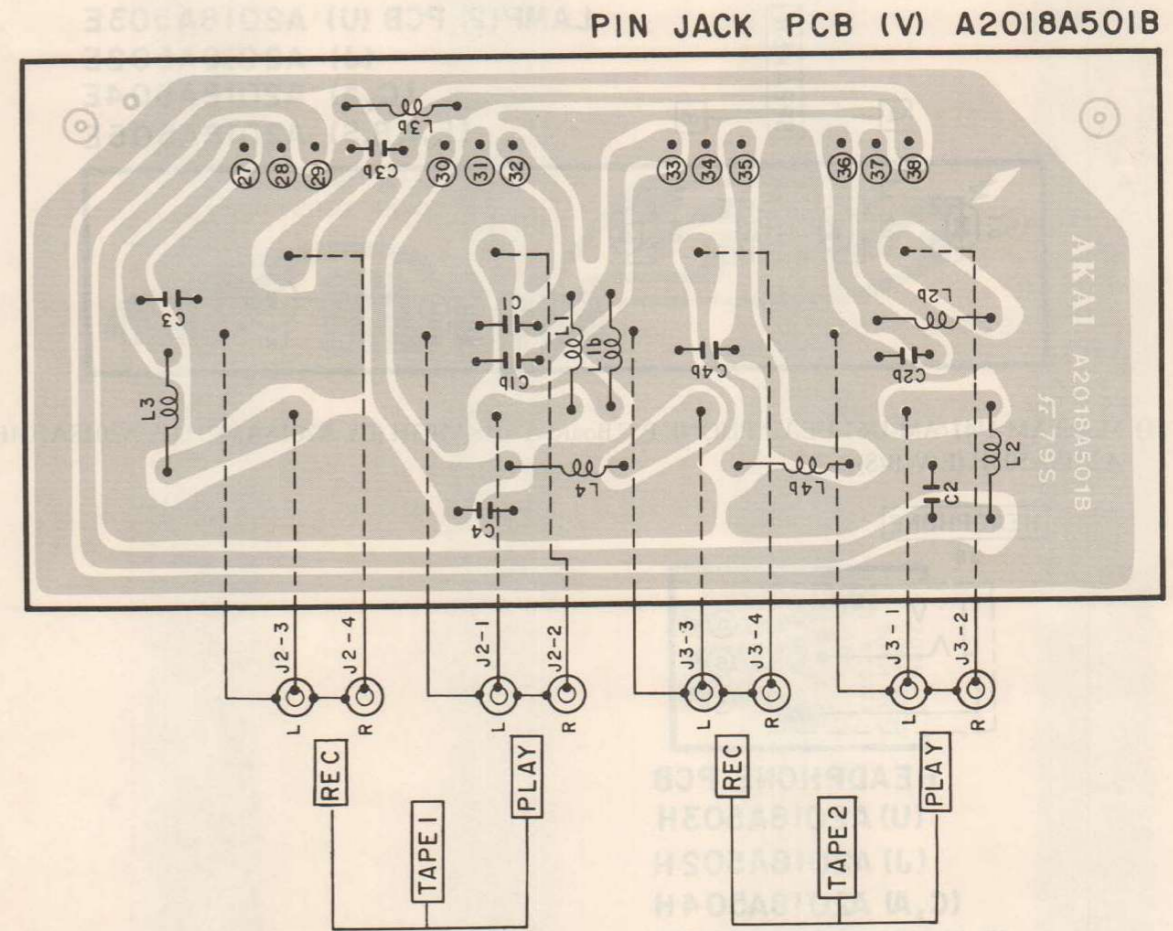

7) Model AM-U41/AM-U61 MUTE P.C Board A2018A503B (U), A2018A502B (J), A2018A504B (C/A), A2018A505B (E/V/B/S)

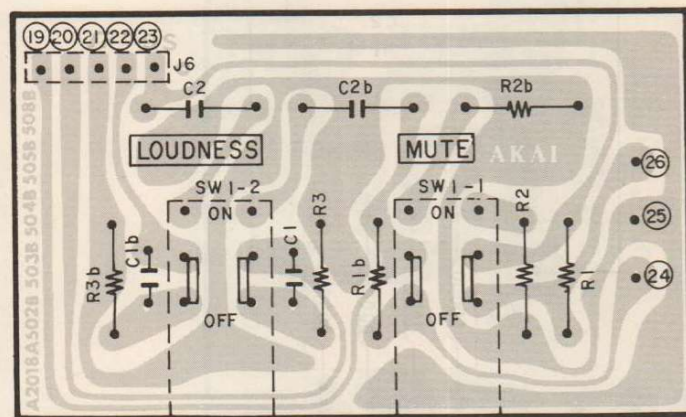

MUTE PCB (U) A2018A503B  
(J) A2018A502B  
(C,A) A2018A504B  
(E,V,B,S) A2018A505B

8) Model AM-U41/AM-U61 SPEAKER SW P.C Board A2018A503C (U), A2018A502C (J), A2018A504C (C/A), A2018A505C (E/V/B/S)

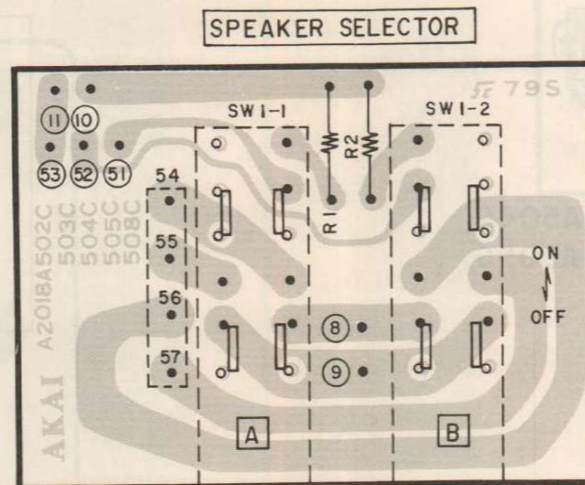

SPEAKER SW PCB (U) A2018A503C  
(J) A2018A502C  
(C,A) A2018A504C  
(E,V,B,S) A2018A505C

9) Model AM-U41/AM-U61 LAMP (I) P.C Board A2018A503D (U), A2018A502D (J), A2018A504D (C/A), A2018A505D (E/V/B/S)

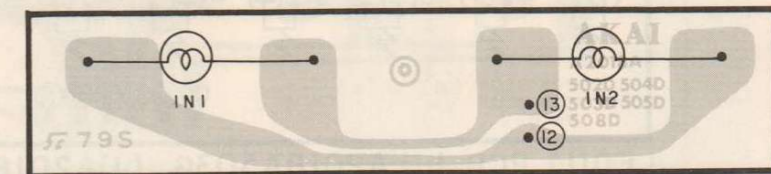

LAMP (I) PCB (U) A2018A503D  
(J) A2018A502D  
(C,A) A2018A504D  
(E,V,B,S) A2018A505D



10) Model AM-U41/AM-U61 LAMP (2) P.C Board A2018A503E (U), A2018A502E (J), A2018A504E (C/A), A2018A505E (E/V/B/S)

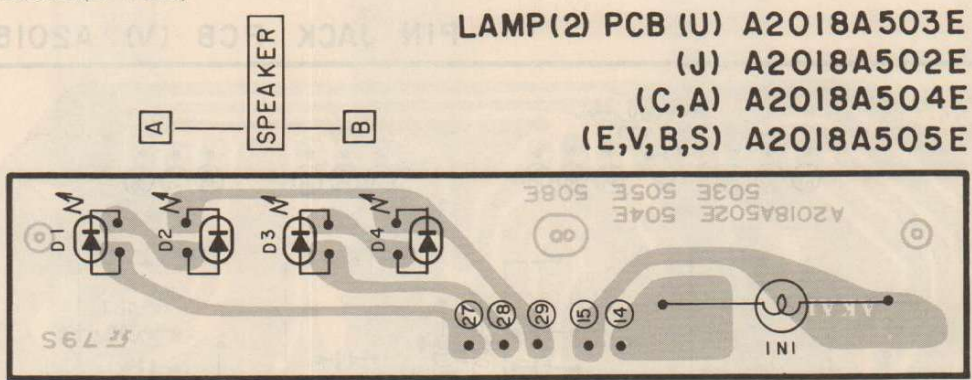

14) Model AM-U41 VR (1) P.C Board A2018A503F (U), A2018A502F (J), A2018A504F (C/A), A2018A505F (E/V/B/S)

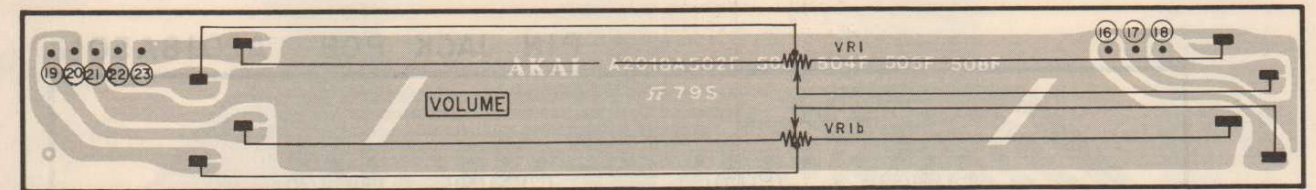

VR (1) PCB (U)A2018A503F (J)A2018A502F (C,A) A2018A504F (E,V,B,S)A2018A505F

11) Model AM-U41/AM-U61 HEAD PHONE P.C Board A2018A503H (U), A2018A502H (J), A2018A504H (C/A), A2018A505H (E/V/B/S)

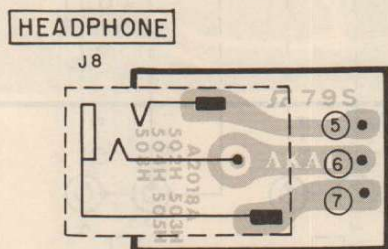

HEADPHONE PCB (U) A2018A503H (J) A2018A502H (C,A) A2018A504H (E,V,B,S) A2018A505H

15) Model AM-U61 VR (1) P.C Board A2019C5010

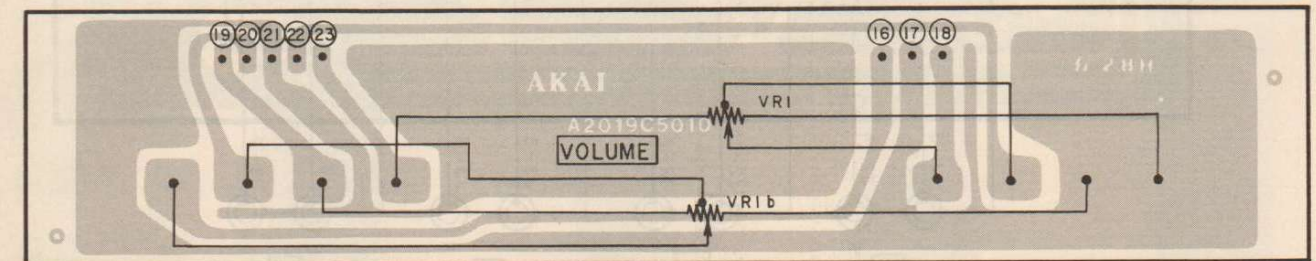

VR (1) PCB A2019C5010

12) Model AM-U41/AM-U61 LED (1) P.C Board A2018A503G (U), A2018A502G (J), A2018A504G (C/A), A2018A505G (E/V/B/S)

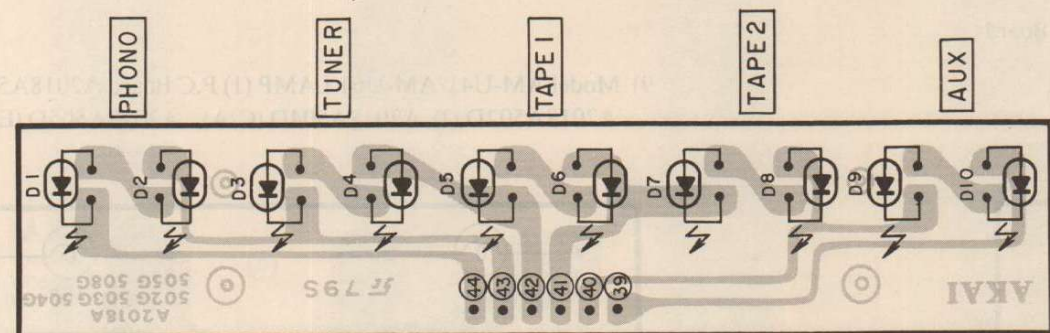

LED(1) PCB (U) A2018A503G (J)A2018A502G (C,A)A2018A504G (E,V,B,S)A2018A505G

16) Model AM-U41/AM-U61 TERMINAL P.C Board A2018A5070

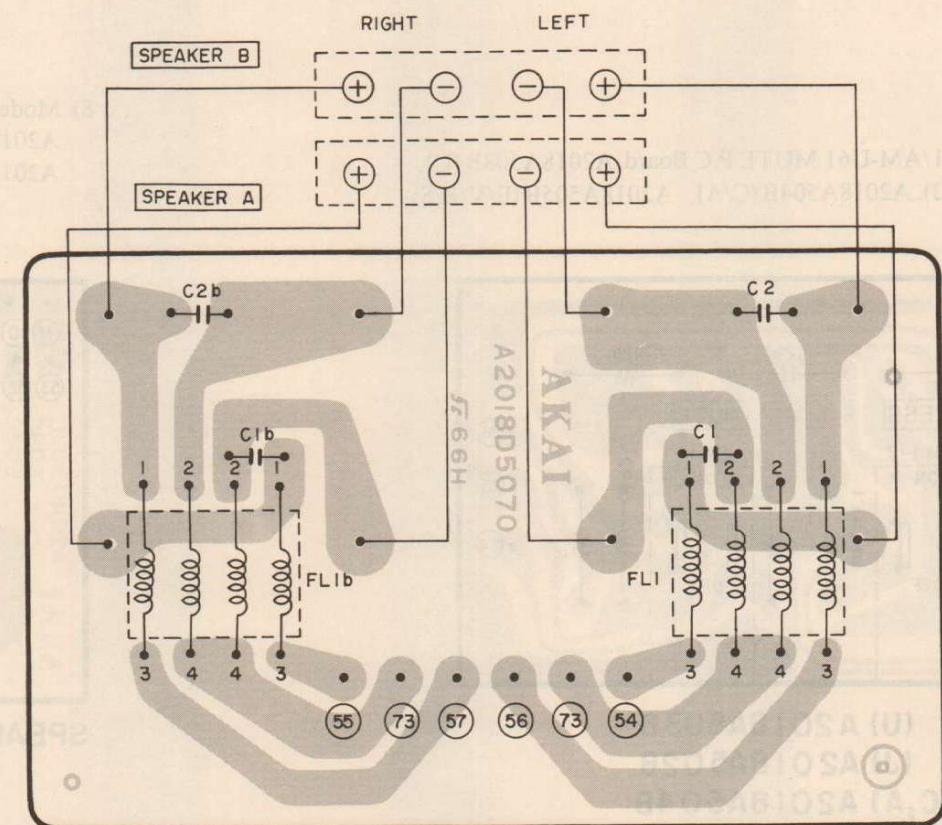

TERMINAL PCB A2018D5070

13) Model AM-U61 LED (2) P.C Board A2019D5020

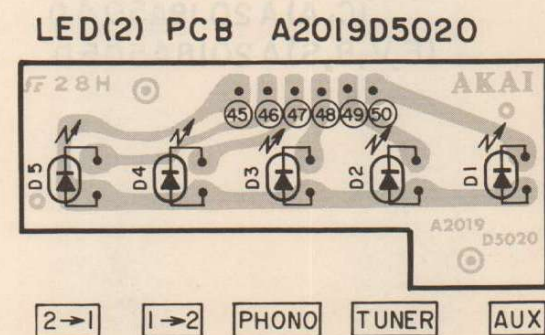

LED(2) PCB A2019D5020

17) Model AM-U41/AM-U61 POWER P.C Board A2013D5042/A2013D5043 (U)

**POWER PCB A2013D5042(AM-U41)  
A2013D5043 (AM-U61)**

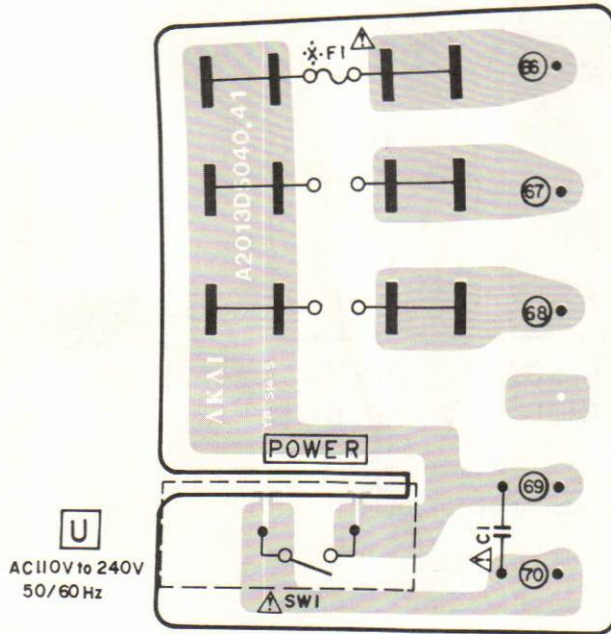

WARNING: ⚠ INDICATES SAFETY CRITICAL COMPONENTS FOR CONTINUED SAFETY. REPLACE SAFETY CRITICAL COMPONENTS ONLY WITH MANUFACTURER'S RECOMMENDED PARTS.  
AVERTISSEMENT: ⚠ IL INDIQUE LES COMPOSANTS CRITIQUES DE SÛRETÉ. POUR MAINTENIR LE DEGRÉ DE SÛRETÉ DE L'APPAREIL, NE REMPLACER LES COMPOSANTS DON'T LE FONCTIONNEMENT EST CRITIQUE POUR LA SÛRETÉ QUE PAR DES PIÈCES RECOMMANDÉES PAR LE FABRICANT.

18) Model AM-U41/AM-U61 POWER P.C Board A2018D5060/A2018D5061 (C/A)

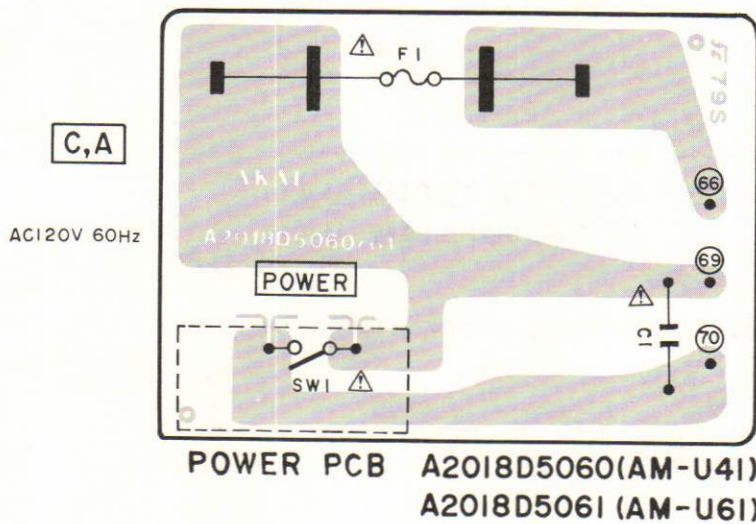

**POWER PCB A2018D5060(AM-U41)  
A2018D5061 (AM-U61)**

19) Model AM-U41/AM-U61 POWER P.C Board A2013D5072/A2013D5073 (E/V/S)

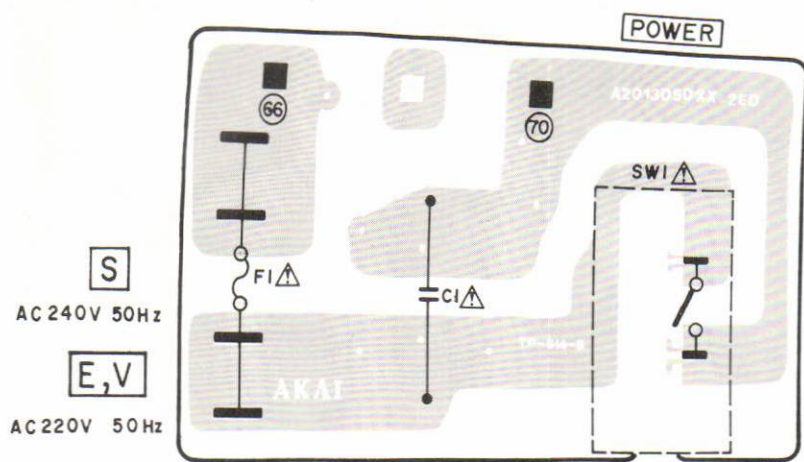

**POWER PCB A2013D5072(AM-U41)  
A2013D5073(AM-U61)**

20) Model AM-U41/AM-U61 POWER P.C Board A2013D5072/A2013D5073 (B)

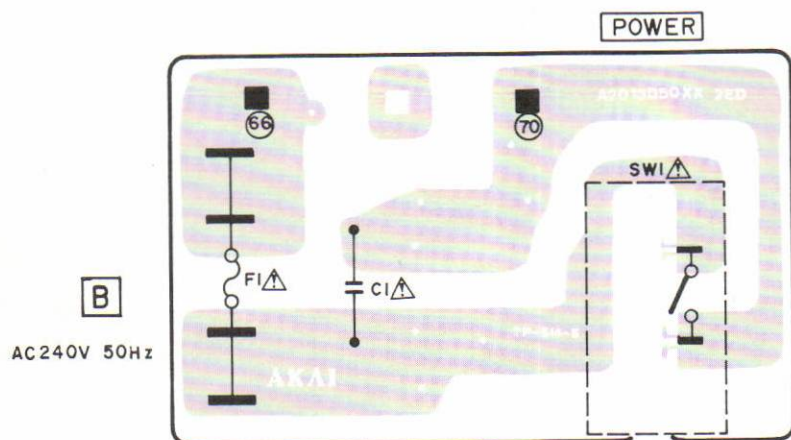

**POWER PCB A2013D5072 (AM-U41)  
A2013D5073 (AM-U61)**

21) Model AM-U41/AM-U61 POWER P.C Board A2013D5082/A2013D5083 (J)

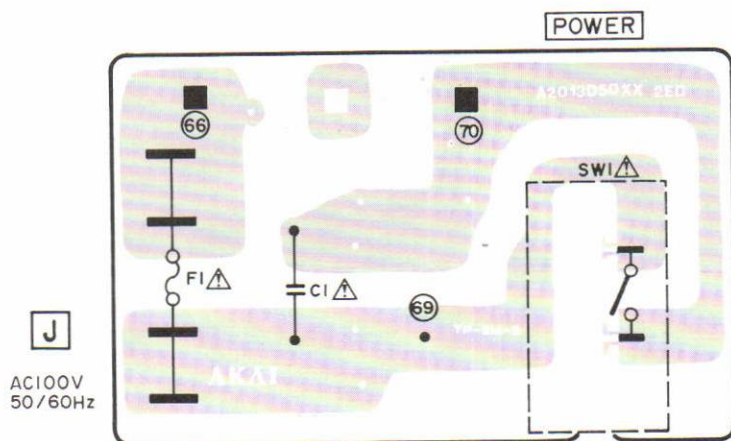

**POWER PCB A2013D5082(AM-U41)  
A2013D5083(AM-U61)**

WARNING: Δ INDICATES SAFETY CRITICAL COMPONENTS. FOR CONTINUED SAFETY, REPLACE SAFETY CRITICAL COMPONENTS ONLY WITH MANUFACTURER'S RECOMMENDED PARTS.  
AVERTISSEMENT: Δ IL INDIQUE LES COMPOSANTS CRITIQUES DE SÛRETÉ. POUR MAINTENIR LE DEGRÉ DE SÛRETÉ DE L'APPAREIL, NE REMPLACER LES COMPOSANTS DONT LE FONCTIONNEMENT EST CRITIQUE POUR LA SÛRETÉ QUE PAR DES PIÈCES RECOMMANDÉES PAR LE FABRICANT.









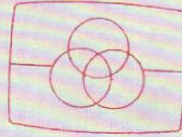

Free service manuals  
Gratis schema's

Digitized by

www.freeservicemanuals.info

### SECTION 3

## PARTS LIST

### TABLE OF CONTENTS

RECOMMENDED SPARE PARTS LIST (AT-S61/L/J) .....	49
1. TUNER P.C BOARD BLOCK .....	50
2. POWER P.C BOARD BLOCK.....	51
3. FILTER P.C BOARD BLOCK (V ONLY).....	51
4. ASSEMBLY BLOCK .....	53
5. FINAL ASSEMBLY BLOCK.....	54
 RECOMMENDED SPARE PARTS LIST (AM-U41) .....	 55
1. MAIN AMP P.C BOARD BLOCK .....	56
2. EQUALIZER P.C BOARD BLOCK .....	57
3. POWER P.C BOARD BLOCK.....	57
4. ASSEMBLY BLOCK .....	59
5. FINAL ASSEMBLY BLOCK.....	60
 RECOMMENDED SPARE PARTS LIST (AM-U61).....	 61
1. MAIN AMP P.C BOARD BLOCK .....	62
2. EQUALIZER P.C BOARD BLOCK .....	63
3. POWER P.C BOARD BLOCK.....	63
4. ASSEMBLY BLOCK .....	65
5. FINAL ASSEMBLY BLOCK.....	66
 INDEX .....	 67

Please refer to COMMON LIST FOR SERVICE PARTS for Resistor and Capacitor not listed in this parts list.



**ATTENTION**

1. When placing an order for parts, be sure to list the parts no., model no., and description. There are instances in which if any of this information is omitted, parts cannot be shipped or the wrong parts will be delivered.
2. Please be careful not to make a mistake in the parts no. If the parts no. is in error, a part different from the one ordered may be delivered.
3. Because parts number and parts unit supply in the Preliminary Parts List may be partially changed, please use this parts list for all future reference.

**HOW TO USE THIS PARTS LIST**

1. This Parts List shows the parts that are considered necessary for repairs. Other parts, such as resistors and capacitors, are shown in the "Common List for Service Parts". Select and order such parts from the "Common List for Service Parts".
2. The Recommended Spare Parts shows those parts in the Parts List which are considered particularly important for service.
3. Parts not shown in the Parts List and "Common List for Service Parts" will not be supplied in principle.
4. How to read list
  - a) Mechanism Block

**2. HEAD BASE BLOCK**

REF. NO.	PARTS NO.	DESCRIPTION
2-1x	BH-T2023A320A	HEAD BASE BLOCK GX-F66R
2-2	HP-H2206A010A	HEAD R/P PR4-8FU C
2-3	ZS-477876	PAN20x03STL CMT
2-4	ZS-536488	BID20x08STL CMT
2-5	ZG-402895	CS ANGLE ADJUST SPRING

SP (Service Parts) Classification

A small "x" indicates the inability to show that particular part in the Photo or Illustration.

This number corresponds with the individual parts index number in that figure

This number corresponds with the Figure Number

**b) P.C Board Block****6. SYS. CON. P.C BOARD BLOCK**

REF. NO.	PARTS NO.	DESCRIPTION
6-1	BA-T2034A070A	PC SYS CON BLK GX-F44R
6-IC1	EI-324536	IC HD14049BP
6-IC2	EI-336801	IC MB8841-564M
6-IC3	EI-331661	IC SN7405N
6-IC4	EI-336725	IC M54527P
6-TR1to4	ET-200985	TR 2SC2603 F,G
6-TR5to28	ET-554657	TR 2SA733A P,Q
6-D1	ED-318292	D SILICON H 1S2473T-77 T26
6-D2to4	ED-308952	D GERMA V 1K34A-LR F07
6-D5to10	ED-318292	D SILICON H 1S2473T-77 T26
6-X1	EI-318384	OSC X'TAL NC-18C 3.579545MHZ

SP (Service Parts) Classification

This reference numbers corresponds with symbol numbers of Schematic Diagrams.

5. Both the kind of part and installation position can be determined by the Parts Number. To determine where a parts number is listed, utilize Parts Index at end of Parts List. It is necessary first of all to find the Parts Number. This can be accomplished by using the Reference Number listed at right of parts number in the Parts Index.

**WARNING**

⚠ INDICATES SAFETY CRITICAL COMPONENTS. FOR CONTINUED SAFETY, REPLACE SAFETY CRITICAL COMPONENTS ONLY WITH MANUFACTURER'S RECOMMENDED PARTS.

**AVERTISSEMENT**

⚠ IL INDIQUE LES COMPOSANTS CRITIQUES DE SURETE. POUR MAINTENIR LE DEGRE DE SECURITE DE L'APPAREIL NE REMPLACER LES COMPOSANTS DONT LE FONCTIONNEMENT EST CRITIQUE POUR LA SECURITE QUE PAR DES PIECES RECOMMANDEES PAR LE FABRICANT.

**I. MODEL AT-S61/L/J**

AT-S61/L/J

**RECOMMENDED SPARE PARTS LIST**

Because, if the parts listed below are on hand, almost any repair can be accomplished, we suggest that you stock these Recommended Spare Parts Items.

REF. NO.	PARTS NO.	DESCRIPTION	REF. NO.	PARTS NO.	DESCRIPTION
1	BT-337978	△ TRANS POWER AT-S61T-11 (J)	59	EO-337572	COIL VARI 2 25-2474 (V)
2	BT-337971	△ TRANS POWER AT-S61T-30 (C, A)	60	EO-337573	COIL VARI 2 25-2475 (V)
3	BT-337973	△ TRANS POWER AT-S61T-40 (B) (E, V)	61	EO-337574	COIL VARI 2 25-2476 (V)
4	BT-337974	△ TRANS POWER AT-S61-T-50 (B) (B, S)	62	EO-337598	COIL VARI 2 25A-1353-01
5	BT-337970	△ TRANS POWER AT-S61T-70 (U)	63	EO-337599	COIL VARI 2 25A-1354-03 (L)
6	EC-336865	C S-FIX H CTZ51C 3.0-10 (EXCEPT L)	64	ER-338408	△ R FUSE ERD2FC F10 1/4W 91R0G (V)
7	EC-337602	C S-FIX H CTZ51E127 4.5-20	65	ER-318248	△ R FUSE ERD2FC 1/4W 47R0G
8	EC-337603	C S-FIX H CTZ51F132 5.5-30	66	ER-337327	FILTER CE BFU459C4N 0.459MHz (EXCEPT C, A)
9	ED-562386	D GERMA H 1S188AM	67	ER-337328	FILTER CE BFU460C4N 0.46MHz (C, A)
10	ED-337413	D LED SLP-135B RED	68	ER-337989	FILTER CE SFE10.7MPKA 10.7MHz
11	ED-337414	D LED SLP-235B GRN	69	ER-337325	FILTER CE SFZ459G3L 0.459MHz (EXCEPT C, A)
12	ED-223547	D SILICON DS131A 100/1.8A	70	ER-337326	FILTER CE SFZ460G3L 0.46MHz (C, A)
13	ED336805	D SILICON DS135D-KB1 200/1.0A	71	ER-341654	FILTER LC LP 42W-1001
14	ED301911	D SILICON H DS448	72	ES-328788	△ SW PUSH ESB-90144T 01-1 UC (C, A)
15	ED-200469	D SILICON H DS448 FA5 F10	73	ES-328787	△ SW PUSH ESB-90149R 01-1 J (J)
16	ED-322238	D SILICON 1B4B41 100/1.0A	74	ES-336909	△ SW PUSH ESB-90259S 01-1 C (U, E, B, S)
17	ED-337605	D VARACTOR SVC333(A) DOUBLE	75	ES-336760	SW TACT EVQ-QJR02K
18	ED323057	D VARISTER MV12	76	ES-328414	SW TACT KHC10901
19	ED-323216	D ZENER H 05Z15 Z	77	ET-323232	TR FET 2SK19 Y
20	ED337606	D ZENER H 05Z6.2 Y	78	ET-336864	TR FET 2SK223 F
21	ED-300257	D ZENER H 05Z6.8 X	79	ET-337604	TR FET 2SK246 Y
22	EE-337571	FRONT END FD632J16 76-90MHz (J)	80	ET-322778	TR 2SA608K-NP E, F, G
23	EE-337570	FRONT END FD632U14 87-108MHz (EXCEPT J)	81	ET-316643	TR 2SC536K-NP F, G
24	EF-322975	△ FUSE EAWK T 250V 0.16A (F3) (E, B, S, V)	82	ET-307193	TR 2SD612K D, E, F
25	EF-322975	△ FUSE EAWK T 250V 0.16A (F5) (E, B, S, V)	83	EV-337995	R S-FIX H RVF8P01 3P 103
26	EF-300588	△ FUSE EAWK T 250V 0.20A (F4) (E, B, S, V)	84	EV-337996	R S-FIX H RVF8P01 3P 104
27	EF-300599	△ FUSE FST3100 T 250V 0.40A (F1, 2) (E, B, S, V)	85	EV-337993	R S-FIX H RVF8P01 3P 203
28	EF-308933	△ FUSE TSC A 250V 0.20A (F1) (U)	86	EV-338588	R S-FIX H RVF8P01 3P 503
29	EF-309389	△ FUSE TSC A 250V 0.40A (F1) (U)			
30	EF-327103	△ FUSE TSC A 250V 0.50A (F1) (J)			
31	EF-315334	△ FUSE TSC 125V 0.25A (F5) (C, A)			
32	EF-306088	△ FUSE TSC 125V 0.31A (F4) (C, A)			
33	EF-309390	△ FUSE TSC 125V 0.50A (F1, 2, 3) (C, A)			
34	EI-337600	IC AT600			
35	EI-337363	IC LA1222			
36	EI-337417	IC LA1235			
37	EI-202218	IC LA1245			
38	EI-332206	IC LA3381			
39	EI-336761	IC LA6458S			
40	EI-336794	IC LB1240			
41	EI-337365	IC LB1426			
42	EI-338171	IC LC4069UB			
43	EI-332287	IC M54517P			
44	EI-315379	IC TC5066BP			
45	EI-336717	IC TC9125BP			
46	EI-315381	IC TD6102P			
47	EI-338675	IC UPC78M24H			
48	EI-327074	OSC X'TAL HC-18/U 9MHz			
49	EL-337975	PL CORD 9.0V 40MA 140/140			
50	EM-337426	IND FL 9-BT-01ZK CHARACTER			
51	EO-336878	COIL DET 2 78-1049			
52	EO-336879	COIL DET 2 78-1050			
53	EO-337607	COIL IFT 08A-04 460KHz			
54	EO-202216	COIL IFT 7MC-6733C 460KHz			
55	EO-336833	COIL IFT 7MC-7736Z 460KHz			
56	EO-202215	COIL OSC 2 7NR6721Y 100μH			
57	EO-307786	COIL OSC 2 7NR-6722Y 580μH (L)			
58	EO-337415	COIL VARI 1 126xGS-6323Z 19KHz			

When ordering parts, please quote Parts Number, Description and Model Number.

## 1. TUNER P.C BOARD BLOCK

REF. NO.	PARTS NO.	DESCRIPTION	REF. NO.	PARTS NO.	DESCRIPTION
1-1	BA-A3027A030A	PC TUNER BLK AT-S61 (U)	1-D31, 32	ED-301911	△ D SILICON H DS448
1-2	BA-A3027A030B	PC TUNER BLK AT-S61 (C) (C, A)	1-D33, 34	ED-323216	△ D ZENER H 05Z15 Z
1-3	BA-A3027A030C	PC TUNER BLK AT-S61 (E) (E, S)	1-D35	ED-223547	△ D SILICON DS131A 100/1.8A
1-4	BA-A3027A030D	PC TUNER BLK AT-S61 (V)	1-D36	ED-200469	D SILICON H DS448 FA5 F10
1-5	BA-A3027A030E	PC TUNER BLK AT-S61L	1-D37 to 39	ED-301911	D SILICON H DS448
1-6	BA-A3027A030F	PC TUNER BLK AT-S61-J	1-D40	ED-323057	D VARISTER MV12
			1-D41	ED-336805	△ D SILICON DS135D-KB1 200/1.0A
<b>TUNER P.C BOARD BLOCK</b>					
1-7	EE-337570	FRONT END FD632U14 87-108MHz (EXCEPT J)	1-D42	ED-322238	△ D SILICON 1B4B41 100/1.0A
1-8	EE-337571	FRONT END FD632J16 76-90MHz (J)	1-D43	ED-300257	D ZENER H 05Z6.8 X
			1-D44	ED-337606	D ZENER H 05Z6.2 Y
			1-D45	ED-323216	D ZENER H 05Z15 Z
1-IC1	EI-337363	IC LA1222	1-J1	EJ-337424	PIN J AJC-034-AA8 P 2P
1-IC2	EI-337417	IC LA1235	1-J2	EJ-324276	DIN J TCS4680-01-111 P 8P
1-IC3	EI-336761	IC LA6458S (V)	1-SW1	ES-328414	SW TACT KHC10901
1-IC4	EI-336761	IC LA6458S	1-VR1	EV-338588	R S-FIX H RVF8P01 3P 503
1-IC5	EI-332206	IC LA3381	1-VR2	EV-337993	R S-FIX H RVF8P01 3P 203
1-IC6	EI-202218	IC LA1245	1-VR3	EV-337995	R S-FIX H RVF8P01 3P 103 (J)
1-IC7	EI-315381	IC TD6102P	1-VR4 to 6	EV-337993	R S-FIX H RVF8P01 3P 203
1-IC8	EI-336717	IC TC9125BP	1-VR7	EV-337995	R S-FIX H RVF8P01 3P 103
1-IC9	EI-337600	IC AT600	1-VR8	EV-337996	R S-FIX H RVF8P01 3P 104
1-IC10	EI-338171	IC LC4069UB	1-L1	EO-337608	COIL FIX 1 LAL04 2.2μH M
1-IC11	EI-332287	IC M54517P	1-L2, 3	EO-318365	COIL FIX 1 LAL04 1MH K
1-IC12	EI-315379	IC TC5066BP	1-L4	EO-318380	COIL FIX 1 LAL04 270μH K
1-IC13	EI-336794	IC LB1240	1-L5	EO-336934	COIL FIX 1 LAL03KH 2.2μH M
1-IC14	EI-337365	IC LB1426	1-T1	EO-336878	COIL DET 2 78-1049
1-IC15	EI-338675	△ IC UPC78M24H	1-T2	EO-336879	COIL DET 2 78-1050
1-TR1	ET-322778	TR 2SA608K-NP E, F, G	1-T3	EO-337572	COIL VARI 2 25-2474 (V)
1-TR2 to 5	ET-316643	TR 2SC536K-NP F, G	1-T4	EO-337573	COIL VARI 2 25-2475 (V)
1-TR6	ET-322778	TR 2SA608K-NP E, F, G	1-T5	EO-337574	COIL VARI 2 25-2476 (V)
1-TR7	ET-337604	TR FET 2SK246 Y	1-T6, 7	EO-337415	COIL VARI 1 126×GS-6323Z 19KHz
1-TR8	ET-337604	TR FET 2SK246 Y	1-T8	EO-337598	COIL VARI 2 25A-1353-01
1-TR9 to 13	ET-316643	TR 2SC536K-NP F, G	1-T9	EO-337599	COIL VARI 2 25A-1354-03 (L)
1-TR14 to 16	ET-337604	TR FET 2SK246 Y	1-T10	EO-202215	COIL OSC 2 7NR-6721Y 100μH
1-TR17	ET-322778	TR 2SA608K-NP E, F, G	1-T11	EO-307786	COIL OSC 2 7NR-6722Y 580μH (L)
1-TR18	ET-316643	TR 2SC536K-NP F, G (L)	1-T12	EO-337607	COIL IFT 08A-04 460KHz
1-TR19 to 22	ET-322778	TR 2SA608K-NP E, F, G (L)	1-T13	EO-202216	COIL IFT 7MC-6733C 460KHz
1-TR23	ET-316643	TR 2SC536K-NP F, G (L)	1-T14	EO-336833	COIL IFT 7MC-7736Z 460KHz
1-TR24	ET-323232	TR FET 2SK19 Y (L)	1-FL1 to 3	ER-337989	FILTER CE SFE10.7MPKA 10.7MHz
1-TR26	ET-316643	TR 2SC536K-NP F, G (L)	1-FL4	ER-341654	FILTER LC LP 42W-1001
1-TR27	ET-316643	TR 2SC536K-NP F, G	1-FL5	ER-337325	FILTER CE SFZ459G3L 0.459MHz (EXCEPT C, A)
1-TR28	ET-336864	TR FET 2SK223 F (L)	1-FL5	ER-337326	FILTER CE SFZ460G3L 0.46MHz (C, A)
1-TR29	ET-336864	TR FET 2SK223 F	1-FL6	ER-337327	FILTER CE BFU459C4N 0.459MHz (EXCEPT C, A)
1-TR30	ET-322778	TR 2SA608K-NP E, F, G	1-FL6	ER-337328	FILTER CE BFU460C4N 0.46MHz (C, A)
1-TR31	ET-316643	TR 2SC536K-NP F, G	1-X1	EI-327074	OSC X'TAL HC-18/U 9MHz
1-TR32 to 35	ET-316643	TR 2SC536K-NP F, G (L)	1-FR1	ER-318248	△ R FUSE ERD2FC 1/4W 47R0G (EXCEPT V)
1-TR36 to 44	ET-316643	TR 2SC536K-NP F, G	1-FR1	ER-338408	△ R FUSE ERD2FC F10 1/4W 91R0G (V)
1-TR45	ET-322778	TR 2SA608K-NP E, F, G	1-FR2	ER-318248	△ R FUSE ERD2FC 1/4W 47R0G
1-TR46	ET-322778	TR 2SA608K-NP E, F, G (L)	1-R5	ER-324480	△ R CB H SNP FS RDS 1/4W 470J
1-TR47	ET-322778	TR 2SA608K-NP E, F, G	1-R7	ER-324184	△ R CB H SNP FS RDS 1/4W 121J
1-TR48	ET-316643	TR 2SC536K-NP F, G	1-R24	ER-324184	△ R CB H SNP FS RDS 1/4W 121J
1-TR49	ET-307193	△ TR 2SD612K D, E, F	1-R38	ER-324184	△ R CB H SNP FS RDS 1/4W 121J
1-TR50	ET-322778	TR 2SA608K-NP E, F, G	1-R55	ER-324184	△ R CB H SNP FS RDS 1/4W 121J (V)
1-TR51, 52	ET-316643	TR 2SC536K-NP F, G	1-R62	ER-324184	△ R CB H SNP FS RDS 1/4W 121J
1-TR53	ET-307193	△ TR 2SD612K D, E, F	1-R118	ER-324185	△ R CB H SNP FS RDS 1/4W 221J (EXCEPT L)
1-D1 to 3	ED301911	D SILICON H DS448	1-R118	ER-324184	△ R CB H SNP FS RDS 1/4W 121J (L)
1-D4	ED-200469	D SILICON H DS448 FA5 F10 (L)	1-R124	ER-324184	△ R CB H SNP FS RDS 1/4W 121J
1-D5, 6	ED-562386	D GERMA H 1S188AM	1-R129	ER-322787	△ R CB H SNP FS RDS 1/4W 100J
1-D7 to 9	ED-301911	D SILICON H DS448	1-R204	ER-324186	△ R CB H SNP FS RDS 1/4W 681J
1-D10, 11	ED-337605	D VARACTOR SVC333 (A) DOUBLE	1-R222	ER-324186	R CB H SNP FS RDS 1/4W 681J
1-D12	ED-323057	D VARISTER MV12	1-C42	EC-330309	C STY F05 CQ09S 511J 50DC (EXCEPT C, A)
1-D13, 14	ED-301911	D SILICON H DS448	1-C42	EC-323252	C STY V CQ09S 771J 50DC (C, A)
1-D15	ED-200469	D SILICON H DS448 FA5 F10			
1-D16	ED-200469	D SILICON H DS448 FA5 F10 (L)			
1-D17	ED-301911	D SILICON H DS448			
1-D18	ED-200469	D SILICON H DS448 FA5 F10			
1-D19 to 21	ED-301911	D SILICON H DS448			
1-D22, 23	ED-200469	D SILICON H DS448 FA5 F10 (L)			
1-D24	ED-200469	D SILICON H DS448 FA5 F10 (J)			
1-D25, 26	ED-200469	D SILICON H DS448 FA5 F10 (C, A)			
1-D27	ED-200469	D SILICON H DS448 FA5 F10 (V)			
1-D28	ED-200469	D SILICON H DS448 FA5 F10			
1-D29, 30	ED-200469	D SILICON H DS448 FA5 F10 (V)			

When ordering parts, please quote Parts Number, Description and Model Number.

REF. NO.	PARTS NO.	DESCRIPTION
1-C43	EC-330309	C STY F05 CQ09S 511J 50DC (EXCEPT C, A)
1-C43	EC-323252	C STY V CQ09S 771J 50DC (C, A)
1-C64	EC-300448	C STY V F05 CQ09S 4900G 50DC (EXCEPT L)
1-C64	EC-338585	C STY V SNP CQFS 4700G 50DC (L)
1-C65	EC-334065	C STY V F05 CQ09S 161J 50DC (L)
1-C106	EC-337581	C EC 224 5DC
1-C119, 120	EC-320548	C CE V F 103Z 250AC
1-VC1	EC-336865	C S-FIX H CTZ51C 3.0-10 (EXCEPT L)
1-VC1	EC-337603	C S-FIX H CTZ51F132 5.5-30 (L)
1-VC2	EC-337602	C S-FIX H CTZ51E127 4.5-20 (L)
1-VC3	EC-337603	C S-FIX H CTZ51F132 5.5-30
1-TM1	EJ-341367	TERMINAL W/SCREW T5827 P 3P (U)
1-TM1	EJ-337595	TERMINAL W/SCREW T5820 P 2P (C, A, J)
1-TM1	EJ-337596	TERMINAL W/SCREW T5819 P 2P (E, B, S)
1-TM1	EJ-337597	TERMINAL W/SCREW T5818 P 2P (V)
<b>OPERATION P.C BOARD BLOCK</b>		
1-IN1	EM-337426	IND FL 9-BT-01ZK CHARACTER
1-D1 to 3	ED-337414	D LED SLP-235B GRN
1-D4 to 6	ED-301911	D SILICON H DS448
1-D7 to 13	ED-337414	D LED SLP-235B GRN
1-D14	ED-337413	D LED SLP-135B RED
1-SW1 to 20	ES-336760	SW TACT EVQ-QJR02K

## 2. POWER P.C BOARD BLOCK

REF. NO.	PARTS NO.	DESCRIPTION
2-SW1	ES-336909	△ SW PUSH ESB-90259S 01-1 C (U, E, B, S)
2-SW1	ES-328788	△ SW PUSH ESB-90144T 01-1 UC (C, A)
2-SW1	ES-328787	△ SW PUSH ESB-90149R 01-1 J (J)
2-C1	EC-320548	△ C CE V F 103Z 250AC (U, J)
2-C1	EC-314688	△ C CE V FZ 103P 125AC (C, A)
2-C1	EC-338496	△ C CE V FZ 472P 400AC (E, B, S)
2-C1	EC-338577	△ C CE V F 472M 400AC (E, B) (L)

## 3. FILTER P.C BOARD BLOCK (V ONLY)

REF. NO.	PARTS NO.	DESCRIPTION
<b>FILTER P.C BOARD BLOCK (V ONLY)</b>		
3-FL1	EO-338409	△ COIL LF FKOB160MH02 250μH (V)
<b>POWER P.C BOARD BLOCK (V ONLY)</b>		
3-SW1	ES-336909	△ SW PUSH ESB-90259S 01-1 C (V)
3-C1	EC-338496	△ C CE V FZ 472P 400AC (V)

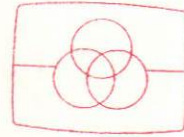

Free service manuals

Gratis schema's

Digitized by

www.freesevicemanuals.info

ASSEMBLY BLOCK

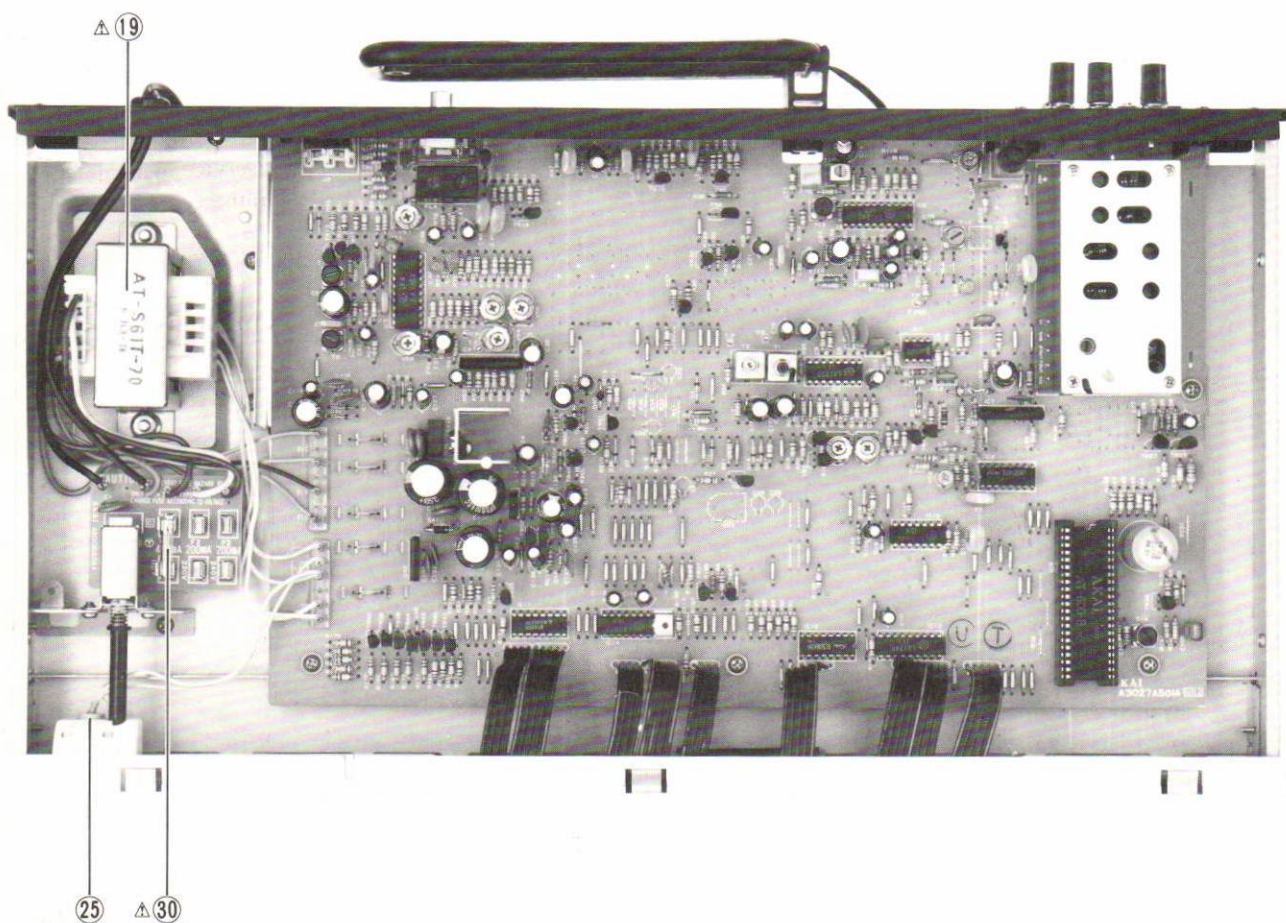
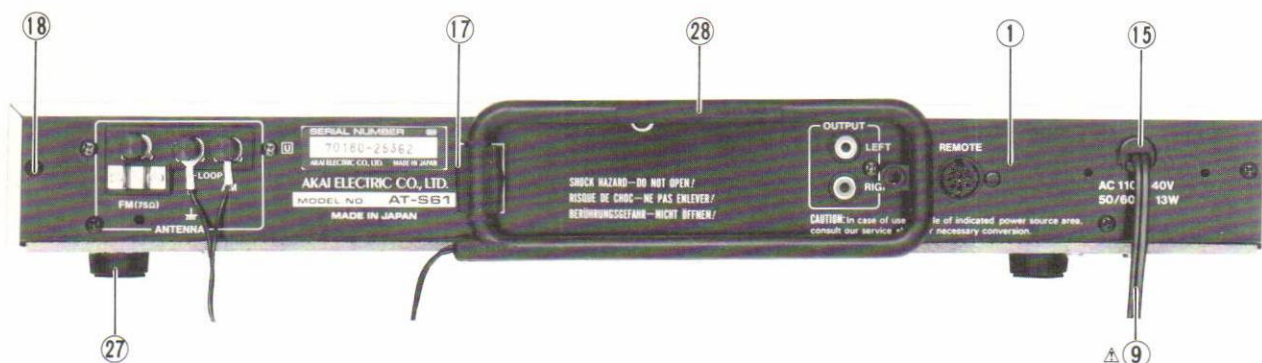

## 4. ASSEMBLY BLOCK

REF. NO.	PARTS NO.	DESCRIPTION
4-1	SP-332734A	PANEL REAR AT-S61(U)
4-2x	SP-332734B	PANEL REAR AT-S61(C)
4-3x	SP-332734C	PANEL REAR AT-S61 (A)
4-4x	SP-332734D	PANEL REAR AT-S61 (E, V)
4-5x	SP-332734E	PANEL REAR AT-S61 (S)
4-6x	SP-332734F	PANEL REAR AT-S61L (E)
4-7x	SP-332734G	PANEL REAR AT-S61L (B)
4-8x	SP-332734H	PANEL REAR AT-S61 (J)
4-9	EW-306428	△ AC CORD 2 CORES KP-205A, VFF J (U)
4-10x	EW-306427	△ AC CORD 2 CORES KP-211, VFF J (J)
4-11x	EW-305691	△ AC CORD 2 CORES KP-8, SPT-1 UC (C, A)
4-12x	EW-336923	△ AC CORD 2 CORES KP-419C, LTCE-2F E (E, S)
4-13x	EW-336926	△ AC CORD GTBS-2F 24/0.20x2 B (B)
4-14x	EW-336924	△ AC CORD 2 CORES KP-560, LTSA-2F S (V)
4-15	SZ-631945	STRAIN RELIEF SR-4N-4 (EXCEPT B)
4-16x	EJ-692908	STRAIN RELIEF SR-5N-4 (B)
4-17	SZ-332739	HOLDER ANTENNA
4-18	ZS-319460	T2BR30x06STL BZN PROJECTION
4-19	BT-337970	△ TRANS POWER AT-S61T-70 (U)
4-20x	BT-337978	△ TRANS POWER AT-S61T-11 (J)
4-21x	BT-337971	△ TRANS POWER AT-S61T-30 (C, A)
4-22x	BT-337973	△ TRANS POWER AT-S61T-40 (B) (E, V)
4-23x	BT-337974	△ TRANS POWER AT-S61T-50 (B) (B, S)
4-24x	ZW-698308	RV NYL30x055 BL
4-25	EL-337975	PL CORD 9.0V 40MA 140/140 (IN901)
4-26x	SP-332738	COVER BOTTOM
4-27	SA-332850	ROUND FOOT
4-28	EE-337976	ANT LOOP LA-200A
4-29x	ZW-305013	RV POP32 (A)
4-30	EF-308933	△ FUSE TSC A 250V 0.20A (F1) (U)
4-31x	EF-309389	△ FUSE TSC A 250V 0.40A (F1) (U)
4-32x	EF-327103	△ FUSE TSC A 250V 0.50A (F1) (J)
4-33x	EF-309390	△ FUSE TSC 125V 0.50A (F1, 2, 3) (C, A)
4-34x	EF-306088	△ FUSE TSC 125V 0.31A (F4) (C, A)
4-35x	EF-315334	△ FUSE TSC 125V 0.25A (F5) (C, A)
4-36x	EF-300599	△ FUSE FST3100 T 250V 0.40A (F1, 2) (E, B, S, V)
4-37x	EF-322975	△ FUSE EAWK T 250V 0.16A (F3) (E, B, S, V)
4-38x	EF-300588	△ FUSE EAWK T 250V 0.20A (F4) (E, B, S, V)
4-39x	EF-322975	△ FUSE EAWK T 250V 0.16A (F5) (E, B, S, V)

## FINAL ASSEMBLY BLOCK

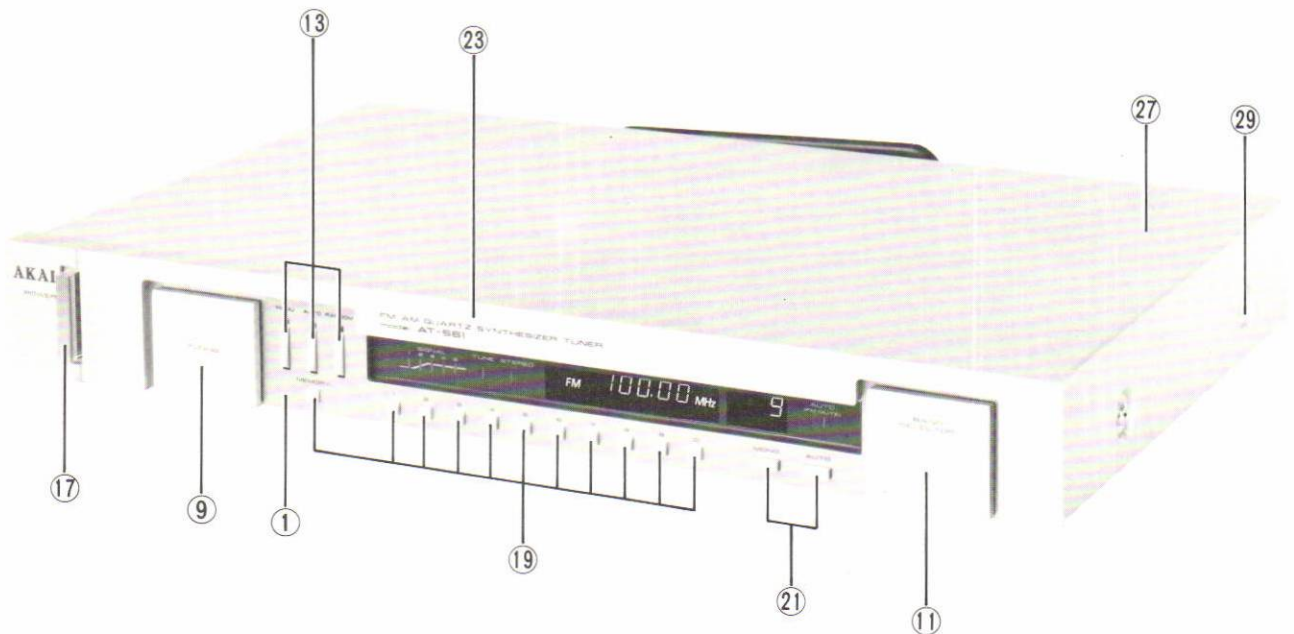

### 5. FINAL ASSEMBLY BLOCK

REF. NO.	PARTS NO.	DESCRIPTION	REF. NO.	PARTS NO.	DESCRIPTION
<b>PANEL OPERATION BLOCK</b>			<b>FINAL ASSEMBLY BLOCK</b>		
5-1	BD-A3027A020A	PANEL OPERATION BLK AT-S61 (AT-S61/L)	5-17	SK-332744	KNOB POWER
5-2x	BD-A3027A020B	PANEL OPERATION BLK AT-S61-P (AT-S61-P/LP)	5-18x	ZG-313182	SP C-4.5/0.35-25.0 C-029
5-3x	BD-A3027A020C	PANEL OPERATION BLK AT-S61-J	5-19	SK-342499A	KNOB PUSH (B-1)
5-4x	BD-A3027A020D	PANEL OPERATION BLK AT-S61-JP	5-20x	SK-342499B	KNOB PUSH (B-1)-P
5-5x	SP-332743A	PANEL OPERATION (A) (AT-S61/L)	5-21	SK-342499C	KNOB PUSH (B-2)
5-6x	SP-332743B	PANEL OPERATION (A)-P (AT-S61-P/LP)	5-22x	SK-342499D	KNOB PUSH (B-2)-P
5-7x	SP-332743C	PANEL OPERATION (B) (AT-S61J)	5-23	SP-332753A	PANEL FRONT AT-S61 (AT-S61/J)
5-8x	SP-332743D	PANEL OPERATION (B)-P (AT-S61JP)	5-24x	SP-332753B	PANEL FRONT AT-S61-P (AT-S61P/JP)
5-9	SK-332745A	KNOB TUNING	5-25x	SP-332753C	PANEL FRONT AT-S61L
5-10x	SK-332745B	KNOB TUNING-P	5-26x	SP-332753D	PANEL FRONT AT-S61L-P
5-11	SK-332747A	KNOB BAND	5-27	SP-332752A	COVER UPPER
5-12x	SK-332747B	KNOB BAND-P	5-28x	SP-332752B	COVER UPPER-P
5-13	SK-332750A	KNOB PUSH (A)	5-29	ZS-322570	ST BID40x08STL NI3
5-14x	SK-332750B	KNOB PUSH (A)-P	5-30x	ZS-322580	ST BID40x08STL BNI
5-15x	SE-342181	MASK LED			
5-16x	SZ-332748	WIND FRONT			

When ordering parts, please quote Parts Number, Description and Model Number.

## II. MODEL AM-U41

AM-U41

### RECOMMENDED SPARE PARTS LIST

Because, if the parts listed below are on hand, almost any repair can be accomplished, we suggest that you stock these Recommended Spare Parts Items.

REF. NO.	PARTS NO.	DESCRIPTION	REF. NO.	PARTS NO.	DESCRIPTION
1	BT-341430	△ TRANS POWER AMU-41T-10 (J)	50	ES-323369	SW REMOTE S SSR24602D 04-6
2	BT-341431	△ TRANS POWER AMU-41T-20 (A)	51	ES-337398	SW REMOTE W SBU0006F L=120
3	BT-341432	△ TRANS POWER AMU-41T-30 (C)	52	ET-337984	TR FET 2SK150 BL, GR
4	BT-341433	△ TRANS POWER AMU-41T-40 (E, V)	53	ET-337759	TR FET 2SK246 GR
5	BT-341434	△ TRANS POWER AMU-41T-50 (B, S)	54	ET-337234	TR FET 2SK270 GR, BL
6	BT-341435	△ TRANS POWER AMU-41T-70 (U)	55	ET-200479	TR 2SA1115 D, E, F
7	ED-337391	D LED GL-5NG6 GRN	56	ET-337985	TR 2SA1144 O, Y
8	ED-330320	D SILICON DBA10C 200/1.0A	57	ET-305463	TR 2SA970 GR, BL
9	ED-336805	D SILICON DS135D-KB1 200/1.0A	58	ET-308866	TR 2SA979 G, H
10	ED-337153	D SILICON H DS446FA5 F10	59	ET-337760	TR 2SA984K F
11	ED-200469	D SILICON H DS448 FA5 F10	60	ET-301165	TR 2SB631K E, F
12	ED-323057	D VARISTER MV12	61	ET-307195	TR 2SC2240 GR, BL
13	ED-330218	D ZENER H HZ15L 2	62	ET-337758	TR 2SC2259 G, H
14	ED-337990	D ZENER H HZ27L 1	63	ET-308977	TR 2SC2274K F
15	ED-337750	D ZENER H 05Z16Y	64	ET-337986	TR 2SC2704 O, Y
16	ED-338096	D ZENER H 05Z2.0 X	65	ET-316171	TR 2SC536K-NP E, F
17	ED-337761	D ZENER H 05Z24 X	66	ET-300931	TR 2SD600K E, F
18	ED-337751	D ZENER H 05Z4.3 X	67	ET-328440	TR 2SD863-V8 E, F
19	ED-323534	D ZENER H 05Z20 Z	68	EV-325629	VR ROTARY 16P20×1Q C104
20	EF-258344	△ FUSE SEMKO T 250V 0.80A (F2, 3, 4) (E, B, S, V)	69	EV-325630	VR ROTARY 16P20×1R C104
21	EF-623125	△ FUSE SEMKO T 250V 2.5A (F1) (E, B, S, V)	70	EV-337987	VR ROTARY 16P20×2W 1Z254 2Z254
22	EF-623125	△ FUSE SEMKO T 250V 2.5A (F1) (U)	71	EV-337308	VR SLIDE 100P2SV0B B254
23	EF-249851	△ FUSE SEMKO T 250V 5A (F1) (U)			
24	EF-459843	△ FUSE ST6 125V 5A (F1) (C, A)			
25	EF-200952	△ FUSE TSC A 250V 6.3A (F1) (J)			
26	EF-309388	△ FUSE TSC A 250V 0.80A (F2, 3, 4) (J)			
27	EF-309391	△ FUSE TSC 125V 0.08A (F2) (C, A)			
28	EF-310229	△ FUSE TSC 125V 1A (F3, 4) (C, A)			
29	EI-337593	IC STK-1060 (2)			
30	EI-200938	IC TA75558S			
31	EJ-337405	△ SOCKET OUTLET S2T733T164 JUC 3×2P (U, J, C, A)			
32	EL-337757	PL LEAD 14.0V 50MA			
33	EP-323565	RELAY POWER G2Z-222P-US 2NO 24V			
34	EP-337416	RELAY SIGNAL G2V-282P-NL 2TR 12V			
35	ER-338000	△ R FUSE ERD2FC F10 1/4W 2200G			
36	ER-337756	△ R FUSE ERD2FC F10 1/4W 4700G			
37	ER-332225	△ R FUSE ERD2FC F10 1/4W 56R0G			
38	ES-337390	△ SW PUSH ESB-70274T 01-1 UC (C)			
39	ES-328788	△ SW PUSH ESB-90144T 01-1 UC (A)			
40	ES-328787	△ SW PUSH ESB-90149R 01-1 J (J)			
41	ES-336909	△ SW PUSH ESB-90259S 01-1 C (U, E, B, S, V)			
42	ES-337394	SW PUSH SUL122A 02-2 S			
43	ES-337392	SW PUSH SUL232S 2-THROW			
44	ES-337393	SW PUSH SUL241A 2-THROW			
45	ES-337998	SW PUSH SUL532A 5-THROW			
46	ES-337389	SW PUSH SUN222A 2-THROW			
47	ES-337317	SW REMOTE B SWR1300 L=300			
48	ES-337403	SW REMOTE O SUR510			
49	ES-337388	SW REMOTE S SSR2435 04-3			

When ordering parts, please quote Parts Number, Description and Model Number.



## 1. MAIN AMP P.C BOARD BLOCK

REF. NO.	PARTS NO.	DESCRIPTION	REF. NO.	PARTS NO.	DESCRIPTION
1-1	BA-A2018A060A	PC MAIN AMP BLK AM-U41 (U)	1-FR1	ER-332225	△ R FUSE ERD2FC F10 1/4W 56ROG (U, E, B, S, V)
1-2	BA-A2018A060B	PC MAIN AMP BLK AM-U41 (J)	1-FR2	ER-338000	△ R FUSE ERD2FC F10 1/4W 2200G (U, E, B, S, V)
1-3	BA-A2018A060C	PC MAIN AMP BLK AM-U41 (C) (C, A)	1-FR3, 4	ER-337756	△ R FUSE ERD2FC F10 1/4W 4700G (U, E, B, S, V)
1-4	BA-A2018A060D	PC MAIN AMP BLK AM-U41 (E) (E, B, S)	1-R17	ER-324337	△ R CB H SNP FS RDS 1/4W 560J (U, J, C, A)
1-5	BA-A2018A060E	PC MAIN AMP BLK AM-U41P (U)	1-R32	ER-337752	△ R OMF H FS 1W 103J
1-6	BA-A2018A060F	PC MAIN AMP BLK AM-U41P (J)	1-R35	ER-324185	△ R CB H SNP FS RDS 1/4W 221J (U, J, C, A)
1-7	BA-A2018A060G	PC MAIN AMP BLK AM-U41 (C) (C, A)	1-R39, 40	ER-323075	△ R CB H SNP FS RDS 1/4W 472J
1-8	BA-A2018A060H	PC MAIN AMP BLK AM-U41 (E) (E, B, S)	1-R41, 42	ER-322591	△ R CB H SNP FS RDS 1/4W 101J
1-9	BA-A2018A060J	PC MAIN AMP BLK AM-U41 (V)	1-R47, 48	ER-328082	△ R CB H SNP FS RDS 1/4W 332J
1-10	BA-A2018A060K	PC MAIN AMP BLK AM-U41-P (V)	1-R51	ER-323075	△ R CB H SNP FS RDS 1/4W 472J
<b>MAIN AMP P.C BOARD BLOCK</b>			1-R52	ER-333689	△ R CB H SNP FS RDS 1/2W 682J
			1-R59, 60	ER-323075	△ R CB H SNP FS RDS 1/2W 472J
1-IC1	EI-200938	IC TA75558S	1-R61, 62	ER-316802	△ R CB H SNP FS RDS 1/4W 471J (U, J, C, A)
1-IC3	EI-200938	IC TA75558S	1-R68, 69	ER-337754	△ R OMF H SNP FS 1W 100J
1-TR1	ET-328440	TR 2SD863-V8 E, F	1-R74	ER-337755	△ R OMF H SNP FS 2W 222J
1-TR2	ET-337984	TR FET 2SK150 BL, GR	1-R75	ER-322361	△ R OMF H SNP FS 2W 102J
1-TR3	ET-337758	TR 2SC2259 G, H	1-R76	ER-324756	△ R OMF H FS 2W 331J
1-TR4	ET-308866	TR 2SA979 G, H	1-R80	ER-337754	△ R OMF H SNP FS 1W 100J
1-TR7	ET-305463	TR 2SA970 GR, BL	1-R90, 91	ER-323075	△ R CB H SNP FS RDS 1/4W 472J
1-TR8	ET-307195	TR 2SC2240 GR, BL	1-R94, 95	ER-333698	△ R CB H SNP FS RDS 1/2W 821J
1-TR9	ET-337985	△ TR 2SA1144 O, Y	1-C27, 28	EC-332052	C EC V F05 NP SM 4R7M 35DC
1-TR10	ET-337986	△ TR 2SC2704 O, Y	1-C31	EC-334013	C EC V CUT NP SM 331M 6.3DC
1-TR11	ET-305463	TR 2SA970 GR, BL	1-C38, 39	EC-337306	C EC V 123/56DC
1-TR12 to 14	ET-307195	TR 2SC2240 GR, BL	1-C42	EC-320548	C CE V F 103Z 250AC (U, J, C, A)
1-TR15	ET-305463	TR 2SA970 GR, BL	1-C42	EC-326583	C MMY V CUT CF921 473K 400DC (E, B, S, V)
1-TR16, 17	ET-316171	TR 2SC536K-NP E, F	1-C43	EC-320548	C CE V F 103Z 250AC (U, J, C, A)
1-TR18	ET-305463	TR 2SA970 GR, BL	1-C43	EC-326583	C MMY V CUT CF921 473K 400DC (E, B, S, V)
1-TR19	ET-328440	TR 2SD863-V8 E, F	1-C44, 45	EC-320548	C CE V F 103Z 250AC
1-TR20, 21	ET-337759	TR FET 2SK246 GR	1-C46 to 49	EC-320548	C CE V F 103Z 250AC (E, B, S, V)
1-TR22	ET-300931	△ TR 2SD600K E, F	<b>MUTE P.C BOARD BLOCK</b>		
1-TR23	ET-301165	△ TR 2SB631K E, F	1-SW1	ES-337393	SW PUSH SUL241A 2-THROW
1-TR24	ET-307195	TR 2SC2240 GR, BL	<b>SPEAKER SW P.C BOARD BLOCK</b>		
1-TR25	ET-337760	TR 2SA984K F	1-SW1	ES-337392	SW PUSH SUL232S 2-THROW
1-TR26	ET-300931	△ TR 2SD600K E, F	<b>LAMP (1) P.C BOARD BLOCK</b>		
1-TR27	ET-301165	△ TR 2SB631K E, F	1-IN1, 2	EL-337757	PL LEAD 14-0V 50MA
1-D1, 2	ED-338096	D ZENER H 05Z2.0 X	<b>LAMP (2) P.C BOARD BLOCK</b>		
1-D3	ED-200469	D SILICON H DS448 FA5 F10	1-IN1	EL-337757	PL LEAD 14.0V 50MA
1-D4 to 7	ED-337153	D SILICON H DS446 FA5 F10	1-D1 to 4	ED-337391	D LED GL-5NG6 GRN
1-D8, 9	ED-200469	D SILICON H DS448 FA5 F10	<b>VR (1) P.C BOARD BLOCK</b>		
1-D10	ED-337153	D SILICON H DS446 FA5 F10	1-VR1	EV-337308	VR SLIDE 100P2SV0B B254
1-D11	ED-337750	D ZENER H 05Z16 Y	<b>HEAD PHONE P.C BOARD BLOCK (EXCEPT V)</b>		
1-D12	ED-337153	D SILICON H DS446 FA5 F10	1-J8	EJ-336885	PHONE J 3P HLJ0607-023 6.3
1-D13	ED-336805	△ D SILICON DS135D-KB1 200/1.0A	1-J8	EJ-336886	PHONE J 3P HLJ0607-020 6.3 (P)
1-D14	ED-337153	D SILICON H DS446 FA5 F10	<b>HEAD PHONE P.C BOARD BLOCK (V ONLY)</b>		
1-D15	ED-200749	△ D SILICON DBA60-K15 400/6.0A	1-J8	EJ-336885	PHONE J 3P HLJ0607-023 6.3
1-D16	ED-330320	△ D SILICON DBA10C 200/1.0A	1-J8	EJ-336886	PHONE J 3P HLJ0607-020 6.3 (P)
1-D17	ED-323534	D ZENER 05Z20 Z	1-L1	EO-336934	COIL FIX 1 LAL03KH 2.2μH M
1-D18, 19	ED-337990	D ZENER H HZ27L 1			
1-D20, 21	ED-330218	D ZENER H HZ15L 2			
1-D22	ED-337153	D SILICON H DS446 FA5 F10			
1-D23	ED-337751	D ZENER H 05Z4.3 X			
1-D24	ED-337761	D ZENER H 05Z24 X			
1-D25, 26	ED-200469	D SILICON H DS448 FA5 F10			
1-D27, 28	ED-337751	D ZENER H 05Z4.3 X			
1-D29	ED-337153	D SILICON H DS446 FA5 F10			
1-SW1	ES-337389	SW PUSH SUN222A 2-THROW			
1-SW2	ES-337394	SW PUSH SUL122A 02-2 S			
1-VR1	EV-325629	VR ROTARY 16P20x1Q C104			
1-VR2	EV-325630	VR ROTARY 16P20x1R C104			
1-VR3	EV-337987	VR ROTARY 16P20x2W 1Z254 2Z254			
1-RL1	EP-337416	RELAY SIGNAL G2V-282P-NL 2TR 12V			
1-RL2	EP-323565	RELAY POWER G2Z-222P-US 2NO 24V			
1-L1	EO-332116	COIL FIX 2 103AK-006A 2.2μH			

When ordering parts, please quote Parts Number, Description and Model Number.

**2. EQUALIZER P.C BOARD BLOCK**

REF. NO.	PARTS NO.	DESCRIPTION
2-1	BA-A2018A040A	PC EQ BLK AM-U41 (U) (U, J, C, A, E, B, S)
2-2	BA-A2018A040B	PC EQ BLK AM-U41 (V)

**EQUALIZER P.C BOARD BLOCK**

2-TR1	ET-337234	TR FET 2SK270 GR, BL
2-TR2, 3	ET-307195	TR 2SC2240 GR, BL
2-TR4 to 6	ET-305463	TR 2SA970 GR, BL
2-TR7	ET-307195	TR 2SC2240 GR, BL
2-TR8	ET-308977	TR 2SC2274K F
2-TR9	ET-337760	TR 2SA984K F
2-D1 to 3	ED-200469	D SILICON H DS448 FA5 F10
2-D4	ED-323057	D VARISTER MV12
2-D5	ED-200469	D SILICON H DS448 FA5 F10
2-J1	EJ-337404	PIN J AJC-052-ABB P 6P
2-J4	EJ-324913	SOCKET JAMPER W-D0606 6P
2-SW1	ES-337388	SW REMOTE S SSR2435 04-3
2-SW2	ES-337998	SW PUSH SUL532A 5 THROW
2-SW3	ES-323369	SW REMOTE S SSR24602D 04-6
2-L1	EO-337684	COIL FIX 2 FL12R751E 750 $\mu$ H
2-L2, 3	EO-336934	COIL FIX 1 LAL03KH 2.2 $\mu$ H M
2-FR1, 2	ER-332225	$\Delta$ R FUSE ERD2FC F10 1/4W 56R0G
2-R15	ER-337999	R MF H F10 1/4W 82R0F
2-R16	ER-337100	R MF H F10 1/4W 9R10F
2-R17	ER-323352	R MF H F10 1/4W 4532F
2-R18	ER-323351	R MF H F10 1/4W 3741F
2-R27, 28	ER-324934	R CB H SNP FS RDS 1/4W 220J
2-C6	EC-324103	C PP V SNP PS 6972G 50DC
2-C7	EC-324102	C PP V SNP PS 2002G 50DC

**PIN JACK P.C BOARD BLOCK**

2-J1	EO-336934	COIL FIX 1 LAL03KH 2.2 $\mu$ H M
2-J2	EJ-336915	PIN J C-810 P 4P
2-L1 to 4	EO-336934	COIL FIX 1 LAL03KH 2.2 $\mu$ H M

**3. POWER P.C BOARD BLOCK**

REF. NO.	PARTS NO.	DESCRIPTION
3-SW1	ES-336909	$\Delta$ SW PUSH ESB-90259S 01-1 C (U, E, B, S, V)
3-SW1	ES-328787	$\Delta$ SW PUSH ESB-90149R 01-1 J (J)
3-SW1	ES-337390	$\Delta$ SW PUSH ESB-70274T 01-1 UC (C)
3-SW1	ES-328788	$\Delta$ SW PUSH ESB-90144T 01-1 UC (A)
3-FL1	EO-338409	$\Delta$ COIL LF FKOB160MH02 250 $\mu$ H (V)
3-C1	EC-320548	$\Delta$ C CE V F 103Z 250AC (U, J)
3-C1	EC-338411	$\Delta$ C CE V FZ 103P 400AC (B, S, V)
3-C1	EC-330308	$\Delta$ C MMY V ECQUF 103M 250AC (E)
3-C1	EC-314688	$\Delta$ C CE V FZ 103P 125AC (C, A)

**ASSEMBLY BLOCK**

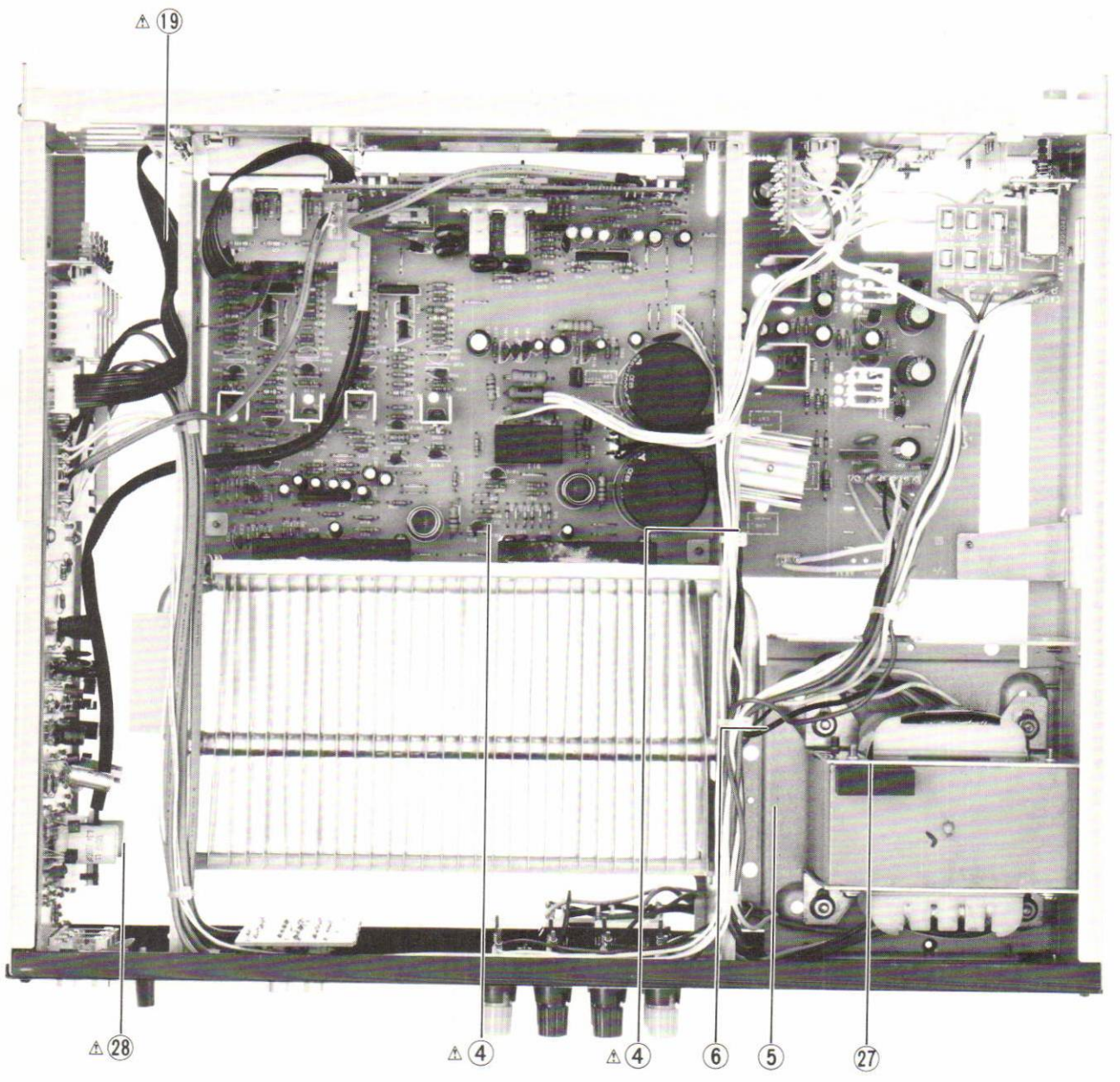
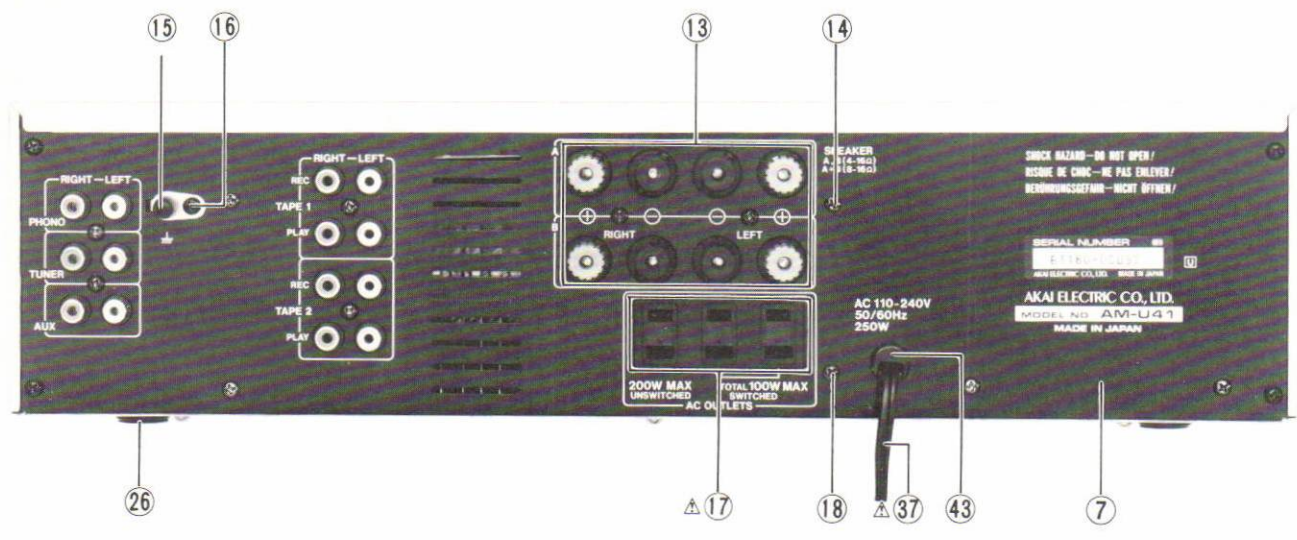

## 4. ASSEMBLY BLOCK

REF. NO.	PARTS NO.	DESCRIPTION	REF. NO.	PARTS NO.	DESCRIPTION
	<b>LED (1) P.C BOARD BLOCK</b>			<b>ASSEMBLY BLOCK</b>	
4-1x	ED-337391	D LED GL-5NG6 GRN (D1to10)	4-7	SP-336440B	PANEL REAR AM-U41 (U)
	<b>TERMINAL P.C BOARD BLOCK</b>		4-8x	SP-336440A	PANEL REAR AM-U41 (J)
4-2x	EJ-342935	TERMINAL (J1) (V)	4-9x	SP-336440D	PANEL REAR AM-U41 (C)
4-3x	EO-342936	COIL BALUN (FL1) (V)	4-10x	SP-336440C	PANEL REAR AM-U41 (A)
	<b>MAIN AMP BLOCK</b>		4-11x	SP-336440E	PANEL REAR AM-U41 (E) (E, V)
4-4	EI-337593	△ IC STK-1060 (2) (IC2)	4-12x	SP-336440F	PANEL REAR AM-U41 (B) (B, S)
	<b>SW REMOTE BLOCK</b>		4-13	EJ-337406	TERMINAL W/SCREW ANB-024-AAA S 8P
4-5	ES-337403	SW REMOTE O SUR510 (PHONO MM/MC)	4-14	ZS-522865	T2BR30x12STL BNI
4-6	ES-337317	SW REMOTE B SWR1300 L=300	4-15	EJ-329610	TERMINAL W/SCREW UB-0067 L 1P
			4-16	ZS-308846	T2BR30x08STL BZN PROJECTION
			4-17	EJ-337405	△ SOCKET OUTLET S2T733T164 JUC 3x2P (U, J, C, A)
			4-18	ZS-308846	T2BR30x08STL BZN PROJECTION
			4-19	BT-341435	△ TRANS POWER AMU-41T-70 (U)
			4-20x	BT-341430	△ TRANS POWER AMU-41T-10 (J)
			4-21x	BT-341432	△ TRANS POWER AMU-41T-30 (C)
			4-22x	BT-341431	△ TRANS POWER AMU-41T-20 (A)
			4-23x	BT-341433	△ TRANS POWER AMU-41T-40 (E, V)
			4-24x	BT-341434	△ TRANS POWER AMU-41T-50 (B, S)
			4-25x	SP-336441	COVER LOWER (A)
			4-26	SA-332850	ROUND FOOT
			4-27	ES-337398	SW REMOTE W SBU0006F L=120 (REC SELECTOR)
			4-28	EF-249851	FUSE SEMKO T 250V 5A (F1) (U)
			4-29x	EF-623125	△ FUSE SEMKO T 250V 2.5A (F1) (U)
			4-30x	EF-200952	△ FUSE TSC A 250V 6.3A (F1) (J)
			4-31x	EF-309388	△ FUSE TSC A 250V 0.80A (F2, 3, 4) (J)
			4-32x	EF-459843	△ FUSE ST6 125V 5A (F1) (C, A)
			4-33x	EF-309391	△ FUSE TSC 125V 0.08A (F2) (C, A)
			4-34x	EF-310229	△ FUSE TSC 125V 1A (F3, 4) (C, A)
			4-35x	EF-623125	△ FUSE SEMKO T 250V 2.5A (F1) (E, B, S, V)
			4-36x	EF-258344	△ FUSE SEMKO T 250V 0.80A (F2, 3, 4) (E, B, S, V)
			4-37	EW-306428	△ AC CORD 2 CORES KP-205A, VFF J (U)
			4-38x	EW-306427	△ AC CORD 2 CORES KP-211, VFF J (J)
			4-39x	EW-328245	△ AC CORD 2 CORES KP-8/SPT-1 105C UC (C, A)
			4-40x	EW-336923	△ AC CORD 2 CORES KP-419C, LTCE-2F E (E, V)
			4-41x	EW-336926	△ AC CORD GTBS-2F 24/0.20x2 B (B)
			4-42x	EW-336924	△ AC CORD 2 CORES KP-560, LTSA-2F S (S)
			4-43	SZ-631945	STRAIN RELIEF SR-4N-4 (U, J, C, A, E, S, V)
			4-44x	EJ-692908	STRAIN RELIEF SR-5N-4 (B)

## FINAL ASSEMBLY BLOCK

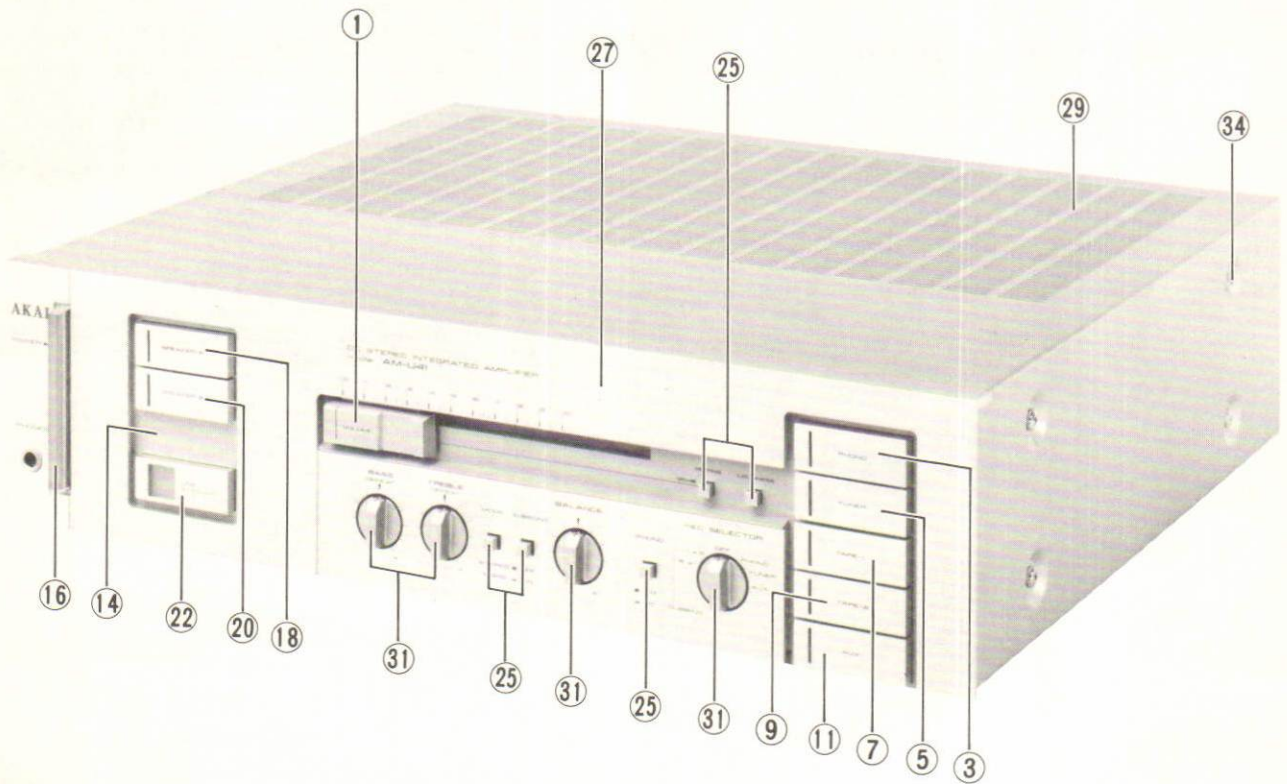

### 5. FINAL ASSEMBLY BLOCK

REF. NO. PARTS NO. DESCRIPTION

#### ESCUTCHEON PANEL (B) BLOCK

5-1	SK-336479A	KNOB SLIDE
5-2x	SK-336479B	KNOB SLIDE-P
5-3	SK-B336472E	KNOB OPERATE (A-3)-P PART
5-4x	SK-B336472F	KNOB OPERATE (A-3)-P PART
5-5	SK-B336472G	KNOB OPERATE (A-4) PART
5-6x	SK-B336472H	KNOB OPERATE (A-4)-P PART
5-7	SK-B336472J	KNOB OPERATE (A-5) PART
5-8x	SK-B336472K	KNOB OPERATE (A-5)-P PART
5-9	SK-B336472L	KNOB OPERATE (A-6) PART
5-10x	SK-B336472M	KNOB OPERATE (A-6)-P PART
5-11	SK-B336472N	KNOB OPERATE (A-7) PART
5-12x	SK-B336472P	KNOB OPERATE (A-7)-P PART
5-13x	ZG-313027	SP T1-5.0/0.32-18.0 T1-140

#### ESCUTCHEON PANEL (A) BLOCK

5-14	BD-A2018A030A	ESCUTCHEON PANEL (A) BLK AM-U41
5-15x	BD-A2018A030B	ESCUTCHEON PANEL (A) BLK AM-U41-P
5-16	SK-B336468	KNOB OPERAT PART
5-17x	ZG-336449	SP PLATE (A)
5-18	SK-B336472A	KNOB OPERATE (A-1) PART
5-19x	SK-B336472B	KNOB OPERATE (A-1)-P PART
5-20	SK-B336472C	KNOB OPERATE (A-2) PART
5-21x	SK-B336472D	KNOB OPERATE (A-2)-P PART
5-22	SK-B336474A	KNOB OPERATE (B) PART
5-23x	SK-B336474B	KNOB OPERATE (B)-P PART
5-24x	ZG-336460	SP PUSH (D)

REF. NO. PARTS NO. DESCRIPTION

#### FINAL ASSEMBLY BLOCK

5-25	SK-336471A	KNOB MUTE (A)
5-26x	SK-336471B	KNOB MUTE (A)-P
5-27	SP-336465A	PANEL FRONT AM-U41
5-28x	SP-336465B	PANEL FRONT AM-U41-P
5-29	SP-336443A	COVER UPPER
5-30x	SP-336443B	COVER UPPER-P
5-31	SK-336470A	KNOB
5-32x	SK-336470B	KNOB-P
5-33x	ZW-305013	RV POP32
5-34	ZS-322570	ST BID40x08STL N13
5-35x	ZS-322580	ST BID40x08STL BN1

When ordering parts, please quote Parts Number, Description and Model Number.

### III. MODEL AM-U61

AM-U61

#### RECOMMENDED SPARE PARTS LIST

Because, if the parts listed below are on hand, almost any repair can be accomplished, we suggest that you stock these Recommended Spare Parts Items.

REF. NO.	PARTS NO.	DESCRIPTION	REF. NO.	PARTS NO.	DESCRIPTION
1	BT-338023	△ TRANS POWER AM-U61T-10 (J)	47	ES-337392	SW PUSH SUL232S 2-THROW
2	BT-338024	△ TRANS POWER AM-U61T-20 (A)	48	ES-337393	SW PUSH SUL241A 2-THROW
3	BT-338025	△ TRANS POWER AM-U61T-30 (C)	49	ES-337998	SW PUSH SUL532A 5-THROW
4	BT-338026	△ TRANS POWER AM-U61T-40 (E)	50	ES-337389	SW PUSH SUN222A 2-THROW
5	BT-338028	△ TRANS POWER AM-U61T-50 (B, S)	51	ES-337401	SW REMOTE S SSR244 04-4
6	BT-338029	△ TRANS POWER AM-U61T-60 (V)	52	ES-337400	SW REMOTE S SSR26602D 06-6
7	BT-338030	△ TRANS POWER AM-U61T-70 (U)	53	ES-337399	SW REMOTE W SBU0006F L=120
8	ED-337391	D LED GL-5NG6 GRN	54	ES-337402	SW REMOTE W SBU004F L=280
9	ED-337395	D LED SR538W RED	55	ET-337984	TR FET 2SK150 BL, GR
10	ED-330320	D SILICON DBA10C 200/1.0A	56	ET-337759	TR FET 2SK246 GR
11	ED-336805	D SILICON DS135D-KB1 200/1.0A	57	ET-337234	TR FET 2SK270 GR, BL
12	ED-337153	D SILICON H DS446 FA5 F10	58	ET-337985	TR 2SA1144 O,Y
13	ED-200469	D SILICON H DS448 FA5 F10	59	ET-305463	TR 2SA970 GR, BL
14	ED-338041	D SILICON 10G4B41 400/10.0A	60	ET-308866	TR 2SA979 G, H
15	ED-323057	D VARISTER MV12	61	ET-337760	TR 2SA984K F
16	ED-330218	D ZENER H HZ15L 2	62	ET-301165	TR 2SB631K E, F
17	ED-337990	D ZENER H HZ27L 1	63	ET-307195	TR 2SC2240 GR, BL
18	ED-328481	D ZENER H 05Z20 X	64	ET-337758	TR 2SC2259 G, H
19	ED-306469	D ZENER H 05Z22 X	65	ET-308977	TR 2SC2274K F
20	ED-338049	D ZENER H 05Z24 Y	66	ET-337986	TR 2SC2704 O, Y
21	ED-337751	D ZENER H 05Z4.3 X	67	ET-316171	TR 2SC536K-NP E, F
22	EF-258344	△ FUSE SEMKO T 250V 0.80A (F2, 3, 4) (E, B, S, V)	68	ET-300931	TR 2SD600K E, F
23	EF-691007	△ FUSE SEMKO T 250V 3.15A (F1) (U)	69	ET-328440	TR 2SD863-V8 E, F
24	EF-691007	△ FUSE SEMKO T 250V 3.15A (F1) (E, B, S, V)	70	EV-338118	R S-FIX V H1052A 3P 0.15W 104
25	EF-242605	△ FUSE SEMKO T 250V 6.30A (F1) (U)	71	EV-330724	VR ROTARY 16P20x2C 1Z254
26	EF-303348	△ FUSE ST6 125V 6.30A (F1) (C, A)	72	EV-330725	VR ROTARY 16P20x2E C 104
27	EF-309388	△ FUSE TSC A 250V 0.80A (F2) (J)	73	EV-330843	VR ROTARY 16P20x2E C 104
28	EF-306949	△ FUSE TSC A 250V 1.25A (F3, 4) (J)	74	EV-337309	VR SLIDE 100P2SV0A B254
29	EF-341260	△ FUSE TSC A 250V 8.00A (F1) (J)			
30	EF-309392	△ FUSE TSC 125V 1.25A (F2, 3, 4) (C, A)			
31	EI-338022	IC STK-1080 (2)			
32	EI-200938	IC TA75558S			
33	EJ-337405	△ SOCKET OUTLET S2T733T164 JUC 3x2P (U, J, C, A)			
34	EL-337757	PL LEAD 14.0V 50MA			
35	EP-323565	RELAY POWER G2Z-222P-US 2NO 24V			
36	EP-337416	RELAY SIGNAL G2V-282P-NL 2TR 12V			
37	ER-338000	△ R FUSE ERD2FC F10 1/4W 2200G (E, B, S, V)			
38	ER-337756	△ R FUSE ERD2FC F10 1/4W 4700G (E, B, S, V)			
39	ER-332225	△ R FUSE ERD2FC F10 1/4W 56R0G			
40	ER-332225	△ R FUSE ERD2FC F10 1/4W 56R0G (E, B, S, V)			
41	ES-337390	△ SW PUSH ESB-70274T 01-1 UC (C)			
42	ES-337390	△ SW PUSH ESB-70274T 01-1 UC (C)			
43	ES-328788	△ SW PUSH ESB-90144T 01-1 UC (A)			
44	ES-328787	△ SW PUSH ESB-90149R 01-1 J (J)			
45	ES-336909	△ SW PUSH ESB-90259S 01-1 C (U, E, B, S, V)			
46	ES-337394	SW PUSH SUL122A 02-2 S			

When ordering parts, please quote Parts Number, Description and Model Number.

## 1. MAIN AMP P.C BOARD BLOCK

REF. NO.	PARTS NO.	DESCRIPTION	REF. NO.	PARTS NO.	DESCRIPTION
1-1	BA-A2019A060A	PC MAIN AMP BLK AM-61 (U)	1-FR1	ER-332225	△ R FUSE ERD2FC F10 1/4W 56R0G (E, B, S, V)
1-2	BA-A2019A060B	PC MAIN AMP BLK AM-U61 (J)	1-FR2	ER-338000	△ R FUSE ERD2FC F10 1/4W 2200G (E, B, S, V)
1-3	BA-A2019A060C	PC MAIN AMP BLK AM-U61 (C) (C, A)	1-FR3, 4	ER-337756	△ R FUSE ERD2FC F10 1/4W 4700G (E, B, S, V)
1-4	BA-A2019A060D	PC MAIN AMP BLK AM-U61 (E) (E, B, S)	1-R17	ER-324337	△ R CB H SNP FS RDS 1/4W 560J (U, J, C, A)
1-5	BA-A2019A060E	PC MAIN AMP BLK AM-U61-P (U)	1-R32	ER-337752	△ R OMF H FS 1W 103J
1-6	BA-A2019A060F	PC MAIN AMP BLK AM-U61 (J)	1-R35	ER-324185	△ R CB H SNP FS RDS 1/4W 221J (U, J, C, A)
1-7	BA-A2019A060G	PC MAIN AMP BLK AM-U61-P (C)(C, A)	1-R39, 40	ER-323075	△ R CB H SNP FS RDS 1/4W 472J
1-8	BA-A2019A060H	PC MAIN AMP BLK AM-U61-P (E)(E, B, S)	1-R41, 42	ER-322421	△ R CB H SNP FS RDS 1/4W 820J
1-9	BA-A2019A060J	PC MAIN AMP BLK AM-U61 (V)	1-R47, 48	ER-328082	△ R CB H SNP FS RDS 1/4W 332J
1-10	BA-A2019A060K	PC MAIN AMP BLK AM-U61-P (V)	1-R51	ER-323075	△ R CB H SNP FS RDS 1/4W 472J
			1-R52	ER-333689	△ R CB H SNP FS RDS 1/2W 682J
			1-R59, 60	ER-323075	△ R CB H SNP FS RDS 1/4W 472J
			1-R61, 62	ER-316802	△ R CB H SNP FS RDS 1/4W 471J
			1-R68, 69	ER-337754	△ R OMF H SNP FS 1W 100J
			1-R74	ER-337755	△ R OMF H SNP FS 2W 222J
			1-R75	ER-338084	△ R OMF H SNP FS 2W 122J
			1-R76	ER-624756	△ R OMF H FS 2W 331J
			1-R80	ER-337754	△ R OMF H SNP FS 1W 100J
			1-R90, 91	ER-323075	△ R CB H SNP FS RDS 1/4W 472J
			1-R94, 95	ER-333698	△ R CB H SNP FS RDS 1/2W 821J
			1-C27, 28	EC-332052	C EC V F05 NP SM 4R7M 35DC
			1-C31	EC-334013	C EC V CUT NP SM 331M 6.3DC
			1-C42	EC-320548	C CE V F 103Z 250AC (U, J, C, A)
			1-C42	EC-326583	C MMY V CUT CF921 473K 400DC (E, B, S, V)
			1-C43	EC-320548	C CE V F 103Z 250AC (U, J, C, A)
			1-C43	EC-326583	C MMY V CUT CF921 473K 400DC (E, B, S, V)
			1-C44, 45	EC-320548	C CE V F 103Z 250AC
			1-C46 to 49	EC-320548	C CE V F 103Z 250AC
			1-C50, 51	EC-201643	C EC V CUT SM 471M 80DC
			1-C53, 54	EC-316189	C EC V F05 SM 1ROM 100DC
			1-C59, 60	EC-338032	C CE V F05 SL 470K 500DC
					<b>MUTE P.C BOARD BLOCK</b>
			1-SW1	ES-337393	SW PUSH SUL241A 2-THROW
					<b>SPEAKER SW P.C BOARD BLOCK</b>
			1-SW1	ES-337392	SW PUSH SUL232S 2-THROW
					<b>LAMP (1) P.C BOARD BLOCK</b>
			1-IN1, 2	EL-337757	PL LEAD 14.0V 50MA
					<b>LAMP (2) P.C BOARD BLOCK</b>
			1-IN1	EL-337757	PL LEAD 14.0V 50MA
			1-D1 to 3	ED-337391	D LED GL-5NG5 GRN
			1-D4	ED-337391	D LED GL-5NG6 GRN
					<b>HEAD PHONE P.C BOARD BLOCK (EXCEPT V)</b>
			1-J8	EJ-336885	PHONE J 3P HLIJ0607-023 6.3
			1-J8	EJ-336886	PHONE J 3P HLIJ0607-020 6.3 (P)
					<b>HEAD PHONE P.C BOARD BLOCK (V ONLY)</b>
			1-J8	EJ-336885	PHONE J 3P HLIJ0607-023 6.3
			1-J8	EJ-336886	PHONE J 3P HLIJ0607-020 6.3 (P)
			1-L1	EO-336934	COIL FIX 1 LAL03KH 2.2μH M
					<b>MAIN AMP P. C BOARD BLOCK</b>
1-IC1	EI-200938	IC TA 75558S			
1-IC3	EI-200938	IC TA75558S			
1-TR1	ET-328440	TR 2SD863-V8 E, F			
1-TR2	ET-337984	TR FET 2SK150 BL, GR			
1-TR3	ET-337758	TR 2SC2259 G, H			
1-TR4	ET-308866	TR 2SA979 G, H			
1-TR5	ET-305463	TR 2SA970 GR, BL			
1-TR6	ET-307195	TR 2SC2240 GR, BL			
1-TR7	ET-305463	TR 2SA970 GR, BL			
1-TR8	ET-307195	TR 2SC2240 GR, BL			
1-TR9	ET-337985	△ TR 2SA1144 O, Y			
1-TR10	ET-337986	△ TR 2SC2704 O, Y			
1-TR11	ET-305463	TR 2SA970 GR, BL			
1-TR12 to 14	ET-307195	TR 2SC2240 GR, BL			
1-TR15	ET-305463	TR2SA970 GR, BL			
1-TR16, 17	ET-316171	TR 2SC536K-NP E, F			
1-TR18	ET-305463	TR 2SA970 GR, BL			
1-TR19	ET-328440	TR 2SD863-V8 E, F			
1-TR20, 21	ET-337759	TR FET 2SK246 GR			
1-TR22	ET-300931	△ TR 2SD600K E, F			
1-TR23	ET-301165	△ TR 2SB631K E, F			
1-TR24	ET-307195	TR 2SC2240 GR, BL			
1-TR25	ET-337760	TR 2SA984K F			
1-TR26	ET-300931	△ TR 2SD600K E, F			
1-TR27	ET-301165	△ TR 2SB631K E, F			
1-D3	ED-200469	D SILICON H DS448 FA5 F10			
1-D4 to 7	ED-337153	D SILICON H DS446 FA5 F10			
1-D8, 9	ED-200469	D SILICON H DS448 FA5 F10			
1-D10	ED-337153	D SILICON H DS446 FA5 F10			
1-D11	ED-328481	D ZENER H 05Z20 X			
1-D12	ED-337153	D SILICON H DS446 FA5 F10			
1-D13	ED-336805	D SILICON DS135D-KB1 200/1.0A			
1-D14	ED-337153	D SILICON H DS446 FA5 F10			
1-D15	ED-338041	△ D SILICON 10G4B41 400/10.0A			
1-D16	ED-330320	△ D SILICON DBA10C 200/1.0A			
1-D17	ED-306469	D ZENER H 05Z22 X			
1-D18, 19	ED-337990	D ZENER H HZ27L 1			
1-D20, 21	ED-330218	D ZENER H HZ15L 2			
1-D22	ED-337153	D SILICON H DS446 FA5 F10			
1-D23	ED-337751	D ZENER H 05Z4.3 X			
1-D24	ED-338049	D ZENER H 05Z24 Y			
1-D25, 26	ED-200469	D SILICON H DS448 FA5 F10			
1-D27, 28	ED-337751	D ZENER H 05Z4.3 X			
1-D29	ED-337153	D SILICON H DS446 FA5 F10			
1-SW1	ES-337389	SW PUSH SUN222A 2-THROW			
1-SW2	ES-337394	SW PUSH SUL122A 02-2 S			
1-VR1	EV-330725	VR ROTARY 16P20x2D C104			
1-VR2	EV-330843	VR ROTARY 16P20x2E C104			
1-VR3	EV-330724	VR ROTARY 16P20x2C 1Z254			
1-RL1	EP-337416	RELAY SIGNAL G2V-282P-NL 2TR 12V			
1-RL2	EP-323565	RELAY POWER G2Z-222P-US 2NO 24V			
1-L1	EO-332116	COIL FIX 2 103AK-006A 2.2μH			

When ordering parts, please quote Parts Number, Description and Model Number.

**2. EQUALIZER P.C BOARD BLOCK**

REF. NO.	PARTS NO.	DESCRIPTION
2-1	BA-A2019A120A	PC EQ BLK AM-U61 (U) (U, J, C, A, E, B, S)
2-2	BA-A2019A120B	PC EQ BLK AM-U61 (V)

**EQUALIZER P.C BOARD BLOCK**

REF. NO.	PARTS NO.	DESCRIPTION
2-IC1	EI-200938	IC TA75558S
2-TR1	ET-337234	TR FET 2SK270 GR, BL
2-TR2, 3	ET-307195	TR 2SC2240 GR, BL
2-TR4 to 6	ET-305463	TR 2SA970 GR, BL
2-TR7	ET-307195	TR 2SC2240 GR, BL
2-TR8	ET-308977	TR 2SC2274K F
2-TR9	ET-337760	TR 2SA984K F
2-D1, 2	ED-200469	D SILICON H DS448 FA5 F10
2-D3	ED-200469	D SILICON H DS448 FA5 F10
2-D4	ED-323057	D VARISTER MV12
2-D5	ED-200469	D SILICON H DS448 FA5 F10
2-D6, 7	ED-330218	D ZENER H HZ15L 2
2-J1	EJ-337404	PIN J AJC-052-ABB P 6P
2-SW1	ES-337401	SW REMOTE S SSR244 04-4
2-SW2	ES-337998	SW PUSH SUL532A 5-THROW
2-SW3	ES-337400	SW REMOTE S SSR26602D 06-6
2-VR1	EV-338118	R S-FIX V H1052A 3P 0.15A 104
2-L1	EO-337684	COIL FIX 2 FL12R751E 750 $\mu$ H
2-L2, 3	EO-336934	COIL FIX 1 LAL03KH 2.2 $\mu$ H M
2-FR1,2	ER-332225	$\Delta$ R FUSE ERD2FC F10 1/4W 56R0G
2-R14	ER-309781	R MF V 1/4W 1200F
2-R15	ER-311768	R MF H 1/4W 2700F
2-R16	ER-337100	R MF H F10 1/4W 9R10F
2-R17	ER-323352	R MF H F10 1/4W 4532F
2-R18	ER-323351	R MF H F10 1/4W 3741F
2-R27, 28	ER-324934	$\Delta$ R CB H SNP FS RDS 1/4W 220J
2-R37, 38	ER-200944	$\Delta$ R CB H SNP FS RDS 1/4W 152J
2-C6	EC-324103	C PP V SNP PS 6972G 50DC
2-C7	EC-324102	C PP V SNP PS 2002G 50DC
2-C15, 16	EC-332052	C EC V F05 NP SM 4R7M 35DC

**PIN JACK P.C BOARD BLOCK**

REF. NO.	PARTS NO.	DESCRIPTION
2-J2, 3	EJ-336915	PIN J C-810 P 4P
2-L1 to 4	EO-336934	COIL FIX 1 LAL03KH 2.2 $\mu$ H M (V)

**3. POWER P.C BOARD BLOCK**

REF. NO.	PARTS NO.	DESCRIPTION
3-SW1	ES-336909	$\Delta$ SW PUSH ESB-90259S 01-1 C (U, E, B, S, V)
3-SW1	ES-328787	$\Delta$ SW PUSH ESB-90149R 01-1 J (J)
3-SW1	ES-337390	$\Delta$ SW PUSH ESB-70274T 01-1 UC (C)
3-SW1	ES-328788	$\Delta$ SW PUSH ESB-90144T 01-1 UC (A)
3-FL1	EO-338409	$\Delta$ COIL LF FKOB160MH02 250 $\mu$ H (V)
3-C1	EC-320548	$\Delta$ C CE V F 103Z 250AC (U, J)
3-C1	EC-338411	$\Delta$ C CE V FZ 103P 400AC (B, S, V)
3-C1	EC-330308	$\Delta$ C MMY V ECQUF 103M 250AC (E)
3-C1	EC-314688	$\Delta$ C CE V FZ 103P 125AC (C, A)

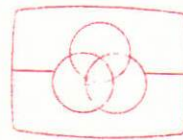

Free service manuals  
Gratis schema's

Digitized by

www.freesevicemanuals.info



ASSEMBLY BLOCK

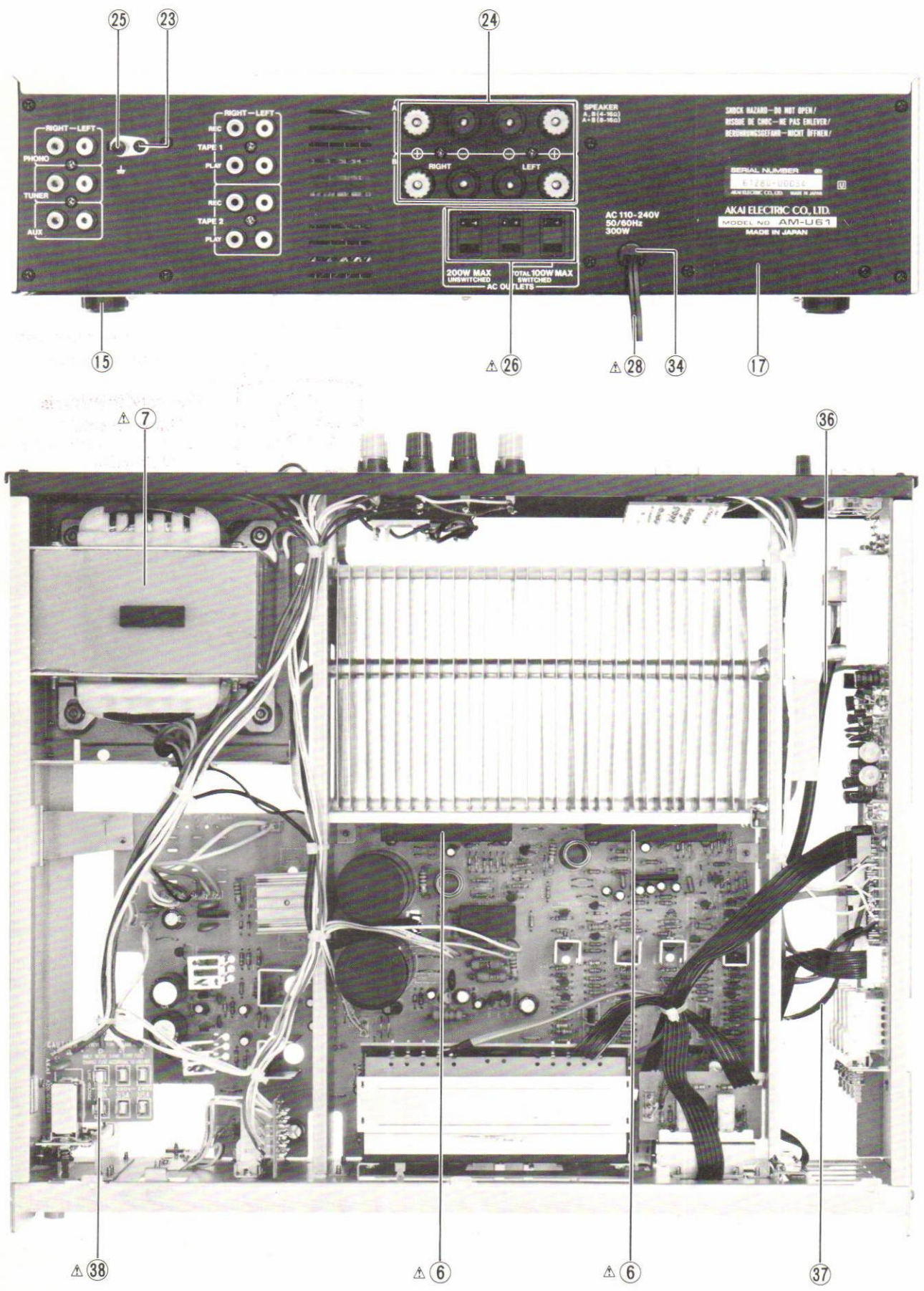

## 4. ASSEMBLY BLOCK

REF. NO.	PARTS NO.	DESCRIPTION
<b>VR P.C BOARD BLOCK</b>		
4-1x	EV-337309	VR SLIDE 100P2SV0A B254 (VR1)
<b>LED (1) P.C BOARD BLOCK</b>		
4-2x	ED-337391	D LED GL-5NG6 GRN (D1 to 10)
<b>TERMINAL P.C BOARD BLOCK</b>		
4-3x	EJ-342935	TERMINAL (J1) (V)
4-4x	EO-342936	COIL BALUN (FL1) (V)
<b>LED (2) P.C BOARD BLOCK</b>		
4-5x	ED-337395	D LED SR538W RED (D1 to 5)
<b>MAIN AMP P.C BOARD BLOCK</b>		
4-6	EI-338022	△ IC STK-1080 (2) (IC2)
<b>ASSEMBLY BLOCK</b>		
4-7	BT-338030	△ TRANS POWER AM-U61T-70 (U)
4-8x	BT-338023	△ TRANS POWER AM-U61T-10 (J)
4-9x	BT-338025	△ TRANS POWER AM-U61T-30 (C)
4-10x	BT-338024	△ TRANS POWER AM-U61T-20 (A)
4-11x	BT-338026	△ TRANS POWER AM-U61T-40 (E)
4-12x	BT-338028	△ TRANS POWER AM-U61T-50 (B, S)
4-13x	BT-338029	△ TRANS POWER AM-U61T-60 (V)
4-14x	SP-336494	COVER BOTTOM (B)
4-15	SA-312465	CIRCULAR FOOT (A) PART CA
4-16x	ZS-565942	T2PAN40x08STL CMT
4-17	SP-336440H	PANEL REAR AM-U61 (U)
4-18x	SP-336440G	PANEL REAR AM-U61 (J)
4-19x	SP-336440K	PANEL REAR AM-U61 (C)
4-20x	SP-336440J	PANEL REAR AM-U61 (A)
4-21x	SP-336440L	PANEL REAR AM-U61(E) (E, V)
4-22x	SP-336440M	PANEL REAR AM-U61 (B) (B, S)
4-23	ZS-308846	T2BR30x08STL BZN PROJECTION
4-24	EJ-337406	TERMINAL W/SCREW ANB-024-AAA S 8P
4-25	EJ-329610	TERMINAL W/SCREW UB-0067 L 1P
4-26	EJ-337405	△ SOCKET OUTLET S2T733T164 JUC 3x2P (U, J, A)
4-27x	EJ-337405	△ SOCKET OUTLET S2T733T164 JUC 3x2P (C)
4-28	EW-306428	△ AC CORD 2 CORES KP-205A, VFF J (U)
4-29x	EW-306427	△ AC CORD 2 CORES KP-211, VFFJ (J)
4-30x	EW-328245	△ AC CORD 2 CORES KP-8/SPT-1 105C UC (C, A)
4-31x	EW-336923	△ AC CORD 2 CORES KP-419C, LTCE-2F E (E, V)
4-32x	EW-336926	△ AC CORD GTBS-2F 24/0.20x2 B (B)
4-33x	EW-336924	△ AC CORD 2 CORES KP-560, LTSA-2F S (S)
4-34	SZ-631945	STRAIN RELIEF SR-4N-4 (U, J, C, A, E, S, V)
4-35x	EJ-692908	STRAIN RELIEF SR-5N-4 (B)
4-36	ES-337402	SW REMOTE W SBU004F L=280 (PHONO MM/MC)
4-37	ES-337399	SW REMOTE W SBU0006F L=120
4-38	EF-242605	△ FUSE SEMKO T 250V 6.30A (F1) (U)
4-39x	EF-691007	△ FUSE SEMKO T 250V 3.15A (F1) (U)
4-40x	EF-341260	△ FUSE TSC A 250V 8.00A (F1) (J)
4-41x	EF-309388	△ FUSE TSC A 250V 0.80A (F2) (J)
4-42x	EF-306949	△ FUSE TSC A 250V 1.25A (F3, 4) (J)

REF. NO.	PARTS NO.	DESCRIPTION
4-43x	EF-303348	△ FUSE ST6 125V 6.30A (F1) (C, A)
4-44x	EF-309392	△ FUSE TSC 125V 1.25A (F2, 3, 4) (C, A)
4-45x	EF-691007	△ FUSE SEMKO T 250V 3.15A (F1) (E, B, S, V)
4-46x	EF-258344	△ FUSE SEMKO T 250V 0.80A (F2, 3, 4) (E, B, S, V)
4-47x	ZW-305013	RV POP32 (A)

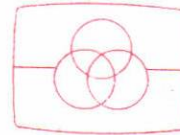

Free service manuals  
Gratis schema's

Digitized by

www.freesevicemanuals.info

## FINAL ASSEMBLY BLOCK

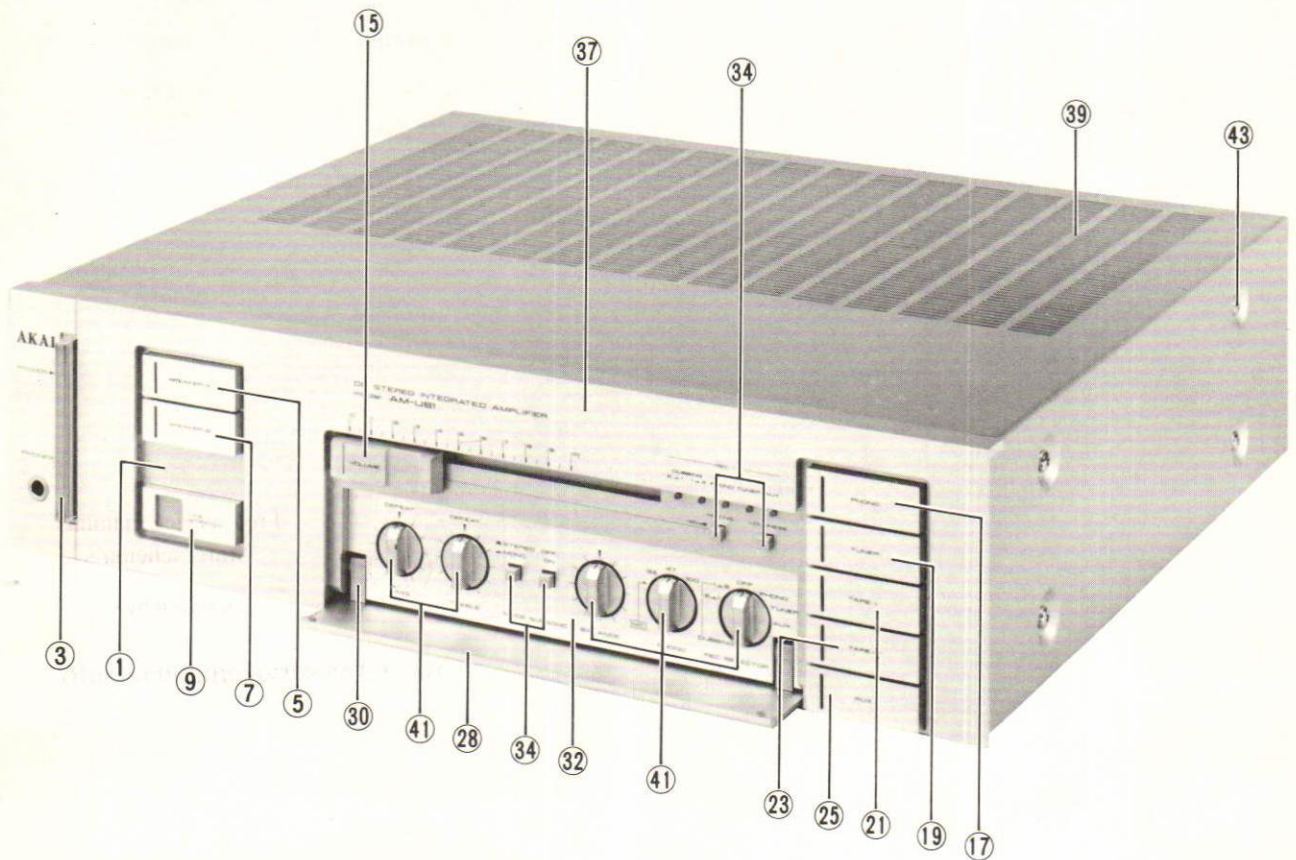

### 5. FINAL ASSEMBLY BLOCK

REF. NO.	PARTS NO.	DESCRIPTION	REF. NO.	PARTS NO.	DESCRIPTION
<b>ESCUTCHEON PANEL A-2 BLOCK</b>					
5-1	BD-A2019A020A	ESCUTCHEON PANEL A-2 BLK AM-U61	5-21	SK-B336472J	KNOB OPERATE (A-5)-P PART
5-2x	BD-A2019A020B	ESCUTCHEON PANEL A-2 BLK AM-U61-P	5-22x	SK-B336472K	KNOB OPERATE (A-5)-P PART
5-3	SK-B336468	KNOB OPERATE PART	5-23	SK-B336472L	KNOB OPERATE (A-6)-PART
5-5	SK-B336472A	KNOB OPERATE (A-1) PART	5-24x	SK-B336472M	KNOB OPERATE (A-6)-P PART
5-6x	SK-B336472B	KNOB OPERATE (A-1)-P PART	5-25	SK-B336472N	KNOB OPERATE (A-7)-PART
5-7	SK-B336472C	KNOB OPERATE (A-2) PART	5-26x	SK-B336472P	KNOB OPERATE (A-7)-P PART
5-8x	SK-B336472D	KNOB OPERATE (A-2)-P PART	5-27x	ZG-313027	SP T1-5.0/0.32-18.0 T1-140
5-9	SK-B336474A	KNOB OPERATE (B) PART	5-28	BD-B336500A	PANEL DOOR PART
5-10x	SK-B336474B	KNOB OPERATE (B)-P PART	5-29x	BD-B336500B	PANEL DOOR-P PART
5-11x	ZG-336460	SP PUSH (D)	5-30	TA-336501A	HINGE
<b>ESCUTCHEON PANEL (C) BLOCK</b>					
5-12	BD-A2019A030A	ESCUTCHEON PANEL (C) BLK AM-U61	5-31x	TA-336501B	HINGE-P
5-13x	BD-A2019A030B	ESCUTCHEON PANEL (C) BLK AM-U61-P	5-32	SP-336499A	PANEL OPERATION
5-14x	TA-336480	GUIDE SLIDE KNOB	5-33x	SP-336499B	PANEL OPERATION
5-15	SK-336479A	KNOB SLIDE	<b>FINAL ASSEMBLY BLOCK</b>		
5-16x	SK-336479B	KNOB SLIDE-P	5-34	SK-336471A	KNOB MUTE (A)
5-17	SK-B336472E	KNOB OPERATE (A-3) PART	5-35x	SK-336471B	KNOB MUTE (A)-P
5-18x	SK-B336472F	KNOB OPERATE (A-3)-P PART	5-36x	SK-336471C	KNOB MUTE (B)
5-19	SK-B336472G	KNOB OPERATE (A-4)-P PART	5-37	SP-336496A	PANEL FRONT AM-U61
5-20x	SK-B336472H	KNOB OPERATE (A-4)-P PART	5-38x	BD-336496B	PANEL FRONT AM-U61-P
			5-39	SP-336443A	COVER UPPER
			5-40x	SP-336443B	COVER UPPER-P
			5-41	SK-336470A	KNOB
			5-42x	SK-336470B	KNOB-P
			5-43	ZS-322570	ST BID40x08STL N13
			5-44x	ZS-322580	ST BID40x08STL BN1

When ordering parts, please quote Parts Number, Description and Model Number.

## INDEX

AT-S61/L/J

Parts No.	Ref. No. & Symbol No.	Parts No.	Ref. No. & Symbol No.	Parts No.	Ref. No. & Symbol No.	Parts No.	Ref. No. & Symbol No.
BA-A3027A030A	1-1	EI-315379	1-IC12	ET-316643	1-TR2 to 5		
BA-A3027A030B	1-2	EI-315381	1-IC7	ET-316643	1-TR31		
BA-A3027A030C	1-3	EI-327074	1-X1	ET-322778	1-TR50		
BA-A3027A030D	1-4	EI-332206	1-IC5	ET-322778	1-TR47		
BA-A3027A030E	1-5	EI-332287	1-IC11	ET-322778	1-TR45		
BA-A3027A030F	1-6	EI-336717	1-IC8	ET-322778	1-TR1		
BD-A3027A020A	5-1	EI-336761	1-IC4	ET-322778	1-TR30		
BD-A3027A020B	5-2x	EI-336761	1-IC3	ET-322778	1-TR19 to 22		
BD-A3027A020C	5-3x	EI-336794	1-IC13	ET-322778	1-TR6		
BD-A3027A020D	5-4x	EI-337363	1-IC1	ET-322778	1-TR17		
BT-337970	4-19	EI-337365	1-IC14	ET-322778	1-TR46		
BT-337971	4-21x	EI-337417	1-IC2	ET-323232	1-TR24		
BT-337973	4-22x	EI-337600	1-IC9	ET-336864	1-TR29		
BT-337974	4-23x	EI-338171	1-IC10	ET-336864	1-TR28		
BT-337978	4-20x	EI-338675	1-IC15	ET-337604	1-TR8		
EC-300448	1-C64	EJ-324276	1-J2	ET-337604	1-TR14 to 16		
EC-314688	2-C1	EJ-337424	1-J1	ET-337604	1-TR7		
EC-320548	1-C119, 120	EJ-337595	1-TM1	EV-337993	1-VR4 to 6		
EC-320548	2-C1	EJ-337596	1-TM1	EV-337993	1-VR2		
EC-323252	1-C42	EJ-337597	1-TM1	EV-337995	1-VR7		
EC-323252	1-C43	EJ-341367	1-TM1	EV-337995	1-VR3		
EC-330309	1-C42	EJ-692908	4-16x	EV-337996	1-VR8		
EC-330309	1-C43	EL-337975	4-25	EV-338588	1-VR1		
EC-334065	1-C65	EM-337426	1-IN1	EW-305691	4-11x		
EC-336865	1-VC1	EO-202215	1-T10	EW-306427	4-10x		
EC-337581	1-C106	EO-202216	1-T13	EW-306428	4-9		
EC-337602	1-VC2	EO-307786	1-T11	EW-336923	4-12x		
EC-337603	1-VC3	EO-318365	1-L2, 3	EW-336924	4-14x		
EC-337603	1-VC1	EO-318380	1-L4	EW-336926	4-13x		
EC-338496	2-C1	EO-336833	1-T14	SA-332850	4-27		
EC-338496	3-C1	EO-336878	1-T1	SE-342181	5-15x		
EC-338577	2-C1	EO-336879	1-T2	SK-332744	5-17		
EC-338585	1-C64	EO-336934	1-L5	SK-332745A	5-9		
ED-200469	1-D29, 30	EO-337415	1-T6, 7	SK-332745B	5-10x		
ED-200469	1-D24	EO-337572	1-T3	SK-332747A	5-11		
ED-200469	1-D4	EO-337573	1-T4	SK-332747B	5-12x		
ED-200469	1-D18	EO-337574	1-T5	SK-332750A	5-13		
ED-200469	1-D36	EO-337598	1-T8	SK-332750B	5-14x		
ED-200469	1-D28	EO-337599	1-T9	SK-342499A	5-19		
ED-200469	1-D22, 23	EO-337607	1-T12	SK-342499B	5-20x		
ED-200469	1-D16	EO-337608	1-L1	SK-342499C	5-21		
ED-200469	1-D27	EO-338409	3-FL1	SK-342499D	5-22x		
ED-200469	1-D25, 26	ER-318248	1-FR1	SP-332734A	4-1		
ED-200469	1-D15	ER-318248	1-FR2	SP-332734B	4-2x		
ED-223547	1-D35	ER-322787	1-R129	SP-332734C	4-3x		
ED-300257	1-D43	ER-324184	1-R38	SP-332734D	4-4x		
ED-301911	1-D4 to 6	ER-324184	1-R124	SP-332734E	4-5x		
ED-301911	1-D1 to 3	ER-324184	1-R118	SP-332734F	4-6x		
ED-301911	1-D19 to 21	ER-324184	1-R55	SP-332734G	4-7x		
ED-301911	1-D31, 32	ER-324184	1-R62	SP-332734H	4-8x		
ED-301911	1-D37 to 39	ER-324184	1-R7	SP-332738	4-26x		
ED-301911	1-D13, 14	ER-324184	1-R24	SP-332743A	5-5x		
ED-301911	1-D7 to 9	ER-324185	1-R118	SP-332743B	5-6x		
ED-301911	1-D17	ER-324186	1-R204	SP-332743C	5-7x		
ED-322238	1-D42	ER-324186	1-R222	SP-332743D	5-8x		
ED-323057	1-D12	ER-324480	1-R5	SP-332752A	5-27		
ED-323057	1-D40	ER-337325	1-FL5	SP-332752B	5-28x		
ED-323216	1-D45	ER-337326	1-FL5	SP-332753A	5-23		
ED-323216	1-D33, 34	ER-337327	1-FL6	SP-332753B	5-24x		
ED-336805	1-D41	ER-337328	1-FL6	SP-332753C	5-25x		
ED-337413	1-D14	ER-337989	1-FL1 to 3	SP-332753D	5-26x		
ED-337414	1-D7 to 13	ER-338408	1-FR1	SZ-332739	4-17		
ED-337414	1-D1 to 3	ER-341654	1-FL4	SZ-332748	5-16x		
ED-337605	1-D10, 11	ES-328414	1-SW1	SZ-631945	4-15		
ED-337606	1-D44	ES-328787	2-SW1	ZG-313182	5-18x		
ED-562386	1-D5, 6	ES-328788	2-SW1	ZS-319460	4-18		
EE-337570	1-7	ES-336760	1-SW1 to 20	ZS-322570	5-29		
EE-337571	1-8	ES-336909	2-SW1	ZS-322580	5-30x		
EE-337976	4-28	ES-336909	3-SW1	ZW-305013	4-29x		
EF-300588	4-38x	ET-307193	1-TR53	ZW-698308	4-24x		
EF-300599	4-36x	ET-307193	1-TR49				
EF-306088	4-34x	ET-316643	1-TR36 to 44				
EF-308933	4-30	ET-316643	1-TR48				
EF-309389	4-31x	ET-316643	1-TR32 to 35				
EF-309390	4-33x	ET-316643	1-TR26				
EF-315334	4-35x	ET-316643	1-TR23				
EF-322975	4-37x	ET-316643	1-TR18				
EF-322975	4-39x	ET-316643	1-TR9 to 13				
EF-327103	4-32x	ET-316643	1-TR51, 52				
EI-202218	1-IC6	ET-316643	1-TR27				

Parts No.	Ref. No. & Symbol No.	Parts No.	Ref. No. & Symbol No.	Parts No.	Ref. No. & Symbol No.	Parts No.	Ref. No. & Symbol No.
BA-A2018A040A	2-1	EJ-337405	4-17	ET-337984	1-TR2		
BA-A2018A040B	2-2	EJ-337406	4-13	ET-337985	1-TR9		
BA-A2018A060A	1-1	EJ-342935	4-2x	ET-337986	1-TR10		
BA-A2018A060B	1-2	EJ-692908	4-44x	EV-325629	1-VR1		
BA-A2018A060C	1-3	EL-337757	1-IN1, 2	EV-325630	1-VR2		
BA-A2018A060D	1-4	EL-337757	1-IN1	EV-337308	1-VR1		
BA-A2018A060E	1-5	EO-332116	1-L1	EV-337987	1-VR3		
BA-A2018A060F	1-6	EO-336934	1-L1	EW-306427	4-38x		
BA-A2018A060G	1-7	EO-336934	2-J1	EW-306428	4-37		
BA-A2018A060H	1-8	EO-336934	2-L1 to 4	EW-328245	4-39x		
BA-A2018A060J	1-9	EO-336934	2-L2, 3	EW-336923	4-40x		
BA-A2018A060K	1-10	EO-337684	2-L1	EW-336924	4-42x		
BD-A2018A030A	5-14	EO-338409	3-FL1	EW-336926	4-41x		
BD-A2018A030B	5-15x	EO-342936	4-3x	SA-332850	4-26		
BT-341430	4-20x	EP-323565	1-RL2	SK-B336468	5-16		
BT-341431	4-22x	EP-337416	1-RL1	SK-B336472A	5-18		
BT-341432	4-21x	ER-316802	1-R61, 62	SK-B336472B	5-19x		
BT-341433	4-23x	ER-322361	1-R75	SK-B336472C	5-20		
BT-341434	4-24x	ER-322591	1-R41, 42	SK-B336472D	5-21x		
BT-341435	4-19	ER-323075	1-R39, 40	SK-B336472E	5-3		
EC-314688	3-C1	ER-323075	1-R51	SK-B336472F	5-4x		
EC-320548	1-C42	ER-323075	1-R59, 60	SK-B336472G	5-5		
EC-320548	1-C43	ER-323075	1-R90, 91	SK-B336472H	5-6x		
EC-320548	1-C44, 45	ER-323351	2-R18	SK-B336472J	5-7		
EC-320548	1-C46 to 49	ER-323352	2-R17	SK-B336472K	5-8x		
EC-320548	3-C1	ER-324185	1-R35	SK-B336472L	5-9		
EC-324102	2-C7	ER-324337	1-R17	SK-B336472M	5-10x		
EC-324103	2-C6	ER-324934	2-R27, 28	SK-B336472N	5-11		
EC-326583	1-C42	ER-328082	1-R47, 48	SK-B336472P	5-12x		
EC-326583	1-C43	ER-332225	1-FR1	SK-B336474A	5-22		
EC-330308	3-C1	ER-332225	2-FR1, 2	SK-B336474B	5-23x		
EC-332052	1-C27, 28	ER-333689	1-R52	SK-336470A	5-31		
EC-334013	1-C31	ER-333698	1-R94, 95	SK-336470B	5-32x		
EC-337306	1-C38, 39	ER-337100	2-R16	SK-336471A	5-25		
EC-338411	3-C1	ER-337752	1-R32	SK-336471B	5-26x		
ED-200469	1-D3	ER-337754	1-R68, 69	SK-336479A	5-1		
ED-200469	1-D8, 9	ER-337754	1-R80	SK-336479B	5-2x		
ED-200469	1-D25, 26	ER-337755	1-R74	SP-336440A	4-8x		
ED-200469	2-D1 to 3	ER-337756	1-FR3, 4	SP-336440B	4-7		
ED-200469	2-D5	ER-337999	2-R15	SP-336440C	4-10x		
ED-200749	1-D15	ER-338000	1-FR2	SP-336440D	4-9x		
ED-323057	2-D4	ER-624756	1-R76	SP-336440E	4-11x		
ED-323534	1-D17	ES-323369	2-SW3	SP-336440F	4-12x		
ED-330218	1-D20, 21	ES-328787	3-SW1	SP-336441	4-25x		
ED-330320	1-D16	ES-328788	3-SW1	SP-336443A	5-29		
ED-336805	1-D13	ES-336909	3-SW1	SP-336443B	5-30x		
ED-337153	1-D4 to 7	ES-337317	4-6	SP-336465A	5-27		
ED-337153	1-D10	ES-337388	2-SW1	SP-336465B	5-28x		
ED-337153	1-D12	ES-337389	1-SW1	SZ-631945	4-43		
ED-337153	1-D14	ES-337390	3-SW1	ZG-313027	5-13x		
ED-337153	1-D22	ES-337392	1-SW1	ZG-336449	5-17x		
ED-337153	1-D29	ES-337393	1-SW1	ZG-336460	5-24x		
ED-337391	1-D1 to 4	ES-337394	1-SW2	ZS-308846	4-16		
ED-337391	4-1x	ES-337398	4-27	ZS-308846	4-18		
ED-337750	1-D11	ES-337403	4-5	ZS-322570	5-34		
ED-337751	1-D23	ES-337998	2-SW2	ZS-322580	5-35x		
ED-337751	1-D27, 28	ET-300931	1-TR26	ZS-522865	4-14		
ED-337761	1-D24	ET-300931	1-TR22	ZW-305013	5-33x		
ED-337990	1-D18, 19	ET-301165	1-TR27				
ED-338096	1-D1, 2	TT-301165	1-TR23				
EF-249851	4-28	ET-305463	1-TR7				
EF-258344	4-36x	ET-305463	1-TR11				
EF-200952	4-30x	ET-305463	1-TR15				
EF-309388	4-31x	ET-305463	1-TR18				
EF-309391	4-33x	ET-305463	2-TR4 to 6				
EF-310229	4-34x	ET-307195	1-TR8				
EF-459843	4-32x	ET-307195	1-TR12 to 14				
EF-623125	4-29x	ET-307195	1-TR24				
EF-623125	4-35x	ET-307195	2-TR2, 3				
EI-200938	1-IC1	ET-307195	2-TR7				
EI-200938	1-IC3	ET-308866	1-TR4				
EI-337593	4-4	ET-308977	2-TR8				
EJ-324913	2-J4	ET-316171	1-TR16, 17				
EJ-329610	4-15	ET-328440	1-TR19				
EJ-336885	1-J8	ET-328440	1-TR1				
EJ-336885	1-J8	ET-337234	2-TR1				
EJ-336886	1-J8	ET-337758	1-TR3				
EJ-336886	1-J8	ET-337759	1-TR20, 21				
EJ-336915	2-J2	ET-337760	1-TR25				
EJ-337404	2-J1	ET-337760	2-TR9				

Parts No.	Ref. No. & Symbol No.	Parts No.	Ref. No. & Symbol No.	Parts No.	Ref. No. & Symbol No.	Parts No.	Ref. No. & Symbol No.
BA-A2019A060A	1-1	EF-691007	4-45x	ET-307195	1-TR8		
BA-A2019A060B	1-2	EI-200938	1-IC1	ET-307195	1-TR12 to 14		
BA-A2019A060C	1-3	EI-200938	1-IC3	ET-307195	1-TR24		
BA-A2019A060D	1-4	EI-200938	2-IC1	ET-307195	2-R2, 3		
BA-A2019A060E	1-5	EI-338022	4-6	ET-307195	2-TR7		
BA-A2019A060F	1-6	EJ-329610	4-25	ET-308866	1-TR4		
BA-A2019A060G	1-7	EJ-336885	1-J8	ET-308977	2-TR8		
BA-A2019A060H	1-8	EJ-336885	1-J8	ET-316171	1-TR 16, 17		
BA-A2019A060J	1-9	EJ-336886	1-J8	ET-328440	1-TR1		
BA-A2019A060K	1-10	EJ-336886	1-J8	ET-328440	1-TR19		
BA-A2019A120A	2-1	EJ-336915	2-J2, 3	ET-337234	2-TR1		
BA-A2019A120B	2-2	EJ-337404	2-J1	ET-337758	1-TR3		
BD-A2019A020A	5-1	EJ-337405	4-26	ET-337759	1-TR20, 21		
BD-A2019A020B	5-2x	EJ-337405	4-27x	ET-337760	1-TR25		
BD-A2019A030A	5-12	EJ-337406	4-24	ET-337760	2-TR9		
BD-A2019A030B	5-13x	EJ-342935	4-3x	ET-337984	1-TR2		
BD-B336500A	5-28	EJ-692908	4-35x	ET-337985	1-TR9		
BD-B336500B	5-29x	EL-337757	1-IN1, 2	ET-337986	1-TR10		
BD-336496B	5-38x	EL-337757	1-IN1	EV-330724	1-VR3		
BT-338023	4-8x	EO-332116	1-L1	EV-330725	1-VR1		
BT-338024	4-10x	EO-336934	1-L1	EV-330843	1-VR2		
BT-338025	4-9x	EO-336934	2-L2, 3	EV-337309	4-1x		
BT-338026	4-11x	EO-336934	2-L1 to 4	EV-338118	2-VR1		
BT-338028	4-12x	EO-337684	2-L1	EW-306427	4-29x		
BT-338029	4-13x	EO-338409	3-FL1	EW-306428	4-28		
BT-338030	4-7	EO-342936	4-4x	EW-328245	4-30x		
EC-201643	1-C50, 51	EP-323565	1-RL2	EW-336923	4-31x		
EC-314688	3-C1	EP-337416	1-RL1	EW-336924	4-33x		
EC-316189	1-C53, 54	ER-200944	2-R37, 38	EW-336926	4-32x		
EC-320548	1-C42	ER-309781	2-R14	SA-312465	4-15x		
EC-320548	1-C43	ER-311768	2-R15	SK-B336468	5-3		
EC-320548	1-C44, 45	ER-316802	1-R61, 62	SK-B336472A	5-5		
EC-320548	1-C46 to 49	ER-322421	1-R41, 42	SK-B336472B	5-6x		
EC-320548	3-C1	ER-323075	1-R39, 40	SK-B336472C	5-7		
EC-324102	2-C7	ER-323075	1-R51	SK-B336472D	5-8x		
EC-324103	2-C6	ER-323075	1-R59, 60	SK-B336472E	5-17		
EC-326583	1-C42	ER-323075	1-R90, 91	SK-B336472F	5-18x		
EC-326583	1-C43	ER-323351	2-R18	SK-B336472G	5-19		
EC-330308	3-C1	ER-323352	2-R17	SK-B336472H	5-20x		
EC-332052	1-C27, 28	ER-324185	1-R35	SK-B336472J	5-21		
EC-332052	2-C15, 16	ER-324337	1-R17	SK-B336472K	5-22x		
EC-334013	1-C31	ER-324934	2-R27, 28	SK-B336472L	5-23		
EC-338032	1-C59, 60	ER-328082	1-R47, 48	SK-B336472M	5-24x		
EC-338411	3-C1	ER-332225	1-FR1	SK-B336472N	5-25		
ED-200469	1-D8, 9	ER-332225	2-FR1, 2	SK-B336472P	5-26x		
ED-200469	1-D25, 26	ER-333689	1-R52	SK-B336474A	5-9		
ED-200469	1-D3	ER-333698	1-R94, 95	SK-B336474B	5-10x		
ED-200469	2-D1, 2	ER-337100	2-R16	SK-336470A	5-41		
ED-200469	2-D3	ER-337752	1-R32	SK-336470B	5-42x		
ED-200469	2-D5	ER-337754	R68, 69	SK-336471A	5-34		
ED-306469	1-D17	ER-337754	1-R80	SK-336471B	5-35x		
ED-323057	2-D4	ER-337755	1-R74	SK-336471C	5-36x		
ED-328481	1-D11	ER-337756	1-FR3, 4	SK-336479A	5-15		
ED-330218	1-D20, 21	ER-338000	1-FR2	SK-336479B	5-16x		
ED-330218	2-D6, 7	ER-338084	1-R75	SP-336440G	4-18x		
ED-330320	1-D16	ER-624756	1-R76	SP-336440H	4-17		
ED-336805	1-D13	ES-328787	3-SW1	SP-336440J	4-20x		
ED-337153	1-D10	ES-328788	3-SW1	SP-336440K	4-19x		
ED-337153	1-D12	ES-336909	3-SW1	SP-336440L	4-21x		
ED-337153	1-D14	ES-337389	1-SW1	SP-336440M	4-22x		
ED-337153	1-D22	ES-337390	3-SW1	SP-336443A	5-39		
ED-337153	1-D29	ES-337392	1-SW1	SP-336443B	5-40x		
ED-337153	1-D4 to 7	ES-337393	1-SW1	SP-336494	4-14x		
ED-337391	1-D1 to 3	ES-337394	1-SW2	SP-336496A	5-37		
ED-337391	1-D4	ES-337399	4-37	SP-336499A	5-32		
ED-337391	4-2x	ES-337400	2-SW3	SP-336499B	5-33x		
ED-337395	4-5x	ES-337401	2-SW1	SZ-631945	4-34		
ED-337751	1-D23	ES-337402	4-36	TA-336480	5-14x		
ED-337751	1-D27, 28	ES-337998	2-SW2	TA-336501A	5-30		
ED-337990	1-D18, 19	ET-300931	1-TR22	TA-336501B	5-31x		
ED-338041	1-D15	ET-300931	1-TR26	ZG-313027	5-27x		
ED-338049	1-D24	ET-301165	1-TR23	ZG-336460	5-11x		
EF-242605	4-38	ET-301165	1-TR27	ZS-308846	4-23		
EF-258344	4-46x	ET-305463	1-TR5	ZS-322570	5-43		
EF-303348	4-43x	ET-305463	1-TR7	ZS-322580	5-44x		
EF-306949	4-42x	ET-305463	1-TR11	ZS-365942	4-16x		
EF-309388	4-41x	ET-305463	1-TR15	ZW-305013	4-47x		
EF-309392	4-44x	ET-305463	1-TR18				
EF-341260	4-40x	ET-305463	2-TR4 to 6				
EF-691007	4-39x	ET-307195	1-TR6				

Free service manuals  
Gratis schema's

Digitized by

www.freesevicemanuals.info

SECTION 4

# SCHEMATIC DIAGRAM

## MODEL AT-S61/L/J MODEL AM-U41, AM-U61

1. SCHEMATIC DIAGRAM OF ICs.....	70
2. AT-S61 NO. 1640660A SCHEMATIC DIAGRAM.....	75
3. AT-S61L NO. 1640661A SCHEMATIC DIAGRAM.....	76
4. FT-S61J NO. 1640662A SCHEMATIC DIAGRAM.....	77
5. AM-U41 NO. 1640846A SCHEMATIC DIAGRAM.....	78
6. AM-U61 NO. 1640848A SCHEMATIC DIAGRAM.....	79

### SCHEMATIC DIAGRAM OF ICs

LA1245

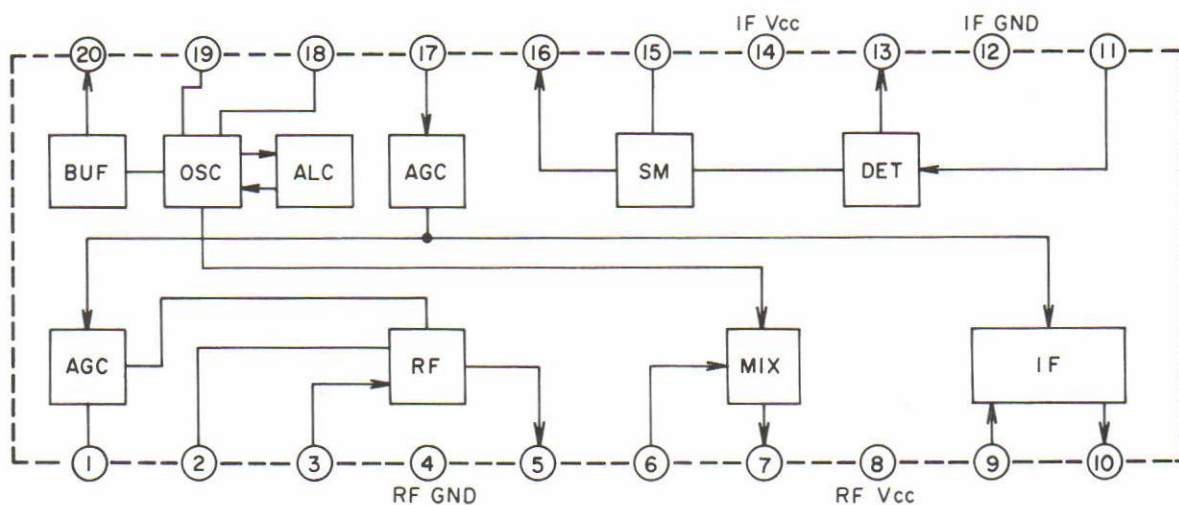

LB1426

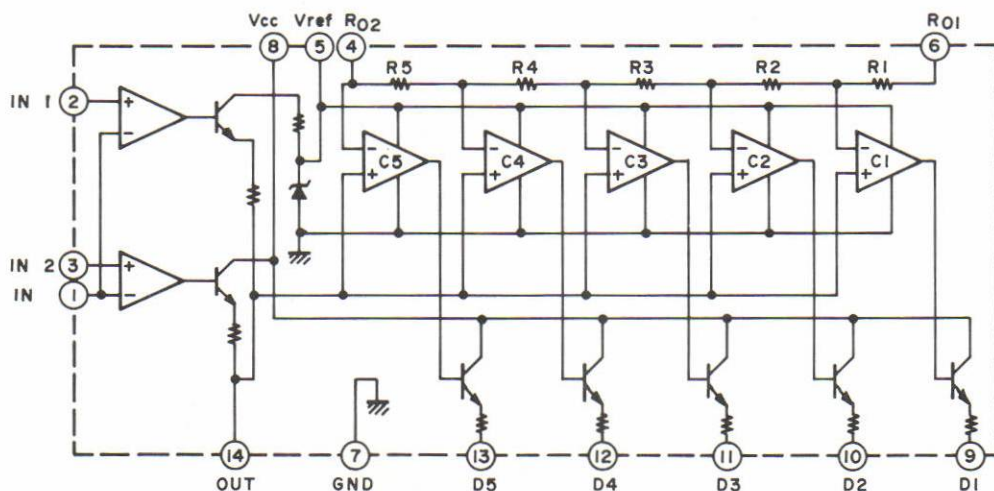

LA1222

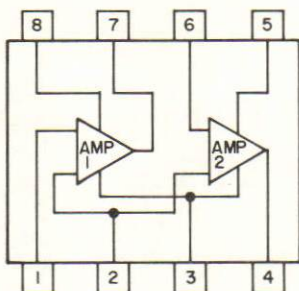

TD6102P

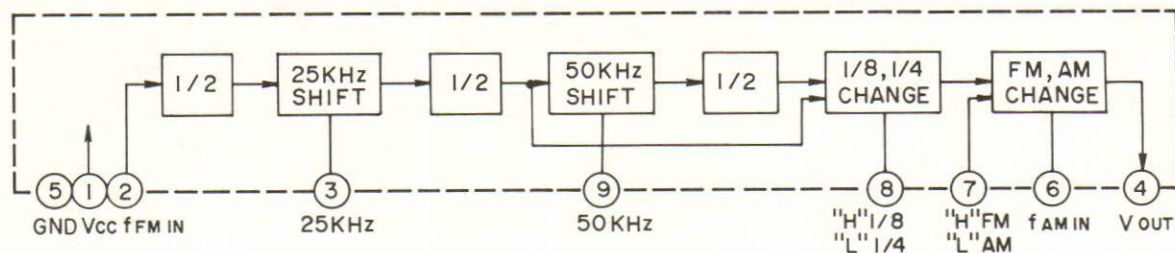

TC9125BP

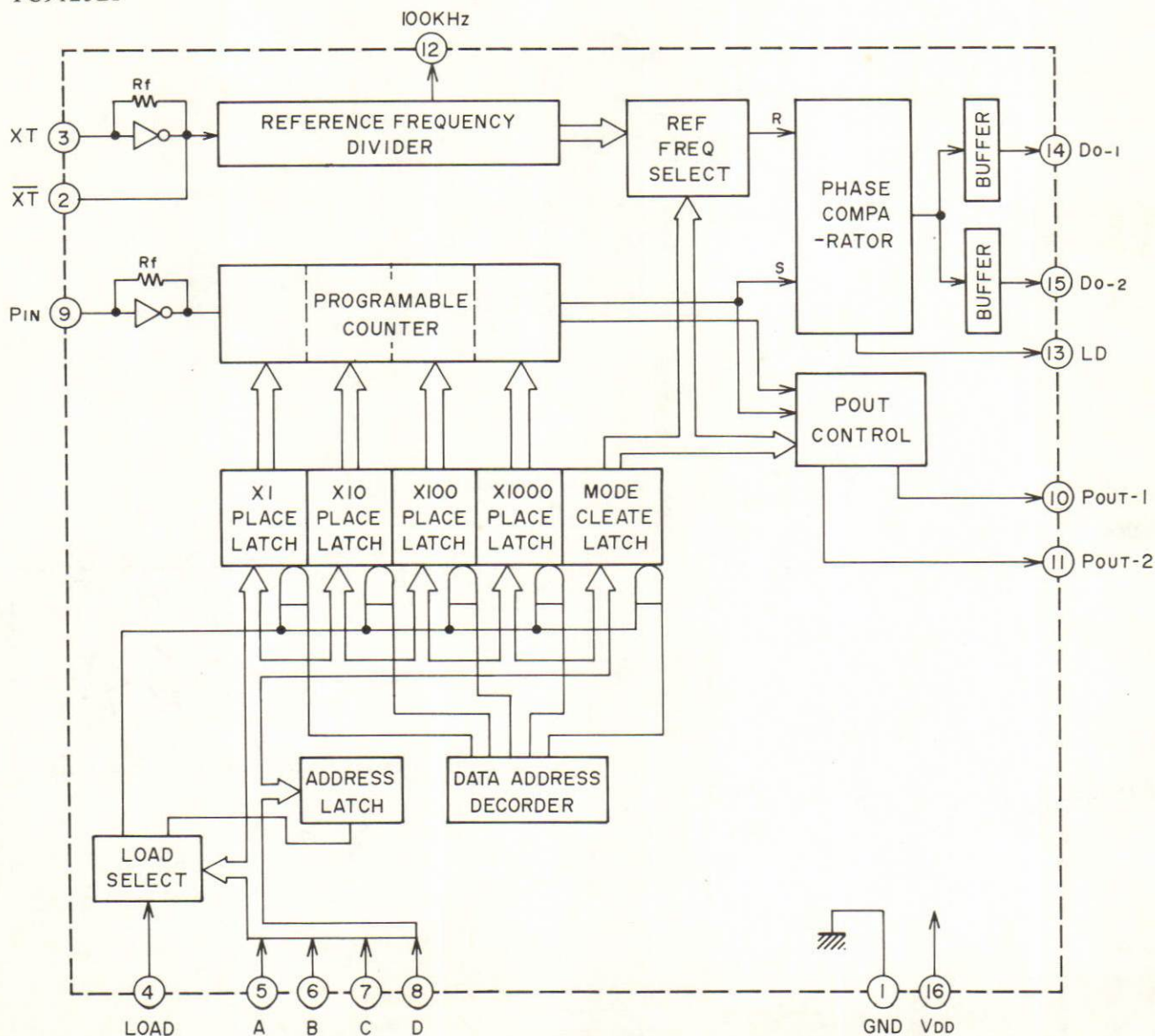



LA3381

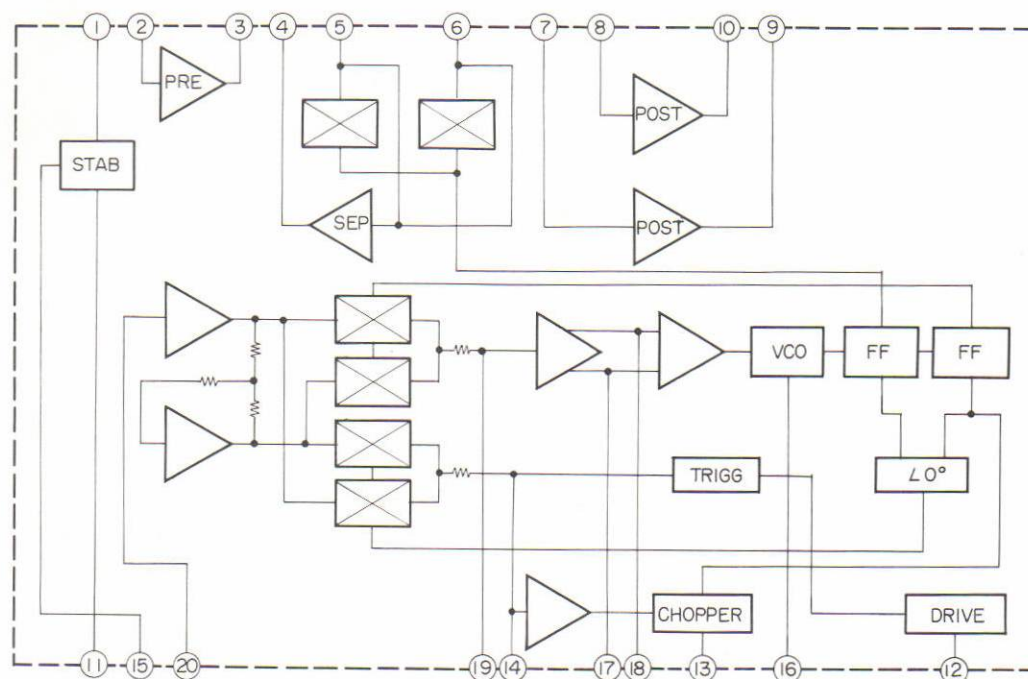

M54517

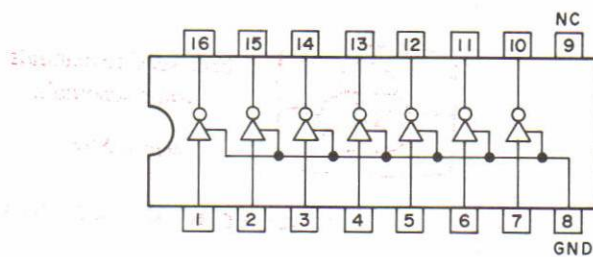

TC4069UB

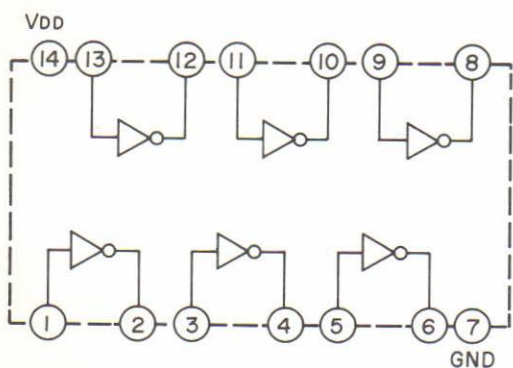

TC5066BP

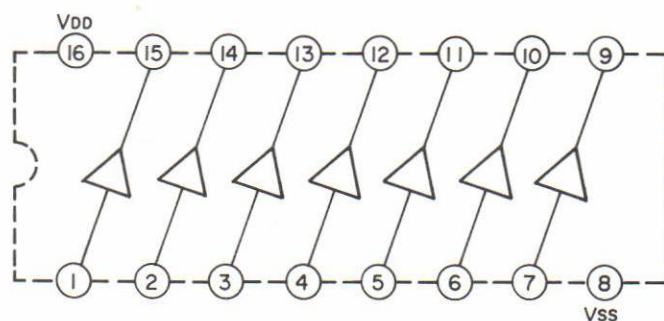

STK-1060II

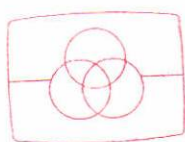
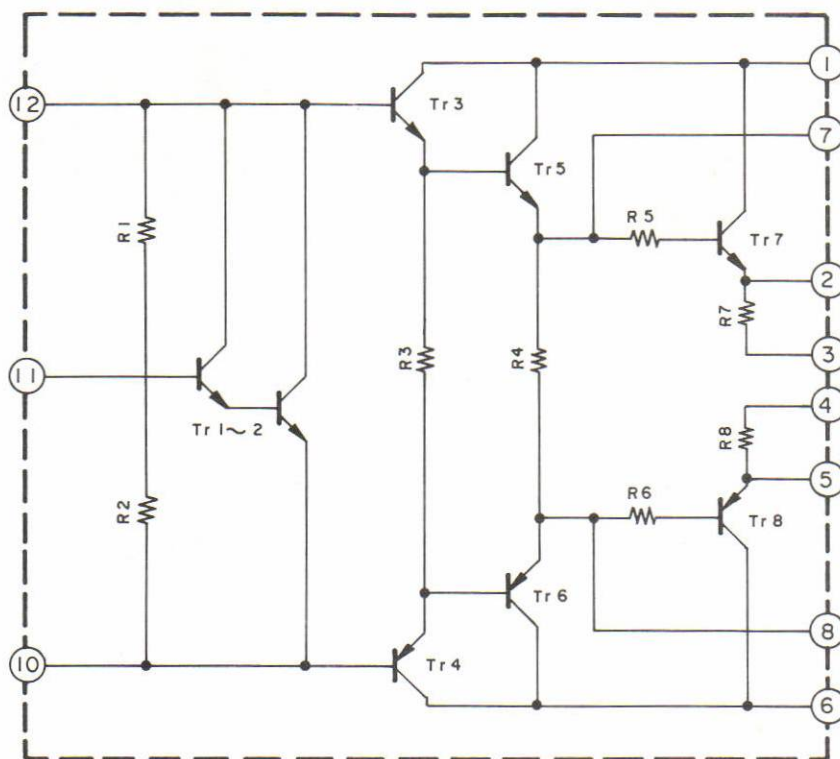

Free service manuals  
Gratis schema's  
Digitized by

STK-1080II

www.freeservicemanuals.info

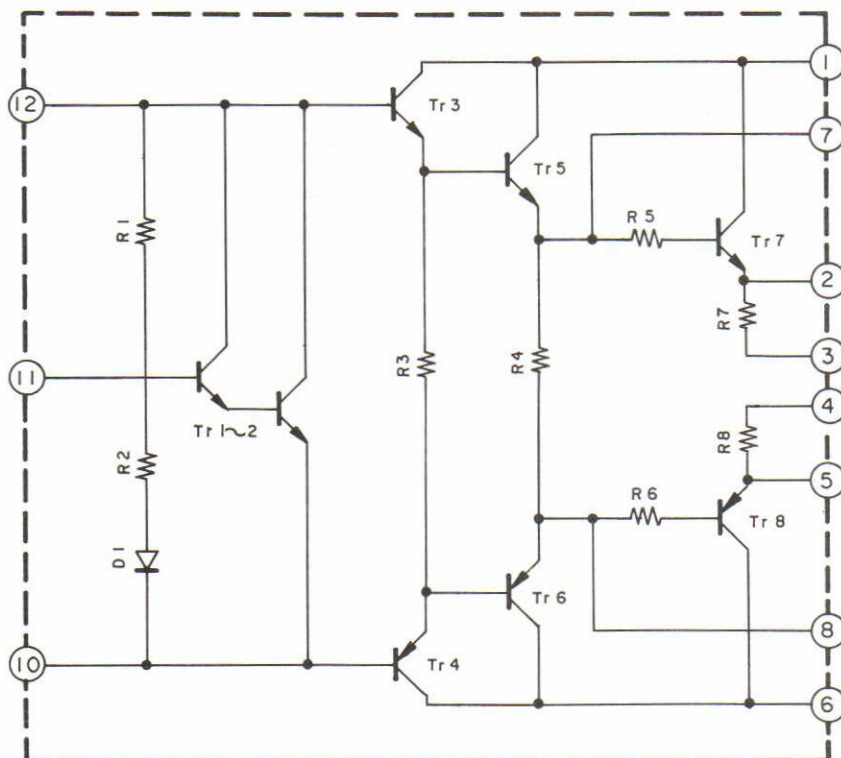

TA75558S

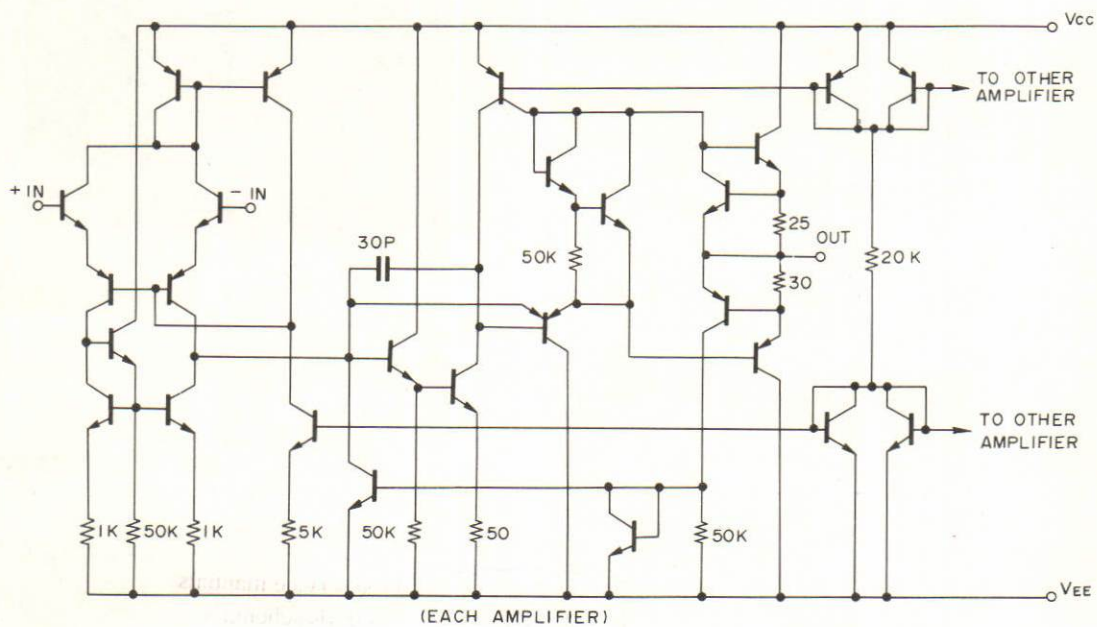
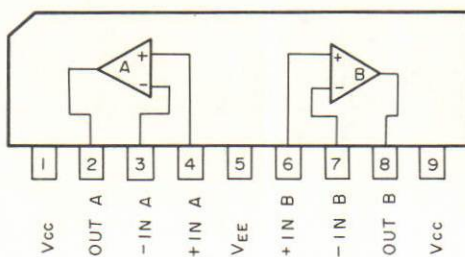

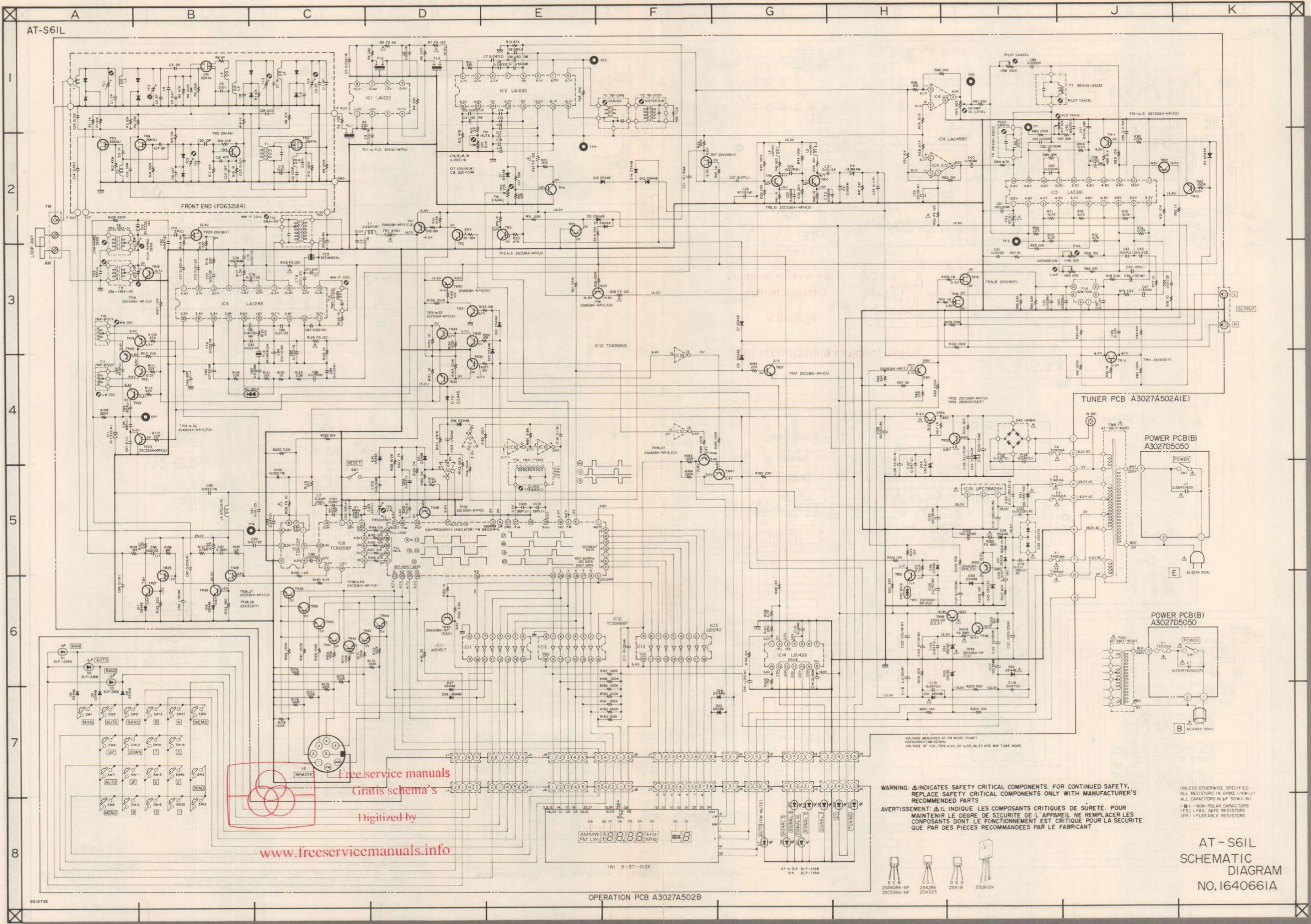

Free service manuals  
 Gratis schema's  
 Digitized by  
 www.freeservicemanuals.info

WARNING: ⚠ INDICATES SAFETY CRITICAL COMPONENTS. FOR CONTINUED SAFETY, REPLACE SAFETY CRITICAL COMPONENTS ONLY WITH MANUFACTURER'S RECOMMENDED PARTS.  
 AVERTISSEMENT: ⚠ IL INDIQUE LES COMPOSANTS CRITIQUES DE SÛRETÉ. POUR MAINTENIR LE DEGRÉ DE SÛRETÉ DE L'APPAREIL, NE REMPLACER LES COMPOSANTS DONT LE FONCTIONNEMENT EST CRITIQUE POUR LA SÛRETÉ QUE PAR DES PIÈCES RECOMMANDÉES PAR LE FABRICANT.

UNLESS OTHERWISE SPECIFIED:  
 ALL RESISTORS IN OHMS (R/W/J)  
 ALL CAPACITORS IN P.F. (P/F/W/J)  
 # = NON-POLAR CAPACITORS  
 (FS) = FAIL-SAFE RESISTORS  
 (FR) = FUSEABLE RESISTORS



AT-S61L  
 SCHEMATIC  
 DIAGRAM  
 NO.1640661A

OPERATION PCB A3027A502B

AT-S61

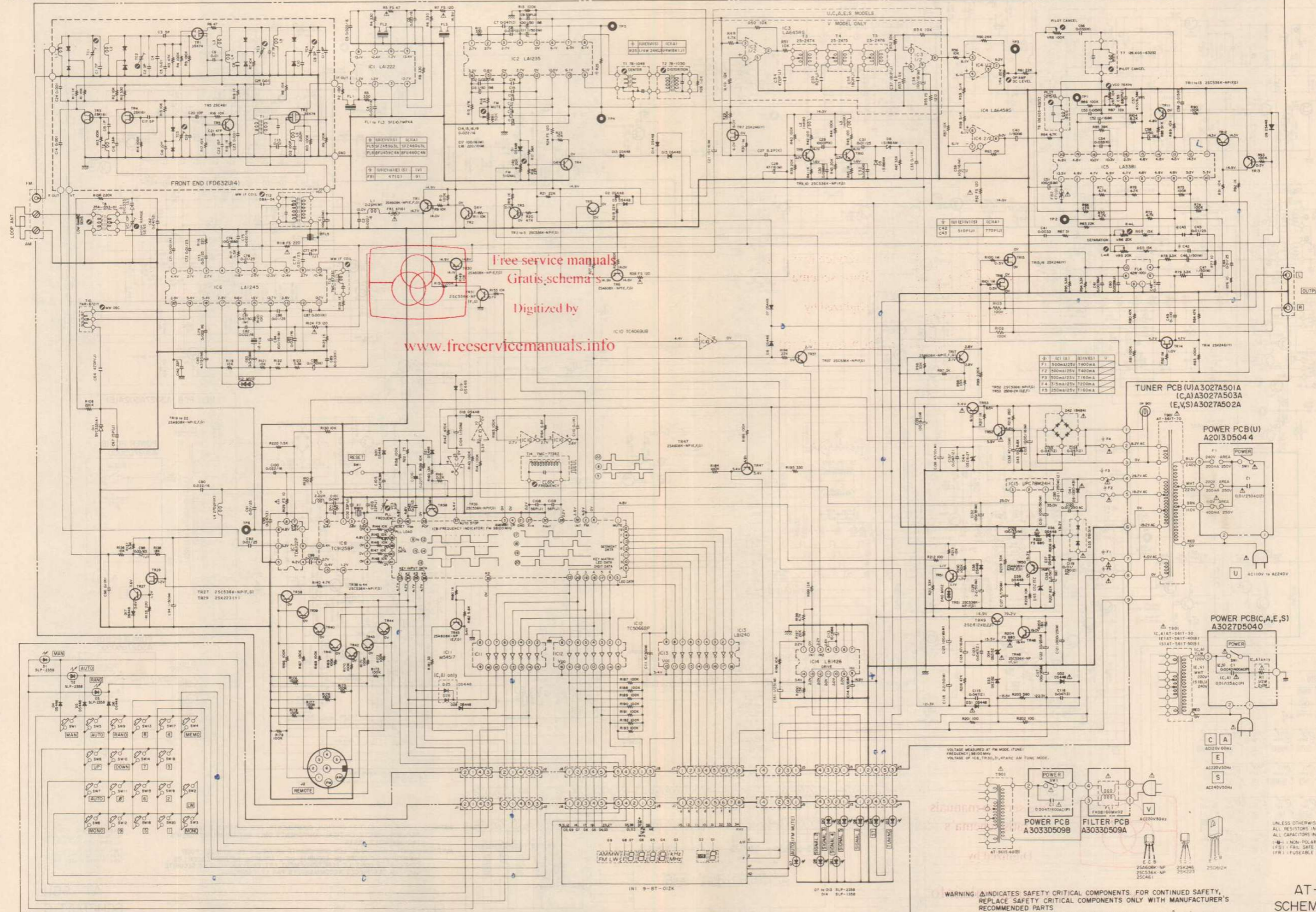

Free service manuals  
 Gratis schemas  
 Digitized by  
 www.freeservicemanuals.info

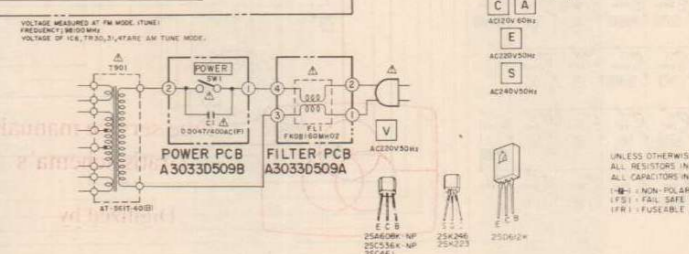

WARNING: Δ INDICATES SAFETY CRITICAL COMPONENTS. FOR CONTINUED SAFETY, REPLACE SAFETY CRITICAL COMPONENTS ONLY WITH MANUFACTURER'S RECOMMENDED PARTS.  
 AVERTISSEMENT: Δ IL INDIQUE LES COMPOSANTS CRITIQUES DE SÛRETÉ. POUR MAINTENIR LE DEGRÉ DE SÛRETÉ DE L'APPAREIL NE REMPLACER LES COMPOSANTS DONT LE FONCTIONNEMENT EST CRITIQUE POUR LA SÛRETÉ QUE PAR DES PIÈCES RECOMMANDÉES PAR LE FABRICANT.

AT-S61  
 SCHEMATIC  
 DIAGRAM  
 NO. 1640660A

OPERATION PCB (U) A3027A501B (C,A) A3027A503A (E,V,S) A3027A5032B

AT-S61J

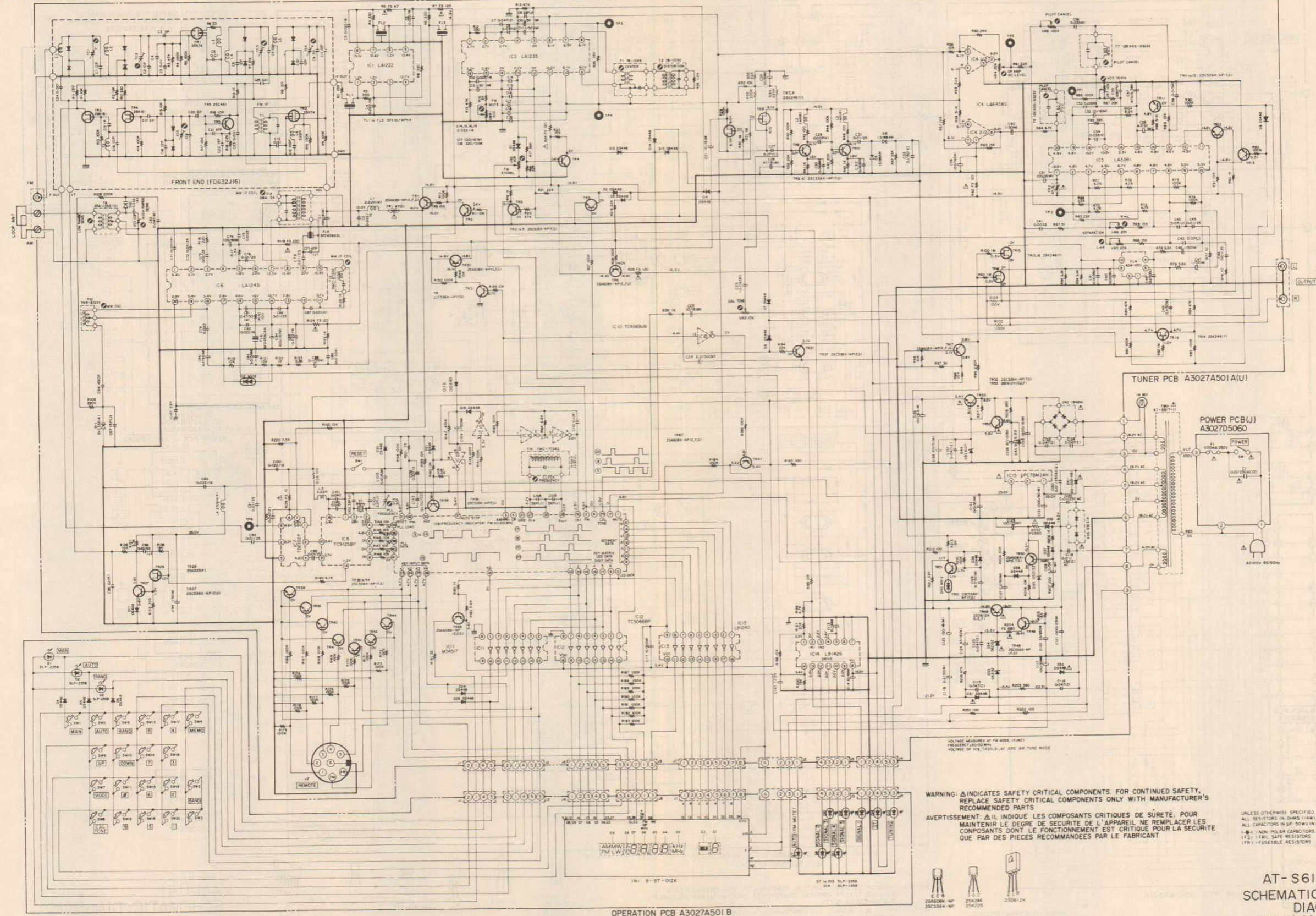

AM-U41

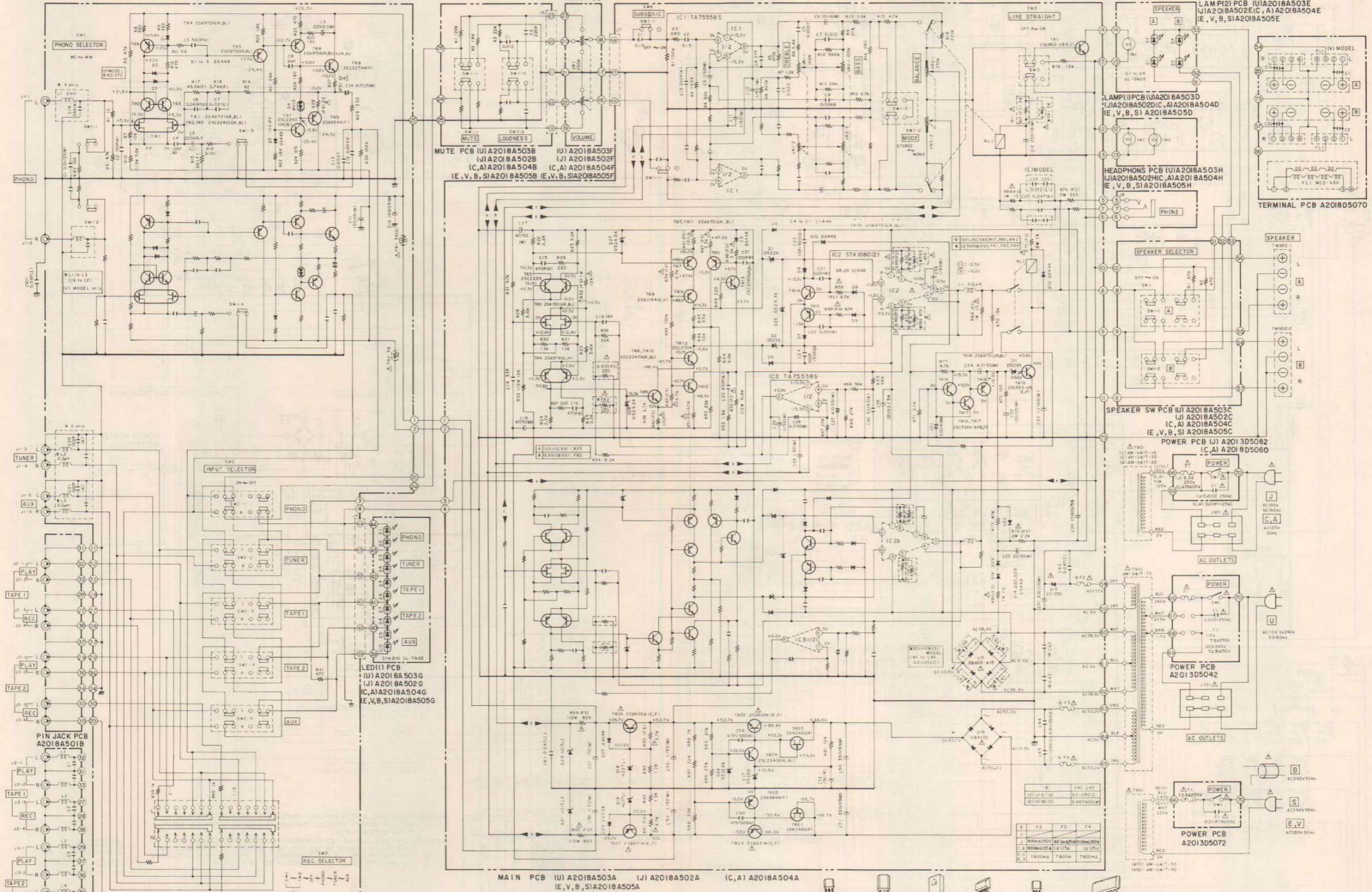

WARNING: Δ INDICATES SAFETY CRITICAL COMPONENTS. FOR CONTINUED SAFETY, REPLACE SAFETY CRITICAL COMPONENTS ONLY WITH MANUFACTURER'S RECOMMENDED PARTS.

AVERTISSEMENT: Δ IL INDIQUE LES COMPOSANTS CRITIQUES DE SÛRETÉ. POUR MAINTENIR LE DEGRÉ DE SÛRETÉ DE L'APPAREIL NE REMPLACER LES COMPOSANTS DONT LE FONCTIONNEMENT EST CRITIQUE POUR LA SÛRETÉ QUE PAR DES PIÈCES RECOMMANDÉES PAR LE FABRICANT.

- ECB 25C2240
- ECB 25A970
- ECB 25A974
- ECB 25A984K
- ECB 25C536K-NP
- ECB 25S863
- ECB 25A144
- ECB 25C2704
- ECB 25D600K
- ECB 25B631K
- BCEB 25C2295
- BCEB 25A979
- DGS 25K246
- DGS 25K270
- DGS 25K150

AM-U41  
SCHEMATIC DIAGRAM  
No. 1640846A

EQUALIZER PCB A2018A501A

NOTE  
UNLESS OTHERWISE SPECIFIED  
ALL RESISTORS IN OHMS (1AW/J)  
ALL CAPACITORS IN µF (50WV/J)

MAIN PCB (U) A2018A503A (J) A2018A502A (C,A) A2018A504A  
IE,V,B,SI A2018A505A

POWER PCB A2013D5042  
POWER PCB A2013D5042  
POWER PCB A2013D5042

POWER PCB (J) A2013D5082  
(C,A) A2018D5060

HEADPHONES PCB (U) A2018A503H  
(J) A2018A502HC, (A) A2018A504H  
IE,V,B,SI A2018A505H

LAMP I PCB (U) A2018A503D  
(J) A2018A502D, (C,A) A2018A504D  
IE,V,B,SI A2018A505D

LAMP II PCB (U) A2018A503E  
(J) A2018A502E, (C,A) A2018A504E  
IE,V,B,SI A2018A505E

TERMINAL PCB A2018D5070

SPEAKER SW PCB (U) A2018A503F  
(J) A2018A502C, (A) A2018A504C  
IE,V,B,SI A2018A505C

SPEAKER SW PCB (U) A2018A503F  
(J) A2018A502C, (A) A2018A504C  
IE,V,B,SI A2018A505C

POWER PCB A2013D5042

POWER PCB A2013D5042

POWER PCB A2013D5042

POWER PCB A2013D5042

POWER PCB A2013D5042

AM-U61

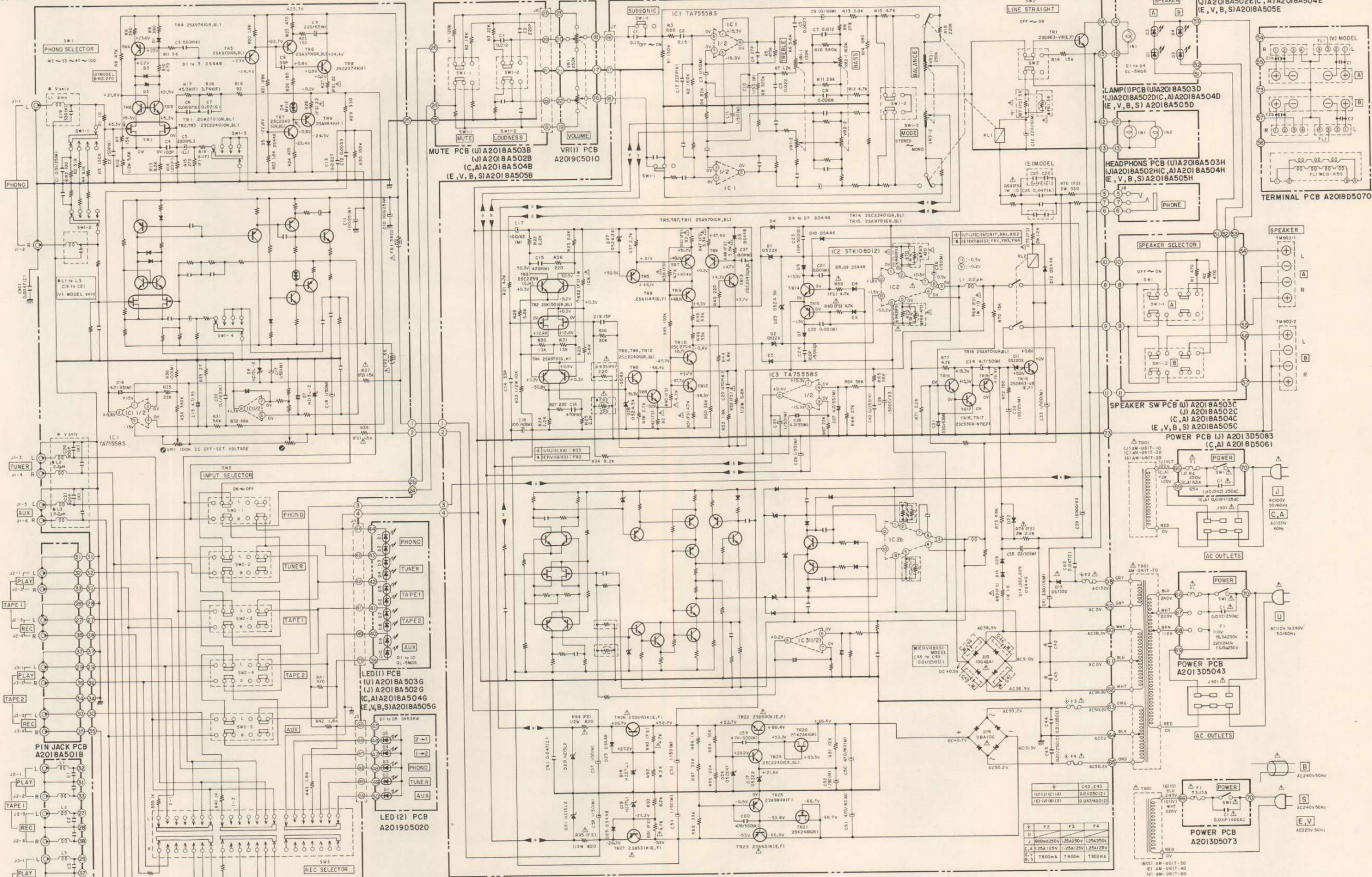

MAIN PCB (U) A2018A503A (J) A2018A502A (C,A) A2018A504A  
 (E,V,B,S) A2018A505A

WARNING: Δ INDICATES SAFETY CRITICAL COMPONENTS. FOR CONTINUED SAFETY, REPLACE SAFETY CRITICAL COMPONENTS ONLY WITH MANUFACTURER'S RECOMMENDED PARTS  
 AVERTISSEMENT: Δ IL INDIQUE LES COMPOSANTS CRITIQUES DE SÛRETÉ. POUR MAINTENIR LE DEGRÉ DE SÛRETÉ DE L'APPAREIL, NE REMPLACER LES COMPOSANTS DONT LE FONCTIONNEMENT EST CRITIQUE POUR LA SÛRETÉ QUE PAR DES PIÈCES RECOMMANDÉES PAR LE FABRICANT

NOTE  
 UNLESS OTHERWISE SPECIFIED  
 ALL RESISTORS IN OHMS 1/4W(1)  
 ALL CAPACITORS IN μF 50WV(1)

- ECB 25C2240
- ECB 25A970
- ECB 25A974
- ECB 25A984K
- ECB 25C396X-NP
- ECB 25DB63
- ECB 25A1144
- ECB 25C2704
- ECB 25D600K
- ECB 25B631K
- BCECB 25C2295
- BCECB 25A979
- DGS 25K246
- DGS 25K270
- DGS 25K150

AM-U61  
 SCHEMATIC DIAGRAM  
 No. 1640848A



## **AKAI ELECTRIC CO., LTD.**

12-14, 2-Chome, Higashi-Kojiya, Ohta-Ku, Tokyo, Japan

TEL Tokyo (742) 5111 CABLE HIFIAKAI TOKYO TELEX J26261

Printed No. 1640832-5117G1

Printed Date: May 10, 1982

Printed in Japan