

# AKAI SERVICE MANUAL

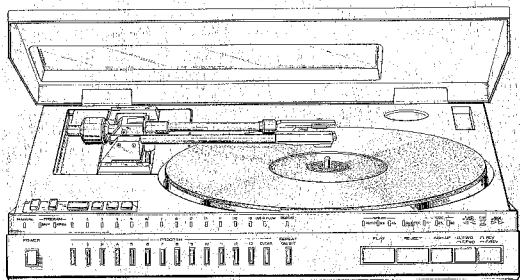

LINEAR TRACKING FULL AUTO DIRECT DRIVE  
TURN TABLE

MODEL **AP-L45/C**

LINEAR TRACKING PROGRAMABLE FULL AUTO  
DIRECT DRIVE TURN TABLE

MODEL **AP-L95/C**

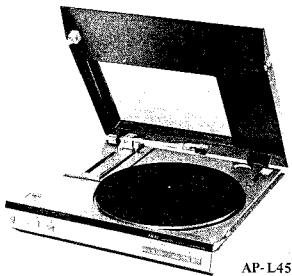

AP-L45



AP-L95

LINEAR TRACKING FULL AUTO DIRECT DRIVE TURN TABLE

MODEL **AP-L45/C**

LINEAR TRACKING PROGRAMABLE FULL AUTO  
DIRECT DRIVE TURN TABLE

MODEL **AP-L95/C**

THIS MANUAL IS APPLICABLE TO BOTH SILVER AND BLACK PANEL MODEL

SECTION 1	SERVICE MANUAL .....	3
SECTION 2	PARTS LIST .....	39
SECTION 3	SCHEMATIC DIAGRAM .....	55

---

SECTION I

**SERVICE MANUAL**

TABLE OF CONTENTS

I. SPECIFICATIONS	4
1. MODEL AP-L45/C	4
2. MODEL AP-L95/C	4
II. DISMANTLING OF UNIT	5
III. CONTROLS	6
1. MODEL AP-L45/C	6
2. MODEL AP-L95/C	7
IV. PRINCIPAL PARTS LOCATION	8
1. MODEL AP-L45/C	8
2. MODEL AP-L95/C	8
V. VOLTAGE CONVERSION	9
VI. OPERATION OF VARIOUS PARTS	9
1. FEATURES OF LINEAR TRACKING ARM	9
2. INPUT/OUTPUT AND FUNCTION OF MICROCOMPUTER TERMINALS	9
3. MODEL AP-L45/C BLOCK DIAGRAM	10
4. MODEL AP-L95/C BLOCK DIAGRAM	11
5. RECEPTION OF FUNCTION KEY INPUT AND LED DRIVE	12
6. HORIZONTAL DRIVE CIRCUIT OF ARM	13
7. FUNCTION OF INTERRUPTERS (A) AND (B)	15
8. TUNE INTERVAL DETECTION CIRCUIT (AP-L95)	16
9. MOTOR CONTROL CIRCUIT	17
VII. ORDINARY ADJUSTMENT	19
1. ATTACHING A CARTRIDGE	19
2. STYLUS PRESSURE ADJUSTMENT	19
VIII. ADJUSTMENT	21
1. TONE ARM LIFTER HEIGHT ADJUSTMENT	22
2. REJECT SWITCH INSTALLATION POSITION ADJUSTMENT	22
3. ARM MOVING SPEED ADJUSTMENT	23
4. DEFLECTION SENSOR POSITION ADJUSTMENT	24
5. DEFLECTION SENSOR ELECTRICAL ADJUSTMENT	24
6. REFLECTION SENSOR SENSITIVITY (AP-L95/C)	24
7. REFLECTION SENSOR POSITION ADJUSTMENT (AP-L95/C)	24
8. DEFLECTION SWITCH POSITION ADJUSTMENT	25
9. QUARTZ LOCK PHASE ANGLE ADJUSTMENT	25
IX. CLASSIFICATION OF VARIOUS P.C BOARDS	26
1. P.C BOARD TITLES AND IDENTIFICATION NUMBERS	26
2. MODEL AP-L45/C COMPOSITION OF VARIOUS P.C BOARDS	27
3. MODEL AP-L95/C COMPOSITION OF VARIOUS P.C BOARDS	30

For basic adjustments, measuring methods, and operating principles, refer to GENERAL TECHNICAL MANUAL.

# I. SPECIFICATIONS

## 1. MODEL AP-L45/C

DRIVE SYSTEM & MECHANISM	Direct Drive (Quartz Lock) Linear Tracking Arm Fully Automatic
TURNABLE	Zinc alloy die-cast
MOTOR	DC brush-less motor
SPEED	33-1/3 rpm $\pm$ 0.002%, 45 rpm $\pm$ 0.002%
WOW AND FLUTTER	0.04% (DIN), 0.02% (JIS)
RUMBLE	44 dB (DIN A), 75 dB (DIN B), 53 dB (JIS)
TONE ARM	Static balanced type linear tracking arm
EFFECTIVE ARM LENGTH	184 mm
STYLUS PRESSURE ADJUSTMENT RANGE	0 to 3 grams
APPLICABLE CARTRIDGE WEIGHT	4 to 10.5 grams
ARM LIFTER	Power Assisted cam drive
HORIZONTAL TRACKING ANGLE ERROR	$\pm$ 0.2°
SHELL WEIGHT	7.5 grams
CARTRIDGE	PC-95 (MM type: Dual magnet type) (Model AP-L45 does not include a cartridge)
OUTPUT VOLTAGE	5 mV (DIN 45541)
CHANNEL SEPARATION	More than 25 dB (DIN 45543)
OPTIMAL STYLUS PRESSURE	2 grams
STATIC VERTICAL COMPLIANCE	$18 \times 10^{-6}$ cm/dyne
STATIC HORIZONTAL COMPLIANCE	$29 \times 10^{-6}$ cm/dyne
POWER REQUIREMENTS	120V, 60 Hz for USA and Canada 220V, 50 Hz for Europe except UK 240V, 50 Hz for UK and Australia 110V, 120V, 220V or 240V, 50 or 60 Hz for other countries
DIMENSIONS	440 (W) $\times$ 124 (H) $\times$ 410 (D) mm (17.3 $\times$ 4.9 $\times$ 16.1 inches)
WEIGHT	11.0 kg (24.2 lbs)

## 2. MODEL AP-L95/C

DRIVE SYSTEM & MECHANISM	Direct Drive (Quartz Lock) Linear Tracking Arm Fully Automatic with Random Program Search System
MOTOR	DC brush-less motor
TURNABLE	Zinc alloy die-cast
SPEED	33-1/3 rpm $\pm$ 0.002%, 45 rpm $\pm$ 0.002%
WOW AND FLUTTER	0.04% (DIN), 0.02% (JIS)
RUMBLE	44 dB (DIN A), 75 dB (DIN B), 53 dB (JIS)
TONE ARM	Static balanced type linear tracking arm
EFFECTIVE ARM LENGTH	184 mm
STYLUS PRESSURE ADJUSTMENT RANGE	0 to 3 grams
APPLICABLE CARTRIDGE WEIGHT	4 to 10.5 grams
ARM LIFTER	Power Assisted cam drive
HORIZONTAL TRACKING ANGLE ERROR	$\pm$ 0.2°
SHELL WEIGHT	7.5 grams
CARTRIDGE	PC-95 (MM type: Dual magnet type) (Model AP-L95 does not include a cartridge)
OUTPUT VOLTAGE	5 mV (DIN 45541)
CHANNEL SEPARATION	More than 25 dB (DIN 45543)
OPTIMAL STYLUS PRESSURE	2 grams
STATIC VERTICAL COMPLIANCE	$18 \times 10^{-6}$ cm/dyne
STATIC HORIZONTAL COMPLIANCE	$29 \times 10^{-6}$ cm/dyne
POWER REQUIREMENTS	120V, 60 Hz for USA and Canada 220V, 50 Hz for Europe except UK 240V, 50 Hz for UK and Australia 110V, 120V, 220V or 240V, 50 or 60 Hz for other countries
DIMENSIONS	440 (W) $\times$ 124 (H) $\times$ 410 (D) mm (17.3 $\times$ 4.9 $\times$ 16.1 inches)
WEIGHT	11.2 kg (24.6 lbs)

\* For improvement purposes, specifications and design are subject to change without notice.

## II. DISMANTLING OF UNIT

In case of trouble, etc. necessitating dismantling, please dismantle in the order shown in the photographs. Reassemble in reverse order.

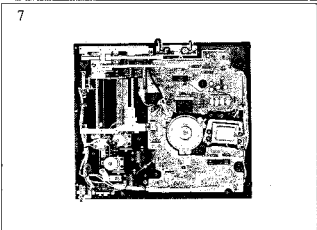
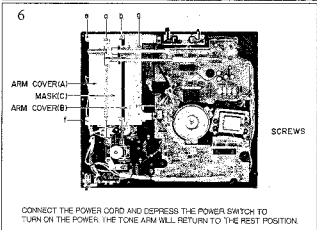
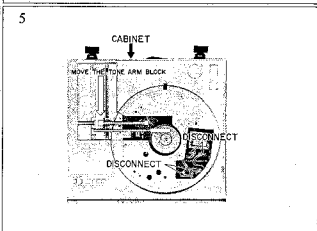
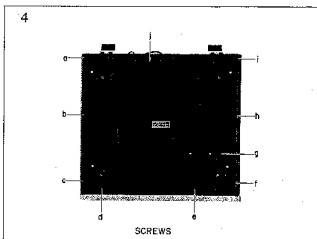
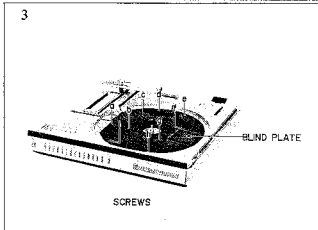
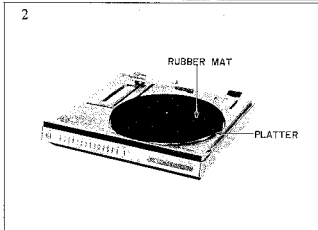
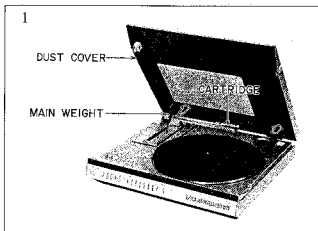

### III. CONTROLS

#### 1. MODEL AP-L45/C

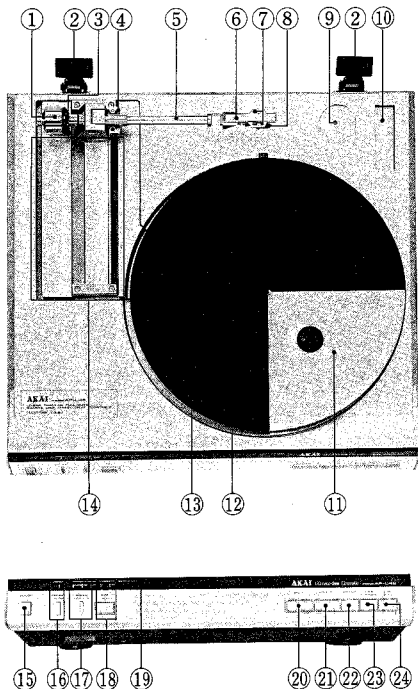

Fig. 1 Controls (Model AP-L45/C)

- |   |  |
|---|--|
| 1. MAIN WEIGHT  | 14. TONE ARM TRACK                           |
| 2. HINGES   | 15. POWER SWITCH                             |
| 3. STYLUS PRESSURE SCALE RING                         | 16. REPEAT SWITCH AND INDICATOR              |
| 4. TONE ARM LIFTER                                    | 17. SPEED SELECTOR AND INDICATORS            |
| 5. TONE ARM   | 18. SIZE SELECTOR AND INDICATORS             |
| 6. CARTRIDGE SHELL                                    | 19. QUARTZ LOCK INDICATOR                    |
| 7. CARTRIDGE RE-SETTING SCREWS                        | 20. PLAY BUTTON                              |
| 8. CARTRIDGE *A CARTRIDGE IS NOT SUPPLIED WITH AP-L45 | 21. REJECT BUTTON                            |
| 9. 45 RPM ADAPTER HOLDER                              | 22. ARM UP BUTTON                            |
| 10. STYLUS GAUGE HOLDER                               | 23. FORWARD/FAST FORWARD (FWD/F. FWD) BUTTON |
| 11. PLATTER   | 24. REVERSE/FAST REVERSE (REV/F. REV) BUTTON |
| 12. SPINDLE   |  |
| 13. RUBBER MAT  |  |

## 2. MODEL AP-L95/C

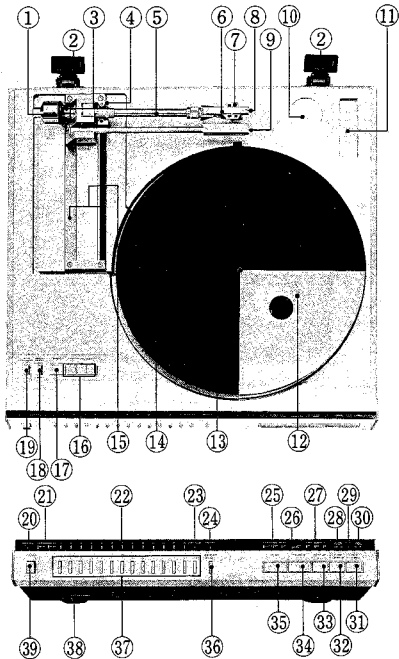

Fig. 2 Controls (Model AP-L95/C)

- |  |   |
|--|---|
| 1. MAIN WEIGHT   | 22. PROGRAM NUMBER INDICATORS   |
| 2. HINGES  | 23. OVERFLOW INDICATOR  |
| 3. STYLUS PRESSURE SCALE RING                          | 24. REPEAT INDICATOR  |
| 4. TONE ARM LIFTER                                     | 25. SPEED INDICATORS  |
| 5. TONE ARM  | 26. QUARTZ LOCK INDICATOR   |
| 6. CARTRIDGE SHELL                                     | 27. SIZE INDICATORS   |
| 7. CARTRIDGE RE-SETTING SCREWS                         | 28. FORWARD/FAST FORWARD (FWD/F. FWD) INDICATOR                                 |
| 8. CARTRIDGE *A. CARTRIDGE IS NOT SUPPLIED WITH AP-L95 | 29. CUE INDICATOR   |
| 9. PHOTO SENSOR  | 30. REVERSE/FAST REVERSE (REV/F. REV) INDICATOR                                 |
| 10. 45 RPM ADAPTER HOLDER                              | 31. REVERSE/FAST REVERSE (REV/F. REV) BUTTON                                    |
| 11. STYLUS GAUGE HOLDER                                | 32. FORWARD/FAST FORWARD (FWD/F. FWD) BUTTON                                    |
| 12. PLATTER  | 33. ARM UP BUTTON   |
| 13. SPINDLE  | 34. REJECT BUTTON   |
| 14. RUBBER MAT   | 35. PLAY BUTTON   |
| 15. TONE ARM TRACK                                     | 36. REPEAT SWITCH   |
| 16. MANUAL SIZE BUTTONS                                | 37. PROGRAM BUTTONS   |
| 17. SPEED BUTTON                                       | 38. SENSOR SENSITIVITY SELECTOR [LOW (LO)/NORMAL (NORM)/MIDDLE (MID)/HIGH (HI)] |
| 18. PROGRAM (PRGM) MODE BUTTON (■ RPSS ■ SKIP)         | 39. POWER SWITCH  |
| 19. ARM RELEASE BUTTON                                 |   |
| 20. MANUAL INDICATOR                                   |   |
| 21. PROGRAM INDICATORS                                 |   |

## IV. PRINCIPAL PARTS LOCATION

### 1. MODEL AP-L45/C

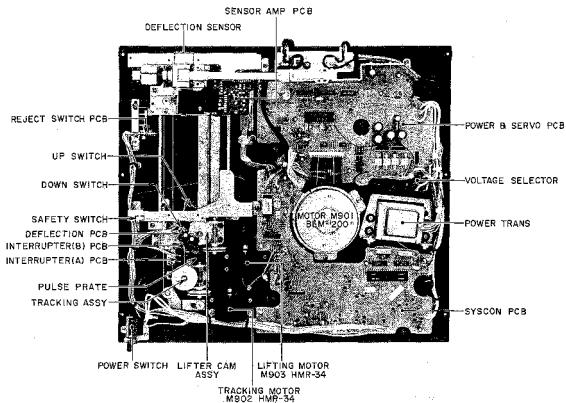

Fig. 3 Top View (Model AP-L45/C)

### 2. MODEL AP-L95/C

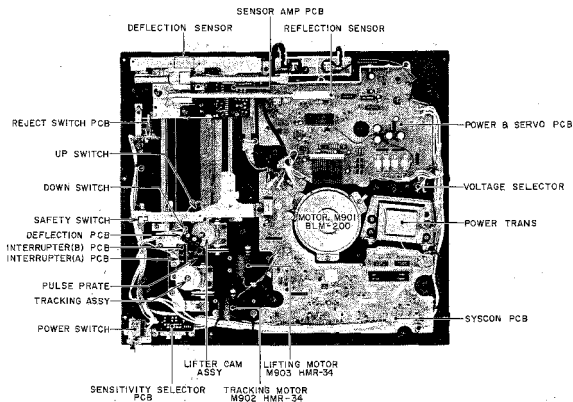

Fig. 4 Top View (Model AP-L95/C)



## V. VOLTAGE CONVERSION

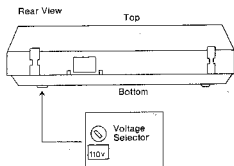

Fig. 5 Voltage Conversion

Models for Canada and USA are not equipped with this facility. Each unit is preset at the factory depending on its destination. Please confirm that the Voltage Selector on the bottom of the equipment is set to the voltage for your area. If not:

1. Disconnect the Power Cord.
2. Turn the Voltage Selector with a screwdriver until the correct voltage for your area appears.

## VI. OPERATION OF VARIOUS PARTS

### 1. FEATURES OF LINEAR TRACKING ARM

- 1) The linear tracking arm means that the locus traced on a record by the stylus point is linear. Since this tracking method has the same movement as that of the cutter head when it cuts a master disk, the tracking error is greatly reduced. (The ordinary offset arm turn table has the tracking error angle of  $\pm 1 - 2^\circ$ , but AP-L45/L95 has only  $\pm 0.2^\circ$ ).  
For this reason, there is less high frequency distortion and less crosstalk.
- 2) Because the inside force is not produced, the cross

modulation distortion is reduced. (In the case of offset arm turn table, the complete elimination is impossible because the friction force between the stylus and record is constantly changing even if adjusted by a canceler).

- 3) The effective arm length can be shortened and it is advantageous in trackability and rigidity. (If the offset arm is shortened, the tracking error will be increased).
- 4) Because of the dynamic lateral balance provided, vibration will not occur so easily around the arm supporting shaft.

### 2. INPUT/OUTPUT AND FUNCTION OF MICROCOMPUTER TERMINALS

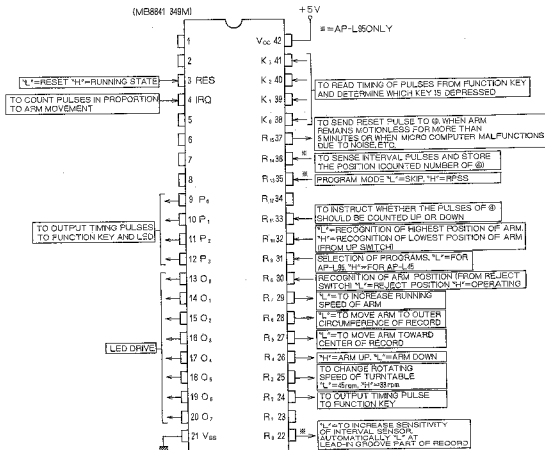

Fig. 6





## 5. RECEPTION OF FUNCTION KEY INPUT AND LED DRIVE

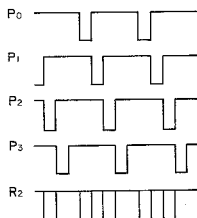

Fig. 9. Timing Pulses from Microcomputers

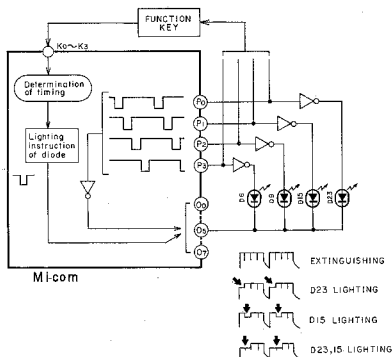

Fig. 10 LED Drive

### 1) Reception of FUNCTION KEY Input

The microcomputers  $P_0$ – $P_3$  output pulses of different timing. These pulses are combined with the pulse coming from the microcomputer  $R_2$  terminal and inputted into the FUNCTION KEY (matrix switch). When the key is depressed, the combined pulses is inputted in any one of the microcomputers  $K_0$ – $K_3$ . The microcomputer reads the pulse timing, recognizes which key was depressed and starts the operation (memory, output, LED drive, etc.) (AP-L95). AP-L45 adopts the same method except that the combined pulses are added to the switch.

### 2) Lighting of LED

The LED is lit up by the dynamic lighting method. The LED is driven by the microcomputers  $O_0$ – $O_7$  and the timing is that of the pulses of the microcomputers  $P_0$ – $P_3$ . A portion of it will be described here (See Fig. 10). The pulses from the microcomputers  $P_0$ – $P_3$  are added to the respective LED anode. To the cathode side, the pulses of  $P_0$ – $P_3$  are combined and added. If the FUNCTION KEY is depressed instructing "light D23", a minus pulse with the same timing as for  $P_0$  is added to the microcomputer  $O_2$  to light D23 only. The above concerns the operation of AP-L95/C, but AP-L45/C operates in the same manner, although the number of LEDs is different.

## 6. HORIZONTAL DRIVE CIRCUIT OF ARM

The signal from the deflection sensor or from the micro-computer drives the DC motor to move the arm.

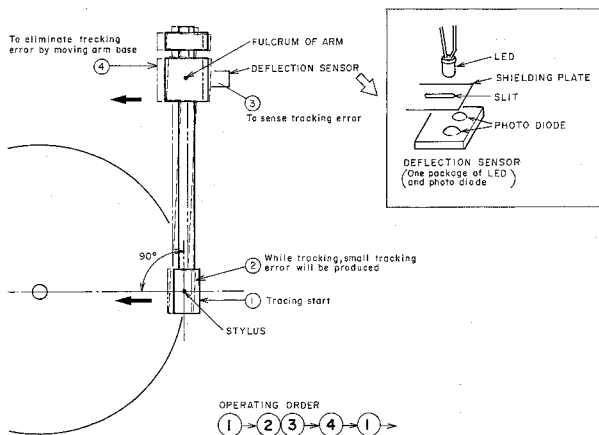

Fig. 11 Arm Movement During Playing

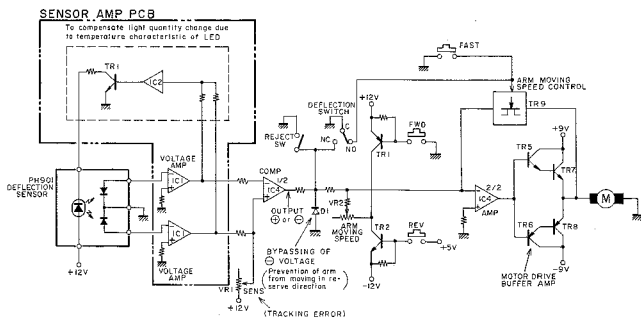

Fig. 12 Horizontal Drive Circuit of Arm

### 1) Operation during Playing

During playing it is ideal that the line between the stylus point and the spindle center crosses the centerline of the arm at right angles, and to achieve it, it is necessary to move the arm base in combination with the movement of the stylus point. AP-L45/L95 uses the following method. The arm movement is detected by the deflection sensor (LED and two photo diodes) and the voltage of the output is amplified by the inversion amplifier (Sensor Amp PCB IC1). The two amplified voltages are compared by the comparator (IC4 1/2) to produce the output  $\oplus$  or  $\ominus$ . The  $\oplus$  output is when the stylus point is shifted toward the center and  $\ominus$  output is when it is shifted toward the outer circumference. The voltage enters the inversion amplifier (IC4 2/2) and the output drives the buffer amplifier to supply current to the motor. Since it is not necessary to move the arm toward the outer circumference during playing, any  $\ominus$  output from IC4 1/2 is cut by D1.

#### ○ Additional circuit

IC2, TR1 of the Sensor Amp PCB is a circuit to control the current to be supplied to the LED of the deflection sensor and to compensate the change in the quantity of light caused by the temperature characteristic of the LED. It controls so that the sum of the two photo diode outputs is always constant.

**REJECT Switch:** To cut the sensor output at the REJECT position.

**DEFLECTION Switch:** Switch interlocked with the arm's up/down movement. When the stylus point is positioned above the record, NC and C are connected, and when it is lowered to the same height as the record, NO and C are connected.

NC-C= Sensor output is cut.

NO-C= Gain of motor drive amp is increased.

### 2) Arm Movement When Arm is in Up Position

When FWD or REV signal comes from the micro-computer,  $\oplus$  or  $\ominus$  voltage is added to the inversion amplifier (IC4 2/2) through TR1 or TR2, and the output drives the motor. If  $\oplus$  voltage (FWD signal) is inputted in the IC4 2/2, the output becomes  $\ominus$  because it is an inversion amplifier, and the motor is driven by the  $\ominus$  voltage through TR6 and 8. TR9 feeds the  $\ominus$  voltage to the IC4 2/2 to control the gain of the drive amplifier. (NFB).

In the absence of the FAST signal, the impedance of TR9 is low, the feedback amount is large, and the motor rotates at low speed.

When the fast signal comes, the impedance of TR9 becomes high and the motor rotates at high speed. Here the two kinds of moving speed of the arm (FAST/SLOW) are changed.



## 8. TUNE INTERVAL DETECTION CIRCUIT (AP-L95)

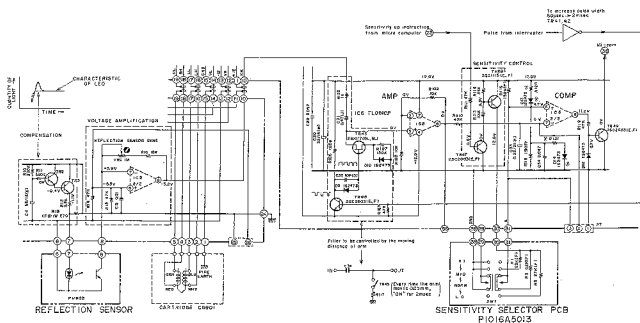

Fig. 14 Reflection Sensor

AP-L95 has a sub-arm which detects the record size and the tune interval and carries out RPSS, SKIP or record size selection.

AP-L95 features the possibility of detecting the tune interval even if the moving speed of the arm is not constant, i.e., it can detect the tune interval whether the arm is moved slowly or fast, or the record is being played.

This makes possible the direct access from tune to tune. This operation can be done by providing a filter to be controlled by the moving distance of the arm between the output of the reflection sensor and the amplifier. The pulses from the interrupter are shaped in TR41 and 42 to switch TR46 and 45 to achieve the ON/OFF of the differentiation circuit consisting of C31 and R107. The interrupter produces one pulse each time the arm moves 0.05mm.

The output from the filter is amplified by IC6 and enters the comparator IC5 2/2. The sensitivity is adjusted by changing the reference voltage of the comparator. TR47 and 48 increase the sensitivity at the lead-in part of the record in accordance with the instructions from the microcomputer. The output of the comparator (IC5 2/2) is passed through TR49 and inputted in the microcomputer as the tune interval pulse.



## 9. MOTOR CONTROL CIRCUIT

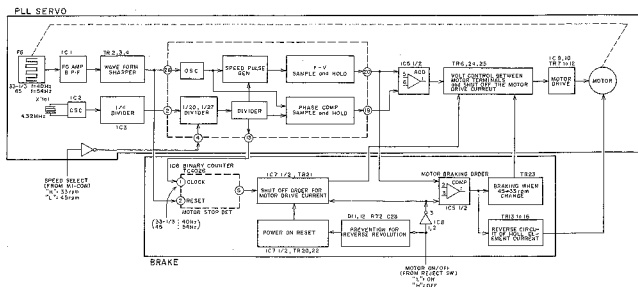

Fig. 15 Motor Control Circuit

### 1) Motor Drive Circuit

A DC brush-less motor is used, and to obtain the rotation torque, the current to be supplied to the stator coils of 3 systems is switched by a hall device arranged at the phase difference of  $2/3\pi$  with 80 pole rotor magnet.

The current to the stator coils is supplied through an operational amplifier and a push-pull amplifier and the operational amplifier is switched by the hall device. The principle is same for the motor of GX-F90.

### 2) PLL SERVO Circuit

This circuit is our PLL IC AP-400 which has been used for the turn table for some time. The sin wave generated by the motor FG is amplified by IC1 and shaped into the square wave (50% duty).

On the other hand, the pulse (Frequency 4.32 MHz) from X'tal OSC is divided into 1/4.

These two pulses entering AP-400 are F-V converted into voltage  $V_f$  by the sample & hold circuit and into voltage  $V_p$  by the phase comparison sample & hold circuit.  $V_f$  and  $V_p$  are combined by the operational amplifier to control the base current of TR25 through TR6. TR25 control the interterminal voltage of the motor to control the rotation of the motor. In AP-Q50 and AP-Q60, the current to the hall device was controlled, but in this AP-L45/L95, TR25 controls the interterminal voltage of the motor while a constant current is supplied to the hall device.

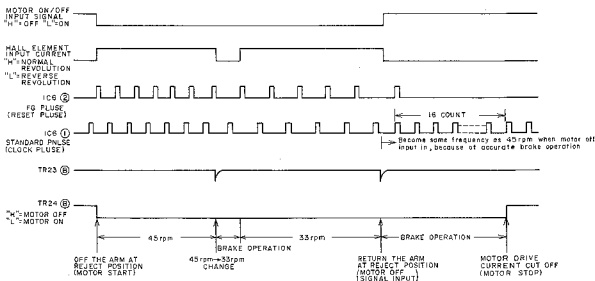

Fig. 16 Brake Circuit Timing Chart

### 3) Brake Circuit (AP-L95)

This circuit works to stop the rotation of the platter swiftly when the arm returns to the reject position, and also works to reduce the speed of the rotation swiftly when the number of rotation is changed from 45 rpm to 33 rpm while the platter is rotating. The braking method is to invert the direction of the current supplied to the hall device of the motor to generate the reverse rotation torque.

#### a. Stop in Steady Rotation

During the steady rotation, ① of the comparator IC5 has about +12V and is supplying the current to the hall device through TR14 and 15. If the arm returns to the reject position and ③ of IC8 becomes "L", ① of IC5 will have the voltage of about -9V. The hall device is supplied the current in the reverse direction as to the current during the steady rotation by TR16 and 13 and the reverse rotation torque is generated in the motor to brake the rotation. But if it is left as it is, the motor will start the reverse rotation, and therefore, it is necessary to cut off the current running to the stator coils by detecting the stop of the motor, and this is done by IC6, 7 and TR21. IC6 is a binary counter which counts the pulses coming from pin ① (clock). Pin ⑤ is the output of fifth figure, and each time 16 pulses from the clock are counted, the output of "H" is produced. The pulses from the X'tal OSC are always added to the pin ① (clock), but it is always reset by the pulses from FG during steady rotation, and therefore, no 16 count is available, and no output of "H" from ⑤. If the motor is sufficiently braked, the interval of the reset pulses from FG is widened, and the counter counts 16 before the reset pulse is added, ⑤ will produce the output of "H". This is the signal to indicate that the rotational speed of the motor is sufficiently reduced.

If ⑤ of IC6 becomes "H", the flip-flop IC7 is set, and Q becomes "L". TR21 is turned ON and TR25 is turned OFF through TR24 to break the motor driving current.

#### b. Speed Change from 45 rpm to 33 rpm

If the speed is changed from 45 rpm to 33 rpm when the platter is rotating, the voltage  $V_f$  of ② of AP-400A becomes high to reduce the motor current. (usual servo operation). Because  $V_f$  is also added to IC5 ②, the output ① becomes minus and the current to the hall device is inverted as in the case of the stop in steady rotation. At the same time, TR23 is turned on for the charging time of C24, increases the reduced motor current, and momentarily brakes. When the rotation of the motor becomes 33 rpm,  $V_f$  is reduced, IC5 ① returns to positive voltage, and the motor starts the steady rotation.

## VII. ORDINARY ADJUSTMENT

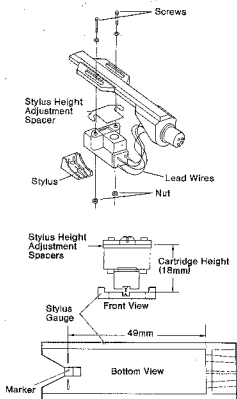
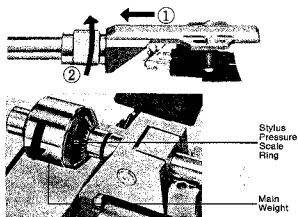

Fig. 17

### 1. ATTACHING A CARTRIDGE

Cartridge is not included with the AP-L45/L95 turntable. Read the operator's manual carefully before attempting installation. Cartridge Shell lead designations are as follows:

- BLUE: Left Ground (Earth) (-)
- WHITE: Left Output (+)
- GREEN: Right Ground (Earth) (-)
- RED: Right Output (+)

Attach the cartridge lightly to the Cartridge Shell. Adjust the height of the stylus with the Stylus Height Adjustment Spacers. Place the Cartridge Shell into the Stylus Gauge. Attach the Cartridge securely to the Cartridge Shell so that the Stylus is positioned as shown in the illustrations.

- Place the spacers to adjust the height.
- The Stylus should be over the 49 mm marker.

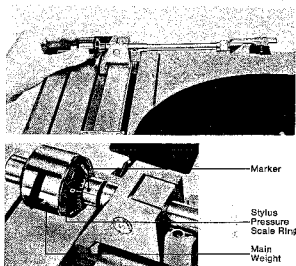

Fig. 18

### 2. STYLUS PRESSURE ADJUSTMENT

#### 1) MODEL AP-L45/C

1. Remove the Stylus Guard being careful not to damage the Stylus.
2. Adjust the Main Weight until the Tone Arm is slightly above the Tone Arm Lifter and balanced.
3. Without moving the Main Weight, rotate the Stylus Pressure Scale Ring only, to match the "0" mark with the mark on the weight shaft.
4. Rotate the Main Weight towards you, as viewed from the front operating panel (the Stylus Pressure Scale Ring will move with it), until the desired Stylus Pressure Scale indication is at the mark on the shaft. The range of adjustment is from 0 to 3 grams.

\* For AP-L45C only: the recommended stylus pressure for the cartridge supplied, PC95, is 2 grams.

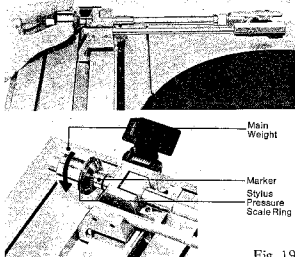

Fig. 19

## 2) MODEL AP-L95/C

1. Depress the POWER Switch to turn on the power.
2. Remove the Stylus Guard being careful not to damage the Stylus.
3. Depress the ARM RELEASE button.  
The Tone Arm will descend.
4. Adjust the Main Weight until the Tone Arm is in perfect horizontal balance.
5. Without moving the Main Weight, rotate the Stylus Pressure Scale Ring only to match the "0" mark with the mark on the weight shaft.
6. Rotate the Main Weight towards you, as viewed from the front operating panel (the Stylus Pressure Scale Ring will move with it), until the desired Stylus Pressure Scale indication is at the mark on the shaft. The range of adjustment is from 0 to 3 grams.  
\* For AP-L95C only: The recommended stylus pressure for the cartridge supplied, PC-95, is 2 grams.
7. Depress the ARM RELEASE button again, the Tone Arm will rise.

## VIII. ADJUSTMENT

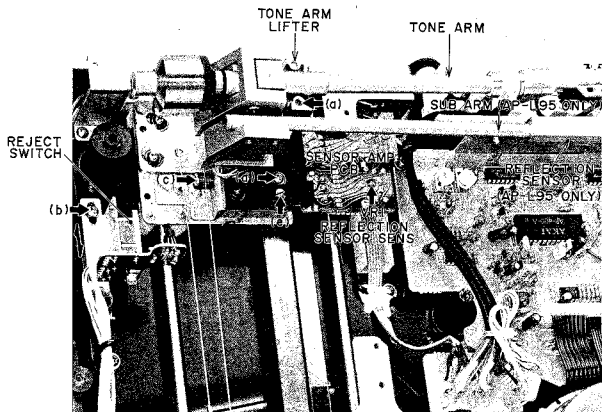

Fig. 20

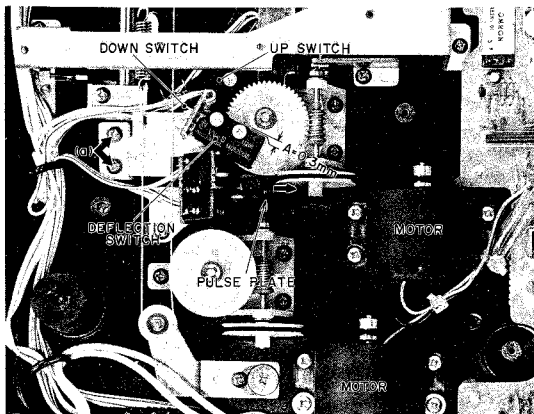

Fig. 21

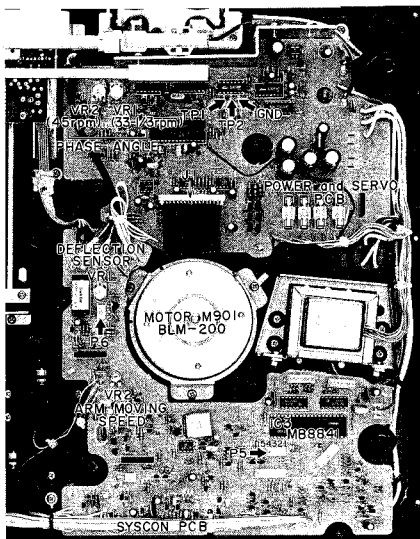

Fig. 22

#### 1. TONE ARM LIFTER HEIGHT ADJUSTMENT (Refer to Fig. 20)

- 1) Check that the cartridge is mounted in the shell at the proper height.
- 2) Set the platter and rubber mat in place, and push the power switch on.
- 3) Push the manual size selector 17 or 25, and advance the arm inwards by means of the FWD switch. (If the arm is advanced by the PLAY switch, the arm will lower to damage the stylus point).
- 4) When the arm stops, push the power switch off.
- 5) Remove the screw (a) from the tone arm.
- 6) Turn the single-groove screw located under the screw (a) until the distance from the rubber mat surface to the stylus point is 8 mm.
- 7) Tighten the screw (a) again.

#### 2. REJECT SWITCH INSTALLATION POSITION ADJUSTMENT (LEAD-IN, LEAD-OUT POSITION ADJUSTMENT)

(Refer to Figs. 20, 23, 24)

- 1) Place a 30 cm record on, and push the power switch on.
- 2) Push the PLAY button to lead the stylus in.
- 3) See that the stylus lowers into the lead-in groove (radius 146.5 to 149 mm) at this time.
- 4) If the stylus lowers at a point too far out or in, loosen the screw (b) (Fig. 20), and adjust by changing the position of the REJECT switch. (The stylus' lowering position will change inward if the switch is moved to the front, or outward if the switch is moved to the rear).
- 5) After retightening the screw (b), check by using several 30 cm, 25 cm and 17 cm records that the stylus will not lower into the sound groove or out of the record.
- 6) After this confirmation of stylus operation, lock the screw (b) by painting.

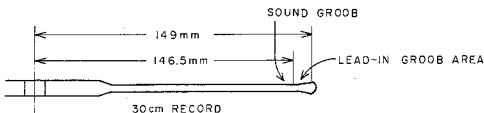

Fig. 23

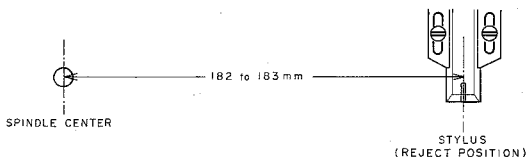
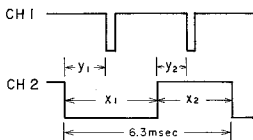

Fig. 24 Reference Value



$$a = \frac{Y_1}{X_1} \times 100 = 50\% \pm 25\%$$

$$b = \frac{Y_2}{X_2} \times 100 = 50\% \pm 25\%$$

Fig. 25

### 3. ARM MOVING SPEED ADJUSTMENT (Refer to Figs. 22, 25)

- 1) Push the power switch off.
- 2) Remove the rubber mat and platter.
- 3) Short Pin (3) and Pin (5) of Syscon P.C Board P5.
- 4) Connect Pin (5) of P5 to GND of oscilloscope CH1, and Pin (4) of the same to CH1 (+). Also connect Pin (2) to CH2 (+). (Use a probe).

CAUTION: Exercise good care in connecting the pins because their spacing is very small.

- 5) When the power switch is pushed on, the arm starts moving back and forth, and waveforms appear on CH1 and CH2 of the oscilloscope. (Fig. 25)
- 6) Adjust VR2 on Syscon P.C Board until the period of the waveform on CH2 is 6.3 msec. (If the periods of the arm movements forward and back are different, adjust the shorter period to 6.3 msec).

7) Check that the phase difference a, b between the waveforms on CH1 and CH2 (Fig. 25) is  $50\% \pm 25\%$ .

8) Push the power switch off, and disconnect the pins mentioned in Steps 3) and 4).

#### 4. DEFLECTION SENSOR POSITION

##### ADJUSTMENT (Refer to Figs. 20, 22)

- 1) Check the arm that it is in the REJECT position.
  - 2) Lightly tap the arm lifter with your finger so that the arm will seat well on the arm lifter.
  - 3) Push the power switch off.
  - 4) Short Pin ① and Pin ③ of Syscon P.C Board P6.
  - 5) Connect Pin ① of P6 to the digital voltmeter's (-) and Pin ② to its (+).
  - 6) Push the power switch on.
  - 7) Adjust the screw (c) (Fig. 20) until the digital voltmeter reads  $-0.25 \pm 0.55V$  DC.
  - 8) After the adjustment, lock the screw (c) by painting, and applying a bond.
  - 9) Push the power switch off.
  - 10) Disconnect the pins mentioned in Steps 4) and 5).
- CAUTION: Exercise good care in connecting the pins because their spacing is very small.

#### 5. DEFLECTION SENSOR ELECTRICAL

##### ADJUSTMENT (Refer to Figs. 21, 22)

- 1) Check the arm that it is in the REJECT position.
- 2) Check that the stylus pressure has already been adjusted.
- 3) Remove the rubber mat and platter.
- 4) Turn Syscon P.C Board VR1 (Fig. 22) counterclockwise all the way.
- 5) Set the manual size selector to the position 30, and push the PLAY button. (The arm goes down to the 30 cm lead-in position).
- 6) The arm starts moving as VR1 is slowly turned clockwise.

CAUTION: The arm will be rejected if the arm moving speed gets too fast. If this occurs, repeat from Step 4).

- 7) Slowly turn VR1 counterclockwise until the arm stands still.
- 8) Check that, when the arm is raised or lowered at that position, the pulse plate will not move (the arm will not move horizontally).
- 9) If the pulse plate moves, turn VR1 slightly counterclockwise, and repeat Step 8).
- 10) Push the REJECT button, and disconnect the wire from the main motor Power & Servo P.C Board J1.
- 11) Place the platter and rubber mat back on.
- 12) Set the manual size selector to 17, and push the PLAY button. (Lower the stylus onto a still rubber mat).
- 13) Turn the pulse plate clockwise (in the arrow direction shown in Fig. 21) by about 5 mm with your finger, and check that the pulse plate returns to its original position. If the pulse plate does not return, repeat from Step 4).
- 14) Reconnect the motor (J1).

#### 6. REFLECTION SENSOR SENSITIVITY

##### (AP-L95/C) (Refer to Figs. 20, 26)

- 1) Push the power switch off.
  - 2) Disconnect the motor (Power & Servo P.C Board J1).
  - 3) Connect Pin ① of Syscon P.C Board P6 to the digital voltmeter's (-) and Pin ④ to its (+).
  - 4) Place the platter and rubber mat on.
  - 5) Clean a record which has a wide lead-out groove pitch and set it in place.
- CAUTION: 1. Use neither a sono-sheet nor a color record.
2. Use a record which is free from defects, dirt and dust.
- 6) Push the power switch on.
  - 7) Advance the reflection sensor (with tone arm block) over the lead-out groove area by means of the F. FWD button. (Fig. 26)

CAUTION: Turn the record by hand so that the groove will not be directly under the reflection sensor. (Fig. 26)

- 8) Adjust VR1 (Fig. 20 Sensor Amp P.C Board) so that the digital voltmeter reads  $-1.0 \pm 0.2V$  DC at this time.

CAUTION: If the sensor is over the lead-out groove area, VR1 cannot be adjusted because it is under the platter. In that case, it is necessary to temporarily move the arm to a point where VR1 can be turned. (REV or REJECT).

- 9) Repeat Steps 7) and 8) a few times, and check again with other record.

#### 7. REFLECTION SENSOR POSITION ADJUSTMENT (AP-L95/C) (Refer to Fig. 20)

- 1) Set a record, having as narrow intervals as possible, in place.

CAUTION: Use neither a sono-sheet nor a color record.

- 2) Using a stylus gauge (a standard accessory), check that the stylus is in the proper position.
  - 3) Program a suitable tune. (RPSS)
  - 4) Push the PLAY button, and check that the stylus properly goes down at the center of the desired interval.
  - 5) If the stylus fails to go down in the interval center, loosen the screw (d) (Fig. 20), and adjust by turning CAM (e).
  - 6) Repeat Steps 3), 4) and 5) a few times.
  - 7) Retighten the screw (d).
  - 8) Confirm as mentioned in Steps 3) and 4).
- If good, lock the screw (d) and CAM (e) by painting.



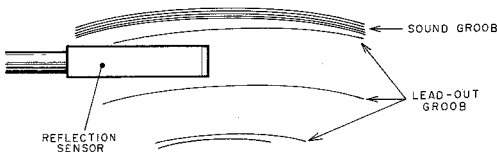
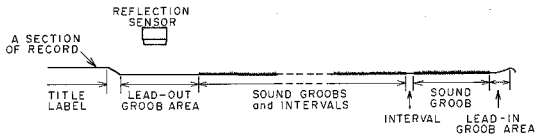

Fig. 26

## 8. DEFLECTION SWITCH POSITION

### ADJUSTMENT (Refer to Fig. 21)

- 1) Push the ARM RELEASE button to lower the arm.  
(AP-L45/C: Remove the platter and rubber mat, and lower the arm at the 30 cm or 17 cm position).
- 2) The clearance A (Fig. 21) should be about 0.3 mm at this time.
- 3) It can be adjusted by loosening the screws (a) in Fig. 21.

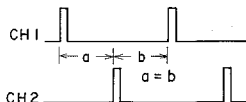

Fig. 27

## 9. QUARTZ LOCK PHASE ANGLE

### ADJUSTMENT (Refer to Figs. 22, 27)

- 1) Connect TP1 and GND shown in Fig. 22 (Power & Servo P.C Board) to the oscilloscope's CH1 (+) and GND, and TP2 to CH2 (+). (Use a probe).
- 2) Place the platter and rubber mat on.  
**CAUTION:** Be careful not to let the probe and platter contact with each other.
- 3) Set the speed to 33, and the size to 30. Advance the arm and turn the platter by operating the FWD button. Do not lower the arm.
- 4) Turn VR1 (Fig. 22 Power & Servo P.C Board) until the phase relationship between CH1 and CH2 is as shown in Fig. 27.
- 5) Change the speed to 45.
- 6) Turn VR2 (Fig. 22 Power & Servo P.C Board) until the phase relationship between CH1 and CH2 is as shown in Fig. 27.
- 7) Push the power switch off, and disconnect those mentioned in Step 1).

## IX. CLASSIFICATION OF VARIOUS P.C BOARDS

---

### 1. P.C BOARD TITLES AND IDENTIFICATION NUMBERS

#### 1) MODEL AP-L45/C

P.C BOARD TITLE	P.C BOARD NUMBER
Syscon P.C Board	P1015A5010
Power & Servo P.C Board	P1015A5011
Sensor Amp P.C Board	P1015A5012
Interrupter (A) P.C Board	P1015A5014
Interrupter (B) P.C Board	P1015A5015
Reject Switch P.C Board	P1015A5016
Up Switch P.C Board	P1015A5017
Down Switch P.C Board	P1015A5018
Deflection P.C Board	P1015A5019
Main Panel P.C Board	P1015A5040
Size Switch P.C Board	P1015A5041

#### 2) MODEL AP-L95/C

P.C BOARD TITLE	P.C BOARD NUMBER
Syscon P.C Board	P1016A5010
Power & Servo P.C Board	P1016A5011
Sensor Amp P.C Board	P1016A5012
Sensitivity Selector P.C Board	P1016A5013
Interrupter (A) P.C Board	P1016A5014
Interrupter (B) P.C Board	P1016A5015
Reject Switch P.C Board	P1016A5016
Up Switch P.C Board	P1016A5017
Down Switch P.C Board	P1016A5018
Deflection P.C Board	P1016A5019
Main Panel L95 P.C Board	P1016A5030
By-Pass P.C Board	P1016A5031
Cabinet P.C Board	P1016A5032
Release SW P.C Board	P1016A5033

## 2. MODEL AP-L45/C COMPOSITION OF VARIOUS P.C BOARDS

- 1) Syscon P.C Board P1015A5010 (2ED), Sensor Amp P.C Board P1015A5012, Interrupter (A) P.C Board P1015A5014, Interrupter (B) P.C Board P1015A5015, Reject Switch P.C Board P1015A5017, Down Switch P.C Board P1015A5018, Up Switch P.C Board P1015A5019, Deflection P.C Board P1015A 5040

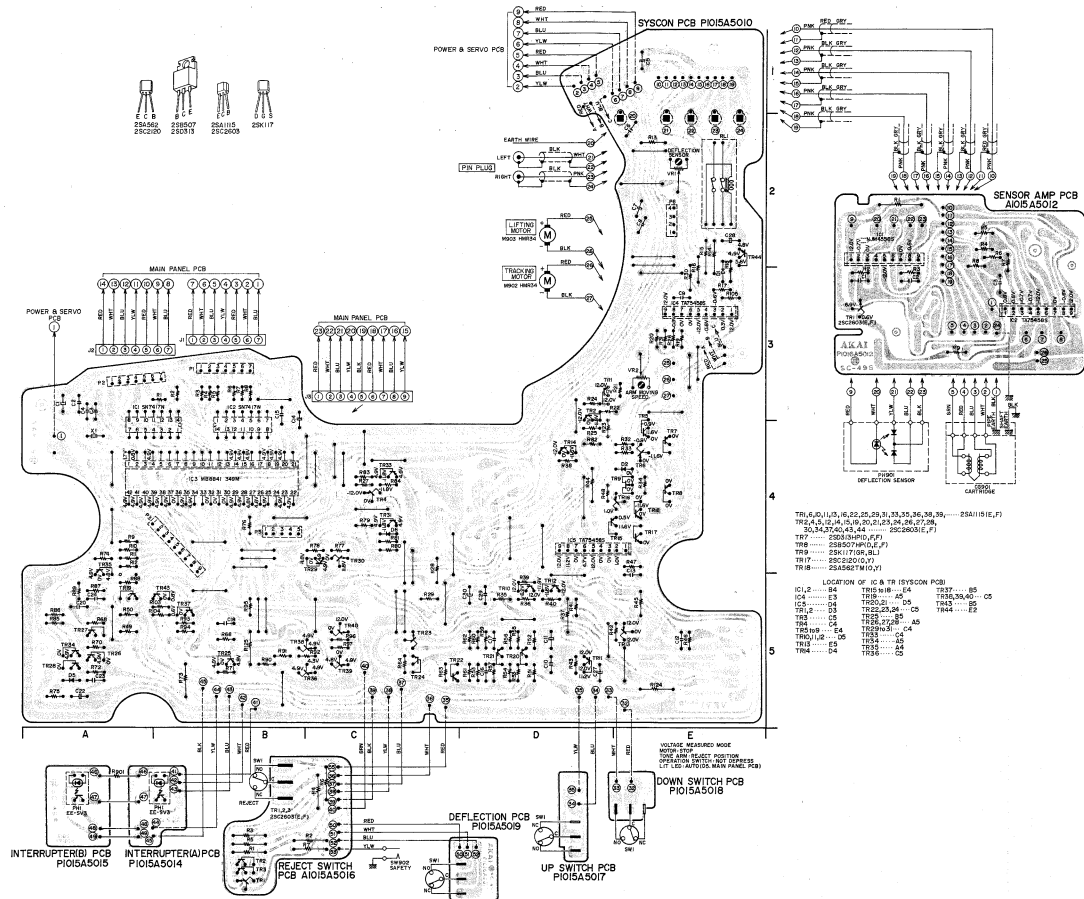







2) Power & Servo P.C Board P1016A5011 (2ED)

LOCATION OF IC & TR

IC1	TR1
IC2	TR2
IC3	TR3
IC4	TR4
IC5	TR5
IC6	TR6
IC7	TR7
IC8	TR8
IC9	TR9
IC10	TR10
IC11	TR11
IC12	TR12
IC13	TR13
IC14	TR14
IC15	TR15
IC16	TR16
IC17	TR17
IC18	TR18
IC19	TR19
IC20	TR20
IC21	TR21
IC22	TR22
IC23	TR23
IC24	TR24
IC25	TR25

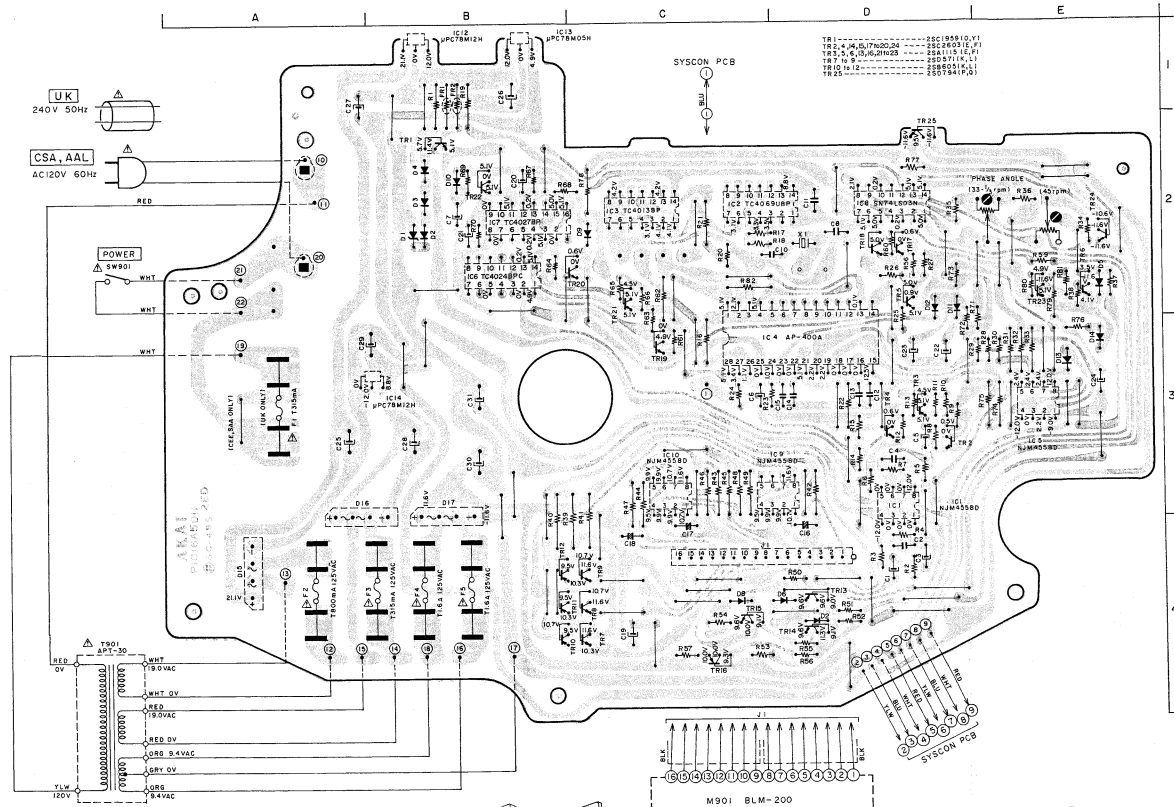

TR1	IC15	2SC1851Q.V1
TR2	IC16	7820.20
TR3	IC17	2SC1851Q.V1
TR4	IC18	2SC1851Q.V1
TR5	IC19	2SC1851Q.V1
TR6	IC20	2SC1851Q.V1
TR7	IC21	2SC1851Q.V1
TR8	IC22	2SC1851Q.V1
TR9	IC23	2SC1851Q.V1
TR10	IC24	2SC1851Q.V1
TR11	IC25	2SC1851Q.V1

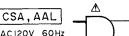
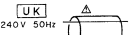

AKAI  
SERVO MOTOR

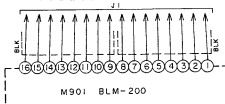
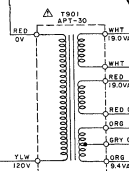

VOLTS MEASURED AT STOP MODE.

WARNING: INDICATES SAFETY CRITICAL COMPONENTS FOR CONTINUED SAFETY. REPLACE SAFETY CRITICAL COMPONENTS ONLY WITH MANUFACTURER'S RECOMMENDED PARTS.  
 AVERTISSEMENT: IL EST INDIQUE LES COMPOSANTS CRITIQUES DE SÛRETÉ POUR MAINTENIR LE NIVEAU DE SÛRETÉ DE L'APPAREIL. SEULS LES COMPOSANTS RECOMMANDÉS PAR LE FABRICANT SONT À UTILISER POUR LA SÛRETÉ DE L'APPAREIL.

- IC1 2SC2603
- IC2 2SC1959
- IC3 2SC2571
- IC4 25D794
- IC5 UPC78M05H
- IC6 UPC78M12H

3) Main Panel L95 P.C Board P1016A 5030 (2ED), By-Pass P.C Board P1016A5031, Cabinet P.C Board P1016A5032 and Release SW P.C Board P1016A5033 (2ED)

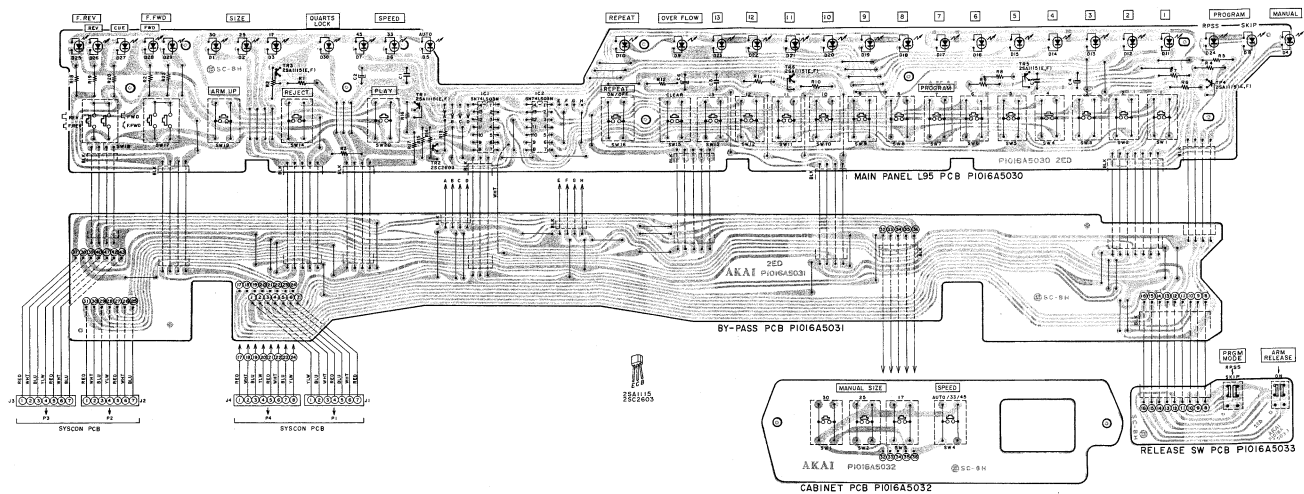



SECTION 2

**PARTS LIST**

TABLE OF CONTENTS

I. MODEL AP-L45/C	41
1. RECOMMENDED SPARE PARTS	41
2. SYS. CON. P.C BOARD BLOCK	42
3. MAIN PANEL L45 P.C BOARD BLOCK	42
4. ASSEMBLY BLOCK (1)	43
5. ASSEMBLY BLOCK (2)	45
6. FINAL ASSEMBLY BLOCK	46
II. MODEL AP-L95/C	47
1. RECOMMENDED SPARE PARTS	47
2. SYS. CON. P.C BOARD BLOCK	47
3. MAIN PANEL L95 P.C BOARD BLOCK	48
4. ASSEMBLY BLOCK (1)	49
5. ASSEMBLY BLOCK (2)	51
6. FINAL ASSEMBLY BLOCK	52
INDEX	53

Resistor and Capacitor which is not listed in this parts list, please refer to COMMON LIST FOR SERVICE PARTS.

## HOW TO USE THIS PARTS LIST

1. This parts list is compiled by various individual blocks based on assembly process.
2. When ordering parts, please describe parts number, serial number, and model number in detail.
3. How to read list.

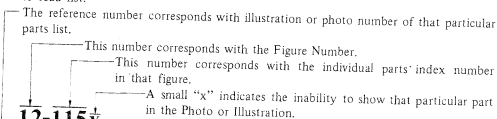

Ref. No.	Parts No.	Description
<b>FLYWHEEL BLOCK #13</b>		
12-115x	800425	Flywheel Block Assy. Comp.
12-116	244506	Flywheel Only
12-117x	244754	Felt, Flywheel
12-118	251324	Main Metal Case
12-119	253080	Main Metal

4. The symbol numbers shown on the P.C. Board list can be matched with the Composite Views of components of the Schematic Diagram or Service Manual.
5. The indications of Resistors and Capacitors in the photos of P.C. Board are being eliminated.
6. The shape of the parts and parts name, etc. can be confirmed by comparing them with the parts shown on the Electrical Parts Table of P.C. Board.
7. Both the kind of part and installation position can be determined by the Parts Number. To determine where a parts number is listed, utilize Parts Index at end of Parts List.  
It is necessary first of all to find the Parts Number. This can be accomplished by using the Reference Number listed at right of parts number in the Parts Index. (meaning of ref. no. outlined in Item 3 above).
8. Utilize separate "Price List for Parts" to determine unit price. The most simple method of finding parts Price is to utilize the reference number.

### CAUTION:

1. When placing an order for parts, be sure to list the parts no., model no., and description. There are instances in which if any of this information is omitted, parts cannot be shipped or the wrong parts will be delivered.
2. Please be careful not to make a mistake in the parts no. If the parts no. is in error, a part different from the one ordered may be delivered.
3. Because parts number and parts unit supply in the Preliminary Service Manual (Basic Parts List) may be partially changed, please use this parts list for all future reference.

**WARNING:**  $\Delta$  INDICATES SAFETY CRITICAL COMPONENTS. FOR CONTINUED SAFETY, REPLACE SAFETY CRITICAL COMPONENTS ONLY WITH MANUFACTURER'S RECOMMENDED PARTS.

**AVERTISSEMENT:**  $\Delta$  IL INDIQU LES COMPOSANTS CRITIQUES DE SURETE. POUR MAINTENIR LE DEGRE DE SECURITE DE L'APPAREIL NE REMPLACER LES COMPOSANTS DONT LE FONCTIONNEMENT EST CRITIQUE POUR LA SECURITE QUE PAR DES PIECES RECOMMANDEES PAR LE FABRICANT.

# I. MODEL AP-L45/C

## 1. RECOMMENDED SPARE PARTS

Because, if the parts listed below are on hand, almost any repair can be accomplished, we suggest that you stock these Recommended Spare Parts Items.

REF. NO.	PARTS NO.	DESCRIPTION
1-1	BMM3102A010A	MOTOR BLM-200
1-2	BM328792	MOTOR HMR3401-01-020
1-3	BT328783	△ TRANS POWER APT95-10 (J)
1-4	BT328784	△ TRANS POWER APT95-30 (C,A)
1-5	BT328785	△ TRANS POWER APT95-40 (E,B,S)
1-6	BT328782	△ TRANS POWER APT95-70 (U)
1-7	ED308952	D GERMA V 1K34A-LR F07
1-8	ED322772	D LED SLP-155D-01 RED
1-9	ED322773	D LED SLP-255D-01 GRN
1-10	ED560913	D SILICON V 1S2473VE
1-11	ED322238	D SILICON 1B4B41 100/1.0A
1-12	ED313284	D ZENER H WZ-036
1-13	EF695766	△ FUSE SEMKO T 250V 0.31A (F1) (B)
1-14	EF695766	△ FUSE SEMKO T 250V 0.31A (F3) (E,B,S)
1-15	EF258344	△ FUSE SEMKO T 250V 0.80A (F2) (E,B,S)
1-16	EF601964	△ FUSE SEMKO T 250V 1.60A (F4,S) (E,B,S)
1-17	EF306125	△ FUSE TSC A 250V 0.31A (F3) (U,J)
1-18	EF309388	△ FUSE TSC A 250V 0.80A (F2) (U,J)
1-19	EF311839	△ FUSE TSC A 250V 1.6A (F4,S) (U,J)
1-20	EF309391	△ FUSE TSC 125V 0.08A (F2) (C,A)
1-21	EF306088	△ FUSE TSC 125V 0.31A (F3) (C,A)
1-22	EF308847	△ FUSE TSC 125V 1.60A (F4,S) (C,A)
1-23	E1325557	IC AP-400-A (TM4504P)
1-24	E1328812	IC MB8841 349M
1-25	E1213390	IC NJM4558D
1-26	E1201940	IC NJM4558S
1-27	E1310043	IC SN74LS03N
1-28	E1328790	IC SN74LS109AN
1-29	E1328789	IC SN74LS12N
1-30	E1331660	IC SN7417N
1-31	E1322599	IC TA75458S
1-32	E1306727	IC TC4013BP
1-33	E1306726	IC TC4069UBP
1-34	E1328798	IC μPC78M05H
1-35	E1328796	IC μPC78M12H
1-36	E1328799	OSC X'TAL 4.32 MHz
1-37	E1323231	OSC X'TAL 4MHz
1-38	FP322437	RELAY LEAD LAB2NS 2NO 5V
1-39	ER318248	△ R FUSE ERD2FC 1/4W 47R0G
1-40	ES328788	△ SW PUSH ESB-90144T 01-1 UC (C,A)
1-41	ES328787	△ SW PUSH ESB-90149R 01-1 J (J)
1-42	ES328786	△ SW PUSH ESB-90159S 01-1 B (U,E,B,S)
1-43	ES309920	SW LEAF BSW-130 01-1 NO
1-44	ES308929	SW MICRO VV-S
1-45	ES328780	SW PUSH SPK-02 2-02-02N
1-46	ES305733	SW SELECTOR HWX0131-260 01-4
1-47	ES328777	SW TACT EVQ-PYR12K
1-48	ES328778	SW TACT KHFI0901
1-49	ET328889	PHOTO SENSOR EE-SV3-B
1-50	ET200558	TR 2SA1115 E,F
1-51	ET328861	TR 2SA562TM O,Y
1-52	ET323348	TR 2SB507HP D,E,F
1-53	ET666415	TR 2SB605 K,L
1-54	ET330162	TR 2SC1959 O,Y
1-55	ET328844	TR 2SC2120 O,Y
1-56	ET200505	TR 2SC2603 E,F
1-57	ET323366	TR 2SD313HP D,E,F
1-58	ET666404	TR 2SD571 K,L

REF. NO.	PARTS NO.	DESCRIPTION
1-59	ET307349	TR 2SD794 P,Q
1-60	ET321016	TR 2SK117 GR,BL
1-61	EV317580	R S-FIX H TM8KV2-1S 3P 0.50W 202
1-62	EV520806	R S-FIX H V8K4-1 3P 103
1-63	MB329540	BELT
1-64	TP328793	TONE ARM W/SHELL
1-65	TP329217	TONE ARM W/SHELL (BL)

## 2. SYS. CON. P.C BOARD BLOCK

REF. NO.	PARTS NO.	DESCRIPTION
2-1	BA1P015A006A	PC SYSCON BLK AP-L45(U)
2-2	BA1P015A006B	PC SYSCON BLK AP-L45(J)
2-3	BA1P015A006C	PC SYSCON BLK AP-L45(C)(C,A)
2-4	BA1P015A006D	PC SYSCON BLK AP-L45(E)(E,S)
2-5	BA1P015A006E	PC SYSCON BLK AP-L45(B)
<b>PC SYSCON BLOCK</b>		
2-1C1,2	E1311660	IC SN7417N
2-1C3	E1328812	IC MB8841 349M
2-1C4,5	E1322599	IC TA75458S
2-TR1	ET200558	TR 2SA1115 E,F
2-TR2	ET200505	TR 2SC2603 E,F
2-TR4,5	ET200505	TR 2SC2603 E,F
2-TR6	ET200558	TR 2SA1115 E,F
2-TR7	ET323366	TR 2SD313HP D,E,F
2-TR8	ET323348	TR 2SB507HP D,E,F
2-TR9	ET321016	TR 2SK117 GR, BL
2-TR10,11	ET200558	TR 2SA1115 E,F
2-TR12	ET200505	TR 2SC2603 E,F
2-TR13	ET200558	TR 2SA1115 E,F
2-TR14,15	ET200505	TR 2SC2603 E,F
2-TR16	ET200558	TR 2SA1115 E,F
2-TR17	ET328844	TR 2SC120 O,Y
2-TR18	ET328861	TR 2SA562TM O,Y
2-TR19to21	ET200505	TR 2SC2603 E,F
2-TR22	ET200558	TR 2SA1115 E,F
2-TR23,24	ET200505	TR 2SC2603 E,F
2-TR25	ET200558	TR 2SA1115 E,F
2-TR26to28	ET200505	TR 2SC2603 E,F
2-TR29	ET200558	TR 2SA1115 E,F
2-TR30	ET200505	TR 2SC2603 E,F
2-TR31	ET200558	TR 2SA1115 E,F
2-TR33	ET200558	TR 2SA1115 E,F
2-TR34	ET200505	TR 2SC2603 E,F
2-TR35,36	ET200558	TR 2SA1115 E,F
2-TR37	ET200505	TR 2SC2603 E,F
2-TR38,39	ET200558	TR 2SA1115 E,F
2-TR40	ET200505	TR 2SC2603 E,F
2-TR43,44	ET200505	TR 2SC2603 E,F
2-D1	ED308952	D GERMA V 1K34A-LR F07
2-D2	ED560913	D SILICON V 1S2473VE
2-D5,6	ED560913	D SILICON V 1S2473VE
2-R1,1	EP322437	RELAY LEAD LAB2NS 2NO 5V
2-X1	E1323231	OSC XTAL 4MHz
2-VR1	EV317580	R S-FIX HTM8KV2-IS 3P 0.50W
2-VR2	EV520806	R S-FIX H V8K4-1 3P 103
2-P1,2	E1306822	PLUG 7P CONNECTOR 171825-7 7P
2-P3	EJ1318366	PLUG 9P CONNECTOR 171825-9
2-P5	EJ1318261	PLUG 5P CONNECTOR 171825-5
2-P6	EJ1318260	PLUG 4P CONNECTOR 171825-4
<b>PC POWER &amp; SERVO BLOCK</b>		
2-4C1	E1213390	IC NJM4558D
2-4C2	E1306726	IC TC4069UBP
2-4C3	E1306727	IC TC4013BP
2-4C4	E1325557	IC AP-400-A (TM4504P)
2-4C5	E1213390	IC NJM4558D
2-4C8	E1310043	IC SN74LS03N
2-4C9,10	E1213390	IC NJM4558D
2-4C12	E1328796	IC $\mu$ PC78M12H
2-4C13	E1328798	IC $\mu$ PC78M05H
2-4C14	E1328796	IC $\mu$ PC78M12H
2-TR1	ET330162	TR 2SC1959 O,Y
2-TR2	ET200505	TR 2SC2603 E,F
2-TR3	ET200558	TR 2SA1115 E,F
2-TR4	ET200505	TR 2SC2603 E,F
2-TR5,6	ET200558	TR 2SA1115 E,F
2-TR7to9	ET666404	TR 2SD571 K,L
2-TR10to12	ET666415	TR 2SB605 K,L
2-TR17,18	ET200505	TR 2SC2603 E,F
2-TR21	ET200558	TR 2SA1115 E,F

REF. NO.	PARTS NO.	DESCRIPTION
2-TR24	ET200505	TR 2SC2603 E,F
2-TR25	ET307349	TR 2SD794 P,Q
2-D1	ED313284	D ZENER H WZ-036
2-D2to5	ED560913	D SILICON V 1S2473VE
2-D15to17	ED322238	D SILICON 1B4B41 100/1.0A
2-VR1,2	EV317580	R S-FIX H TM8KV2-IS 3P 0.50W
2-X1	E1328799	OSC XTAL 4.32 MHz
2-J1	EJ312099	SOCKET JUMPER W-D0616 16P
2-FR1,2	ER318248	$\Delta$ R FUSE ERD2FC 1/4W 47R0G
2-C32	EC320548	C CE V F 103Z 250AC (U,J)
2-C32	EC314688	C CE V FZ 103P 125AC (C,A)
2-C32	EC325671	C MP V 103M 250AC (E,B,S)
<b>PC SENSOR AMP BLOCK</b>		
2-4C1	E1201940	IC NJM4558S
2-4C2	E1322599	IC TA75458S
2-TR1	ET200505	TR 2SC2603 E,F
<b>PC INTERRUPTER (A) BLOCK</b>		
2-PH1	ET328889	PHOTO SENSOR EE-SV3-B
<b>PC INTERRUPTER (B) BLOCK</b>		
2-PH1	ET328889	PHOTO SENSOR EE-SV3-B
<b>PC REJECT SW BLOCK</b>		
2-TR1to3	ET200505	TR 2SC2603 E,F
<b>PC UP SW BLOCK</b>		
2-SW1	ES308929	SW MICRO VV-5
<b>PC DOWN SW BLOCK</b>		
2-SW1	ES308929	SW MICRO VV-5
<b>PC DEFLECTION SW BLOCK</b>		
2-SW1	ES308929	SW MICRO VV-5

## 3. MAIN PANEL L45 P.C BOARD BLOCK

REF. NO.	PARTS NO.	DESCRIPTION
3-1	BA1P015A100A	PC MAIN PANEL L45 BLK AP-L45 (Inc. Main Panel, SW Size PCB)
<b>PC MAIN PANEL BLOCK</b>		
3-1C1	E1310043	IC SN74LS03N
3-1C2	E1328789	IC SN74LS12N
3-1C3	E1328790	IC SN74LS109AN
3-TR1	ET200505	TR 2SC2603 E,F
3-TR2to7	ET200558	TR 2SA1115 E,F
3-D1to5	ED322772	D LED SLP-15SD-01 RED
3-D6	ED322773	D LED SLP-25SD-01 GRN
3-D7	ED322772	D LED SLP-15SD-01 RED
3-SW1,2	ES328777	SW TACT EVQ-PYR12K
3-SW3,4	ES328778	SW TACT KH10901
3-SW5to7	ES328777	SW TACT EVQ-PYR12K
<b>PC SW SIZE BLOCK</b>		
3-SW1	ES328780	SW PUSH SPK-02 2-02-02N
3-2	ZW-329991	RV NYL30x044

ASSEMBLY BLOCK (1)

4. ASSEMBLY BLOCK (1)

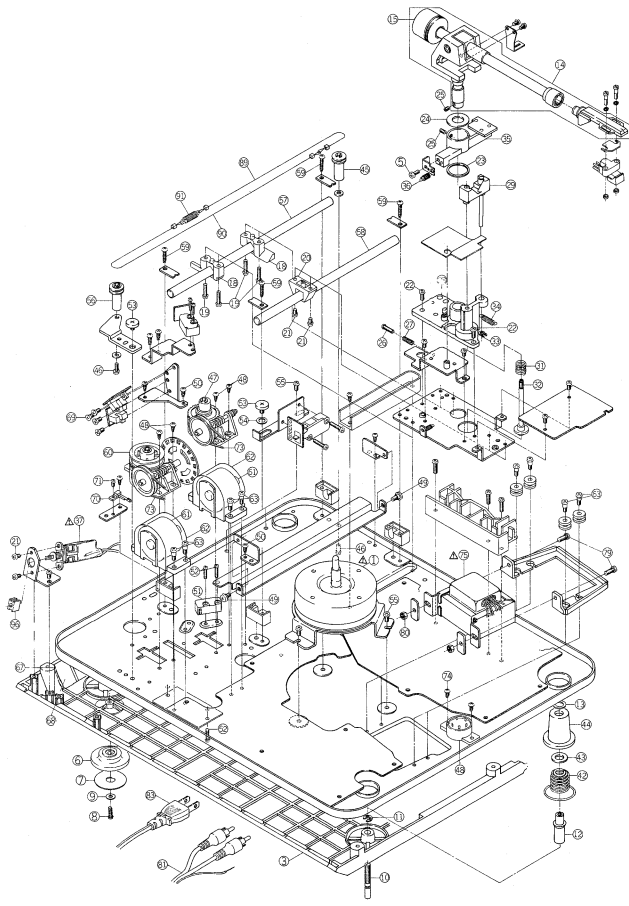

REF. NO.	PARTS NO.	DESCRIPTION
<b>MOTOR BLOCK</b>		
4-1	BMH20200A	MOTOR BLM-200
4-2x	E1328241	HOLL ELEMENT VHE-711
<b>COVER BOTTOM BLOCK</b>		
4-3	SP329641	COVER BOTTOM
4-4	ZS324402	PLX PAN30x08STL CMT
4-6	SA329647	FOOT RUBBER
4-7	TP329648	FELT RUBBER FOOT
4-8	ZS325503	PLX PAN30x13STL CMT
4-9	ZW550642	PW31x080x050STL CMT
4-10	TP329649	PROP BOTTOM
4-11	ZW270123	RING E4008STL CMT
4-12	TP329650	PROP 9 INSULATOR
4-13	ZW332727	RING CS780STL PRK
<b>STONE ARM BLOCK</b>		
4-14	TP328793	STONE ARM W/SHELL
4-15	TP780013	MAIN WEIGHT 4-80079
4-16x	TP329217	STONE ARM W/SHELL (BL)
4-17x	TP780014	MAIN WEIGHT (BL) 4-80105
<b>CHASSIS STONE ARM BLOCK</b>		
4-18	TP329554	SLIDER (A)
4-19	ZS483502	PAN30x13STL CMT
4-20	TP329555	SLIDER (B)
4-21	ZS422076	PAN30x05STL CMT
4-22	ZS609332	PAN080X13 CMT PW080
4-23	PW329557	WASHER SENSOR (A)
4-24	PW329558	WASHER SENSOR (B)
4-25	ZS356804	6SEI30x085CM PFR HP
4-26	ZS309246	ADJUST SCREW (B)
4-27	ZG313178	SP C-3.5/0.5-12.5 C-025
<b>HOLDER TONE ARM BLOCK</b>		
4-28	TPB329869	TONE ARM PART
4-29	TPB329885A	ARM LIFTER PART
4-30x	TPB329885B	ARM LIFTER (BL) PART
4-31	ZG329587	SP PUSH LIFTER
4-32	TPB329897	SHAFT LIFTER PART
4-33	ZW653163	RING CS280STL PRK
4-34	ZG313029	SP T-5.0/0.32-24.4 T1-142
<b>SENSOR UNIT BLOCK</b>		
4-35	TP328894	SENSOR UNIT
4-36	ZG313042	SP T1-5.0/0.5-18.0 T1-155
<b>POWER SW BLOCK</b>		
4-37	ES328786	△ SW PUSH ESB-901595 01-1 B (E,B,S)
4-38x	ES328787	△ SW PUSH ESB-90149R 01-1 J (J)
4-39x	ES328788	△ SW PUSH ESB-90144T 01-1 UC (C,A)
<b>ASSEMBLY BLOCK</b>		
4-42	ZG329667A	SP PULL INSULATOR (A)
4-43	ZW329651	WASHER INSULATOR
4-44	TP329652	CUSHION INSULATOR
4-45	ZSB329743	PROP 1 PULLEY(A) PART
4-46	ZS413201	PAN40x08STL CMT
4-47	TP329984	LIFTER CAM ASSY
4-48	ZS478640	T2BR30x05STL CMT
4-49	ZS329990	GRADUATED SCREW Y981
4-50	ZS325495	T2BR30x06STL CMT
4-51	ES533478	SW MICRO K3 UC
4-52	ZS482736	PROP 1 PULLEY(B) PART
4-53	ZS329989	GRADUATED SCREW Y906B
4-54	ZW260111	PW61x100x080NYL
4-55	ZS417150	PAN40x06STL CMT
4-56	ZSB329750	PROP 1 PULLEY(C) PART
4-57	TP329470A	SHAFT GUIDE(A)
4-58	TP329470B	SHAFT GUIDE(B)
4-59	ZS452802	T2BR30x13STL CMT
4-60	TP323299	TRACKING ASSY AP-L45
4-61	BM328792	MOTOR HMR3401-01-020

REF. NO.	PARTS NO.	DESCRIPTION
4-62	TP329538	CUSHION
4-63	ZS329988	GRADUATED SCREW Y2063
4-64x	ZS455207	T2BR30x05STL CMT
4-65x	ZS608174	PAN26x03STL N13
4-66x	ZW339503	PW31x080x050NYL
4-69	ZS414033	CTS30x05STL CMT
4-70	ES309920	SW LEAF BSW-130 01-1 NO
4-71	ZS608095	PAN20x05STL CMT
4-72x	ZS244912	CTS26x15STL N13
4-73	MB329540	BELT
4-74	ES305733	SW SELECTOR HWX01 31-260 01-4
4-75	BT328782	△ TRANS POWER AP195-70(U)
4-76x	BT328783	△ TRANS POWER AP195-10(U)
4-77x	BT328784	△ TRANS POWER AP195-30(C,A)
4-78x	BT328785	△ TRANS POWER AP195-40(E,B,S)
4-79	ZS424056	PAN40x16STL CMT
4-80	ZW413188	N40STL CMT 1
4-81	EW326740	CORD 21068-3 2P AUDIO CORD (U,J,E,B,S)
4-82x	EW323781	CORD 3P AUDIO CORD (C,A)
4-83	EW306428	△ AC CORD 2 CORES KP-205A, VFF UCJ (U)
4-84x	EW306427	△ AC CORD 2 CORES KP-211, VFF 1 (J)
4-85x	EW305691	△ AC CORD 2 CORES KP-8, SPT-1 UC (C,A)
4-86x	EW313882	△ AC CORD 2 CORES KP-419C, LTCE-2F E (E)
4-87x	EW313884	△ AC CORD 2 CORES GTBS-2F 24/0.20x2 B (B)
4-88x	EW201515	△ AC CORD 2 CORES KP-560, LTSA-2F S (S)
4-89	TP329589A	STRING WIRE (A) L=237.4MM
4-90	TP329589B	STRING WIRE (B) L=662.3MM
4-91	ZS313085	SP T1-6.3/0.8-25.0 T1-197
4-92x	ZS391476	6SEI40x0405CM PFR HP
4-96	SK329634	KNOB PUSH
4-97	EF309388	△ FUSE TSC A 250V 0.80A (F2) (U,J)
4-98	EF306125	△ FUSE TSC A 250V 0.31A (F3) (U,J)
4-99	EF311839	△ FUSE TSC A 250V 1.6A (F4.5) (U,J)
4-100x	EF309391	△ FUSE TSC 125V 0.08A (F2) (C,A)
4-101x	EF306088	△ FUSE TSC 125V 0.31A (F3)(C,A)
4-102x	EF308847	△ FUSE TSC 125V 1.60A (F4.5) (C,A)
4-103x	EF695766	△ FUSE SEMKO T 250V 0.31A (F1) (B)
4-104x	EF258344	△ FUSE SEMKO T 250V 0.80A (F2) (E,B,S)
4-105x	EF695766	△ FUSE SEMKO T 250V 0.31A (F3) (E,B,S)
4-106x	EF601964	△ FUSE SEMKO T 250V 1.60A (F4.5) (E,B,S)
4-107x	ZS319588	T1PAN30x35STL CMT

ASSEMBLY BLOCK (2)

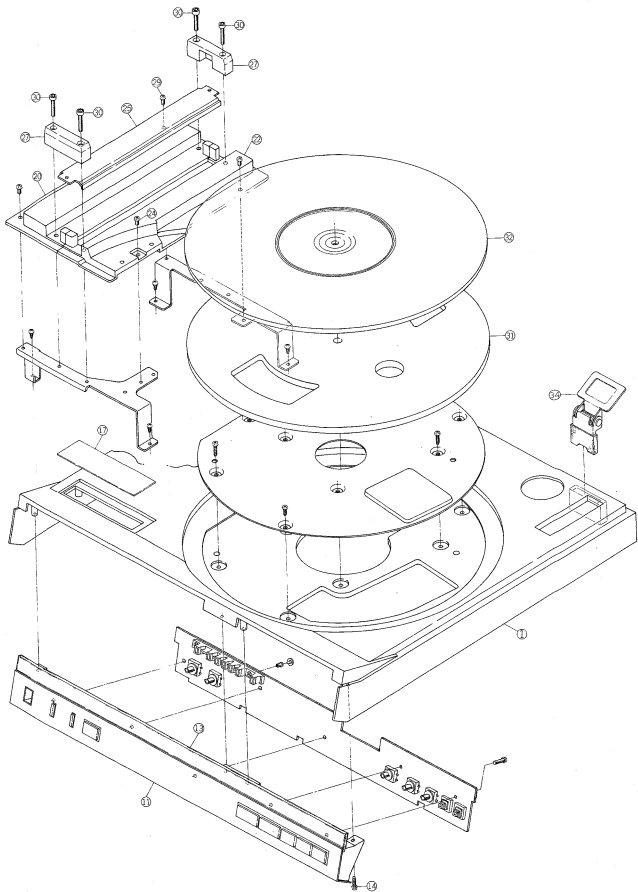

## 5. ASSEMBLY BLOCK (2)

REF. NO.	PARTS NO.	DESCRIPTION
<b>CABINET BLOCK</b>		
5-1	BC329595A	CABINET
5-2x	BC329595B	CABINET (BL)
5-3x	SE329625A	ESCUTCHEON FRONT
5-4x	SE329625B	ESCUTCHEON FRONT (BL)
5-5x	SE329639A	ESCUTCHEON POWER
5-6x	SE329639B	ESCUTCHEON POWER (BL)
5-7x	SE329631C	ESCUTCHEON KNOB (A-2)
5-8x	SE329631D	ESCUTCHEON KNOB (A-2)-BL
5-9x	SE329974A	ESCUTCHEON KNOB (B)
5-10x	SE329974B	ESCUTCHEON KNOB (B)-BL
5-11	TP329973A	PLATE OPERATION (B)
5-12x	TP329973B	PLATE OPERATION (B)-BL
5-13	SZ329630B	IND PLATE LED (AP-L45)
5-14	ZS325503	PLX PAN30x12STL CMT
5-16	TP329598C	PLATE AP-L45
5-17x	TP329598D	PLATE AP-L45 (BL)
5-18x	TP329663A	SHEET ANTI-REFLECTION
5-19x	TP329663B	SHEET ANTI-REFLECTION (BL)
<b>ASSEMBLY BLOCK</b>		
5-20	TP329577A	COVER ARM (A)
5-21x	TP329577B	COVER ARM (A)-BL
5-22	TP329582A	COVER ARM (B)
5-23x	TP329582B	COVER ARM (B)-BL
5-24	ZS325495	T2BR30x06STL CMT
5-25	TP329586C	MASK (D)
5-26x	TP329586D	MASK (D)-BL
5-27	TP329584A	HOLDER MASK
5-28x	TP329584B	HOLDER MASK (BL1)
5-29	ZS379350	PAN30x06STL CMT
5-30	ZS329979	6RB30x200BRS NI3
5-31	TP329306	PLATTER
5-32	TP329307A	TABLE SHEET (A) (U,J,C,E,B,S)
5-33x	TP329307B	TABLE SHEET (B) (A)
5-34	TPB320745	HINGE (D) PART AP-D30

## FINAL ASSEMBLY BLOCK

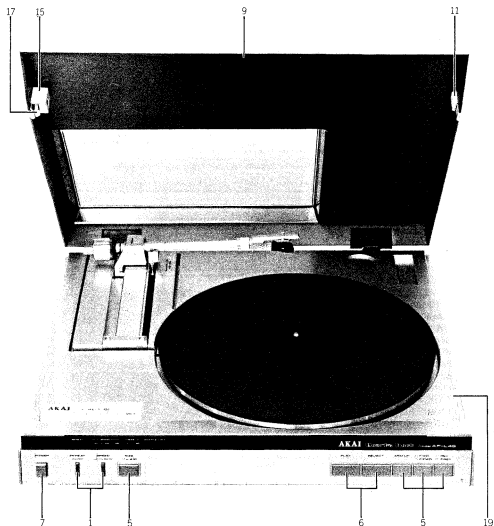

### 6. FINAL ASSEMBLY BLOCK

REF. PARTS NO. DESCRIPTION  
NO.

#### CABINET BLOCK

6-1 SK329632A KNOB PUSH (A)  
6-2x SK329632B KNOB PUSH (A)-BL  
6-3 SK329600A KNOB PUSH (B)  
6-4x SK329600B KNOB PUSH (B)-BL  
6-5 SK329603A KNOB PUSH (C)  
6-6x SK329603B KNOB PUSH (C)-BL

#### FINAL ASSEMBLY BLOCK

6-7 SK329636A KNOB POWER  
6-8x SK329636B KNOB POWER (BL)  
6-9 BC329590C DUST COVER AP-L45  
6-10x BC329590D DUST COVER AP-L45 (BL)  
6-11 TP329591A CUSHION COVER  
6-12x TP329591B CUSHION COVER (BL)  
6-13x SE331934A ESCUTCHEON KNOB (C)  
6-14x SE331934B ESCUTCHEON KNOB (C)-BL  
6-15 TP331935A CLAMPER (C)  
6-16x TP331935B CLAMPER (C)-BL  
6-17 TP331936A CLAMPER (A)  
6-18x TP331936B CLAMPER (A)-BL

REF. PARTS NO. DESCRIPTION  
NO.

6-19 TP331937A CLAMPER (B)  
6-20x TP331937B CLAMPER (B)-BL  
6-21x ZG313172 SP C-3.5/0.4-10.0 C-020  
6-22x ZS306488 T1BID30x10STL BNI  
6-23x TP332786A MASK (E)  
6-24x TP332786B MASK (E)-BL  
6-25x TP332787A MASK (F)  
6-26x TP332787B MASK (F)-BL  
6-27x ZS32788 T10CS20x08BNI



## II. MODEL AP-L95/C

### 1. RECOMMENDED SPARE PARTS

Because, if the parts listed below are on hand, almost any repair can be accomplished, we suggest that you stock these Recommended Spare Parts Items.

REF. NO.	PARTS NO.	DESCRIPTION
1-1	BMM3102A010A	MOTOR BLM-200
1-2	BM328792	MOTOR HMR3401-01-020
1-3	BT328783	Δ TRANS POWER APT95-10 (J)
1-4	BT328784	Δ TRANS POWER APT95-30 (C,A)
1-5	BT328785	Δ TRANS POWER APT95-40 (E,B,S)
1-6	BT328782	Δ TRANS POWER APT95-70 (U)
1-7	ED308952	D GERMA V 1K34A-LR F07
1-8	ED328791	D LED GL-9FR4 RED
1-9	ED322772	D LED SLP-155D-01 RED
1-10	ED322773	D LED SLP-255D-01 GRN
1-11	ED316143	D SILICON H 1S2473HS F10
1-12	ED560913	D SILICON V 1S2473VE
1-13	ED322238	D SILICON 1B4B41 100/1.0A
1-14	ED313284	D ZENER H WZ-036
1-15	EF695766	Δ FUSE SEMKO T 250V 0.31A (F3) (E,B,S)
1-16	EF695766	Δ FUSE SEMKO T 250V 0.31A (F1) (B)
1-17	EF258344	Δ FUSE SEMKO T 250V 0.80A (F2) (E,B,S)
1-18	EF601964	Δ FUSE SEMKO T 250V 1.60A (F4,S) (E,B,S)
1-19	EF306125	Δ FUSE TSC A 250V 0.31A (F3) (U,J)
1-20	EF309388	Δ FUSE TSC A 250V 0.80A (F2) (U,J)
1-21	EF311839	Δ FUSE TSC A 250V 1.6A (F4,S) (U,J)
1-22	EF309391	Δ FUSE TSC 125V 0.08A (F2) (C,A)
1-23	EF306088	Δ FUSE TSC 125V 0.31A (F3) (C,A)
1-24	EF308847	Δ FUSE TSC 125V 1.60A (F4,S) (C,A)
1-25	EI325557	IC AP-400-A (TM4504P)
1-26	EI328812	IC MB8841 349M
1-27	EI213390	IC NJM4558D
1-28	EI201940	IC NJM4558S
1-29	EI310043	IC SN74LS03N
1-30	EI331660	IC SN7417N
1-31	EI322599	IC TA75458S
1-32	EI306727	IC TC4013BP
1-33	EI328795	IC TC4024BPC
1-34	EI324682	IC TC4027BP
1-35	EI306726	IC TC4069UBP
1-36	EI324256	IC TL081CP
1-37	EI328798	IC UPC73M05H
1-38	EI328796	IC UPC73M12H
1-39	EI328799	OSC X'TAL 4.32 MHz
1-40	EI323231	OSC X'TAL 4MHz
1-41	EP322437	RELAY LEAD LAB2NS 2NO 5V
1-42	ER318248	Δ R FUSE ERD2FC 1/4W 47R0G
1-43	ES328788	Δ SW PUSH ESB-90144T 01-1 UC (C,A)
1-44	ES328787	Δ SW PUSH ESB-90149R 01-1 J (J)
1-45	ES328786	Δ SW PUSH ESB-90159S 01-1 B (U,E,B,S)
1-46	ES309920	SW LEAF B SW-130 01-1 NO
1-47	ES573478	SW MICRO K3 UC
1-48	ES308929	SW MICRO VV-S
1-49	ES328779	SW PUSH SPJ22H 2-02-02N
1-50	ES305733	SW SELECTOR HXW0131-260 01-4
1-51	ES329027	SW SLIDE 0024001X 2-02-04S
1-52	ES328777	SW TACT EVQ-PYR12K
1-53	ES328778	SW TACT KHf 10901
1-54	ET328889	PHOTO SENSOR EE-SV3-B
1-55	ET200558	TR 2SA1115 E,F

REF. NO.	PARTS NO.	DESCRIPTION
1-56	ET328861	TR 2SA562TM O,Y
1-57	ET323348	TR 2SB807HP D,E,F
1-58	ET666415	TR 2SB605 K,L
1-59	ET530162	TR 2SC1959 O,Y
1-60	ET328864	TR 2SC2120 O,Y
1-61	ET200505	TR 2SC2603 E,F
1-62	ET323366	TR 2SD313HP D,E,F
1-63	ET666404	TR 2SD571 K,L
1-64	ET307349	TR 2SD794 P,Q
1-65	ET321016	TR 2SK117 GR,BL
1-66	EV329215	R S-FIX H TM8K(PV) 3P 0.30W 105
1-67	EV317580	R S-FIX H TM8KV2-IS 3P 0.50W 202
1-68	EV520806	R S-FIX H V8K4-1 3P 103
1-69	MB329540	BELT
1-70	TP328894	SENSOR UNIT
1-71	TP328793	TONE ARM W/SHELL
1-72	TP329217	TONE ARM W/SHELL (BL)

### 2. SYS. CON. P.C BOARD BLOCK

REF. NO.	PARTS NO.	DESCRIPTION
2-1	BAP015A060F	PC SYSCON BLK AP-L95(U)
2-2	BAP015A060G	PC SYSCON BLK AP-L95(J)
2-3	BAP015A060H	PC SYSCON BLK AP-L95(C),(C,A)
2-4	BAP015A060J	PC SYSCON BLK AP-L95(E),(E,S)
2-5	BAP015A060K	PC SYSCON BLK AP-L95(B)

#### PC SYSCON BLOCK

2-IC1,2	EI331660	IC SN7417N
2-IC3	EI328812	IC MB8841 349M
2-IC4,5	EI322599	IC TA75458S
2-IC6	EI324256	IC TL081CP
2-TR1	ET200558	TR 2SA1115 E,F
2-TR2	ET200505	TR 2SC2603 E,F
2-TR3	ET200558	TR 2SA1115 E,F
2-TR4,5	ET200505	TR 2SC2603 E,F
2-TR6	ET200558	TR 2SA1115 E,F
2-TR7	ET323366	TR 2SD313HP D,E,F
2-TR8	ET323348	TR 2SB807HP D,E,F
2-TR9	ET321016	TR 2SK117 GR,BL
2-TR10,11	ET200558	TR 2SA1115 E,F
2-TR12	ET200505	TR 2SC2603 E,F
2-TR13	ET200558	TR 2SA1115 E,F
2-TR14,15	ET200505	TR 2SC2603 E,F
2-TR16	ET200558	TR 2SA1115 E,F
2-TR17	ET328844	TR 2SC2120 O,Y
2-TR18	ET328861	TR 2SA562TM O,Y
2-TR19 to 21	ET200505	TR 2SC2603 E,F
2-TR22	ET200558	TR 2SA1115 E,F
2-TR23,24	ET200505	TR 2SC2603 E,F
2-TR25	ET200558	TR 2SA1115 E,F
2-TR26 to 28	ET200505	TR 2SC2603 E,F
2-TR29	ET200558	TR 2SA1115 E,F
2-TR30	ET200505	TR 2SC2603 E,F
2-TR31	ET200558	TR 2SA1115 E,F
2-TR32	ET200505	TR 2SC2603 E,F
2-TR33	ET200558	TR 2SA1115 E,F
2-TR34	ET200505	TR 2SC2603 E,F
2-TR35,36	ET200558	TR 2SA1115 E,F
2-TR37	ET200505	TR 2SC2603 E,F
2-TR38,39	ET200558	TR 2SA1115 E,F
2-TR40	ET200505	TR 2SC2603 E,F
2-TR41,42	ET200558	TR 2SA1115 E,F
2-TR43,44	ET200505	TR 2SC2603 E,F
2-TR45	ET321016	TR 2SK117 GR,BL
2-TR46,47	ET200505	TR 2SC2603 E,F
2-TR48	ET200558	TR 2SA1115 E,F
2-TR49,50	ET200505	TR 2SC2603 E,F
2-D1	ED308952	D GERMA V 1K34A-LR F07
2-D2 to 6	ED560913	D SILICON V 1S2473VE
2-D7,8	ED316143	D SILICON H 1S2473HS F10
2-D9 to 14	ED560913	D SILICON V 1S2473VE

REF. NO.	PARTS NO.	DESCRIPTION
2-RL1	EP322437	RELAY LEAD LAB2NS 2NO 5V
2-X1	E1323231	OSC X'TAL 4MHZ
2-VR1	EV317580	R S-FIX H TM8KV2-1S 3P 0.50W
		202
2-VR2	EV520806	R S-FIX H V8K4-1 3P 103
2-P1 to 3	EJ306822	PLUG 7P CONNECTOR 171825-7 7P
2-P4	EJ318263	PLUG 8P CONNECTOR 171825-8
		8P
2-P5	EJ318261	PLUG 5P CONNECTOR 171825-5
		5P
2-P6	EJ318260	PLUG 4P CONNECTOR 171825-4
		4P
2-P7	EJ318259	PLUG 3P CONNECTOR 171825-3
		3P
2-R116	EW308922	PW92x150x050ALM
2-R118	ER309816	R MF V 1/4W 1502F
2-C26	EC317420	C SA V F05 R10K 10DC
2-C33	EC316569	C SA V F05 R22K 25.0DC

#### PC POWER & SERVO BLOCK

2-IC1	E1213390	IC NJM4558D
2-IC2	E1306726	IC TC4069UBP
2-IC3	E1306727	IC TC4013BP
2-IC4	E1325557	IC NJM4558D (TM4504P)
2-IC5	E1213390	IC NJM4558D
2-IC6	E1328795	IC TC4024BPC
2-IC7	E1324682	IC TC4027BP
2-IC8	E1310043	IC SN74LS03N
2-IC9,10	E1213390	IC NJM4558D
2-IC12	E1328796	IC $\mu$ PC78M12H
2-IC13	E1328798	IC $\mu$ PC78M05H
2-IC14	E1328796	IC $\mu$ PC78M12H
2-TR1	ET330162	TR 2SC1959 O,Y
2-TR2	ET200505	TR 2SC2603 E,F
2-TR3	ET200558	TR 2SA1115 E,F
2-TR4	ET200505	TR 2SC2603 E,F
2-TR5,6	ET200558	TR 2SA1115 E,F
2-TR7 to 9	ET666404	TR 2SD571 K,L
2-TR10 to 12	ET666415	TR 2SB806 K,L
2-TR13	ET200558	TR 2SA1115 E,F
2-TR14,15	ET200505	TR 2SC2603 E,F
2-TR16	ET200558	TR 2SA1115 E,F
2-TR17 to 20	ET200505	TR 2SC2603 E,F
2-TR21 to 23	ET200558	TR 2SA1115 E,F
2-TR24	ET200505	TR 2SC2603 E,F
2-TR25	ET307349	TR 2SD794 P,Q
2-D1	ED313284	D ZENER H WZ-036
2-D2 to 14	ED560913	D SILICON V 1S2473VE
2-D15 to 17	ED322238	D SILICON 1B4841 100/1.0A
2-VR1,2	EV317580	R S-FIX H TM8KV2-1S 3P 0.50W
		202
2-X1	E1328799	OSC X'TAL 4.32 MHz
2-J1	EJ312099	SOCKET JUMPER W-D0616 16P
2-FR1,2	ER318248	$\Delta$ R FUSE ERD2FC 1/4W 47R0G
2-C16 to 18	EC601132	C EC V CUT NP 04D R47M 50DC
2-C21	EC313826	C SA V F05 R 10K 25DC
2-C32	EC320548	C CE V F 103Z 250AC (U,J)
2-C32	EC314688	C CE V FZ 103P 125AC (C,A)
2-C32	EC325671	C MP V 103M 250AC (E,B,S)

#### PC SENSOR AMP BLOCK

2-IC1	E1201940	IC NJM4558S
2-IC2	E1322599	IC TA75458S
2-TR1 to 3	ET200505	TR 2SC2603 E,F
2-VR1	EV329215	R S-FIX H TM8K(PV) 3P 0.30W
		105
2-R13	ER329279	R OMF H FS 1W 271J

#### PC SENSITIVITY SELECTOR BLOCK

2-SW1	ES329027	SW SLIDE 0024001X 2-02-04S
2-R1	ER318323	R MF H F10 1/4W 1803F
2-R2	ER329280	R MF H F10 1/4W 6202F
2-R3	ER329282	R MF H F10 1/4W 2702F

#### PC INTERRUPTER (A) BLOCK

2-PH1	ET328889	PHOTO SENSOR EE-SV3-B
-------	----------	-----------------------

REF. NO.	PARTS NO.	DESCRIPTION
		PC INTERRUPTER (B) BLOCK
2-PH1	ET328889	PHOTO SENSOR EE-SV3-B
		PC REJECT SW BLOCK
2-TR1 to 3	ET200505	TR 2SC2603 E,F
		PC UP SW BLOCK
2-SW1	ES308929	SW MICRO VV-S
		PC DOWN SW BLOCK
2-SW1	ES308929	SW MICRO VV-S
		PC DEFLECTION BLOCK
2-SW1	ES308929	SW MICRO VV-S

### 3. MAIN PANEL L95 P.C BOARD BLOCK

REF. NO.	PARTS NO.	DESCRIPTION
3-1	BAF1016A00A	PC MAIN PANEL L95 BLK AP-L95
		PC MAIN PANEL L95 BLOCK
3-IC1,2	EI310043	IC SN74LS03N
3-TR1	ET200558	TR 2SA1115 E,F
3-TR2	ET200505	TR 2SC2603 E,F
3-TR3 to 6	ET200558	TR 2SA1115 E,F
3-D1 to 24	ED322772	D LED SLP-155D-01 RED
3-D25 to 29	ED328791	D LED GL-9PR4 RED
3-D30	ED322773	D LED SLP-255D-01 GRN
3-SW1 to 16	ES328777	SW TACT EVQ-PVR12K
3-SW17,18	ES328778	SW TACT KHFI0901
3-SW19,20	ES328777	SW TACT EVQ-PYR12K
3-2	ZW329991	RV NYL 30x044
		PC CABINET BLOCK
3-SW1 to 4	ES328777	SW TACT EVQ-PYR12K
		PC RELEASE SW BLOCK
3-SW1,2	ES328779	SW PUSH SPJ222H 2-02-02N

ASSEMBLY BLOCK (1)

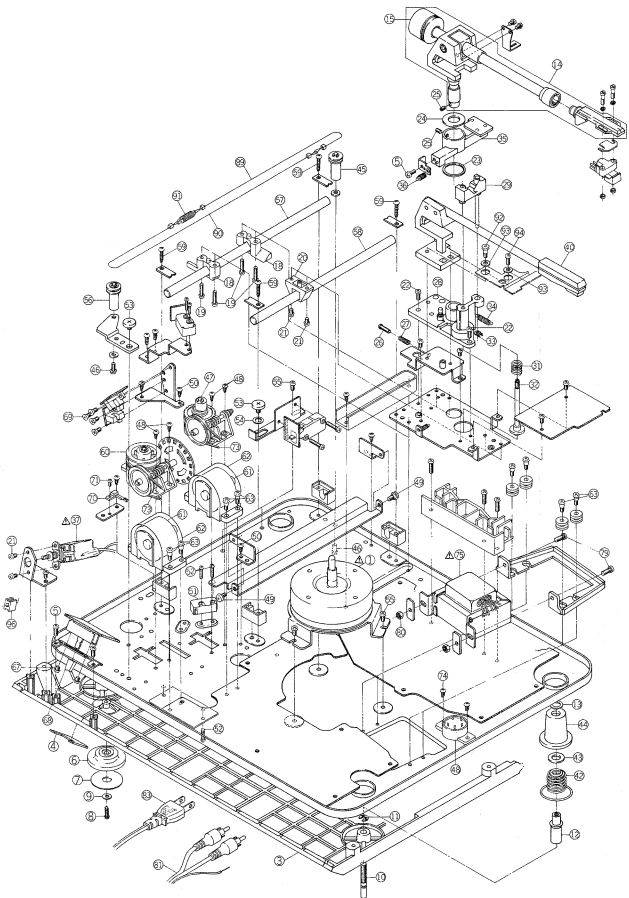

4. ASSEMBLY BLOCK (1)

REF. NO.	PARTS NO.	DESCRIPTION
<b>MOTOR BLOCK</b>		
4-1	BMM3102A010A	MOTOR BLM-200
4-2x	E1328241	HOLL ELEMENT VHE-711
<b>COVER BOTTOM BLOCK</b>		
4-3	SP329641	COVER BOTTOM
4-4	TP329642	PLATE SENSOR
4-5	ZS324202	PLX PAN30x08STL CMT
4-6	SA329647	FOOT RUBBER
4-7	TP329648	FELT RUBBER FOOT
4-8	ZS329503	PLX PAN30x12STL CMT
4-9	ZW550642	PW31x080x050STL CMT
4-10	TP329649	PROP BOTTOM
4-11	ZW270123	RING E400SUF CMT
4-12	TP329650	PROP INSULATOR
4-13	ZW332727	RING CS7805TL PKR
<b>TONE ARM BLOCK</b>		
4-14	TP328793	TONE ARM W/SHELL
4-15	TP780013	MAIN WEIGHT 4.80079
4-16x	TP329217	TONE ARM W/SHELL (BL)
4-17x	TP780014	MAIN WEIGHT (BL) 4-80105
<b>CHASSIS TONE ARM BLOCK</b>		
4-18	TP329554	SLIDER (A)
4-19	ZS443802	PAN30x12STL CMT
4-20	TP329555	SLIDER (B)
4-21	ZS422076	PAN30x08STL CMT
4-22	ZS600832	PAN30x08STL CMT PW080
4-23	PW329557	WASHER SENSOR (A)
4-24	PW329558	WASHER SENSOR (B)
4-25	ZS356804	GSET 30x040SCM PKR HP
4-26	ZS329546	ADJUST SCREW (B)
4-27	ZG313178	SP C-3.5/0.5-12.5 C-025
<b>HOLDER TONE ARM BLOCK</b>		
4-28	TPB329869	HOLDER TONE ARM PART
4-29	TPB329885A	ARM LIFTER PART
4-30x	TPB329885B	ARM LIFTER (BL) PART
4-31	ZG329587	SP PUSH LIFTER
4-32	TPB329897	SHAFT LIFTER PART
4-33	ZW653163	RING CS2805TL PKR
4-34	ZG313029	SP T1-5.0/0.32-22.4 T1-142
<b>SENSOR UNIT BLOCK</b>		
4-35	TP328894	SENSOR UNIT
4-36	ZG313042	SP T1-5.0/0.55-18.0 T1-155
<b>POWER SW BLOCK</b>		
4-37	ES328786	△ SW PUSH ESB-90159S 01-1 B (U,E,B,S)
4-38x	ES328787	△ SW PUSH ESB-90149R 01-1 H (U)
4-39x	ES328788	△ SW PUSH ESB-90144T 01-1 U (U)
<b>SUB ARM BLOCK</b>		
4-40	BZP1016A009A	SUB ARM BLK AP-L95
4-41x	BZP1016A009B	SUB ARM BLK AP-L95-BL
<b>ASSEMBLY BLOCK</b>		
4-42	ZG329667A	SP PULL INSULATOR (A)
4-43	ZW329651	WASHER INSULATOR
4-44	TP329652	CUSHION INSULATOR
4-45	ZS8329743	PROP 1 PULLEY(A) PART
4-46	ZS413201	PAN40x08STL CMT
4-47	TP329984	LIFTER CAM ASSEY
4-48	ZS447840	T2BR30x08STL CMT
4-49	ZS329990	GRADUATED SCREW Y981
4-50	ZS325495	T2BR30x08STL CMT
4-51	ES5734078	SW MICRO K3 UC
4-52	ZS482736	CTS30x15STL CMT
4-53	ZS329989	GRADUATED SCREW Y906B
4-54	ZW260111	PW61x100x080NVL
4-55	ZS417150	PAN40x06STL CMT
4-56	ZS8329750	PROP 1 PULLEY(B) PART

REF. NO.	PARTS NO.	DESCRIPTION
4-57	TP329470A	SHAFT GUIDE(A)
4-58	TP329470B	SHAFT GUIDE(B)
4-59	ZS462802	T2BR30x15STL CMT
4-60	TP329983	TRACKING ASSY
4-61	BM328792	MOTOR HMR3401-01-020
4-62	TP329538	CUSHION
4-63	ZS329988	GRADUATED SCREW Y2063
4-64x	ZS455207	T2BR30x08STL CMT
4-65x	ZS608174	PAN26x08STL N13
4-66x	ZW259503	PW31x080x050NVL
4-67	ZS329378	PAN26x08STL CMT
4-68	SK329565	KNOB SLIDE
4-69	ZS414033	CTS30x08STL CMT
4-70	ES309920	SW LEAF BSW-130 01-1 NO
4-71	ZS308095	PAN20x05STL CMT
4-72x	ZS244912	ZS244912
4-73	MB329540	BELT
4-74	ES305733	SW SELECTOR HW0131-260 01-4
4-75	BT328782	△ TRANS POWER APT95-70(U)
4-76x	BT328783	△ TRANS POWER APT95-10(U)
4-77x	BT328784	△ TRANS POWER APT95-30(C,A)
4-78x	BT328785	△ TRANS POWER APT95-40(E,B,S)
4-79	ZS424056	PAN40x10STL CMT
4-80	ZW413188	N40STL CMT 1
4-81	EW326740	CORD 21068-32P AUDIO CORD (U,E,B,S)
4-82x	EW328781	CORD 2P AUDIO CORD (C,A)
4-83	EW306428	△ AC CORD 2 CORES KP-205A, 240.02x2 B (B)
4-84x	EW306427	△ AC CORD 2 CORES KP-211, VFF J (J)
4-85x	EW305691	△ AC CORD 2 CORES KP-8, SPT-1
4-86x	EW313882	△ AC CORD 2 CORES KP-419C, LTCE-2F E (E)
4-87x	EW313884	△ AC CORD 2 CORES GTBS-2F (U)
4-88x	EW201515	△ AC CORD 2 CORES KP-560, L TSA-2F S (S)
4-89	TP329589A	STRING WIRE (A) L=237.4MM
4-90	TP329589B	STRING WIRE (B) L=662.3MM
4-91	ZG313085	SP T1-6.3/0.8-25.0 T1-197
4-92	ZS329569	SCREW SENSOR ARM
4-93	ZG330033	CONE DISC SPRING DB-4
4-94	ZS421740	PAN30x08STL B NI
4-95x	ZS391476	GSET40x040SCM PKR HP
4-96	SK329634	KNOB PUSH
4-97	EF309388	△ FUSE TSC A 250V 0.80A (F2) (U,J)
4-98	EF306125	△ FUSE TSC A 250V 0.31A (F3) (U,J)
4-99	EF311839	△ FUSE TSC A 250V 1.6A (F4,5) (U,J)
4-100x	EF309391	△ FUSE TSC 125V 0.80A (F2) (C,A)
4-101x	EF306088	△ FUSE TSC 125V 0.31A (F3)(C,A)
4-102x	EF308847	△ FUSE TSC 125V 1.60A (F4,5) (C,A)
4-103x	EF695766	△ FUSE SEMKO T 250V 0.31A (F3)
4-104x	EF258344	△ FUSE SEMKO T 250V 0.80A (F2) (E,B,S)
4-105x	EF695766	△ FUSE SEMKO T 250V 0.31A (F3)
4-106x	EF601964	△ FUSE SEMKO T 250V 1.60A (F4,5) (E,B,S)
4-107x	ZS331988	T1PAN30x35 STL CMT

ASSEMBLY BLOCK (2)

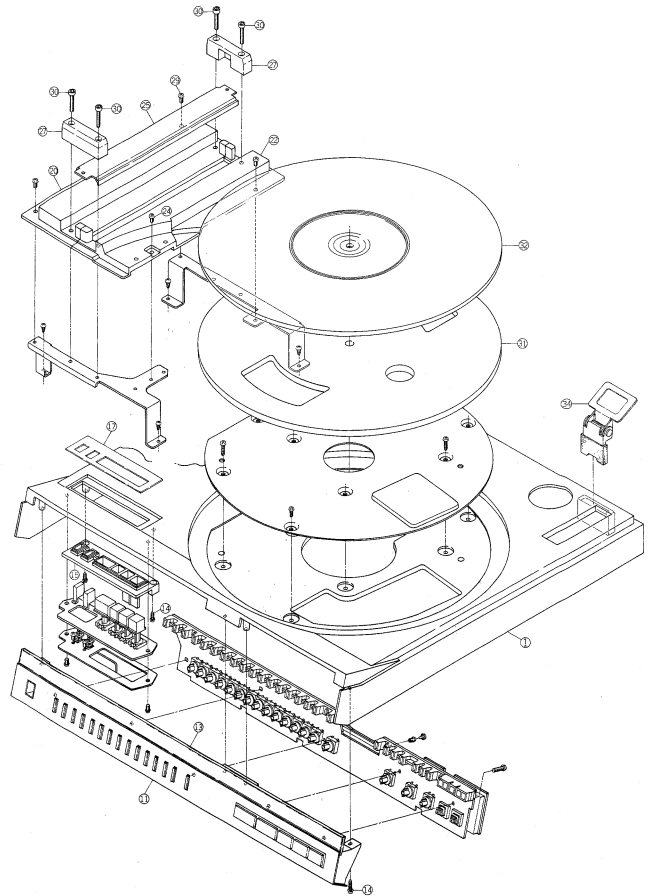

---

## 5. ASSEMBLY BLOCK (2)

REF. NO.	PARTS NO.	DESCRIPTION
<b>CABINET BLOCK</b>		
5-1	BC329595A	CABINET
5-2x	BC329595B	CABINET (BL)
5-3x	SE329625A	ESCUTCHEON FRONT
5-4x	SE329625B	ESCUTCHEON FRONT (BL)
5-5x	SE329639A	ESCUTCHEON POWER
5-6x	SE329639B	ESCUTCHEON POWER (BL)
5-7x	SE329631A	ESCUTCHEON KNOB (A-1)
5-8x	SE329631B	ESCUTCHEON KNOB (A-1)-BL
5-9x	SE329631C	ESCUTCHEON KNOB (A-2)
5-10x	SE329631D	ESCUTCHEON KNOB (A-2)-BL
5-11	TP329629A	PLATE OPERATION (A)
5-12x	TP329629B	PLATE OPERATION (A)-BL
5-13	SZ329630A	IND PLATE LED
5-14	ZS325503	PLX PAN30x12STL CMT
5-15	SE329599A	ESCUTCHEON SUB OPERATION
5-16x	SE329599B	ESCUTCHEON SUB OPERATION (BL)
5-17	TP329598A	PLATE SUB OPERATION
5-18x	TP329598B	PLATE SUB OPERATION (BL)
5-19x	TP329663B	SHEET ANTI-REFLECTION (BL)
<b>ASSEMBLY BLOCK</b>		
5-20	TP329577A	COVER ARM (A)
5-21x	TP329577B	COVER ARM (A)-BL
5-22	TP329582A	COVER ARM (B)
5-23x	TP329582B	COVER ARM (B)-BL
5-24	ZS325495	T2BR30x06STL CMT
5-25	TP329586A	MASK (C)
5-26x	TP329586B	MASK (C)-BL
5-27	TP329584A	HOLDER MASK
5-28x	TP329584B	HOLDER MASK (BL1)
5-29	ZS379350	PAN30x06STL CMT
5-30	ZS329979	6RB30x200BRS N13
5-31	TP329306	PLATTER
5-32	TP329307A	TABLE SHEET (A) (U,J,C,E,B,S)
5-33x	TP329307B	TABLE SHEET (B) (A)
5-34	TPB320745	HINGE (D) PART AP-D30

## FINAL ASSEMBLY BLOCK

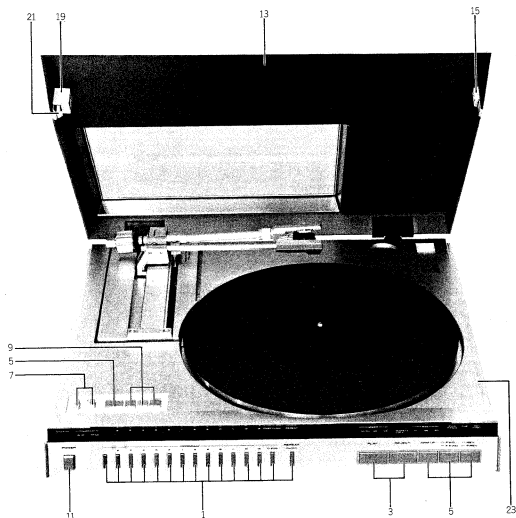

### 6. FINAL ASSEMBLY BLOCK

REF. NO.	PARTS NO.	DESCRIPTION	REF. NO.	PARTS NO.	DESCRIPTION
<b>CABINET BLOCK</b>			<b>FINAL ASSEMBLY BLOCK</b>		
6-1	SK329632A	KNOB PUSH (A)	6-20x	TP331935B	CLAMPER (C)-BL
6-2x	SK329632B	KNOB PUSH (A)-BL	6-21	TP331936A	CLAMPER (A)
6-3	SK329600A	KNOB PUSH (B)	6-22x	TP331936B	CLAMPER (A)-BL
6-4x	SK329600B	KNOB PUSH (B)-BL	6-23	TP331937A	CLAMPER (B)
6-5	SK329603A	KNOB PUSH (C)	6-24x	TP331937B	CLAMPER (B)-BL
6-6x	SK329603B	KNOB PUSH (C)-BL	6-25x	ZG313172	SP C-3.5/0.4-10.0 C-020
6-7	SK329614A	KNOB PUSH (D)	6-26x	ZS306488	T1BID30x10STL BNI
6-8x	SK329614B	KNOB PUSH (D)-BL	6-27x	TP332786A	MASK (E)
6-9	SK329640A	KNOB PUSH (E)	6-28x	TP332786B	MASK (E)-BL
6-10x	SK329640B	KNOB PUSH (E)-BL	6-29x	TP332787A	MASK (F)
6-11	SK329636A	KNOB POWER	6-30x	TP332787B	MASK (F)-BL
6-12x	SK329636B	KNOB POWER (BL)	6-31x	ZS332788	T10CS20x08BNI
6-13	BC329590A	DUST COVER AP-L95			
6-14x	BC329590B	DUST COVER AP-L95 (BL)			
6-15	TP329591A	CUSHION COVER			
6-16x	TP329591B	CUSHION COVER (BL)			
6-17x	SE331934A	ESCUTCHEON KNOB (C)			
6-18x	SE331934B	ESCUTCHEON KNOB (C)-BL			
6-19	TP331935A	CLAMPER (C)			

When ordering parts, please quote Parts Number, Description and Model Number.

# INDEX

## 1. MODEL AP-L45/C

PARTS NO.	REF. NO.	PARTS NO.	REF. NO.	PARTS NO.	REF. NO.	PARTS NO.	REF. NO.	PARTS NO.	REF. NO.
BAF1015A061A	2-1	ES309920	4-70	SE329625A	5-3x	TP332787B	6-26x		
BAF1015A061B	2-2	ES328777	3-SW1, 2	SE329625B	5-4x	TP780013	4-15		
BAF1015A061C	2-3	ES328777	3SW5 to 7	SE329631C	5-7x	TP780014	4-17x		
BAF1015A061D	2-4	ES328778	2-SW3, 4	SE329631D	5-8x	ZG313029	4-34		
BAF1015A061E	2-5	ES328780	3-SW1	SE329639A	5-5x	ZG313042	4-36		
BAF1015A100A	3-1	ES328786	4-37	SE329639B	5-6x	ZG313085	4-91		
BC329590C	6-9	ES328787	4-38x	SE329974A	5-9x	ZG313172	6-21x		
BC329590D	6-10x	ES328788	4-39x	SE329974B	5-10x	ZG313178	4-27		
BC329595A	5-1	ES573478	4-51	SE331934A	6-13x	ZG329587	4-31		
BC329595B	5-2x	ET200505	2-TR1	SE331934B	6-14x	ZG329667A	4-42		
BMM302A000A	4-1	ET200505	2-TR2	SK329600A	6-3	ZSB329743	4-45		
BM328792	4-61	ET200505	2-TR4, 5	SK329600B	6-4x	ZSB329750	4-56		
BT328782	4-75	ET200505	2-TR12	SK329603A	6-5	ZS244912	4-72x		
BT328783	4-76x	ET200505	2-TR14, 15	SK329603B	6-6x	ZS305246	4-26		
BT328784	4-77x	ET200505	2-TR19to21	SK329632A	6-1	ZS306488	6-22x		
BT328785	4-78x	ET200505	2-TR23,24	SK329632B	6-2x	ZS322402	4-5		
EC314688	2-C32	ET200505	2-TR26to28	SK329634	4-96	ZS325495	4-50		
EC320548	2-C32	ET200505	2-TR30	SK329636A	6-7	ZS325495	5-24		
EC325671	2-C32	ET200505	2-TR34	SK329636B	6-8x	ZS325503	4-8		
ED308952	2-D1	ET200505	2-TR37	SP329641	4-3	ZS325503	5-14		
ED313284	2-D1	ET200505	2-TR40	SZ329630B	5-13	ZS329979	5-30		
ED322238	2D15 to 17	ET200505	2TR43,44	TPB320745	5-34	ZS329988	4-63		
ED322772	3-D1 to 5	ET200505	2-TR2	TPB329869	4-28	ZS329989	4-53		
ED322772	3-D7	ET200505	2-TR4	TPB329885A	4-29	ZS329990	4-49		
ED322773	3-D6	ET200505	2TR17,18	TPB329885B	4-30x	ZS331988	4-107x		
ED560913	1-D2	ET200505	2-TR24	TPB329897	4-32	ZS332788	6-27x		
ED560913	2-D5, 6	ET200505	2-TR1to3	TP328793	4-14	ZS356804	4-25		
ED560913	2-D2 to 5	ET200505	3-TR1	TP328894	4-35	ZS379350	5-29		
EF258344	4-104x	ET200558	2-TR1	TP329217	4-16x	ZS391476	4-95x		
EF306088	4-101x	ET200558	2-TR35,36	TP329306	5-32	ZS413201	4-46		
EF306125	4-98	ET200558	2-TR6	TP329307A	5-32	ZS414033	4-69		
EF308847	4-102x	ET200558	2-TR10,11	TP329307B	5-33x	ZS417150	4-55		
EF309388	4-97	ET200558	2-TR13	TP329470A	4-57	ZS422076	4-21		
EF309391	4-100x	ET200558	2-TR16	TP329470B	4-58	ZS424056	4-79		
EF311839	4-99	ET200558	2-TR22	TP329538	4-62	ZS447840	4-48x		
EF601964	4-106x	ET200558	2-TR25	TP329554	4-18	ZS455207	4-64x		
EF695766	4-103x	ET200558	2-TR9	TP329555	4-20	ZS462802	4-59		
EF695766	4-105x	ET200558	2-TR31	TP329577A	5-20	ZS482736	4-52		
EI201940	2-IC1	ET200558	2-TR33	TP329577B	5-21x	ZS483502	4-19		
EI211390	2-IC1	ET200558	2-TR38,39	TP329582A	5-22	ZS608095	4-71		
EI213390	2-IC5	ET200558	2-TR3	TP329582B	5-23x	ZS608174	4-65x		
EI213390	2-IC9, 10	ET200558	2-TR5, 6	TP329584A	5-27	ZS608332	4-22		
EI306726	2-IC2	ET200558	2-TR21	TP329584B	5-28x	ZW259503	4-66x		
EI306727	2-IC3	ET200558	3-TR2to7	TP329586C	5-25	ZW260111	4-54		
EI310043	2-IC8	ET307349	2-TR25	TP329586D	5-26x	ZW270123	4-11		
EI310043	3-IC1	ET321016	2-TR9	TP329589A	4-89	ZW329651	4-43		
EI322599	2-IC4, 5	ET323348	2-TR8	TP329589B	4-90	ZW329991	3-2		
EI322599	2-IC2	ET323366	2-TR7	TP329591A	6-11	ZW332727	4-13		
EI323231	2-X1	ET328844	2-TR17	TP329591B	6-12x	ZW413188	4-80		
EI325557	2-IC4	ET328861	2-TR18	TP329598C	5-16	ZW550642	4-9		
EI328241	4-2x	ET328889	2-PH1	TP329598D	5-17x	ZW653163	4-33		
EI328789	3-IC2	ET328889	2-PH1	TP329648	4-7				
EI328790	3-IC3	ET330162	2-TR1	TP329649	4-10				
EI328796	2-IC12	ET666404	2-TR7to9	TP329650	4-12				
EI328796	2-IC14	ET666415	2-TR10to12	TP329652	4-44				
EI328798	2-IC13	EW317580	2-VR1, 2	TP329663A	5-18x				
EI328799	2-X1	EW317580	2-VR1	TP329663B	5-19x				
EI328812	2-IC3	EW520806	2-VR2	TP329973A	5-11				
EI331660	2-IC1, 2	EW201515	4-88x	TP329973B	5-12x				
EJ306822	2-P1, 2	EW305691	4-85x	TP329984	4-47				
EJ312099	2-11	EW306427	4-84x	TP331935A	6-15				
EJ318260	2-P6	EW306428	4-83	TP331935B	6-16x				
EJ318261	2-P5	EW313882	4-86x	TP331936A	6-17				
EJ318366	2-P3	EW313884	4-87x	TP331936B	6-18x				
EP322437	2-RL1	EW326740	4-81	TP331937A	6-19				
EP318248	2-FR1, 2	EW328781	4-82x	TP331937B	6-20x				
ES305733	4-74	MB329540	4-73	TP332399	4-60				
ES308929	2-SW1	PW329557	4-23	TP332786A	6-23x				
ES308929	2-SW1	PW329558	4-24	TP332786B	6-24x				
ES308929	2-SW1	SA329647	4-6	TP332787A	6-25x				

2. MODEL AP-L95/C

PARTS NO. REF. NO.	PARTS NO. REF. NO.	PARTS NO. REF. NO.	PARTS NO. REF. NO.	PARTS NO. REF. NO.
BAP1015A060F 2-1	EJ318260 2-P6	ET307349 2-TR25	TP329538 4-62	ZS421740 4-94
BAP1015A060G 2-2	EJ318261 2-P5	ET321016 2-TR9	TP329554 4-18	ZS422076 4-21
BAP1015A060H 2-3	EJ318263 2-P4	ET321016 2-TR45	TP329555 4-20	ZS424056 4-79
BAP1015A060J 2-4	EP323437 2-RL1	ET323348 2-TR5	TP329577A 5-20	ZS447840 4-48
BAP1015A060K 2-5	ER309816 2-RL18	ET323366 2-TR7	TP329577B 5-21x	ZS455207 4-64x
BAP1016A040A 3-1	ER318248 2-FR1, 2	ET328844 2-TR17	TP329582A 5-22	ZS462802 5-22
BC329590A 6-13	ER318323 2-R1	ET328861 2-TR18	TP329582B 5-23x	ZS482736 4-52
BC329590B 6-14x	ER329279 2-R13	ET328889 2-PH1	TP329584A 5-27	ZS483502 4-19
BC329595A 5-1	ER329280 2-R2	ET328889 2-PH1	TP329584B 5-28x	ZS592378 4-67
BC329595B 5-2x	ER329282 2-R3	ET330162 2-TR1	TP329586A 5-25	ZS608095 4-71
BMM302A00A 4-1	ES305733 4-74	ET666404 2-TR7to9	TP329586B 5-26x	ZS608174 4-65x
BM328792 4-61	ES308929 2-SW1	ET666425 2-TR10to12	TP329589A 4-89	ZS608332 4-22
BT328782 4-75	ES308929 2-SW1	EV317580 2-VR1	TP329589B 4-90	ZW259503 4-66x
BT328783 4-76x	ES308929 2-SW1	EV317580 2-VR1,2	TP329591A 6-15	ZW260111 4-54
BT328784 4-77x	ES309920 4-70	EV329215 2-VR1	TP329591B 6-16x	ZW270123 4-11
BT328785 4-78x	ES328777 3-SW106	EV520806 2-VR2	TP329598A 5-17	ZW329651 4-43
BZP1016A050A 4-40	ES328777 3SW19,20	EW201515 4-88x	TP329598B 5-18x	ZW329991 3-2
BZP1016A050B 4-41x	ES328777 3-SW104	EW305691 4-85x	TP329629A 5-11	ZW332727 4-13
EC313826 2-C21	ES328778 3-SW17,18	EW306427 4-84x	TP329629B 5-12x	ZW413188 4-80
EC314688 2-C32	ES328779 3-SW1,2	EW306428 4-83	TP329642 4-4	ZW550642 4-9
EC316569 2-C33	ES328786 4-37	EW308922 2-RL16	TP329648 4-7	ZW653163 4-33
EC317420 2-C26	ES328787 4-38x	EW313882 4-86x	TP329649 4-10	
EC320548 2-C32	ES328788 4-39x	EW313884 4-87x	TP329650 4-12	
EC325671 2-C32	ES329027 2-SW1	EW326740 4-81	TP329652 4-44	
EC601132 2-C16to18	ES573478 4-51	EW-328781 4-82x	TP329663B 5-19x	
ED308952 2-D1	ET200505 2-TR2	MB329540 4-73	TP329983 4-60	
ED313284 2-D1	ET200505 2-TR4, 5	PW329557 4-23	TP329984 4-47	
ED316143 2-D7, 8	ET200505 2-TR12	PW329558 4-24	TP331937A 6-19	
ED322238 2-D15 to 17	ET200505 2-TR14, 15	SA329647 4-6	TP331935B 2-20x	
ED322772 3-D1 to 24	ET200505 2-TR19to21	SE329599A 5-15	TP331936A 6-21	
ED322773 3-D30	ET200505 2-TR23,24	SE329599B 5-16x	TP331936B 6-22x	
ED328791 3-D2to29	ET200505 2-TR26to28	SE329625A 5-3x	TP331937A 6-23	
ED560913 2-D2to6	ET200505 2-TR30	SE329625B 5-4x	TP331937B 6-24x	
ED560913 2-D9to14	ET200505 2-TR32	SE329631A 5-7x	TP332786A 6-27x	
ED560913 2-D2to14	ET200505 2-TR34	SE329631B 5-8x	TP332786B 6-28x	
EF258344 4-104x	ET200505 2-TR37	SE329631C 5-9x	TP332787A 6-29x	
EF306088 4-101x	ET200505 2-TR40	SE329631D 5-10x	TP332787B 6-30x	
EF306125 4-98	ET200505 2-TR43,44	SE329639A 5-5x	TP780013 4-15	
EF308847 4-102x	ET200505 2-TR46,47	SE329639B 5-6x	TP780014 4-17x	
EF309388 4-97	ET200505 2-TR49,50	SE331934A 6-17x	ZG313029 4-34	
EF309391 4-100x	ET200505 2-TR2	SE331934B 6-18x	ZG313042 4-36	
EF311839 4-99	ET200505 2-TR4	SK329600A 6-3	ZG313085 4-91	
EF601964 4-106x	ET200505 2-TR14,15	SK329600B 6-4x	ZG313172 6-25x	
EF695766 4-103x	ET200505 2-TR17to20	SK329603A 6-5	ZG313178 4-27x	
EF695766 4-105x	ET200505 2-TR24	SK329603B 6-6x	ZG329587 4-31	
FI201940 2-C1	ET200505 2-TR1to3	SK329614A 6-7	ZG329667A 4-42	
EI213390 2-1C1	ET200505 2-TR1to3	SK329614B 6-8x	ZG330033 4-93	
EI213390 2-1C5	ET200505 3-TR2	SK329632A 6-1	ZSB329743 4-45	
EI213390 2-1C1, 10	ET200558 2-TR1	SK329632B 6-2x	ZSB329750 4-56	
EI306726 2-1C2	ET200558 2-TR3	SK329634 4-96	ZS244912 4-72x	
EI306727 2-1C3	ET200558 2-TR6	SK329636A 6-11	ZS305246 4-26	
EI310043 2-1C8	ET200558 2-TR10,11	SK329636B 6-12x	ZS306488 6-26x	
EI310043 3-1C1, 2	ET200558 2-TR13	SK329640A 6-9	ZS322402 4-5	
EI322599 2-1C4, 5	ET200558 2-TR16	SK329640B 6-10x	ZS325495 4-50	
EI322599 2-1C2	ET200558 2-TR22	SK329665 4-68	ZS325495 5-24	
EI323231 2-1	ET200558 2-TR25	SP329641 4-3	ZS325503 4-8	
EI324256 2-1C6	ET200558 2-TR29	SZ329630A 5-13	ZS325503 5-14	
EI324682 2-1C7	ET200558 2-TR31	TPB320745 5-34	ZS329569 4-92	
EI32557 2-1C4	ET200558 2-TR35, 6	TPB329689 4-28	ZS329979 4-36	
EI328241 4-2x	ET200558 2-TR35,36	TPB329885A 4-29	ZS329988 4-63	
EI328795 2-1C6	ET200558 2-TR38,39	TPB329885B 4-30x	ZS329989 4-53	
EI328796 2-1C12	ET200558 2-TR41,42	TPB329897 4-32	ZS329990 4-49	
EI328796 2-1C14	ET200558 2-TR48	TP328793 4-14	ZS331988 4-107x	
EI328798 2-1C13	ET200558 2-TR3	TP328894 4-35	ZS332788 6-31x	
EI328799 2-1X1	ET200558 2-TR5, 6	TP329217 4-16x	ZS336804 4-26	
EI328812 2-1C3	ET200558 2-TR13	TP329306 5-32	ZS379350 5-29	
EI331660 2-1C1, 2	ET200558 2-TR16	TP329307A 5-32	ZS391476 4-95x	
EJ306822 2-P1to3	ET200558 3-TR2to23	TP329307B 5-33x	ZS413201 4-46	
EJ312099 2-1	ET200558 3-TR1	TP329470A 4-57	ZS414033 4-69	
EJ318259 2-P7	ET200558 3-TR3to6	TP329470B 4-58	ZS417150 4-55	



## SECTION 3

## SCHEMATIC DIAGRAM

1. SCHEMATIC DIAGRAM OF ICs
2. AP-L45/C No. 3-1 1621430A SYSCON SCHEMATIC DIAGRAM
3. AP-L45/C No. 3-2 1621431A POWER & SERVO SCHEMATIC DIAGRAM
4. AP-L45/C No. 3-3 1621432A PANEL SCHEMATIC DIAGRAM
5. AP-L95/C No. 3-1 1621433A SYSCON SCHEMATIC DIAGRAM
6. AP-L95/C No. 3-2 1621434A POWER & SERVO SCHEMATIC DIAGRAM
7. AP-L95/C No. 3-3 1621435A PANEL SCHEMATIC DIAGRAM

AP-400A

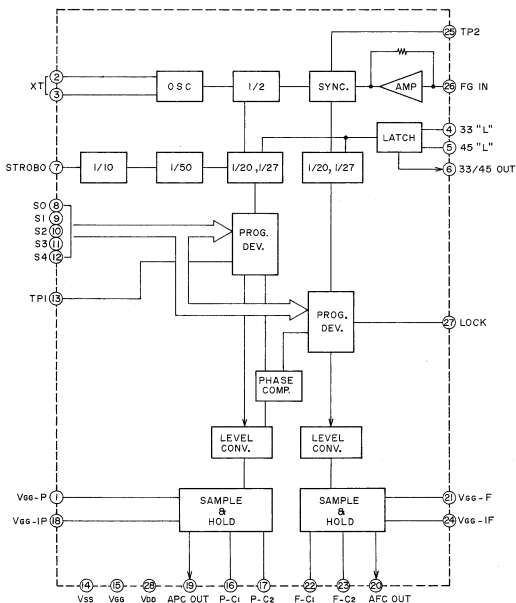

MB8841-349M

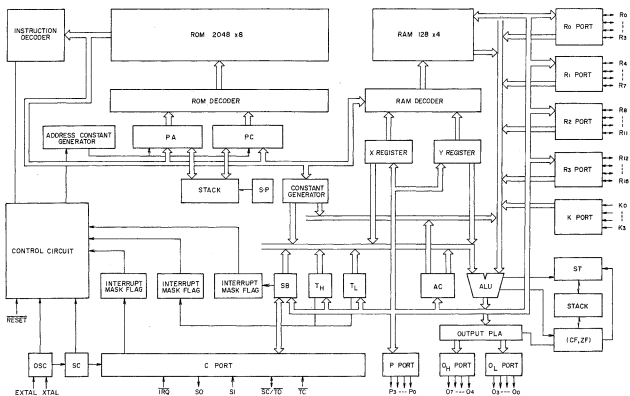

NJM4558D

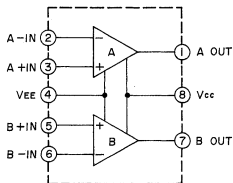

SN 7417N

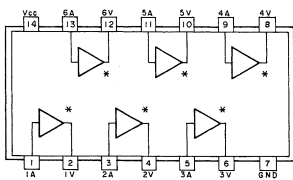

\* OPEN COLLECTOR

SN74LS03N

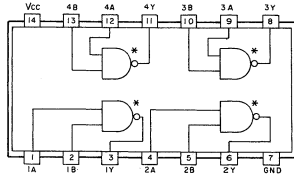

\* OPEN COLLECTOR

SN 74LS 109AN

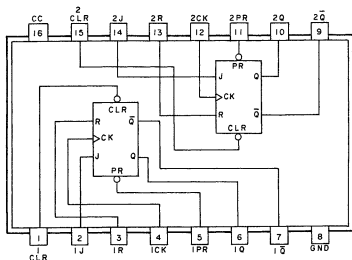

NJM4558S  
TA75458S

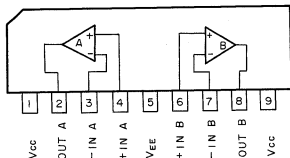

TC4013BP

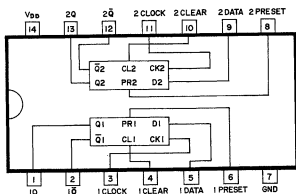

TC4024BPC

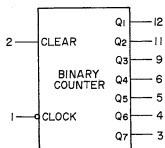

V<sub>DD</sub> : 14  
V<sub>SS</sub> : 7  
NC : 8,10,13

CLOCK Δ	CLEAR	OUTPUT STATE
※	H	ALL OUTPUTS="L"
⏏	L	NO CHANGE
⏏	L	ADVANCE TO NEXT STATE

Δ: LEVEL CHANGE, ※: DON'T CARE

TC4027BP

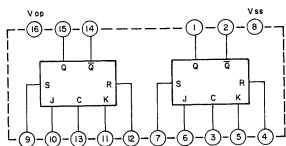

TC4069UBP

TL081CP

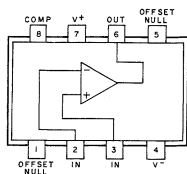
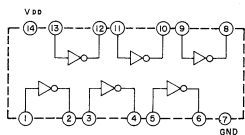

$\mu$ PC78M05H  
 $\mu$ PC78M12H

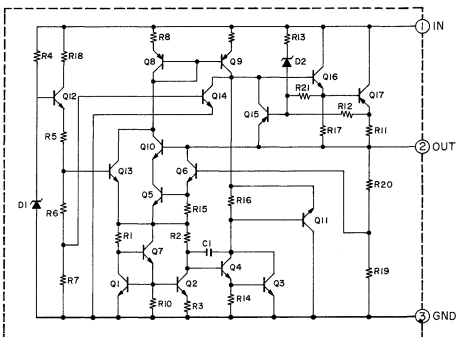
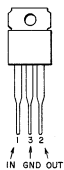





AP-L45/C

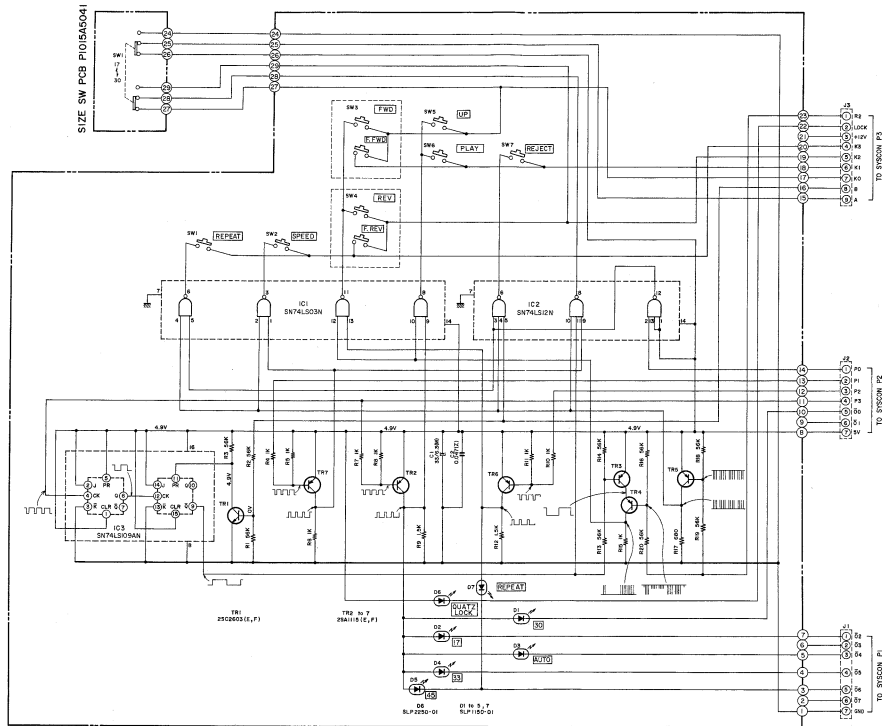

MAIN PANEL PCB P1015A5040

VOLTAGE MEASURED MODE  
OPERATION SWITCH : NOT DEPRESS  
LIT LED : AUTO 30, 33 (01, 03, 04)

NOTE  
UNLESS OTHERWISE SPECIFIED  
ALL RESISTORS IN OHMS (K=K, M=M)  
ALL CAPACITORS IN PF (50WV/2)

AP-L45/C PANEL  
SCHEMATIC DIAGRAM  
NO. 3-3 1621432A



28A115  
2SC6083







AP-L95/C

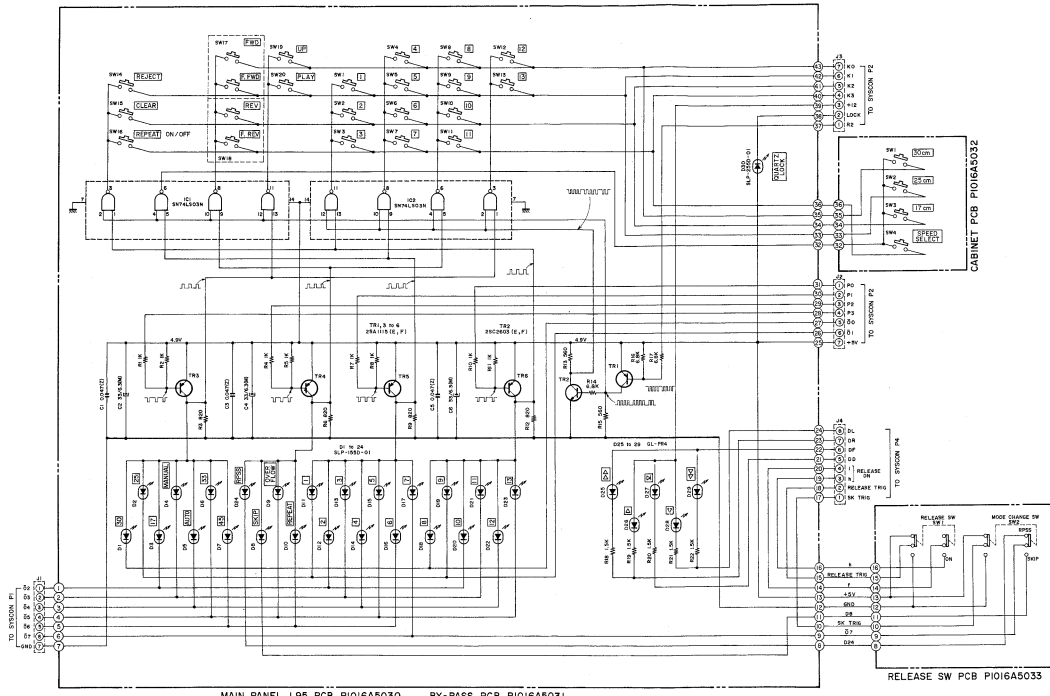

MAIN PANEL L95 PCB P1016A5030 BY-PASS PCB P1016A5031

RELEASE SW PCB P1016A5033



28A1115  
28C2403

VOLTAGE MEASURED MODE  
OPERATION SWITCH : NOT DEPRESS  
LIT LED : AUTO IODS

NOTE  
UNLESS OTHERWISE SPECIFIED  
ALL RESISTORS IN OHMS (UNLESS  
ALL CAPACITORS IN μF 50WV/10)

AP-L95/C PANEL  
SCHEMATIC DIAGRAM  
NO.3-3 1621435A