

SERVICE MANUAL

PARTS LIST

MODEL AT-2450
AM-2450

AKAI

ALSO APPLICABLE TO BLACK PANEL MODEL

MC-Service

AT-2450
AM-2450

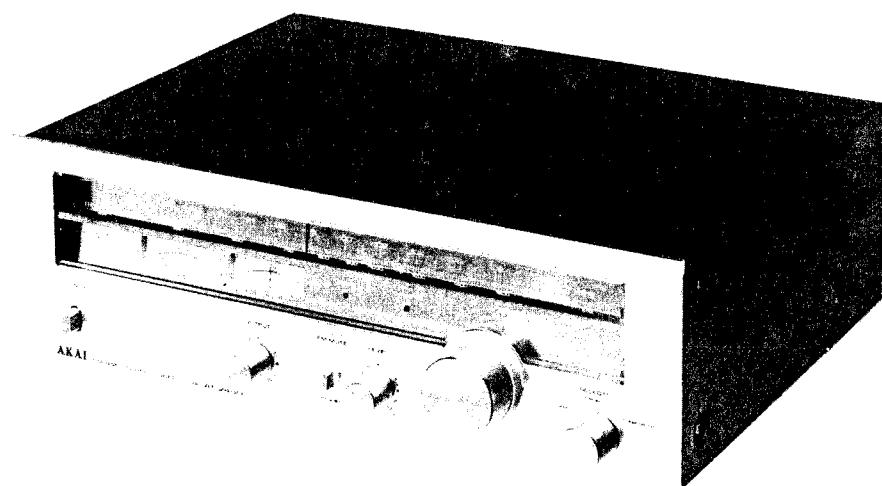

AT-2450

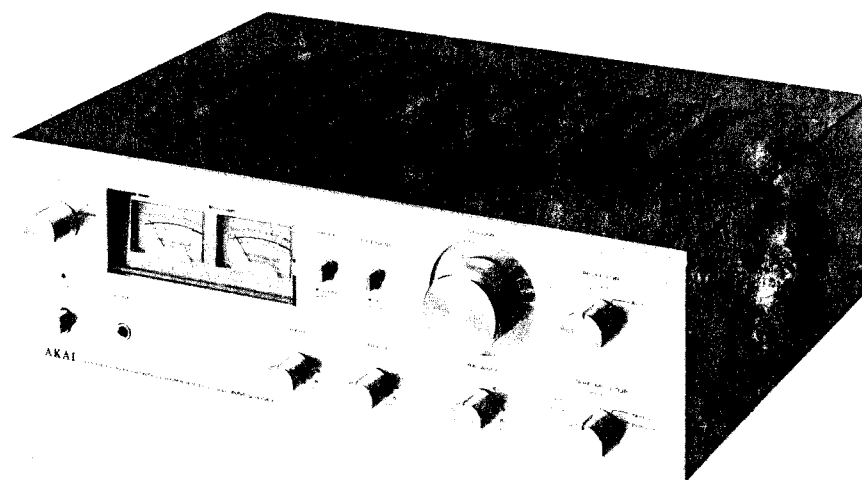

AM-2450

AKAI STEREO TUNER AND STEREO INTEGRATED AMPLIFIER

MODEL **AT-2450 AM-2450**

ALSO APPLICABLE TO BLACK PANEL MODEL

SECTION 1	SERVICE MANUAL	1
SECTION 2	PARTS LIST	33
SECTION 3	SCHEMATIC DIAGRAM	48

SECTION 1

SERVICE MANUAL

TABLE OF CONTENTS

I.	TECHNICAL DATA	2
	1. MODEL AT-2450	2
	2. MODEL AM-2450	3
II.	DISMANTLING OF UNIT	4
	1. MODEL AT-2450	4
	2. MODEL AM-2450	5
III.	CONTROLS	6
	1. MODEL AT-2450	6
	2. MODEL AM-2450	7
IV.	PRINCIPAL PARTS LOCATION	8
	1. MODEL AT-2450	8
	2. MODEL AM-2450	9
V.	OPERATING PRINCIPLES OF QUADRATURE DETECTION SYSTEM	10
VI.	OPERATING PRINCIPLES OF PLL CIRCUIT EMPLOYED IN STEREO DEMODULATION CIRCUIT	12
	1. PLL CIRCUIT OPERATION	12
	2. STEREO DEMODULATION CIRCUIT	13
VII.	LEVEL DIAGRAM	15
VIII.	TUNER ADJUSTMENT (AT-2450)	16
	1. FM TUNER SECTION ADJUSTMENT	17
	2. AM TUNER SECTION ADJUSTMENT	18
IX.	AMPLIFIER ADJUSTMENT (AM-2450)	19
	1. IDLING CURRENT ADJUSTMENT	19
	2. LEVEL METER INDICATION ADJUSTMENT	20
X.	TUNING CORD THREADING	21
XI.	CLASSIFICATION OF VARIOUS P.C BOARDS	22
	1. P.C BOARD TITLE AND IDENTIFICATION NUMBER	22
	2. MODEL AT-2450 COMPOSITION OF VARIOUS P.C BOARDS	23
	3. MODEL AM-2450 COMPOSITION OF VARIOUS P.C BOARDS	26

For basic adjustments, measuring methods, and operating principles, refer to GENERAL TECHNICAL MANUAL.

I. TECHNICAL DATA

1. MODEL AT-2450

FM TUNER SECTION

FREQUENCY RANGE		87.5 MHz to 108 MHz
SENSITIVITY (IHF)		1.7 μ V
CAPTURE RATIO		1.2 dB
SELECTIVITY (IHF)		More than 80 dB
IMAGE REJECTION		More than 90 dB (98 MHz)
IF REJECTION		More than 100 dB (98 MHz)
SPURIOUS REJECTION		More than 100 dB (98 MHz)
AM SUPPRESSION		55 dB
SIGNAL TO NOISE RATIO		75 dB
HARMONIC DISTORTION	MONO	Less than 0.15% (100% modulation)
	STEREO	Less than 0.2% (100% modulation)
FM STEREO FREQUENCY RESPONSE		20 Hz to 15 kHz +1/-3 dB
MUTING		Level Control (1 μ V to 100 μ V)
STEREO SEPARATION		More than 45 dB (1 kHz)
SUB CARRIER SUPPRESSION		More than 65 dB
OUTPUT VOLTAGE		Controllable from 0 to 2V (100% modulation)
ANTENNA INPUT IMPEDANCE		300 ohms balanced, 75 ohms unbalanced

AM TUNER SECTION

FREQUENCY RANGE		520 kHz to 1,605 kHz
SENSITIVITY (IHF)		100 μ V/m (bar antenna), 15 μ V (external antenna)
SELECTIVITY (IHF)		More than 30 dB
IMAGE REJECTION		More than 50 dB (1,000 kHz)
IF REJECTION		More than 40 dB
SIGNAL TO NOISE RATIO		More than 55 dB
OUTPUT VOLTAGE		Controllable from 0 to 2V
ANTENNA		Built-in ferrite bar antenna

MISCELLANEOUS

SEMICONDUCTORS		Transistors: 9, Diodes: 14, FET: 1, ICs: 4
POWER REQUIREMENTS		120 V, 60 Hz for U.S.A. and Canada
		220 V, 50 Hz for Europe
		240 V, 50 Hz for UK
		110/220/240 V, 50/60 Hz Switchable for other countries
DIMENSIONS		440 (W) x 144 (H) x 368 (D) mm (17.3 x 5.7 x 14.5) inches
WEIGHT		7.3 kg (16.1 lbs)

* For improvement purposes, specifications and design are subject to change without notice.

2. MODEL AM-2450

POWER AMPLIFIER SECTION

RATED OUTPUT POWER	2-CHANNELS DRIVEN	45 watts per channel, minimum RMS, at 8 ohms from 20 to 20,000 Hz with no more than 0.1% total harmonic distortion.
POWER BANDWIDTH (IHF)		6 Hz to 60 kHz/8 ohms (Total Harmonic Distortion: 0.1%)
SIGNAL TO NOISE RATIO (IHF)	PHONO AUX	Better than 75 dB Better than 95 dB
RESIDUAL NOISE		Less than 0.5 mV at 8 ohms
CHANNEL SEPARATION (IHF)	PHONO	Better than 55 dB at 1,000 Hz
DAMPING FACTOR		More than 30 (1 kHz, 8 ohms)
OUTPUT	SPEAKERS HEADPHONE	A, B (4 to 16 ohms)/A + B (8 to 16 ohms) 4 to 16 ohms

PREAMPLIFIER SECTION

INPUT SENSITIVITY/IMPEDANCE	PHONO AUX TUNER TAPE MONITOR	3 mV/47 kohms 150 mV/100 kohms 150 mV/100 kohms PIN: 150 mV/100 kohms DIN: 150 mV/100 kohms
OUTPUT LEVEL/IMPEDANCE	TAPE REC	PIN: 150 mV/1 kohms DIN: 30 mV/80 kohms
FREQUENCY RESPONSE	PHONO (RIAA EQUALIZATION) TUNER, AUX, TAPE MONITOR	30 Hz to 15 kHz +1 dB, -1 dB 10 Hz to 60 kHz +1 dB, -1 dB
TONE CONTROL	BASS TREBLE	±9 dB at 100 Hz ±9 dB at 10 kHz
LOUDNESS CONTROL		+10 dB at 100 Hz, +5 dB at 10 kHz (Volume control set at -30 dB position)
MISCELLANEOUS		
SEMICONDUCTORS		Transistors: 27, Diodes: 17, ICs: 4
POWER REQUIREMENTS		120 V, 60 Hz for U.S.A. and Canada 220 V, 50 Hz for Europe 240 V, 50 Hz for UK 110/220/240 V, 50/60 Hz Switchable for other countries
DIMENSIONS		440 (W) x 144 (H) x 345 (D) mm (17.3 x 5.7 x 13.6 inches)
WEIGHT		9.9 kg (21.8 lbs)

* For improvement purposes, specifications and design are subject to change without notice.

II. DISMANTLING OF UNIT

1. MODEL AT-2450

In case of trouble, etc. necessitating dismantling, please dismantle in the order shown in the photographs. Reassemble in reverse order.

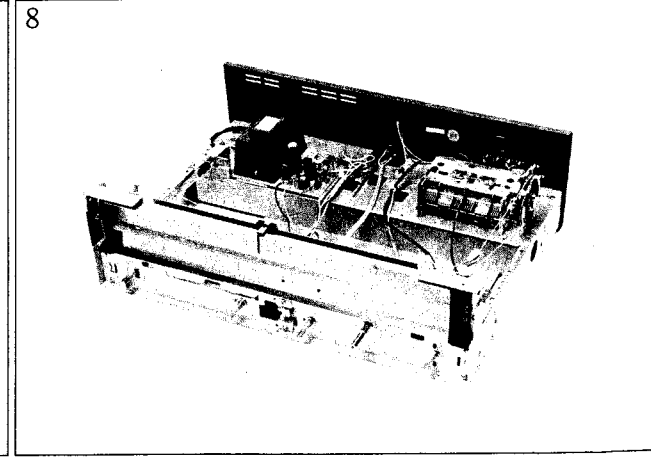
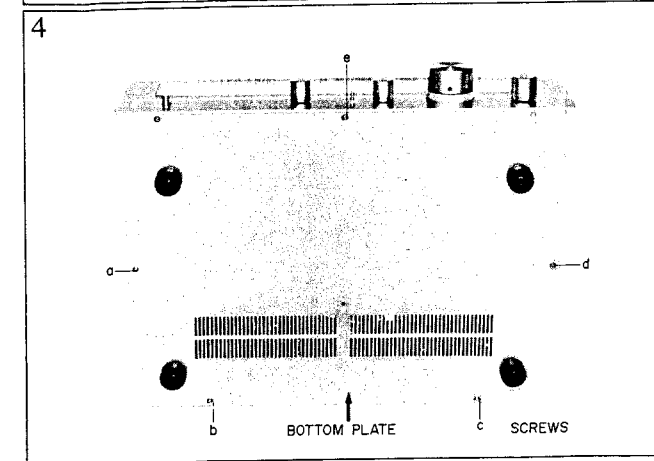
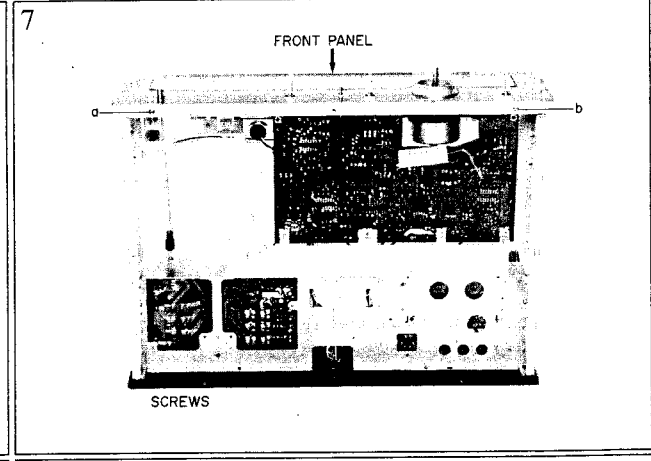
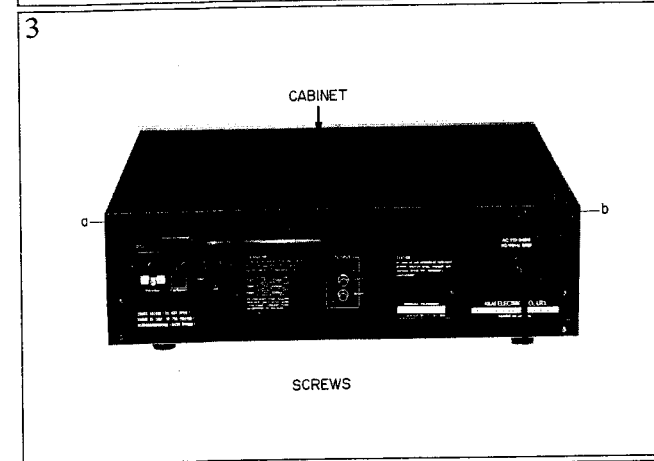
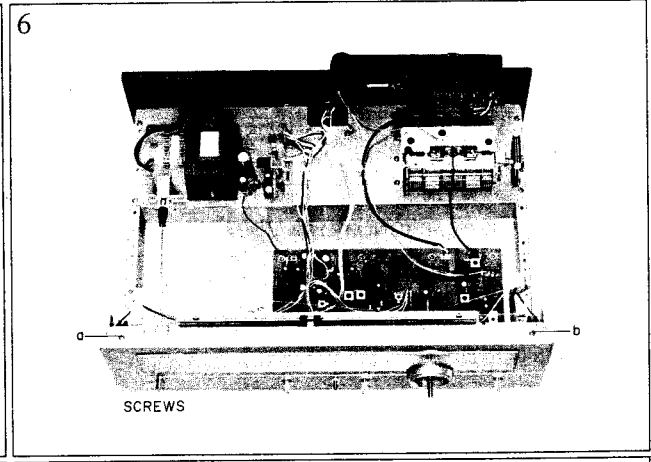
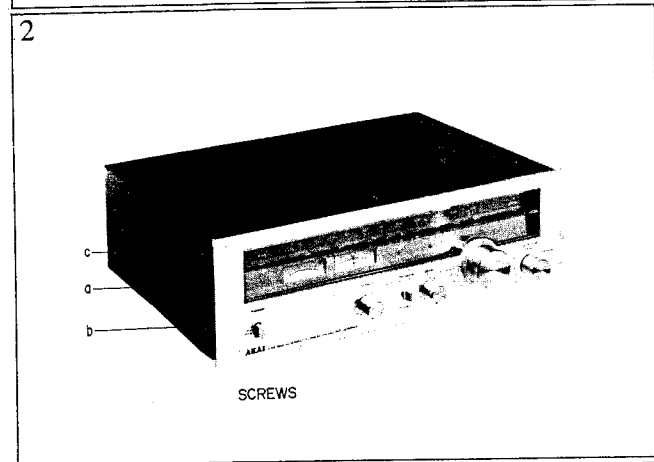
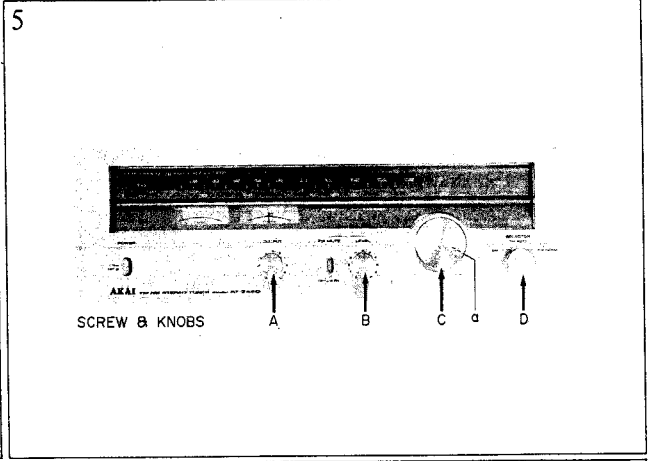
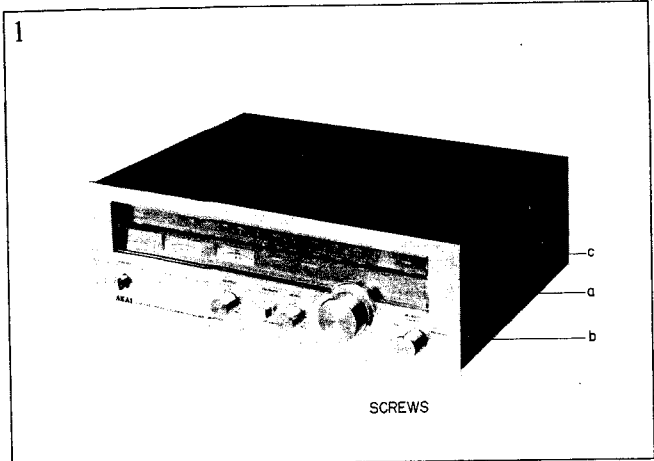

2. MODEL AM-2450

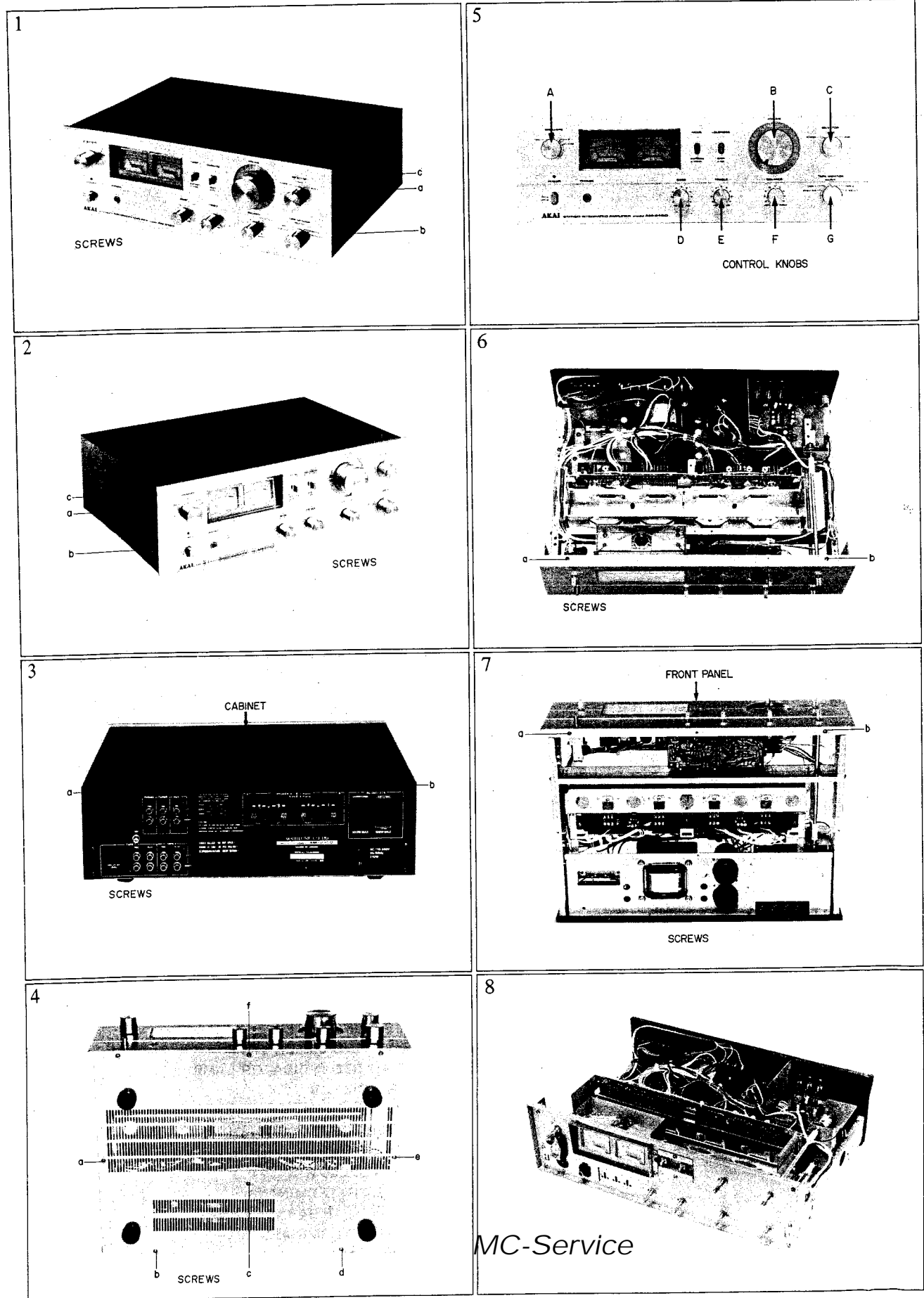

III. CONTROLS

1. MODEL AT-2450

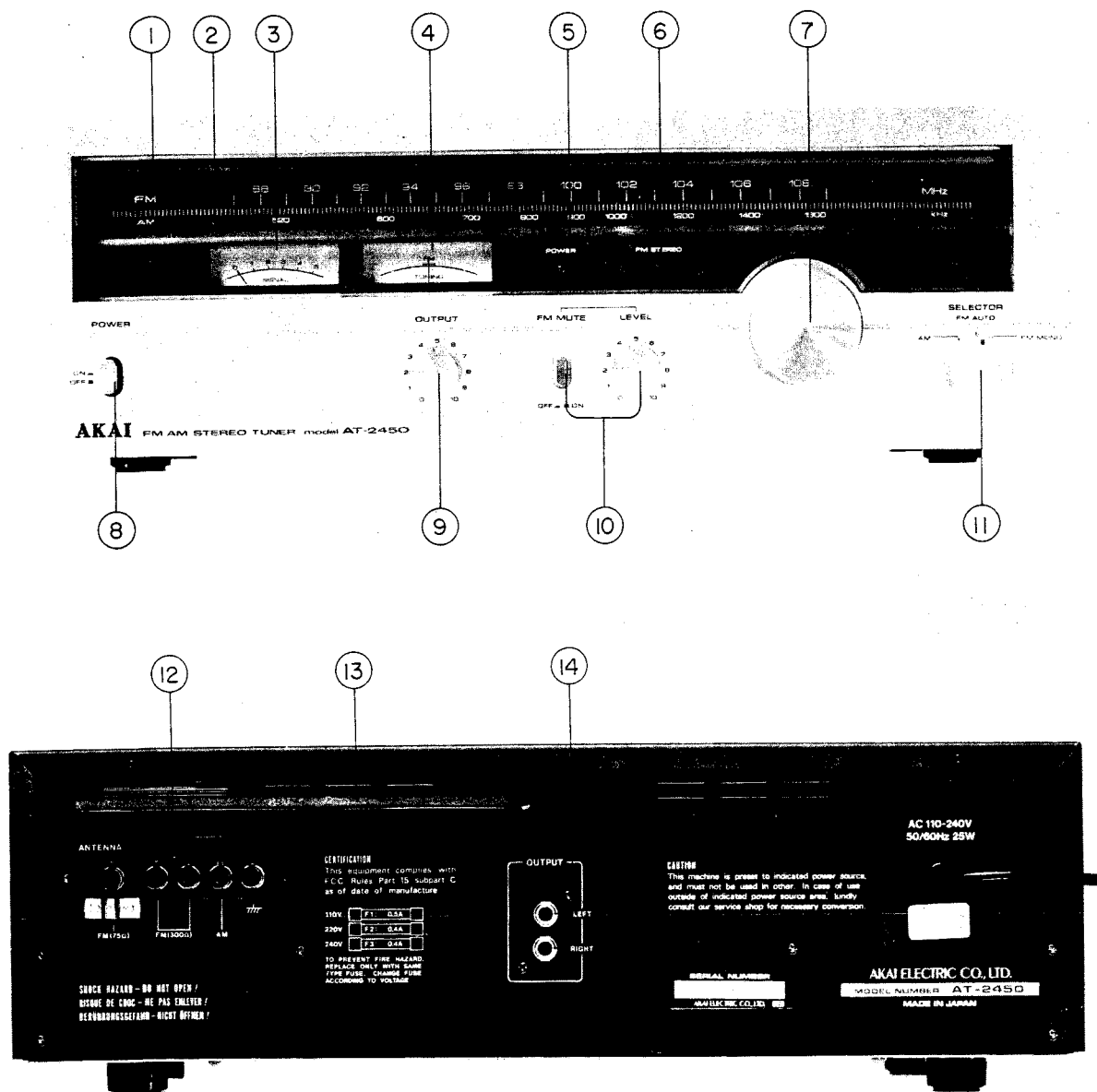

Fig. 1 Controls AT-2450

1. FM DIAL SCALE
2. AM DIAL SCALE
3. SIGNAL STRENGTH METER
4. FM TUNING METER
5. POWER INDICATOR LAMP
6. FM STEREO INDICATOR LAMP
7. TUNING KNOB
8. POWER SWITCH
9. OUTPUT LEVEL CONTROL
10. FM MUTE SWITCH and LEVEL ADJUSTER
11. INPUT SELECTOR
12. ANTENNA TERMINALS
13. AM FERRITE BAR ANTENNA
14. OUTPUT TERMINALS

2. MODEL AM-2450

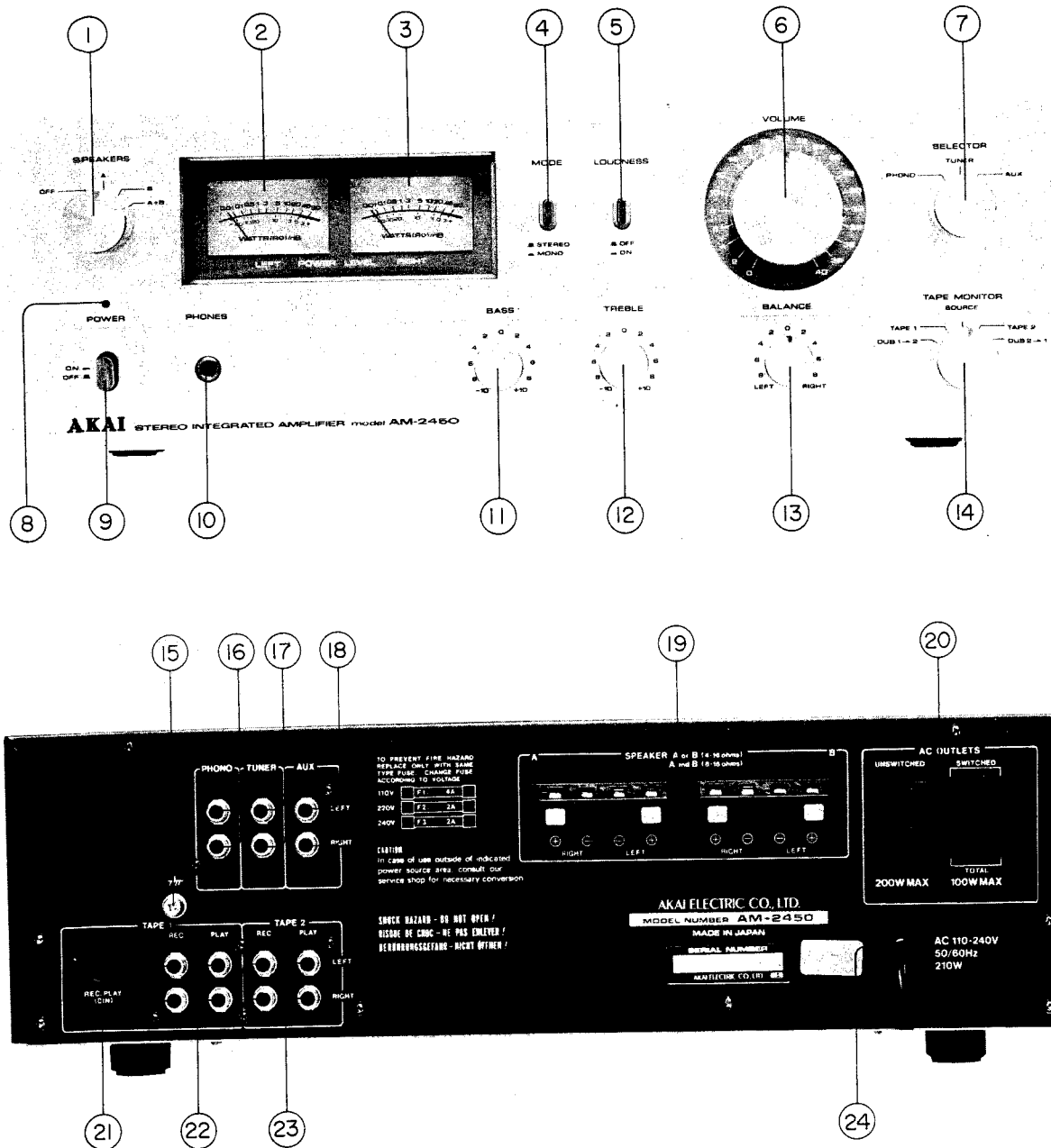

Fig. 2 Controls AM-2450

1. SPEAKER SYSTEM SELECTOR
2. LEFT OUTPUT POWER LEVEL METER
3. RIGHT OUTPUT POWER LEVEL METER
4. MODE SWITCH
5. LOUDNESS SWITCH
6. VOLUME CONTROL
7. INPUT SELECTOR
8. POWER INDICATOR LAMP
9. POWER SWITCH
10. HEADPHONE JACK
11. BASS TONE CONTROL
12. TREBLE TONE CONTROL
13. STEREO BALANCE CONTROL
14. TAPE MONITOR SWITCH

15. GROUND TERMINALS
16. PHONO TERMINALS
17. TUNER TERMINALS
18. AUX TERMINALS
19. A and B SYSTEM SPEAKER TERMINALS
20. EXTRA AC OUTLETS (Some models are not equipped with this facility)
21. TAPE 1 SYSTEM DIN JACK
22. TAPE 1 SYSTEM REC/PB TERMINALS
23. TAPE 2 SYSTEM REC/PB TERMINALS
24. AC CORD (Some models are equipped with an AC Inlet instead of an AC cord. Connect with an appropriate power cord.)

MC-Service

IV. PRINCIPAL PARTS LOCATION

1. MODEL AT-2450

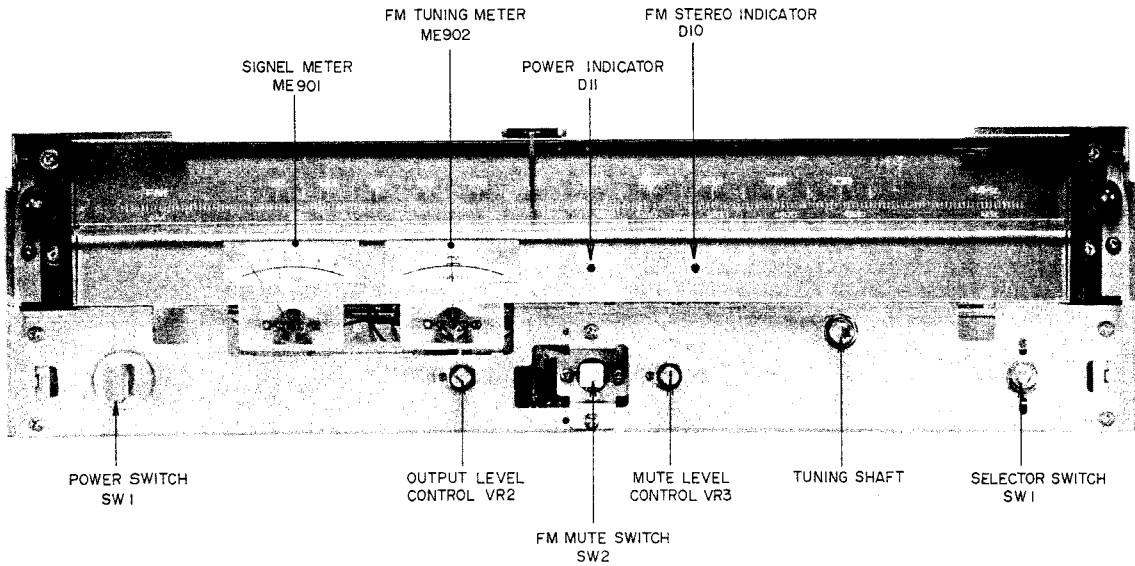

Fig. 3 Front View

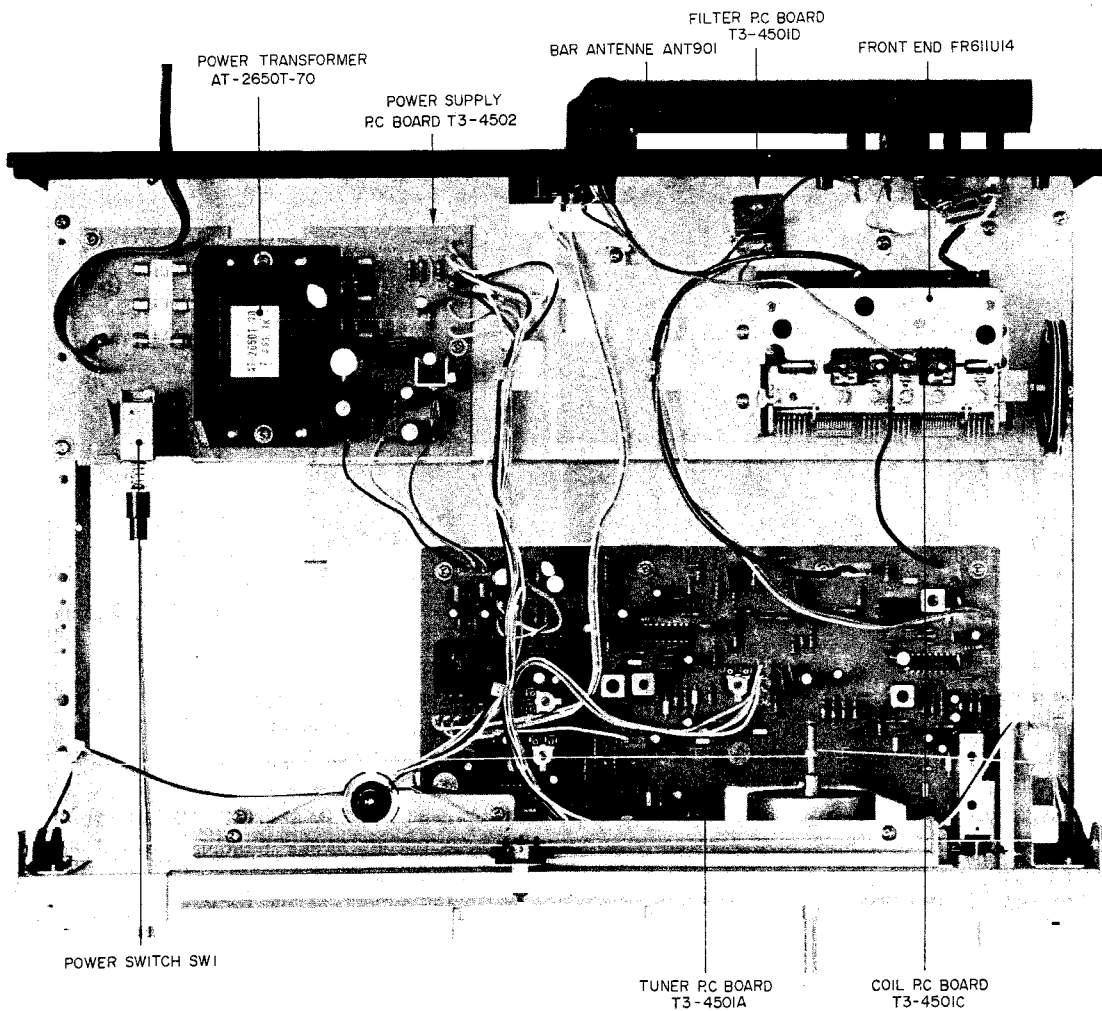

Fig. 4 Top View

2. MODEL AM-2450

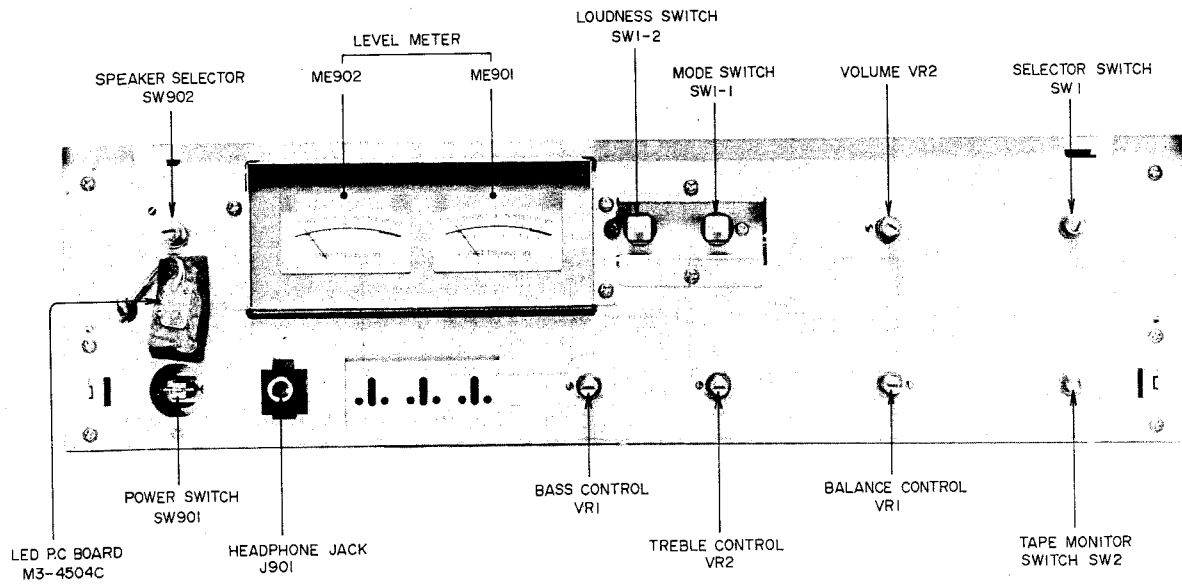

Fig. 5 Front View

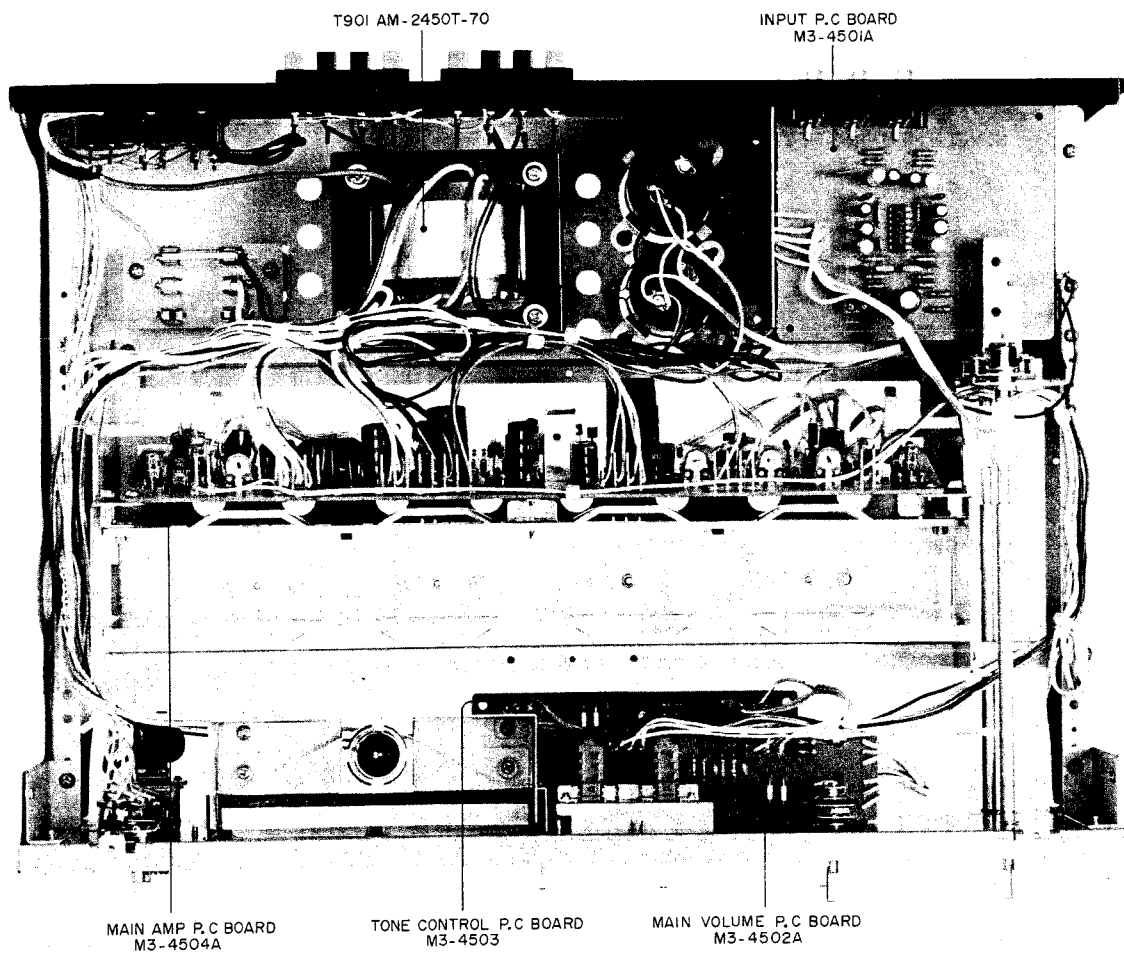

Fig. 6 Top View

MC-Service

V. OPERATING PRINCIPLES OF QUADRATURE SYSTEM

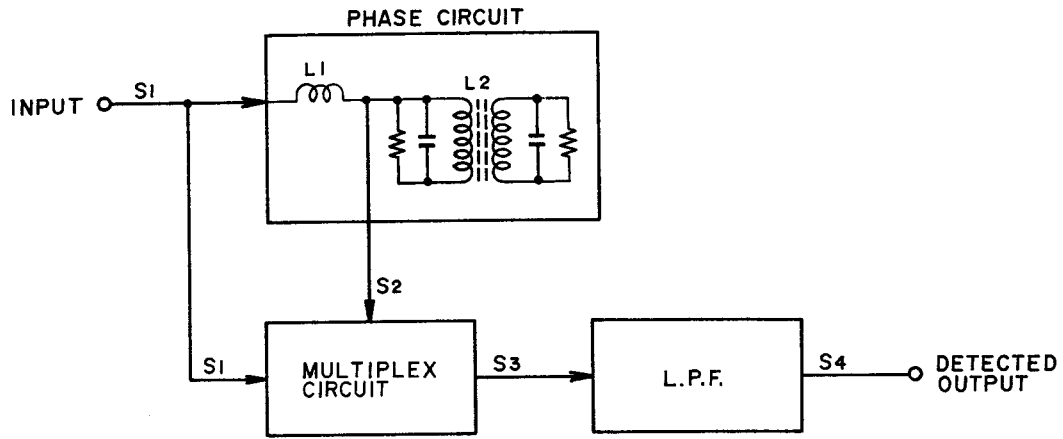

Fig. 7 Quadrature Detection Block Diagram

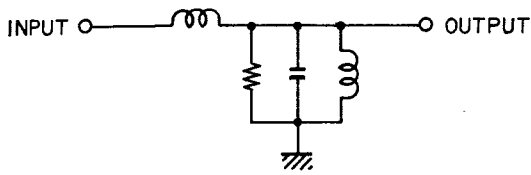

Fig. 8 Single Tuning Type

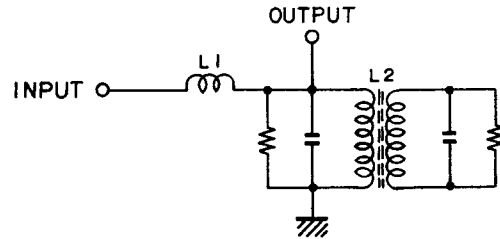

Fig. 9 Double Tuning Type

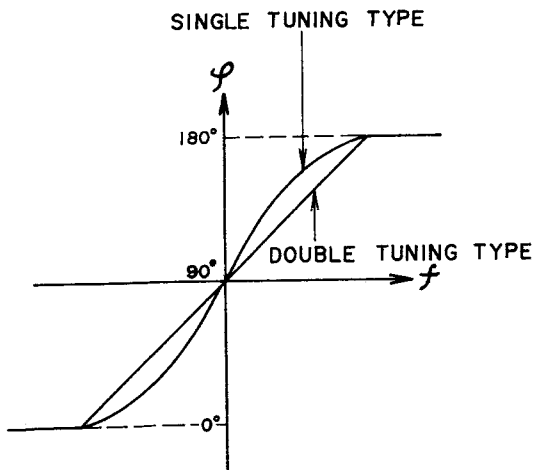

Fig. 10 Tuning Curve

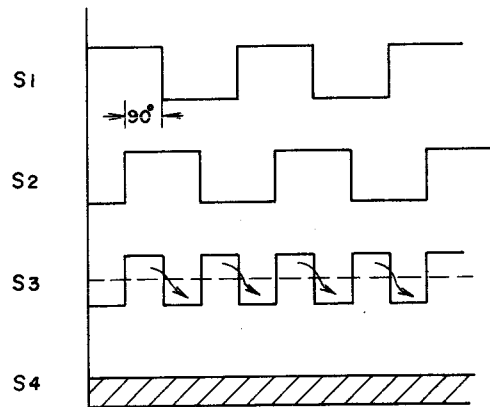

Fig. 11 Output at Non-modulation

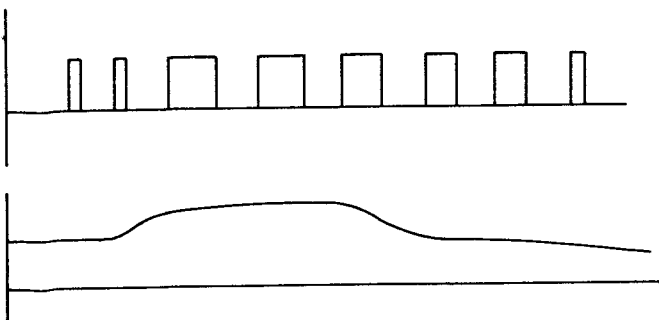

Fig. 12 Output at Modulation Time

The Quadrature Detection Circuit is comprised of a Phase Circuit, a Multiplier Circuit and a Low Pass Filter (L.P.F.) as shown in Fig. 7.

There are two types of Phase Circuits, the Single tuning type shown in Fig. 8 and the Double tuning type shown in Fig. 9. However, because with the double tuning type there is less frequency deviation in relation to carrier frequency, linearity is improved as shown in Fig. 10 and phase distortion is reduced, this type of phase circuit is employed in the AT-2450.

Input signal S1 is divided into the part which enters the direct multiplier circuit and the part which passes the phase circuit and enters the multiplier circuit. The signal supplied to the phase circuit is always 90° phase delayed at L1. Also because at Non-modulation time, L2 is tuned to 10.7 MHz, if modulation is applied and S1 is changed from 10.7 MHz, phase deviation at L2 will take place proportionately in relation to this change part and this becomes S2 signal which is delayed in relation to S1.

At Non-modulation, because as shown in Fig. 11, the input signal S1 and 90° phase delayed (by means of L1) signal S2 are switched by means of the multiplier circuit, the output signal becomes S3.

Because this S3 passes the low pas filter and becomes S4 fixed direct current, the detector output is zero. Then, when modulation is applied, because the switched output is varied according to the degree of modulation, and the output which passed the lowe pass filter becomes the pulsating current part as shown in Fig. 12, detector output is obtained.

VI. OPERATING PRINCIPLES OF PLL CIRCUIT EMPLOYED IN STEREO DEMODULATION CIRCUIT

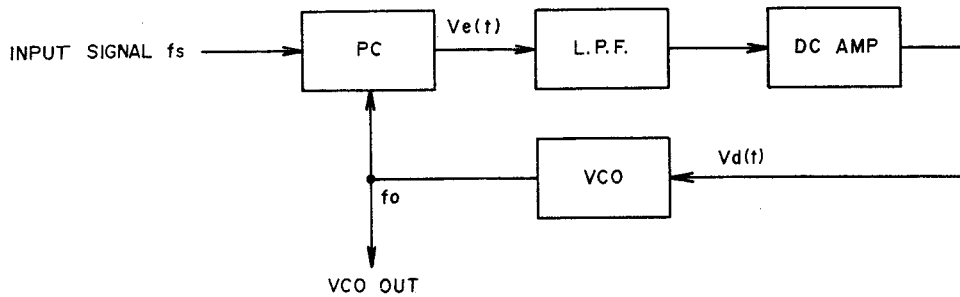

Fig. 13 PLL Circuit

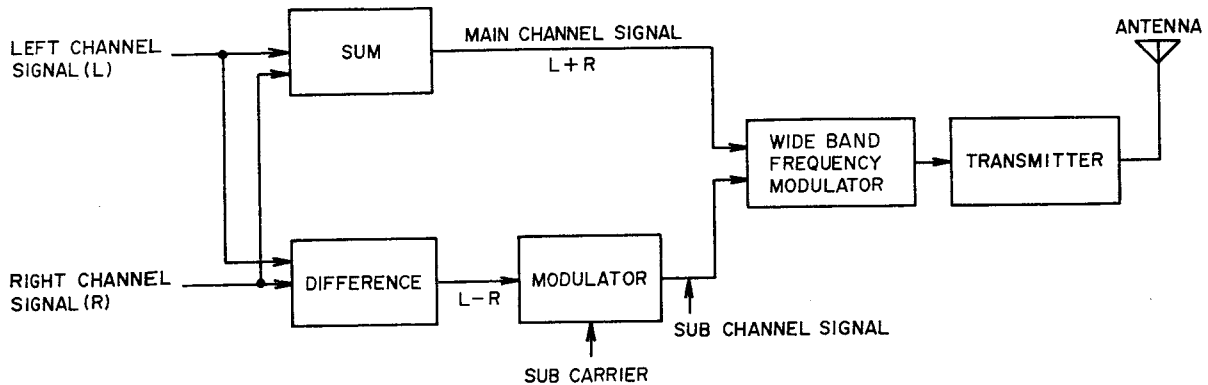

Fig. 14 FM Broadcasting System Diagram

To separate the FM stereo broadcast signal received to date into left and right signals, a 19 kHz pilot signal was successively multiplied to form a 38 kHz signal and stereo separation was effected from this. However, with this multiplier system, change in coils due to wear occurred and adjustment points were numerous, etc. Therefore, this model employs a newly developed PLL circuit which produces an exceedingly accurate 38 kHz switching signal.

1. PLL CIRCUIT OPERATION

PLL circuit is a kind of feedback circuit and is comprised of a Phase Comparator (PC), a Low Pass Filter (LPF), a Direct Current Amplifier (DC Amp) and a Voltage Control Oscillator (VCO) as shown in Fig. 13. The PC compares input signal F_s and VCO oscillator output and generates the difference in signal voltage $V_e(t)$ proportionately to this phase deviation. This $V_e(t)$ passes LPF and the DC Amp and becomes control voltage. This control voltage supplied to VCO and VCO oscillation frequency is DC controlled. When there is no input signal F_s , because there is also no $V_e(t)$, control voltage $V_d(t)$ becomes zero, and VCO maintains a *Free-running oscillation frequency. When a signal enters, VCO oscillation frequency F_o is controlled to narrow the difference between F_s by means of feedback as described above, and the PLL circuit assumes a synchronous condition. This is referred to as input signal lock. (When the difference between F_o and F_s is too large, the differential signal frequency becomes high and is reduced at the LPF. However, because the VCO control voltage does not change, PLL will not

stay within the *lock range).

Because of the ability of the signal interference removing LPF to accumulate the previous voltage when the PLL deviates from within the lock range due to certain interference, the original condition is quickly reinstated.

- * Free running frequency: Oscillating frequency when there is no input signal.
- * Lock range: At the condition in which the VCO oscillation frequency is locked to the input signal, the lock range is the oscillating frequency in which when the input signal changes, the PLL maintains its input signal lock condition.

Accordingly, in case F_s is changed inside the PLL lock range, VCO oscillation frequency always follows this, and a no frequency deviation and no phase difference signal is obtained. In other words, VCO oscillation frequency can be locked to F_s .

2. STEREO DEMODULATION CIRCUIT

As shown in Fig. 14 for FM broadcasts, the sum signal (L+R) consists of left signal (L) and right signal (R) and the audio frequency band of this signal in its original form is frequency modulated.

On the other hand, the difference signal of both (L-R) is changed to high frequency through the use of the sub carrier, and is referred to as the sub channel signal. The carrier is further frequency modulated and sent to the FM stereo transmitter.

Accordingly, for composite stereo signal demodulation, the sub carrier used for demodulation at the transmitter must be the same uniform 38 kHz signal as the frequency and phase. If the 38 kHz waveform is asymmetrical, channel separation will become poor. At the PLL employed MPX stereo demodulator circuit, as shown in Fig. 15 first a 76 kHz signal is oscillated and when this passes the divider, a symmetrical 38 kHz signal is obtained.

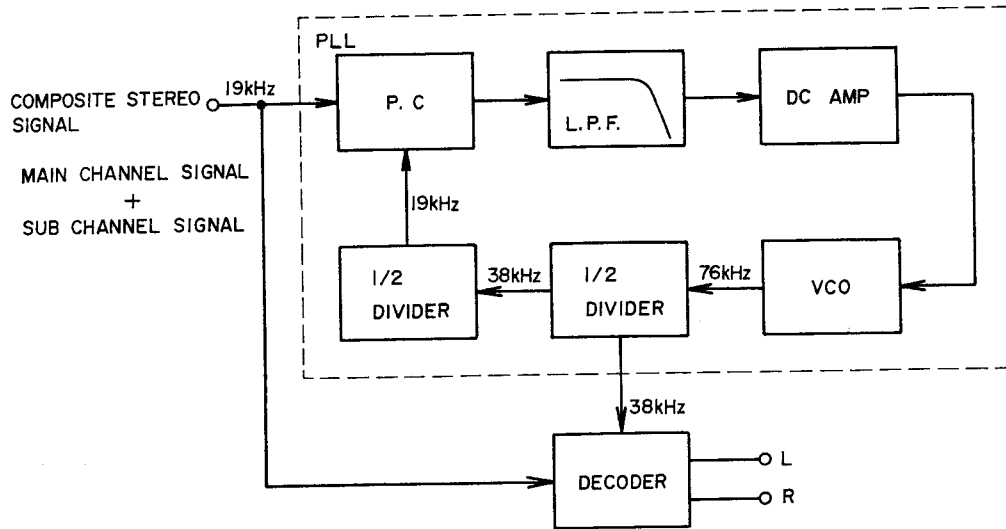

Fig. 15 MPX IC Function

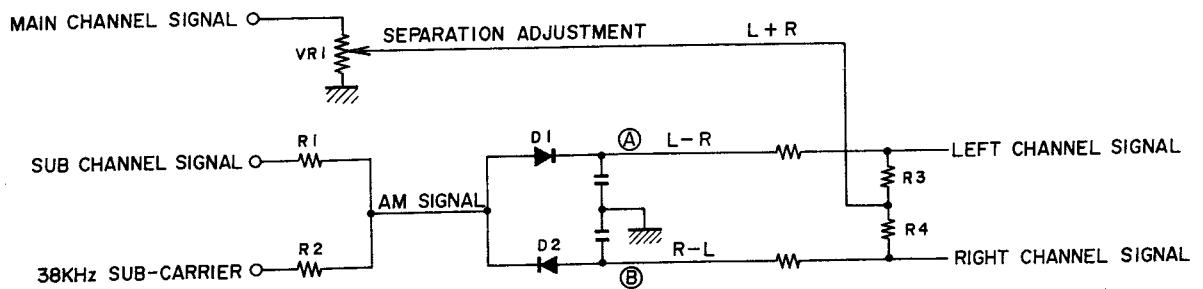

Fig. 16 Multiplex Decoder

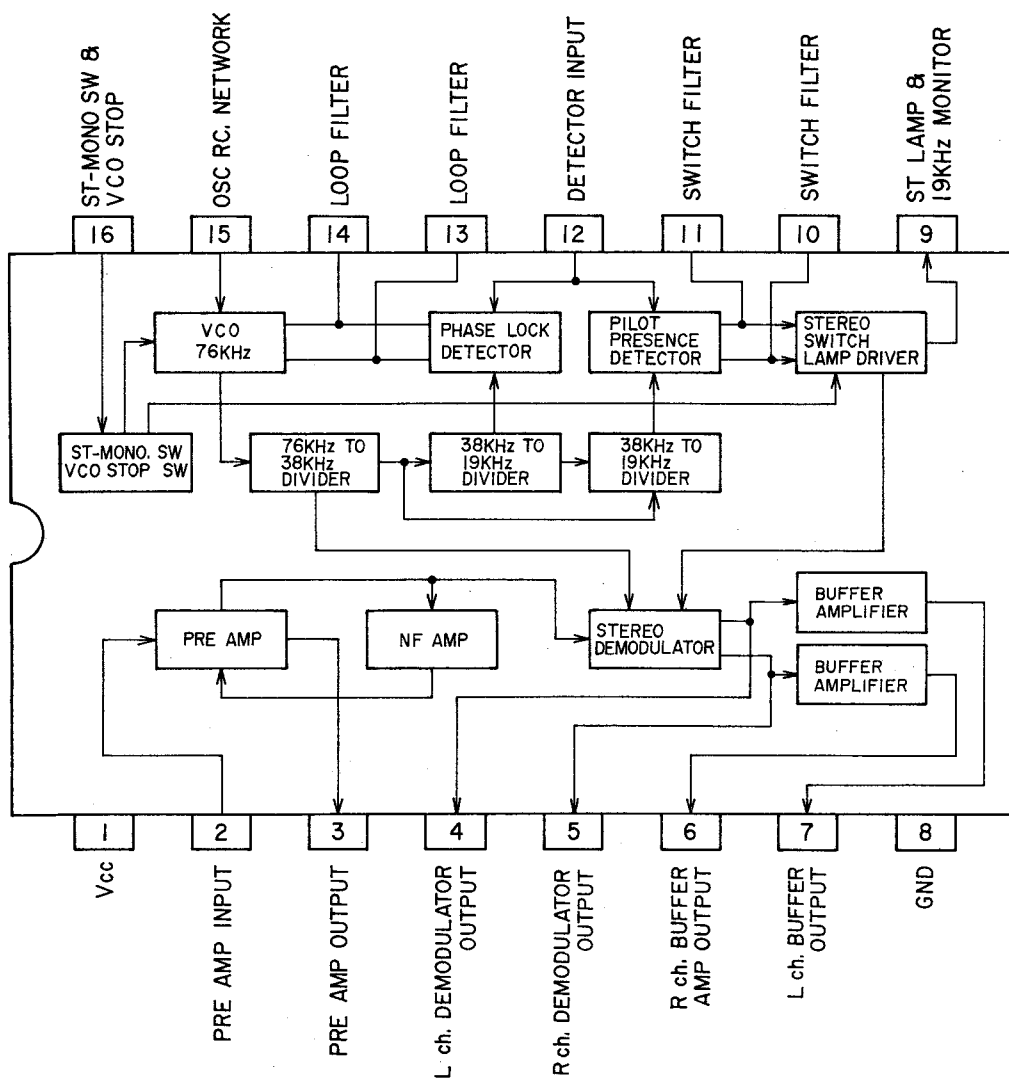

Fig. 17 μ PC1173C Function System Diagram

This 38 kHz sub carrier is supplied to the multiplex decoder together with the sub channel of the composite stereo signal. At the multiplex decoder, left and right channel audio signals are separated in order as shown in Fig. 16.

The 38 kHz sub carrier composited with the sub channel signal of which the carrier part was removed when sub channel signal and sub carrier passed R1 R2 produces the regular AM wave. Then, because this envelop is detected by mutually reverse polarity connected diodes D1 and D2, L-R signal is emitted

at point **A** and R-L signal at point **B**.

Also, because the main channel signal (L+R) is supplied to R3, R4 center point, **A****B** point voltage is added and subtracted and becomes

$$(L+R) + (L-R) = 2L \text{ (left channel)}$$

$$(L+R) + (R-L) = 2R \text{ (right channel)}$$

The level of the main channel signal (L+R) can be adjusted by means of the variable resistor VR (VR1) for optimum separation.

Thus, the function of the PLL IC μ PC1173C actually employed is as shown in Fig. 17.

VII. LEVEL DIAGRAM

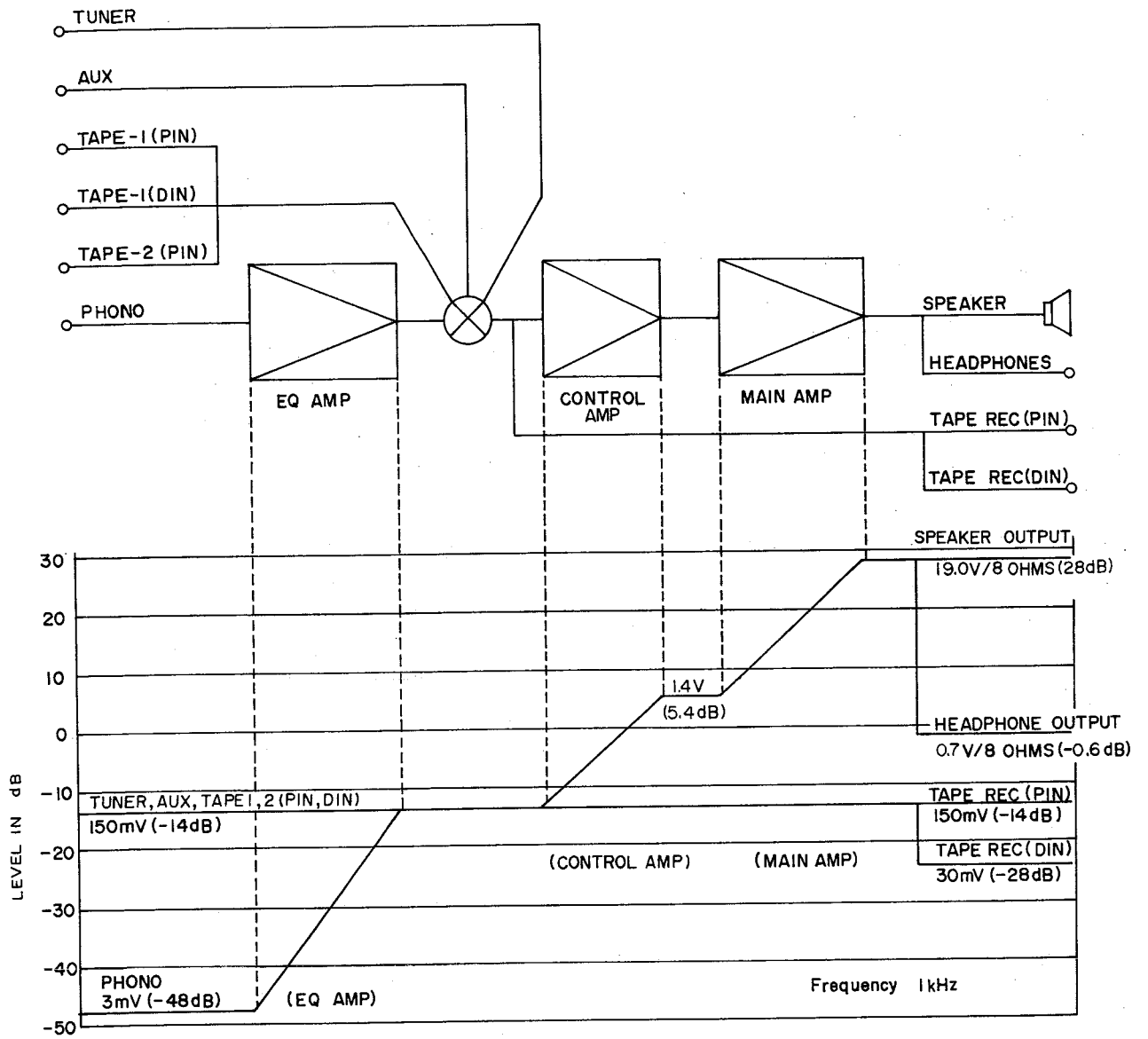

Fig. 18 Level Diagram AM-2450

VIII. TUNER ADJUSTMENT (AT-2450)

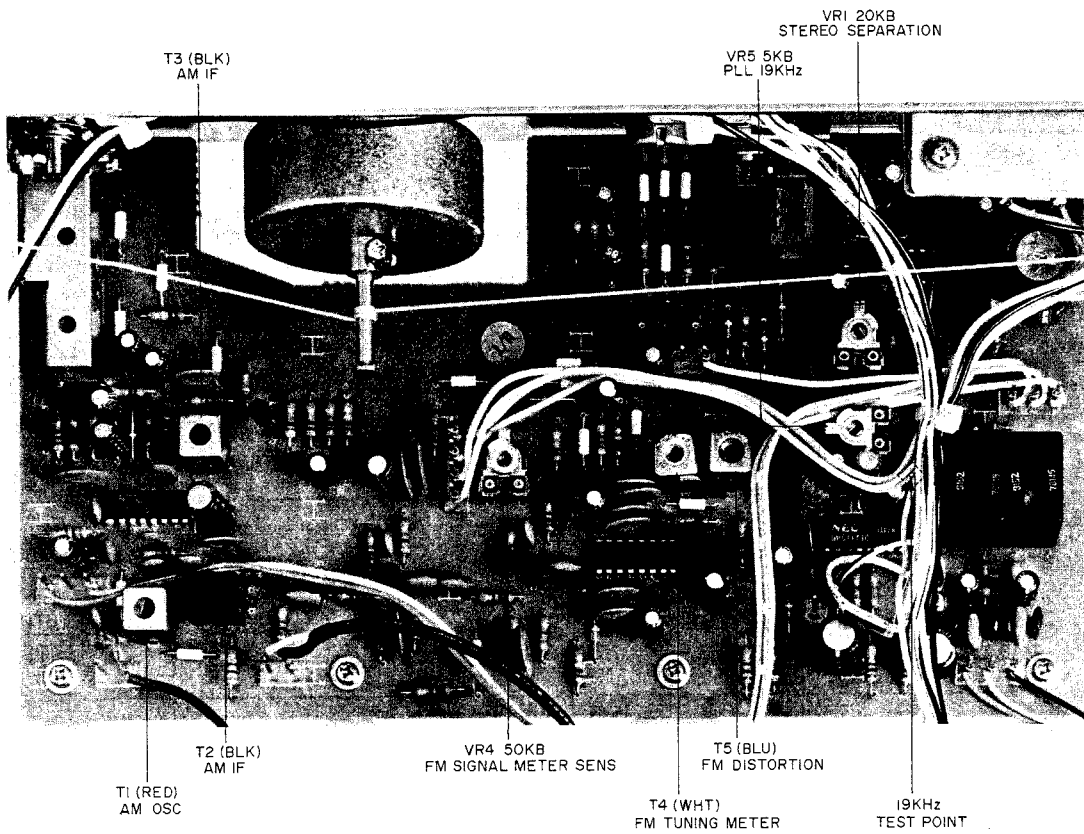

Fig. 19 Tuner P.C Board T3-4501A

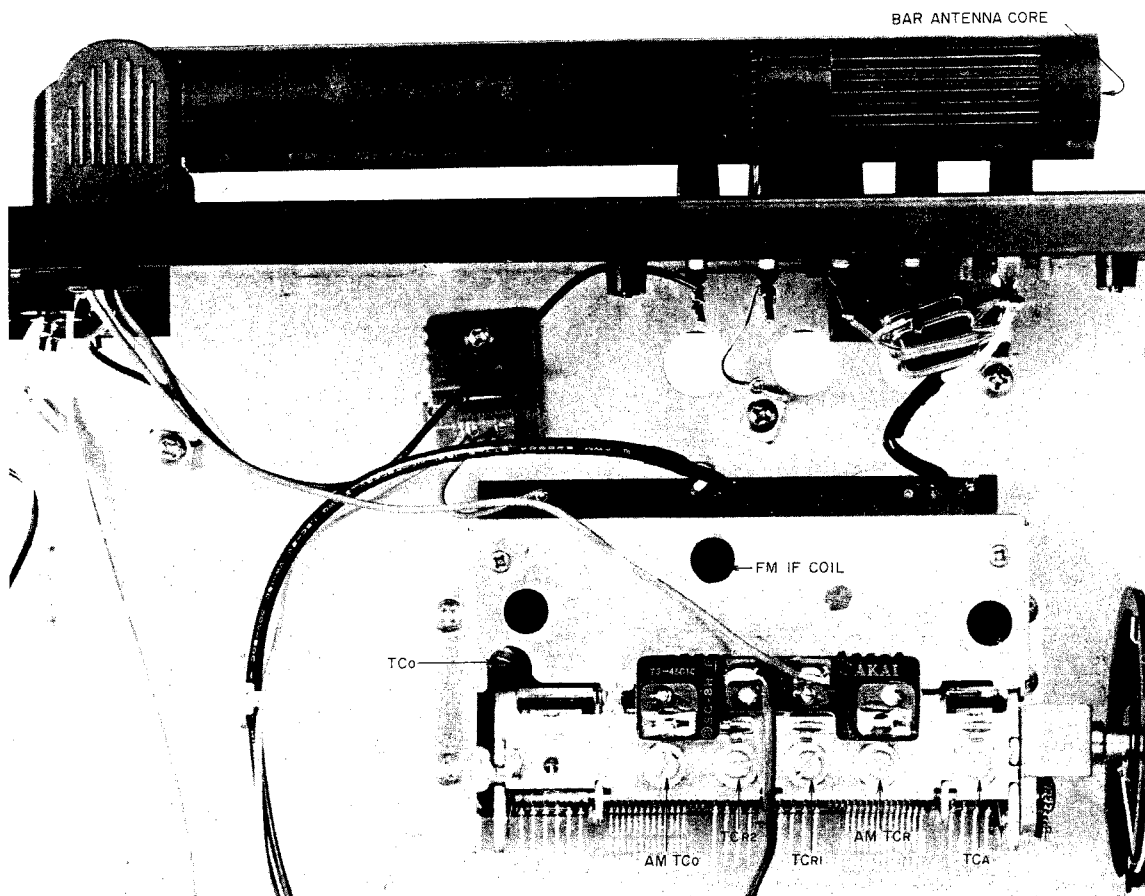

Fig. 20 Front End and Bar Antenna

1. FM TUNER SECTION ADJUSTMENT (Refer to Figs. 19, 20)

Step	Adjustment Item	Adjustment Point	Result	Remarks
1	Tuning Meter Centering	T4 (WHT) (Tuner P.C Board)	Centered Tuning Meter Indication	SELECTOR to FM MONO. FM Mute to OFF. Tunes only noise without interference from broadcasting.
2	Distortion Factor	T5 (BLU) (Tuner P.C. Board)	Less than 0.15% Distortion Factor	98 MHz, 60 dB (mono) input. Less than 0.15% on both channels. See NOTE 1.
3	Confirmation of Tuning Meter Indication			If Tuning Meter Indication is not centered re-adjust Step 1 and 2 above.
4	High Range Scale Indication	TCo (Front End)	Maximum Output	108 MHz, 60dB (mono) input. TUNING INDICATOR to 108 MHz. Error: Within ± 250 kHz.
5	Confirmation of Low Range Scale Indication		Maximum Output	88 MHz, 60 dB (mono) input. TUNING INDICATOR to 88 MHz. Error: Within ± 250 kHz.
6	High Range Sensitivity	TCA, TCR1, TCR2 (Front End)	Less than 3% Distortion Factor	108 MHz, Less than 5 dB (mono) input.
7	Confirmation of Low Range Sensitivity		Less than 3% Distortion Factor	88 MHz, Less than 5 dB (mono) input. See NOTE 2.
8	Confirmation of Mid Range Sensitivity		Less than 3% Distortion Factor	98 MHz, Less than 5 dB (mono) input. See NOTE 2.
9	PLL IC Free Running Frequency	VR5 5 kB (Tuner P.C Board)	19.00 kHz	Frequency Counter to Test Point. (Tuner P.C Board) See NOTE 3.
10	Confirmation of Stereo Indicator Lighting			98 MHz, 60 dB (stereo) input. Unlit stereo indicator indicates no stereo separation.
11	Stereo Separation (Left→Right)	VR1 20 kB (Tuner P.C Board)	More than 45 dB	98 MHz, 60 dB (stereo), L ch input. Minimum output of R ch.
12	Stereo Separation (Right→Left)	VR1 20 kB (Tuner P.C Board)	More than 45 dB	98 MHz, 60 dB (stereo), R ch input. Minimum output of L ch.
13	Signal Meter Sensitivity	VR4 50 kB (Tuner P.C Board)	Indicator at "4.5"	98 MHz, 100 dB (mono) input.

Chart-1

NOTES: 1. When the distortion factor is not less than 0.15% in Step 2, adjust by turning the Front End IF Coil core but not more than one turn.

2. In the event that distortion factors in Steps 7 and 8 are not less than 3%, readjust Front End Trimmer Condensers TCA, TCR1 and TCR2 to obtain a minimum average distortion factor at 88, 98 and 108 MHz (same distortion factor at all three points).

3. PLL IC free running frequency must be an exact 19.00 kHz.

2. AM TUNER SECTION ADJUSTMENT (Refer to Figs. 19, 20)

Step	Adjustment Item	Adjustment Point	Result	Remarks
1	Low Range Scale Indication	T1 (RED) (Tuner P.C Board)	Maximum Output	SELECTOR to AM. 520 kHz 50 dB input. TUNING INDICATOR to 520 kHz. Error: Within 2%.
2	High Range Scale Indication	AM TCo (Front End)	Maximum Output	1,400 kHz 50 dB input. TUNING INDICATOR to 1,400 kHz. Error: Within 2%.
3	Low Range Sensitivity	Bar Antenna core T2, T3 (BLK) (Tuner P.C Board)	Maximum Output Minimum Distortion Factor	520 kHz 50 dB input. Less than 10% Distortion Factor
4	High Range Sensitivity	AM TCR (Front End)	Maximum Output Minimum Distortion Factor	1,400 kHz 50 dB input. Less than 10% Distortion Factor

Chart-2

NOTE: For best results, repeat Steps 1 through 4 two or three times.

IX. AMPLIFIER ADJUSTMENT (AM-2450)

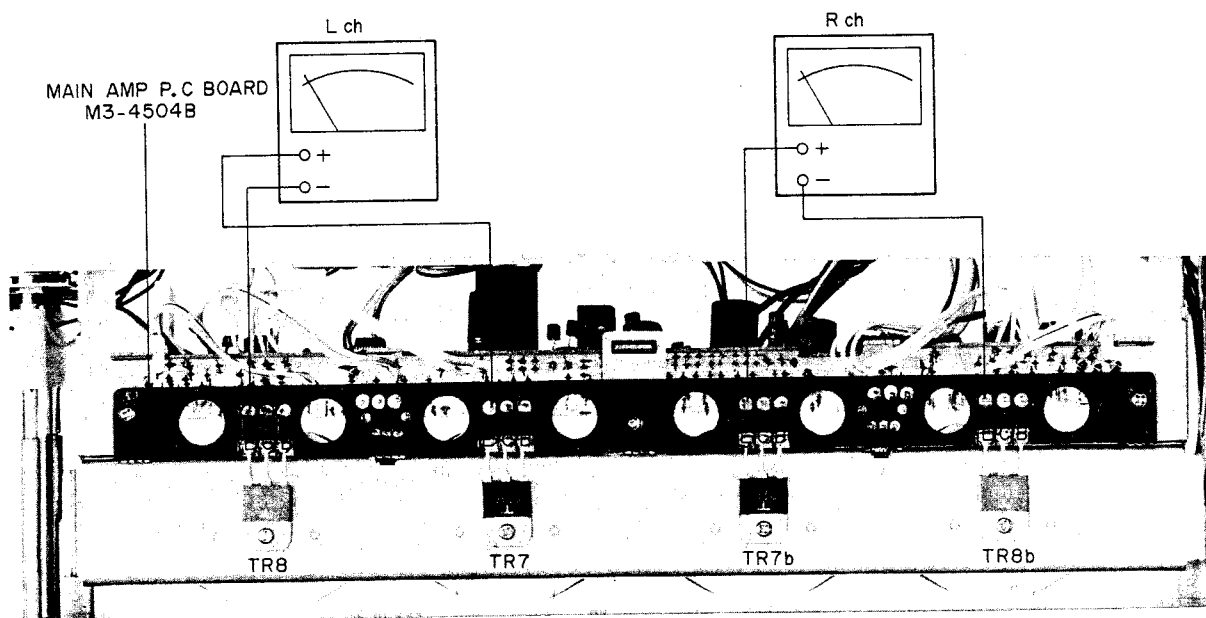

Fig. 21 Instrument Connection

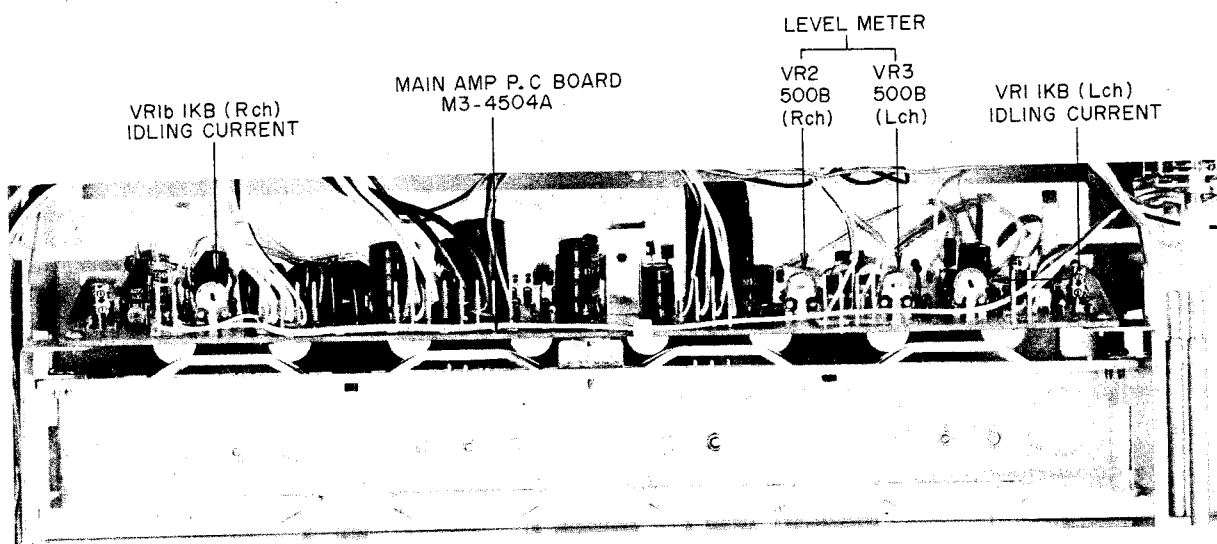

Fig. 22 Adjustment Points

1. IDLING CURRENT ADJUSTMENT (Refer to Figs. 21, 22)

Step	Adjustment Item	Adjustment Point	Result	Remarks
1	Idling Current (Left channel)	VR1 1 kΩ (Main Amp P.C Board)	20 mV	Use a Voltmeter or Tester with DC 50 mV range. (Idling Current is 20 mA).
2	Idling Current (Right channel)	VR1b 1kΩ (Main Amp P.C Board)	20 mV	

Chart-3

* Be careful not to damage the Power Transistors.

MC-Service

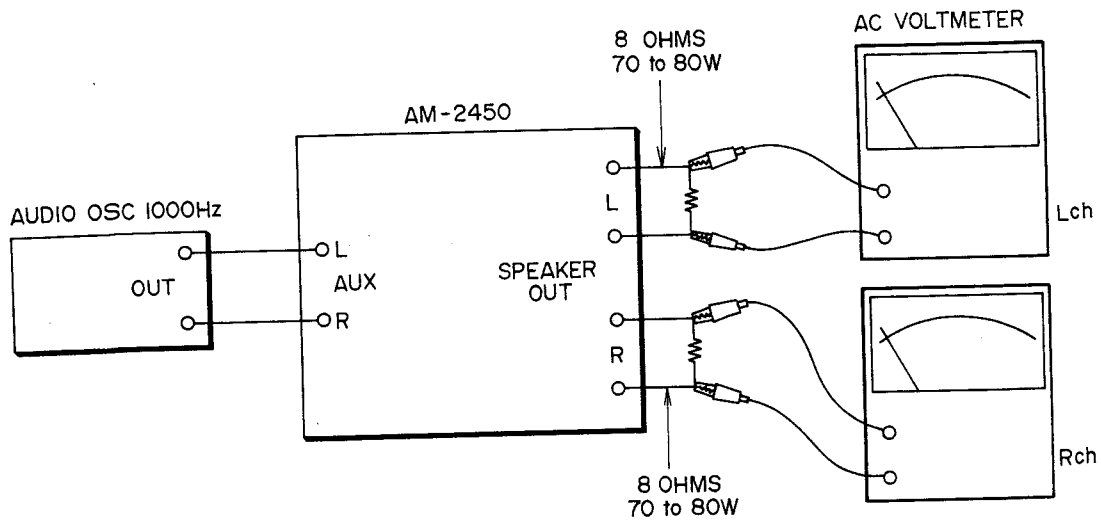

Fig. 23 Instrument Connection

2. LEVEL METER INDICATION ADJUSTMENT (Refer to Fig. 23)

- 1) Connect a load of 8 ohms and AC Voltmeter (approx. 50V range) to the speaker terminals in parallel.
 - 2) Supply a signal of 1,000 Hz to the AUX terminal.
 - 3) Adjust main volume so that 19V is indicated by the AC Voltmeter.
 - 4) Adjust semi-fixed volumes VR3 500B (L ch), and VR2 500B (R ch) on the Main Amp P.C Board.
- Level meter indication should be "45" with the above condition.

X. TUNING CORD THREADING

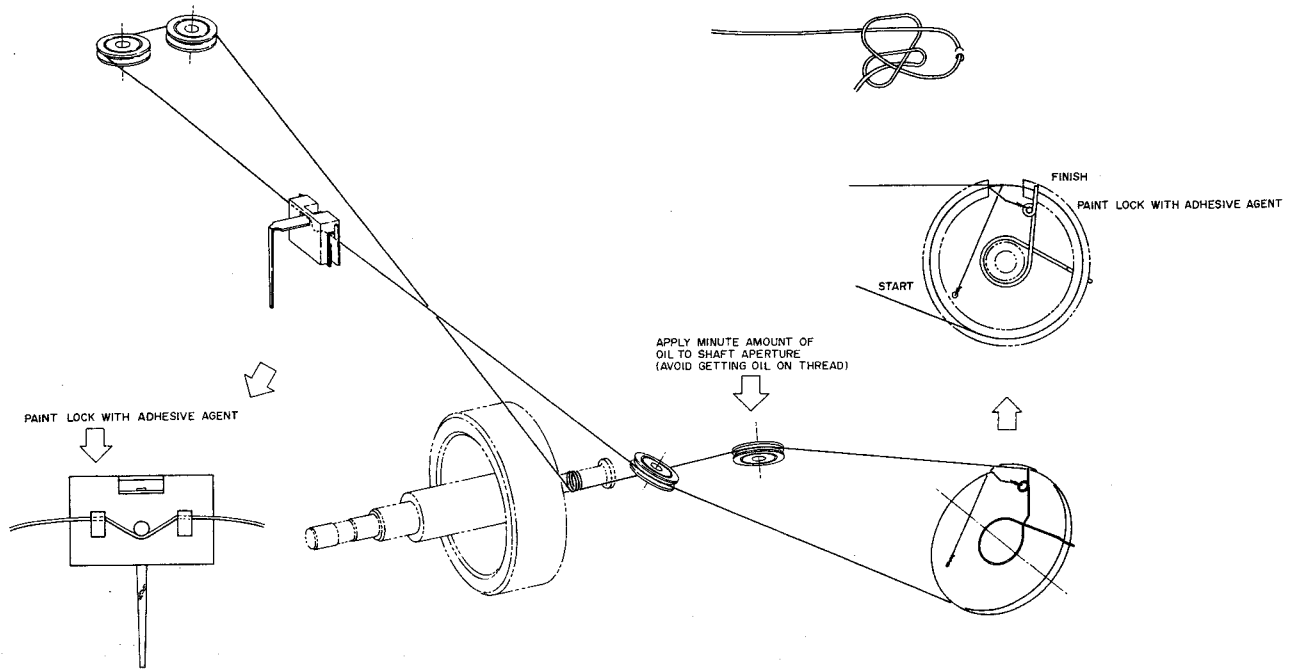

Fig. 24 Tuning Cord Threading

XI. CLASSIFICATION OF VARIOUS P.C BOARDS

1. P.C BOARD TITLE AND IDENTIFICATION NUMBER

1) Model AT-2450

P.C Board Title	P.C Board Number
Tuner P.C Board	T3-4501A
Power Supply P.C Board	T3-4502
LED P.C Board	T3-4501B
Coil P.C Board	T3-4501C
Filter P.C Board	T3-4501D

Chart-4

2) Model AM-2450

P.C Board Title	P.C Board Number
Main Amp P.C Board	M3-4504A/B
Tone Control P.C Board	M3-4503
Main Vol. & Balance P.C Board	M3-4502A/B
Input P.C Board	M3-4501A
Tape P.C Board	M3-4501B
LED P.C Board	M3-4504C

Chart-5

2. MODEL AT-2450 COMPOSITION OF VARIOUS P.C BOARDS

- 1) TUNER P.C BOARD T3-4501A (2ED), LED P.C BOARD T3-4501B, COIL P.C BOARD T3-4501C & FILTER P.C BOARD T3-4501D

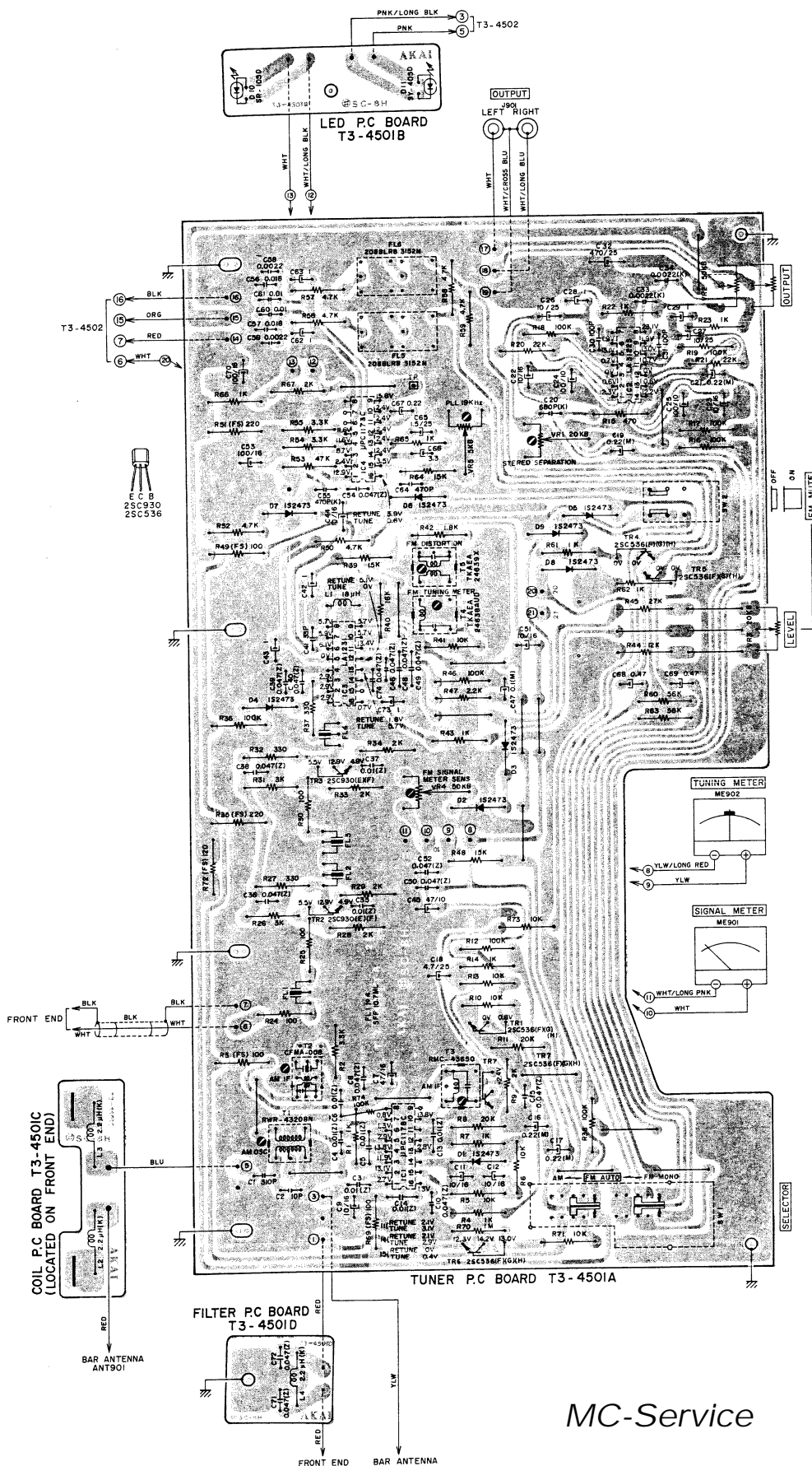

MC-Service

2) POWER SUPPLY P.C BOARD T3-4502 (U/T)

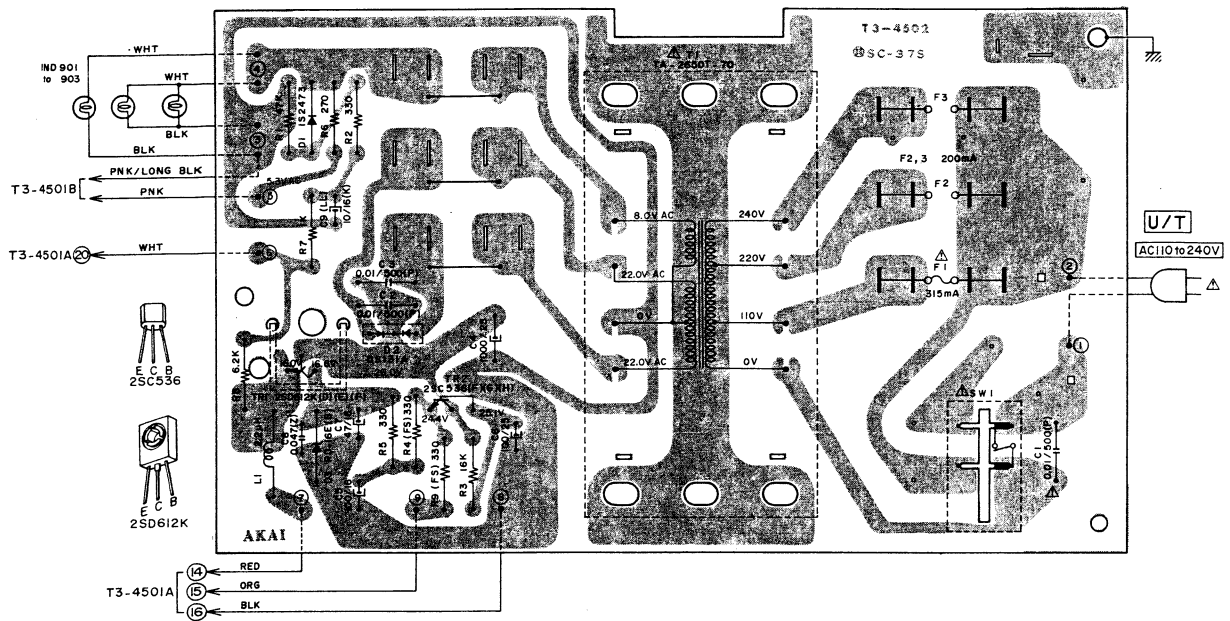

3) POWER SUPPLY P.C BOARD T3-4502 (CSA, AAL)

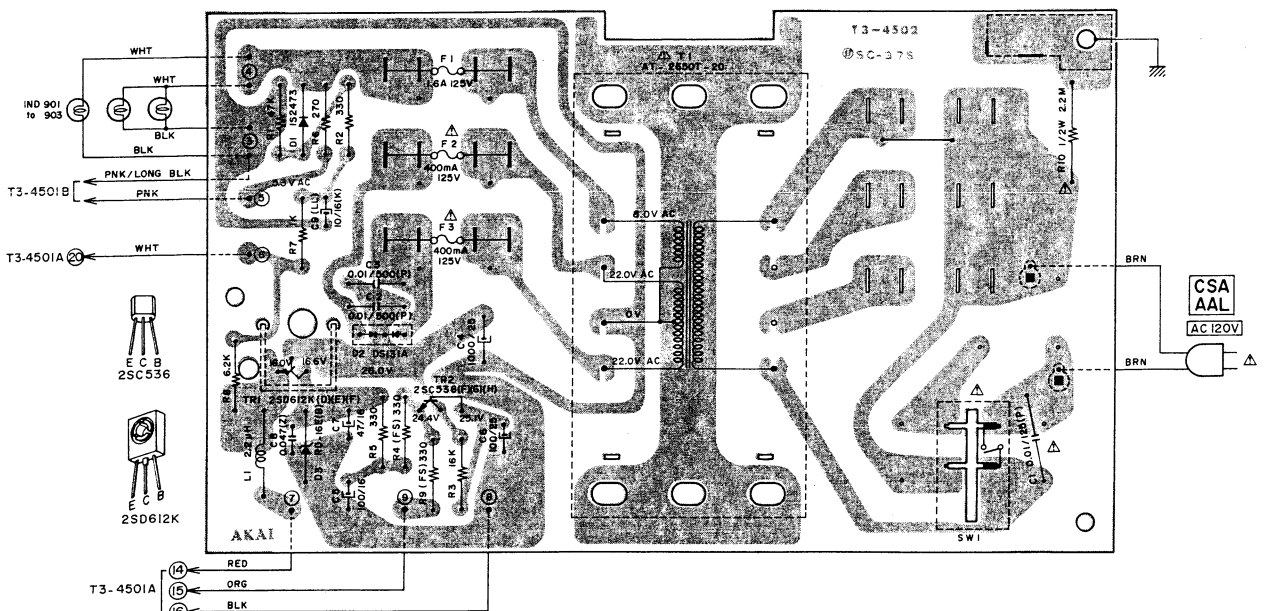

MC-Service

WARNING: Δ INDICATES SAFETY CRITICAL COMPONENTS. FOR CONTINUED SAFETY, REPLACE SAFETY CRITICAL COMPONENTS ONLY WITH MANUFACTURER'S RECOMMENDED PARTS

AVERTISSEMENT: Δ IL INDIQUE LES COMPOSANTS CRITIQUES DE SÛRETÉ. POUR MAINTENIR LE DEGRÉ DE SÛRETÉ DE L'APPAREIL, NE REMPLACER LES COMPOSANTS DONT LE FONCTIONNEMENT EST CRITIQUE POUR LA SÛRETÉ QUE PAR DES PIÈCES RECOMMANDÉES PAR LE FABRICANT

4) POWER SUPPLY P.C BOARD T3-4502 (CEE)

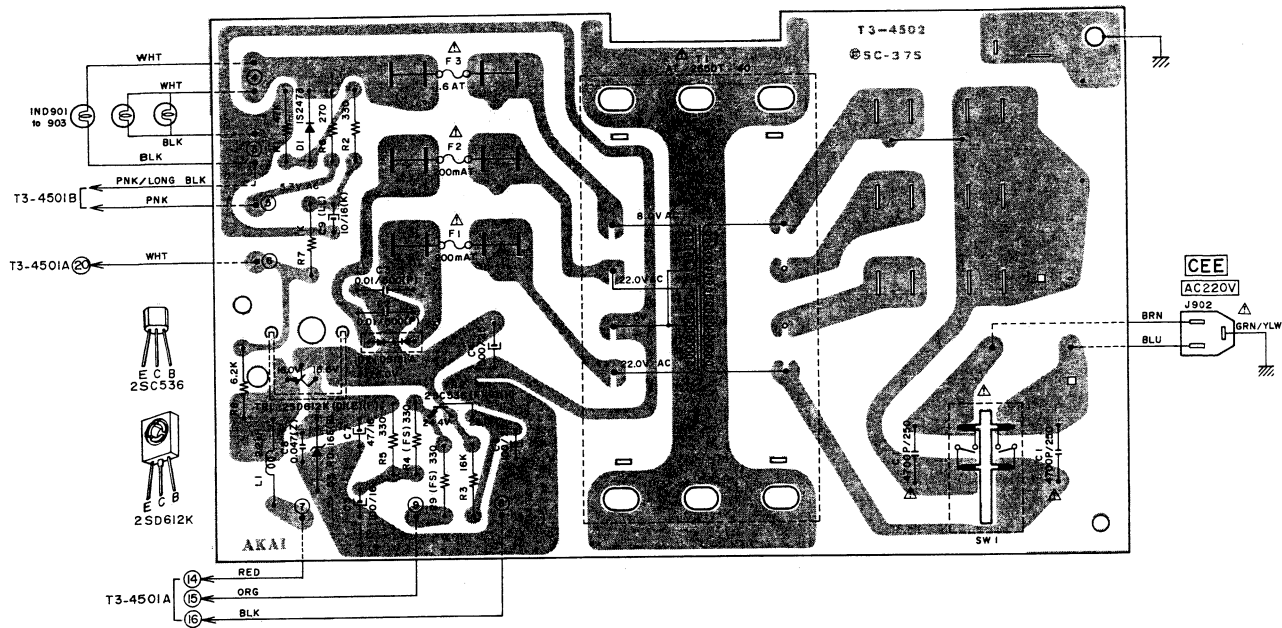

5) POWER SUPPLY P.C BOARD T3-4502 (UK)

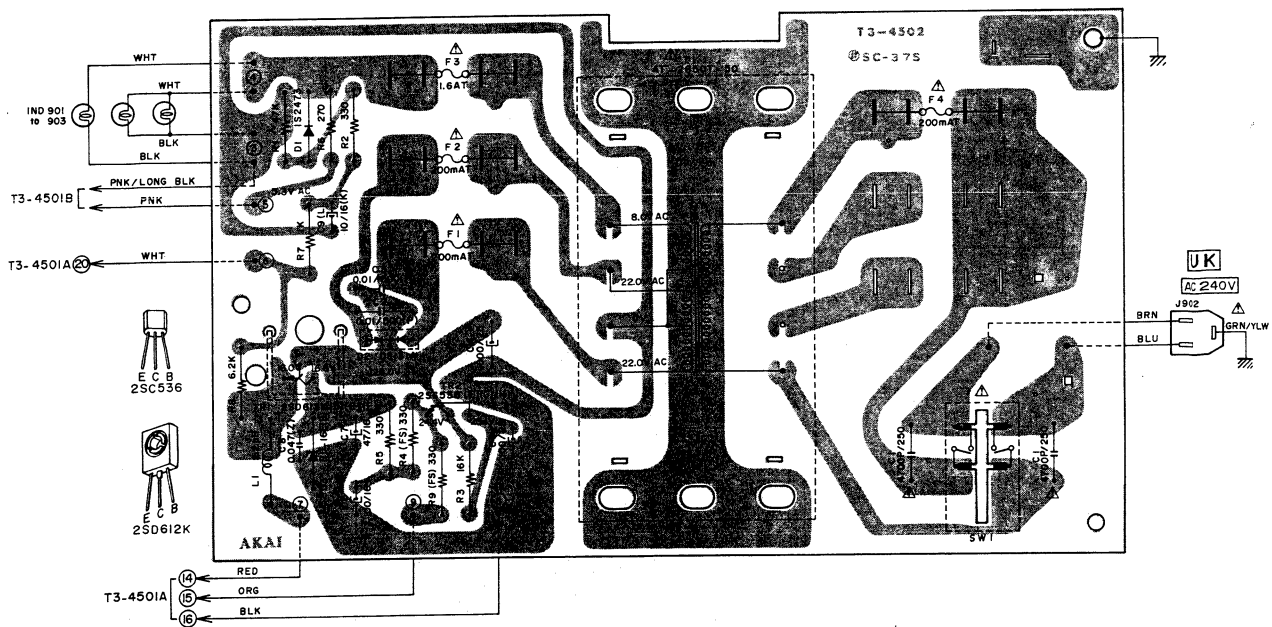

WARNING: Δ INDICATES SAFETY CRITICAL COMPONENTS. FOR CONTINUED SAFETY, REPLACE SAFETY CRITICAL COMPONENTS ONLY WITH MANUFACTURER'S RECOMMENDED PARTS

AVERTISSEMENT: Δ IL INDIQU LES COMPOSANTS CRITIQUES DE SÛRETÉ. POUR MAINTENIR LE DEGRÉ DE SÛRETÉ DE L'APPAREIL NE REMPLACER LES COMPOSANTS DONT LE FONCTIONNEMENT EST CRITIQUE POUR LA SÛRETÉ QUE PAR DES PIÈCES RECOMMANDÉES PAR LE FABRICANT

MC-Service

3. MODEL AM-2450 COMPOSITION OF VARIOUS P.C BOARDS

1) MAIN AMP P.C BOARD M3-4504A/B (2ED) & LED P.C BOARD M3-4504C

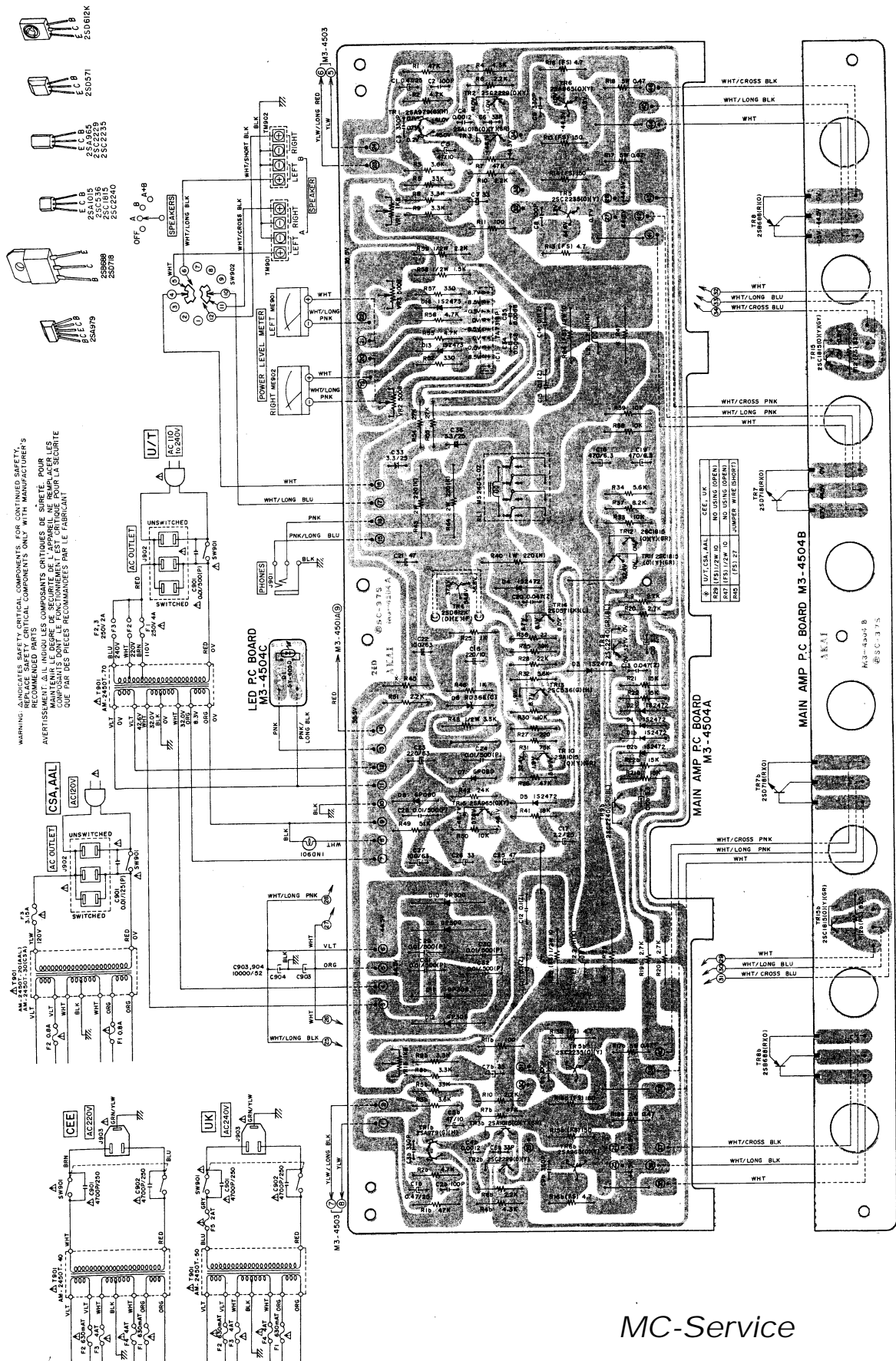

2) TONE CONTROL P.C BOARD M3-4503

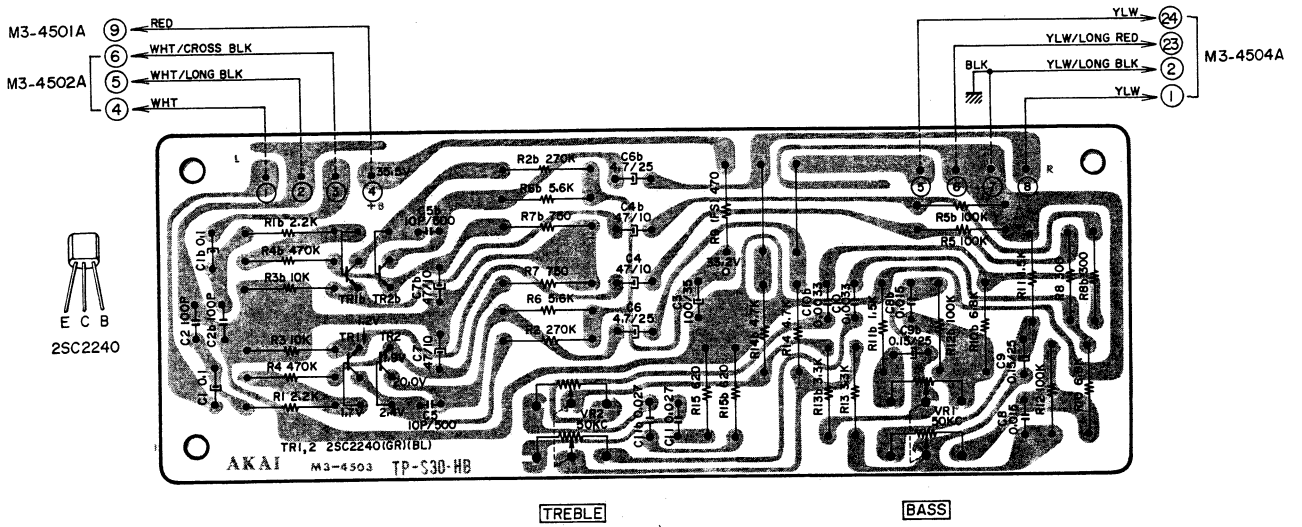

3) MAIN VOL. & BALANCE P.C BOARD M3-4502A/B

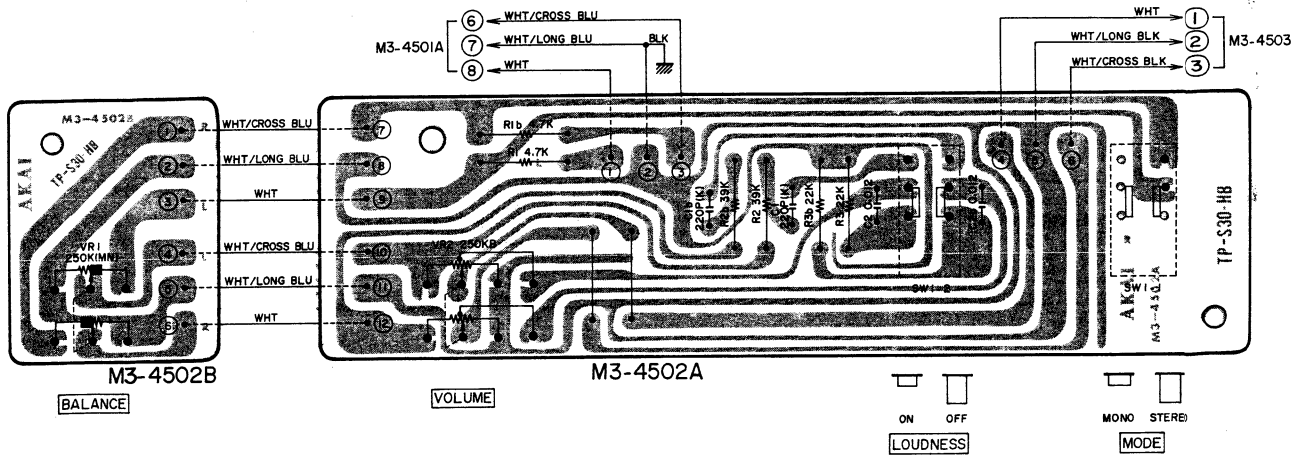

4) INPUT P.C BOARD M3-4501A

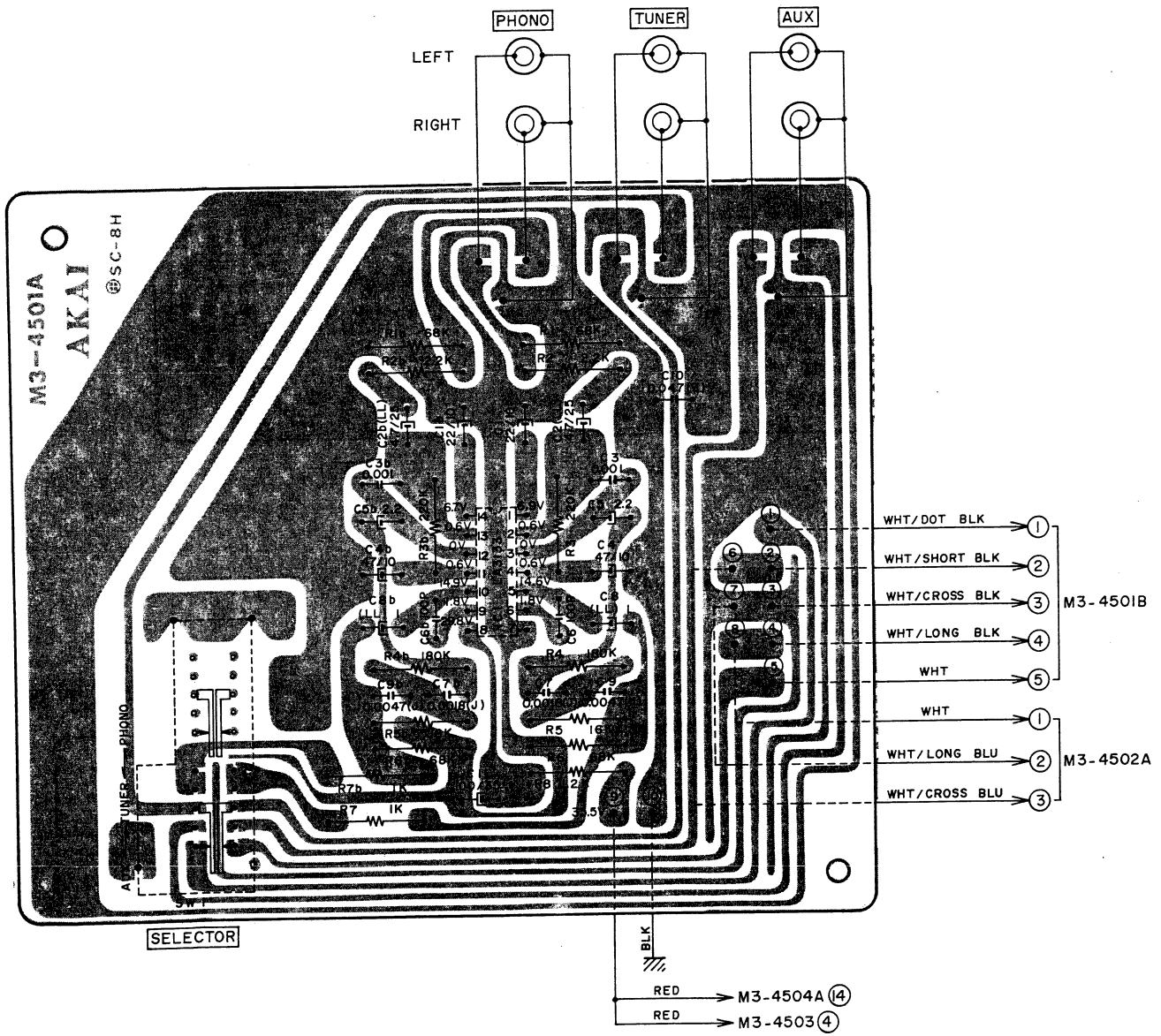

5) TAPE P.C BOARD M3-4501B

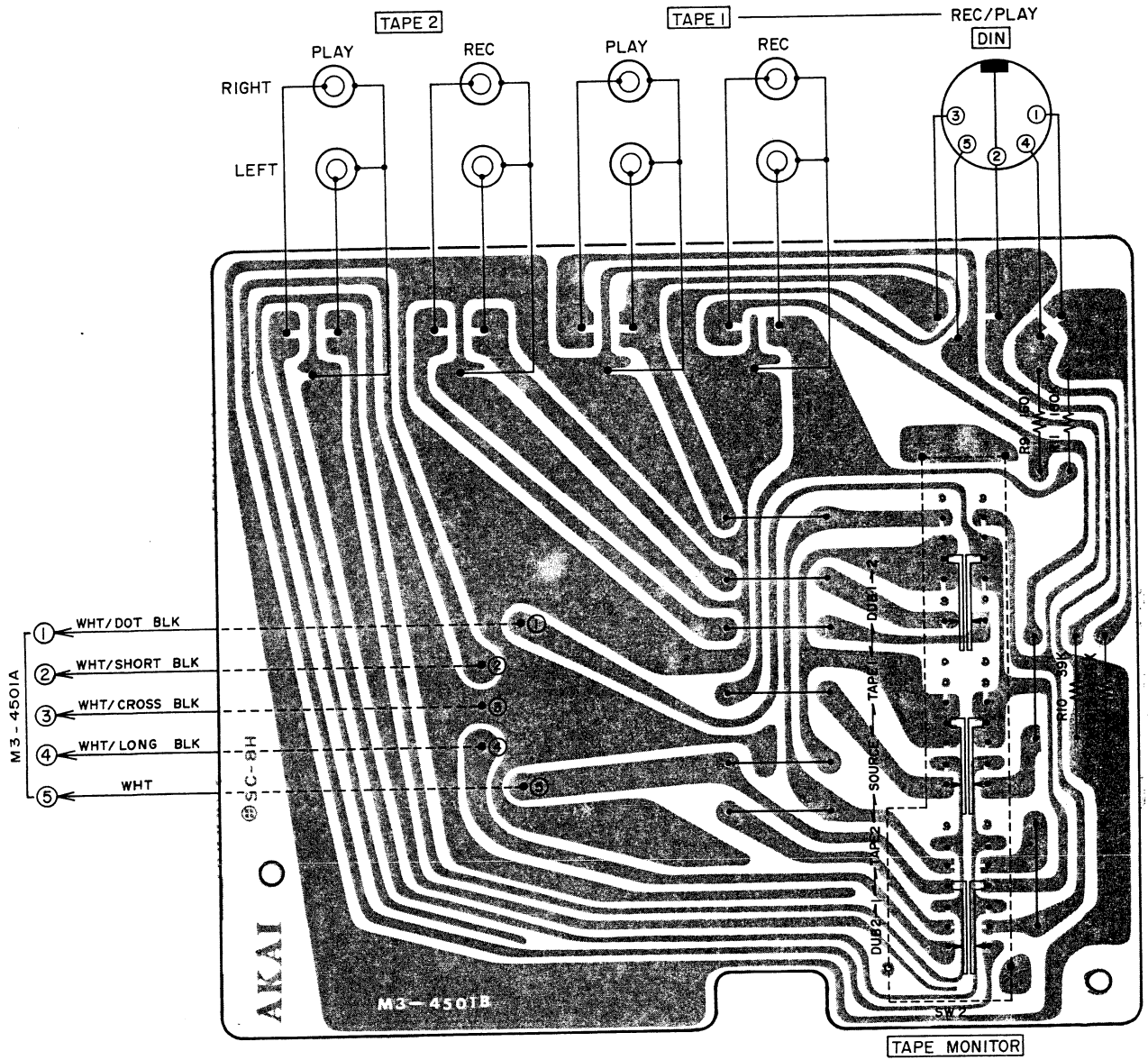

MC-Service

MC-Service

MC-Service

SECTION 2

PARTS LIST

TABLE OF CONTENTS

1. RECOMMENDED SPARE PARTS LIST	36
MODEL AT-2450	
2. TUNER P.C BOARD (T3-4501A) BLOCK	39
3. POWER SUPPLY P.C BOARD (T3-4502) BLOCK	39
4. ASSEMBLY BLOCK	40
5. FINAL ASSEMBLY BLOCK	42
MODEL AM-2450	
6. INPUT & TAPE P.C BOARD (M3-4501A/B) BLOCK	43
7. MAIN VOL. & BALANCE P.C BOARD (M3-4502A/B) BLOCK	43
8. TONE CONTROL P.C BOARD (M3-4503) BLOCK	43
9. MAIN AMP P.C BOARD (M3-4504A/B) BLOCK	43
10. ASSEMBLY BLOCK	44
11. FINAL ASSEMBLY BLOCK	46
INDEX	47

Resistor and Capacitor which is not listed in this parts list, please refer to COMMON LIST FOR SERVICE PARTS.

HOW TO USE THIS PARTS LIST

1. This parts list is compiled by various individual blocks based on assembly process.
2. When ordering parts, please describe parts number, serial number, and model number in detail.
3. How to read list.

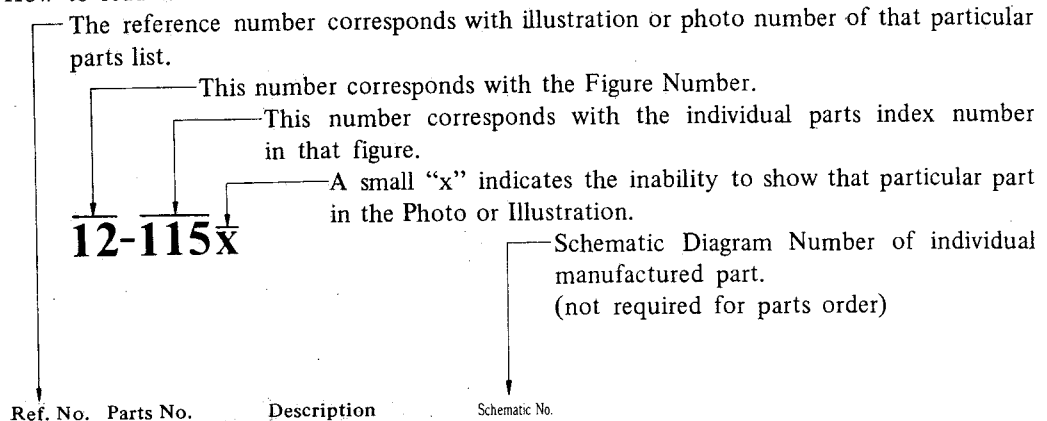

4. The symbol numbers shown on the P.C. Board list can be matched with the Composite Views of components of the Schematic Diagram or Service Manual.
5. The indications of Resistors and Capacitors in the photos of P.C. Board are being eliminated.
6. The shape of the parts and parts name, etc. can be confirmed by comparing them with the parts shown on the Electrical Parts Table of P.C. Board.
7. Both the kind of part and installation position can be determined by the Parts Number. To determine where a parts number is listed, utilize Parts Index at end of Parts List.
It is necessary first of all to find the Parts Number. This can be accomplished by using the Reference Number listed at right of parts number in the Parts Index. (meaning of ref. no. outlined in Item 3 above).
8. Utilize separate "Price List for Parts" to determine unit price. The most simple method of finding parts Price is to utilize the reference number.

CAUTION:

1. When placing an order for parts, be sure to list the parts no. model no., and description. There are instances in which if any of this information is omitted, parts cannot be shipped or the wrong parts will be delivered.
2. Please be careful not to make a mistake in the parts no. If the parts no. is in error, a part different from the one ordered may be delivered.
3. Because parts number and parts unit supply in the Preliminary Service Manual (Basic Parts List) may be partially changed, please use this parts list for all future reference.

WARNING: Δ INDICATES SAFETY CRITICAL COMPONENTS. FOR CONTINUED SAFETY, REPLACE SAFETY CRITICAL COMPONENTS ONLY WITH MANUFACTURER'S RECOMEMNDED PARTS.

AVERTISSEMENT: Δ IL INDIQU LES COMPOSANTS CRITIQUES DE SURETE. POUR MAINTENIR LE DEGRE DE SECURITE DE L'APPAREIL NE REMPLACER LES COMPOSANTS DONT LE FONCTIONNEMENT EST CRITIQUE POUR LA SECURITE QUE PAR DES PIECES RECOMMANDEES PAR LE FABRICANT.

MC-Service

AC INLET SYSTEM

This model is equipped with an AC INLET SYSTEM. Please refer to the AC INLET SYSTEM CHART below for the specific type. By the AC INLET SYSTEM, AC (mains) cord can be connected to and disconnected from the model because the model is provided with socket exclusively for AC (mains) cord on its main body. Please note, however, that certain models are not equipped with this system and has a built-in AC (mains) cord as before.

AC INLET SYSTEM CHART

CLASS I

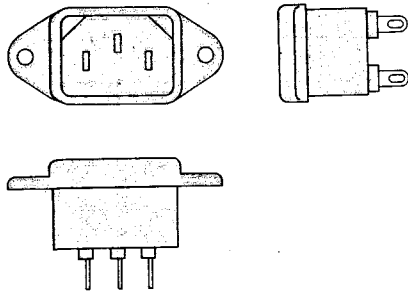

Picture 1
AC INLET
to be
installed
on machines

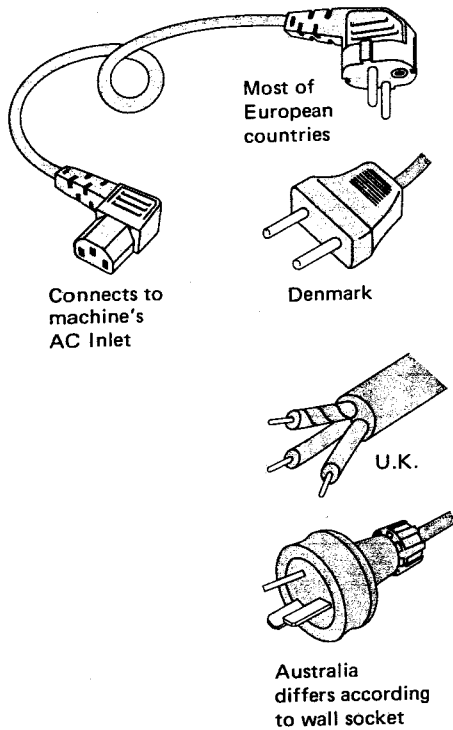

CLASS II

☐ This mark indicating double insulation will be attached to machine's rear panel

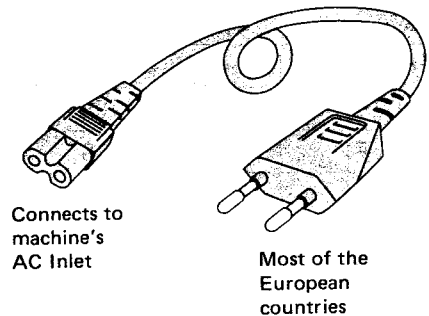
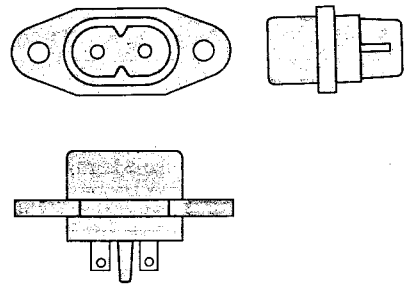

Picture 2
AC (mains)
cord

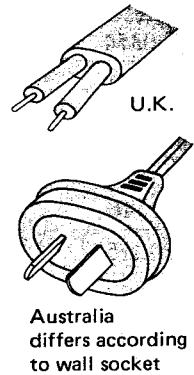

Parts List for AC (mains) Cord Set

Standard		Description	Type of AC Inlet	Parts No.
Class I	CEE	Cord Set CEE (3 cores)	3P	EW302993
	BEAB	Cord Set BEAB (3 cores)	3P	EW302994
	SAA	Cord Set SAA (3 cores)	3P	EW302996
	U/T	Cord Set U/T (3 cores)	3P	EW302646
Class II	CEE	Cord Set CEE (2 cores)	2P	EW638144
	BEAB	Cord Set BEAB (2 cores)	2P	EW302995
	SAA	Cord Set SAA (2 cores)	2P	EW302991
	U/T	Cord Set U/T (2 cores)	2P	EW302899

1. RECOMMENDED SPARE PARTS LIST

Because, if the parts listed below are on hand, almost any repair can be accomplished, we suggest that you stock these Recommended Spare Parts Items.

MODEL AT-2450/BL

Parts No.	Description	Note
BA308077	Tuner P.C Board Comp. AT-2450	
BT308859	△ Power Trans. AT-2650T-70	U/T
BT308829	△ Power Trans. AT-2650T-20	CSA, AAL
BT308830	△ Power Trans. AT-2650T-40	CEE
BT308831	△ Power Trans. AT-2650T-50	UK
ED308860	Zener Diode RD-16E(B)	
ED698826	LED SR-105D	
ED308592	LED SY-405D	
EF306125	△ Fuse 315mA 250V	U/T
EF308933	△ Fuse 200mA 250V	U/T
EF308847	△ Fuse 1.6A 125V	CSA, AAL
EF308848	△ Fuse 400mA 125V	CSA, AAL
EF300596	△ Fuse (FST) 200mA T	CEE, UK
EF601964	△ Fuse (SEMKO T Type) 1.6AT	CEE, UK
EI307199	IC μ PC1178C	
EI697871	IC LA-3122S	
EI307198	IC LA1231	
EI308850	IC μ PC1173C	
EM308844	Signal Meter KL-243X-35	
EM300355	Signal Meter KL-243X-26	BL
EM308843	Tuning Meter KL-243X-36	
EM300354	Tuning Meter KL-243X-27	BL
ES308852	Rotary SW. SRZK-043S	
ES308858	△ Push SW. JP29, w/o label	U/T
ES308863	△ Push SW. JP29, w/label	CSA, AAL
ES242346	△ Push SW. JP17	CEE, UK
ET632215	Transistor 2SC536 (F) (G) (H)	
ET618873	Transistor 2SC930 (E) (F)	
ET307193	Transistor 2SD612K (D) (E) (F)	

MODEL AM-2450/BL

Parts No.	Description	Note
BA308025	Main Amp P.C Board Comp. AM-2450	U/T, CSA
BA308026	Main Amp P.C Board Comp. AM-2450	CEE, UK
BT308591	△ Power Trans. AM-2450T-70	U/T
BT308588	△ Power Trans. AM-2450T-30	CSA
BT308587	△ Power Trans. AM-2450T-20	AAL
BT308589	△ Power Trans. AM-2450T-40	CEE
BT308590	△ Power Trans. AM-2450T-50	UK
ED240377	Zener Diode RD36E (C)	
EF563703	△ Fuse 2A 250V	U/T
EF575212	△ Fuse 4A 250V	U/T
EF277424	△ Fuse ST-4 0.8A	CSA, AAL
EF304303	△ Fuse ST-6 3.15A	CSA, AAL
EF601942	△ Fuse (SEMKO T Type) 630mAT	CEE, UK
EF690996	△ Fuse (SEMKO T Type) 4AT	CEE, UK
EF601301	△ Fuse (SEMKO T Type) 2AT	UK
EI305696	IC LA3133	
EI308865	IC TA7318P	
EP245305	Relay MA24D4-0Z	
ES308883	Rotary SW. SRZ-K043N (18)	
ES308884	Rotary SW. SRZ-K065T	
ES224436	△ Push SW. JP01	
ES280258	△ Push SW. SDV1P TV-5 (w/label)	CSA, AAL
ES242346	△ Push SW. JP17	CEE, UK
ET307195	Transistor 2SC2240 (GR) (BL)	
ET308866	Transistor 2SA979 (G) (H)	
ET310168	Transistor 2SC2229 (O) (Y)	
ET308867	Transistor 2SA1015 (O) (Y) (GR)	
ET308870	Transistor 2SC2235 (O) (Y)	
ET308868	Transistor 2SA965 (O) (Y)	
ET307195	Transistor 2SC2240 (GR) (BL)	
ET305221	Transistor 2SC1815 (O) (Y) (GR)	
ET403391	Transistor 2SC536 (G) (H)	
ET666404	Transistor 2SD571 (K) (L)	
ET307193	Transistor 2SD612K (D) (E) (F)	
ET308879	Transistor 2SD718 (R) (O)	
ET308880	Transistor 2SB688 (R) (O)	
EV307189	Single Axial 2 Throw Vol. GM70E-250kMN	
EV307188	Single Axial 2 Throw Vol. GM80E-250kBx2	
EV308596	Single Axial 2 Throw Vol. GM70E-C50kx2	

MC-Service

MODEL AT-2450

2. TUNER P.C BOARD (T3-4501A) BLOCK

Symbol No.	Parts No.	Description	Schematic No.
2-1	BA308077	Tuner P.C Board Comp. AT-2450	T3-4546
2-IC1	EI3 07199	IC μ PC1178C	45-8-268
2-IC2	EI6 97871	IC LA-3122S	45-8-185
2-IC3	EI3 07198	IC LA1231	45-8-267
2-IC4	EI3 08850	IC μ PC1173C	45-8-318
2-TR1	ET632215	Transistor 2SC536(F)(G)(H)	45-1-55
2-TR2,3	ET618873	Transistor 2SC930(E)(F)	45-1-185
2-TR4to7	ET632215	Transistor 2SC536(F)(G)(H)	45-1-55
2-D1to9	ED624903	Silicon Diode 1S2473	45-3-28
2-SW1	ES308852	Rotary SW. SRZK-043S	25-6-160
2-SW2	ES308851	Push SW. 12M-7S231	25-5-298
2-VR1	EV560136	Semi-fixed/Vol. V10K8-4-2 20 k Ω	36-10-250
2-VR2	EV308854	Single Axial 2 Throw Vol. GM70R871C 50 k Ω x2	36-22-40
2-VR3	EV308853	Vol. VM10R907C 100 k Ω	36-6-35
2-VR4	EV650891	Semi-fixed/Vol. V10K8-4-2 50 k Ω	36-10-250
2-VR5	EV307246	Semi-fixed/Vol. D10 Axial Type 5 k Ω	36-10-274
2-T1	EO307186	OSC Coil RWR-43208N	23-4-47
2-T2	BT307204	AM-IF Trans. CFMA-008	53-1-131
2-T3	EO307205	AM-IF Coil RMC-43650C	23-1-292
2-T4	EO307202	Detection Coil TKAEA-24638AUO	23-1-290
2-T5	EO307203	Detection Coil TKAEA-24639X	23-1-291
2-L1	EO650610	Inductor 144LZ 18 μ H (J)	23-1-240
2-FL1to4	ER308617	Ceramic Filter SFE10.7ML-Z	53-1-139
2-FL5,6	ER308855	Low Pass Filter 208BLRB-3251N	53-1-140
2-C1	EC307257	Styrol/C. (Homing Type) 310PF(J) 50WV	24-11-14
2-C64	EC306987	Styrol/C. (Homing Type) 470PF(J) 50WV	24-11-14
2-C65	EC638188	Solid Aluminum/C. (Vert. Type) 1.5 μ F(M) 25WV	24-19-2
COIL P.C BOARD BLOCK			
2-L2,3	EO539820	Peaking Coil 2.2 μ H(K)	23-1-187
FILTER P.C BOARD BLOCK			
2-L4	EO539820	Peaking Coil 2.2 μ H(K)	23-1-187

3. POWER SUPPLY P.C BOARD (T3-4502) BLOCK

Symbol No.	Parts No.	Description	Schematic No.
3-1	BA308069	Power Supply P.C Board Comp. AT-2450(U/T)	T3-4550
3-2	BA308067	Power Supply P.C Board Comp. AT-2450(CSA,AAL)	T3-4550
3-3	BA308066	Power Supply P.C Board Comp. AT-2450(CEE)	T3-4550
3-4	BA311178	Power Supply P.C Board Comp. AT-2450(UK)	T3-4550
3-TR1	ET307193	Transistor 2SD612K (D)(E)(F)	45-1-308
3-TR2	ET632215	Transistor 2SC536(F)(G)(H)	45-1-55
3-D1	ED624903	Silicon Diode 1S2473	45-3-28
3-D2	ED223547	Silicon Diode DS131A	45-2-67
3-D3	ED308860	Zener Diode RD-16E(B)	45-6-72
3-SW1	ES308858	Δ Push SW. JP29, w/o label (U/T)	25-5-299
3-SW1	ES308863	Δ Push SW. JP29, w/label (CSA, AAL)	25-5-300
3-SW1	ES242346	Δ Push SW. JP17 (CEE, UK)	25-5-224
3-L1	EO539820	Peaking Coi. 2.2 μ H(K)	23-1-187
3-C1	EC204671	Δ Ceramic/C. DD31-6E 0.01 μ F(P) 500WV(U/T)	24-5-66
3-C1	EC294118	Δ Ceramic/C. DPN6600YM 0.01 μ F(P) 125WV (CSA, AAL)	24-5-70
3-C1	EC301320	Δ MP/C. 4700PF(M) 250WV (CEE, UK)	24-9-122
3-C2	EC204671	Δ Ceramic/C. DD31-6E 0.01 μ F(P) 500WV	24-5-66
3-C3	EC204671	Δ Ceramic/C. DD31-6E 0.01 μ F(P) 500WV	24-5-66
3-2	ZS325495	Tapping Screw #2, 3x6 (BR)	

4. ILLUSTRATION OF ASSEMBLY BLOCK

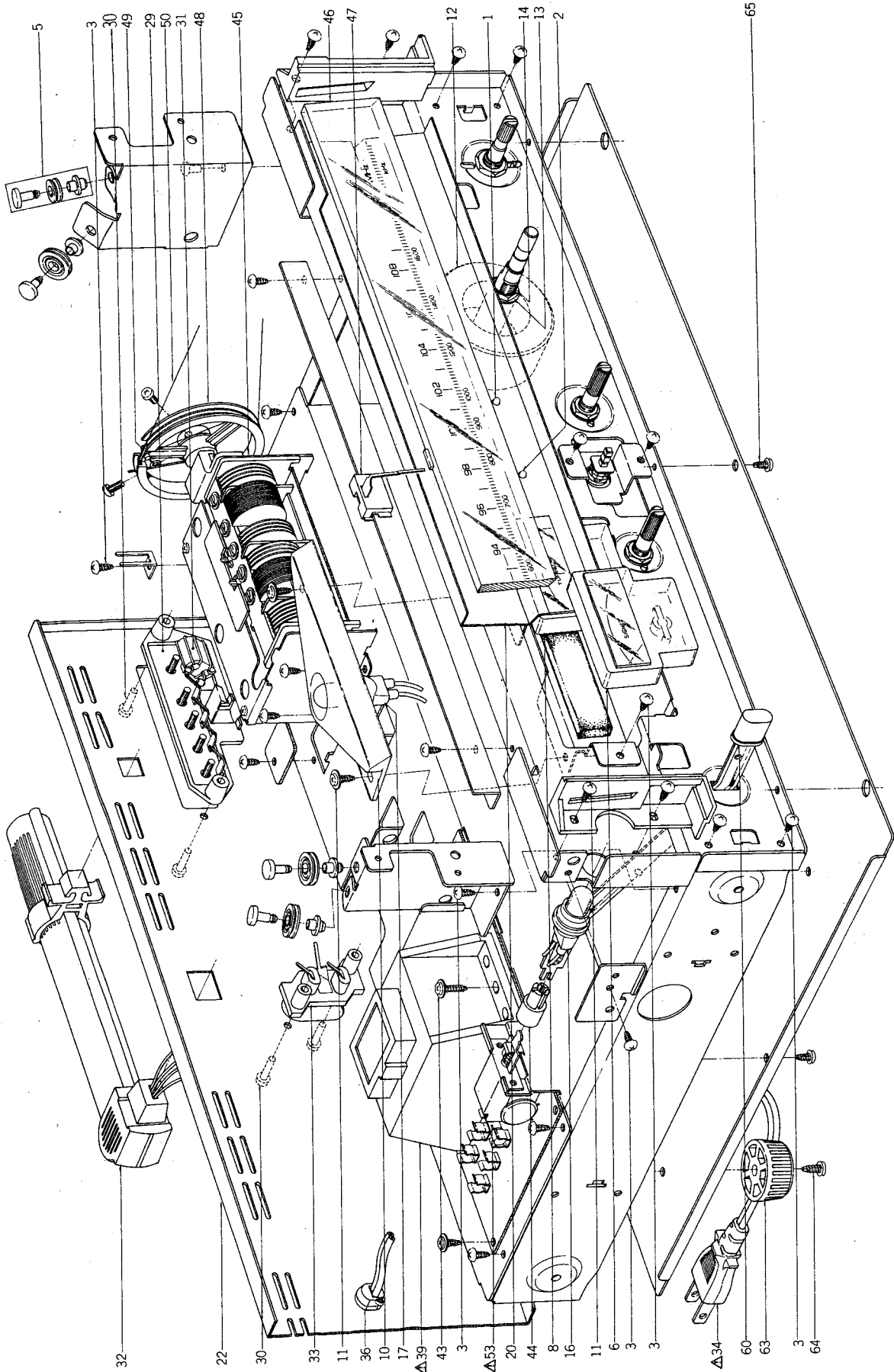

4) ASSEMBLY BLOCK

Ref. No.	Parts No.	Description	Schematic No.	Ref. No.	Parts No.	Description	Schematic No.
LED P.C BOARD BLOCK							
4-1	ED698826	LED SR-105D	45-15-16	4-55x	EF308847	△ Fuse 1.6A 125V (CSA, AAL)	39-1-65
4-2	ED308592	LED SY-405D	45-15-20	4-56x	EF308848	△ Fuse 400mA 125V (CSA, AAL)	39-1-65
ASSEMBLY BLOCK							
4-3	ZS325495	Tapping Screw #2, 3x6(BR)		4-57x	EF300596	△ Fuse (FST) 200mAT (CEE, UK)	39-1-61
4-4x	ZS297641	Tapping Screw #2, 3x8(Bind) W=10		4-58x	EF601964	△ Fuse (SEMKO T Type) 1.6AT (CEE, UK)	39-1-53
4-5	MZ307170	Pulley	13-2-39	4-59x	EF300596	△ Fuse (FST) 200mAT (UK)	39-1-61
4-6	EM308844	Signal Meter KL-243X-35	46-1-214	4-60	SK305674	Power SW. Cap	CN-6338
4-7x	EM300355	Signal Meter KL-243X-26(BL)	46-1-165	4-61x	SK306130	Power SW. Cap (BL)	CN-6338
4-8	EM308843	Tuning Meter KL-243X-36	46-1-213	4-62	SP308634	Bottom Plate	T3-4523
4-9x	EM300354	Tuning Meter KL-243X-27(BL)	46-1-163	4-63	EA312465	Circular Foot (A) Part CA	CA-6014
4-10	TA308638	Meter Illumination Plate	T3-4526	4-64	ZS565942	Tapping Screw #2, 4x8(Pan)	
4-11	ZS498273	Tapping Screw #2, 3x8(BR) W=8		4-65	ZS447840	Tapping Screw #2, 3x8(BR)	
4-12	TA308837	Flywheel	13-2-46				
4-13	ZW308889	Washer	25-6-160				
4-14	ZW308890	Nut	25-6-160				
4-15x	ZS379350	Screw, pan head 3x6					
4-16	EL307157	Lamp (Cord Type) 8V 300mA (300mmx2)	28-2-71				
4-17	EL308839	Lamp (Cord Type) 8V 300mA (500mmx2)	28-2-71				
4-18x	EL308840	Lamp (Cord Type) 8V 300mA (600mmx2)	28-2-71				
4-19x	ZW231030	Nylon Rivet (FNRP) 3x4.5 (Black)	2-7-54				
4-20	SP308606	Meter Panel	T3-4503				
4-21x	SP308607	Meter Panel (BL)	T3-4503				
4-22	SP308619	Rear Panel (A) (U)(U/T)	T3-4510				
4-23x	SP308620	Rear Panel (B) (C)(CSA)	T3-4511				
4-24x	SP308621	Rear Panel (C) (A)(AAL)	T3-4511				
4-25x	SP308622	Rear Panel (D) (E)(CEE)	T3-4512				
4-26x	SP308623	Rear Panel (E) (B)(UK)	T3-4512				
4-27x	ZS447761	Tapping Screw #2, 3x6(BR) (Black)					
4-28x	ZS308673	Tapping Screw 3x20 (Pan), w/guide (CSA, AAL, CEE, UK)	7-1-68				
4-29	EJ308832	5P Antenna Terminal Plate UD-0059	32-1-92				
4-30	ZS522865	Tapping Screw #2, 3x12 (BR) (Black)					
4-31	BT444137	Balum Trans. 75 ohms-300 ohms	23-1-129				
4-32	EE308833	Bar Antenna	55-1-55				
4-33	EJ308834	2P PIN Jack T5511	31-5-143				
4-34	EW306428	△ AC Cord (U/T)	26-3-64				
4-35x	EW305691	△ AC Cord CUL (CSA, AAL)	26-3-65				
4-36	EZ631945	Strain Relief SR-4N-4 (U/T, CSA, AAL)	2-7-49				
4-37x	EJ296853	△ 3P In-Let CM-3 (CEE, UK)	31-1-199				
4-38x	ZS463353	Tapping Screw #2, 3x8(BR) (Black) (CEE, UK)					
4-39	BT308859	△ Power Trans. AT-2650T-70 (U/T)	38-4-666				
4-40x	BT308829	△ Power Trans. AT-2650T-20 (CSA, AAL)	38-4-663				
4-41x	BT308830	△ Power Trans. AT-2650T-40 (CEE)	38-4-664				
4-42x	BT308831	△ Power Trans. AT-2650T-50 (UK)	38-4-665				
4-43	ZS308513	Tapping Screw #2, 3x12(BR) W=8					
4-44	TC289484	SW. Joint	CM-6015				
4-45	EE308838	Front End FR611U14	57-2-47				
4-46	TA308609	Scale Plate (A)	T3-4504				
4-47	TA308109	Pointer Part AT-2450	T3-4535				
4-48	MI301149	Dial Wheel	2-15-17				
4-49	ZG300891	Dial Wheel Spring	AB-3533				
4-50	TA307160	Dial String TK-1064 D0.5	8-2-1				
4-51x	ZS434250	Screw, pan head 4x8, w/washer (CEE, UK)					
4-52x	ZW413188	Nut M4, #1 (CEE, UK)					
4-53	EF306125	△ Fuse 315mA 250V (U/T)	39-1-64				
4-54x	EF308933	△ Fuse 200mA 250V (U/T)	39-1-64				

When ordering parts, please describe Parts Number, Description, and Model Number in detail.

5. PHOTO OF FINAL ASSEMBLY BLOCK

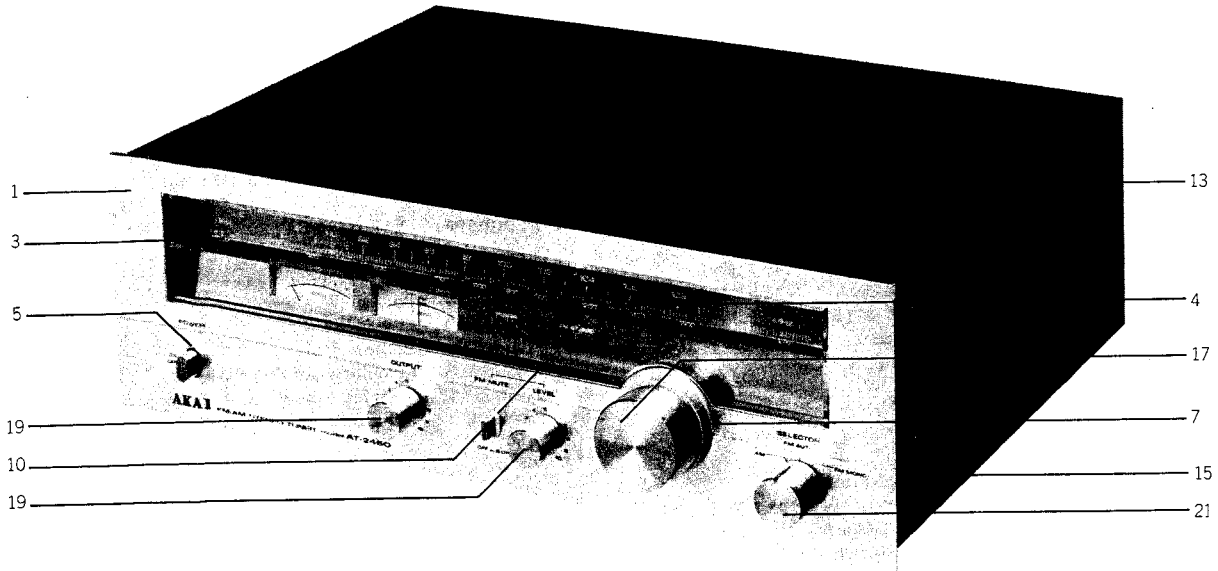

5) FINAL ASSEMBLY BLOCK

Ref. No.	Parts No.	Description	Schematic No.
FRONT PANEL BLOCK			
5-1	BD308062	Front Panel Block Comp. AT-2450	T3-4554
5-2x	BD308061	Front Panel Block Comp. AT-2450-BL	T3-4554
5-3	TA308613	Front Plate	T3-4507
5-4	SE305651	Button Escutcheon (B)	CN-6352
5-5	SE308529	Button Escutcheon (A)	CY-6013
5-6x	SE306936	Button Escutcheon (B-BL)	CN-6352
5-7	SK308641	Tuning Knob Stand	T3-4529
5-8x	SK308642	Tuning Knob Stand (BL)	T3-4529
5-9x	ZS497878	Tapping Screw #2, 3x10(BR) W=8	
5-10	SK305653	Push Button (A)	CN-6309
5-11x	SK305656	Push Button (D) (BL)	CN-6309
5-12x	ZG305657	Button Spring	CN-6310
FINAL ASSEMBLY BLOCK			
5-13	BC308635	Upper Cover (A) (U/T, CSA, CEE, UK)	T3-4524
5-14x	BC308636	Upper Cover (B) (AAL)	T3-4524
5-15	ZS537006	Screw, binding head 4x8 (Black)	
5-16x	ZS308846	Tapping Screw #2, 3x8(BR) (Oval Neck)	7-1-69
5-17	SK308643	Tuning Knob	T3-4530
5-18x	SK308644	Tuning Knob (BL)	T3-4530
5-19	SK308565	Knob (A)	M3-4531
5-20x	SK308566	Knob (A-BL)	M3-4531
5-21	SK308567	Knob (B)	M3-4532
5-22x	SK308568	Knob (B-BL)	M3-4532

MC-Service

When ordering parts, please describe Parts Number, Description, and Model Number in detail.

MODEL AM-2450

6. INPUT & TAPE P.C BOARD (M3-4501A/B) BLOCK

Symbol No.	Parts No.	Description	Schematic No.
INPUT P.C BOARD (M3-4501A) BLOCK			
6-1	BA308020	Input P.C Board Comp. AM-2450	M3-4540
6-IC1	EI305696	IC LA3133	45-8-270
6-SW1	ES308883	Rotary SW. SRZ-K043N(18)	25-6-157
6-J1	EJ293376	6P PIN Jack	31-1-198
6-C2	EC308593	Elect./C. (LL, Homing Type) 4.7 μ F 25WV	24-20-18
TAPE P.C BOARD (M3-4501B) BLOCK			
6-2	BA308022	Tape P.C Board Comp. AM-2450	M3-4540
6-SW2	ES308884	Rotary SW. SRZ-K065T	25-6-158
6-J2	EJ293365	4P PIN Jack	31-1-197
6-J3	EJ293365	4P PIN Jack	31-1-197
6-J4	EJ698051	DIN Jack	31-1-158

7. MAIN VOL. & BALANCE P.C BOARD (M3-4502A/B) BLOCK

Symbol No.	Parts No.	Description	Schematic No.
7-1	BA308017	Main Vol. & Balance P.C Board Comp. AM-2450	M3-4541
7-VR1	EV307189	Single Axial 2 Throw Vol. GM70E-250kMN	36-22-36
7-VR2	EV307188	Single Axial 2 Throw Vol. GM80E-250kBx2	36-22-35
7-SW1	ES308595	2 throw Push SW. J-P7291#01	25-5-296

8. TONE CONTROL P.C BOARD (M3-4503) BLOCK

Symbol No.	Parts No.	Description	Schematic No.
8-1	BA308012	Tone Control P.C Board Comp. AM-2450	M3-4539
8-TR1,2	ET307195	Transistor 2SC2240(GR)(BL)	45-1-302
8-VR1,2	EV308596	Single Axial 2 Throw Vol. GM70E-C50kx2	36-22-39
8-C9	EC662308	Solid Aluminum/C. (Vert. Type) 0.15 μ F(K) 25WV	24-19-2

9. MAIN AMP P.C BOARD (M3-4504A/B) BLOCK

Symbol No.	Parts No.	Description	Schematic No.
9-1	BA308025	Main Amp P.C Board Comp. AM-2450(U/T)(CSA)	M3-4537
9-2	BA308026	Main Amp P.C Board Comp. AM-2450(CEE)(UK)	M3-4537
9-IC1	EI308865	IC TA7318P	45-8-306
9-TR1	ET308866	Transistor 2SA979(G)(H)	45-1-324
9-TR2	ET310168	Transistor 2SC2229(O)(Y)	45-1-305
9-TR3	ET308867	Transistor 2SA1015(O)(Y)(GR)	45-1-328
9-TR5	ET308870	Transistor 2SC2235(O)(Y)	45-1-331
9-TR6	ET308868	Transistor 2SA965(O)(Y)	45-1-329
9-TR9	ET307195	Transistor 2SC2240(GR)(BL)	45-1-302
9-TR10	ET308867	Transistor 2SA1015(O)(Y)(GR)	45-1-328
9-TR11,12	ET305221	Transistor 2SC1815(O)(Y)(GR)	45-1-299
9-TR13	ET403391	Transistor 2SC536(G)(H)	45-1-55
9-TR14	ET666404	Transistor 2SD571(K)(L)	45-1-218
9-TR15	ET305221	Transistor 2SC1815(O)(Y)(GR)	45-1-299
9-TR16	ET308868	Transistor 2SA965(O)(Y)	45-1-329
9-TR17	ET307193	Transistor 2SD612K(D)(E)(F)	45-1-308
9-D1to5	ED214457	Silicon Diode 1S2472	45-3-41
9-D6	ED240377	Zener Diode RD36E(C)	45-6-72
9-D7,8	ED300924	Silicon Diode GP08D	45-2-68
9-D9to12	ED245428	Silicon Diode GP30G	45-2-69
9-D13,14	ED624903	Silicon Diode 1S2473	45-3-28
9-L1,2	EO650823	Phase Compensation Coil 2.2 μ H(K)	23-1-239
9-RL1	EP245305	Relay MS24D4-0Z	47-1-28
9-VR1	EV300921	Semi-fixed/Vol. V10K8-1-2 1kB	36-10-255
9-VR2,3	EV301637	Semi-fixed/Vol. V10K8-1-2 500 ohms(B)	36-10-255
9-R17,18	ER622978	Metal Plate/R. MPC71F1 5W 0.47 ohm (K)	35-16-48
9-R40	ER389687	Metal Oxide Film/R. 1W 220 ohms (K)	35-15-10
9-R43,44	ER409814	Metal Oxide Film/R. 2W 220 ohms (K)	35-15-8
9-C1	EC621257	Solid Aluminum/C. (Vert. Type) 0.47 μ F(M) 25WV	24-19-2
9-C17	EC662128	Solid Aluminum/C. (Vert. Type) 2.2 μ F(M) 25WV	24-19-2
9-C33	EC308877	NP Elect./C. (Homing Type) 3.3 μ F(M) 25WV	24-17-31
9-C36	EC308877	NP Elect./C. (Homing Type) 3.3 μ F(M) 25WV	24-17-31
9-3	ZS325495	Tapping Screw #2, 3x6 (BR)	
9-4	ZS447840	Tapping Screw #2, 3x8 (BR)	
HEAT-SINK BLOCK			
9-TR7	ET308879	Transistor 2SD718(R)(O)	45-1-322
9-TR8	ET308880	Transistor 2SB688(R)(O)	45-1-323
9-5	ZW310167	Insulator Washer AC331	45-16-35
9-6	ZS421806	Screw, pan head 3x8	

10. ILLUSTRATION OF ASSEMBLY BLOCK

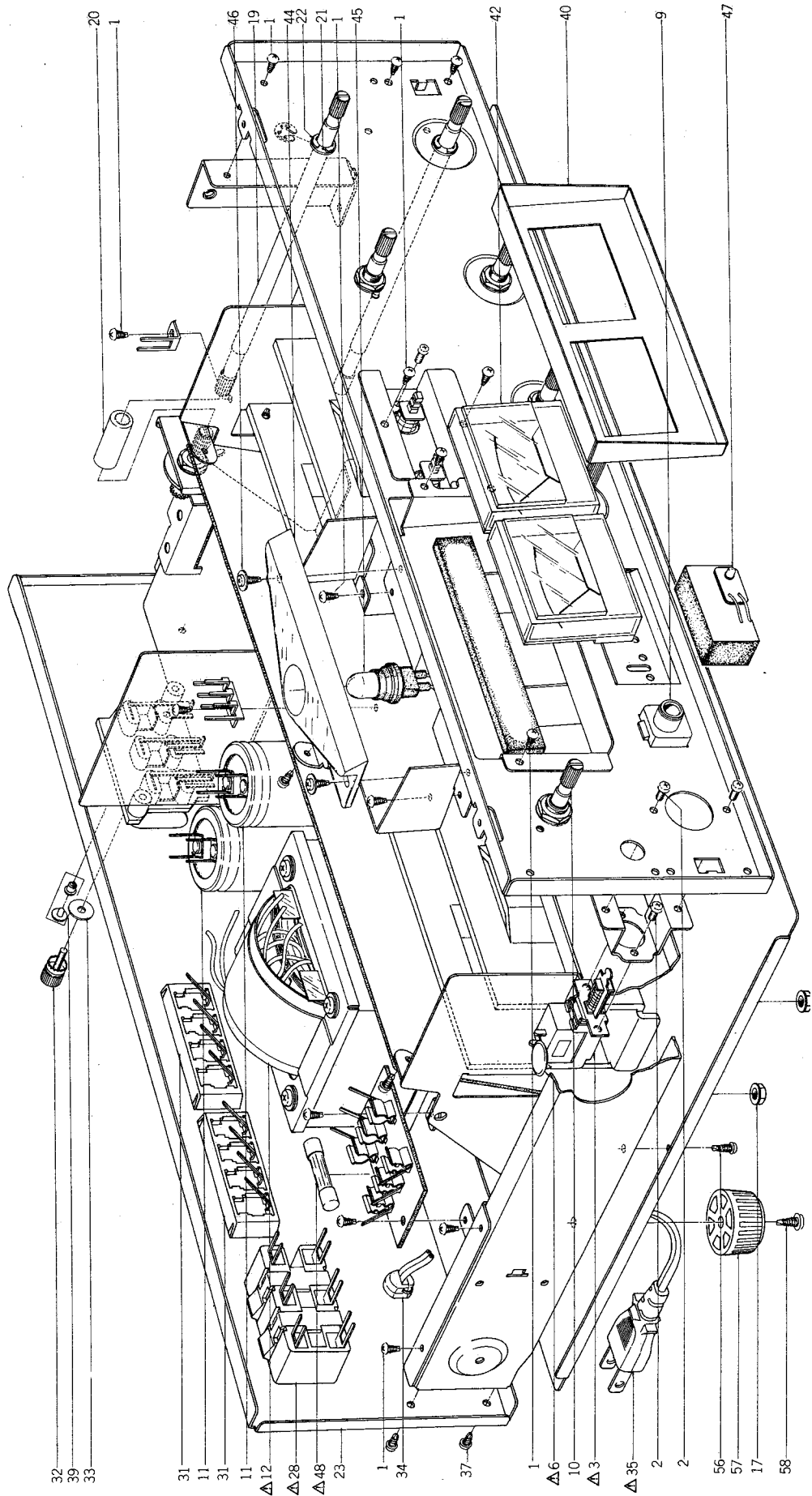

10) ASSEMBLY BLOCK

Ref. No.	Parts No.	Description	Schematic No.	Ref. No.	Parts No.	Description	Schematic No.
10-1	ZS325495	Tapping Screw #2, 3x6 (BR)		10-55	SP308560	Bottom Plate	M3-4528
10-2	ZS379350	Screw, pan head 3x6		10-56	ZS447840	Tapping Screw #2, 3x8(BR)	
10-3	ES224436	△ Push SW. JP01	25-5-221	10-57	EA312465	Circular Foot (A) Part CA	CA-6014
10-4x	ES280258	△ Push SW. SDV1P TV-5 (w/label)(CSA, AAL)	25-5-243	10-58	ZS565942	Tapping Screw #2, 4x8(Pan)	
10-5x	ES242346	△ Push SW. JP17 (CEE, UK)	25-5-224				
10-6	EC204671	△ Ceramic/C. DD31-6E 0.01μF(P) 500WV(U/T)	24-5-66				
10-7x	EC294118	△ Ceramic/C. DPN6600 YM 0.01μF(P) 125WV(CSA,AAL)	24-5-70				
10-8x	EC301320	△ MP/C. 4700PF(M) 250WV (CEE, UK)	24-9-122				
10-9	EJ301199	Headphone Jack 3P64M	31-2-83				
10-10	ES308581	Rotary SW. SR321N 1-2-4	25-7-51				
10-11	EC308585	Elect./C. 10000μF 52WV	24-10-129				
10-12	BT308591	△ Power Trans. AM-2450T-70 (U/T)	38-4-653				
10-13x	BT308588	△ Power Trans. AM-2450T-30 (CSA)	38-4-650				
10-14x	BT308587	△ Power Trans. AM-2450T-20 (AAL)	38-4-649				
10-15x	BT308589	△ Power Trans. AM-2450T-40 (CEE)	38-4-651				
10-16x	BT308590	△ Power Trans. AM-2450T-50 (UK)	38-4-652				
10-17	ZW413267	Flange Nut M4					
10-18x	ZS434250	Screw, pan head 4x8, w/washer (CEE, UK)					
10-19	MS308569	Relay Shaft	M3-4533				
10-20	TA646773	Joint	AA-5240				
10-21	ZW322110	Washer (Nylon) D6.1x10x1t					
10-22	ZW270123	'E' Ring 4M	6-1-9				
10-23	SP308546	Rear Panel (A) (U)(U/T)	M3-4518				
10-24x	SP308547	Rear Panel (B) (C)(CSA)	M3-4519				
10-25x	SP308548	Rear Panel (C) (A) (AAL)	M3-4519				
10-26x	SP308549	Rear Panel (D) (E)(CEE)	M 3-4520				
10-27x	SP308550	Rear Panel (E) (B)(UK)	M3-4520				
10-28	EJ240535	△ 3-throw AC Outlet (U/T, CSA, AAL)	31-1-173				
10-29x	EJ296853	△ 3P In-let CM-3 (CEE, UK)	31-1-199				
10-30x	ZS463353	Tapping Screw #2, 3x8 (BR) (Black) (CEE, UK)					
10-31	EJ306942	4P Push Terminal S-Q2361	32-1-86				
10-32	EJ306940	Earth Terminal	32-1-87				
10-33	ZW651082	Washer (SPC) D3.2x10x1t					
10-34	EZ631945	Strain Relief SR-4N-4	2-7-49				
10-35	EW306428	△ AC Cord (U/T)	26-3-64				
10-36x	EW305691	△ AC Cord CUL (CSA, AAL)	26-3-65				
10-37	ZS447761	Tapping Screw #2, 3x6(BR) (Black)					
10-38x	ZS522865	Tapping Screw #2, 3x12(BR) (Black)					
10-39	ZW698308	Nylon Rivet (FNRP) 3x5.5 (Black)	2-7-54				
10-40	SP308535	Meter Panel	M3-4510, 4511				
10-41x	SP308536	Meter Panel (BL)	M3-4510, 4511				
10-42	EM308881	Level Meter D18C54R	46-1-205				
10-43x	EM308882	Level Meter D18C55R (BL)	46-1-206				
10-44	TA308638	Meter Illumination Plate	T3-4526				
10-45	EL308840	Lamp (Cord Type) 8V 300mA (600mmx2)	28-2-71				
10-46	ZS498273	Tapping Screw #2, 3x8(BR) W=8					
10-47	ED308592	LED SY-405D	45-15-20				
10-48	EF563703	△ Fuse 2A 250V (U/T)	39-1-50				
10-49x	EF575212	△ Fuse 4A 250V (U/T)	39-1-50				
10-50x	EF277424	△ Fuse ST-4 0.8A (CSA,AAL)	39-1-28				
10-51x	EF304303	△ Fuse ST-6 3.15A (CSA, AAL)	39-1-63				
10-52x	EF601942	△ Fuse (SEMKO T Type) 630mAT (CEE, UK)	39-1-53				
10-53x	EF690996	△ Fuse (SEMKO T Type) 4AT (CEE, UK)	39-1-53				
10-54x	EF601301	△ Fuse (SEMKO T Type) 2AT (UK)	39-1-53				

When ordering parts, please describe Parts Number, Description, and Model Number in detail.

11. PHOTO OF FINAL ASSEMBLY BLOCK

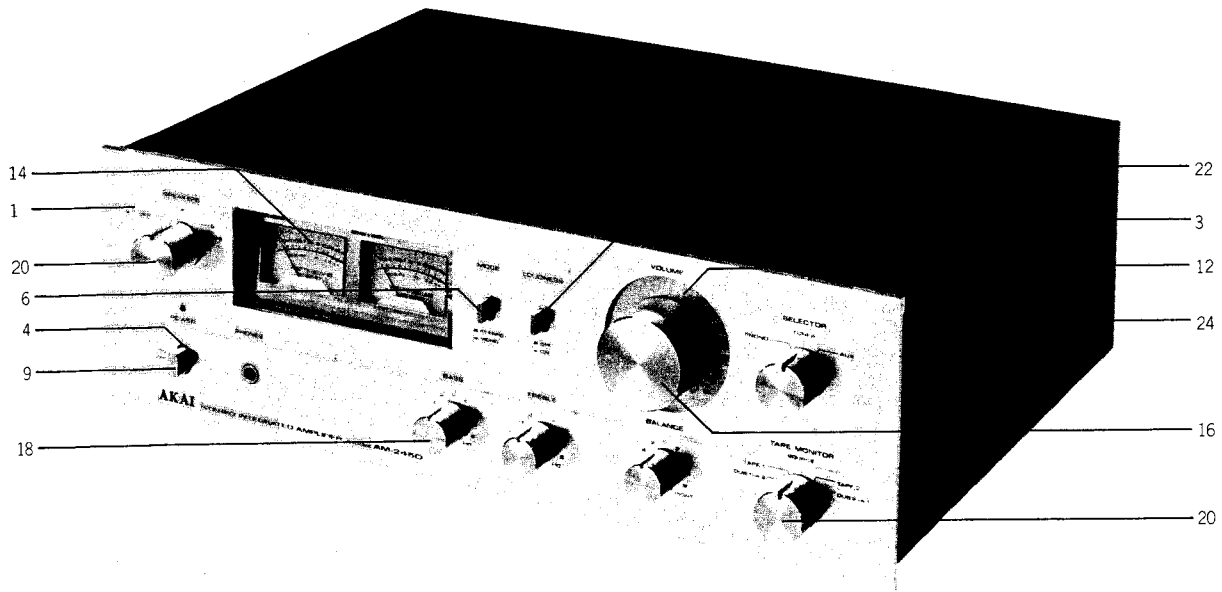

11) FINAL ASSEMBLY BLOCK

Ref. No.	Parts No.	Description	Schematic No.
FRONT PANEL BLOCK			
11-1	BD308010	Front Panel Block Comp. AM-2450	M3-4534
11-2x	BD308011	Front Panel Block Comp. AM-2450-BL	M3-4534
11-3	SE305651	Button Escutcheon (B)	CN-6352
11-4	SE306863	Button Escutcheon	M3-2522
11-5x	SE306936	Button Escutcheon (B-BL)	CN-6352
11-6	SK305653	Push Button (A)	CN-6309
11-7x	SK305656	Push Button (D) (BL)	CN-6309
11-8x	ZG305657	Button Spring	CN-6310
11-9	SK306864	Push Button	M3-2523
11-10x	SK306866	Push Button (BL)	M3-2523
11-11x	ZG306867	Taper Spring	M3-2524
11-12	TA308532	Vol. Plate	M3-4507, 4508
11-13x	TA308998	Vol. Plate (BL)	M3-4507, 4508
11-14	TA308534	Meter Plate	M3-4509
FINAL ASSEMBLY BLOCK			
11-15x	ZS447840	Tapping Screw #2, 3x8(BR)	
11-16	SK308562	Vol. Knob	M3-4530
11-17x	SK308563	Vol. Knob (BL)	M3-4530
11-18	SK308565	Knob (A)	M3-4531
11-19x	SK308566	Knob (A-BL)	M3-4531
11-20	SK308567	Knob (B)	M3-4532
11-21x	SK308568	Knob (B-BL)	M3-4532
11-22	BC308561	Upper Cover (A) (U/T, CSA, CEE, UK)	M3-4529
11-23x	BC308571	Upper Cover (B) (AAL)	M3-4529
11-24	ZS537006	Screw, binding head 4x8	
11-25x	ZS447761	Tapping Screw #2, 3x6(BR) (Black)	

When ordering parts, please describe Parts Number, Description, and Model Number in detail.

INDEX

Parts No.	Ref. No. & Symbol No.	Parts No.	Ref. No. & Symbol No.	Parts No.	Ref. No. & Symbol No.	Parts No.	Ref. No. & Symbol No.	Parts No.	Ref. No. & Symbol No.
BA308012	8-1	EI307199	2-IC1	EV308853	2-VR3	ZS325495	10-1		
BA308017	7-1	EI308850	2-IC4	EV308854	2-VR2	ZS379350	4-15x		
BA308020	6-1	EI308865	9-IC1	EV560136	2-VR1	ZS379350	10-2		
BA308022	6-2	EI697871	2-IC2	EV650891	2-VR4	ZS421806	9-6		
BA308025	9-1	EJ240535	10-28	EW305691	4-35x	ZS434250	4-51x		
BA308026	9-2	EJ293365	6-J2	EW305691	10-36x	ZS434250	10-18x		
BA308066	3-3	EJ293365	6-J3	EW306428	4-34	ZS447761	4-27x		
BA308067	3-2	EJ293376	6-J1	EW306428	10-35	ZS447761	10-37		
BA308069	3-1	EJ296853	4-37x	EZ631945	4-36	ZS447761	11-25x		
BA308077	2-1	EJ296853	10-29x	EZ631945	10-34	ZS447840	4-65		
BA311178	3-4	EJ301199	10-9	MI301149	4-48	ZS447840	9-4		
BC308561	11-22	EJ306940	10-32	MS308569	10-19	ZS447840	10-56		
BC308571	11-23x	EJ306942	10-31	MZ307170	4-5	ZS447840	11-15x		
BC308635	5-13	EJ308832	4-29	SE305651	5-4	ZS463353	4-38x		
BC308636	5-14x	EJ308834	4-33	SE305651	11-3	ZS463353	10-30x		
BD308010	11-1	EJ698051	6-J4	SE306863	11-4	ZS497878	5-9x		
BD308011	11-2x	EL307157	4-16	SE306936	5-6x	ZS498273	4-11		
BD308061	5-2x	EL308839	4-17	SE306936	11-5x	ZS498273	10-46		
BD308062	5-1	EL308840	4-18x	SE308529	5-5	ZS522865	4-30		
BT307204	2-T2	EL308840	10-45	SK305653	5-10	ZS522865	10-38x		
BT308587	10-14x	EM300354	4-9x	SK305653	11-6	ZS537006	5-15		
BT308588	10-13x	EM300355	4-7x	SK305656	5-11x	ZS537006	11-24		
BT308589	10-15x	EM308843	4-8	SK305656	11-7x	ZS565942	4-64		
BT308590	10-16x	EM308844	4-6	SK305674	4-60	ZS565942	10-58		
BT308591	10-12	EM308881	10-42	SK306130	4-61x	ZW231030	4-19x		
BT308829	4-40x	EM308882	10-43x	SK306864	11-9	ZW270123	10-22		
BT308830	4-41x	EO307186	2-T1	SK306866	11-10x	ZW308889	4-13		
BT308831	4-42x	EO307202	2-T4	SK308562	11-16	ZW308890	4-14		
BT308859	4-39	EO307203	2-T5	SK308563	11-17x	ZW310167	9-5		
BT444137	4-31	EO307205	2-T3	SK308565	5-19	ZW322110	10-21		
EA312465	4-63	EO539820	2-L2,3	SK308565	11-18	ZW413188	4-52x		
EA312465	10-57	EO539820	2-L4	SK308566	5-20x	ZW413267	10-17		
EC204671	3-C1	EO539820	3-L1	SK308566	11-19x	ZW651082	10-33		
EC204671	3-C2	EO650610	2-L1	SK308567	5-21	ZW698308	10-39		
EC204671	3-C3	EO650823	9-L1,2	SK308567	11-20				
EC204671	10-6	EP245305	9-RL1	SK308568	5-22x				
EC294118	3-C1	ER308617	2-FL1to4	SK308568	11-21x				
EC294118	10-7x	ER308855	2-FL5,6	SK308641	5-7				
EC301320	3-C1	ER389687	9-R40	SK308642	5-8x				
EC301320	10-8x	ER409814	9-R43,44	SK308643	5-17				
EC306987	2-C64	ER622978	9-R17,18	SK308644	5-18x				
EC307257	2-C1	ES224436	10-3	SP308535	10-40				
EC308585	10-11	ES242346	3-SW1	SP308536	10-41x				
EC308593	6-C2	ES242346	10-5x	SP308546	10-23				
EC308877	9-C33	ES280258	10-4x	SP308547	10-24x				
EC308877	9-C36	ES308581	10-10	SP308548	10-25x				
EC621257	9-C1	ES308595	7-SW1	SP308549	10-26x				
EC638188	2-C65	ES308851	2-SW2	SP308550	10-27x				
EC662128	9-C17	ES308852	2-SW1	SP308560	10-55				
EC662308	8-C9	ES308858	3-SW1	SP308606	4-20				
ED214457	9-D1to5	ES308863	3-SW1	SP308607	4-21x				
ED223547	3-D2	ES308883	6-SW1	SP308619	4-22				
ED240377	9-D6	ES308884	6-SW2	SP308620	4-23x				
ED245428	9-D9to12	ET305221	9-TR11,12	SP308621	4-24x				
ED300924	9-D7,8	ET305221	9-TR15	SP308622	4-25x				
ED308592	4-2	ET307193	3-TR1	SP308623	4-26x				
ED308592	10-47	ET307193	9-TR17	SP308634	4-62				
ED308860	3-D3	ET307195	8-TR1,2	TA307160	4-50				
ED624903	2-D1to9	ET307195	9-TR9	TA308109	4-47				
ED624903	3-D1	ET308866	9-TR1	TA308532	11-12				
ED624903	9-D13,14	ET308867	9-TR3	TA308534	11-14				
ED698826	4-1	ET308867	9-TR10	TA308609	4-46				
EE308833	4-32	ET308868	9-TR6	TA308613	5-3				
EE308838	4-45	ET308868	9-TR16	TA308638	4-10				
EF277424	10-50x	ET308870	9-TR5	TA308638	10-44				
EF300596	4-57x	ET308879	9-TR7	TA308837	4-12				
EF300596	4-59x	ET308880	9-TR8	TA308998	11-13x				
EF304303	10-51x	ET310168	9-TR2	TA646773	10-20				
EF306125	4-53	ET403391	9-TR13	TC289484	4-44				
EF308847	4-55x	ET618873	2-TR2,3	ZG300891	4-49				
EF308848	4-56x	ET632215	2-TR1	ZG305657	5-12x				
EF308933	4-54x	ET632215	2-TR4to7	ZG305657	11-8x				
EF563703	10-48	ET632215	3-TR2	ZG306867	11-11x				
EF575212	10-49x	ET666404	9-TR14	ZS297641	4-4x				
EF601301	10-54x	EV300921	9-VR1	ZS308513	4-43				
EF601942	10-52x	EV301637	9-VR2,3	ZS308673	4-28x				
EF601964	4-58x	EV307188	7-VR2	ZS308846	5-16x				
EF690996	10-53x	EV307189	7-VR1	ZS325495	3-2				
EI305696	6-IC1	EV307246	2-VR5	ZS325495	4-3				
EI307198	2-IC3	EV308596	8-VR1,2	ZS325495	9-3				

SECTION 3

SCHEMATIC DIAGRAM

1. AT-2450 No. 2-1 1562040A SCHEMATIC DIAGRAM
2. AM-2450 No. 2-2 1562041A SCHEMATIC DIAGRAM

MC-Service

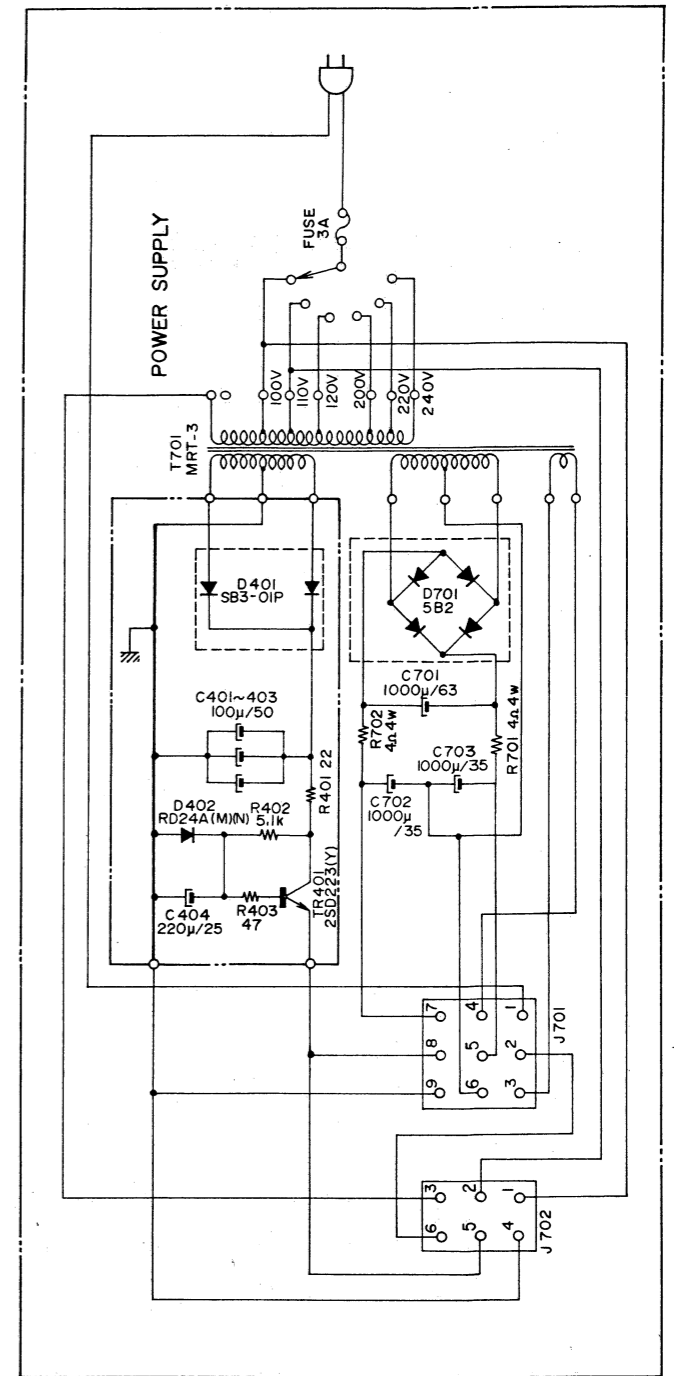
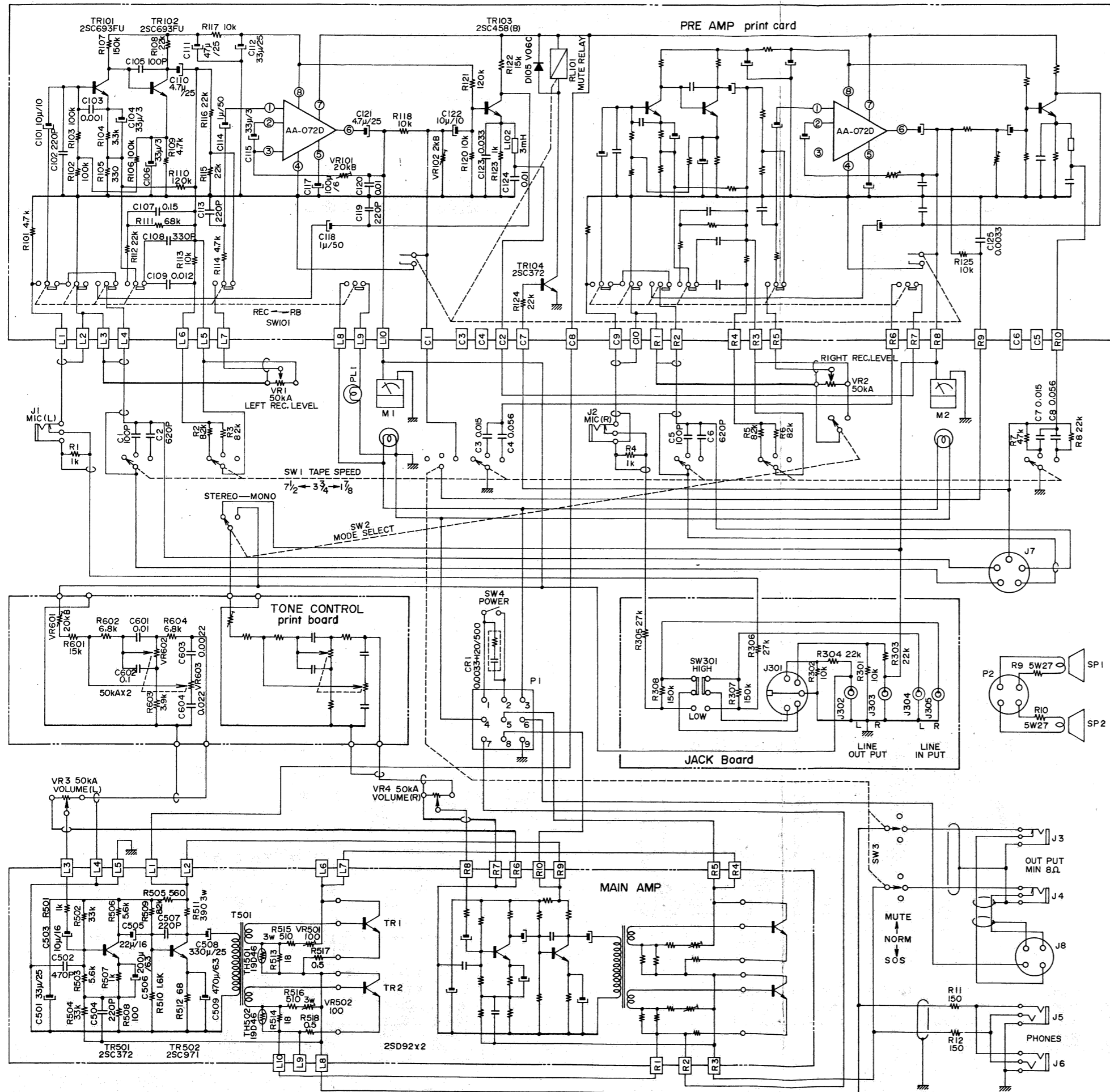

ALL RESISTOR 1/4 WATT UNLESS OTHERWISE NOTED.
ALL CAPACITY µF UNLESS OTHERWISE NOTED.

**M-10 AMPLIFIER
SCHEMATIC DIAGRAM**
NO.2-2 13816560

MC-Service

μPC1178C

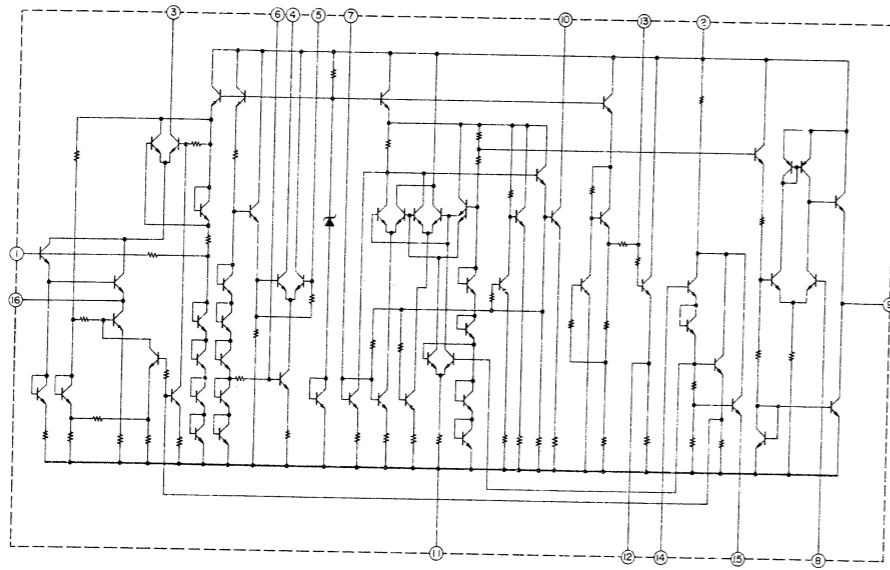

μPC1173C

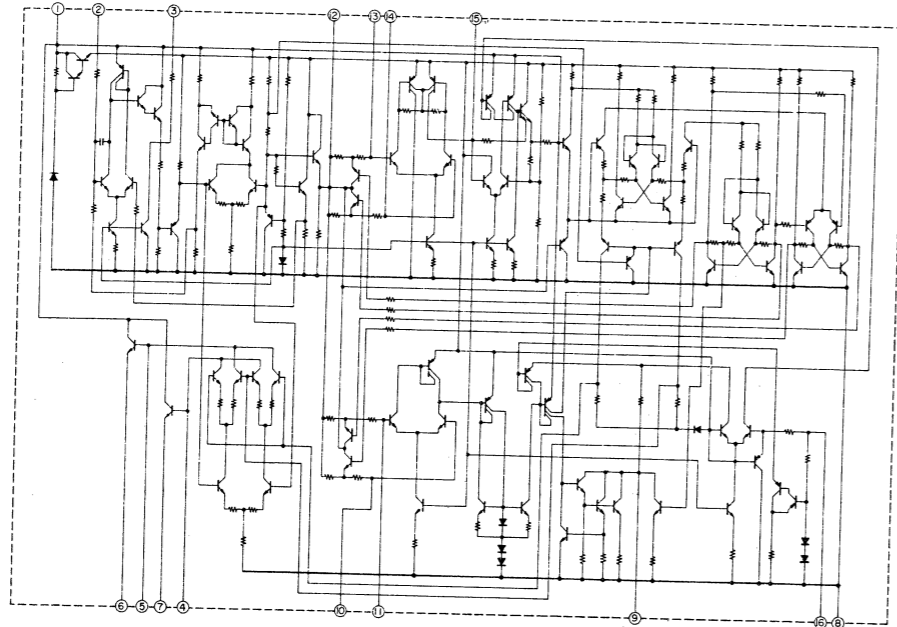

LA-3122S

