

AKAI SERVICE MANUAL

RTV servis Horvat

Kešinci, 31402 Semeljci

Tel : 031-856-637

Tel / fax : 031-856-139

Mob : 098-788-319

rtv-servis-horvat@os.tel.hr

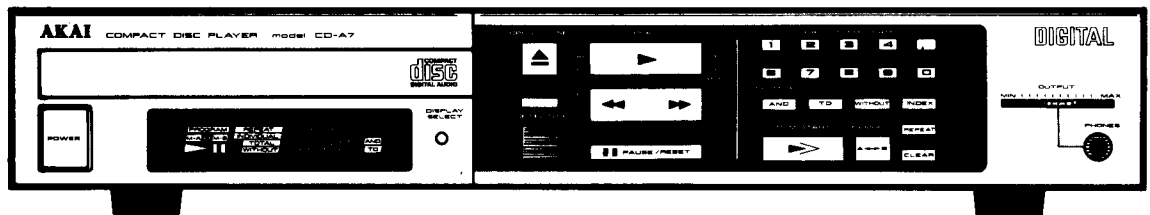

COMPACT DISC PLAYER

MODEL **CD-A7**

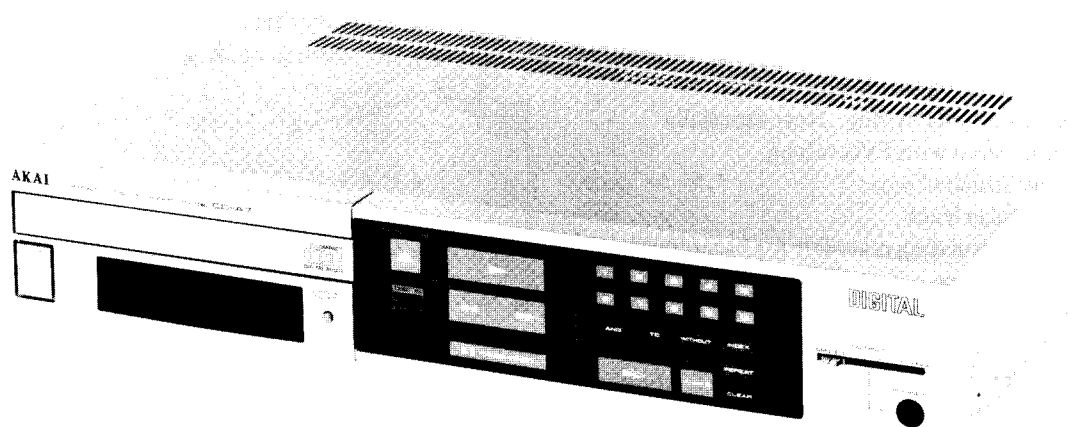

* FOR THE CIRCUIT DESCRIPTION, PLEASE REFER TO THE TECHNICAL HAND BOOK AUDIO I "COMPACT DISC AND PLAYER".

CD-A7 uses three-spot method for tracking servo, and Astigmatic Method for Focus servo.

COMPACT DISC PLAYER

MODEL CD-A7

SECTION 1	SERVICE MANUAL	5
SECTION 2	PARTS LIST	15

SAFETY INSTRUCTIONS

SAFETY CHECK AFTER SERVICING

Confirm the specified insulation resistance between power cord plug prongs and externally exposed parts of the set is greater than 10 Mohms, but for equipment with external antenna terminals (tuner, receiver, etc.) and is intended for **C** or **A**, specified insulation resistance should be more than 2.2 Mohms (ground terminals, microphone jacks, headphone jacks, line-in-out jacks etc.)

PRECAUTIONS DURING SERVICING

1. Parts identified by the \triangle symbol parts are critical for safety.
Replace only with parts number specified.
2. In addition to safety, other parts and assemblies are specified for conformance with such regulations as those applying to spurious radiation. These must also be replaced only with specified replacements.
Examples: RF converters, tuner units, antenna selector switches, RF cables, noise blocking capacitors, noise blocking filters, etc.
3. Use specified internal wiring. Note especially:
 - 1) Wires covered with PVC tubing
 - 2) Double insulated wires
 - 3) High voltage leads
4. Use specified insulating materials for hazardous live parts. Note especially:
 - 1) Insulation Tape
 - 2) PVC tubing
 - 3) Spacers (Insulating Barriers)
 - 4) Insulation sheets for transistors
 - 5) Plastic screws for fixing microswitch (especially in turntable)
5. When replacing AC primary side components (transformers, power cords, noise blocking capacitors, etc.), wrap ends of wires securely about the terminals before soldering.

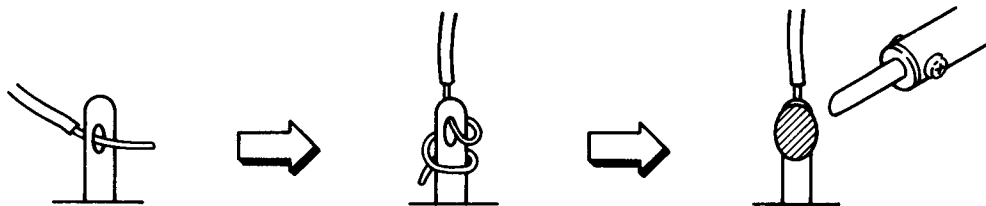

6. Observe that wires do not contact heat producing parts (heatsinks, oxide metal film resistors, fusible resistors, etc.).
7. Check that replaced wires do not contact sharp edged or pointed parts.
8. Also check areas surrounding repaired locations.
9. Use care that foreign objects (screws, solder droplets, etc.) do not remain inside the set.

VOLTAGE CONVERSION

Models for some countries are not equipped with this facility, each machine is preset at the factory according to its destination, but some machines can be set to 110V, 120V, 220V or 240V as required.

If your machine's voltage can be converted.

Before connecting the power cord, turn the VOLTAGE SELECTOR located on the rear panel with a screwdriver until the correct voltage is indicated.

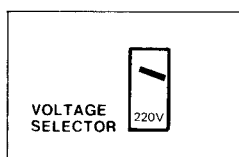

SYCLE CONVERSION

Sycle conversion is not necessary, since CD-A7 uses DC motors.

PRECAUTIONS IN REPAIRING

When repairing or adjusting the unit, please note the following points.

1. Do not put excessive pressure on the mecha part (operation part), including the pick-up block, as extremely high mechanical precision is required in these parts.
2. When the base is removed for repair or adjustment, make sure that there are no metal objects in the narrow gap between the PC Board or the mecha parts and the base.
3. The input processing IC (HA12049A) and the CD signal processing ICs (HD61Z001, HD61901A, HD61902A and HM6119) can be damaged by static electricity or leakage from a soldering iron during repairing. While soldering, please take the precautions against leakage as in the illustration below.

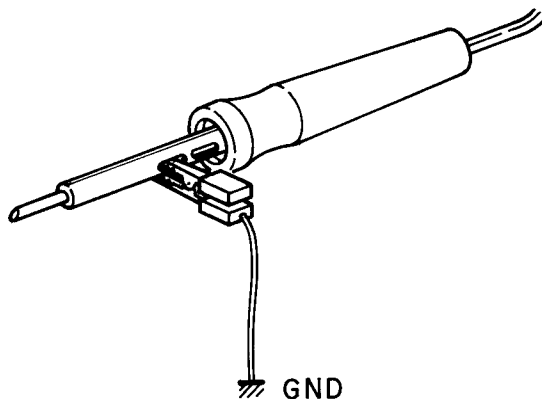

4. Do not loosen any screws in the pick-up block. When handling the pick-up block, please refer to the points to NOTE when replacing the pick-up block.
5. Keep safety from hazardous Laser Beam Radiation, DO NOT watch the Laser Beam (objective Lens) Directly.

SECTION 1

SERVICE MANUAL

TABLE OF CONTENTS

I. TECHNICAL DATA	6
II. DISMANTLING OF UNIT	7
III. CONTROLS	8
IV. PLINCIPAL PARTS LOCATION	9
V. REPLACEMENT OF THE PICK-UP BLOCK	10
VI. ADJUSTMENT	11
VII. PC BOARD TITLE AND IDENTIFICATION NUMBERS	14

For basic adjustments, measuring methods, and operating principles, refer to GENERAL TECHNICAL MANUAL.

I. SPECIFICATIONS

SENSOR TYPE	Optical
QUANTUM BIT	16
CHANNEL	2
SAMPLING FREQUENCY	44.1kHz
FREQUENCY RESPONCE	5 to 20.000Hz \pm 0.5dB
T.H.D.	0.005% (1kHz)
CHANNEL SEPARATION	85dB (1kHz)
DYNAMIC RANGE	90dB
S/N RATIO	90dB
WOW & FLUTTER	Below measurable limits
LINE OUTPUT LEVEL	2V
ACCESS TIME	2.6 Sec
POWER REQUIREMENTS	AC100V 50/60Hz for Japan AC120V 60Hz for USA & Canada AC220V 50Hz for Europe except UK AC240V 50Hz for UK & Australia AC 110/120/220/240V, 50/60Hz convertible for other countries
DIMENSIONS	440(W) \times 76(H) \times 225(D)mm (17.6 \times 3.0 \times 9.0 inches)
WEIGHT	5.8kg (12.8lbs)
REMOTE CONTROL UNIT RC-M80	
TYPE	Infrared pulse position modulation
CARRER FREQUENCY	38kHz \pm 0.2kHz
RANGE	8m
DIRECTIVITY	\pm 30 $^\circ$
POWER SUPPLY	Battery R6 (or AA, UM-3)X2 (3V)
DIMENSIONS	75(W) \times 18(H) \times 162(D)mm (3.0 \times 0.72 \times 6.5 inches)
WEIGHT	150g (0.33lbs) including Batteries

* For improvement purposes, specifications and design are subject to change without notice.

II. DISMANTLING OF UNIT

In case of trouble, etc. necessitating dismantling, please dismantle in the order shown in the photographs. Reassemble in reverse order.

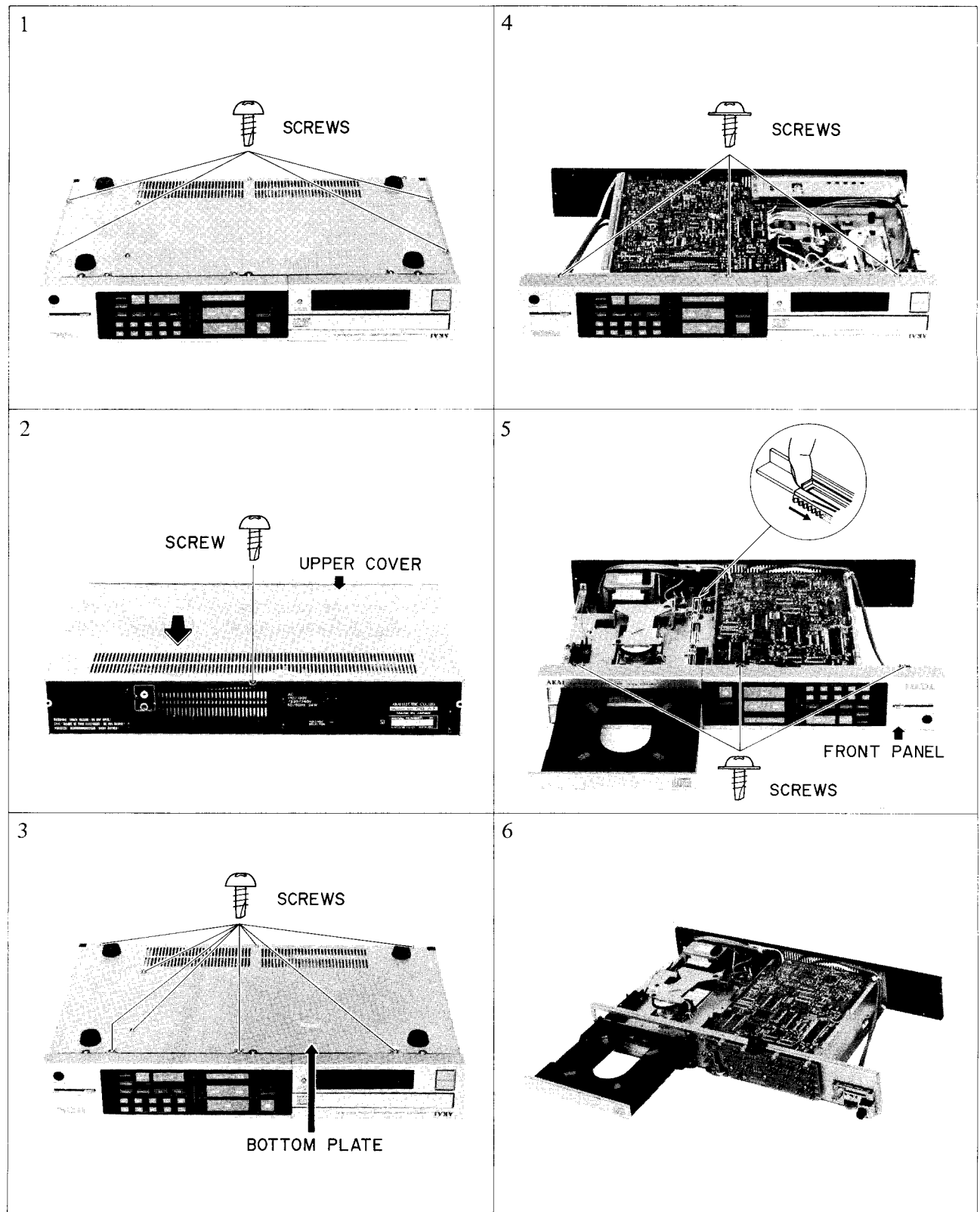

IV. PRINCIPAL PARTS LOCATION

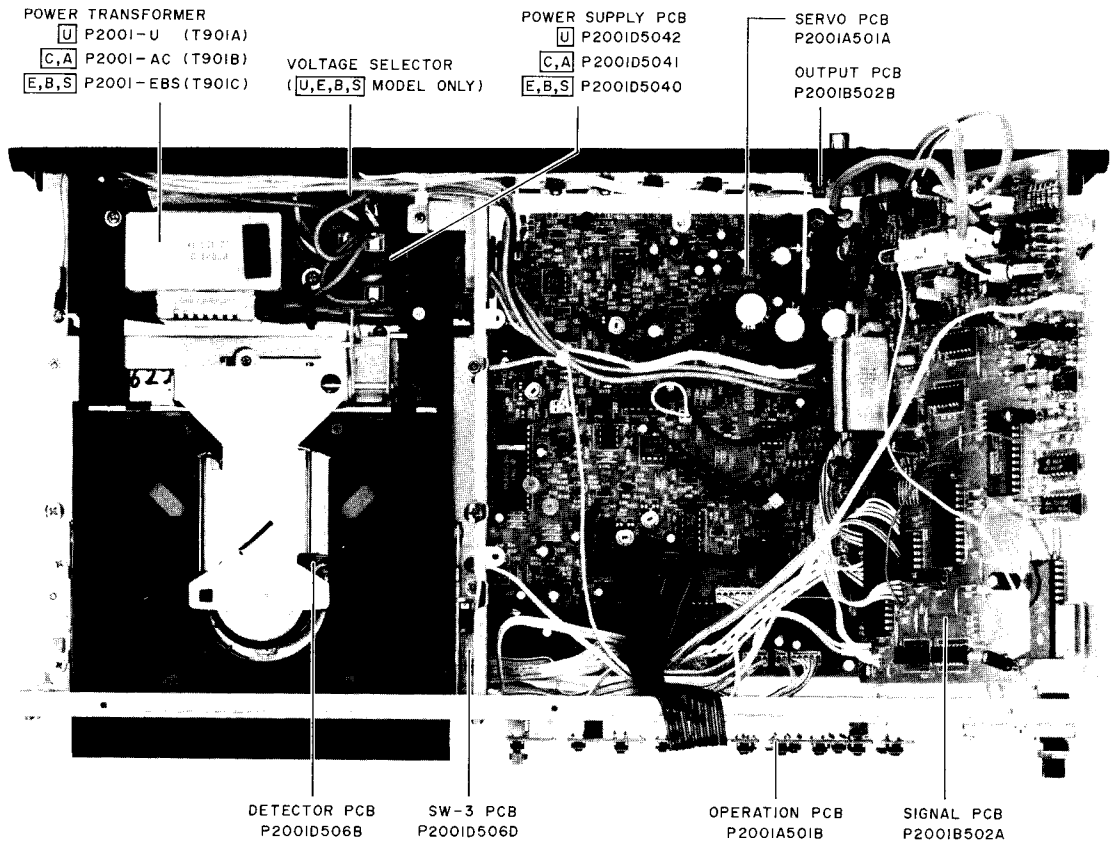

Fig. 4-1 Upper View

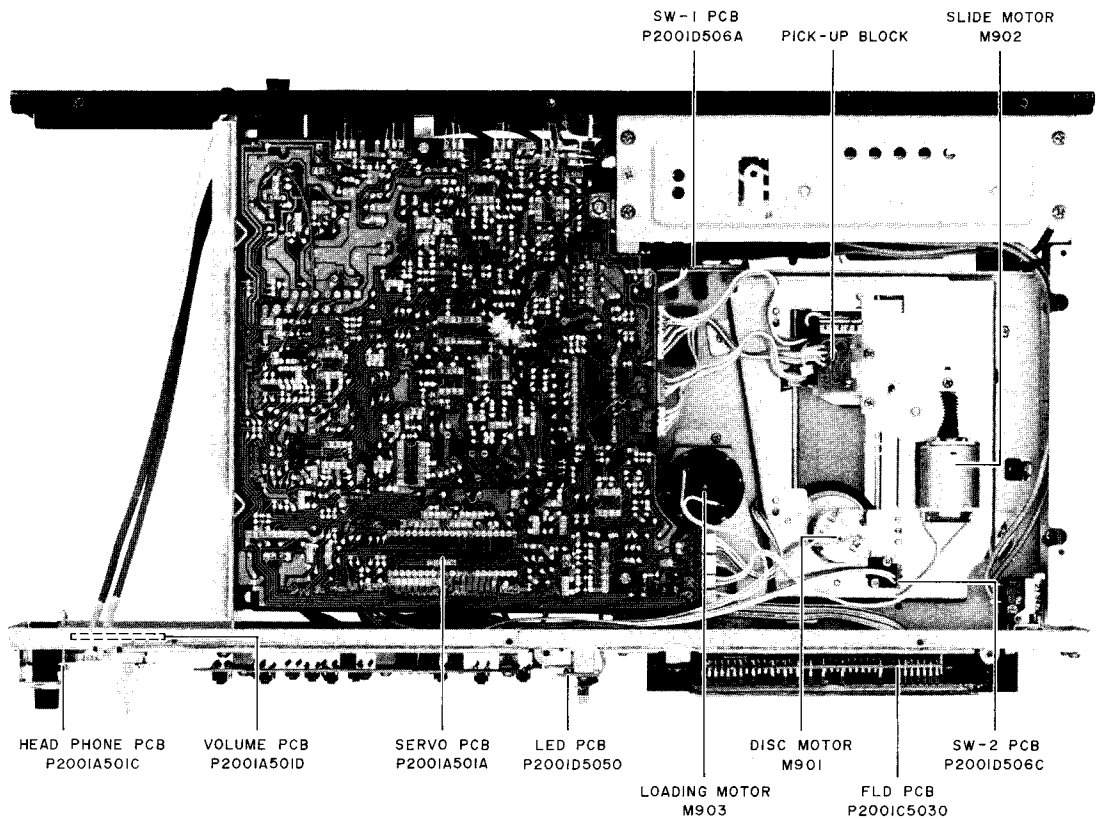

Fig. 4-2 Bottom View

V. REPLACEMENT OF THE PICK-UP BLOCK

5-1. PRECAUTIONS, WHEN REPLACING THE PICK-UP BLOCK

- 1) The LD (Laser Diode) fixed on the pick-up block PC Board can be damaged by static electricity or leakage from a soldering iron.
Do not touch the PC Board of the pick-up block, or use a tester to check if the electricity is on. When soldering, make sure that precautions are taken to prevent leakage from the soldering iron.
- 2) Avoid scratches, dirt or dust on the lense of the pick-up caused by touching with the fingers.
- 3) When connection or disconnection the RED connector, make sure that the PC Board is shorted circuit.
Do not turn the electricity on while it remains shorted-circuited.

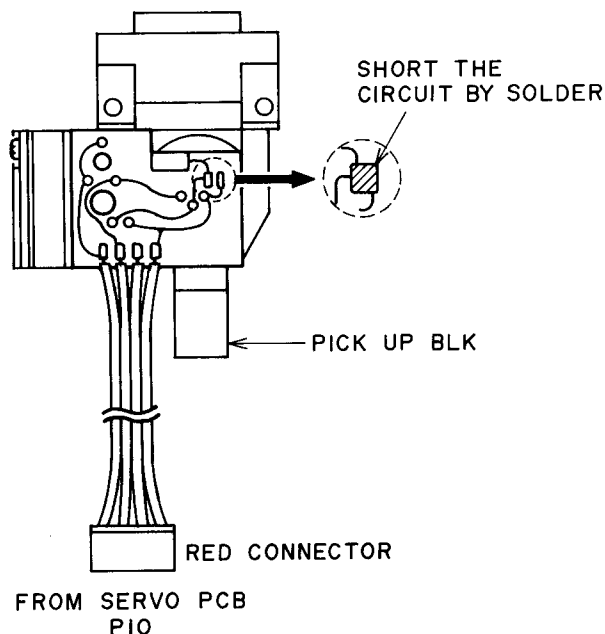

Fig. 5-1

5-2. PROCEDURES FOR CHANGING THE PICK-UP BLOCK

- 1) Remove the top cover and the base and turn the power on. Press the eject button and open the disk holder. Then turn the power off.
- 2) Remove the three connectors on the pick-up block: P10, 15 and 16.
Note: Make sure the LD is short circuited before removing the connectors.

- 3) Remove the slide gear fixed at the button. Refer to Fig. 4-2.
- 4) Move the disk clamber lever aside with a finger and remove the three disk motor fixing screws, (A), (B) and (C).
- 5) When the four screws (D), (E), (F) and (G), for the metal fittings of the pick-up guide rail are removed, the pick-up block guided rail can be removed.

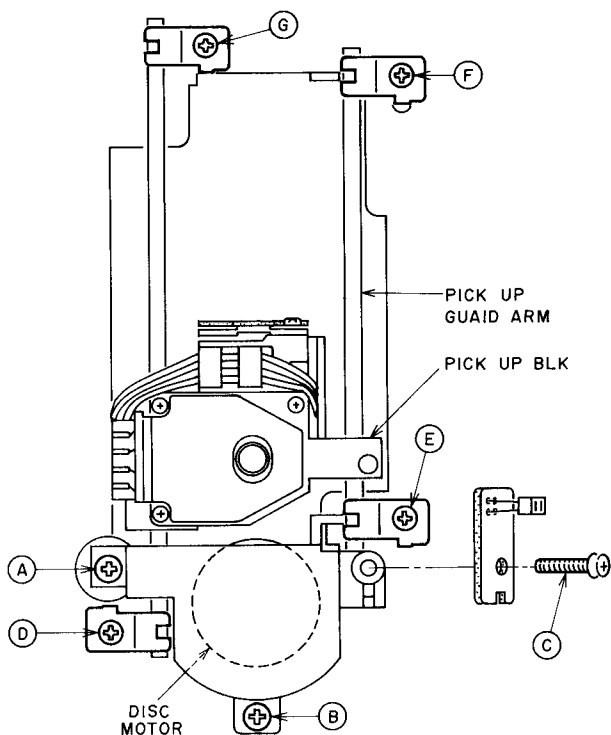

Fig. 5-2 TOP VIEW

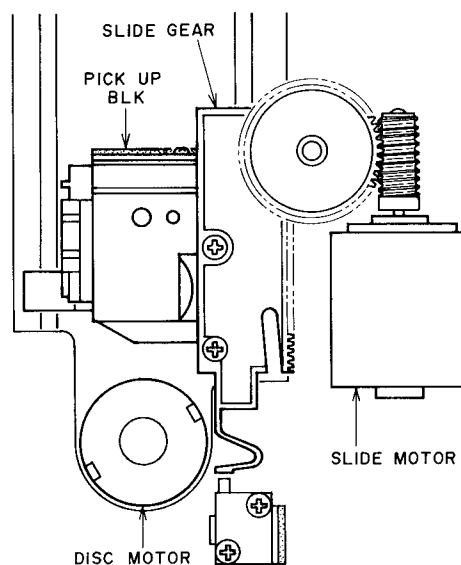

Fig. 5-3 BOTTOM VIEW

VI. ADJUSTMENT

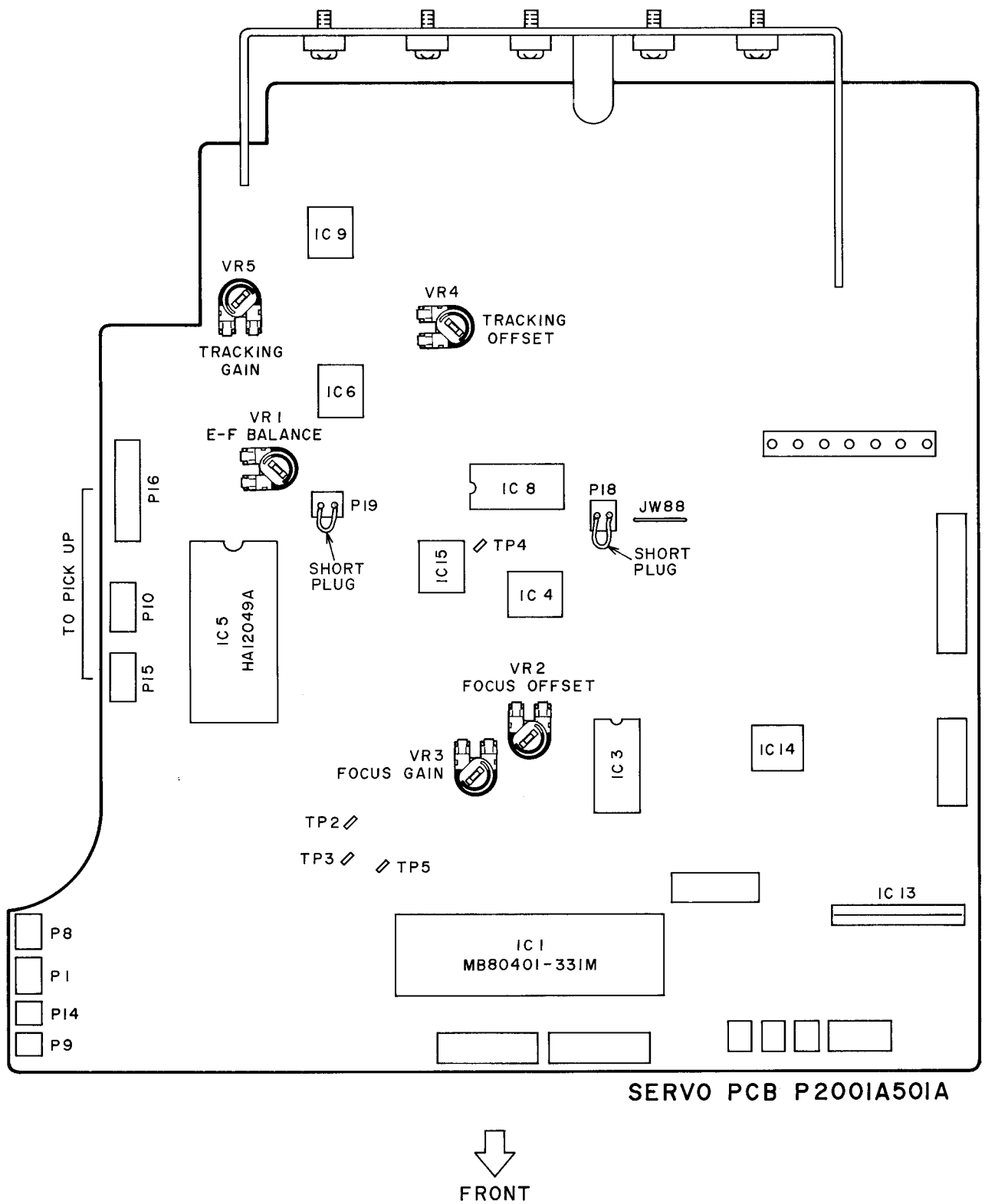

Fig. 6-1 SERVO PC Board Adjustment Points

6-1. ADJUSTMENT WHEN CHANGING THE PICK-UP

Change the pick-up, following the procedures in the item V, and when replacement is complete turn the short terminal of the LD (Laser Diode) to open.

6-1-1. OPTICAL AXIS ADJUSTMENT

If the mechanical eccentricity is large when fixing the pick-up tracking errors become large. This in turn interferes with the tracking servo, so optical axis adjustment is necessary.

- 1) Insert the eccentricity test disk, (AT-751370), and turn the tracking servo off (extract J19 on the servo PC board), then play back.
- 2) Connect the oscilloscope to TP5 on the Servo PC board and observe the wave patterns.
- 3) Put the optical axis metal fixings (0.1mm, 0.15 mm, 0.2mm, 0.25mm, and 0.3mm) under the pick-up guide rails D and E and adjust so that the voltage difference between A and B is less than 30 mV.

$$|A-B| < 30\text{mV}$$

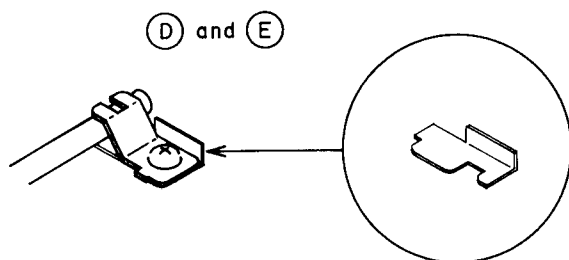
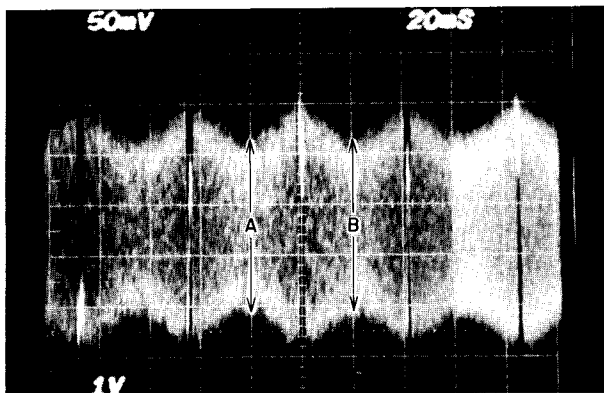

OPTICAL AXIS ADJUSTMENT SHIM

Fig. 6-2

THICKNESS OF THE SHIM	PARTS NUMBER
0.1mm	MZ351819 A
0.2mm	MZ351819 B
0.3mm	MZ351819 C
0.15mm	MZ351819 D
0.25mm	MZ351819 E

6-1-2. READJUSTMENT OF E-F BALANCE

When the pick-up is changed, E-F balance adjustment must be performed. Refer to item 6-2-2 for adjustment.

6-1-3. CHECKING THE ELECTRIC CURRENT OF THE LASER

The electric current of the laser is indicated on the labels on the pick-up.

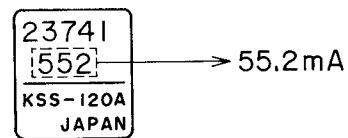

Fig. 6-3

- 1) Connect the millivoltmeter between TP2 and TP3 on the SERVO PC board and measure the voltage.

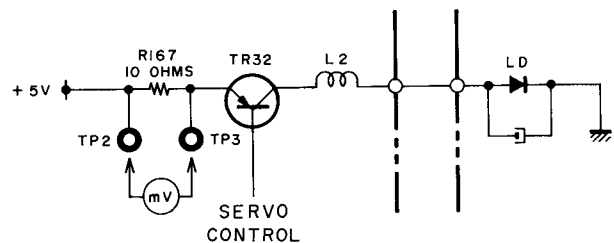

Fig. 6-4

- 2) Calculate the electric current of the laser from the voltage measured and check that it is within $\pm 2.0\%$ of the recommended value.

$$\text{Electric current of the laser} = \text{Voltage measured} \div 10.$$

If the electric current of the laser exceeds 10% of the recommended value, changed the pick-up again.

6-1-4. APC (AUTOMATIC POWER CONTROL) CIRCUITRY

This is a servo circuit to maintain the LD (Laser Diode) power of the pick-up. The LD power can be adjusted by the VR1 by the pick-up block. However, appropriate adjustment for individual characteristics has already been made, so **DO NOT touch this.**

6-2. SERVO ADJUSTMENT

Servo adjustment is an adjustment to the control circuitry for accurate and safe disc play back. When adjusting use a sony type 3 (No. YEDS 7) or philips (No. 410056-2 or 400079-2) as a test disc.

6-2-1. FOCUS OFFSET

- 1) Connect the oscilloscope to TP4 and the jumper wire JW88 on the SERVO PC board.
 JW88 DC Balance Voltage
 TP4 Eye pattern waves
- 2) Play back the test disc and adjust the VR2 so that the eye pattern wave forms are at their clearest. Check that the DC balance voltage is at minimum. If the eye pattern wave forms when the DC balance is at minimum are not the same as the clearest ones, adjust so that the eye pattern wave forms are at their clearest.

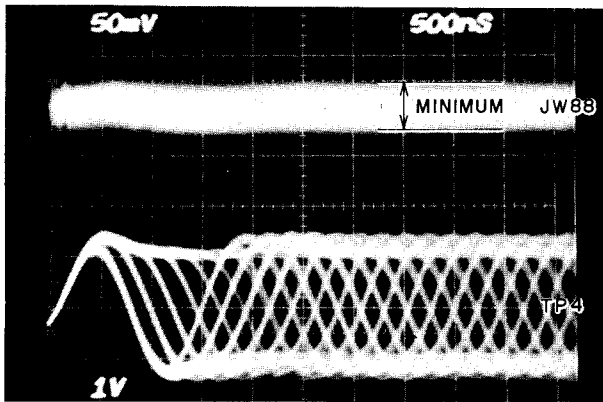

Fig. 6-5

6-2-2. E-F BALANCE ADJUSTMENT

This is to adjust the output balance of diodes E and F for tracking error detection.

When changing the pick-up adjusting the tracking constancy, this must be checked and adjusted.

- 1) Connect the oscilloscope to TP5 on the servo PC board.

Measure direct current voltage via an integral circuitry between TP5 and the oscilloscope as in illustration Fig. 6-7.

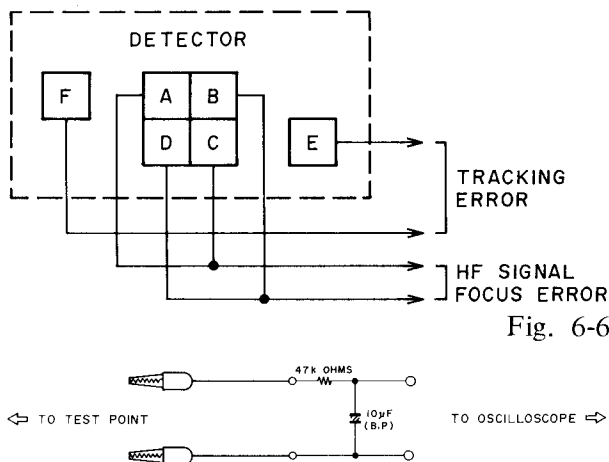

Fig. 6-6

Fig. 6-7

- 2) Play back the test disc and turn the machine to pause.
- 3) Extract the short plug (P19) on the SERVO PC board.
- 4) Adjust the VR1 for E-F balance so that the voltage is $0V \pm 5mV$.

6-2-3. TRACKING OFFSET

- 1) Connect the oscilloscope to TP5 on the SERVO PC board. (Measure as in item 2-2, Via and integral circuit.)
- 2) Play back the test disc.
- 3) Adjust the tracking offset adjustment VR4 so that the TP5 voltage is $0V \pm 5mV$.

6-2-4. FOCUS GAIN ADJUSTMENT

- 1) Connect the oscilloscope between P15-No. 1 terminal on the SERVO PC board and earth, and measure the voltage on the focus coil.
- 2) Play back the test disc and adjust VR3 so that the focus coil voltage is 500 to 600 mVp-p.

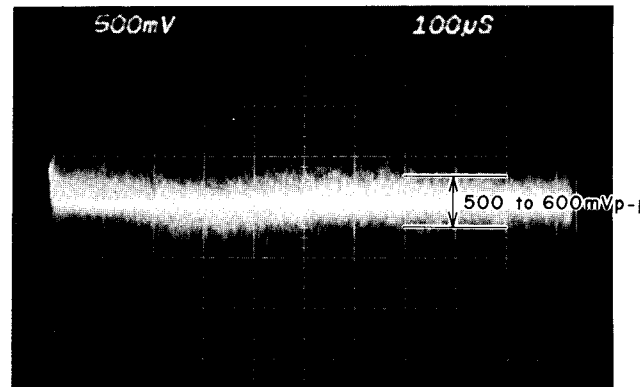

Fig. 6-8

6-2-5. TRACKING GAIN ADJUSTMENT

- 1) Connect the oscilloscope between P15-No. 2 terminal on the SERVO PC board and earth and measure the voltage on the tracking coil.
- 2) Play back the test disc and adjust VR5 so that the tracking coil voltage is 1.8 to 2.2Vp-p.

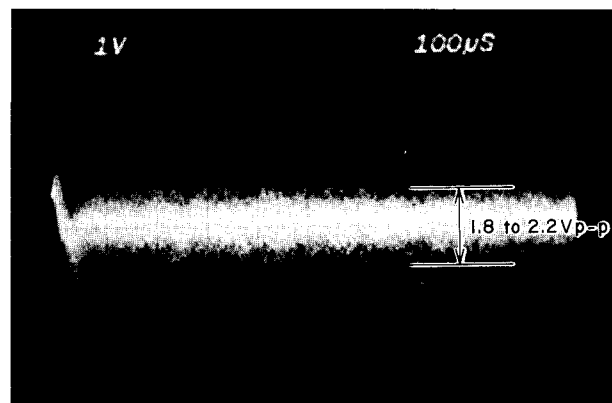

Fig. 6-9

Reference:

If the sound jumps when the machine is lightly jolted, this means the tracking Gain is small.

If a disc with a scratch of 600μ is played and the sound jumps, this means the tracking Gain is large.

Philips No. 410056-2 TNO6,01'05" up till TNO7,00'02"

VII. PC BOARD TITLE AND IDENTIFICATION NUMBERS

PC BOARD TITLE		PC BOARD NUMBER	REMARKS
SERVO	PC BOARD	P2001A501A	
OPERATION	PC BOARD	A501B	
HEAD PHONE	PC BOARD	A501C	
VOLUME	PC BOARD	A501D	
SIGNAL	PC BOARD	P2001A502A	
OUTPUT	PC BOARD	A502B	
FLD	PC BOARD	P2001C5030	
LED	PC BOARD	P2001D501E	
SW-1	PC BOARD	P2001D506A	
DETECTOR	PC BOARD	D506B	
SW-2	PC BOARD	D506C	
SW-3	PC BOARD	D506D	
POWER SUPPLY	PC BOARD	P2001D5040	E, B, S
		D5041	C, A
		D5042	U

SECTION 2

PARTS LIST

TABLE OF CONTENTS

RECOMMENDED SPARE PARTS	17
1. MECHA BLOCK	18
2. PC BOARD BLOCK	19
3. SIGNAL PC BOARD	19
4. FLD PC BOARD	19
5. SERVO PC BOARD	19
6. OPERATION PC BOARD	20
7. VOLUME PC BOARD	20
8. OUTPUT PC BOARD	20
9. HEAD PHONE PC BOARD	20
10. LED PC BOARD	20
11. DETECTOR PC BOARD	20
12. SW-1 PC BOARD	20
13. SW-2 PC BOARD	20
14. SW-3 PC BOARD	20
15. POWER SUPPLY PC BOARD	20
16. ASSEMBLY BLOCK	21
17. FINAL ASSEMBLY BLOCK	22
INDEX	24

Resistor and Capacitor which is not listed in this parts list, please refer to
COMMON LIST FOR SERVICE PARTS.

ATTENTION

1. When placing an order for parts, be sure to list the parts no., model no., and description of each part. If any of this information is omitted, there are instances in which parts cannot be shipped or the wrong parts will be delivered.
2. Please be careful not to make a mistake in the parts no. If the parts no. is in error, a part different from the one ordered may be delivered.
3. Because part numbers and part definitions and supply in the Preliminary Parts List may have been the subject of changes, please use this parts list for all future reference.

HOW TO USE THIS PARTS LIST

1. This Parts List shows those parts which are considered necessary for repairs. Other parts, such as resistors and capacitors, are shown in the "Common List for Service Parts" from which these parts should be selected and parts.
2. The Recommended Spare Parts List shows those parts in the Parts List which are considered particularly important for service.
3. Parts not shown in the Parts List and "Common List for Service Parts" will not in principle be supplied.
4. How to read the parts list

a) Mechanism Block

b) P.C Board Block

2. HEAD BASE BLOCK

REF. NO.	PART NO.	DESCRIPTION
2-1x	BH-T2023A320A	HEAD BASE BLOCK GX-F66R
2-2	HP-H2206A010A	HEAD R/P PR4-8FU C
2-3	ZS-477876	PAN20×03STL CMT
2-4	ZS-536488	BID20×08STL CMT
2-5	ZG-402895	CS ANGLE ADJUST SPRING

SP (Service Parts) Classification

A small "x" indicates the inability to show that particular part in the Photo or Illustration.

This number corresponds with the individual parts index number in that figure

This number corresponds with the Figure Number

6. SYS. CON. P C BOARD BLOCK

REF. NO.	PART NO.	DESCRIPTION
6-1	BA-T2034A070A	PC SYS CON BLK GX-F44R
6-IC1	EI-324536	IC HD14049BP
6-IC2	EI-336801	IC MB8841-564M
6-IC3	EI-331661	IC SN7405N
6-IC4	EI-336725	IC M54527P
6-TR1to4	ET-200985	TR 2SC2603 F,G
6-TR5to28	ET-554657	TR 2SA733A P,Q
6-D1	ED-318292	D SILICON H 1S2473T-77 T26
6-D2to4	ED-308952	D GERMA V 1K34A-LR F07
6-D5to10	ED-318292	D SILICON H 1S2473T-77 T26
6-X1	EI-318384	OSC X'TAL NC-18C 3.579545MHZ

SP (Service Parts) Classification

These reference symbols correspond with component symbols in the Schematic Diagrams.

5. The kind of part and its installation position can both be determined by the Part Number. To determine where a part number is listed, utilize the Parts Index at the end of the Parts List. It is necessary first of all to find the Part Number. This can be accomplished by using the Reference Number listed at the right of the part number in the Parts Index.

WARNING

△ INDICATES SAFETY CRITICAL COMPONENTS. FOR CONTINUED SAFETY, REPLACE SAFETY CRITICAL COMPONENTS ONLY WITH MANUFACTURE'S RECOMMENDED PARTS

AVERTISSEMENT

△ IL INDIQUE LES COMPOSANTS CRITIQUES DE SÉCURITÉ. POUR MAINTENIR LE DEGRÉ DE SÉCURITÉ DE L'APPAREIL, NE REMPLACER QUE DES PIÈCES RECOMMANDÉES PAR LE FABRICANT

RECOMMENDED SPARE PARTS

Because, if the parts listed below are on hand, almost any repair can be accomplished, we suggest that you stock these Recommended Spare Parts Items.

REF. NO.	PARTS NO.	DESCRIPTION
1 N	BM-P2001A220A	LOADING MOTOR PULLY BLK CD-M88-B
2 N	BM-P2001A190A	MAIN MOTOR BLK CD-M88-B
3 N	BM-P2001A170A	MOTOR RADIAL BLK CD-M88-B
4 N	BO-355857	PICK UP KSS-120A
5 N	BT-355852	△ TRANS POWER P2001-AC [C,A]
6 N	BT-355853	△ TRANS POWER P2001-EBS [E,B,S]
7 N	BT-355850	△ TRANS POWER P2001-U [U]
8	ED-353291	D LED GL-9PR24 RED
9	ED-330319	D SILICON DBA10B 100/1.0A
10	ED-301911	D SILICON H DS448
11	ED-344280	D SILICON H GMA-01-FY2 F05
12	ED-357915	D SILICON S5295B
13	ED-306109	D SILICON W03B 100/1.0A
14	ED-329057	D ZENER H HZ11 A1
15	ED-346611	D ZENER H HZ11 B3
16	ED-346618	D ZENER H HZ15 1
17	ED-323836	D ZENER H HZ16 2
18	ED-306316	D ZENER H HZ5 C2
19	ED-346603	D ZENER H HZ6 A1
20	ED-306010	D ZENER H HZ6 A2
21	ED-331197	D ZENER H HZ6 C1
22	ED-337265	D ZENER H HZ6 C2
23	ED-319167	D ZENER H HZ6 C3
24	ED-337266	D ZENER H HZ9 A1
25	ED-328700	D ZENER H HZ9 A2
26	EF-601942	△ FUSE SEMKO T 250V 0.63A
27	EF-623103	△ FUSE SEMKO T 250V 1.00A
28	EF-309387	△ FUSE TSC A 250V 1.00A
29	EF-310229	△ FUSE TSC 125V 1.00A
30 N	EH-357109	DL XM-6V
31 N	EH-357109	DL XM-6V
32 N	EH-355868	FILTER ACTIVE AFL89WB 20000C5
33	EI-332255	△ IC HA11715
34	EI-330352	IC BA6109
35	EI-355874	IC HA12049
36	EI-324795	IC HD14001BP
37 N	EI-355859	IC HD61Z001
38 N	EI-355860	IC HD61901A
39 N	EI-355861	IC HD61902A
40 N	EI-355866	IC HD6805
41 N	EI-355862	IC HM6116P04
42	EI-349874	IC LB1245
43	EI-355876	IC LM311P
44 N	EI-355863	IC MB84053B
45 N	EI-357146	IC MB88400-339M [MB88400]
46	EI-337228	IC M5218L0
47 N	EI-355697	IC M5221P
48	EI-213390	IC NJM4558D
49 N	EI-355865	IC NJM5534D
50 N	EI-355864	IC PCM53JP-V
51 N	EI-355875	IC TC40H008P
52	EI-304657	IC TC4011BP
53	EI-305456	IC TC4049BP
54	EI-330226	IC #PC1373H
55	EI-349372	OSC CE CSA4.00MG 4MHz
56 N	EI-355867	OSC X,TAL 34.574400MHz
57	EJ-301513	SOCKET INLET S-16453 E 2P [U,E,B,S]
58 N	EM-355811	IND FL FIP7EM7 CHARACTER
59	EQ-328529	RELAY LEAD LAB2NS 2NO 12V
60	ER-331188	△ R FUSE ERD2FC S10 1/4W 8R2J
61 N	ES-357108	△ SW SELECTOR HXM0131-01-108 01-2 [E,B,S]
62	ES-305733	△ SW SELECTOR HXW0131-260 01-4 [U]
63 N	ES-355842	SW SLIDE SCL101T 01-2
64	ES-349367	SW TACT KHH10906
65 N	ET-355807	PHOTO SENSOR 0N2160 P,Q
66	ET-330238	PHOTO SENSOR PH302

REF. NO.	PARTS NO.	DESCRIPTION
67	ET-348302	TR FET 2SK381 C,D
68	ET-308472	TR 2SA1115 E,F,G
69	ET-345626	TR 2SA1248 S,T
70 N	ET-356806	TR 2SA1392 R,S
71	ET-322598	TR 2SB632K E,F
72	ET-318237	TR 2SB764 E,F
73 N	ET-355877	TR 2SB865
74	ET-308141	TR 2SC2603 G
75	ET-336869	TR 2SC2999 C,D
76	ET-345625	TR 2SC3116 S,T
77	ET-351872	TR 2SC3383 R,S
78 N	ET-356807	TR 2SD1153
79	ET-310148	TR 2SD612K E,F
80	EV-322415	R S-FIX H D8 3P 104
81	EV-336853	R S-FIX H KVSF807U 3P 103
82	EV-337841	VR SLIDE 30P2SV0A B103
83 N	MB-352160	BELT LOADING
84 N	MR-352158	PULLY GEAR
85 N	MZ-352159	GEAR (C)
86 N	MZ-351816	GEAR PICK UP
87 N	MZ-351815	GEAR WHEEL (A)

"NOTE" N: New Parts

SYMBOL FOR DESTINATION

- [A]: AAL (U.S.A.)
- [B]: UK (England)
- [C]: CSA (Canada)
- [E]: CEE (Europe)
- [S]: SAA (Australia)
- [U]: U/T (Universal Area)
- [V]: VDE (West Germany)

1. MECHA BLOCK

REF. NO.	PARTS NO.	DESCRIPTION
MECHA BLOCK		
1-1	BM-P2001A170A	MOTOR RADIAL BLK CD-M88-B
1-2	MV-368886	BALL 300STL
1-3	ZS-432843	PAN26x04STL CMT
1-4	MH-351813B	SHAFT (B)
1-5	ZS-442585	BID26x04STL CMT
1-6	ZS-536488	BID20x08STL CMT
1-7	MZ-352172	STOPER
1-8	ZG-351817	SP PLATE THRUST
1-9	BM-P2001A190A	MAIN MOTOR BLK CD-M88-B
1-10	ZS-572242	CTS26x06STL CMT
1-11	BO-355857	PICK UP KSS-120A
1-12	MS-351813A	SHAFT (A)
1-13	MZ-351814	HOLDER SHAFT (A)
1-14	MZ-351816	GEAR PICK UP
1-15	ZS-608220	PAN 26x06STL CMT
1-16	MZ-351815	GEAR WHEEL (A)
1-17	ZW-270088	RING E 190SUP CMT
1-18A	MZ-351819A	SHIM (A)
1-18B	MZ-351819B	SHIM (B)
1-18C	MZ-351819C	SHIM (C)
1-19	ZW-345299	PW31*060*100STL CMT
1-20	ZS-430413	CTS26x04STL CMT
1-21	BM-P2001A220A	LOADING MOTOR PULLY BLK CD-M88-B
1-22	MR-352158	PULLY GEAR
1-23	MB-352160	BELT LOADING
1-24	MZ-352159	GEAR (C)
1-25	MZ-352165	CLAMPER
1-26	MS-352166	GUIDE CLAMPER
1-27	BC-352204	COVER DISC TRAY
1-28	ZG-318204	SP T2-03.2/0.29-16.0 T2-062
1-29	MS-B352169	SHAFT LEVER RELEASE PART
1-30	ZS-354427	CTS26x04STL BNI
1-31	ZG-352174	SP TORSION PIN
1-32	MZ-352194	RACK GEAR
1-33	ZG-352184	SCREW STOPPER
1-34	BZ-P2001A130A	HOLDER RAIL (L) BLK CD-M88-B
1-35	BZ-P2001A140A	HOLDER RAIL (R) BLK CD-M88-B
1-36	TC-336146	BRAKE RUBBER
1-37	ZG-313014	SP T1-04.0/0.60-22.4 T1-127
1-38	ZG-324825	SP T2-04.0/0.40-16.0 T2-111
1-39	ZS-358965	SCREW ADJUST
1-40	ZW-485728	N23STL CMT

DETECTOR PC BOARD

11-PH1	ET-355807	PHOTO SENSOR ON2160 P,Q
--------	-----------	-------------------------

SW-1 PC BOARD

12-SW1	ES-355842	SW SLIDE SCL101T 01-2
--------	-----------	-----------------------

SW-2 PC BOARD

13-SW1	ES-355842	SW SLIDE SCL101T 01-2
--------	-----------	-----------------------

SW-3 PC BOARD

14-SW1	ES-355842	SW SLIDE SCL101T 01-2
--------	-----------	-----------------------

Parts listed in 1 to SW1 on the exploded view and list are normally stocked for replacement purpose. The remaining parts shown in this manual are not normally stocked, because they are seldom required for routine service.

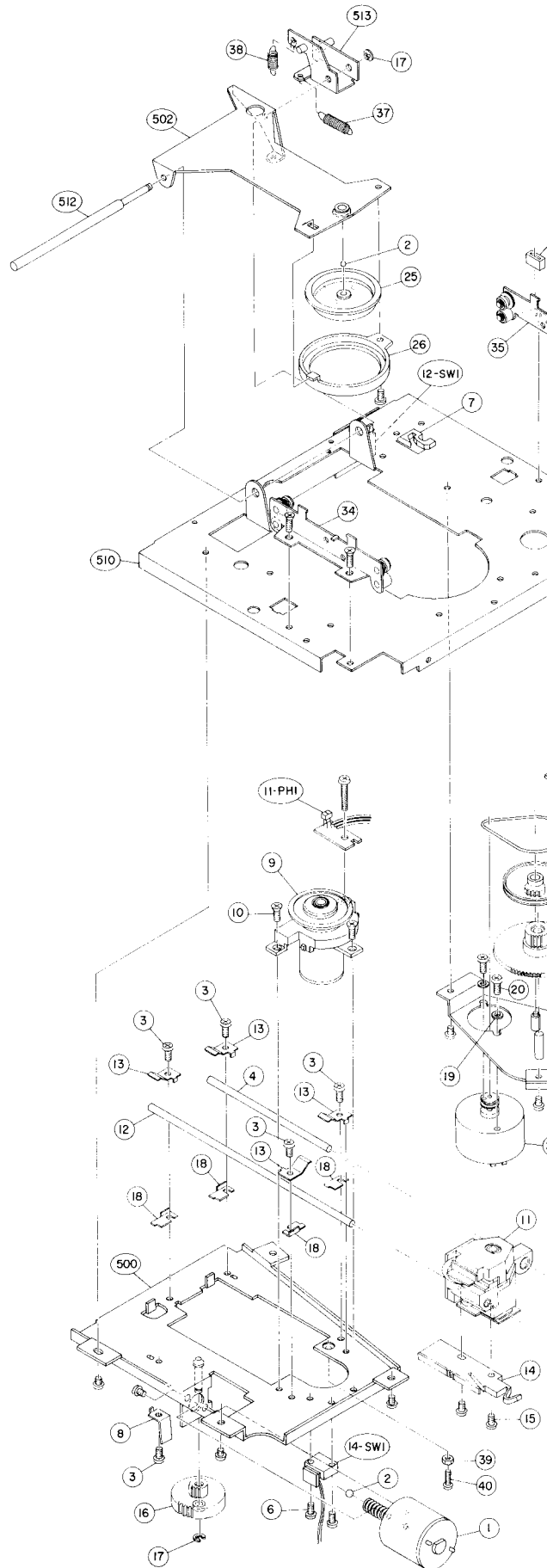

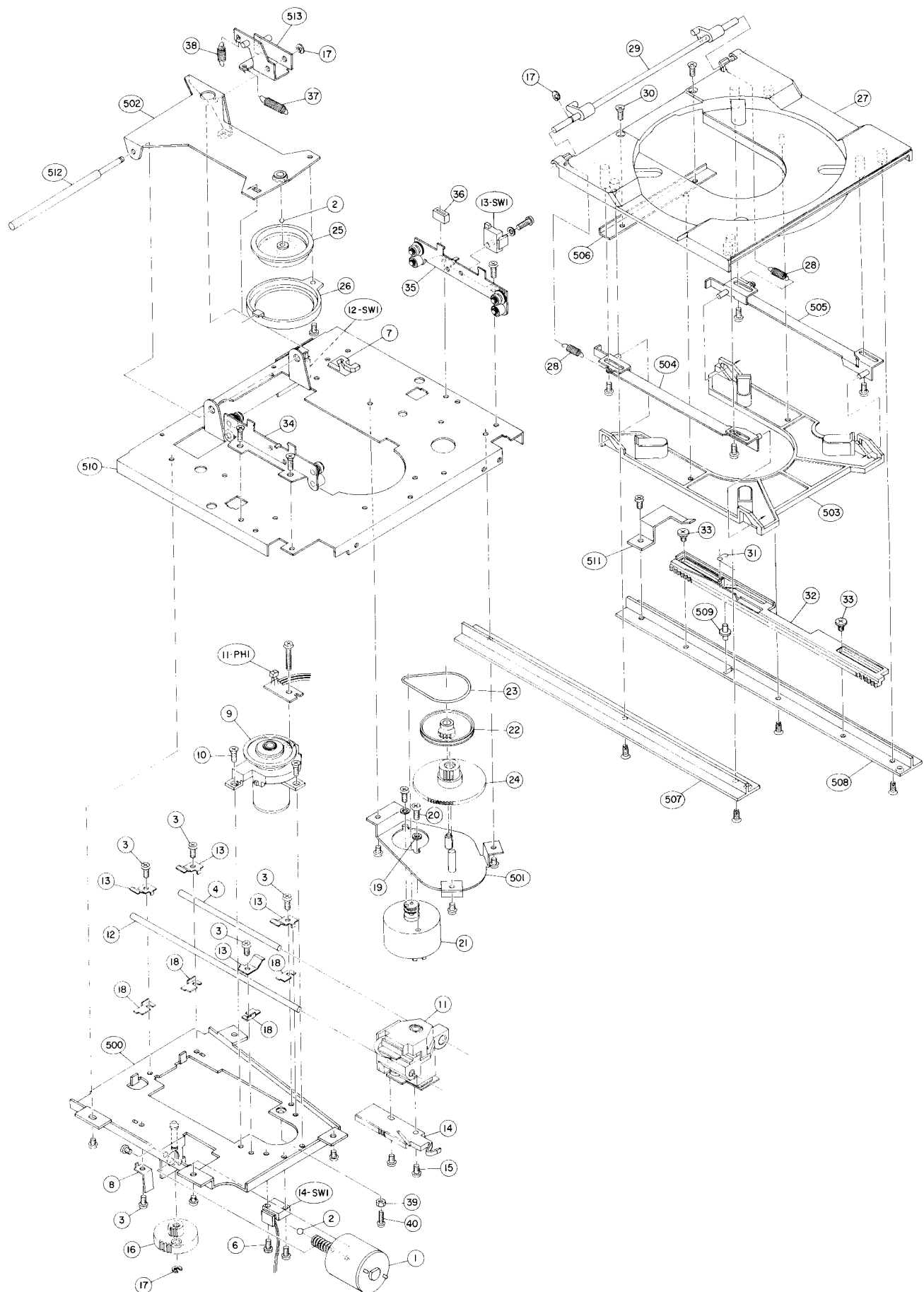

2. PC BOARD BLOCK

REF. NO.	PARTS NO.	DESCRIPTION
2-1	BA-P2001A090A	PC SIGNAL BLK CD-M88-B
2-2	BA-P2001A050B	PC SERVO BLK CD-A7

NOTES:

(1) PC SIGNAL BLK consists of following PC BOARDS.

- SIGNAL PC BOARD
- OUT PUT PC BOARD

(2) PC SERVO BLK consists of following PC BOARDS.

- SERVO PC BOARD
- OPERATION PC BOARD
- LED PC BOARD
- HEAD PHONE PC BOARD

3. SIGNAL PC BOARD

REF. NO.	PARTS NO.	DESCRIPTION
3-IC1	EI-355859	IC HD61Z001
3-IC2	EI-355860	IC HD61901A
3-IC3	EI-355861	IC HD61902A
3-IC4	EI-355862	IC HM6116P-4
3-IC5	EI-355864	IC PCMS3JP-V
3-IC6	EI-355863	IC MB84053B
3-IC7	EI-355865	IC NJM5534D
3-IC8	EI-355697	IC M5221P
3-IC9	EI-337228	IC M5216L0
3-IC10	EI-305456	IC T04049BP
3-IC11	EI-324795	IC HD14001BP
3-IC12	EI-213390	IC NJM4558D
3-IC13	EI-305456	IC T04049BP
3-IC14	EI-304657	IC T04011BP
3-IC15	EI-305456	IC T04049BP
3-IC16	EI-355866	IC HD6805
3-TR1	ET-355877	TR 2SB865
3-TR2	ET-335807	TR 2SD1153
3-TR3	ET-308141	TR 2SC2603 G
3-TR4	ET-308472	TR 2SA1115 E,F,G
3-TR5	ET-308141	TR 2SC2603 G
3-TR6	ET-351872	△ TR 2SC3383 R,S
3-TR7	ET-356806	△ TR 2SA1392 R,S
3-TR8		
to 10	ET-308141	TR 2SC2603 G
3-D1,2	ED-344280	D SILICON H GMA-01-FY2 F05
3-D3	ED-306010	D ZENER H HZ6 A2
3-D4,5	ED-306013	△ D ZENER H HZ7 C1
3-D6,7	ED-301911	D SILICON H DS448
3-D8		
to 12	ED-344280	D SILICON H GMA-01-FY2 F05
3-RL1,2	EQ-328529	RELAY LEAD LAB2NS 2NO 12V
3-FL1	EH-355868	FILTER ACTIVE AFL39WB20000C5
3-X1	EI-355867	OSC X,TAL 34.574400MHZ
3-X2	EI-349372	OSC CE CSA4.00MG 4MHZ
3-IB1	EH-353788	COMP R RKC1/8B15 10K J
3-FR1		
to 4	ER-332225	△ R FUSE ERD2FC S10 1/4W 56R0G
3-R28	ER-313817	R MF H F10 1/4W 8201F
3-R29	ER-318316	R MF H F10 1/4W 2201F
3-R30	ER-311757	R MF H 1/4W 4701F
3-R31	ER-314607	R MF H 1/4W 4700F
3-R32	ER-314600	R MF H 1/4W 1601F
3-R33	ER-311757	R MF H 1/4W 4701F
3-R34	ER-314599	R MF H 1/4W 1501F
3-R35	ER-310326	R MF H 1/4W 1002F
3-R36	ER-314629	R MF H 1/4W 2402F
3-R37	ER-329280	R MF H F10 1/4W 6202F
3-R46	ER-357867	R MF H F10 1/4W 1102F
3-R51		
to 53	ER-310326	R MF H 1/4W 1002F
3-R54	ER-311748	R MF H 1/4W 2202F
3-R55	ER-337999	R MF H F10 1/4W 82R0F

REF. NO.	PARTS NO.	DESCRIPTION
3-C5	EC-351978	C EC V F05 NP SM R10M 50.0DC
3-C9	EC-350672	C PP V F05 PP 681J 50DC
3-C10	EC-346879	C PP V F05 PP 221J 50DC
3-C11	EC-355727	C COMP V AWS 392J 50DC
3-C12	EC-351992	C COMP V AWS 472J 50DC
3-C13	EC-351994	C COMP V AWS 152J 50DC
3-C27	EC-352007	C COMP V AWS 162J 50DC

4. FLD PC BOARD

REF. NO.	PARTS NO.	DESCRIPTION
4-IC1,2	EI-349874	IC LB1245
4-D1	ED-331197	D ZENER H HZ6 C1
4-SW1	ES-349367	SW TACT KHH10906
4-IN1	EM-355811	IND FL FIP7EM7 CHARACTER

5. SERVO PC BOARD

REF. NO.	PARTS NO.	DESCRIPTION
5-IC1	EI-357146	IC MB88400-399M
5-IC2	EI-330226	IC μPC1373H
5-IC3	EI-355875	IC TC40H008P
5-IC4	EI-213390	IC NJM4558D
5-IC5	EI-355874	IC HA12049
5-IC6	EI-213390	IC NJM4558D
5-IC8	EI-310036	IC TC4066BP
5-IC9		
to 12	EI-213390	IC NJM4558D
5-IC13	EI-330352	△ IC BA6109
5-IC14	EI-355876	IC LM311P
5-IC15	EI-355865	IC NJM5534D
5-TR1	ET-348302	TR FET 2SK381 C,D
5-TR2		
to 6	ET-308141	TR 2SC2603 G
5-TR7	ET-356807	△ TR 2SD1153
5-TR8	ET-355877	△ TR 2SB865
5-TR9	ET-308141	TR 2SC2603 G
5-TR12	ET-348302	TR FET 2SK381 C,D
5-TR13	ET-308141	TR 2SC2603 G
5-TR15,		
16	ET-308141	TR 2SC2603 G
5-TR17	ET-308472	TR 2SA1115 E,F,G
5-TR18	ET-348302	TR FET 2SK381 C,D
5-TR19	ET-308141	TR 2SC2603 G
5-TR20	ET-310148	△ TR 2SD612K E,F
5-TR21	ET-308472	TR 2SA1115 E,F,G
5-TR22	ET-322598	△ TR 2SB632K E,F
5-TR23	ET-308141	TR 2SC2603 G
5-TR24	ET-310148	△ TR 2SD612K E,F
5-TR25	ET-355877	TR 2SB865
5-TR26	ET-308141	TR 2SC2603 G
5-TR27	ET-356807	△ TR 2SD1153
5-TR28	ET-355877	△ TR 2SB865
5-TR29,		
30	ET-308141	TR 2SC2603 G
5-TR31	ET-308472	TR 2SA1115 E,F,G
5-TR32	ET-318237	TR 2SB764 E,F
5-TR33	ET-308472	TR 2SA1115 E,F,G
5-TR34	ET-355877	△ TR 2SB865
5-TR35	ET-308141	TR 2SC2603 G
5-TR36		
to 39	ET-308472	TR 2SA1115 E,F,G
5-TR40	ET-318237	TR 2SB764 E,F
5-TR41	ET-345625	△ TR 2SC3116 S,T
5-TR42	ET-351872	TR 2SC3383 R,S
5-TR43	ET-356806	TR 2SA1392 R,S
5-TR44	ET-345626	△ TR 2SA1248 S,T
5-TR45	ET-345625	△ TR 2SC3116 S,T
5-TR46	ET-351872	TR 2SC3383 R,S
5-TR47	ET-345626	△ TR 2SA1248 S,T
5-TR48	ET-310148	△ TR 2SD612K E,F
5-TR49	ET-308141	TR 2SC2603 G

REF. NO.	PARTS NO.	DESCRIPTION
5-TR50, 51	ET-356806	TR 2SA1392 R,S
5-TR52 to 54	ET-336869	TR 2SC2999 C,D
5-D1	ED-328700	D ZENER H HZ9 A2
5-D2	ED-344280	D SILICON H GMA-01-FY2 F05
5-D3,4	ED-337265	△ D ZENER H HZ6 C2
5-D6	ED-344280	D SILICON H GMA-01-FY F05
5-D9	ED-346618	D ZENER H HZ15 1
5-D10	ED-346611	D ZENER H HZ11 B3
5-D11	ED-301911	D SILICON H DS448
5-D12 to 14	ED-344280	D SILICON H GMA-01-FY2 F05
5-D15	ED-337265	D ZENER H HZ6 C2
5-D16,17	ED-301911	D SILICON H DS448
5-D18	ED-329057	D ZENER H HZ11 A1
5-D19	ED-357915	D SILICON S5295B
5-D20	ED-323836	D ZENER H HZ16 2
5-D22	ED-330319	△ D SILICON DBA10B 100/1.0A
5-D23	ED-306109	D SILICON W03B 100/1.0A
5-D24 to 27	ED-323836	△ D ZENER H HZ16 2
5-D28	ED-330319	△ D SILICON DBA10B 100/1.0A
5-D29	ED-319167	D ZENER H HZ6 C3
5-D30	ED-306316	D ZENER H HZ5 C2
5-D31	ED-344280	D SILICON H GMA-01-FY2 F05
5-D32,33	ED-337266	△ D ZENER H HZ9 A1
5-D34,35	ED-357915	D SILICON S5295B
5-D36	ED-301911	D SILICON H DS448
5-D37	ED-346603	D ZENER H HZ6 A1
5-VR1,2	EV-322415	R S-FIX H D8 3P 104
5-VR3 to 5	EV-336853	R S-FIX H KVSF807U 3P 103
5-L1	EO-330719	COIL FIX1 187LY-103K 103K
5-L2	EO-345913	COIL FIX 1 LAL03KH 100K
5-x1	EI-349372	OSC CE CSA4.00MG 4MHz
5-DL1,2	EH-357109	DL XM-6V
5-IB1,2	EH-355878	COMP R RGLD9×103J
5-FR1	ER-331188	△ R FUSE ERD2FC S10 1/4W 8R2J
5-C19	EC-200948	C EC V F05 NP SM 1R0M 50DC
5-C22,23	EC-345656	C PP V F05 PP 473J 50DC
5-C36	EC-332052	C EC V F05 NP SM 4R7M 35 DC
5-C40	EC-200948	C EC V F05 NP SM 1R0M 50DC
5-C46	EC-307684	C EC V F05 NP SM R47M 50DC
5-C63,67	EC-324662	C EC V CUT SM 222M 25DC
5-C75	EC-201650	C EC V CUT SM 472M 10DC
5-1	EZ-200473	SILICON RUBBER SHEET TC-30

6. OPERATION PC BOARD

REF. NO.	PARTS NO.	DESCRIPTION
6-D1 to 4	ED-301911	D SILICON H DS448
6-SW1 to 23	ES-349367	SW TACT KHH10906

7. VOLUME PC BOARD

REF. NO.	PARTS NO.	DESCRIPTION
7-VR1	EV-337841	VR SLIDE 30P2SV0A B103

8. OUTPUT PC BOARD

REF. NO.	PARTS NO.	DESCRIPTION
8-J25	EJ-345469	PIN J YKC21-0093

9. HEAD PHONE PC BOARD

REF. NO.	PARTS NO.	DESCRIPTION
9-J24	EJ-358901	PHONE J 3P HLJ0541-010 W/NUT 6.3

10. LED PC BOARD

REF. NO.	PARTS NO.	DESCRIPTION
10-D1	ET-330238	PHOTO SENSOR PH302
10-D2	ED-353291	D LED GL-9PR24 RED

11. DETECTOR PC BOARD

REF. NO.	PARTS NO.	DESCRIPTION
11-PH1	ET-355807	PHOTO SENSOR ON2160 P,Q

12. SW-1 PC BOARD

REF. NO.	PARTS NO.	DESCRIPTION
12-SW1	ES-355842	SW SLIDE SCL101T 01-2

13. SW-2 PC BOARD

REF. NO.	PARTS NO.	DESCRIPTION
13-SW1	ES-355842	SW SLIDE SCL101T 01-2

14. SW-3 PC BOARD

REF. NO.	PARTS NO.	DESCRIPTION
14-SW1	ES-355842	SW SLIDE SCL101T 01-2

15. POWER SUPPLY PC BOARD

REF. NO.	PARTS NO.	DESCRIPTION
15-C1A	EC-320548	△ C CE V F 103Z 250AC [U]
15-C1B	EC-338411	△ C CE V FZ 103P 400AC [EXCEPT U]
15-F1A	EF-309387	△ FUSE TSC A 250V 1.00A [U]
15-F1B	EF-310229	△ FUSE TSC 125V 1.00A [C,A]
15-F1C	EF-623103	△ FUSE SEMKO T 250V 1.00A [E,B,S]
15-F2A	EF-309387	△ FUSE TSC A 250V 1.00A [U]
15-F2B	EF-310229	△ FUSE TSC 125V 1.00A [C,A]
15-F2C	EF-601942	△ FUSE SEMKO T 250V 0.63A [E,B,S]
15-F3A	EF-309387	△ FUSE TSC A 250V 1.00A [U]
15-F3B	EF-310229	△ FUSE TSC 125V 1.00A [C,A]
15-F3C	EF-601942	△ FUSE SEMKO T 250V 0.63A [E,B,S]

ASSEMBLY BLOCK

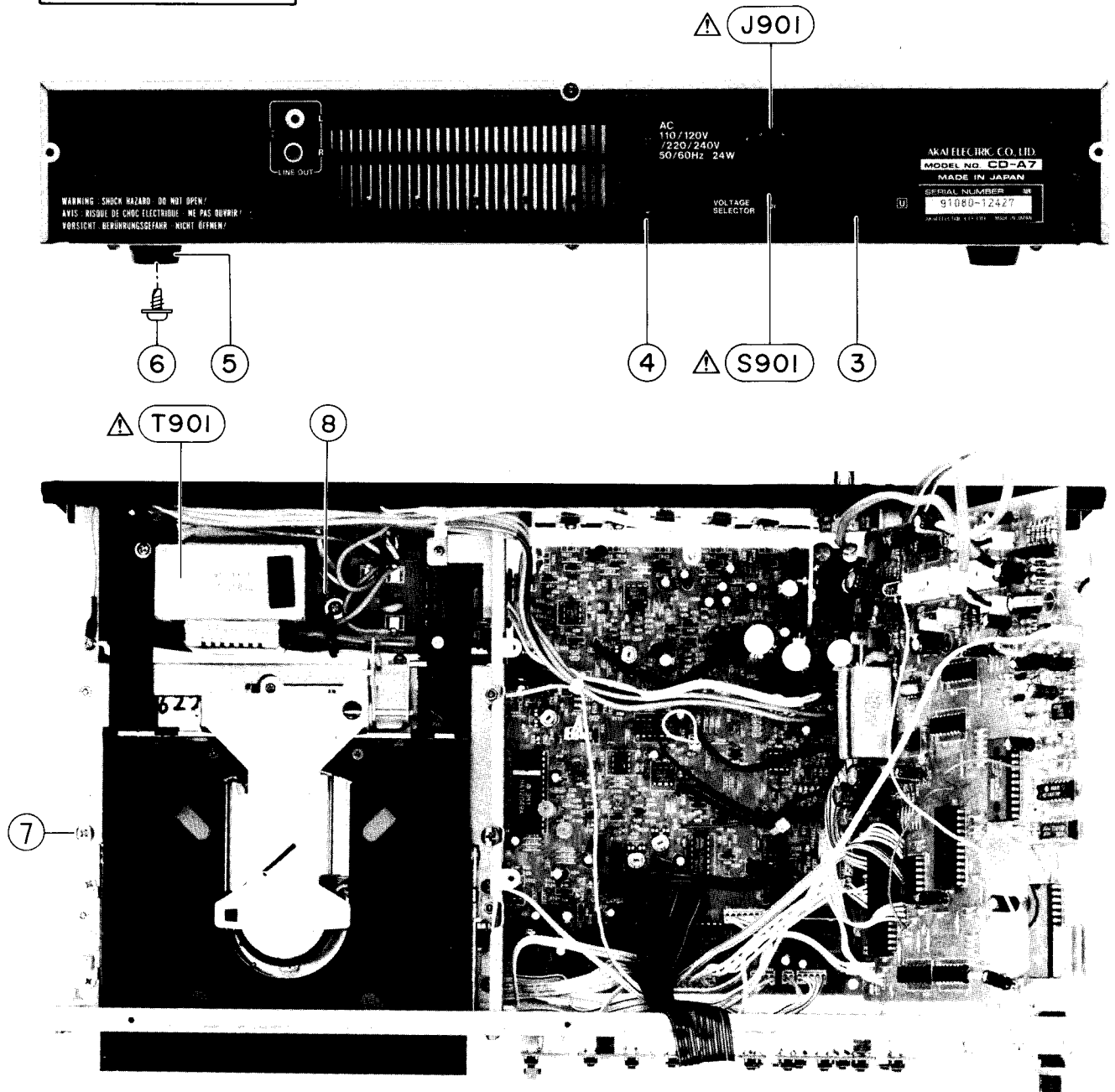

16. ASSEMBLY BLOCK

REF. NO.	PARTS NO.	DESCRIPTION	REF. NO.	PARTS NO.	DESCRIPTION
16-1xA	EW-302899	△ AC CORD 2 CORES VM129A/ VM0712 U/T [U]	16-6	ZS-331567	T2BR30×08STL CMT C080
16-1xB	EW-352237	△ AC CORD 2 CORES KP-8, SPT-2 UC [C,A]	16-7	MS-302757	STOPPER SHAFT
16-1xC	EW-638144	△ AC CORD 2 CORES VM0364/ VM0305 EV [E]	16-8	ZS-417150	PAN40×06STL CMT
16-1xD	EW-302995	△ AC CORD 2 CORES VM0112/00FL B [B]	16-9x	ZS-379350	PAN30×06STL CMT [SELECTOR SW FIX]
16-1xE	EW-322401	△ AC CORD 2 CORES KP-560/KS-15 S [S]	16-T901A	BT-355850	△ TRANS POWER P2001-U [U]
16-2x	EZ-631945	STRAIN RELIEF SR-4N-4 [C,A]	16-T901B	BT-355852	△ TRANS POWER P2001-AC [C,A]
16-3A	SP-351795A	PANEL REAR CD-A7 (U)	16-T901C	BT-355853	△ TRANS POWER P2001-EBS [E,B,S]
16-3B	SP-351795B	PANEL REAR CD-A7 (A,C)	16-S901A	ES-305733	△ SW SELECTOR HXW0131-260 01-4 [U]
16-3C	SP-351795C	PANEL REAR CD-A7 (E,B,S)	16-S901B	ES-357108	△ SW SELECTOR HXM0131-01-108 01-2 [E,B,S]
16-4	ZS-447761	T2BR30×06STL ENI	16-J901	EJ-301513	△ SOCKET INLET S-16453 E 2P [U,E,B,S]
16-5	SA-202118	FOOT	16-SW901	ES-355631	△ SW PUSH A2B-1A2 01-1

FINAL ASSEMBLY BLOCK

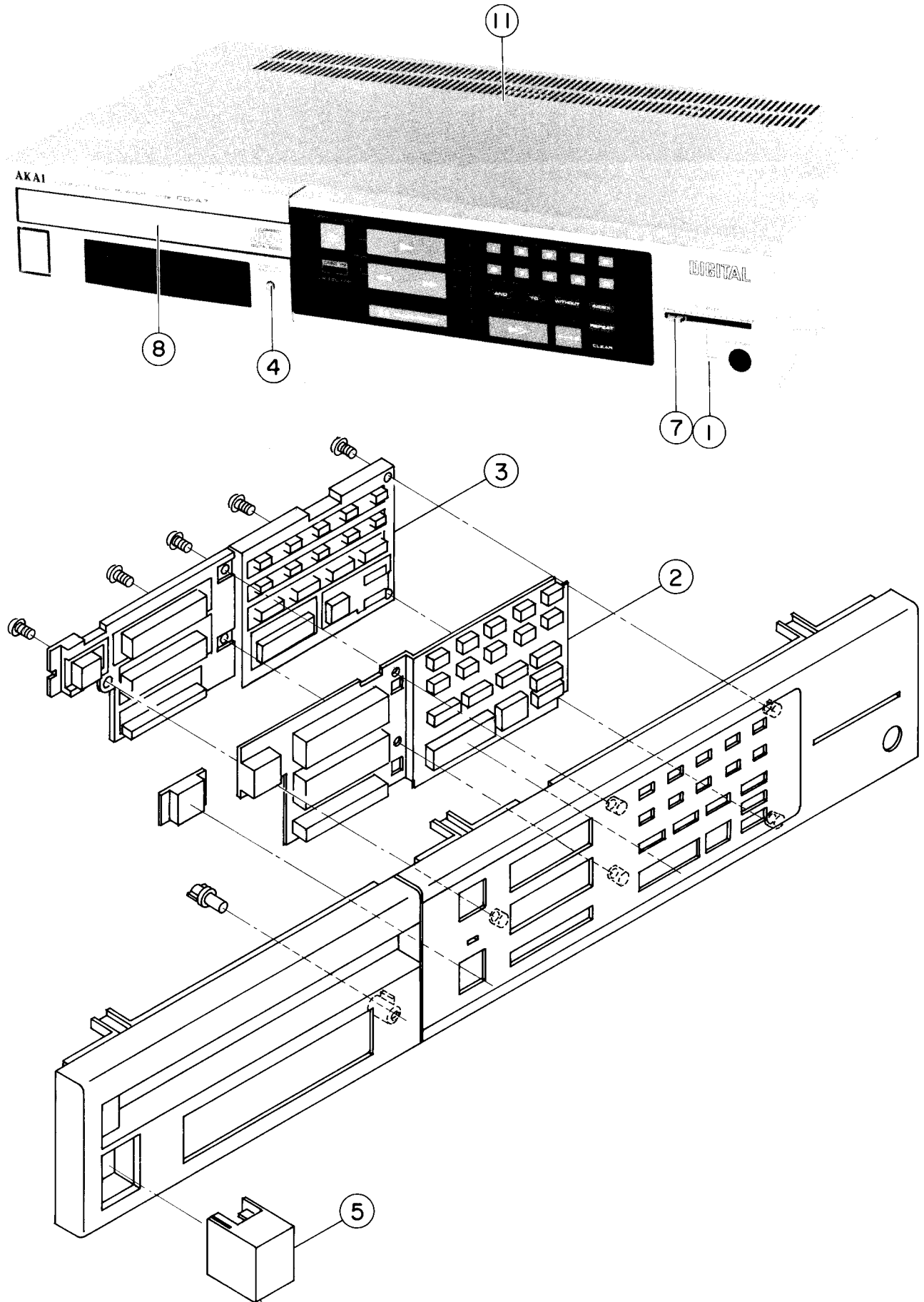

17. FINAL ASSEMBLY BLOCK

REF. NO.	PARTS NO.	DESCRIPTION
PANEL FRONT BLOCK		
17-1	BD-P2004A050A	PANEL FRONT BLK CD-A7
17-1B	BD-P2004A050B	PANEL FRONT BLK CD-A7-B
17-2	SK-352198C	KNOB SWITCH PROGRAM (B)
17-2B	SK-352198D	KNOB SWITCH PROGRAM (B)-B
17-3	SZ-352197	CHASSIS KNOB SWITCH
17-4	SK-352187B	KNOB DISPLAY SELECT (B)
17-4B	SK-352187	KNOB DISPLAY SELECT (A) [BL]
17-5	SK-343017G	KNOB POWER
17-5B	SK-343017F	KNOB POWER-B [BL]
FINAL ASSEMBLY BLOCK		
17-6x	ZS-325495	T2BR30×06STL CMT [PANEL FRONT FIX]
17-7	SK-343009D	KNOB OUTPUT-S
17-7B	SK-343009C	KNOB OUTPUT-B [BL]
17-8	SP-351788	PANEL TRAY
17-8B	SP-351788B	PANEL TRAY-B
17-9x	ZS-355101	CTS26×06STL BNI [PANEL TRAY FIX L,R]
17-10x	ZS-356467	T2CTS26×06STL BNI [PANEL TRAY FIX CENTER]
17-11	SP-351792	COVER UPPER
17-11B	SP-351792B	COVER UPPER-B

SYMBOL FOR COLOR VARIATION

NON : STANDARD COLOR
 B or BL : BLACK

18. REMOTE CONTROL TRANSMITTER RC-80

REF. NO.	PARTS NO.	DESCRIPTION
1-IC1	EI-749983	IC UPD1943G
1-TR1	ET-318603	TR 2SD545NP F
1-D1 to 4	ED-557447	D SILICON H 1S1588
1-D5, 6	ED-714631	D LED TLN105A
1-D7	ED-714635	D LED SEL1123R
1-SW1	ES-710038	SW SLIDE
1-X1	EI-749984	OSC CE KBR455BAT
1-R3, 4	ER-340201	R CB H F10 RDS 1/4W 1ROJ
1-2S	AX-710025	COVER BATTERY RC-90T
1-2B	AV-713375	COVER BATTERY B
1-3	AV-749979	TERMINAL BATTERY A (+)
1-4	AV-749980	TERMINAL BATTERY B (-)
1-5	AV-749981	TERMINAL BATTERY C (+-)
1-1S	AX-357115	REMOTE CONTROL UNIT RC-80-S
1-1B	AX-357116	REMOTE CONTROL UNIT RC-80-B

RTV servis Horvat
 Kešinci, 31402 Semeljci
 Tel : 031-856-637
 Tel / fax : 031-856-139
 Mob : 098-788-319
rtv-servis-horvat@os.tel.hr

INDEX

PARTS NO.	REF. NO.	PARTS NO.	REF. NO.	PARTS NO.	REF. NO.	PARTS NO.	REF. NO.	PARTS NO.	REF. NO.
BA-P2001A050B	2-2	EF-310229	15-F2B	ES-355842	14-SW1	MH-351813B	1-4	RC-80	
BA-P2001A090A	2-1	EF-310229	15-F3B	ES-355842	12-SW1	MR-352158	1-22		
BC-352204	1-27	EF-601942	15-F2C	ES-355842	13-SW1	MS-B352169	1-29	AV-713375	1-2B
BD-P2004A050A	17-1	EF-601942	15-F3C	ES-355842	14-SW1	MS-302757	16-7	AV-749979	1-3
BD-P2004A050B	17-1B	EF-623103	15-F1C	ES-357108	16-S901B	MS-351813A	1-12	AV-749980	1-4
BM-P2001A170A	1-1	EH-353788	3-IB1	ET-308141	3-TR3	MS-352166	1-26	AV-749981	1-5
BM-P2001A190A	1-9	EH-355868	3-FL1	ET-308141	3-TR5	MV-368886	1-2	AX-357115	1-1S
BM-P2001A220A	1-21	EH-355878	5-IB1	ET-308141	3-TR8	MZ-351814	1-13	AX-357116	1-1B
BO-355857	1-11	EH-355878	5-IB2	ET-308141	3-TR9	MZ-351815	1-16	AX-710025	1-2S
BT-355850	16-T901A	EH-357109	5-DL1	ET-308141	3-TR10	MZ-351816	1-14	ED-557447	1-D1 to 4
								ED-714631	1-D5
BT-355852	16-T901B	EH-357109	5-DL2	ET-308141	5-TR49	MZ-351819A	1-18A	ED-714631	1-D6
BT-355853	16-T901C	EI-213390	3-IC12	ET-308141	5-TR2	MZ-351819B	1-18B	ED-714635	1-D7
BZ-P2001A130A	1-34	EI-213390	5-IC4		to 6	MZ-351819C	1-18C	EI-749983	1-IC1
BM-P2001A140A	1-35	EI-213390	5-IC6	ET-308141	5-TR9	MZ-352159	1-24	AV-749981	1-X1
EC-200948	5-C19	EI-213390	5-IC9	ET-308141	5-TR13	MZ-352165	1-25	ER-340201	1-R3
EC-200948	5-C40		to 12	ET-308141	5-TR15	MZ-352172	1-7	ER-340201	1-R4
EC-201650	5-C75	EI-304657	3-IC14	ET-308141	5-TR16	MZ-352194	1-32	ES-710038	1-SW1
EC-307684	5-C46	EI-305456	3-IC10	ET-308141	5-TR19	SA-202118	16-5	ET-318603	1-TR1
EC-320548	15-C1A	EI-305456	3-IC13	ET-308141	5-TR23	SK-343009C	17-7B		
EC-324662	5-C63	EI-305456	3-IC15	ET-308141	5-TR26	SK-343009D	17-7		
EC-324662	5-C67	EI-310036	5-IC8	ET-308141	5-TR29	SK-343017F	1-5B		
EC-332052	5-C36	EI-324795	3-IC11	ET-308141	5-TR30	SK-343017G	17-5		
EC-338411	15-C1B	EI-330226	5-IC2	ET-308141	6-TR35	SK-352187	17-4B		
EC-345656	5-C23	EI-330352	5-IC13	ET-308472	3-TR4	SK-352187B	17-4		
EC-345656	5-C22	EI-337228	3-IC9	ET-308472	5-TR17	SK-352198C	17-2		
EC-346879	3-C10	EI-349372	3-x2	ET-308472	5-TR21	SK-352198D	17-2B		
EC-350672	3-C9	EI-349372	5-x1	ET-308472	5-TR31	SP-351788	17-8		
EC-351978	3-C5	EI-349874	4-IC1	ET-308472	5-TR33	SP-351788B	17-8B		
EC-351992	3-C12	EI-349874	4-IC2	ET-308472	5-TR36	SP-351792	17-11		
EC-351994	3-C13	EI-355697	3-IC8	ET-308472	5-TR37	SP-351792B	17-11B		
EC-352007	3-C27	EI-355859	3-IC1	ET-308472	5-TR38	SP-351795A	16-3A		
EC-355727	3-C11	EI-355860	3-IC2	ET-310148	5-TR48	SP-351795B	16-3B		
ED-301911	3-D6	EI-355861	3-IC3	ET-310148	5-TR20	SP-351795C	16-3C		
ED-301911	3-D7	EI-355862	3-IC4	ET-310148	5-TR24	SZ-352197	17-3		
ED-301911	5-D11	EI-355863	3-IC6	ET-318237	5-TR32	TC-336146	1-36		
ED-301911	5-D16	EI-355864	3-IC5	ET-318237	5-TR40	ZG-313014	1-37		
ED-301911	5-D17	EI-355865	3-IC7	ET-322598	5-TR22	ZG-318204	1-28		
ED-301911	5-D36	EI-355865	5-IC15	ET-330238	10-D1	ZG-324825	1-38		
ED-301911	6-D1	EI-355866	3-IC16	ET-336869	5-TR52	ZG-351817	1-8		
	to 4	EI-355867	3-x1	ET-336869	5-TR53	ZG-352174	1-31		
ED-306010	3-D3	ET-355874	5-IC5	ET-336869	5-TR54	ZG-352184	1-33		
ED-306013	3-D4	EI-355875	5-IC3	ET-345625	5-TR45	ZS-325495	17-6x		
ED-306013	3-D5	EI-355876	5-IC14	ET-345625	5-TR41	ZS-331567	16-6		
ED-306109	5-D23	EI-357146	5-IC1	ET-345626	5-TR44	ZS-354427	1-30		
ED-306316	5-D30	EJ-301513	16-J901	ET-345626	5-TR47	ZS-355101	17-9x		
ED-319167	5-D29	EJ-345469	8-J25	ET-348302	5-TR1	ZS-358965	1-39		
ED-323836	5-D20	EJ-358901	9-J24	ET-348302	5-TR12	ZS-356467	17-10x		
ED-323836	5-D24	EM-355811	4-IN1	ET-348302	5-TR18	ZS-379350	16-9x		
	to 27	EO-330719	5-L1	ET-351872	3-TR6	ZS-417150	16-8		
ED-328700	5-D1	EO-345913	5-L2	ET-351872	5-TR42	ZS-430413	1-20		
ED-329057	5-D18	EQ-328529	3-RL1	ET-351872	5-TR46	ZS-432843	1-3		
ED-330319	5-D22	EQ-328529	3-RL2	ET-351872	5-TR39	ZS-442585	1-5		
ED-330319	5-D28	ER-310326	3-R35	ET-355807	11-PH1	ZS-447761	16-4		
ED-331197	4-D1	ER-310326	3-R51	ET-355807	11-PH1	ZS-536488	1-6		
ED-337265	5-D3	ER-310326	3-R52	ET-355877	3-TR1	ZS-572242	1-10		
ED-337265	5-D4	ER-310326	3-R53	ET-355877	5-TR8	ZS-608220	1-15		
ED-337265	5-D15	ER-311748	3-R54	ET-355877	5-TR25	ZW-345299	1-19		
ED-337266	5-D32	ER-311757	3-R30	ET-355877	5-TR28	ZW-270088	1-17		
ED-337266	5-D33	ER-311757	3-R33	ET-355877	5-TR34	ZW-485728	1-40		
ED-344280	3-D1	ER-314599	3-R34	ET-356806	3-TR7				
ED-344280	3-D2	ER-314600	3-R32	ET-356806	5-TR43				
ED-344280	3-D8	ER-314607	3-R31	ET-356806	5-TR50				
	to 12	ER-314629	3-R36	ET-356806	5-TR51				
ED-344280	5-D2	ER-318316	3-R29	ET-356807	3-TR2				
ED-344280	5-D6	ER-318317	3-R28	ET-356807	5-TR7				
ED-344280	5-D12	ER-329280	3-R37	ET-356807	5-TR27				
ED-344280	5-D13	ER-331188	5-FR1	EV-322415	5-VR1				
ED-344280	5-D14	ER-332225	3-FR1	EV-322415	5-VR2				
ED-344280	5-D31	ER-332225	3-FR2	EV-336853	5-VR3				
ED-346603	5-D37	ER-332225	3-FR3	EV-336853	5-VR4				
ED-346611	5-D10	ER-332225	3-FR4	EV-336853	5-VR5				
ED-346618	5-D9	ER-337999	3-R55	EV-337841	7-VR1				
ED-353291	10-D2	ER-357867	3-R46	EW-302899	16-1xA				
ED-357915	5-D19	ES-305733	16-S901A	EW-302995	16-1xD				
ED-357915	5-D34	ES-349367	4-SW1	EW-322401	16-1xE				
ED-357915	5-D35	ES-349367	6-SW1	EW-552237	16-1xB				
EF-309387	15-F1A		to 23	EW-638144	16-1xC				
EF-309387	15-F2A	ES-355631	16-SW901	EZ-200473	5-1				
EF-309387	15-F3A	ES-355842	12-SW1	EZ-631945	16-2x				
EF-310229	15-F1B	ES-355842	13-SW1	MB-352160	1-23				

RTV servis Horvat

Kešinci, 31402 Semeljci

Tel : 031-856-637

Tel / fax : 031-856-139

Mob : 098-788-319

rtv-servis-horvat@os.tel.hr

AKAI

MODEL **CD-A7**

SCHEMATIC DIAGRAM AND PC BOARD

1. BLOCK DIAGRAM OF IC's	2
2. CD-A7 SERVO BLOCK DIAGRAM	6
3. CD-A7 SIGNAL BLOCK DIAGRAM	7
4. SERVO SCHEMATIC DIAGRAM	8
5. SERVO PCB P2001A501A, POWER SUPPLY PCB P2001D5042 (U) (E, B, S) (C, A), FLD PCB P2001C5030, LED PCB P2001A50E, OPERATION PCB P2001A501B	9
6. CD-A7 SIGNAL SCHEMATIC DIAGRAM.	10
7. SIGNAL PCB P2001B502A	11
8. RC-80 REMOTE CONTROL SCHEMATIC DIAGRAM	12
9. REMOTE CONTROL PCB	12

BLOCK DIAGRAM OF IC's

[PURPOSE OF EACH IC's]

NAME OF IC	PURPOSE
BA6109	Motor Control
HA12049	Signal Processing for DAD Player
HD61Z001	Abstract the FFM and SYNC. Signal, Main Clock etc.
HD61901A	EFM Demodulator, DE-Interlive, Error Detection and Correction, Control & Display Data Process.
HD61902A	Address Control for EXT. RAM, Protecting SYNC Signal, Output Control, Digital Servo Control
HD14001BP	C-MOS nor Gate
HD6805	8 bit μ -Computer
HM6116P	16k bit Random Access Memory
LB1245	High Voltage, Darlington Array
LM311P	Voltage Comparator
M5218L0	Dual Low Noise Operational Amplifier
MB88401-331M	4 bit μ -Computer
MB84053B	Tripe-2 Channel Multiplexer/Demultiplexer
NJM4558D	Dual Low Noise Operational Amplifier
NJM5534D	Low Noise Operational Amplifier
NJM5221P	Dual Low Noise Operational Amplifier
PCM53JP-V	Digital to Analogue Convertor
TC4066	Analogue Switch
TC40H008P	High Speed C-MOS NAND Gate
TC4049	Inverter
TC4011BP	NAND Gate
μ PC1373H	Pre-Amplifier for Remote Control

HD6805 [8 bit μ -COMPUTER]

Pin No.	Symbol	Description	Pin No.	Symbol	Description
1	VSS	To GND	21	D3	} Sub Code Data Input
2	RST	Reset INPUT	22	D2	
3	INT	INTRRUPT INPUT	23	D1	
4	VCC	+5 V INPUT	24	D0	
5	X'tal	} Clock OSC INPUT 4MHz	25	B0	Not used
6	EX'tal		26	B1	KICK-S
7	NUM	To GND	27	B2	Not used
8	TM	Not used	28	B3	1Hz SIGNAL OUT
9	C0	} 4 bit Parallel Transfer Data IN/OUT	29	B4	Mute Control Out
10	C1		30	B5	Not used
11	C2		31	B6	} KICK- } Control Signal for Slide Motor KICK+ } Drive
12	C3		32	B7	
13	C4	8 Address Clock	33	A0	} CLVH ROT } Control Signal Out for Motor Stop } CLV Servo.
14	C5	EXT. Clock	34	A1	
15	C6	Sub Code/Track Counter Change Control of INT	35	A2	
16	C7	4 Address Clock	36	A3	} DC- } Control Signal for Slide Motor DC+ } Drive
17		Not used	37	A4	
18	D6	Ready	38	A5	} Not used
19	D5	Focus OK	39	A6	
20	D4	INSIDE detector FOR PICK-UP	40	A7	

MB88401-339M

Pin No.	Symbol	Description	Pin No.	Symbol	Description
1	R4	Data Transfer Control	22	SG/TO	Data Transfer Control
2	R5	} Data Strob out for Loading Mech. SW, Operation KEY, and Display Data	23	SI	N.C
3	R6		24	SO	N.C
4	R7		25	O0	} Display Data Output
5	R8		26	O1	
6	R9		27	O2	
7	R10		28	O3	
8	R11		29	O4	
9	R12		30	O5	
10	R13	31	O6		
11	R14	Synchro Operation Code out	32	O7	
12	K0	} Data Input of Loading Mech. SW and Operation KEY	33	P0	} Data Transfer Control
13	K1		34	P1	
14	K2		35	P2	Remote Control Gate Output
15	K3		36	P3	Reset Output for HD6805
16	EX	} 4MHz External Clock	37	R0	} Transfer Data In/Out with HD6805
17	X		38	R1	
18	Reset	RESET	39	R2	
19	IRQ	Remo-con or Synchro Operation Code INPUT	40	R3	
20	TC	N.C	41	VM	
21	VSS	GND	42	VCC	

HD61901A

PIN NO.	NAME	FUNCTION	PIN NO.	NAME	FUNCTION
1	RD3	DATA BUS (MSB)	36	TEFR	+5V
2	RD4		37		
5	RD7		38		
6	TC1	Not use	39		Not use
7	TC2		46		
8	EP3	ERROR POINTER DATA Output (LSB)	47		+5V
9	EP4		48		
12	EP0		49	IRQ	
13	OEN	(H: Enable)	50	CDQ0	(LSB)
14	Qsync	Qsync Signal Input	51	CDQ1	C & D DATA Output (Q Data) (MSB)
15	CORS		53	CDQ3	
16	MCK1	SIGNAL PROCESSING CLOCK Input (4.3218MHz)	54	CDP	Not use
			55	MUI	
17	SCK2	SIGNAL PROCESSING CLOCK Input	56	CKEXT	CLOCK Input
18	SCK1		57		Not use
19		+5V	58	RD0	DATA BUS (LSB)
20			59	RD1	
22			60	RD2	
23	VSS	GND			
24		Not use			
25					
26					
27					
28	EMP	Control & Display (Emphasis) Output			
29	VDD	+5V			
30		Not use			
31	Ssync	EFM Signal Lu PULSE Input			
32	DATAACK	DATA LCOCK Input			
33	SDATA	EFM Signal Input			
34	DSTR	STROB Signal Input of 8 bit DATA (except C&D)			
35	CDSTR	STROB Signal Input of 8 bit DATA (C & D)			

HD61902A

PIN NO.	NAME	FUNCTION	PIN NO.	NAME	FUNCTION
1	RD6	DATA Input from IC4 (HM6116)	47	SCK1	SIGNAL PROCESSING CLOCK Output (4.3218MHz)
2	RD7		48	SCK2	
3	MPX		49	MCK1	
4	SHL	SAMPLE HOLD Signal Output (L-CH) (H: SAMPLE L: HOLD)	50	CORS	
5	MPXN	Not use	51	Qsync	Qsync Signal Output
6	SHR	SAMPLE HOLD Signal Output (R-CH) (H: SAMPLE L: HOLD)	52	OEN	OEN Signal Output H ^o -ENABLE
7	CKDE	Not use	53	EPO	} ERROR POINTER DATA Input (LSB)
8	DA ϕ	(LSB)	?	?	
?	?	DATA Output to D/A CONVERTER	57	EP4	
23	DA15	(MSB)	58	RST	RESET Signal Input (L: RESET H: NORMAL)
24	VSS	GND	59	RAO	} RAM ADDRESS Signal Output (LSB)
25	PWM	Maximum Pulse Wide Control Output	?	?	
26	PD		69	RAIO	
27		Not use	70	CS	RAM CIP SELECT Signal Output (L: Cip Select)
?					
29					
30	PREF	REFERENCE Frequency Output for PWM (Duty 50% 33.8kHz)	71	WE	WRITE ENABLE Signal Output (L: Write Enable)
31	CLVH	CONTROL Signal from IC16 (HD6803)	72		+5V
32	VDD	+5V	?		
33	ROT	CONTROL Signal from IC16 (HD6803)	74		
34	MUZ	MUTE Signal (L: Mute H: Normal)	75	RD ϕ	} DATA Input from RAM (HD6803) (LSB)
35	PW ϕ	(LSB)	?	?	
?	?	} PULSE WIDE DATA Input	80	RD5	
40	PW5		(MSB)		
41	EDCK	EDGE CLOCK Input of EFM			
42	TP	+5V			
43	Bsync	Bsync Input			
44	Async	Async Input			
45	MCK	MASTER CLOCK Input (4.3218MHz)			
46	Psync	Psync () Signal Output			

HD61Z001

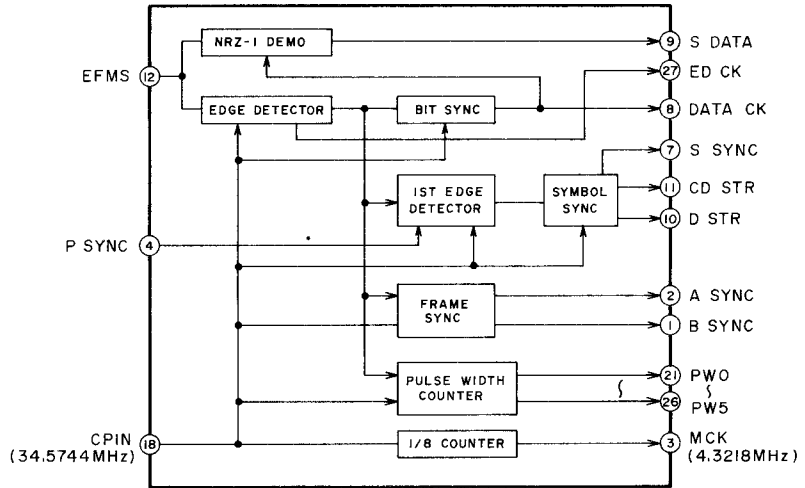

MB84053B

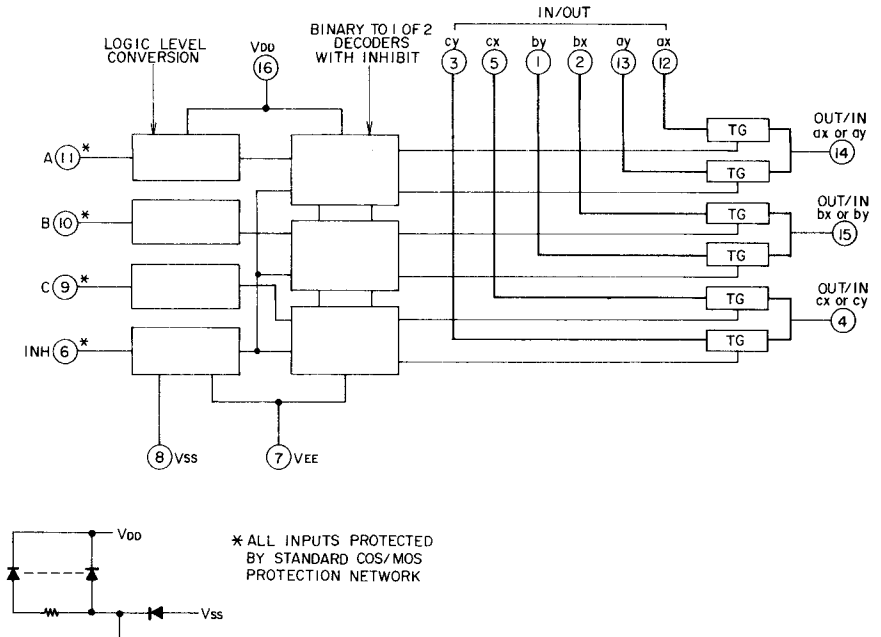

PCM53JP-V

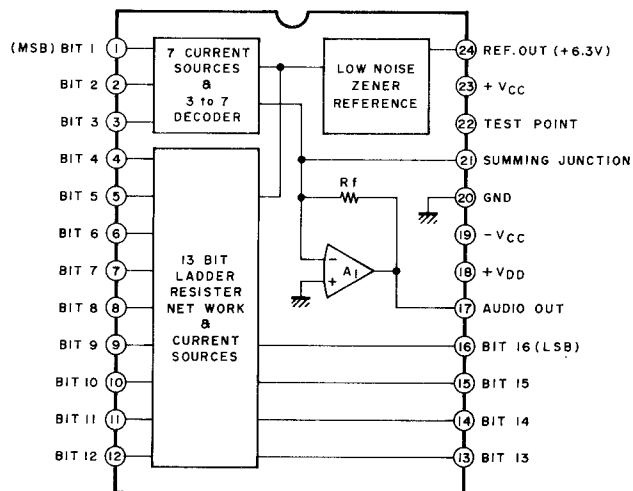

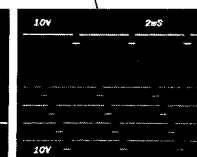
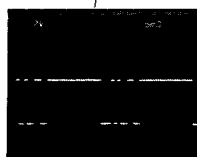
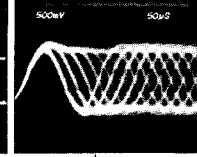
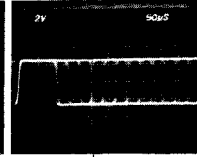
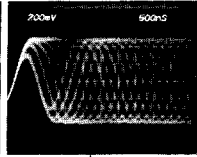
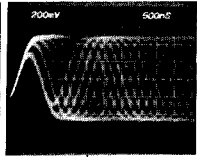
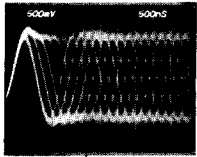
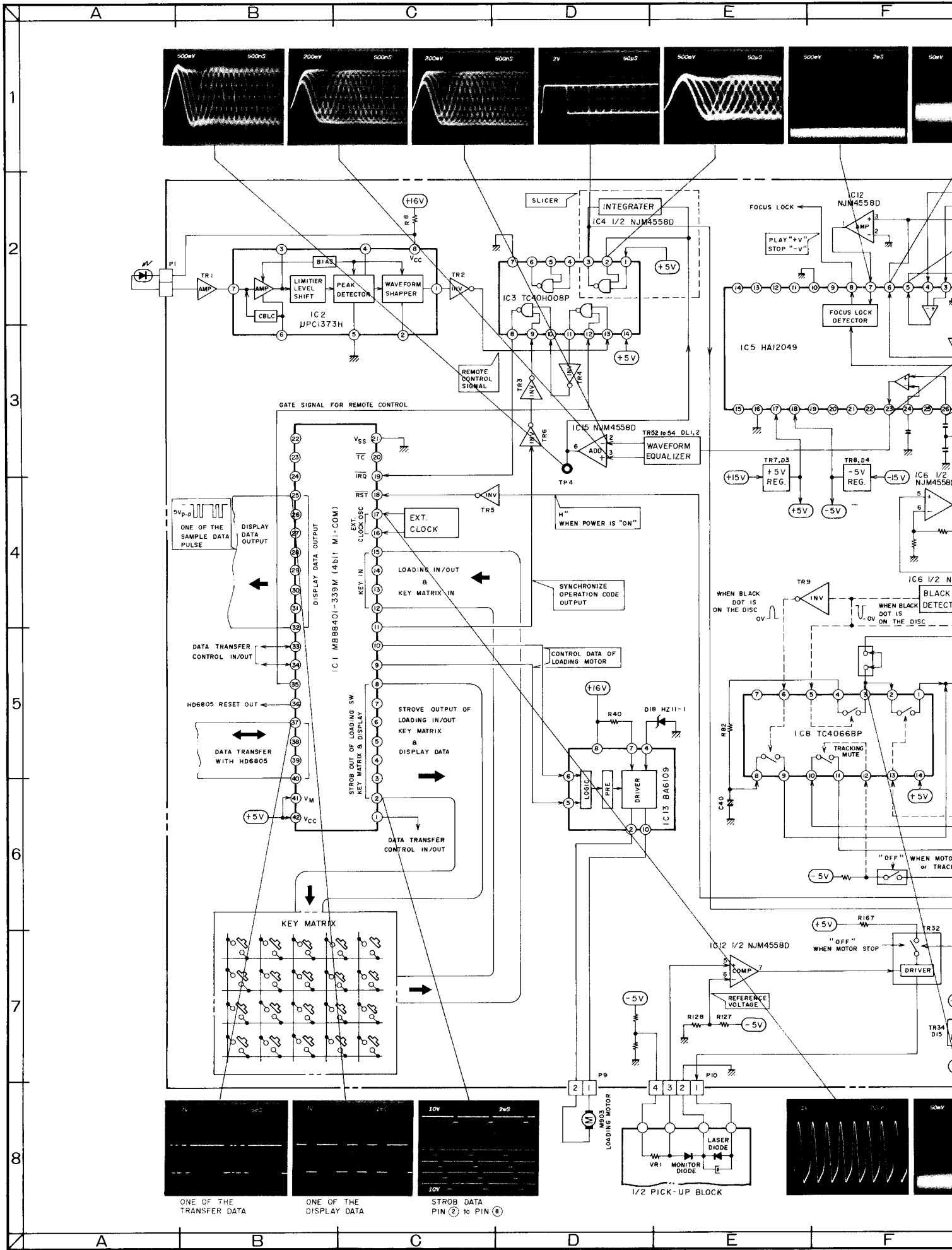

ONE OF THE TRANSFER DATA

ONE OF THE DISPLAY DATA

STROBE DATA PIN (2) TO PIN (8)

1/2 PICK-UP BLOCK

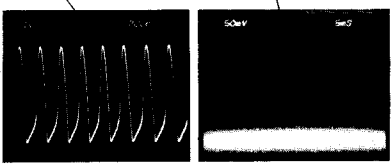
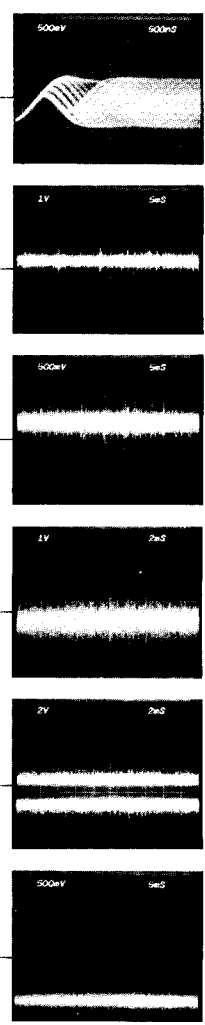
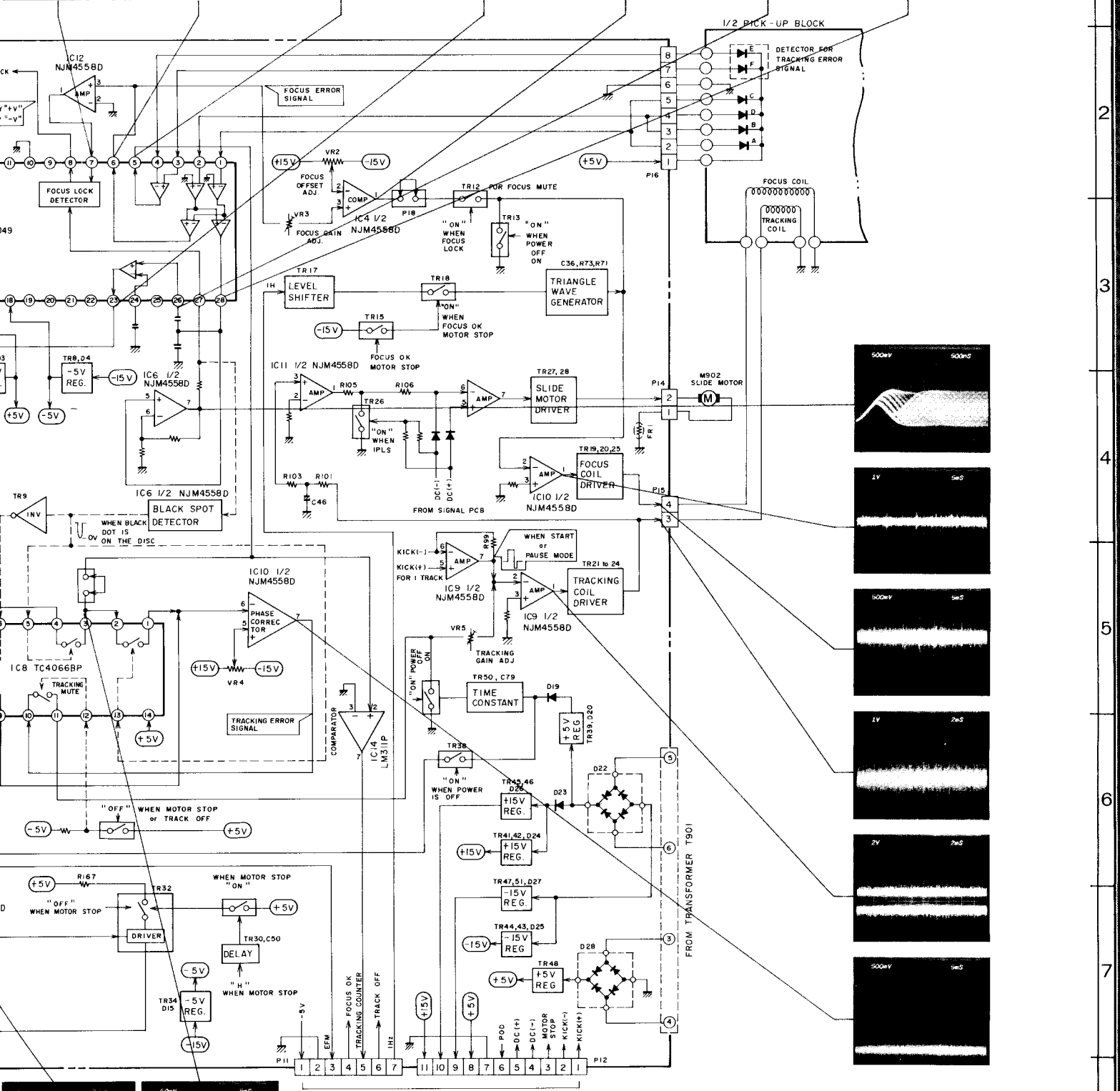
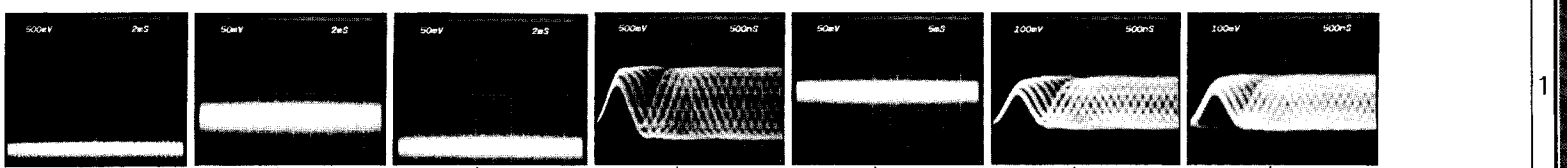

CD-A7 SERVO
BLOCK DIAGRAM
NO.2-1 850101A

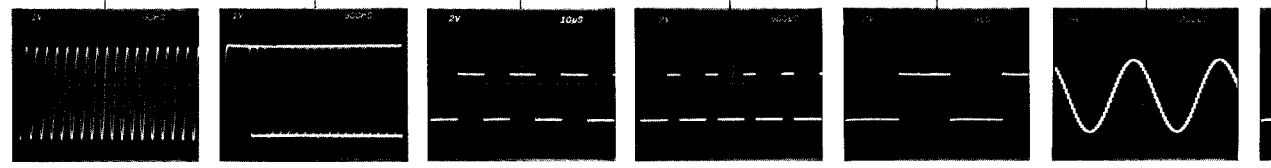
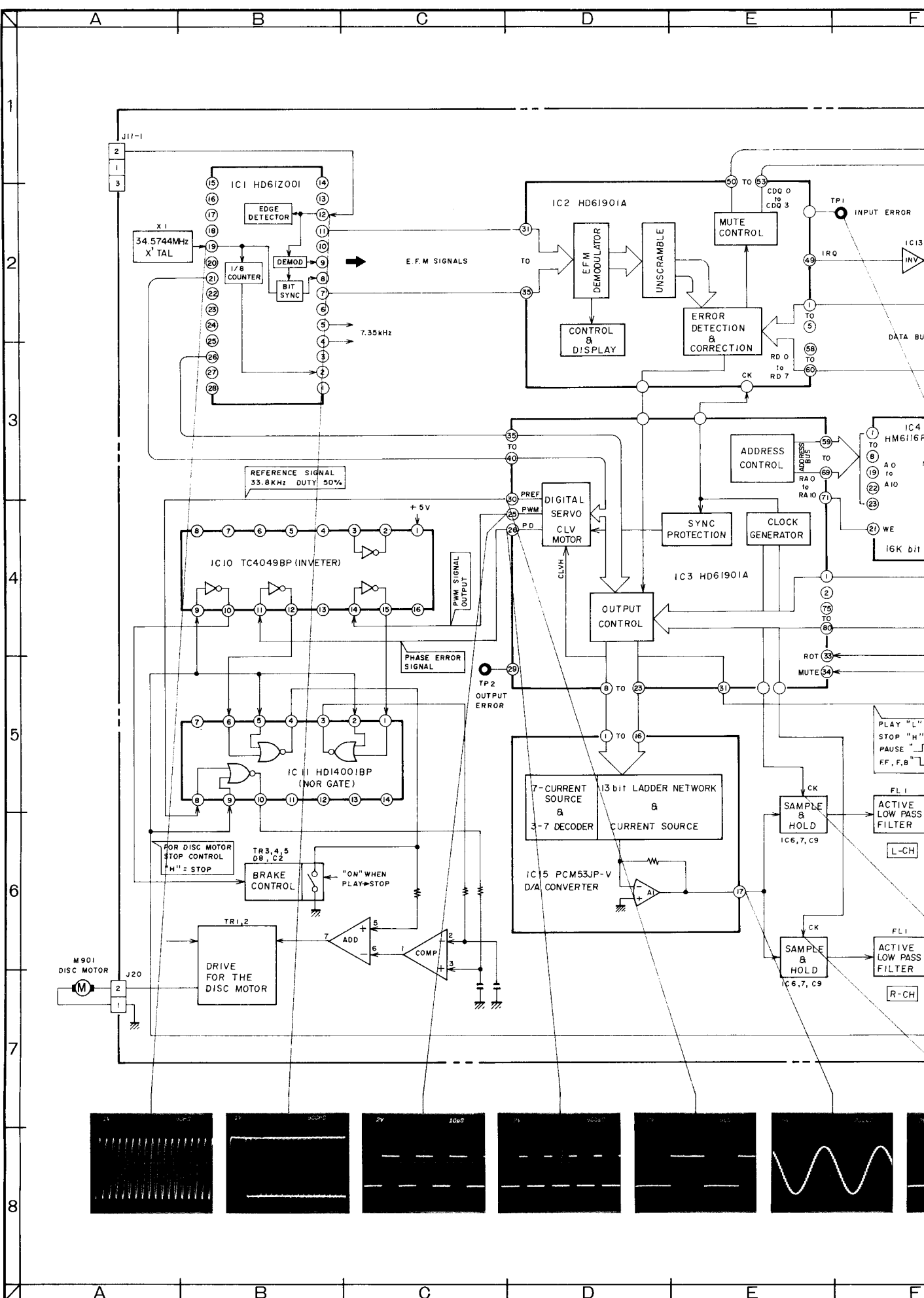

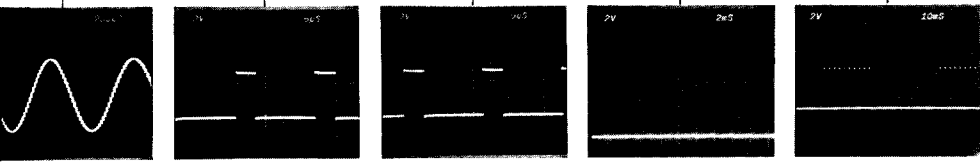
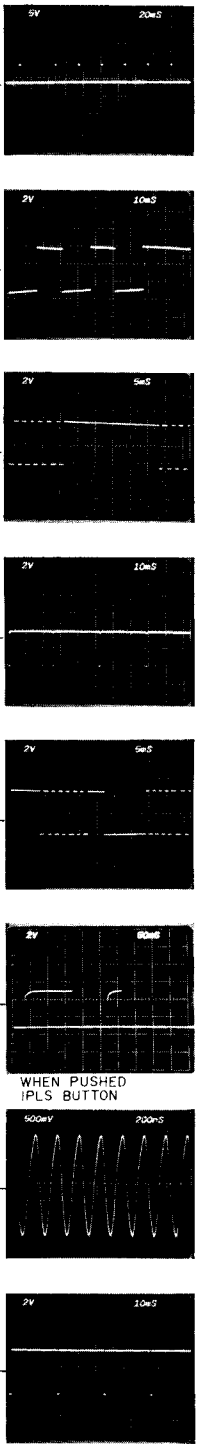
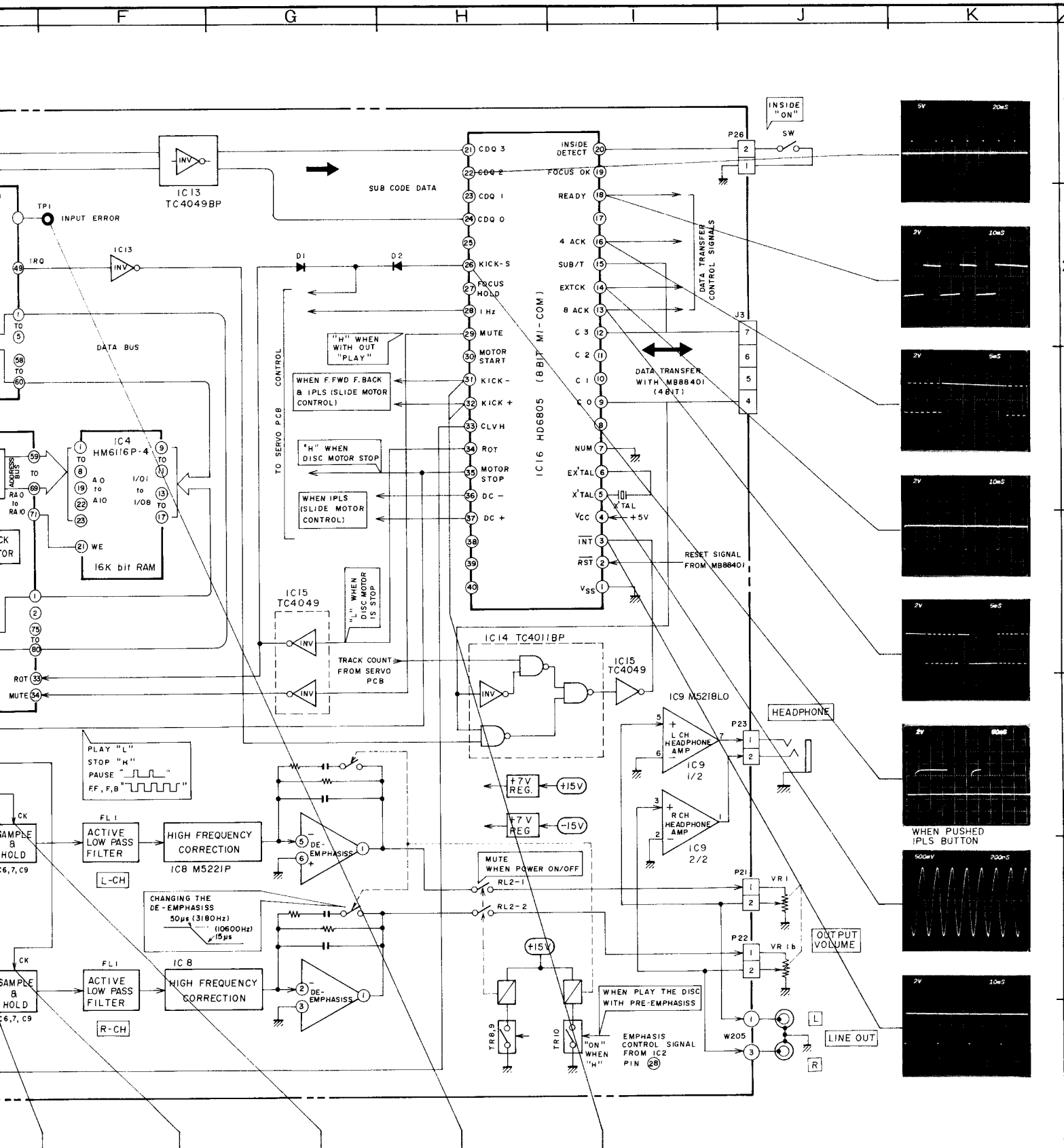

CD-A7 SIGNAL BLOCK DIAGRAM No.2-2 850102A₂

CD-A7

SERVO PCB P200IA501A

LED PCB (1/2) P200IA501E

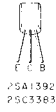

75A1392
75C3383



75B764
75B8663
75C753



75A1248
75B652K
75C3116
75D612K



75A1115
75C2603
75C2999



75K38



75K38

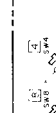

75K38

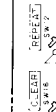

75K38

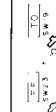

75K38

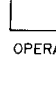

75K38



75K38

OPERATION PCB P200IA501B

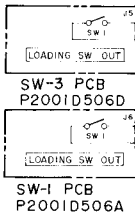

SW-3 PCB
P200ID506D

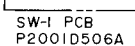

SW-1 PCB
P200ID506A

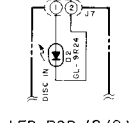

LED PCB (2/2)
P200IA501E

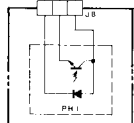

DETECTOR PCB
P200ID506B

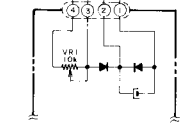

PICK-UP PCB (2/2)

INDICATED VOLTAGES ARE MEASURED AT PLAY MODE

+B (POWER SUPPLY) LINE

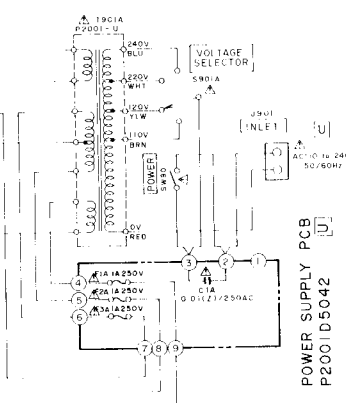
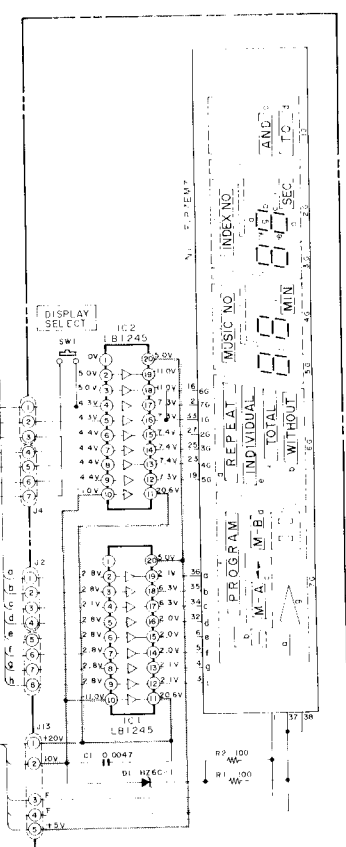
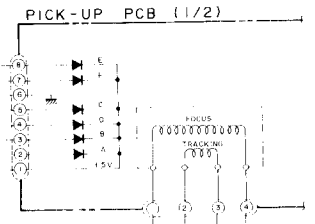
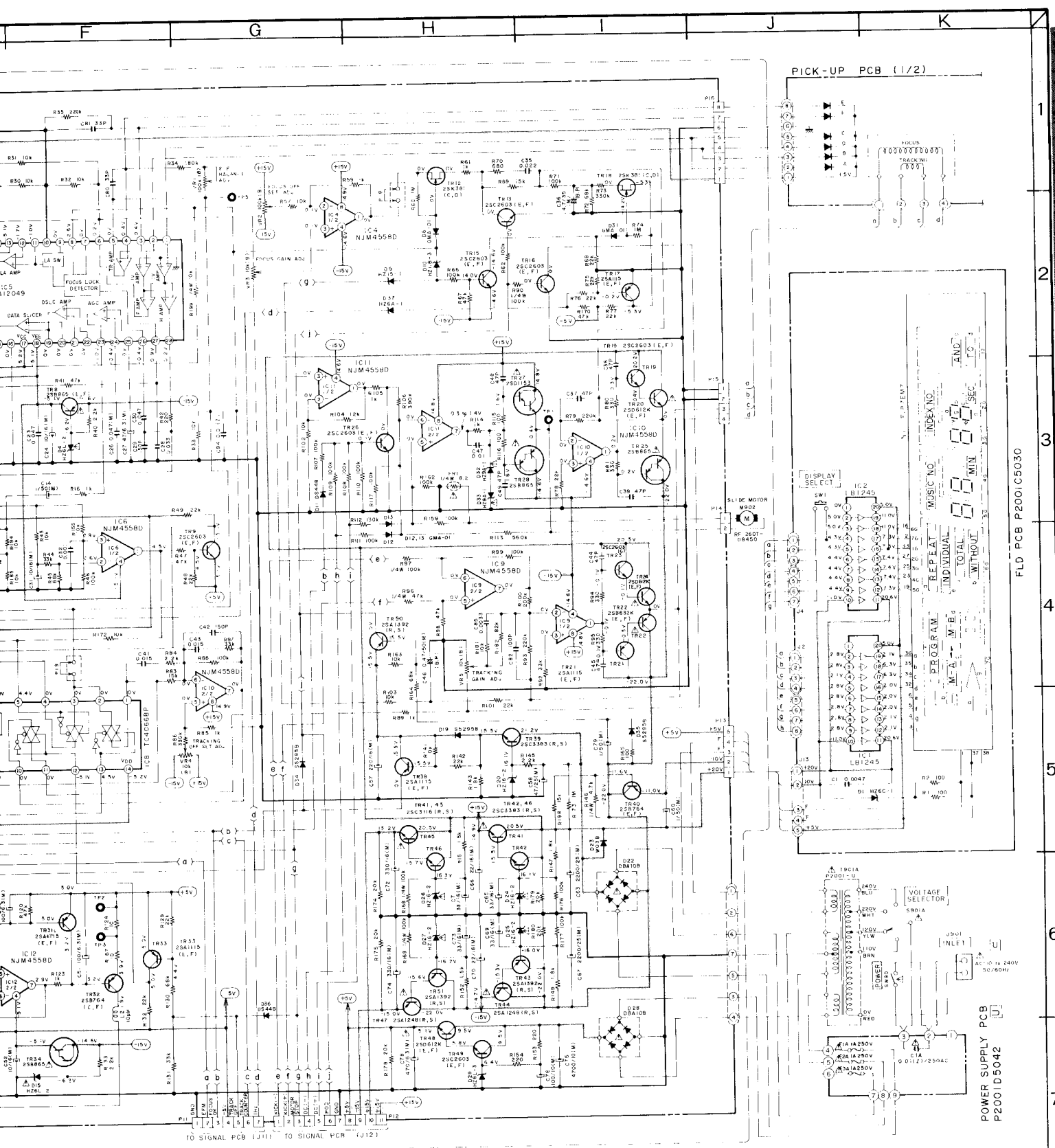

INDICATED VOLTAGES ARE MEASURED AT PLAY MODE.

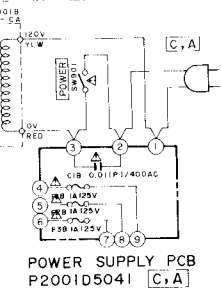
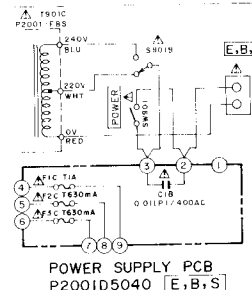

WARNING: INDICATES SAFETY CRITICAL COMPONENTS FOR CONTINUED SAFETY. REPLACE SAFETY CRITICAL COMPONENTS ONLY WITH MANUFACTURER'S RECOMMENDED PARTS.
 AVERTISSEMENT: Δ IL INDIQUE LES COMPOSANTS CRITIQUES DE SÉCURITÉ. POUR MAINTENIR LE DEGRÉ DE SÉCURITÉ DE L'APPAREIL, NE REMPLACEZ QUE DES PIÈCES RECOMMANDÉES PAR LE FABRICANT.

NOTE: UNLESS OTHERWISE SPECIFIED, ALL RESISTORS IN OHMS (1/6W). POWER TRANSFORMER IS DIFFERENT ACCORDING TO AREA.

CD-A7 SERVO SCHEMATIC DIAGRAM No. 3-1 850103A

FLD PCB P2001C5030

POWER SUPPLY PCB P2001D5042

POWER SUPPLY PCB P2001D5040 [E, B, S]

POWER SUPPLY PCB P2001D5041 [C, A]

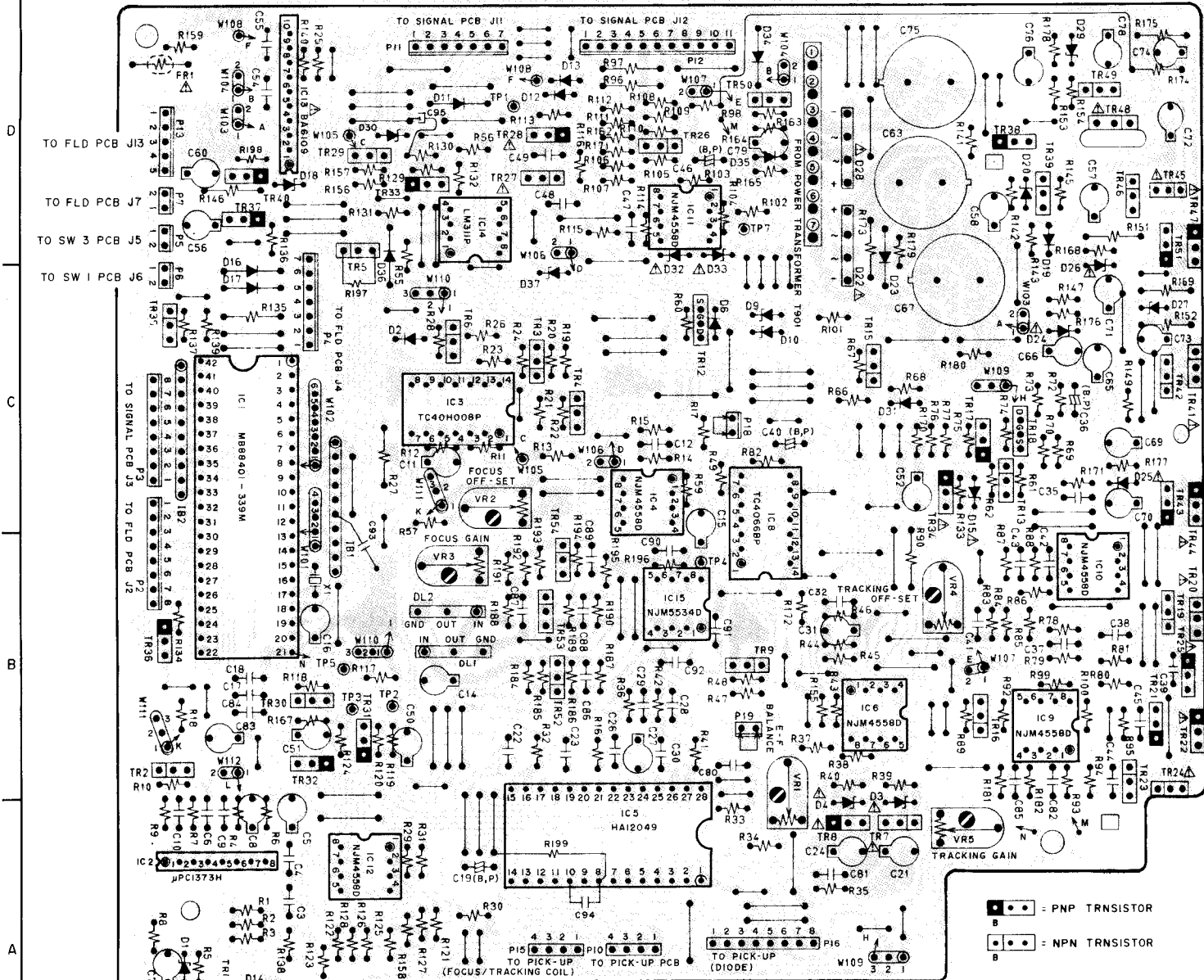

SERVO PCB P200IA501A

P15 TO PICK-UP
P16 TO PICK-UP PCB
P17 TO PICK-UP (DIODE)
P18 TO PICK-UP
P19 TO PICK-UP
P20 TO PICK-UP
P21 TO PICK-UP
P22 TO PICK-UP
P23 TO PICK-UP
P24 TO PICK-UP
P25 TO PICK-UP
P26 TO PICK-UP
P27 TO PICK-UP
P28 TO PICK-UP
P29 TO PICK-UP
P30 TO PICK-UP
P31 TO PICK-UP
P32 TO PICK-UP
P33 TO PICK-UP
P34 TO PICK-UP
P35 TO PICK-UP
P36 TO PICK-UP
P37 TO PICK-UP
P38 TO PICK-UP
P39 TO PICK-UP
P40 TO PICK-UP
P41 TO PICK-UP
P42 TO PICK-UP
P43 TO PICK-UP
P44 TO PICK-UP
P45 TO PICK-UP
P46 TO PICK-UP
P47 TO PICK-UP
P48 TO PICK-UP
P49 TO PICK-UP
P50 TO PICK-UP
P51 TO PICK-UP
P52 TO PICK-UP
P53 TO PICK-UP
P54 TO PICK-UP
P55 TO PICK-UP
P56 TO PICK-UP
P57 TO PICK-UP
P58 TO PICK-UP
P59 TO PICK-UP
P60 TO PICK-UP
P61 TO PICK-UP
P62 TO PICK-UP
P63 TO PICK-UP
P64 TO PICK-UP
P65 TO PICK-UP
P66 TO PICK-UP
P67 TO PICK-UP
P68 TO PICK-UP
P69 TO PICK-UP
P70 TO PICK-UP
P71 TO PICK-UP
P72 TO PICK-UP
P73 TO PICK-UP
P74 TO PICK-UP
P75 TO PICK-UP
P76 TO PICK-UP
P77 TO PICK-UP
P78 TO PICK-UP
P79 TO PICK-UP
P80 TO PICK-UP
P81 TO PICK-UP
P82 TO PICK-UP
P83 TO PICK-UP
P84 TO PICK-UP
P85 TO PICK-UP
P86 TO PICK-UP
P87 TO PICK-UP
P88 TO PICK-UP
P89 TO PICK-UP
P90 TO PICK-UP
P91 TO PICK-UP
P92 TO PICK-UP
P93 TO PICK-UP
P94 TO PICK-UP
P95 TO PICK-UP
P96 TO PICK-UP
P97 TO PICK-UP
P98 TO PICK-UP
P99 TO PICK-UP
P100 TO PICK-UP

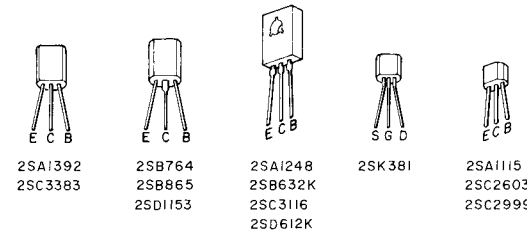

- TR1, 12, 18..... 2SK381 (C,D)
- TR2 to 6, 9, 13, 15, 16, 19, 23, 26, 29, 30, 35, 49..... 2SC2603 (E,F)
- TR7, 27..... 2SD1153 (E,F)
- TR8, 25, 28, 34..... 2SB865 (E,F)
- TR17, 21, 31, 33, 36 to 38..... 2SA1115 (E,F)
- TR22..... 2SB632K (E,F)
- TR20, 24, 48..... 2SD612K (E,F)
- TR32, 40..... 2SB764 (E,F)
- TR41, 45..... 2SC3116 (R,S)
- TR43, 50, 51..... 2SA1392 (R,S)
- TR44, 47..... 2SA1248 (R,S)
- TR52 to 54..... 2SC2999 (C,D)

WARNING: INDICATES SAFETY CRITICAL COMPONENTS FOR CONTINUED SAFETY. REPLACE SAFETY CRITICAL COMPONENTS ONLY WITH MANUFACTURER'S RECOMMENDED PARTS.

AVERTISSEMENT: IL INDIQUE LES COMPOSANTS CRITIQUES DE SÉCURITÉ POUR MAINTENIR LE DEGRÉ DE SÉCURITÉ DE L'APPAREIL. NE REMPLACER QUE DES PIÈCES RECOMMANDÉES PAR LE FABRICANT.

CD-A7

1

2

3

4

5

6

7

8

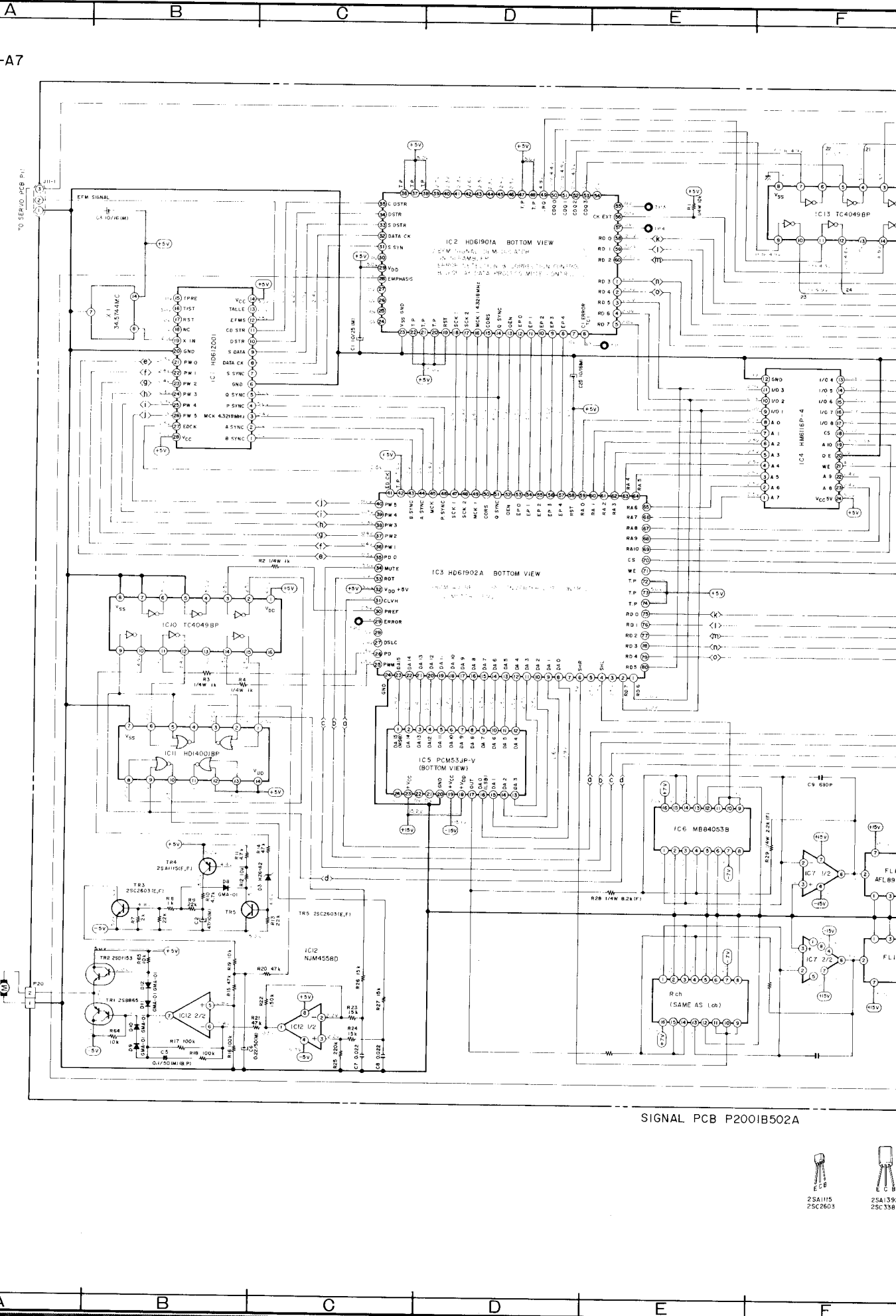

SIGNAL PCB P200IB502A

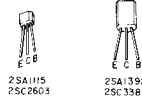

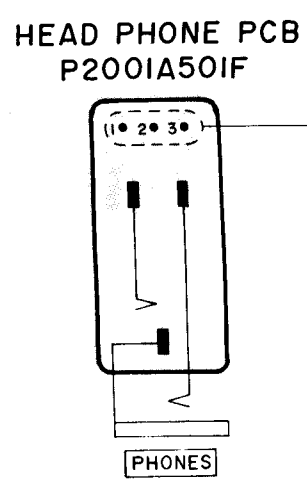
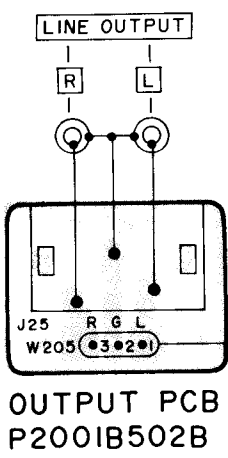
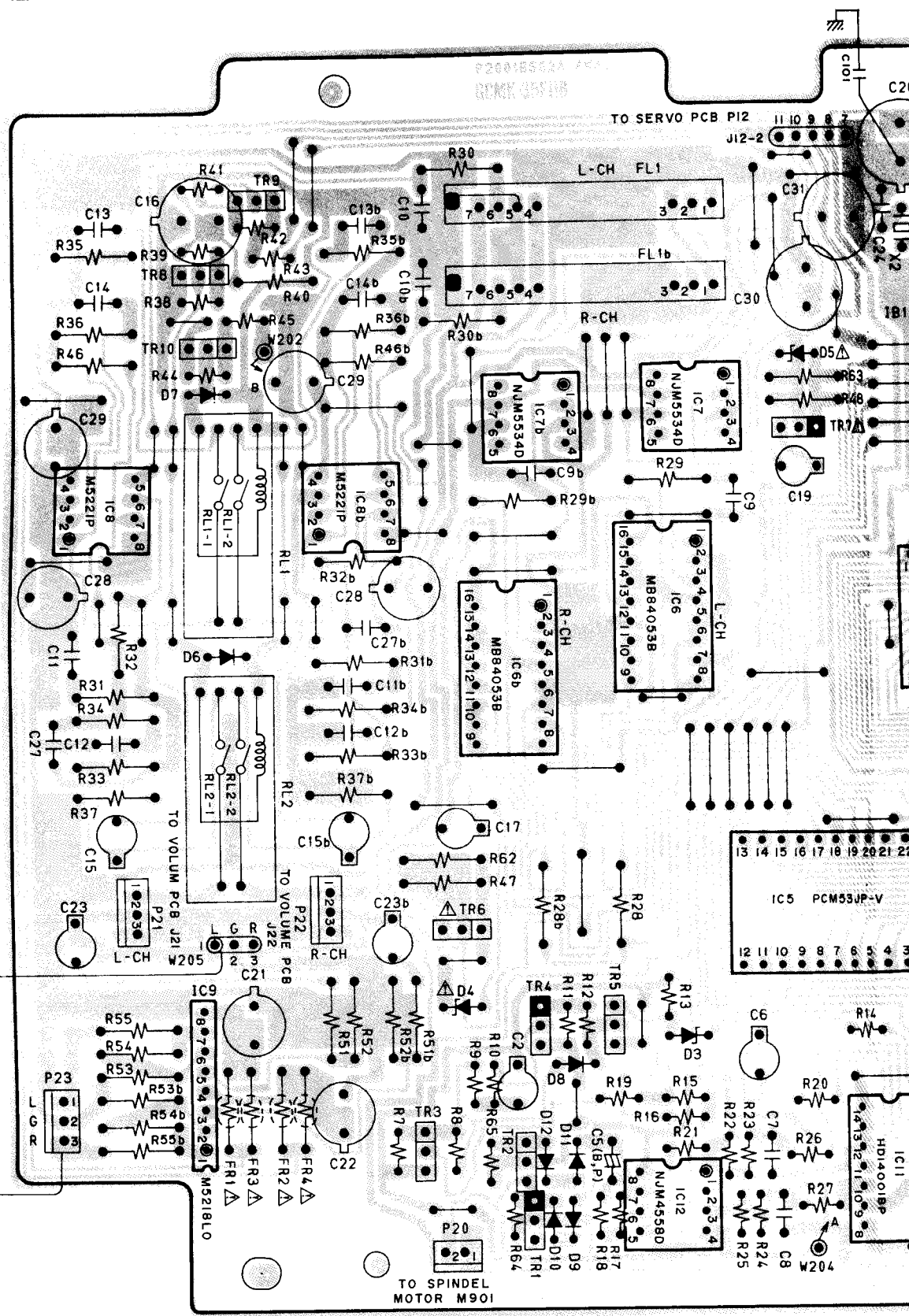

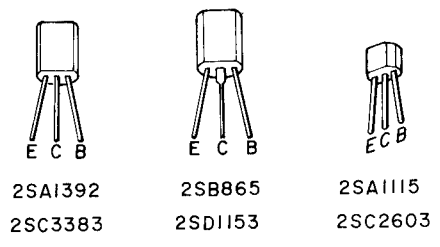

SIGNAL PCB P200IB502A

- TR1,.....2SB865
- TR2,.....2SD1153
- TR3,5,8to10,.....2SC2603(E,F)
- TR4,.....2SA1115(E,F)
- TR6,.....2SC3383(R,S)
- TR7,.....2SA1392(R,S)



 = PNP TRANSISTOR
 = NPN TRANSISTOR

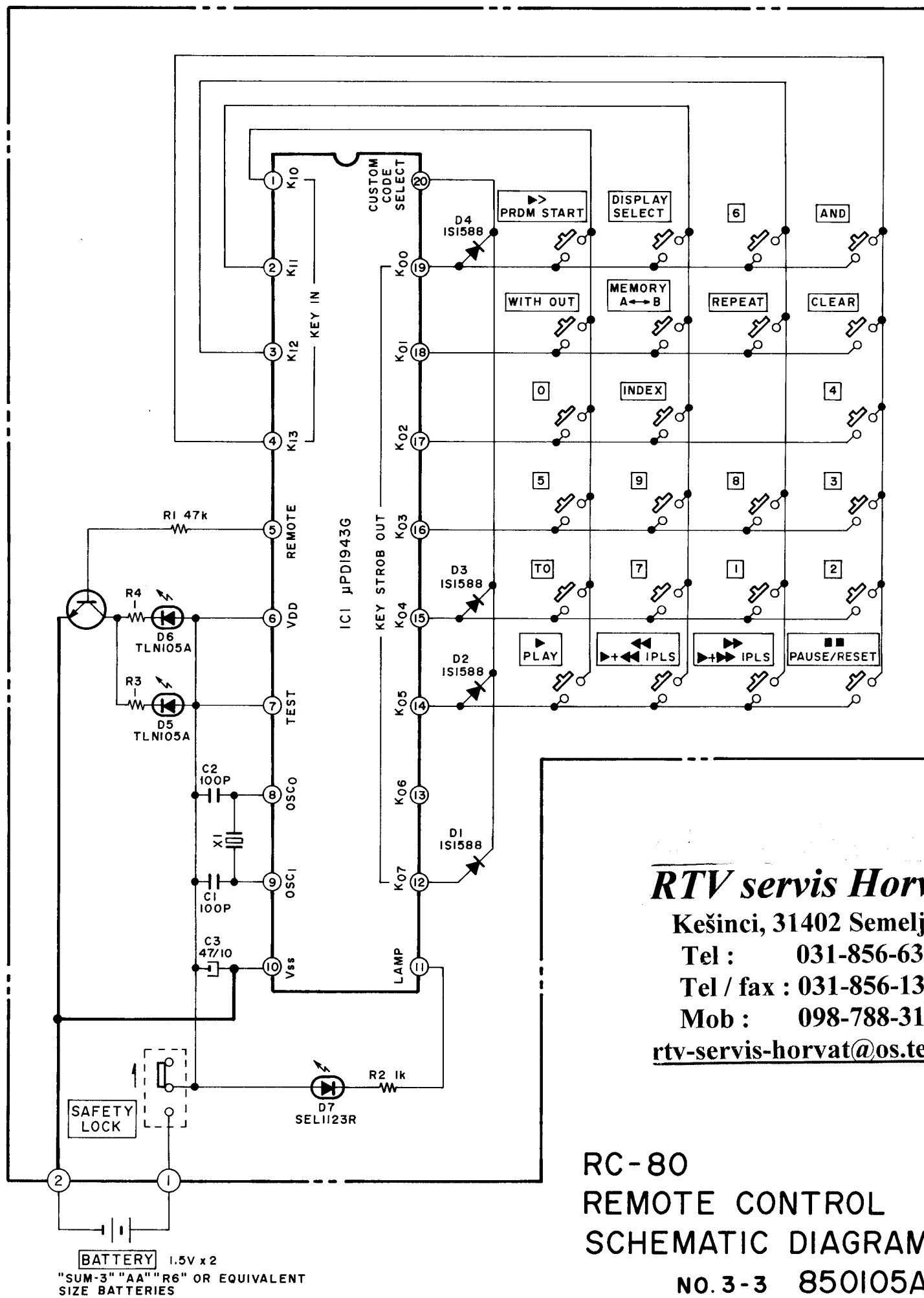

RTV servis Horv
 Kešinci, 31402 Semelj
 Tel : 031-856-63
 Tel / fax : 031-856-13
 Mob : 098-788-31
rtv-servis-horvat@os.te

**RC-80
 REMOTE CONTROL
 SCHEMATIC DIAGRAM
 No. 3-3 850105A**

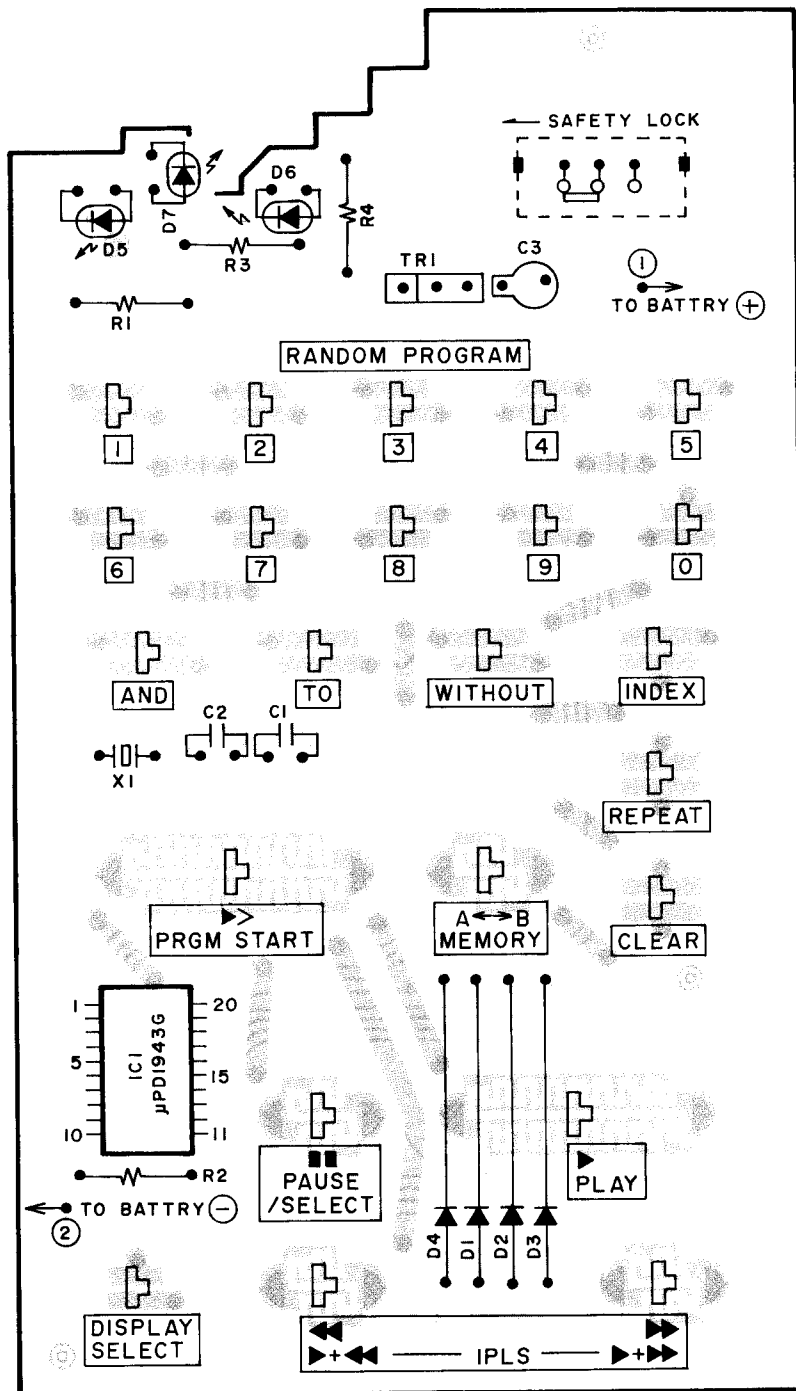
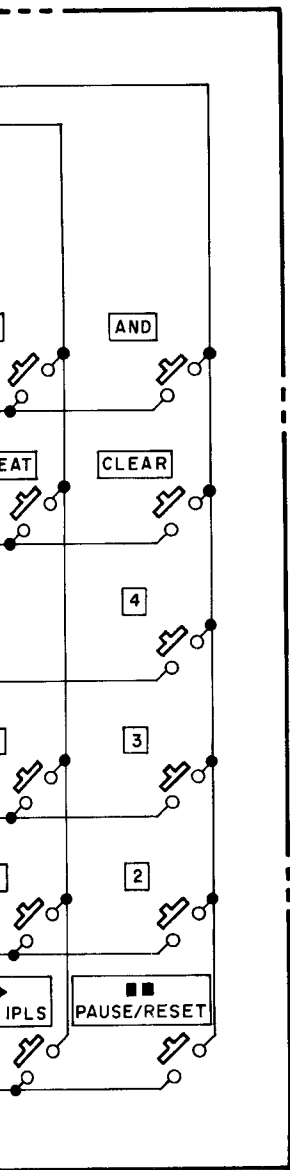

REMOTE CONTROL PCB

servis Horvat
 ci, 31402 Semeljci
 031-856-637
 fax : 031-856-139
 : 098-788-319
 vis-horvat@os.tel.hr

CONTROL
 IC DIAGRAM
 -3 850105A

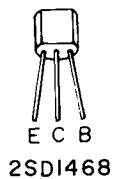

TRI --- 2SD1468

= NPN TRANSISTOR

LOCATION OF TR'S

- TR1.....A4
- TR2.....B4
- TR3.....C3
- TR4.....C3
- TR5.....D4
- TR6.....C3
- TR7.....A2
- TR8.....A2
- TR9.....B2
- TR12.....C2
- TR13.....C1
- TR15.....C2
- TR16.....B1
- TR17.....C1
- TR18.....C1
- TR19.....B1
- TR20.....B1
- TR21.....B1
- TR22.....B1
- TR23.....B1
- TR24.....B1
- TR25.....B1
- TR26...D2,D3
- TR27.....D3
- TR28.....D3
- TR29.....D4
- TR30.....B4
- TR31.....B4
- TR32.....B4
- TR33.....D3
- TR34.....C1
- TR35.....C4
- TR36.....B4
- TR37.....D4
- TR38.....D1
- TR39.....D1
- TR40.....D4
- TR41.....C1
- TR42.....C1
- TR43.....C1
- TR44.....C1
- TR45.....D1
- TR46.....D1
- TR47.....D1
- TR48.....D1
- TR49.....D1
- TR50.....D2
- TR51.....D1
- TR52.....B3
- TR53.....B3
- TR54.....B3

LOCATION OF CONNECTORS

- P1.....A4
- P2...B4,C4
- P3.....C4
- P4.....C4
- P5.....D4
- P6.....C4
- P7.....D4
- P8.....A4
- P9.....A4
- P10.....A3
- P11.....D3
- P12...D2,D3
- P13.....D4
- P14.....A4
- P15.....A3
- P16.....A2

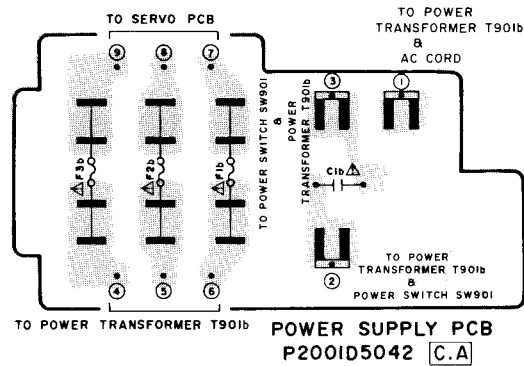
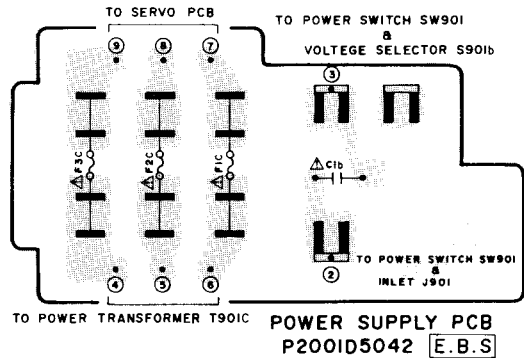
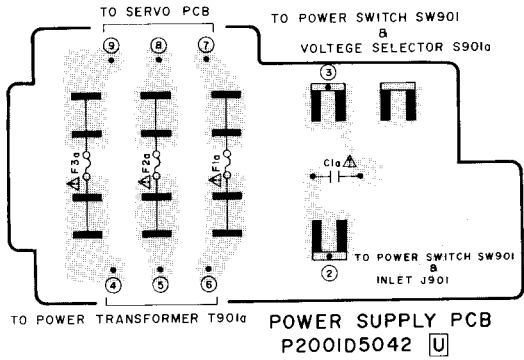

LOCATION OF IC'S

- IC1.....B4,C4
- IC2.....A4
- IC3.....C3
- IC4....C2,C3
- IC5....A2,A3
- IC6.....B2
- IC8....B2,C2
- IC9.....B1
- IC10.....B1
- IC11...D2,D3
- IC12...A3,A4
- IC13.....D4
- IC14.....D3
- IC15...B2,B3

