



**AKAI**

**AM/FM STEREO RADIO (PPL)  
CD/CDRW PLAYER W/REMOTE**

Model:  
CD-P2400RDS

**SERVICE MANUAL**

U-1-2-400 R03

# PRINTED CIRCUIT BOARDS

## MAIN PCB

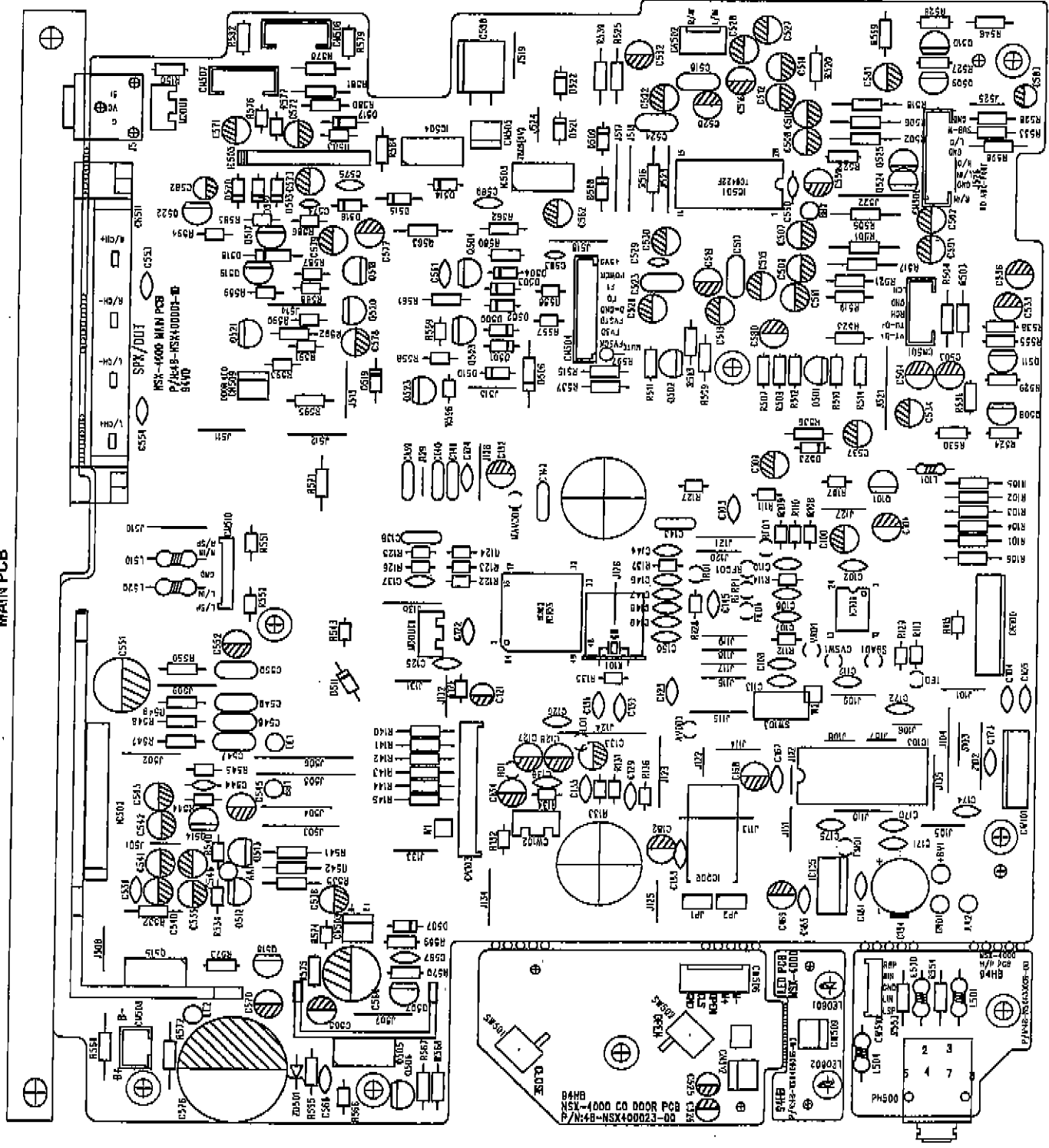

- 5 DEC 2003

MAIN PCB

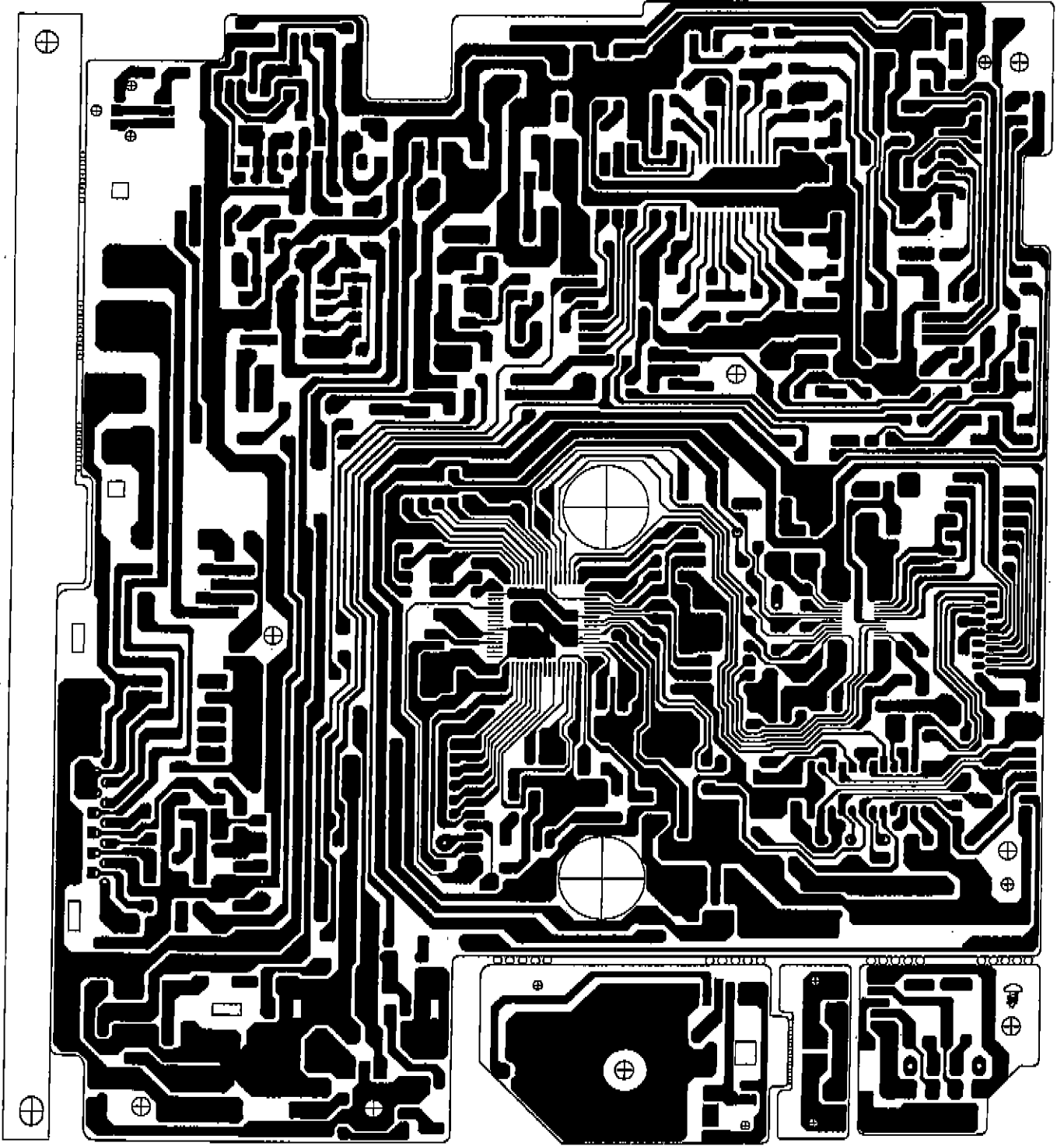

- 5 DEC 2003

DISPLAY PCB

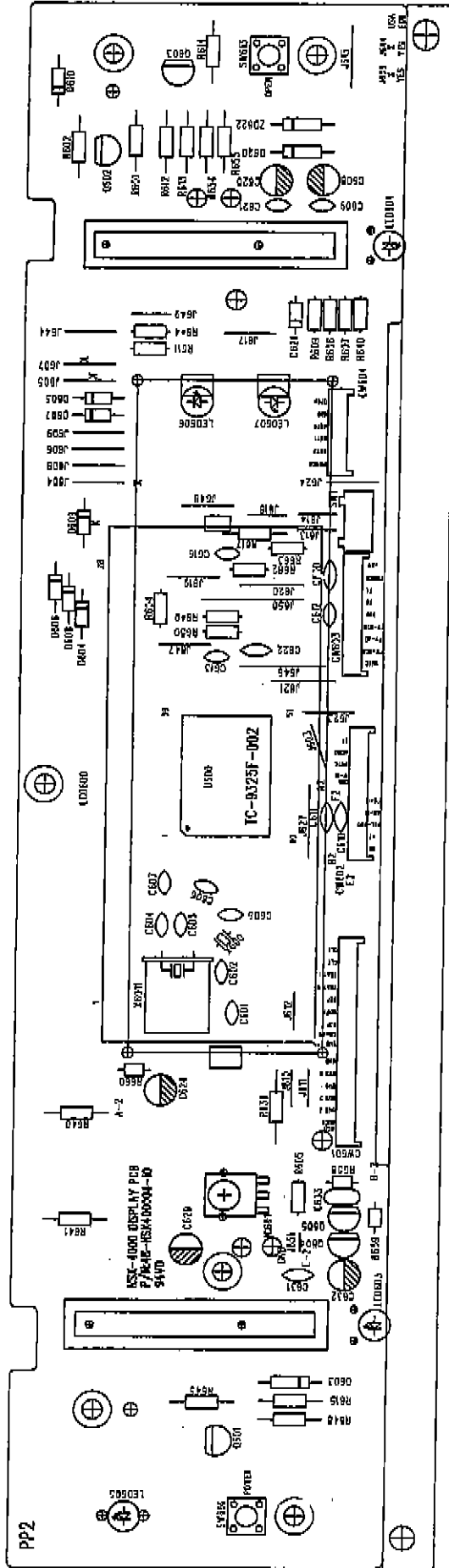

- 5 DEC 2003

DISPLAY PCB

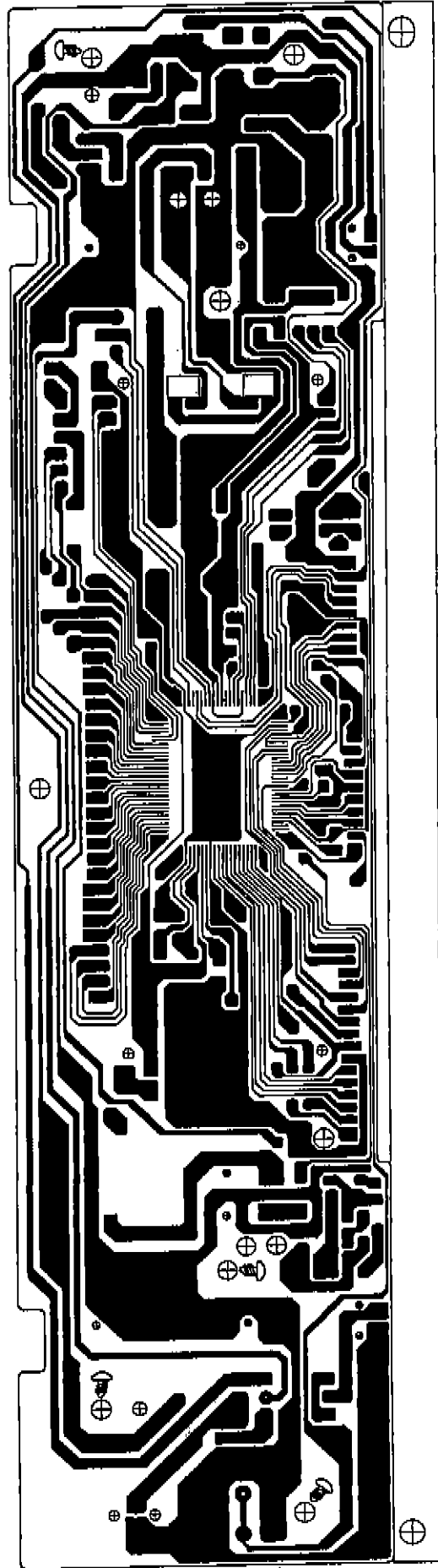

- 5 DEC 2003

TUNER PCB

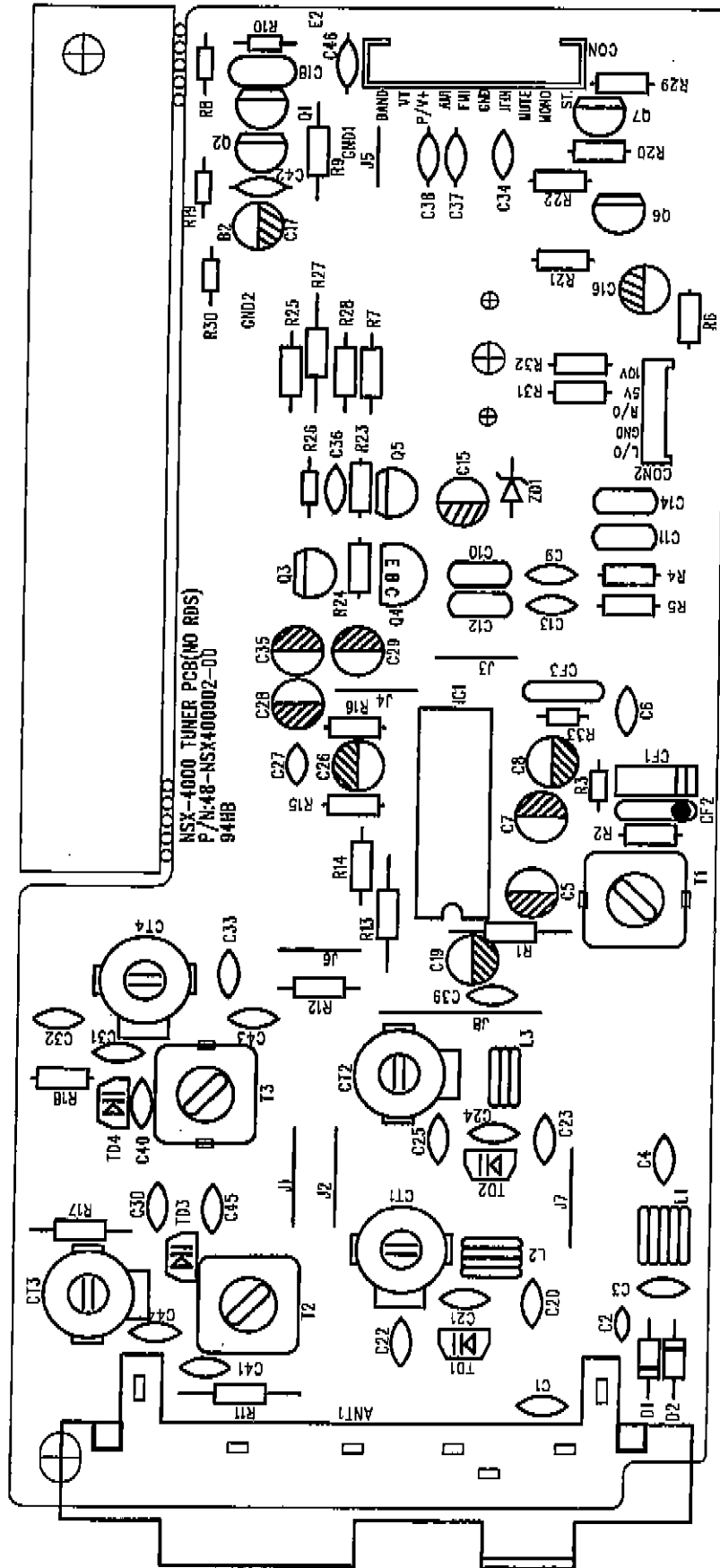

TUNER PCB

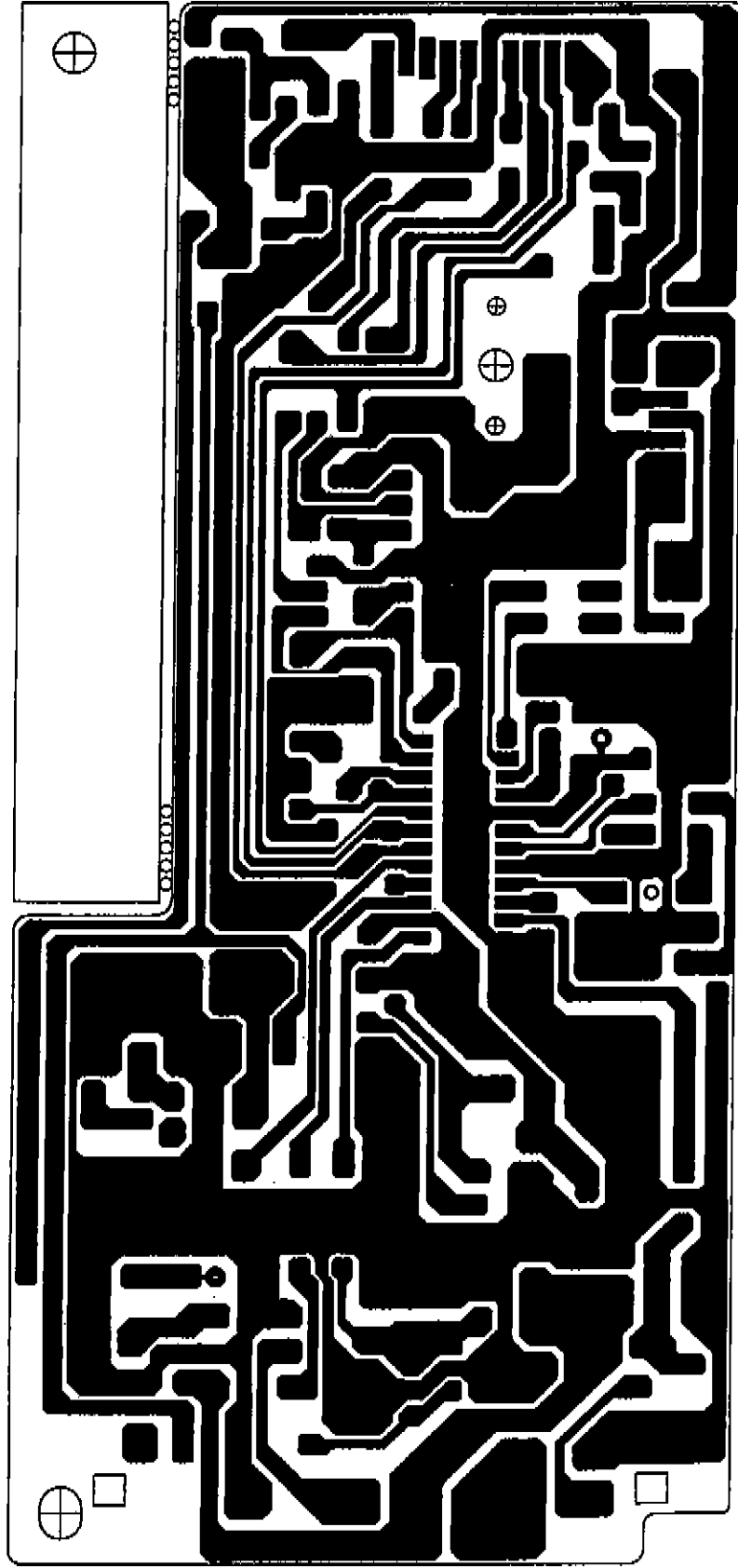

- 5 DEC 2003

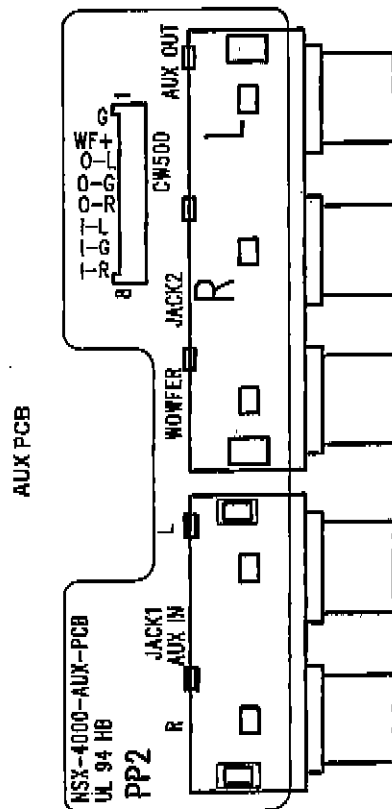
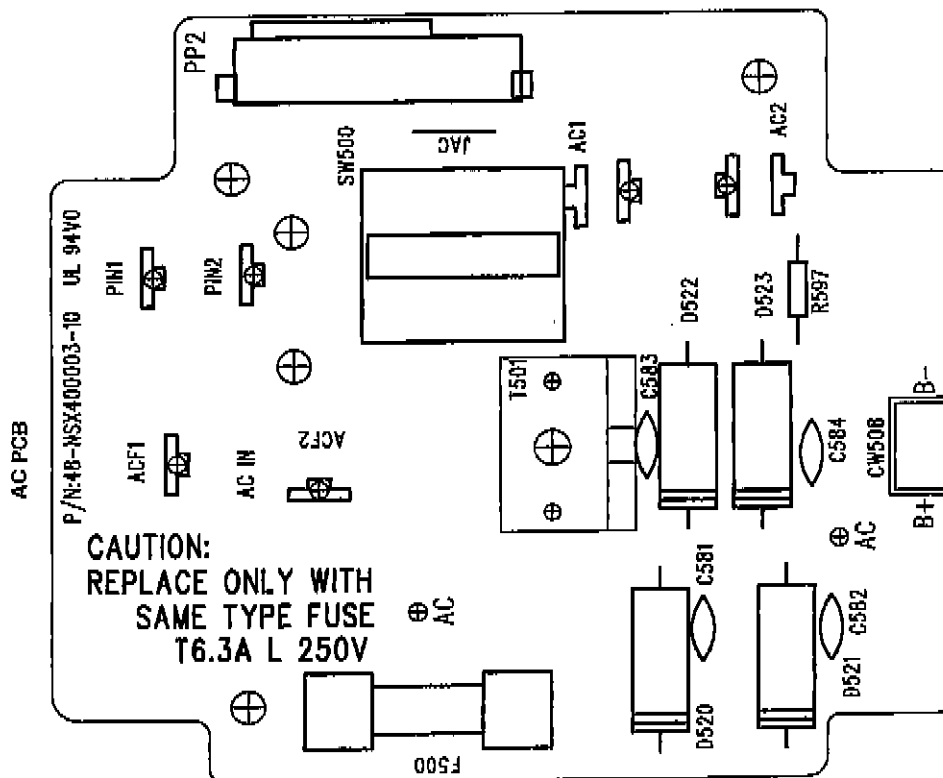



AC PCB

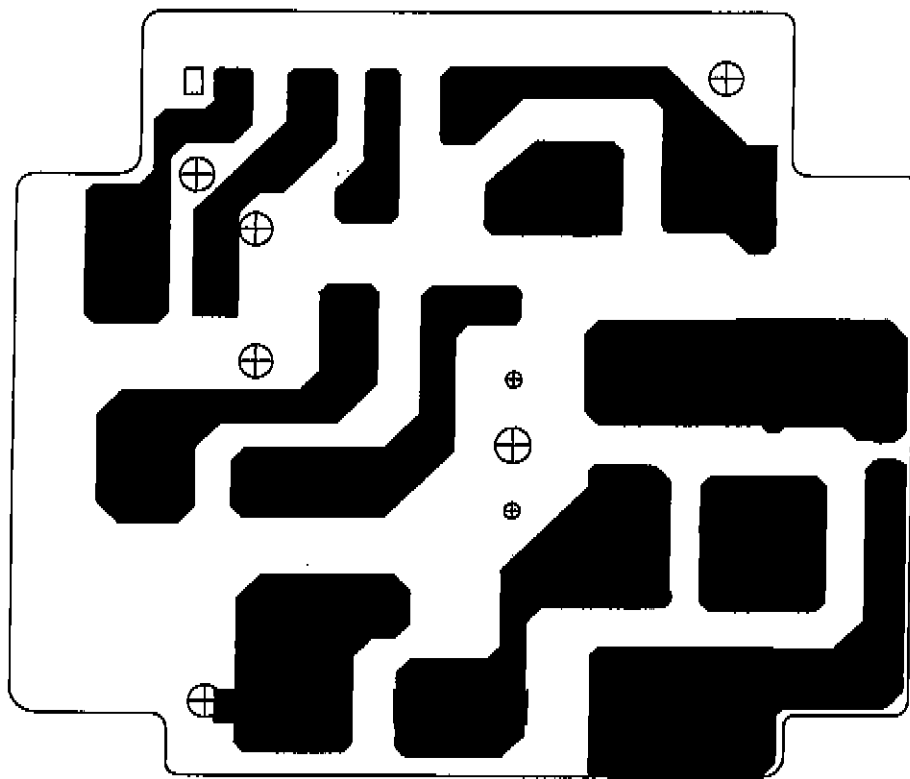

AUX PCB

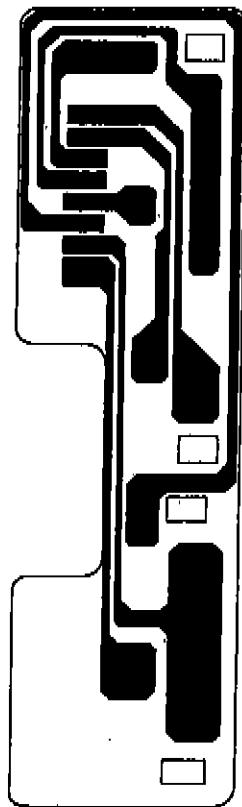

- 5 DEC 2003

KEY-A PCB

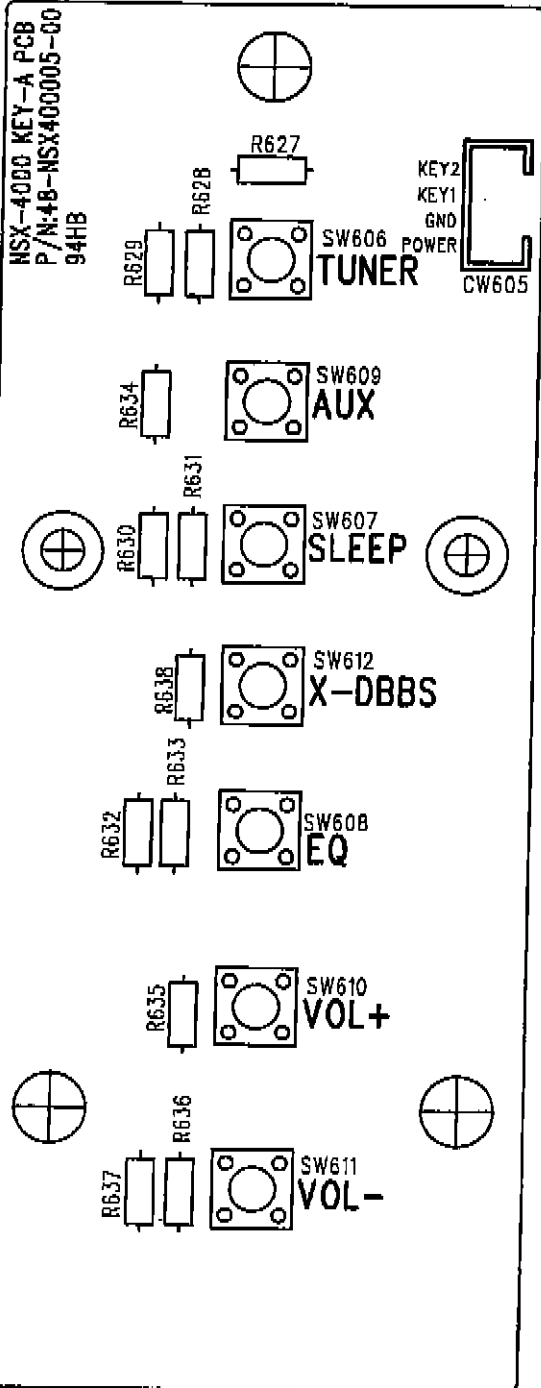

KEY-B PCB

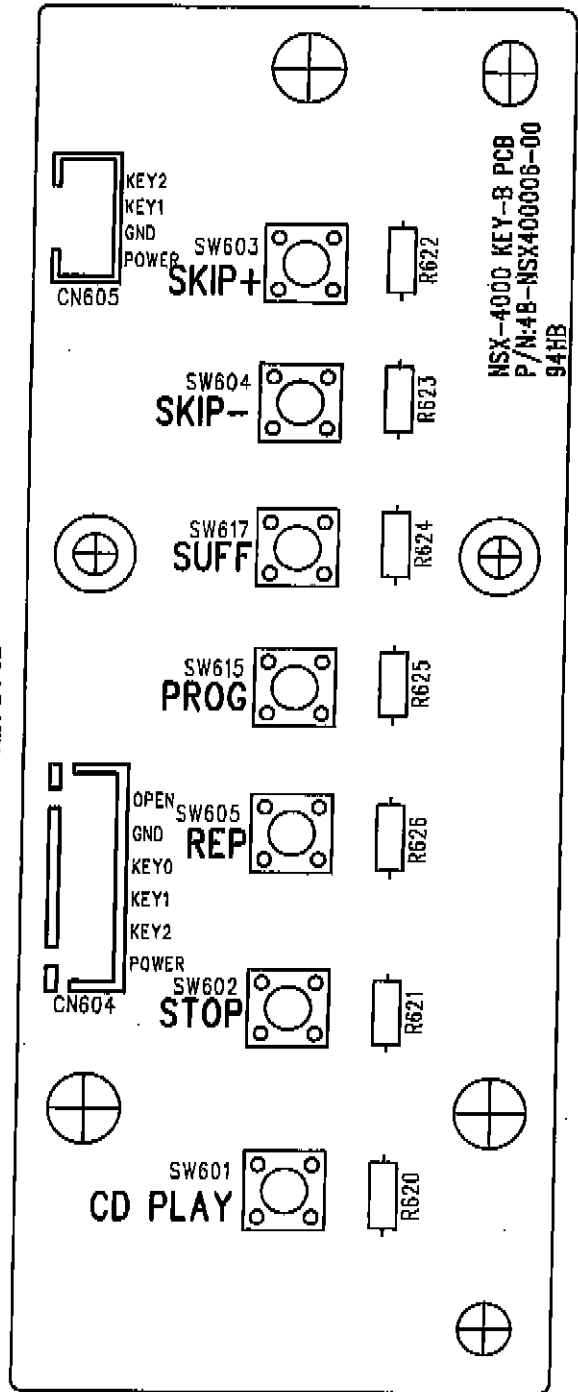

KEY-A PCB

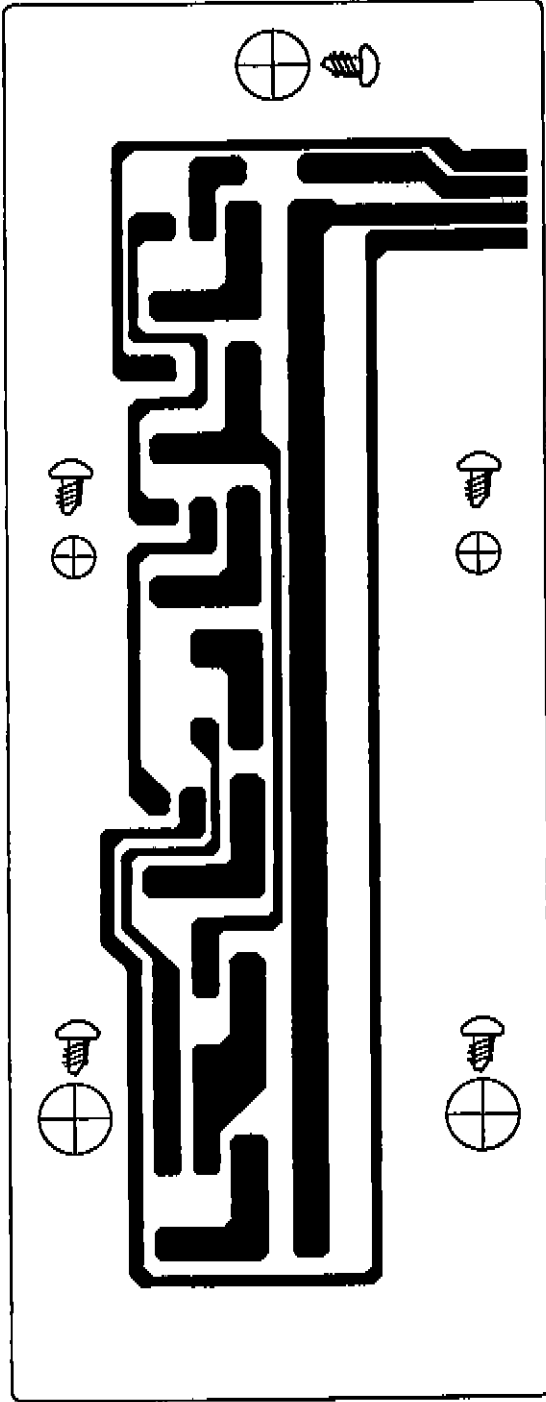

KEY-B PCB

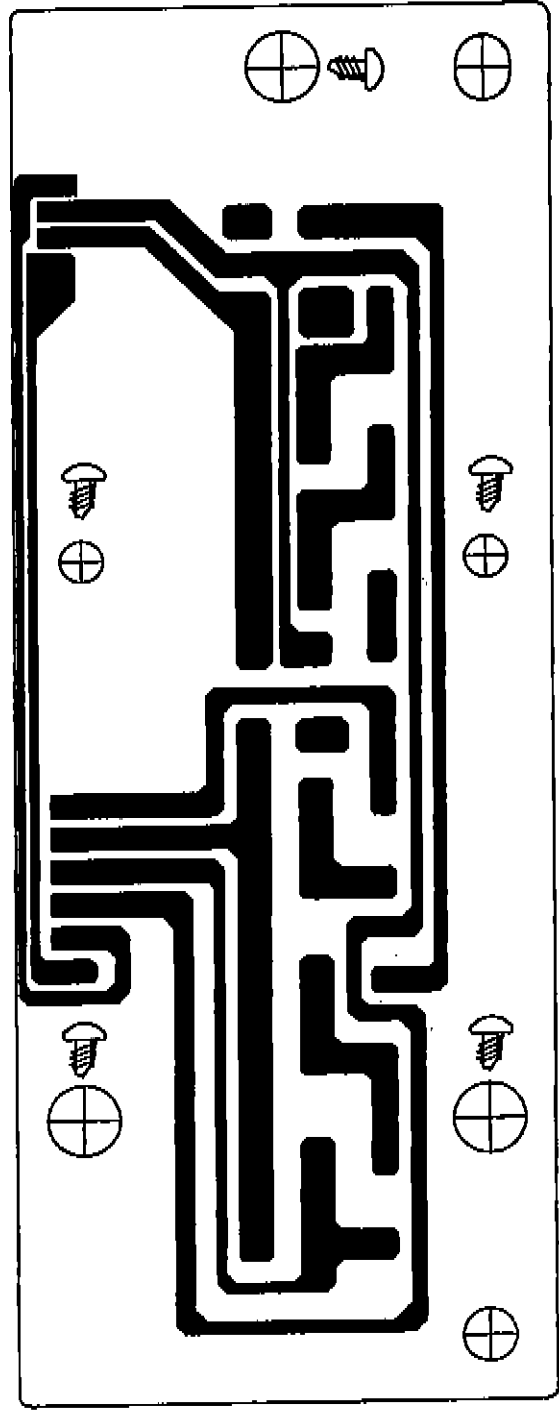

SCHEMATIC DIAGRAMS

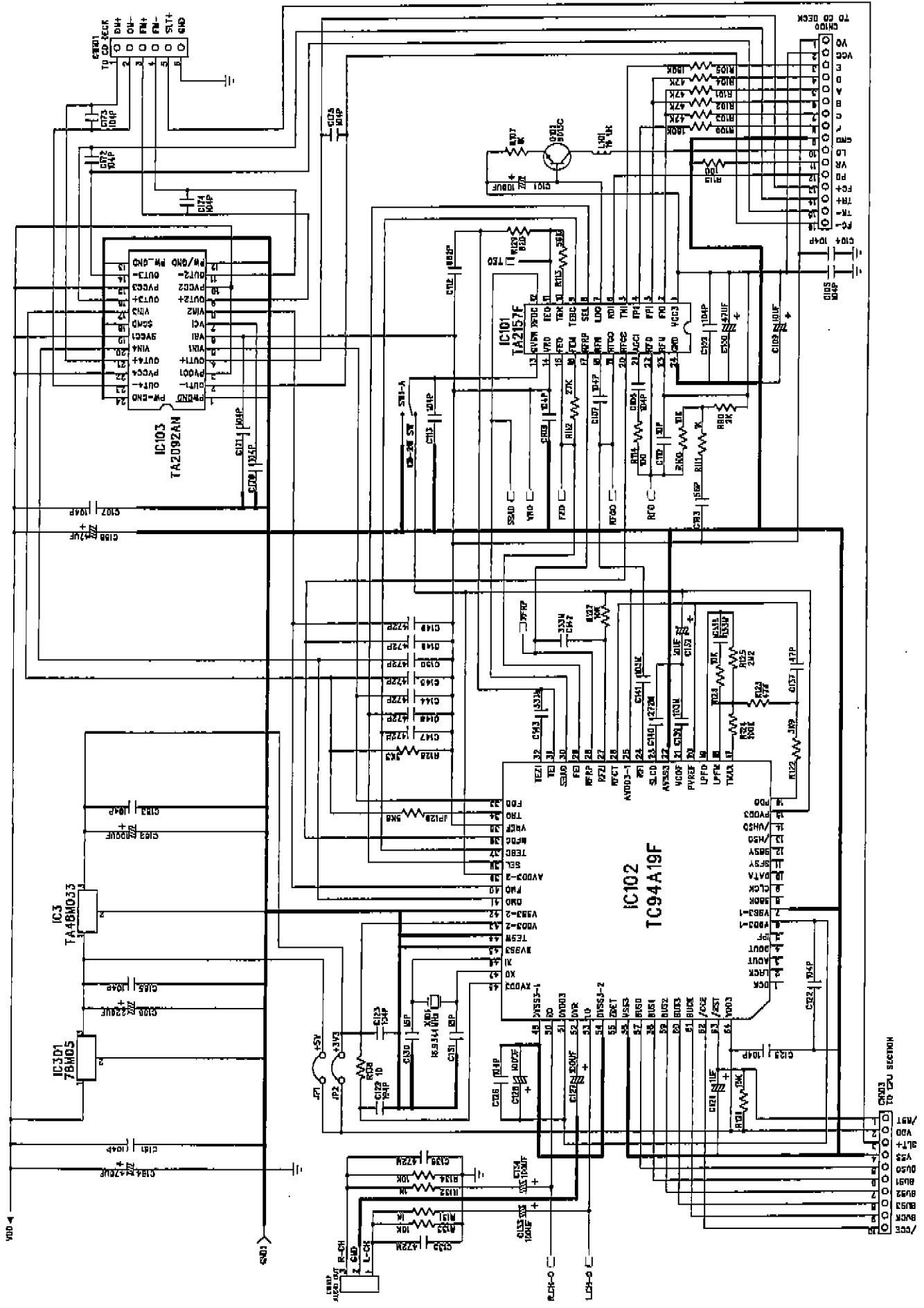

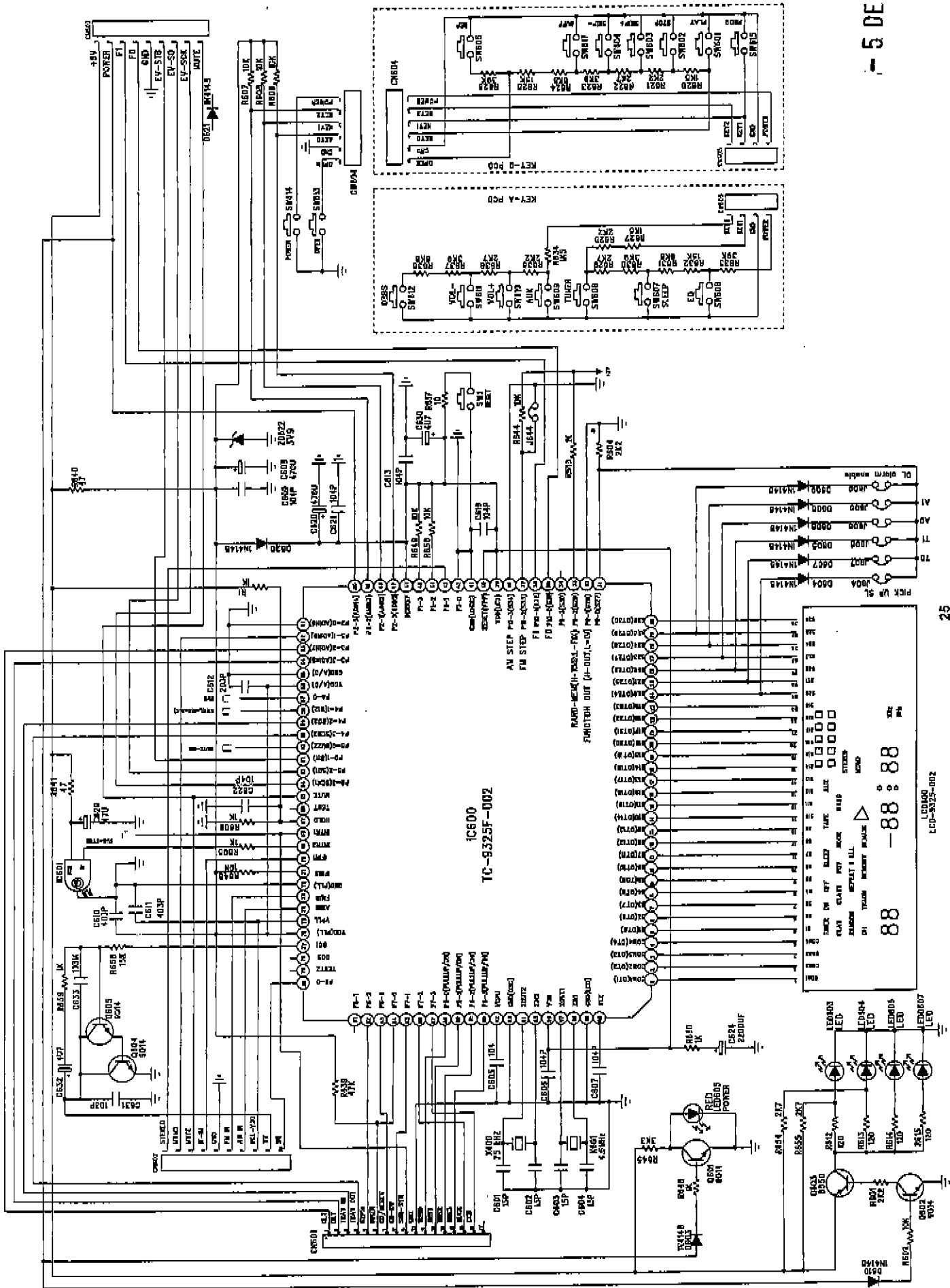

88 - 88 88

88

88

88

88

88

88

88

88

88

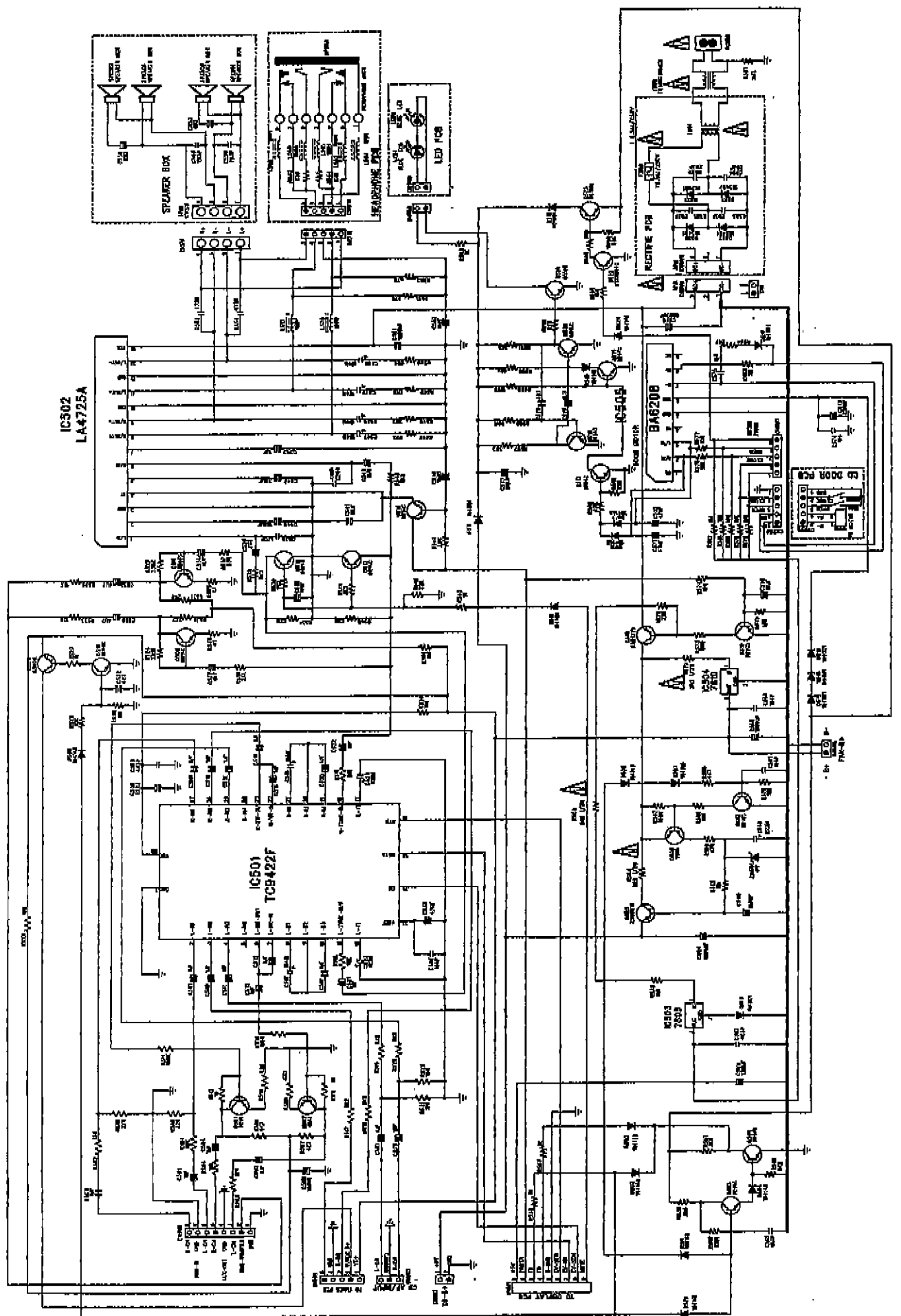

Model #: 00-X40001315-04 Description: AM/FM ST.RADIO (PLL) CD/CDRW PLAYER W/REMOTE #NSX-4000RDS Rev Date  
 Rev #: 0 Specification: 230V CE APP(SIL.+KNOB & PANEL:CHROME SIL.) -France Cost From Source :N  
 Draw #: Brand Name : "AKAI CDP-2400RDS"

Currency: USD Rate: 7.80000 \*

- 5 DEC 2003

Level Code # Usage Ven # U/M Op PMS  
 Description

Level	Code #	Usage	Ven #	U/M	Op	PMS	Description
0	01-X4000003-01	1.00000		PC		M I	AC BD ASSY "CE" (T6.3A/250V) #NSX-4000R
1	15-0001N5401-00	4.00000		PC		P Y	RECTIFIER DIODE 1N5401 3A 100V
1	25-152040300-00	4.00000		PC		P Y	CERAMIC CAP DISC TYPE +80%-20%0.02UF 50V
1	44-522212252-00	1.00000		PC		P Y	2P WIRE(#2UL1007) W/SINGLE HOUSING(2.5) L=120mm
1	46-263320100-05	1.00000		PC		P Y	GLASS FUSE 5x20mm (BUSSMANN) T6.3A/250V S50
1	46-400D05200-00	2.00000		PC		P Y	FUSE HOLDER (PAK HOP) D-052
1	48-NSX40003-11	1.00000		PC		P Y	RECTIFIER PCB 94V0 80x80mm #NSX-4000
0	01-X40000008-00	1.00000		PC		M I	JACK ASSY #NSX-4000R
1	43-452100200-37	1.00000		PC		P Y	RCA JACK 2P (WELLONG) RCA-210-020(W/R)
1	43-453100100-37	1.00000		PC		P Y	RCA JACK 3P (WELLONG) RCA-310-010(W/R)
1	45-512623258-00	1.00000		PC		P Y	8P SHIELD/WIRE(#28/26) SINGLE HOUSING(2mm) L=
1	48-NSX40008-00	1.00000		PC		P Y	RCA JACK PCB 94HB 74.5x20mm #NSX-4000
0	01-X40001001-00	1.00000		PC		M I	MAIN BD ASSY #NSX-4000RDS
1	11-2SB137502-04	1.00000		PC		P Y	TRANSISTOR (TOSHIBA) 2SB1375
1	11-2SD201202-04	1.00000		PC		P Y	TRANSISTOR (TOSHIBA) 2SD2012
1	11-8550C0002-00	1.00000		PC		P Y	PNP TRANSISTOR-2W 8550C
1	11-9013G0001-00	1.00000		PC		P Y	NPN TRANSISTOR 1W 9013G
1	11-9014C0001-00	1.00000		PC		P Y	NPN TRANSISTOR 1W 9014C
1	11-9015C0001-00	1.00000		PC		P Y	PNP TRANSISTOR 1W 9015C
1	12-11203100-03	1.00000		PC		P Y	ZENER DIODE +-5% (TELEFUKEN) 11V 1/2W
1	12-124103200-03	1.00000		PC		P Y	ZENER DIODE +-5% (TELEFUKEN) 24V 1/2W
1	12-151103100-03	2.00000		PC		P Y	ZENER DIODE +-5% (TELEFUKEN) 5.1V 1/2W

Model #: 00-X40001315-04 Description: AM/FM ST.RADIO (PLL) CD/CDRW PLAYER W/REMOTE #NSX-4000RDS Rev Date  
 Rev #: 0 Specification: 230V CE APP(SIL.+KNOB & PANEL-CHROME SIL.) Cost From Source :N  
 Draw #: Brand Name : "AKAI CDP-2400RDS"

Currency : USD Rate : 7.80000 \*

- 5 DEC 2003

Level	Code # Description	Usage	Qty	U/M	Op	PMS
1	12-191103100-03 ZENER DIODE +5% (TELEFUKEN) 9.1V 1/2W	1.00000	PC	P	Y	
1	15-0001N4001-00 RECTIFIER DIODE 1N4001 1A 50V	1.00000	PC	P	Y	
1	15-0001N4148-00 SWITCHING DIODE 1N4148 (LEAD TYPE)	8.00000	PC	P	Y	
1	16-BA4558N00-01 IC (ROHM) BA4558N	1.00000	PC	P	Y	
1	16-KA7806000-02 IC (SAMSUNG) KA7806	1.00000	PC	P	Y	
1	16-LA4725000-02 IC (SANYO) LA4725	1.00000	PC	P	Y	
1	16-TA2078P00-01 IC (TOSHIBA) TA2078P	1.00000	PC	P	Y	
1	16-TC4052BP0-04 IC (TOSHIBA) TC4052BP	1.00000	PC	P	Y	
1	16-TC9260P00-01 IC (TOSHIBA) TC9260P	1.00000	PC	P	Y	
1	21-211223000-00 RESISTOR CARBON FILM +5% 2.2 OHM 1/6W	4.00000	PC	P	Y	
1	21-212103000-00 RESISTOR CARBON FILM +5% 10 OHM 1/6W	1.00000	PC	P	Y	
1	21-212333000-00 RESISTOR CARBON FILM +5% 33 OHM 1/6W	1.00000	PC	P	Y	
1	21-212563000-00 RESISTOR CARBON FILM +5% 56 OHM 1/6W	1.00000	PC	P	Y	
1	21-213103000-00 RESISTOR CARBON FILM +5% 100 OHM 1/6W	7.00000	PC	P	Y	
1	21-213223000-00 RESISTOR CARBON FILM +5% 220 OHM 1/6W	1.00000	PC	P	Y	
1	21-213273000-00 RESISTOR CARBON FILM +5% 270 OHM 1/6W	2.00000	PC	P	Y	
1	21-213333000-00 RESISTOR CARBON FILM +5% 330 OHM 1/6W	2.00000	PC	P	Y	
1	21-213393000-00 RESISTOR CARBON FILM +5% 390 OHM 1/6W	2.00000	PC	P	Y	
1	21-213473000-00 RESISTOR CARBON FILM +5% 470 OHM 1/6W	2.00000	PC	P	Y	
1	21-213683000-00 RESISTOR CARBON FILM +5% 680 OHM 1/6W	1.00000	PC	P	Y	
1	21-214103000-00 RESISTOR CARBON FILM +5% 1K OHM 1/6W	6.00000	PC	P	Y	
1	21-214153000-00 RESISTOR CARBON FILM +5% 1.5K OHM 1/6W	2.00000	PC	P	Y	



Model #: 00-X40001315-04 Description: AM/FM ST.RADIO (PLL) CD/CDRW PLAYER W/REMOTE #NSX-4000RDS Rev Date  
 Rev #: 0 Specification: 230V CE APP(SIL.+KNOB & PANEL:CHROME SIL.) -France Cost From Source :N  
 Draw #: Brand Name : "AKAI CDP-2400RDS"

Currency : USD Rate : 7.80000 \*

~ 5 DEC 2003

Level Code # Usage Ven # U/M Op PMS  
Description

1	21-214183000-00	2.00000	PC	P	Y					
	RESISTOR CARBON FILM +5% 1.8K OHM 1/6W									
1	21-214223000-00	9.00000	PC	P	Y					
	RESISTOR CARBON FILM +5% 2.2K OHM 1/6W									
1	21-214473000-00	5.00000	PC	P	Y					
	RESISTOR CARBON FILM +5% 4.7K OHM 1/6W									
1	21-214683000-00	4.00000	PC	P	Y					
	RESISTOR CARBON FILM +5% 6.8K OHM 1/6W									
1	21-215103000-00	21.00000	PC	P	Y					
	RESISTOR CARBON FILM +5% 10K OHM 1/6W									
1	21-215153000-00	2.00000	PC	P	Y					
	RESISTOR CARBON FILM +5% 15K OHM 1/6W									
1	21-215183000-00	4.00000	PC	P	Y					
	RESISTOR CARBON FILM +5% 18K OHM 1/6W									
1	21-215223000-00	15.00000	PC	P	Y					
	RESISTOR CARBON FILM +5% 22K OHM 1/6W									
1	21-215353000-00	2.00000	PC	P	Y					
	RESISTOR CARBON FILM +5% 33K OHM 1/6W									
1	21-215473000-00	1.00000	PC	P	Y					
	RESISTOR CARBON FILM +5% 47K OHM 1/6W									
1	21-215563000-00	4.00000	PC	P	Y					
	RESISTOR CARBON FILM +5% 56K OHM 1/6W									
1	21-215683000-00	2.00000	PC	P	Y					
	RESISTOR CARBON FILM +5% 68K OHM 1/6W									
1	21-216103000-00	2.00000	PC	P	Y					
	RESISTOR CARBON FILM +5% 100K OHM 1/6W									
1	21-216153000-00	6.00000	PC	P	Y					
	RESISTOR CARBON FILM +5% 150K OHM 1/6W									
1	21-216273000-00	1.00000	PC	P	Y					
	RESISTOR CARBON FILM +5% 270K OHM 1/6W									
1	21-216333000-00	2.00000	PC	P	Y					
	RESISTOR CARBON FILM 1-5% 330K OHM 1/6W									
1	21-217103000-00	2.00000	PC	P	Y					
	RESISTOR CARBON FILM +5% 1M OHM 1/6W									
1	21-221013002-00	1.00000	PC	P	Y					
	RESISTOR FUSIBLE +5% 1 OHM 1/4W									
1	21-221223002-00	2.00000	PC	P	Y					
	RESISTOR FUSIBLE +5% 2.2 OHM 1/4W									
1	25-134710300-00	2.00000	PC	P	Y					
	CERAMIC CAP DISC TYPE +5% 470PF 50V									
1	25-151040300-00	1.00000	PC	P	Y					
	CERAMIC CAP DISC TYPE +80%-20%0.01UF 50V									
1	25-152240300-00	1.00000	PC	P	Y					
	CERAMIC CAP DISC TYPE +80%-20%0.022 UF 50V									

Model #: 00-X40001315-04 Description: AM/FM ST.RADIO (PLL) CD/CDRW PLAYER W/REMOTE #NSX-4000RDS Rev Date  
 Rev #: 0 Specification: 230V CE APP(SIL.+KNOB & PANEL:CHROME SIL.) -France Cost From Source :N  
 Draw #: Brand Name : "AKAI CDP-2400RDS"

Currency : USD Rate : 7.80000 \*

Level Code # Usage Ven # U/M Op PMS Is Sp Sc Cu Lat.Cost Scrap Cost  
Description

- 5 DEC 2003

1	25-161040300-00	3.00000	PC	P	Y	
	CERAMIC CAP DISC TYPE +80%-20%0.1UF 50V					
1	25-342210300-00	2.00000	PC	P	Y	
	MYLAR CAP +-5% 0.0022UF 50V					
1	25-344710300-00	2.00000	PC	P	Y	
	MYLAR CAP +-5% 0.0047UF 50V					
1	25-352210300-00	2.00000	PC	P	Y	
	MYLAR CAP +-5% 0.022UF 50V					
1	25-356810300-00	2.00000	PC	P	Y	
	MYLAR CAP +-5% 0.068UF 50V					
1	25-358210300-00	4.00000	PC	P	Y	
	MYLAR CAP +-5% 0.082UF 50V					
1	25-361010300-00	4.00000	PC	P	Y	
	MYLAR CAP +-5% 0.1UF 50V					
1	26-321030500-00	37.00000	PC	P	Y	
	ELECT CAP (RADIAL) 1UF 50V +-20% (NORMAL SIZE)					
1	26-322230500-00	2.00000	PC	P	Y	
	ELECT CAP (RADIAL) 2.2UF 50V +-20% (NORMAL SIZE)					
1	26-324730500-00	5.00000	PC	P	Y	
	ELECT CAP (RADIAL) 4.7UF 50V +-20% (NORMAL SIZE)					
1	26-331030200-00	2.00000	PC	P	Y	
	ELECT CAP (RADIAL) 10UF 16V +-20%					
1	26-332230200-00	1.00000	PC	P	Y	
	ELECT CAP (RADIAL) 22UF 16V +-20% (NORMAL SIZE)					
1	26-333330200-00	1.00000	PC	P	Y	
	ELECT CAP (RADIAL) 33UF 16V +-20% (NORMAL SIZE)					
1	26-334730200-00	3.00000	PC	P	Y	
	ELECT CAP (RADIAL) 47UF 16V +-20%					
1	26-341030200-00	12.00000	PC	P	Y	
	ELECT CAP (RADIAL) 100UF 16V +-20% (NORMAL SIZE)					
1	26-342230200-00	1.00000	PC	P	Y	
	ELECT CAP (RADIAL) 220UF 16V +-20% (NORMAL SIZE)					
1	26-351030200-00	1.00000	PC	P	Y	
	ELECT CAP (RADIAL) 1000UF 16V +-20% (NORMAL SIZE)					
1	26-351030300-00	1.00000	PC	P	Y	
	ELECT CAP (RADIAL) 1000UF 25V +-20% (NORMAL SIZE)					
1	26-356830300-00	1.00000	PC	P	Y	
	ELECT CAP (RADIAL) 6800UF 25V +-20% NORMAL					
1	38-401000001-00	2.00000	PC	P	Y	
	CHOKE COIL (D6x8mm) 10UH +-10% (1000mA)					
1	43-434020500-37	1.00000	PC	P	Y	
	SPEAKER TERMINAL (WELLONG) PST-402-050					
1	43-9A2001031-00	1.00000	PC	P	Y	
	WAFER 3 PINS P=2mm 180C					

PG ID: MBMR03

Date: 23/11/2002 11:38:23

Bills Of Material Component Listing With Cost

Page: 5

Model #: 00-X40001315-04 Description: AM/FM ST.RADIO (PLL) CD/CDRW PLAYER W/REMOTE #NSX-4000RDS Rev Date  
 Rev #: 0 Specification: 230V CE APP(SIL.+KNOB & PANEL;CHROME SIL.) -France Cost From Source :N  
 Draw #: Brand Name : "AKAI CDP-2400RDS"

Currency: USD Rate: 7.80000 \*

Level	Code #	Usage	Ven #	U/M	Op	PMS	Is	Sp	Sc	Cu	Lat.Cost	Scrap	Cost
Description													

- 5 DEC 2003

1	43-9A2001041-00	1.00000	PC	P Y
	WAFER 4 PINS P=2mm 180C			
1	43-9A2001051-00	2.00000	PC	P Y
	WAFER 5 PINS P=2mm 180C			
1	43-9A2001081-00	1.00000	PC	P Y
	WAFER 8 PINS P=2mm 180C			
1	43-9A2001091-00	1.00000	PC	P Y
	WAFER 9 PINS P=2mm 180C			
1	43-9A2501021-00	2.00000	PC	P Y
	WAFER 2 PINS P=2.5mm 180C			
1	43-9A2501051-00	1.00000	PC	P Y
	WAFER 5 PINS P=2.5mm 180C			
1	44-102440110-0A	40.00000	PC	P Y
	BARE WIRE dia 0.5mm L=40mm			
1	48-NSX400101-11	1.00000	PC	P Y
	MAIN PCB 94V0 203.8x177.5mm #NSX-4000RDS			
1	61-480AE3380-00	1.00000	PC	P Y
	HEAT SINK #AE338 (10+25+10)x30x1.0mm			
1	61-48X400010-01	1.00000	PC	P Y
	HEATSINK/A (AL.) #NSX-4000R			
1	61-48X400020-00	1.00000	PC	P Y
	HEATSINK/B (AL.) #NSX-4000R			
1	61-48X400030-00	4.00000	PC	P Y
	HEATSINK/C (AL.) #NSX-4000R			
1	61-48X400040-00	1.00000	PC	P Y
	HEATSINK/D (AL.) #NSX-4000R			
1	66-220300831-00	1.00000	PC	P Y
	MACHINE SCREW MS/BH 3x8			
1	66-522300831-03	1.00000	PC	P Y
	SCREW BTTB 3.0x8.0 MC			
1	66-524301031-03	2.00000	PC	P Y
	SCREW BTTB 3.0x10.0 MC			
1	67-230000200-00	1.00000	PC	P Y
	NUT DIA 3mm			
0	01-X40001002-00	1.00000	PC	M I
	TUNER BD ASSY "W/ 75" #NSX-4000RDS			
1	11-9014C0001-00	9.00000	PC	P Y
	NPN TRANSISTOR 9014C			
1	11-9015C0001-00	1.00000	PC	P Y
	PNP TRANSISTOR 9015C			
1	11-9018G0001-00	1.00000	PC	P Y
	TRANSISTOR 9018G			
1	12-151103100-03	2.00000	PC	P Y
	ZENER DIODE +-5% (TELEPUKEN) 5.1V 1/2W			

PG ID: MEMR03

Date: 23/11/2002 11:38:23

Bills Of Material Component Listing With Cost

Page: 6

Model #: 00-X40001315-04 Description: AM/FM ST.RADIO (PLL) CD/CDRW PLAYER W/REMOTE #NSX-4000RDS Rev Date  
 Rev #: 0 Specification: 230V CE APP(SIL.+KNOB & PANEL:CHROME SIL.) Cost From Source :N  
 Draw #: Brand Name : "AKAI CDP-2400RDS"

Currency : USD Rate : 7.80000 \*

Level	Code #	Usage	Ven #	U/M	Op	PMS
	Description					

- 5 DEC 2003

1	12-175103100-03	1.00000	PC	P	Y	ZENER DIODE +5% (TELEFUKEN) 7.5V 1/2W
1	15-0001N4148-00	4.00000	PC	P	Y	SWITCHING DIODE 1N4148 (LEAD TYPE)
1	15-1SV149000-06	2.00000	PC	P	Y	VARICAP DIODE (TOSHIBA) 1SV-149
1	16-BU1924F00-00	1.00000	PC	P	Y	IC BU1924F
1	16-TA2099N00-04	1.00000	PC	P	Y	IC (TOSHIBA) TA2099N
1	21-212103000-00	2.00000	PC	P	Y	RESISTOR CARBON FILM +5% 10 OHM 1/6W
1	21-212333000-00	1.00000	PC	P	Y	RESISTOR CARBON FILM +5% 33 OHM 1/6W
1	21-212563000-00	1.00000	PC	P	Y	RESISTOR CARBON FILM +5% 56 OHM 1/6W
1	21-213103000-00	3.00000	PC	P	Y	RESISTOR CARBON FILM +5% 100 OHM 1/6W
1	21-213223000-00	2.00000	PC	P	Y	RESISTOR CARBON FILM +5% 220 OHM 1/6W
1	21-213273000-00	1.00000	PC	P	Y	RESISTOR CARBON FILM +5% 270 OHM 1/6W
1	21-213333000-00	1.00000	PC	P	Y	RESISTOR CARBON FILM +5% 330 OHM 1/6W
1	21-214103000-00	3.00000	PC	P	Y	RESISTOR CARBON FILM +5% 1K OHM 1/6W
1	21-214223000-00	3.00000	PC	P	Y	RESISTOR CARBON FILM +5% 2.2K OHM 1/6W
1	21-214333000-00	3.00000	PC	P	Y	RESISTOR CARBON FILM +5% 3.3K OHM 1/6W
1	21-214393000-00	1.00000	PC	P	Y	RESISTOR CARBON FILM +5% 3.9K OHM 1/6W
1	21-214563000-00	5.00000	PC	P	Y	RESISTOR CARBON FILM +5% 5.6K OHM 1/6W
1	21-215103000-00	8.00000	PC	P	Y	RESISTOR CARBON FILM +5% 10K OHM 1/6W
1	21-215153000-00	2.00000	PC	P	Y	RESISTOR CARBON FILM +5% 15K OHM 1/6W
1	21-215223000-00	9.00000	PC	P	Y	RESISTOR CARBON FILM +5% 22K OHM 1/6W
1	21-215473000-00	1.00000	PC	P	Y	RESISTOR CARBON FILM +5% 47K OHM 1/6W
1	21-215563000-00	1.00000	PC	P	Y	RESISTOR CARBON FILM +5% 56K OHM 1/6W

PG ID: MBMR03

Date: 23/11/2002 11:38:23

Bills Of Material Component Listing With Cost

Page: 7

Model #: 00-X40001315-04 Description: AM/FM ST.RADIO (PLL) CD/CDRW PLAYER W/REMOTE #NSX-4000RDS Rev Date  
 Rev #: 0 Specification: 230V CE APP(SIL.+KNOB & PANEL;CHROME SIL.) Cost From Source :N  
 Draw #: Brand Name : "AKAI CDP-2400RDS"

Currency: USD Rate: 7.80000 \*

Level	Code #	Usage	Ver #	U/M	Op	PMS	Is	Sp	Sc	Cu	Lat.Cost	Scrap	Cost
Description													

- 5 DEC 2003

1	21-216103000-00	5.00000	PC	P Y	RESISTOR CARBON FILM +5% 100K OHM 1/6W
1	21-216273000-00	1.00000	PC	P Y	RESISTOR CARBON FILM +5% 270K OHM 1/6W
1	21-216473000-00	1.00000	PC	P Y	RESISTOR CARBON FILM +5% 470K OHM 1/6W
1	25-123010300-00	1.00000	PC	P Y	CERAMIC CAP DISC TYPE +5% 30PF 50V
1	25-123910300-00	2.00000	PC	P Y	CERAMIC CAP DISC TYPE +5% 39PF 50V
1	25-131010300-00	2.00000	PC	P Y	CERAMIC CAP DISC TYPE +5% 100PF 50V
1	25-132710300-00	1.00000	PC	P Y	CERAMIC CAP DISC TYPE +5% 270PF 50V
1	25-133910300-00	1.00000	PC	P Y	CERAMIC CAP DISC TYPE +5% 390PF 50V
1	25-135610300-00	2.00000	PC	P Y	CERAMIC CAP DISC TYPE +5% 560PF 50V
1	25-141040300-00	4.00000	PC	P Y	CERAMIC CAP DISC TYPE +80%-20%0.001UF 50V
1	25-142240300-00	2.00000	PC	P Y	CERAMIC CAP DISC TYPE +80%-20%0.0022UF 50V
1	25-151040300-00	11.00000	PC	P Y	CERAMIC CAP DISC TYPE +80%-20%0.01UF 50V
1	25-152040300-00	1.00000	PC	P Y	CERAMIC CAP DISC TYPE +80%-20%0.02UF 50V
1	25-154040300-00	1.00000	PC	P Y	CERAMIC CAP DISC TYPE +80%-20%0.04UF 50V
1	25-161040300-00	4.00000	PC	P Y	CERAMIC CAP DISC TYPE +80%-20%0.1UF 50V
1	25-342210300-00	4.00000	PC	P Y	MYLAR CAP +5% 0.0022UF 50V
1	26-311030500-00	2.00000	PC	P Y	ELECT CAP (RADIAL) 0.1UF 50V +20% (NORMAL SIZE)
1	26-321030500-00	6.00000	PC	P Y	ELECT CAP (RADIAL) 1UF 50V +20% (NORMAL SIZE)
1	26-322230500-00	1.00000	PC	P Y	ELECT CAP (RADIAL) 2.2UF 50V +20% (NORMAL SIZE)
1	26-324730500-00	2.00000	PC	P Y	ELECT CAP (RADIAL) 4.7UF 50V +20% (NORMAL SIZE)
1	26-331030500-00	1.00000	PC	P Y	ELECT CAP (RADIAL) 10UF 50V +20% (NORMAL SIZE)
1	26-334730200-00	5.00000	PC	P Y	ELECT CAP (RADIAL) 47UF 16V +20%

PG ID: MBMR03

Bills Of Material Component Listing With Cost

Date: 23/11/2002 11:38:23

Page: 8

Model #: 00-X40001315-04 Description: AM/FM ST.RADIO (PLL) CD/CDRW PLAYER W/REMOTE #NSX-4000RDS Rev Date  
Rev #: 0 Specification: 230V CE APP(SIL.+KNOB & PANEL:CHROME SIL.) Cost From Source :N  
Draw #: Brand Name : "AKAI CDP-2400RDS"

Currency: USD Rate: 7.80000 \*

Level Code # Usage Ven # U/M Op PMS  
Description

- 5 DEC 2003

1	26-341030200-00	2.00000	PC	P	Y	
	ELECT CAP (RADIAL)	100UF 16V +20% (NORMAL SIZE)				
1	26-342230200-00	2.00000	PC	P	Y	
	ELECT CAP (RADIAL)	220UF 16V +20% (NORMAL SIZE)				
1	28-120110100-02	2.00000	PC	P	Y	
	TRIMMER (SINGLE)	DIA 8MM 20PF				
1	31-143325000-18	1.00000	PC	P	Y	
	CRYSTAL (FARGO)	4.332MHZ+20PPM HC-49/U				
1	31-210705100-01	3.00000	PC	P	Y	
	CERAMIC FILTER (MURATA)	SP510.7MA5-A (RED) (3PIN)				
1	31-245003015-20	1.00000	PC	P	Y	
	CERAMIC FILTER (JIANGHA)	LTP450B				
1	31-610705080-01	1.00000	PC	P	Y	
	DISCRIMINATOR FILTER (MURATA)	CDA10.7MG80-A-TF21 (2 PIN)				
1	37-094500010-07	1.00000	PC	P	Y	
	TUNER (MITSUBISHI)	FE450-G01 (R16-4765)				
1	38-301001000-30	2.00000	PC	P	Y	
	AXIAL INDUCTORS (EC-36 TYPE)	10UH +10% (dc max:500 mA)				
1	40-0000660R2-18	1.00000	PC	P	Y	
	LF.T.10mm (KONI)	660R (RED)				
1	40-0000A0494-18	1.00000	PC	P	Y	
	LF.T. 10mm (KONI)	A049 (YELLOW)				
1	40-3AGGS1340-11	2.00000	PC	P		
	MPX FILTER (COILS)	KD12-864122				
1	40-868000100-11	1.00000	PC	P	Y	
	AM ANT COIL(COILS OA10-868461)#868					
1	43-422043A00-03	1.00000	PC	P	Y	
	ANT TERMINAL (UNITRONIC)	#AJ-2043A (W/75 OHM)				
1	43-9A2001111-00	1.00000	PC	P	Y	
	WAFER 11 PINS P=2mm 180C					
1	43-9A2501021-00	1.00000	PC	P	Y	
	WAFER 2 PINS P=2.5mm 180C					
1	44-102440110-0A	20.00000	PC	P	Y	
	BARE WIRE	dia 0.5mm L=40mm				
1	44-512808055-06	1.00000	PC	P	Y	
	5P WIRE(#28UL1571) W/SINGLE HOUSING(2mm) L=80mm					
1	48-NSX400102-01	1.00000	PC	P	Y	
	TUNER PCB 94HB 170x72mm #NSX-4000RDS					
0	01-X40001004-00	1.00000	PC	M	T	
	DISPLAY BD ASS'Y	#NSX-4000RDS				
1	11-855000002-00	1.00000	PC	P	Y	
	PNP TRANSISTOR 2W	8550C				
1	11-901400001-00	5.00000	PC	P	Y	
	NPN TRANSISTOR	9014C				

PG ID: MBR03

Date: 23/11/2002 11:36:23

Bills Of Material Component Listing With Cost

Page: 9

Model #: 00-X40001315-04 Description: AM/FM ST.RADIO (PLL) CD/CDRW PLAYER W/REMOTE #NSX-4000RDS Rev Date  
 Rev #: 0 Specification: 230V CE APP(SIL.+KNOB & PANEL.CHROME SIL.) - SRC Cost From Source: N  
 Draw #: Brand Name: "AKAI CDP-2400RDS"

Currency: USD Rate: 7.80000 \*

Level	Code #	Usage	Ven #	U/M	Op	PMS	Is	Sp	Sc	Cu	Lat.Cost	Scrap	Cost
Description													

- 5 DEC 2003

1	11-9015C0001-00	1.00000	PC	P Y
	PNP TRANSISTOR	9015C		
1	13-1MBB31TA0-31	2.00000	PC	P
	LED (MICRO) (SUPER.BLUE)	#MBB31TA DIA3mm L=27.9mm		
1	13-1MSC32DC0-31	1.00000	PC	P
	LED (MICRO) (RED)	MSC32D-C DIA:2.94mm		
1	13-1SB14E200-00	2.00000	PC	P Y
	LED (SONG) (S.BLUE)	ZGA2-SB14E2-560.(DIA5mm)		
1	13-5X4000001-35	1.00000	PC	P Y
	LCD DISPLAY (SMART TECH)	SDT-DA014-TP-1 W/RDS		
1	15-0001N4148-00	56.00000	PC	P Y
	SWITCHING DIODE	1N4148 (LEAD TYPE)		
1	16-TC9324F00-00	1.00000	PC	P Y
	IC (TOSHIBA)	TC9324F-002		
1	17-57138V400-02	1.00000	PC	P Y
	OPTIC SENSER (ROHM)	RPM7138-V4		
1	21-21223000-00	1.00000	PC	P Y
	RESISTOR CARBON FILM +5%	22 OHM 1/6W		
1	21-212103000-00	1.00000	PC	P Y
	RESISTOR CARBON FILM +5%	10 OHM 1/6W		
1	21-212473000-00	1.00000	PC	P Y
	RESISTOR CARBON FILM +5%	47 OHM 1/6W		
1	21-213183000-00	4.00000	PC	P Y
	RESISTOR CARBON FILM +5%	180 OHM 1/6W		
1	21-213823000-00	1.00000	PC	P Y
	RESISTOR CARBON FILM +5%	820 OHM 1/6W		
1	21-214103000-00	5.00000	PC	P Y
	RESISTOR CARBON FILM +5%	1K OHM 1/6W		
1	21-214223000-00	1.00000	PC	P Y
	RESISTOR CARBON FILM +5%	2.2K OHM 1/6W		
1	21-214273000-00	2.00000	PC	P Y
	RESISTOR CARBON FILM +5%	2.7K OHM 1/6W		
1	21-214333000-00	2.00000	PC	P Y
	RESISTOR CARBON FILM +5%	3.3K OHM 1/6W		
1	21-214473000-00	1.00000	PC	P Y
	RESISTOR CARBON FILM +5%	4.7K OHM 1/6W		
1	21-214683000-00	1.00000	PC	P Y
	RESISTOR CARBON FILM +5%	6.8K OHM 1/6W		
1	21-215103000-00	5.00000	PC	P Y
	RESISTOR CARBON FILM +5%	10K OHM 1/6W		
1	21-215153000-00	1.00000	PC	P Y
	RESISTOR CARBON FILM +5%	15K OHM 1/6W		
1	21-215223000-00	1.00000	PC	P Y
	RESISTOR CARBON FILM +5%	22K OHM 1/6W		

PG ID: MBMR03

Date: 23/11/2002 11:38:23

Bills Of Material Component Listing With Cost

Page: 10

Model #: 00-X40001315-04 Description: AM/FM ST.RADIO (PLL) CD/CDRW PLAYER W/REMOTE #NSX-4000RDS Rev Date  
 Rev #: 0 Specification: 230V CE APP(SIL.+KNOB & PANEL:CHROME SIL.) Cost From Source :N  
 Draw #: Brand Name : "AKAI CDP-2400RDS"

Currency : USD Rate : 7.80000 \*

Level	Code #	Usage	Ven #	U/M	Op	PMS
	Description					





- 5 DEC 2003

1	44-51282255-E4	1.0000	PC	P Y N N USD	0.0
	5P WIRE(UL1571#28) W/SINGLE HOUSING(2mm) L=220mm				
1	44-512825254-04	1.0000	PC	P Y N N USD	0.0
	4P WIRE(#28UL1571) W/SINGLE HOUSING(2mm) L=250mm				
1	44-512830259-E4	1.0000	PC	P Y N N USD	0.0
	9P WIRE(#28UL1571) W/SINGLE HOUSING(2mm) L=300mm				
1	45-032632226-02	1.0000	PC	P Y N N USD	0.0
	2P COAXIAL CABLE #26 W/SINGLE HOUSING(2.5) L=320mm				
1	48-NSX400104-10	1.0000	PC	P Y N N USD	0
	DISPLAY PCB 94X0.257x60mm #NSX-4000RDS				
1	57-26X400000-00	1.0000	PC	P Y N N USD	0.0
	FILTER SHEET 108 8x31.2mm #NSX-4000				
1	57-26X400001-00	1.0000	PC	P Y N N USD	0.0
	WHITE PAPER 98x28x0.1mm #NSX-4000				
1	58-63X400003-00	1.0000	PC	P Y N N USD	0.0
	FIBRE PLATE (22x29X0.5mm) #NSX-4000				
0	01-X40001006-00	1.0000	PC	M N N N USD	0
	KEY/1 BD ASS'Y #NSX-4000RDS				
1	21-214153000-00	2.0000	PC	P Y N N USD	0.0
	RESISTOR CARBON FILM +-5% 1.5K OHM 1/6W				
1	21-214223000-00	2.0000	PC	P Y N N USD	0.0
	RESISTOR CARBON FILM +-5% 2.2K OHM 1/6W				
1	21-214273000-00	2.0000	PC	P Y N N USD	0.0
	RESISTOR CARBON FILM +-5% 2.7K OHM 1/6W				
1	21-214393000-00	2.0000	PC	P Y N N USD	0.0
	RESISTOR CARBON FILM +-5% 3.9K OHM 1/6W				
1	41-151100000-0V	7.0000	PC	P Y N N USD	0
	TACT SWITCH (COMAX) RS-014RB1 (H=5mm F=160+-30g)				
1	43-9B2001091-00	1.0000	PC	P Y N N USD	0.0
	WAFER 9 PINS P=2mm 90C				
1	44-412626254-00	1.0000	PC	P Y N N USD	0.0
	4P FLAT CABLE WIRE (UL2651#26) L=4+252+4mm				
1	48-NSX400105-10	1.0000	PC	P Y N N USD	0
	KEY/1 PCB 94HB 100x38.2mm #NSX-4000RDS				
0	01-X40001006-00	1.0000	PC	M N N N USD	0
	KEY/2 BD ASS'Y #NSX-4000RDS				
1	21-214153000-00	1.0000	PC	P Y N N USD	0.0
	RESISTOR CARBON FILM +-5% 1.5K OHM 1/6W				
1	21-214223000-00	1.0000	PC	P Y N N USD	0.0
	RESISTOR CARBON FILM +-5% 2.2K OHM 1/6W				
1	21-214273000-00	1.0000	PC	P Y N N USD	0.0
	RESISTOR CARBON FILM +-5% 2.7K OHM 1/6W				
1	21-214393000-00	1.0000	PC	P Y N N USD	0.0
	RESISTOR CARBON FILM +-5% 3.9K OHM 1/6W				

PG ID: MBMR03

Date: 23/11/2002 11:38:23

Bills Of Material Component Listing With Cost

Page: 12

Model #: 00-X40001315-04 Description: AM/FM ST.RADIO (PLL) CD/CDRW PLAYER W/REMOTE #NSX-4000RDS Rev Date  
 Rev #: 0 Specification: 230V CB APP(SIL,+KNOB & PANEL:CHROME SIL.) Cost From Source :N  
 Draw #: Brand Name : "AKAI CDP-2400RDS"

Currency : USD Rate : 7.80000 \*

Level	Code #	Usage	Ver #	U/M	Op	PMS	Is	Sp	Sc	Cu	I	
		Description										

- 5 DEC 2003

1	21-214683000-00	1.00000	PC	P	Y	N	N	USD	0.0
	RESISTOR CARBON FILM +5% 6.8K OHM 1/6W								
1	21-215153000-00	1.00000	PC	P	Y	N	N	USD	0.0
	RESISTOR CARBON FILM +5% 15K OHM 1/6W								
1	41-151100000-0V	7.00000	PC	P	Y	N	N	USD	0.
	TACT SWITCH (COMAX) RS-014RB1 (H=5mm F=160+30gf)								
1	48-NSX400106-10	1.00000	PC	P	Y	N	N	USD	0
	KEY/2 PCB 94HB 100x38.2mm #NSX-4000RDS								
0	01-X40001009-00	1.00000	PC	M	N	N	N	USD	0
	HP JACK BD ASSY #NSX-4000RDS								
1	21-213223000-00	2.00000	PC	P	Y	N	N	USD	0.0
	RESISTOR CARBON FILM +5% 220 OHM 1/6W								
1	38-381661000-30	3.00000	PC	P	Y	N	N	USD	0.0
	AXIAL INDUCTORS (EC-36 TYPE) 10UH +10% (I <sub>dc</sub> max:500 mA)								
1	43-433507000-37	1.00000	PC	P	Y	N	N	USD	0.1
	HEADPHONE JACK (WELLLONG) JY3535-070-01								
1	44-522229255-00	1.00000	PC	P	Y	N	N	USD	0.0
	5P WIRE(#22UL1007) W/SINGLE HOUSING(2.5)L=390mm								
1	48-NSX400109-00	1.00000	PC	P	Y	N	N	USD	0
	HP JACK PCB 94HB 30x31.5mm #NSX-4000RDS								
0	01-X40001016-00	1.00000	PC	M	N	N	N	USD	0
	LED LAMP BD ASSY #NSX-4000RDS								
1	13-13B14E200-00	2.00000	PC	P	Y	N	N	USD	0.
	LED (SONGD (S.BLUE) ZGA2-SB14E2-560 (DIA5mm)								
1	44-512816252-04	1.00000	PC	P	Y	N	N	USD	0.0
	2P WIRE(#28UL1571) W/SINGLE HOUSING(2mm) L=160mm								
1	48-NSX400116-10	1.00000	PC	P	Y	N	N	USD	0
	LED LAMP PCB 94HB 30.7x12.2mm #NSX-4000RDS								
0	01-X40001023-00	1.00000	PC	M	N	N	N	USD	1
	CD DOOR SW.BD ASSY #NSX-4000RDS								
1	11-9014C0001-00	6.00000	PC	P	Y	N	N	USD	0.0
	NPN TRANSISTOR 9014C								
1	11-9015C0001-00	1.00000	PC	P	Y	N	N	USD	0.0
	PNP TRANSISTOR 9015C								
1	15-0001N4001-00	5.00000	PC	P	Y	N	N	USD	0.
	RECTIFIER DIODE 1N4001 1A 50V								
1	15-0001N4148-00	6.00000	PC	P	Y	N	N	USD	0.
	SWITCHING DIODE 1N4148 (LEAD TYPE)								
1	16-BA6208000-02	1.00000	PC	P	Y	N	N	USD	0.
	IC DC MOTOR DRIVER (ROHM) BA6208								
1	21-214103000-00	2.00000	PC	P	Y	N	N	USD	0.0
	RESISTOR CARBON FILM +5% 1K OHM 1/6W								
1	21-214153000-00	1.00000	PC	P	Y	N	N	USD	0.0
	RESISTOR CARBON FILM +5% 1.5K OHM 1/6W								

PG ID: MBR03

Bills Of Material Component Listing With Cost

Date: 23/11/2002 11:38:23  
Page: 13

Model #: 00-X40001315-04 Description: AM/FM ST.RADIO (PLL) CD/CDRW PLAYER W/REMOTE #NSX-4000RDS Rev Date  
 Rev #: 0 Specification: 230V CE APP(SIL.+KNOB & PANEL:CHROME SIL.) GERMAN Cost From Source :N  
 Draw #: Brand Name : "AKAI CDP-2400RDS"

Currency: USD Rate: 7.80000 \*

Level	Code #	Usage	Ver #	U/M	Op	PMS	Is	Sp	Sc	Cu	1
Description											

- 5 DEC 2003

1	21-21433000-00	2.00000	PC	P Y N N USD	0.0
	RESISTOR CARBON FILM +5% 3.3K OHM 1/6W				
1	21-215103000-00	8.00000	PC	P Y N N USD	0.0
	RESISTOR CARBON FILM +5% 10K OHM 1/6W				
1	21-215223000-00	4.00000	PC	P Y N N USD	0.0
	RESISTOR CARBON FILM +5% 22K OHM 1/6W				
1	21-215473000-00	1.00000	PC	P Y N N USD	0.0
	RESISTOR CARBON FILM +5% 47K OHM 1/6W				
1	21-215683000-00	1.00000	PC	P Y N N USD	0.0
	RESISTOR CARBON FILM +5% 68K OHM 1/6W				
1	21-216103000-00	1.00000	PC	P Y N N USD	0.0
	RESISTOR CARBON FILM +5% 100K OHM 1/6W				
1	21-221683000-00	1.00000	PC	P Y N N USD	0.0
	RESISTOR CARBON FILM +5% 6.8 OHM 1/4W				
1	21-232273000-00	1.00000	PC	P Y N N USD	0.0
	RESISTOR CARBON FILM +5% 27 OHM 1/2W				
1	25-161040300-00	2.00000	PC	P Y N N USD	0.0
	CERAMIC CAP DISC TYPE +80%-20% 0.1UF 50V				
1	26-322230500-00	2.00000	PC	P Y N N USD	0.0
	ELECT CAP (RADIAL) 2.2UF 50V +20% (NORMAL SIZE)				
1	26-331030200-00	2.00000	PC	P Y N N USD	0.0
	ELECT CAP (RADIAL) 10UF 16V +20%				
1	26-334730101-00	1.00000	PC	P Y N N USD	0.0
	ELECT CAP (RADIAL) 47UF 10V +20% (4x7mm)				
1	26-342230200-00	3.00000	PC	P Y N N USD	0.0
	ELECT CAP (RADIAL) 220UF 16V +20% (NORMAL SIZE)				
1	41-071000001-00	2.00000	PC	P Y N N USD	0.0
	MICRO SWITCH (WELLONG) 1120B				
1	43-9A2001021-00	1.00000	PC	P Y N N USD	0.0
	WAFER 2 PINS P=2mm 180C				
1	43-9A2001041-00	1.00000	PC	P Y N N USD	0.0
	WAFER 4 PINS P=2mm 180C				
1	44-512616254-00	1.00000	PC	P Y N N USD	0.0
	4P WIRE (UL1571 #26) W/SINGLE HOUSING (2mm) L=160mm				
1	48-NSX400123-10	1.00000	PC	P Y N N USD	0.0
	CD DOOR SW PCB 94HB 107x40mm #NSX-400ORDS				
0	01-X40001030-00	1.00000	PC	M N N N USD	3.0
	CD BD ASSY #NSX-400ORDS				
1	11-2SK182502-04	4.00000	PC	P Y N N USD	0.0
	FET TRANSISTOR (TOSHIBA) 2SK1825				
1	11-9014C0001-00	4.00000	PC	P Y N N USD	0.0
	NPN TRANSISTOR 9014C				
1	11-9015C0001-00	2.00000	PC	P Y N N USD	0.0
	PNP TRANSISTOR 9015C				

PG ID: MBMR03

Date: 23/11/2002 11:38:23

Bills Of Material Component Listing With Cost

Page: 14

Model #: 00-X40001315-04 Description: AM/FM ST.RADIO (PLL) CD/CDRW PLAYER W/REMOTE #NSX-400ORDS Rev Date  
 Rev #: 0 Specification: 230V CE APP(SIL.+KNOB & PANEL:CHROME SIL.) Cost From Source :N  
 Draw #: Brand Name : "AKAI CDP-2400RDS"

Currency: USD Rate: 7.80000 \*

Level	Code #	Usage	Ven #	U/M	Op	PMS	Is	Sp	Sc	Cu	I
Description											



- 5 DEC 2003

1	21-215183000-00	1.00000	PC	P	Y	N	N	USD	0.0
	RESISTOR CARBON FILM +5% 18K OHM 1/6W								
1	21-215223000-00	16.00000	PC	P	Y	N	N	USD	0.
	RESISTOR CARBON FILM +5% 22K OHM 1/6W								
1	21-215243000-00	1.00000	PC	P	Y	N	N	USD	0.0
	RESISTOR CARBON FILM +5% 24K OHM 1/6W								
1	21-215333000-00	4.00000	PC	P	Y	N	N	USD	0.0
	RESISTOR CARBON FILM +5% 33K OHM 1/6W								
1	21-215473000-00	15.00000	PC	P	Y	N	N	USD	0.
	RESISTOR CARBON FILM +5% 47K OHM 1/6W								
1	21-215563000-00	1.00000	PC	P	Y	N	N	USD	0.0
	RESISTOR CARBON FILM +5% 56K OHM 1/6W								
1	21-216103000-00	5.00000	PC	P	Y	N	N	USD	0.0
	RESISTOR CARBON FILM +5% 100K OHM 1/6W								
1	21-216153000-00	1.00000	PC	P	Y	N	N	USD	0.0
	RESISTOR CARBON FILM +5% 150K OHM 1/6W								
1	21-216183000-00	2.00000	PC	P	Y	N	N	USD	0.0
	RESISTOR CARBON FILM +5% 180K OHM 1/6W								
1	21-216223000-00	2.00000	PC	P	Y	N	N	USD	0.0
	RESISTOR CARBON FILM +5% 220K OHM 1/6W								
1	21-216473000-00	1.00000	PC	P	Y	N	N	USD	0.0
	RESISTOR CARBON FILM +5% 470K OHM 1/6W								
1	21-216683000-00	1.00000	PC	P	Y	N	N	USD	0.0
	RESISTOR CARBON FILM +5% 680K OHM 1/6W								
1	21-217153000-00	1.00000	PC	P	Y	N	N	USD	0.0
	RESISTOR CARBON FILM +5% 1.5M OHM 1/6W								
1	21-217223000-00	3.00000	PC	P	Y	N	N	USD	0.0
	RESISTOR CARBON FILM +5% 2.2M OHM 1/6W								
1	23-112343005-06	1.00000	PC	P	Y	N	N	USD	0.0
	SEMI-FIXED (6mm) (WELTRONIC) 3KN #637A								
1	23-112361005-06	3.00000	PC	P	Y	N	N	USD	0.0
	SEMI-FIXED (6mm) (WELTRONIC) 100KN #637A								
1	25-115060300-00	1.00000	PC	P	Y	N	N	USD	0.0
	CERAMIC CAP DISC TYPE +0.25PF50V								
1	25-102710300-00	3.00000	PC	P	Y	N	N	USD	0.0
	CERAMIC CAP DISC TYPE +5% 27PF 50V								
1	25-131610300-00	5.00000	PC	P	Y	N	N	USD	0.0
	CERAMIC CAP DISC TYPE +5% 100PF 50V								
1	25-134710300-00	1.00000	PC	P	Y	N	N	USD	0.0
	CERAMIC CAP DISC TYPE +5% 470PF 50V								
1	25-136810300-00	1.00000	PC	P	Y	N	N	USD	0.0
	CERAMIC CAP DISC TYPE +5% 680PF 50V								
1	25-144740300-00	1.00000	PC	P	Y	N	N	USD	0.0
	CERAMIC CAP DISC TYPE +80%-20%0.0047UF 50V								

PG ID: MBMR03

Date: 23/11/2002 11:38:23

Bills Of Material Component Listing With Cost

Page: 16

Model #: 00-X40001315-04 Description: AM/FM ST.RADIO (PLL) CD/CDRW PLAYER W/REMOTE #NSX-4000RDS Rev Date  
 Rev #: 0 Specification: 230V CE APP(SIL.+KNOB & PANEL;CHROME SIL.) Cost From Source :N  
 Draw #: Brand Name : "AKAI CDP-2400RDS"

Currency : USD Rate : 7.80000 \*

Level	Code #	Usage	Ven #	U/M	Op	PMS	Is	Sp	Sc	Co	I
Description											

- 5 DEC 2003

1	25-154740300-00	2.00000	PC	P Y N N USD	0.0
	CERAMIC CAP DISC TYPE +80%-20%0.047UF 50V				
1	25-161040300-00	16.00000	PC	P Y N N USD	0.
	CERAMIC CAP DISC TYPE +80%-20%0.1UF 50V				
1	25-222510300-00	2.00000	PC	P Y N N USD	0.0
	CERAMIC CAP DISC TYPE +-5% 25PF 50V (NPO)				
1	25-343310300-00	2.00000	PC	P Y N N USD	0.0
	MYLAR CAP +5% 0.0033UF 50V				
1	25-345620300-00	1.00000	PC	P Y N N USD	0.0
	MYLAR CAP +10% 0.0056UF 50V				
1	25-346810300-00	1.00000	PC	P Y N N USD	0.0
	MYLAR CAP +5% 0.0068UF 50V				
1	25-351010300-00	1.00000	PC	P Y N N USD	0.0
	MYLAR CAP +5% 0.01UF 50V				
1	25-351510300-00	1.00000	PC	P Y N N USD	0.0
	MYLAR CAP +5% 0.015UF 50V				
1	25-353310300-00	2.00000	PC	P Y N N USD	0.0
	MYLAR CAP +5% 0.033UF 50V				
1	25-362210300-00	1.00000	PC	P Y N N USD	0.0
	MYLAR CAP +5% 0.022UF 50V				
1	26-321030500-00	1.00000	PC	P Y N N USD	0.0
	ELECT CAP (RADIAL) 1UF 50V +20% (NORMAL SIZE)				
1	26-324730500-00	3.00000	PC	P Y N N USD	0.0
	ELECT CAP (RADIAL) 4.7UF 50V +20% (NORMAL SIZE)				
1	26-331030200-00	4.00000	PC	P Y N N USD	0.0
	ELECT CAP (RADIAL) 10UF 16V +20%				
1	26-332230200-00	1.00000	PC	P Y N N USD	0.0
	ELECT CAP (RADIAL) 22UF 16V +20% (NORMAL SIZE)				
1	26-334730200-00	4.00000	PC	P Y N N USD	0.0
	ELECT CAP (RADIAL) 47UF 16V +20%				
1	26-341030200-00	9.00000	PC	P Y N N USD	0.0
	ELECT CAP (RADIAL) 100UF 16V +20% (NORMAL SIZE)				
1	26-342230200-00	1.00000	PC	P Y N N USD	0.0
	ELECT CAP (RADIAL) 220UF 16V +20% (NORMAL SIZE)				
1	26-351030200-00	1.00000	PC	P Y N N USD	0.0
	ELECT CAP (RADIAL) 1000UF 16V +20% (NORMAL SIZE)				
1	31-116935000-07	1.00000	PC	P Y N N USD	0.0
	CRYSTAL (FARGO) 16.9344MHz HC-49/U				
1	38-301001000-30	2.00000	PC	P Y N N USD	0.0
	AXIAL INDUCTORS (EC-36 TYPE) 10UH +10% (Idc max:500mA)				
1	38-310002000-30	1.00000	PC	P Y N N USD	0.0
	AXIAL INDUCTORS (EC-36 TYPE) 100UH +10% (Idc max:275 mA)				
1	43-9A1002162-02	1.00000	PC	P Y N N USD	0.
	WAPER (P.R.C) (LEADER WISE) 16PP=1.0mm 180C				

PG ID: MBR03

Bills Of Material Component Listing With Cost

Date: 23/11/2002 11:38:23

Page: 17

Model #: 00-X40001315-04 Description: AM/FM ST.RADIO (PLL) CD/CDRW PLAYER W/REMOTE #NSX-4000RDS Rev Date  
 Rev #: 0 Specification: 230V CE APP(SIL+KNOB & PANEL:CHROME SIL.) Cost From Source :N  
 Draw #: Brand Name : "AKAI CDP-2400RDS"

Currency : USD Rate : 7.80000 \*

Level Code # Usage Ven # UM Op PMS Is Sp Sc Oz I  
 Description

- 5 DEC 2003

1	43-9A2001101-00	2.00000	PC	P Y N N USD	0.
	WAFFER 10 PINS P=2mm 180C				
1	44-102440110-0A	45.00000	PC	P Y N N USD	0
	BARE WIRE dia 0.5mm L=40mm				
1	44-512816260-04	1.00000	PC	P Y N N USD	0.0
	10P WIRE(#28UL1571) W/SINGLE HOUSING(2mm) L=160mm				
1	44-512818256-04	1.00000	PC	P Y N N USD	0.0
	6P WIRE(#28UL1571) W/SINGLE HOUSING(2MM) L=180mm				
1	44-522212252-00	1.00000	PC	P Y N N USD	0.0
	2P WIRE(#22UL1007) W/SINGLE HOUSING(2.5) L=120mm				
1	45-061825228-00	1.00000	PC	P Y N N USD	0.0
	3P DOUBLE SHIELD WIRE(28) SINGLE HOUSING(2mm) L=180mm				
1	48-NSX400130-01	1.00000	PC	P Y N N USD	0.
	CD PCB 94HB 156.2x158mm #NSX-4000RDS				
1	61-8703310A0-00	3.00000	PC	P Y N N USD	0.
	SOLDERING PIN #3310A				
0	02-X40001315-00	1.00000	PC	M N N N USD	1.
	CASING ASSY #NSX-4000RDS				
1	18-266521000-18	1.00000	PC	P Y N N USD	4.5
	TRANSFORMER EI66 (W/WH HING) TO4188B 230V				
1	32-425151200-00	1.00000	PC	P Y N N USD	0.0
	FERRITE CORE 25x15x12mm (F2515120D)				
1	44-302607000-41	2.00000	PC	P Y N N USD	0.0
	STRAND JUMPER WIRE UL1007 AWG26 4+62+4mm (BLACK)				
1	44-302610200-41	1.00000	PC	P Y N N USD	0.0
	STRAND JUMPER WIRE UL1007 4+92+4mm (BLACK) #AWG-26				
1	44-302610202-41	1.00000	PC	P Y N N USD	0.0
	STRAND JUMPER WIRE UL1007 AWG26 4+92+4mm (RED)				
1	44-8E0012266-00	1.00000	PC	P Y N N USD	0.0
	16P FLEX FLAT CABLE 1mm S4+4 (0.035x0.7mm) L=120mm(D.SAME)				
1	45-112030118-06	1.00000	PC	P Y N N USD	0.0
	AC CORD-VDE APP.(BLK) 2M (M.T)MT-11+H03VVH2-F2(4W10006300)				
1	50-2000004N4-00	1.00000	PC	P Y N N USD	0.
	AC CORD BUSHING (UL APP) #4N4				
1	57-00X400000-00	1.00000	PC	P Y N N USD	0.
	SHEET FOR PCB (LUMIRROR 94V0) #NSX-4000R				
1	58-04X400001-00	1.00000	PC	P Y N N USD	0.
	DRIVE BELT #NSX-4000 DIA21x1.2x1.2mm				
1	58-09KOPEN00-00	8.00000	PC	P Y N N USD	0.
	CABLE TIE 2.5MMx4" #CV-100				
1	58-19D25000-00	1.00000	PC	P Y N N USD	0.
	FELT (W/TAPE 90x5mm) 90x5x0.5mm				
1	58-19D250000-00	3.00000	PC	P Y N N USD	0.
	FELT (DIA11x5xH 5mm) W/TAPExt (CEC2571002500)				

PG ID: MBRM03

Date: 23/11/2002 11:58:23

Bills Of Material Component Listing With Cost

Page: 18

Model #: 00-X40001315-04 Description: AM/FM ST.RADIO (PLL) CD/CDRW PLAYER W/REMOTE #NSX-4000RDS Rev Date  
 Rev #: 0 Specification: 230V CE APP(SIL.+KNOB & PANEL:CHROME SIL.)- Cost From Source :N  
 Draw #: Brand Name : "AKAI CDP-2400RDS"

Currency : USD Rate : 7.80000 \*

Level	Code #	Usage	Qty	U/M	Op	PMS	Is	Sp	Sc	Cu	1
Description											

- 5 DEC 2003

1	58-26X400001-00	2.00000	PC	P Y N N USD	0.
	CD RUBBER DIA3.7mm T=3mm #NSX-4000R				
1	58-26X400010-00	4.00000	PC	P Y N N USD	0.
	RUBBER FOOT DIA25mm T=3mm #NSX-4000R (BLK)(PORON) W/TA				
1	58-44500TB00-00	1.00000	PC	P Y N N USD	0.
	MOTOR RF-500TB-12560				
1	58-61AC21000-00	2.00000	PC	P Y N N USD	0.
	SHOCK ABSORBER.(RED) (SOFT TYPE 30C AC210)				
1	58-61AC22000-00	2.00000	PC	P Y N N USD	0.
	SHOCK ABSORBER.(GREEN) (HARD TYPE 40C AC220)				
1	58-63X400000-01	1.00000	PC	P Y N N USD	0.
	FIBRE PLATE 54x100mm #NSX-4000				
1	58-63X400001-00	1.00000	PC	P Y N N USD	0.
	FIBRE PLATE #NSX-4000RDS				
1	58-63X400002-00	1.00000	PC	P Y N N USD	0.
	FIBRE PLATE 4 (50x70mm) #NSX-4000RDS				
1	61-11X400010-00	1.00000	PC	P Y N N USD	0.
	METAL PLATE/L #NSX-4000R				
1	61-11X400020-00	1.00000	PC	P Y N N USD	0.
	METAL PLATE/R #NSX-4000R				
1	61-11X400040-01	1.00000	PC	P Y N N USD	0.
	TRANSFORMER BRACKET (R1) #NSX-4000R 95x74.5mm				
1	61-63X400010-00	1.00000	PC	P Y N N USD	0.
	BACK METAL PLATE #NSX-4000R 288.6x76.3x1mm				
1	66-230260431-00	2.00000	PC	P Y N N USD	0.
	MACHINE SCREW MS/PH 2.6x4				
1	66-312300831-00	8.00000	PC	P Y N N USD	0.
	SCREW TB/HA 3x8mm (HLR DIA7mm)				
1	66-421301031-00	2.00000	PC	P Y N N USD	0.
	SELF-TAPPING SCREW TA/BH 3x10				
1	66-431260631-00	4.00000	PC	P Y N N USD	0.
	SELF-TAPPING SCREW TA/PH 2.6x6				
1	66-431301031-00	19.00000	PC	P Y N N USD	0.
	SELF-TAPPING SCREW TA/PH 3x10				
1	66-431301231-00	2.00000	PC	P Y N N USD	0.
	SELF-TAPPING SCREW TA/PH 3x12				
1	66-431301831-00	4.00000	PC	P Y N N USD	0.
	SELF TAPPING SCREW TA/PH 3x18				
1	66-451301231-00	3.00000	PC	P Y N N USD	0.
	SELF-TAPPING SCREW TA/KH 3x12				
1	66-481261031-00	12.00000	PC	P Y N N USD	0.
	SELF-TAPPING SCREW TA/WH 2.6x10				
1	66-481301031-00	2.00000	PC	P Y N N USD	0.
	SELF-TAPPING SCREW TA/WH 3x10				

PG ID: MBMR03

Date: 23/11/2002 11:38:23

Bills Of Material Component Listing With Cost

Page: 19

Model #: 00-X40001315-04 Description: AM/FM ST.RADIO (PLL) CD/CDRW PLAYER W/REMOTE #NSX-4000RDS Rev Date  
 Rev #: 0 Specification: 230V CE APP(SIL.+KNOB & PANEL:CHROME SIL.) Cost From Source :N  
 Draw #: Brand Name : "AKAI CDP-2400RDS"

Currency : USD Rate : 7.80000 \*

Level	Code #	Usage	Ven #	U/M	Op	PMS	Is	Sp	Sc	Cu	I
	Description										







- 5 DEC 2003

1	56-07X400490-10	1.00000	PC	P	Y	N	N	USD	0.
	LCD BKT (ABS)	#X-4000 (WHITE)							
1	56-07X400590-10	2.00000	PC	P	Y	N	N	USD	0.
	TUNING/POWER PCB BKT (ABS)	#X-4000 (WHITE)							
1	56-07X400790-10	1.00000	PC	P	Y	N	N	USD	0.
	REMOTE BKT (ABS)	#X-4000 (WHITE)							
1	56-07X400890-10	1.00000	PC	P	Y	N	N	USD	0.
	POWER LED BKT (ABS)	#X-4000 (WHITE)							
1	56-07X400990-10	2.00000	PC	P	Y	N	N	USD	0.
	SUPPORT BKT (ABS)	#X-4000 (WHITE)							
1	56-07X400A90-10	2.00000	PC	P	Y	N	N	USD	0.
	LED CUSHION (HOLDER) (ABS)	#X-4000 (WHITE)							
1	56-09X4001G0-10	1.00000	PC	P	Y	N	N	USD	0.
	SIDE PANEL A/L (ABS)	#X-4000 (CHROME SIL.)							
1	56-09X4002G0-10	1.00000	PC	P	Y	N	N	USD	0.
	SIDE PANEL A/R (ABS)	#X-4000 (CHROME SIL.)							
1	56-09X4003G0-10	1.00000	PC	P	Y	N	N	USD	0.
	SIDE PANEL B/L (ABS)	#X-4000 (CHROME SIL.)							
1	56-09X4004G0-10	1.00000	PC	P	Y	N	N	USD	0.
	SIDE PANEL B/R (ABS)	#X-4000 (CHROME SIL.)							
1	56-14X400060-70	1.00000	PC	P	Y	N	N	USD	0.
	CD DOOR (PMMA)	#X-4000 (GLASS BLUE)							
1	56-14X4001A1-10	1.00000	PC	P	Y	N	N	USD	0.
	CD DOOR COVER (ABS)	#X-4000 (SIL.)							
1	56-22520R0B0-10	1.00000	PC	P	Y	N	N	USD	0.
	LASER COVER	#520R							
1	56-22X400090-10	1.00000	PC	P	Y	N	N	USD	0.
	FM ANT COVER (ABS)	#X-4000							
1	56-22X400190-10	1.00000	PC	P	Y	N	N	USD	0.
	CD LED COVER (ABS)	#X-4000							
1	56-37X400100-30	1.00000	PC	P	Y	N	N	USD	0.
	WORM GEAR (POM)	#X-4000							
1	56-37X400200-30	1.00000	PC	P	Y	N	N	USD	0.
	DRIVE GEAR (POM)	#X-4000							
1	56-53X4000G0-10	2.00000	PC	P	Y	N	N	USD	0.
	CD CONTROL KNOB (GROUP) (ABS)	#X-4000 (CHROME SIL.)							
1	56-53X4001G0-10	2.00000	PC	P	Y	N	N	USD	0.
	STANDY/OPEN KNOB (ABS)	#X-4000 (CHROME SIL.)							
1	56-57X400100-70	1.00000	PC	P	Y	N	N	USD	0.
	LCD BACK LIGHT LENS (PMMA)	#X-4000							
1	56-57X400200-70	1.00000	PC	P	Y	N	N	USD	0.
	CD LED LENS (PMMA)	#X-4000							
1	56-57X4003H0-70	2.00000	PC	P	Y	N	N	USD	0.
	FRONT LENS (PMMA)	#X-4000 (HOT STANDING)							

PG ID: MBMR03

Date: 23/11/2002 11:38:23

Bills Of Material Component Listing With Cost

Page: 22

Model #: 00-X40001315-04 Description: AM/FM ST.RADIO (PLL) CD/CDRW PLAYER W/REMOTE #NSX-4000RDS Rev Date  
 Rev #: 0 Specification: 230V CE APP(SIL.+KNOB & PANEL:CHROME SIL.) Cost From Source :N  
 Draw #: Brand Name : "AKAI CDP-2400RDS"

Currency: USD Rate: 7.80000 \*

Level	Code #	Usage	Ven #	U/M	Op	PMS	Is	Sp	Sc	Cu	Lat.Cost	Scrap	Cost
Description													

