

CS-F11

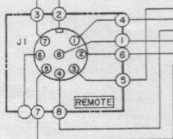

REMOCON PCB

- (U) CL-5402B
- (J) CL-5403B
- (A) CL-5404B
- (EBS) CL-5405B
- (C) CL-5406B

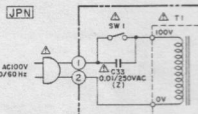

POWER SUPPLY & SYSCON PCB (J) CL-5403A

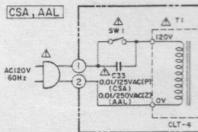

POWER SUPPLY & SYSCON PCB (A) CL-5404A (AAL) (C) CL-5406A (CSA)

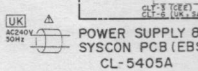
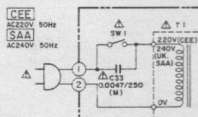

POWER SUPPLY & SYSCON PCB (EBS) CL-5405A

OPERATION SWITCH

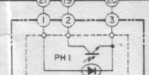
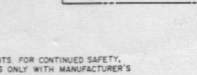
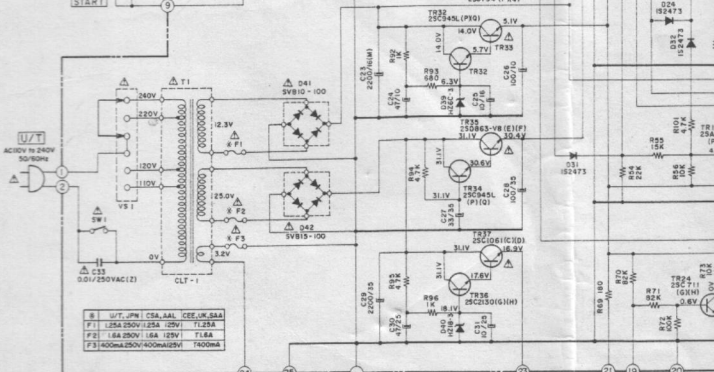
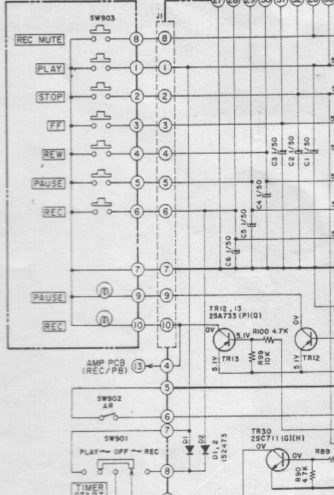

WARNING: INDICATES SAFETY CRITICAL COMPONENTS FOR CONTINUED SAFETY. REPLACE SAFETY CRITICAL COMPONENTS ONLY WITH MANUFACTURER'S RECOMMENDED PARTS

AVERTISSEMENT: IL INDIQUE LES COMPOSANTS CRITIQUES DE SÛRETÉ. POUR MAINTENIR LE DEGRÉ DE SÛRETÉ DE L'APPAREIL, NE REMPLACER LES COMPOSANTS DONT LE FONCTIONNEMENT EST CRITIQUE POUR LA SÛRETÉ QUE PAR DES PIÈCES RECOMMANDÉES PAR LE FABRICANT.

B1	100K	JPN	CSA, AAL	CEE, UK, SAA
F1	125A	120V	125A	125A
F2	16A	250V	16A	125V
F3	1000uF	120V	1000uF	1000uF

F G H J K

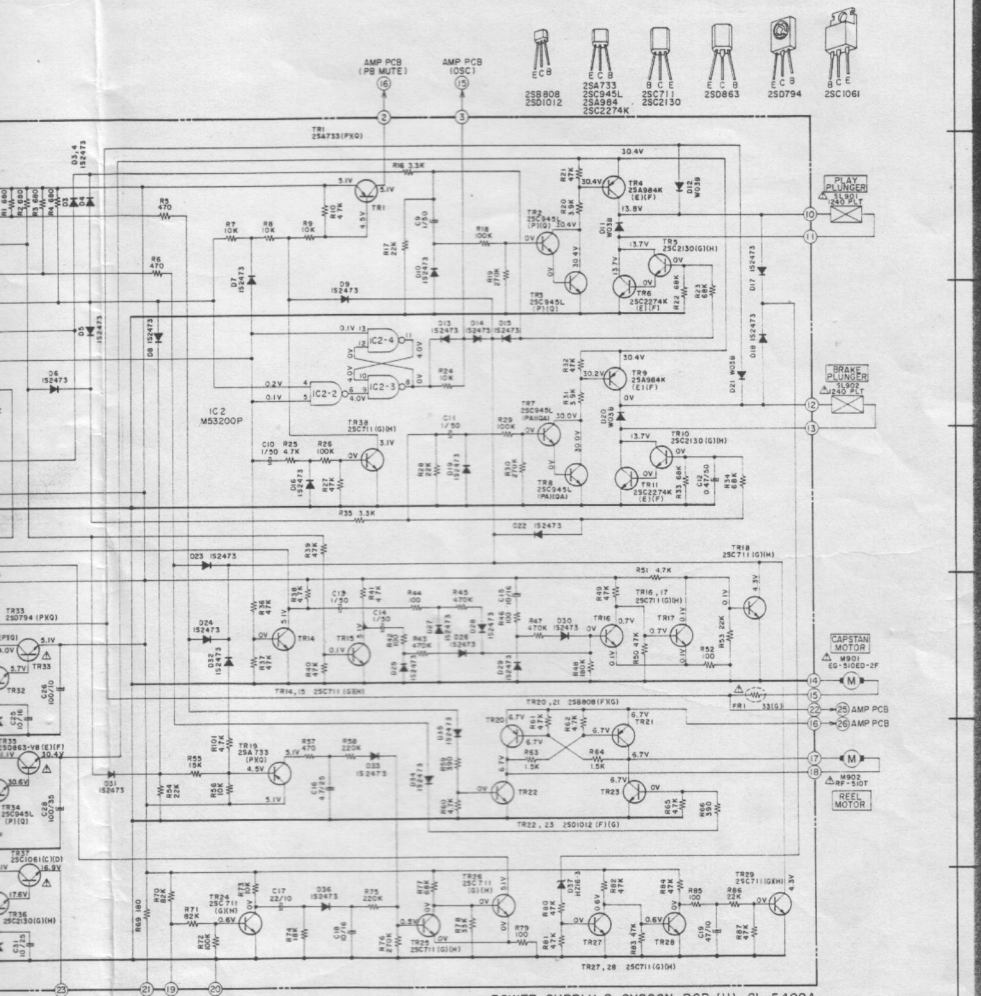

POWER SUPPLY & SYSCON PCB (U) CL-5402A

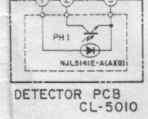

NOTE  
UNLESS OTHERWISE SPECIFIED  
ALL RESISTORS IN OHMS (1/4W 1%)  
ALL CAPACITORS IN  $\mu$ F 50 WV(1)

CS-F11  
POWER & SYSCON  
SCHEMATIC DIAGRAM  
No. 2-2 1620243A  
2C

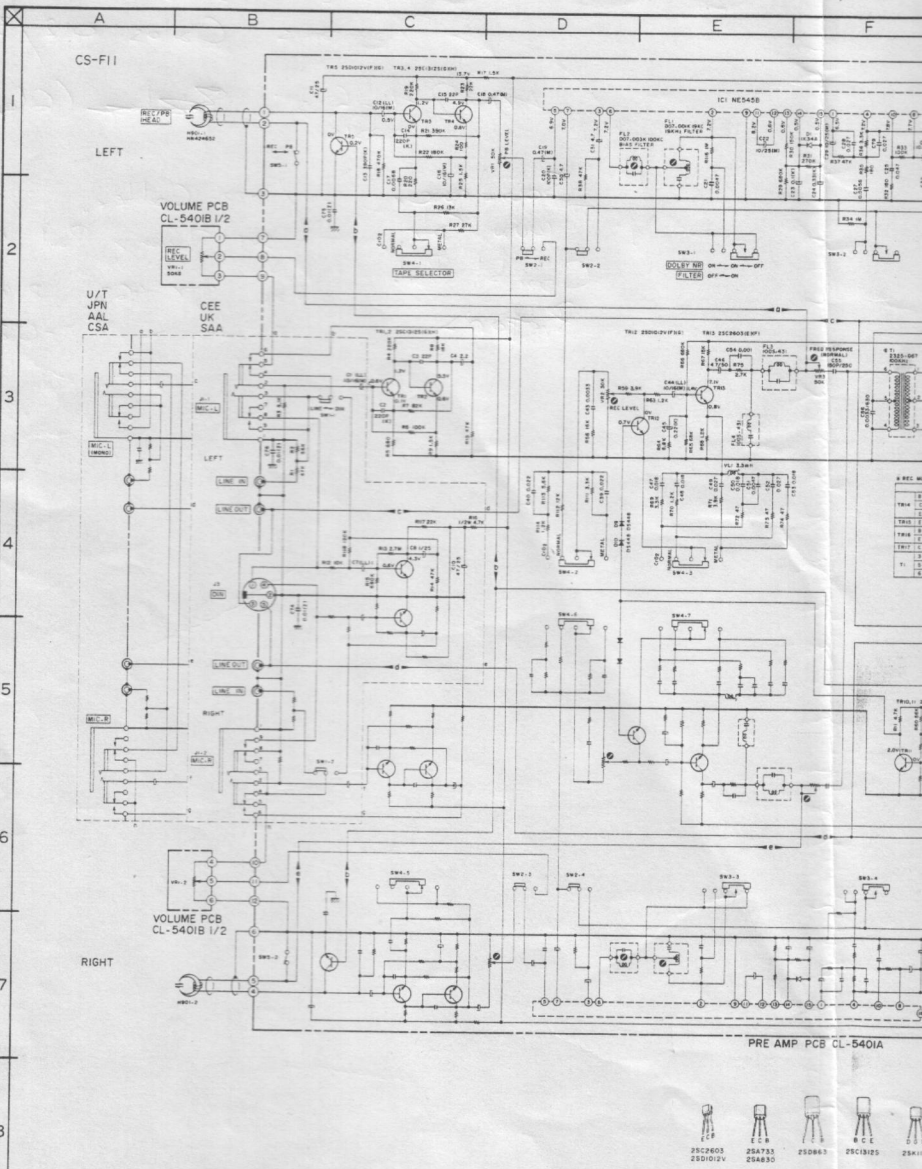

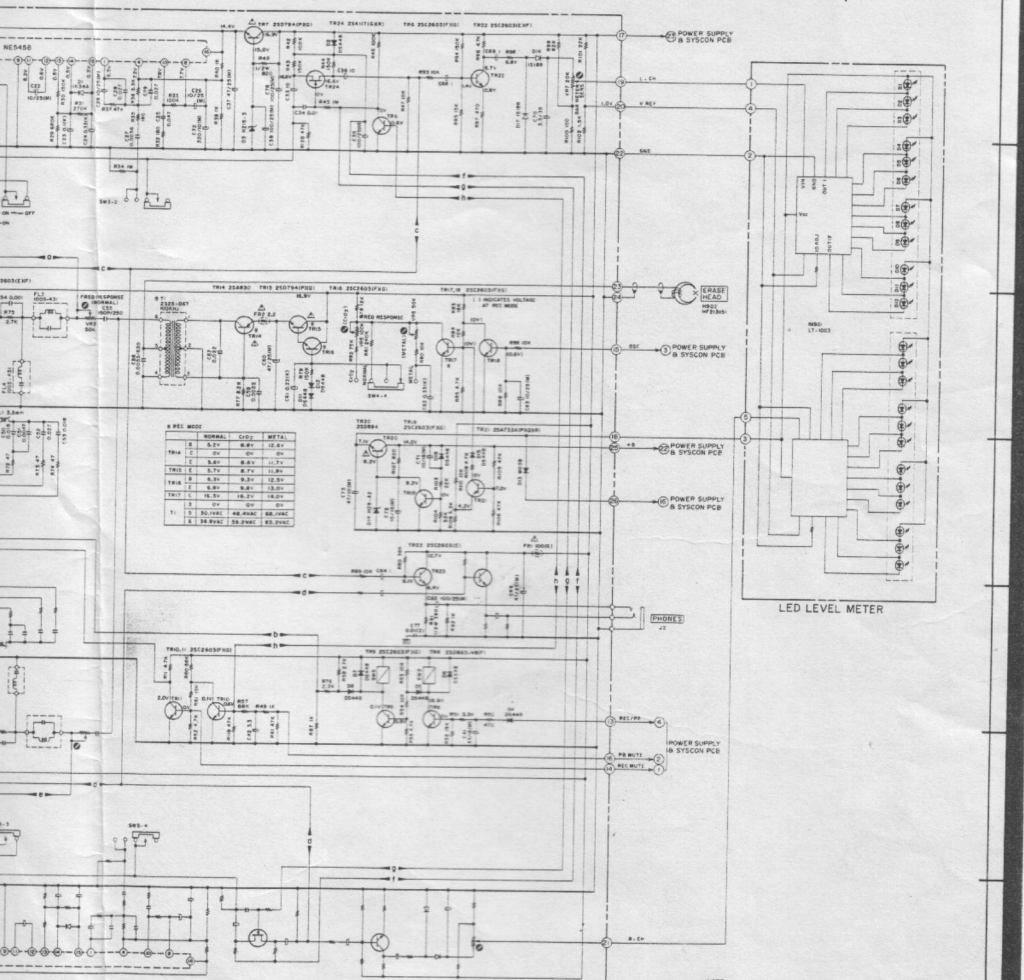

# RES MODE

	NORMAL	CRP	MTFL
TR1	0V	0V	0V
TR2	0V	0V	0V
TR3	0V	0V	0V
TR4	0V	0V	0V
TR5	0V	0V	0V
TR6	0V	0V	0V
TR7	0V	0V	0V
TR8	0V	0V	0V
TR9	0V	0V	0V
TR10	0V	0V	0V
TR11	0V	0V	0V
TR12	0V	0V	0V
TR13	0V	0V	0V
TR14	0V	0V	0V
TR15	0V	0V	0V
TR16	0V	0V	0V
TR17	0V	0V	0V
TR18	0V	0V	0V
TR19	0V	0V	0V
TR20	0V	0V	0V
TR21	0V	0V	0V
TR22	0V	0V	0V
TR23	0V	0V	0V
TR24	0V	0V	0V
TR25	0V	0V	0V
TR26	0V	0V	0V
TR27	0V	0V	0V
TR28	0V	0V	0V
TR29	0V	0V	0V
TR30	0V	0V	0V
TR31	0V	0V	0V
TR32	0V	0V	0V
TR33	0V	0V	0V
TR34	0V	0V	0V
TR35	0V	0V	0V
TR36	0V	0V	0V
TR37	0V	0V	0V
TR38	0V	0V	0V
TR39	0V	0V	0V
TR40	0V	0V	0V
TR41	0V	0V	0V
TR42	0V	0V	0V
TR43	0V	0V	0V
TR44	0V	0V	0V
TR45	0V	0V	0V
TR46	0V	0V	0V
TR47	0V	0V	0V
TR48	0V	0V	0V
TR49	0V	0V	0V
TR50	0V	0V	0V
TR51	0V	0V	0V
TR52	0V	0V	0V
TR53	0V	0V	0V
TR54	0V	0V	0V
TR55	0V	0V	0V
TR56	0V	0V	0V
TR57	0V	0V	0V
TR58	0V	0V	0V
TR59	0V	0V	0V
TR60	0V	0V	0V
TR61	0V	0V	0V
TR62	0V	0V	0V
TR63	0V	0V	0V
TR64	0V	0V	0V
TR65	0V	0V	0V
TR66	0V	0V	0V
TR67	0V	0V	0V
TR68	0V	0V	0V
TR69	0V	0V	0V
TR70	0V	0V	0V
TR71	0V	0V	0V
TR72	0V	0V	0V
TR73	0V	0V	0V
TR74	0V	0V	0V
TR75	0V	0V	0V
TR76	0V	0V	0V
TR77	0V	0V	0V
TR78	0V	0V	0V
TR79	0V	0V	0V
TR80	0V	0V	0V
TR81	0V	0V	0V
TR82	0V	0V	0V
TR83	0V	0V	0V
TR84	0V	0V	0V
TR85	0V	0V	0V
TR86	0V	0V	0V
TR87	0V	0V	0V
TR88	0V	0V	0V
TR89	0V	0V	0V
TR90	0V	0V	0V
TR91	0V	0V	0V
TR92	0V	0V	0V
TR93	0V	0V	0V
TR94	0V	0V	0V
TR95	0V	0V	0V
TR96	0V	0V	0V
TR97	0V	0V	0V
TR98	0V	0V	0V
TR99	0V	0V	0V
TR100	0V	0V	0V

PRE AMP PCB CL-5401A

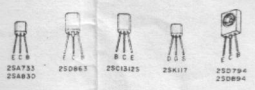

WARNING: Δ INDICATES SAFETY CRITICAL COMPONENTS FOR CONTINUED SAFETY. REPLACE SAFETY CRITICAL COMPONENTS ONLY WITH MANUFACTURER'S RECOMMENDED PARTS.  
 AVERTISSEMENT: Δ IL INDIQUE LES COMPOSANTS CRITIQUES DE SÛRETÉ. POUR MAINTENIR LE DEGRÉ DE SÛRETÉ DE L'APPAREIL, NE REMPLACER LES COMPOSANTS DONT LE FONCTIONNEMENT EST CRITIQUE POUR LA SÛRETÉ QUE PAR DES PIÈCES RECOMMANDÉES PAR LE FABRICANT.

NOTE  
 UNLESS OTHERWISE SPECIFIED  
 ALL RESISTORS IN OHMS (W/Δ)  
 ALL CAPACITORS IN μF 50 W/V Δ  
 FFS = FAIL SAFE RESISTORS  
 LL = LOW LEAKAGE CAPACITORS

CS-F11 AMP  
 SCHEMATIC DIAGRAM  
 NO.2-1 1620242A