

AKAI SERVICE MANUAL

**THIS MANUAL MUST BE USED AS A SET
TOGETHER WITH SEPARATELY PUBLISHED
GX-F35 SERVICE MANUAL AND PARTS LIST.**

STEREO CASSETTE DECK

MODEL GX-F37

I. TECHNICAL DATA

TRACK SYSTEM	4 Track 2 Channel Stereo System
TAPE	Philips Type Cassette
TAPE SPEED	4.76 cm/s $\pm 1.0\%$ (1-7/8 ips. $\pm 1.0\%$)
HEADS	Erase head $\times 1$ Twin Field Super GX head for recording/playback $\times 1$
MOTORS	Electronically speed controlled DC motor for capstan drive $\times 1$ DC motor for reel drive $\times 1$
WOW & FLUTTER	Less than 0.04% WRMS, 0.11% (DIN 45500)
TAPE WINDING TIME	80 sec. using a C-60 cassette tape
FREQUENCY RESPONSE	LN: 30 to 15,000 Hz ± 3 dB (-20 VU) LH: 30 to 16,000 Hz ± 3 dB (-20 VU) CrO ₂ : 30 to 16,500 Hz ± 3 dB (-20 VU) 30 to 9,000 Hz ± 3 dB (0 VU) Metal: 30 to 19,000 Hz ± 3 dB (-20 VU) 30 to 13,000 Hz ± 3 dB (0 VU)
SIGNAL TO NOISE RATIO	LN: Better than 58 dB LH: Better than 58 dB CrO ₂ : Better than 60 dB Metal: Better than 60 dB (measured via tape with peak recording level) HIGH COM ON 80 dB (Metal), D-NR ON: improves up to 10 dB above 5 kHz
HARMONIC DISTORTION	LN: Less than 0.8% LH: Less than 0.8% CrO ₂ : Less than 0.7% Metal: Less than 0.7%
DYNAMIC RANGE	72 dB at 1,000 Hz HIGH COM OFF 94 dB at 1,000 Hz HIGH COM ON
INPUT	MIC: 0.25 mV (input impedance 5.0 kohms) Required microphone impedance: 600 ohms Line: 70 mV (input impedance 30 kohms)
OUTPUT	Line: 410 mV at 0 VU Required load impedance: more than 20 kohms Phone: 100 mV/8 ohms at 0 VU
DIN	Input: 2 mV (input impedance 10 kohms) Output: 410 mV Required load impedance: more than 20 kohms
POWER REQUIREMENTS	120V, 60 Hz for USA and Canada 220V, 50 Hz for Europe except UK 240V, 50 Hz for UK and Australia 110V/120V/220V/240V, 50/60 Hz internally switchable for other countries
POWER CONSUMPTION	U/T, CSA 25W
DIMENSIONS	440 (W) \times 118 (H) \times 285 (D) mm (17.3 \times 4.6 \times 11.2")
WEIGHT	6.9 kg (15.2 lbs)

*For improvement purposes, specifications and design are subject to change without notice.

*HIGH COM is a trademark of AEG-TELEFUNKEN.

II. HIGH-COM ADJUSTMENT

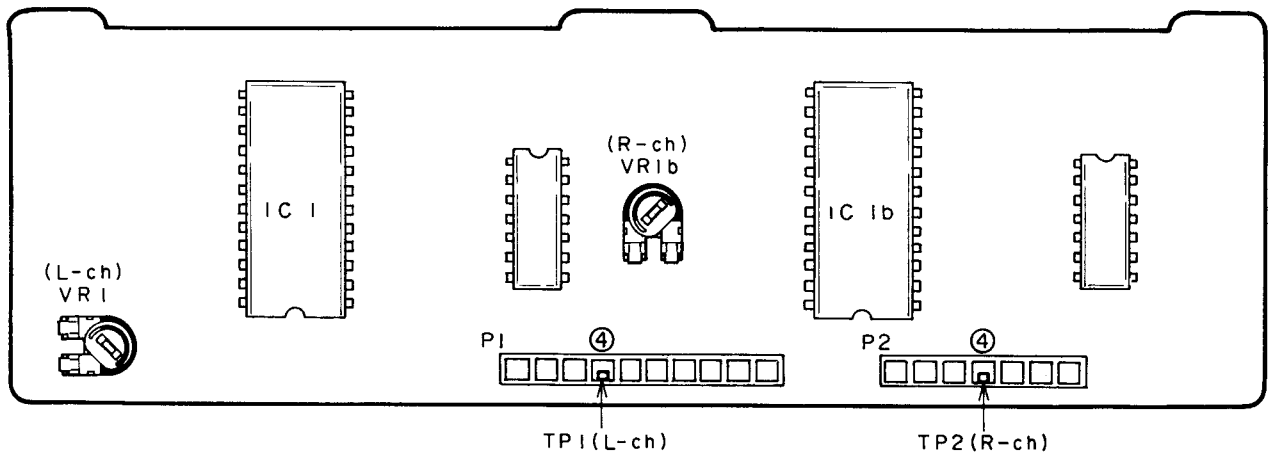

Fig. 1 HIGH-COM P.C Board

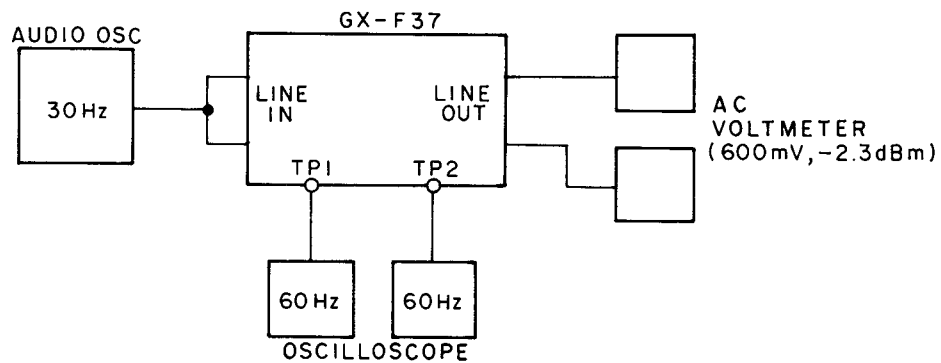

Fig. 2 Instrument Connection

1. Set the Rec Volume so that when 30 Hz of signal is input during REC/PAUSE mode, the output is 600 mV (-2.3 dBm).
2. Connect the TP1 (L-ch) and the TP2 (R-ch) to the oscilloscope to observe the wave form.
3. Adjust the wave form with the VR1 (L-ch) and VR1b (R-ch) so that it is at a constant level. (Fig. 3)
(This wave form becomes 60 Hz).

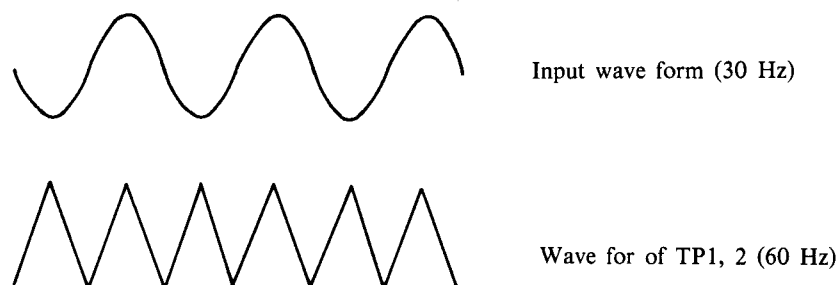

Fig. 3

- NOTES:**
1. The output Volume should be set at maximum.
 2. Set NR Selector to HIGH-COM Position.

III. P.C BOARD TITLES AND IDENTIFICATION NUMBERS

P.C BOARD TITLE	P.C BOARD NUMBER	REMARKS
Pre Amp P.C Board	CL-5001A	
Volume P.C Board	CL-5001B	
LED P.C Board	CL-5001C	
Bar Meter P.C Board	CL-5002	
Power Supply P.C Board	CL-5003	U/T
Power Supply P.C Board	CL-5006	CEE, SAA, UK
Power Supply P.C Board	CL-5025	CSA
System Control P.C Board	CL-5007A	
Remote Control P.C Board	CL-5007B	
Program P.C Board	CL-5008	
Lamp P.C Board	CL-5009	
Detector P.C Board	CL-5010	
Filter P.C Board	CL-5026	
HIGH-COM P.C Board	CL-5602	

IV. PARTS LIST

*The composite parts of Model GX-F37 except for those which have been changed as per the list below, are identical to those of Model GX-F35.

Therefore, when ordering parts of this tape deck, please utilize Model GX-F35 Parts List.

1. PRE AMP P.C BOARD (CL-5001A) BLOCK

Ref. No.	Parts No.	Description
1-1	BAT2017A070A	PRE AMP PC BLK GX-F37 (U)
1-2	BAT2017A070B	PRE AMP PC BLK GX-F37 (E)
1-TR7	ET200985	TR 2SC2603 F, G
1-SW9	ES-305124	SW PUSH SUF12 2-02-02S

3. BAR METER P.C BOARD (CL-5002) BLOCK

Ref. No.	Parts No.	Description
3-1	BAT2016A050B	BAR METER PC BLK GX-F37
3-IND1	EM318607	IND LE FIP48FW16YS GRAPH

2. HIGH-COM P.C BOARD (CL-5602) BLOCK

Ref. No.	Parts No.	Description
2-1	BAT2017A050A	HIGH-COM PC BLK GX-F37
2-IC1	EI305127	IC U401BR
2-IC2	EI304475	IC MC14066BCP
2-VR1	EV315413	R S-FIX H D8 3P 503
2-R1	ER309794	R MF V 1/4W 1601F
2-R2	ER309816	R MF V 1/4W 1502F
2-R3	ER314663	R MF V 1/4W 4702F
2-R4	ER309808	R MF V 1/4W 5601F
2-R6	ER305147	R MF V 1/4W 8253F
2-R8	ER309817	R MF V 1/4W 3302F
2-R9	ER309808	R MF V 1/4W 5601F
2-R14	ER305128	R MF H F10 1/4W 1502F
2-R16	ER307651	R MF H F10 1/4W 3301F
2-R17	ER309793	R MF V 1/4W 1501F
2-C19	EC662308	C SA V R15K 25DC

4. FILTER P.C BOARD (CL-5026) BLOCK

Ref. No.	Parts No.	Description
4-FL1,2	EO669273	COIL FIX 2 FL5R200 18UH

5. FINAL ASSEMBLY BLOCK

Ref. No.	Parts No.	Description
5-1	BDT2017A090A	FRONT PANEL BLK GX-F37 (U)
5-2	BDT2017A090B	FRONT PANEL BLK GX-F37 (E)
5-3	BDT2017A090C	FRONT PANEL BLK GX-F37-BL (U)
5-4	BDT2017A090D	FRONT PANEL BLK GX-F37-BL (E)
5-5	SP-304759	BACK BOARD GX-F37 (U)
5-6	SP304760	BACK BOARD GX-F37 (C)
5-7	SP304761	BACK BOARD GX-F37 (E)
5-8	SP304763	BACK BOARD GX-F37 (B,S)

V. COMPOSITION OF VARIOUS P.C BOARDS

1. PRE AMP P.C BOARD CL-5001A (3ED), VOLUME P.C BOARD CL-5001B, LED P.C Board CL-5001C AND BAR METER P.C BOARD CL-5002

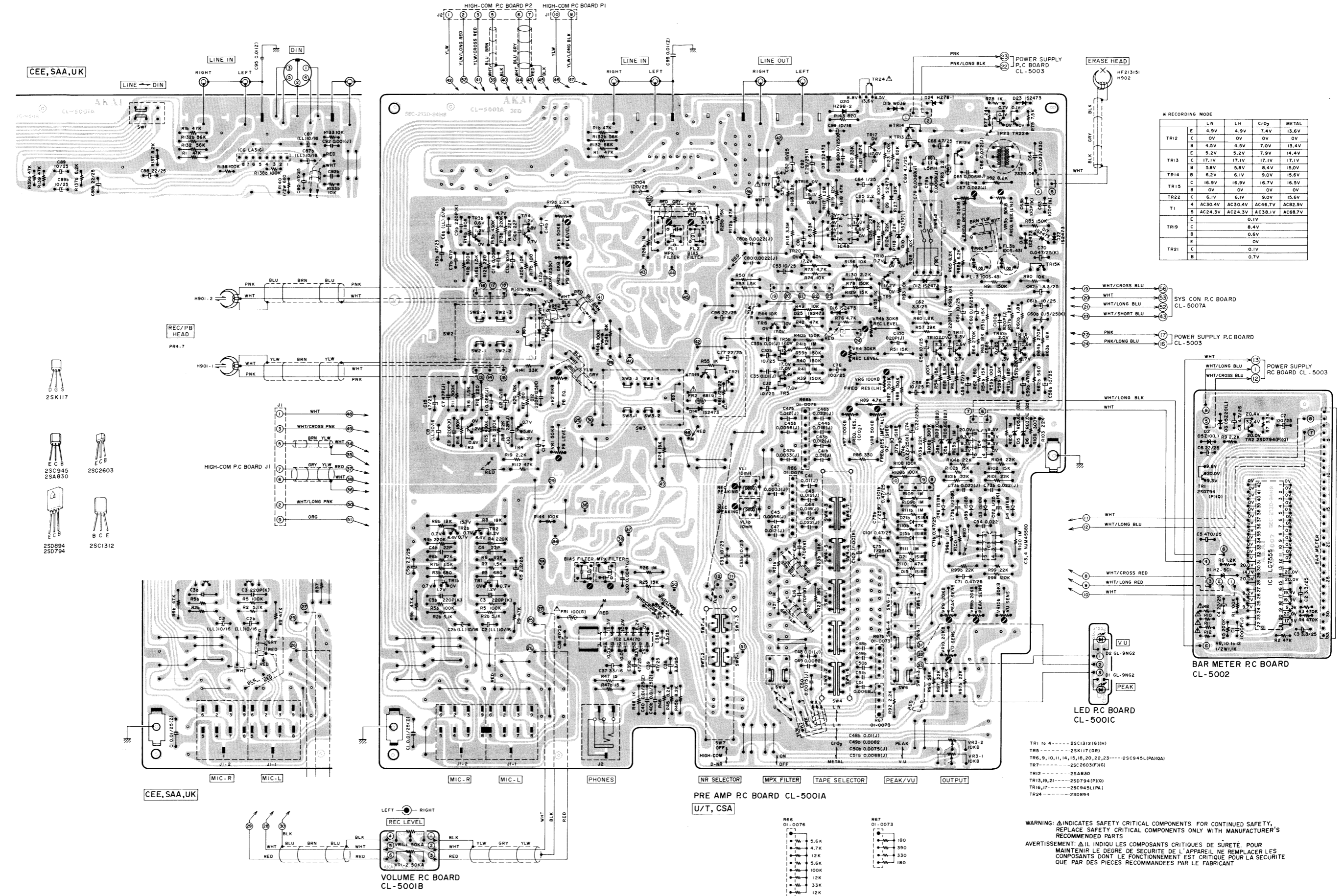

2. SYSTEM CONTROL P.C BOARD CL-5007A (2ED), REMOTE CONTROL P.C BOARD CL-5007B, PROGRAM P.C BOARD CL-5008 AND DETECTOR P.C BOARD CL-5010

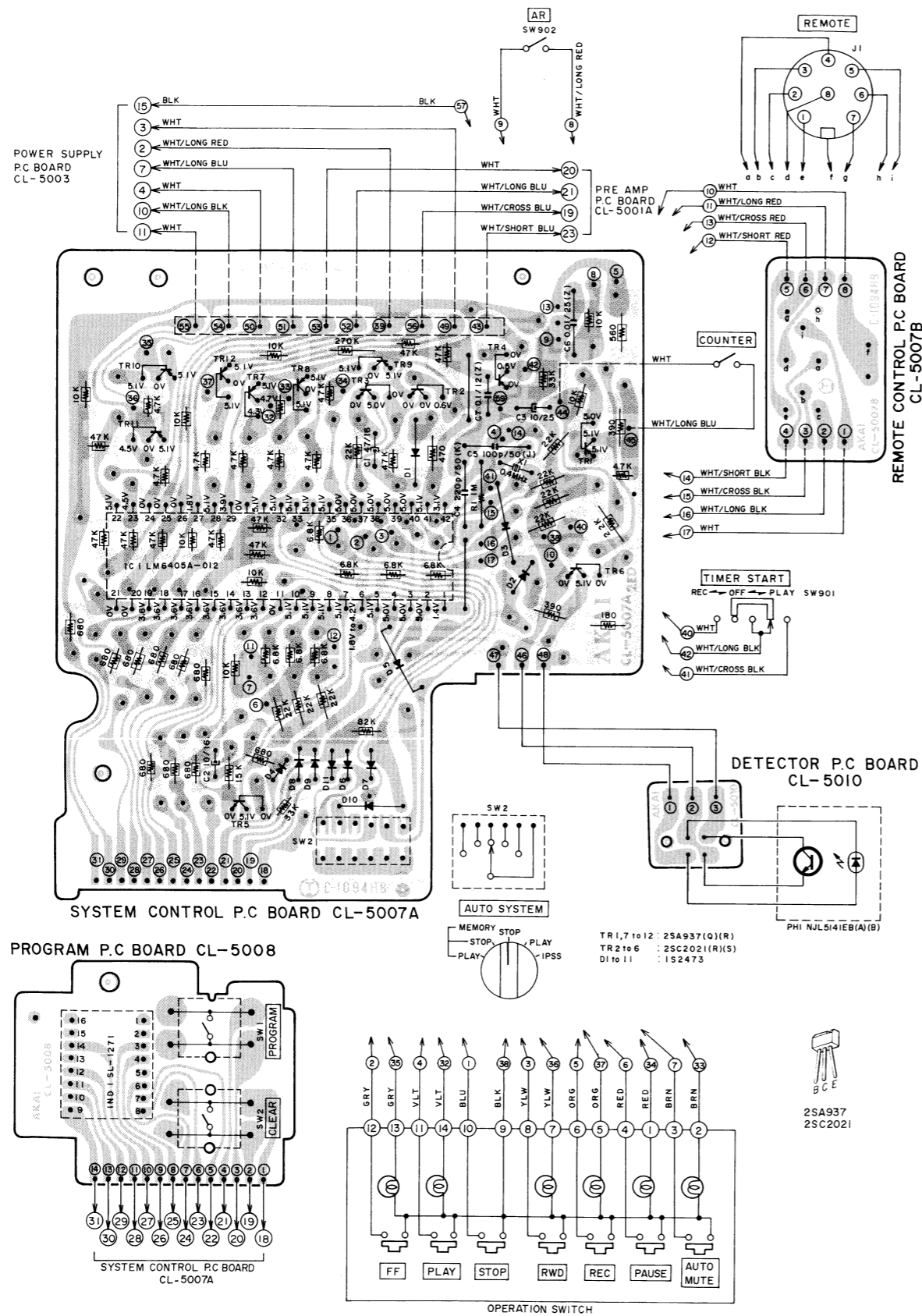

3. HIGH-COM P.C BOARD CL-5602 (2ED)

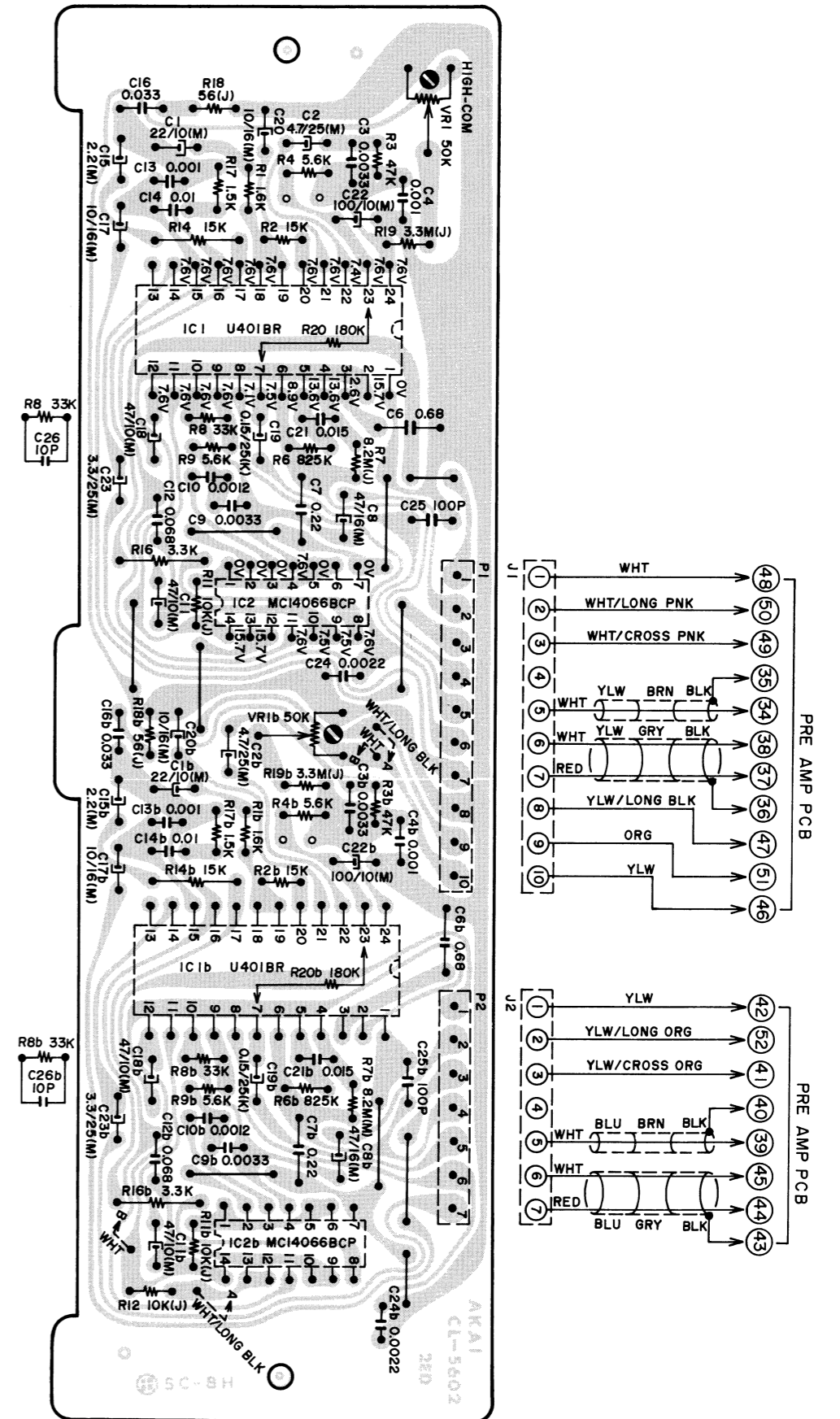

4. POWER SUPPLY P.C BOARD CL-5003 (U/T), CL-5006 (CEE, UK, SAA), CL-5025 (CSA) AND LAMP P.C BOARD CL-5009

POWER SUPPLY P.C BOARD CL-5003 (U/T)

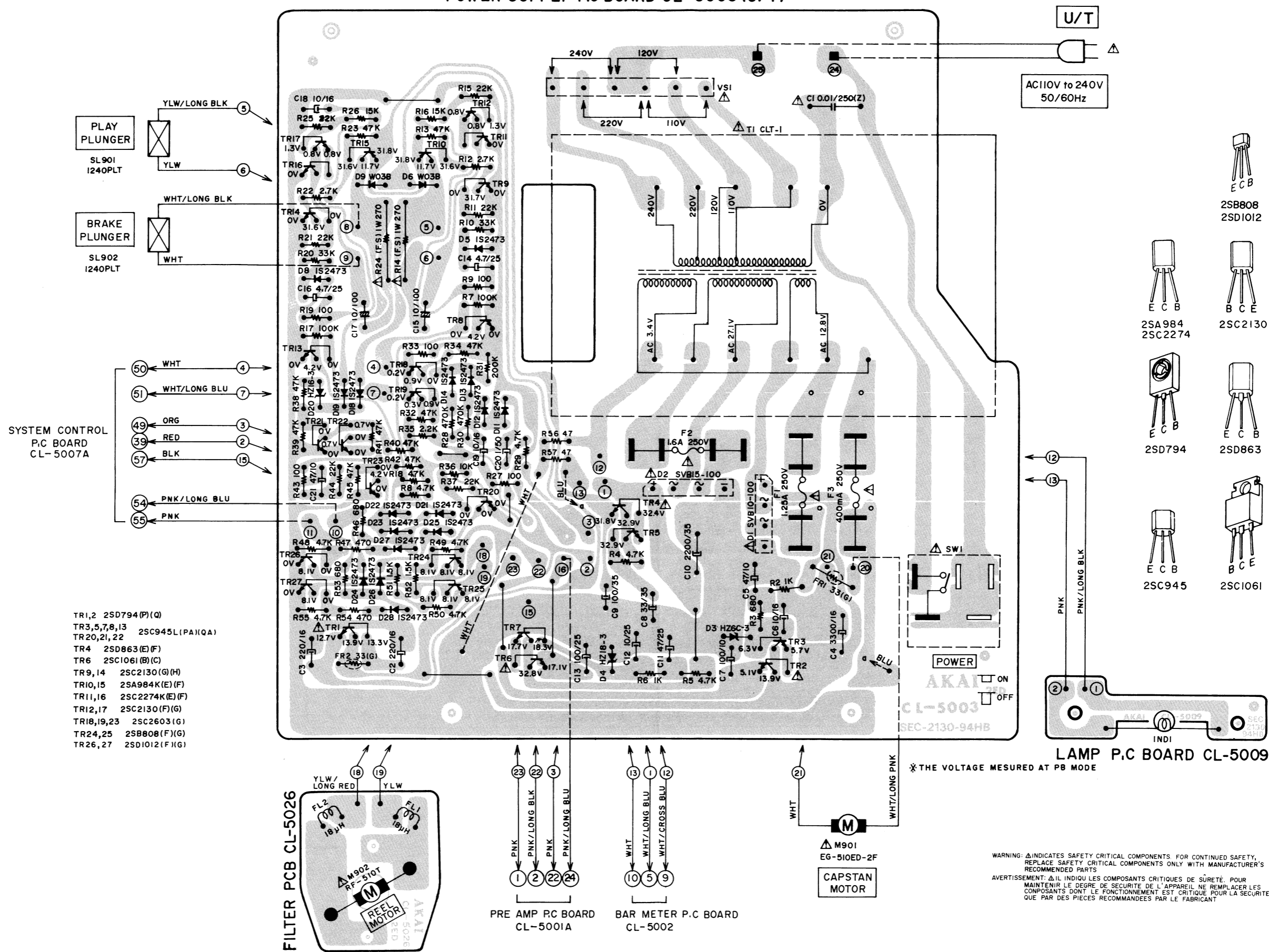

CL-5006(CEE, SAA, UK)

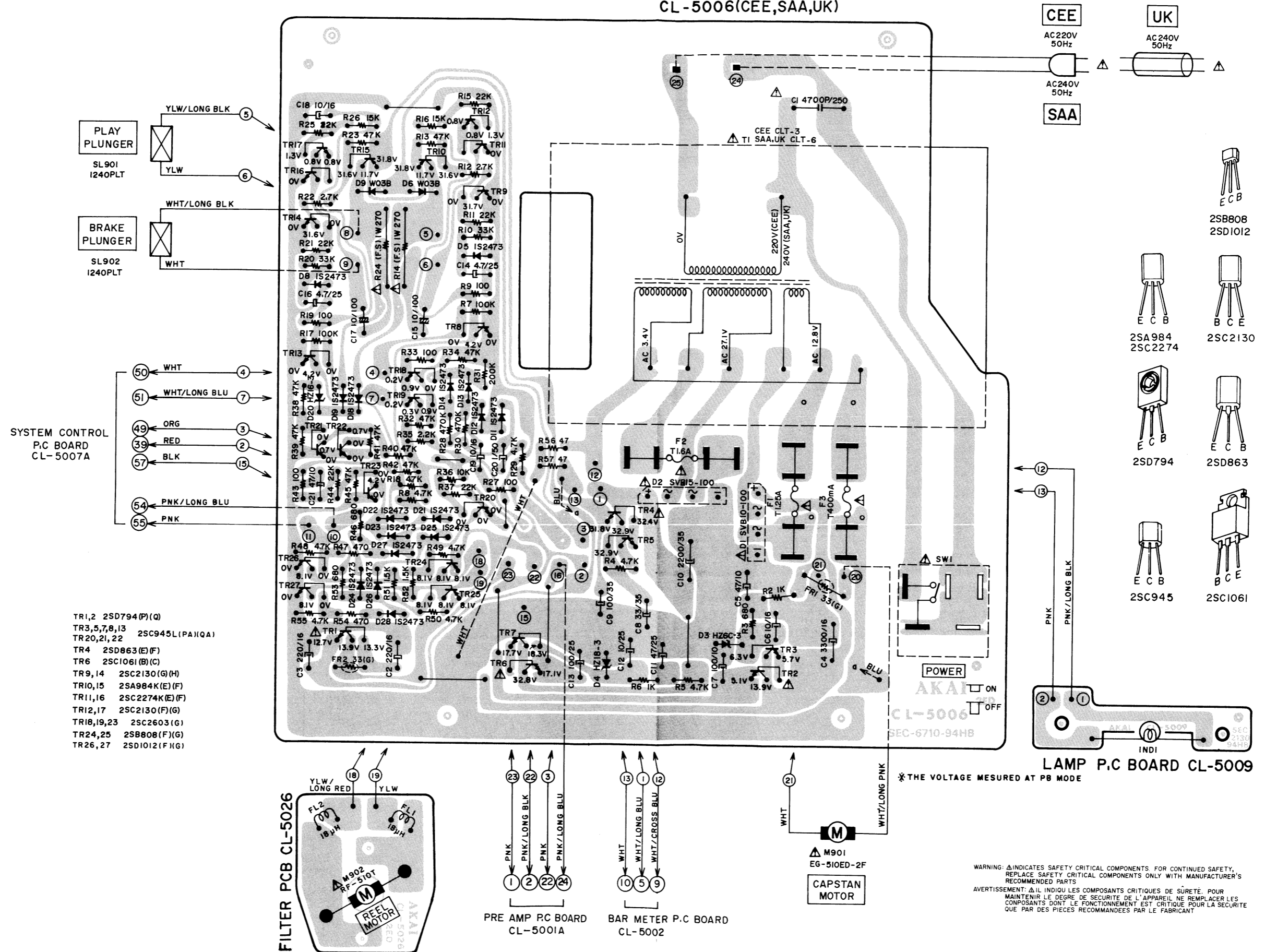

SYSTEM CONTROL
P.C BOARD
CL-5007A

- TR1,2 2SD794(P)(Q)
- TR3,5,7,8,13 2SC945L(PA)(QA)
- TR20,21,22 2SC945L(PA)(QA)
- TR4 2SD863(E)(F)
- TR6 2SC1061(B)(C)
- TR9,14 2SC2130(G)(H)
- TR10,15 2SA984(E)(F)
- TR11,16 2SC2274K(E)(F)
- TR12,17 2SC2130(F)(G)
- TR18,19,23 2SC2603(G)
- TR24,25 2SB808(F)(G)
- TR26,27 2SD1012(F)(G)

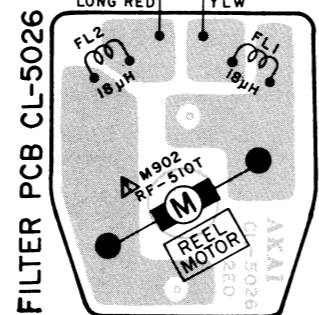

PRE AMP P.C BOARD
CL-5001A

BAR METER P.C BOARD
CL-5002

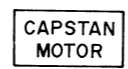

LAMP P.C BOARD CL-5009

WARNING: Δ INDICATES SAFETY CRITICAL COMPONENTS FOR CONTINUED SAFETY, REPLACE SAFETY CRITICAL COMPONENTS ONLY WITH MANUFACTURER'S RECOMMENDED PARTS
AVERTISSEMENT: Δ IL INDIQUE LES COMPOSANTS CRITIQUES DE SÛRETÉ. POUR MAINTENIR LE DEGRÉ DE SÛRETÉ DE L'APPAREIL, NE REMPLACER LES COMPOSANTS DONT LE FONCTIONNEMENT EST CRITIQUE POUR LA SÛRETÉ QUE PAR DES PIÈCES RECOMMANDÉES PAR LE FABRICANT

CL-5025(CSA)

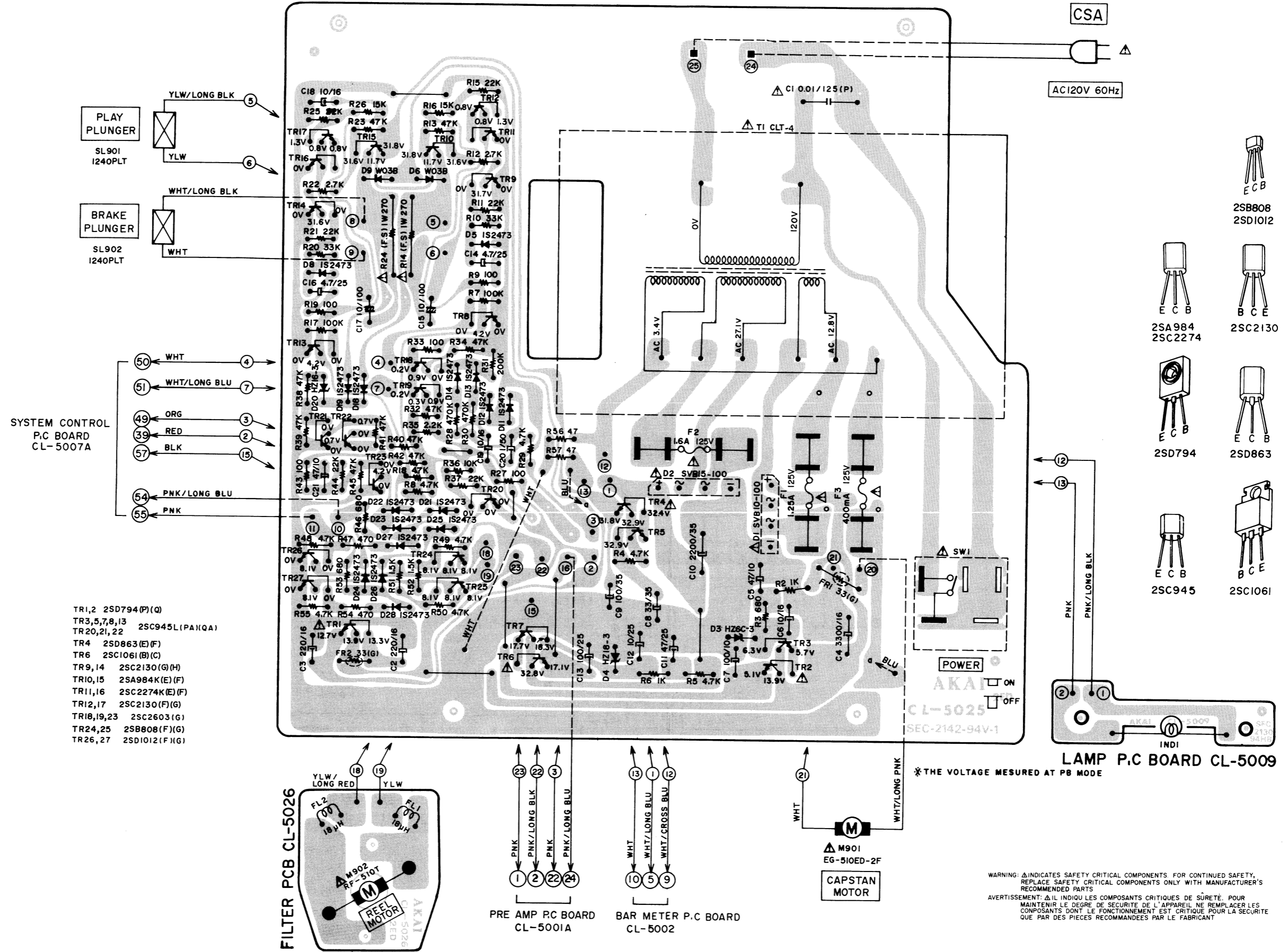

- TR1,2 2SD794(P)(Q)
- TR3,5,7,8,13 2SC945L(PA)(QA)
- TR20,21,22 2SC945L(PA)(QA)
- TR4 2SD863(E)(F)
- TR6 2SC1061(B)(C)
- TR9,14 2SC2130(G)(H)
- TR10,15 2SA984K(E)(F)
- TR11,16 2SC2274K(E)(F)
- TR12,17 2SC2130(F)(G)
- TR18,19,23 2SC2603(G)
- TR24,25 2SB808(F)(G)
- TR26,27 2SD1012(F)(G)

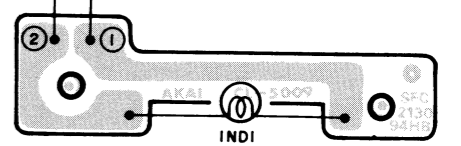
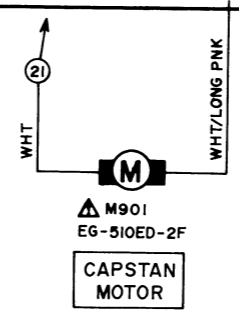
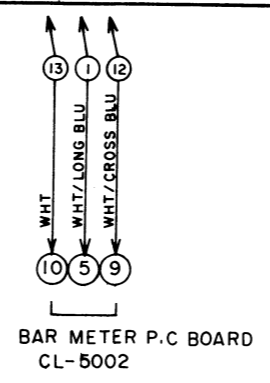
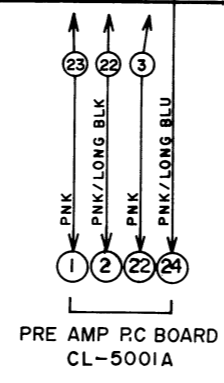
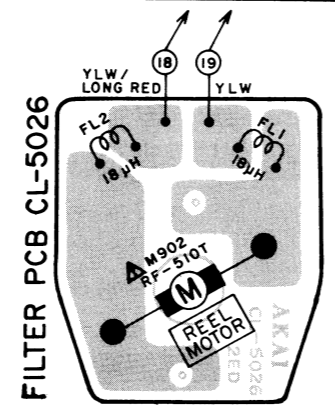

- ECB
2SB808
2SD1012
- ECB
2SA984
2SC2274
- BCE
2SC2130
- ECB
2SD794
- ECB
2SD863
- ECB
2SC945
- BCE
2SC1061

WARNING: Δ INDICATES SAFETY CRITICAL COMPONENTS. FOR CONTINUED SAFETY, REPLACE SAFETY CRITICAL COMPONENTS ONLY WITH MANUFACTURER'S RECOMMENDED PARTS.
AVERTISSEMENT: Δ IL INDIQUE LES COMPOSANTS CRITIQUES DE SÛRETÉ. POUR MAINTENIR LE DEGRÉ DE SÛRETÉ DE L'APPAREIL, NE REMPLACER LES COMPOSANTS DONT LE FONCTIONNEMENT EST CRITIQUE QUE PAR DES PIÈCES RECOMMANDÉES PAR LE FABRICANT.

VI. SCHEMATIC DIAGRAM

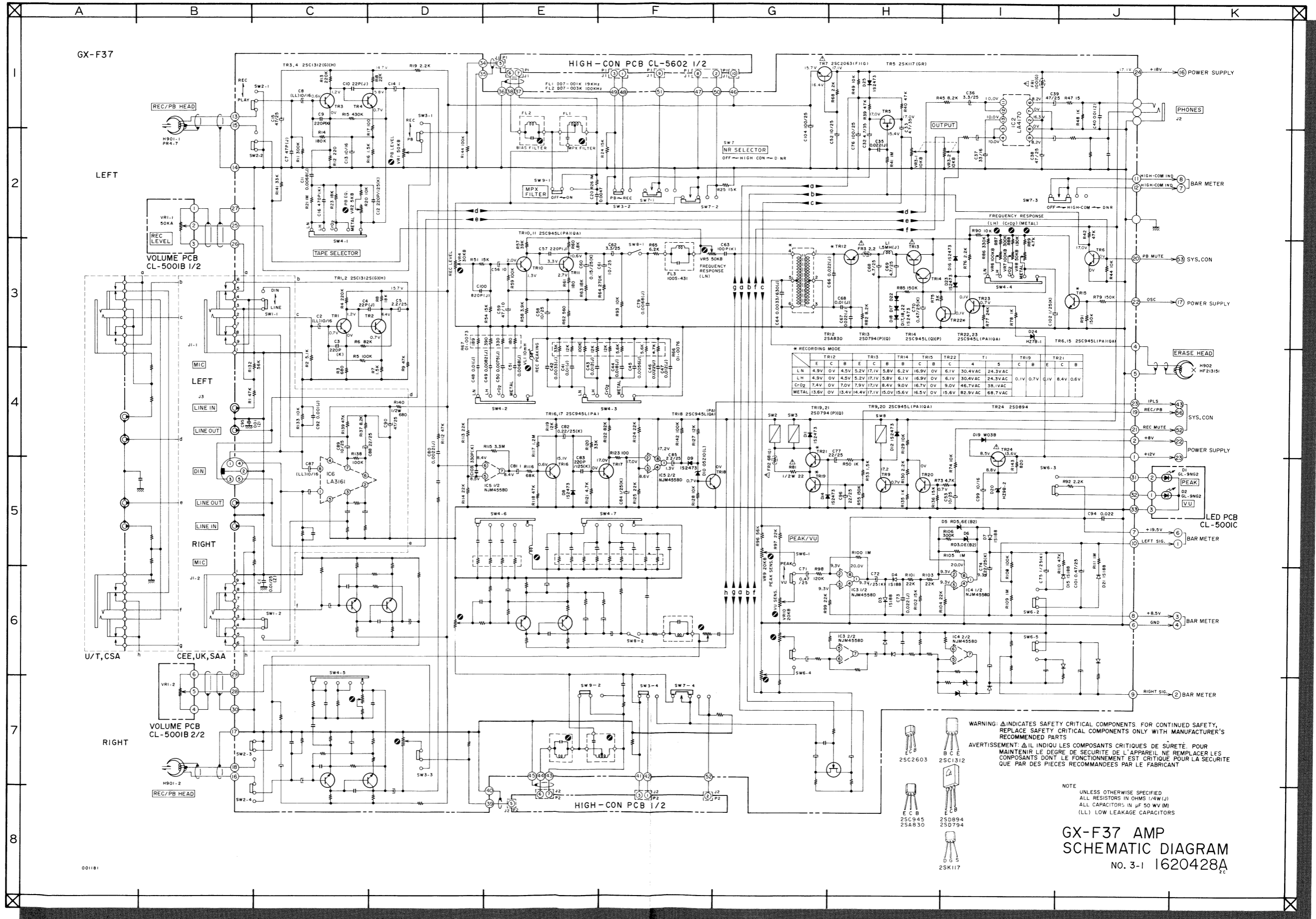

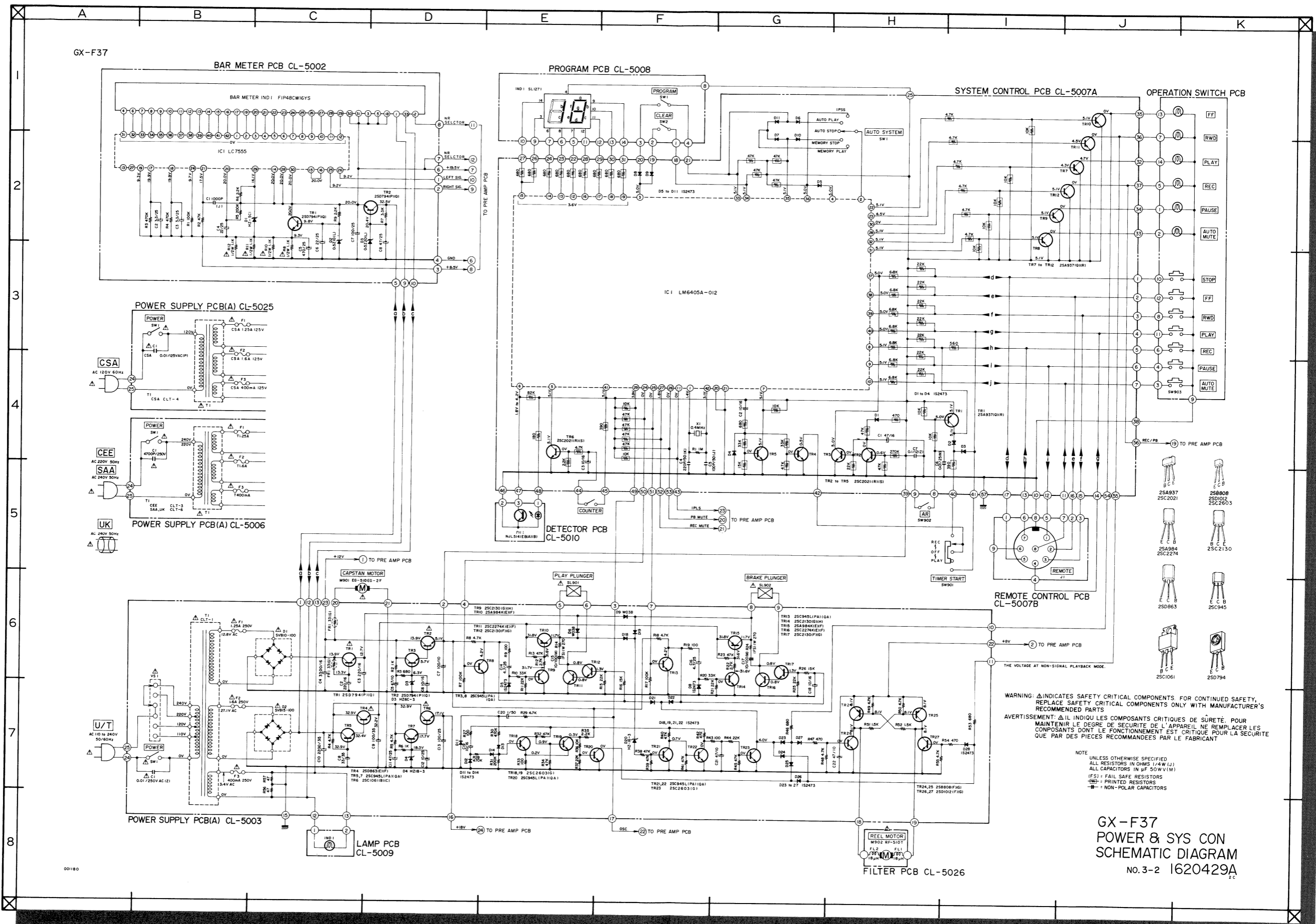

WARNING: Δ INDICATES SAFETY CRITICAL COMPONENTS. FOR CONTINUED SAFETY, REPLACE SAFETY CRITICAL COMPONENTS ONLY WITH MANUFACTURER'S RECOMMENDED PARTS.
 AVERTISSEMENT: Δ IL INDIQUE LES COMPOSANTS CRITIQUES DE SÛRETÉ. POUR MAINTENIR LE DEGRÉ DE SÛRETÉ DE L'APPAREIL NE REMPLACER LES COMPOSANTS DONT LE FONCTIONNEMENT EST CRITIQUE POUR LA SÛRETÉ QUE PAR DES PIÈCES RECOMMANDÉES PAR LE FABRICANT.

NOTE
 UNLESS OTHERWISE SPECIFIED
 ALL RESISTORS IN OHMS 1/4W (J)
 ALL CAPACITORS IN μF 50V (M)
 (FS) = FAIL SAFE RESISTORS
 (P) = PRINTED RESISTORS
 (N) = NON-POLAR CAPACITORS

GX-F37
 POWER & SYS CON
 SCHEMATIC DIAGRAM
 No. 3-2 1620429A

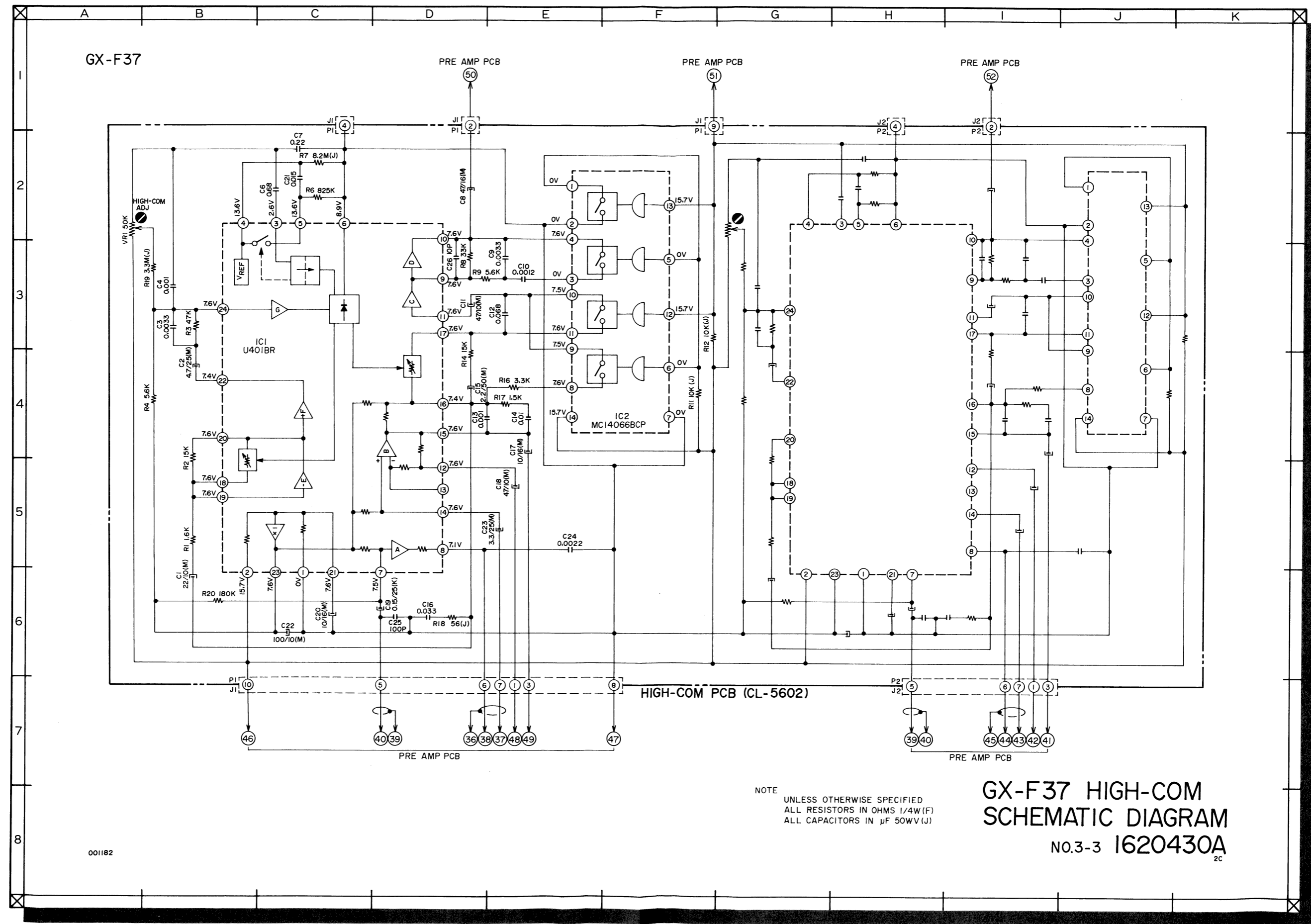

**GX-F37 HIGH-COM
 SCHEMATIC DIAGRAM**
 NO.3-3 1620430A
 2c

001182