

SERVICE MANUAL

AKAI TAPE RECORDER

MODEL M-10

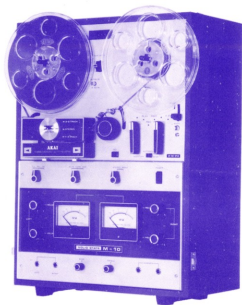

TABLE OF CONTENTS

I.	SPECIFICATIONS	1
II.	MEASURING METHOD	2
III.	CONTROL LOCATIONS	4
IV.	DISMANTLING OF TAPE TRANSPORT UNIT & AMPLIFIERS	5
V.	TRANSPORT MECHANISM	7
VI.	MECHANISM ADJUSTMENT	11
VII.	AMPLIFIER ADJUSTMENT	19
VIII.	MAINTENANCE PROCEDURES	21
IX.	COMPOSITE VIEWS OF COMPONENTS	22
X.	TROUBLE SHOOTING CHART	25
XI.	SCHEMATIC DIAGRAM	

I. SPECIFICATIONS

STYLE	: Portable	MONITOR SYSTEM	: The program being recorded can be monitored by using: Stereo Headphone (8 Ohms) Stereo Headphone Jack. Crystal Receiver - Line Output Jack.
WEIGHT	: 37.4 lbs (17 kg)	MOTORS	
DIMENSIONS	: 14" x 14" x 8-7/8" (358 x 358 x 227 mm)	CAPSTAN MOTOR	: Hysteresis Synchronous 3-speed (2-4-pole) motor Condenser Capacity 3 μ F (50 Hz) 2 μ F (60 Hz)
POWER SUPPLY	: AC 100 to 240 V, 50/60 Hz	Revolution	: 3,000 - 1,500 750 r.p.m. (50 Hz) 3,600 - 1,800 900 r.p.m. (60 Hz)
RECORDING SYSTEM	: In-line 4-track stereo, monaural recording by using Cross-field Bias Head.	REEL MOTOR	: 2 \times 12, outer-rotor motors. Revolutions : 930 r.p.m. at 50 Hz 100 V 1,120 r.p.m. at 60 Hz 110 V
PLAYBACK SYSTEM	: In-line 4-track stereo, monaural playback.	HEADS	
TAPE SPEED	: 1-7/8, 3-3/4 and 7-1/2 ips.	REC/PLAY HEAD	: In-line 4-track stereo and monaural Impedance . . . 1,200 Ohms at 1,000 Hz. Cap 2/1,000 mm
TAPE SPEED DEVIATION	: Within \pm 0.8%	ERASE HEAD	: In-line 4-track stereo Impedance 500 Ohms at 60 KHz. Gap 0.2 mm
WOW AND FLUTTER (Play back only)	: Less than 0.1% r.m.s. at 7-1/2 ips. Less than 0.2% r.m.s. at 3-3/4 ips. Less than 0.3% r.m.s. at 1-7/8 ips.	BIAS HEAD	: In-line 4-track stereo Impedance 500 Ohms at 60 KHz. Gap 0.2 mm
FREQUENCY RESPONSE	: 30 to 25,000 Hz \pm db at 7-1/2 ips. 30 to 18,000 Hz \pm db at 3-3/4 ips. 40 to 9,000 Hz \pm 4 db at 1-7/8 ips.	RECORDING LEVEL INDICATOR	: VERTICAL Indication VU Meter \times 2
SIGNAL TO NOISE RATIO	: Better than 48 db (Forward Operation) Better than 45 db (Reverse Operation)	TRANSISTOR & IC USED	: 2 8CAA-072D 4 2SD92 2 29C458 (B) 7 29C372 4 29C693FU 4 29C971 1 2SD223
DISTORTION	: Within 3% at Line Output, 1,000 Hz O VU Recording and Playback.	DIODE USED	: 1 5B-3-01P 3 1N34A 1 10D4 1 5B2 4 V06C 1 RD24A (M)
CROSS TALK	: Less than -65 db (Monaural) Less than -43 db (Stereo)	REELS USED	: 7", 5", 3" reels 10-1/2" Reel Adaptor available (optional accessory)
ERASE RATIO	: Less than -70 db		
INSULATION RESISTANCE	: More than 50 M.Ohms		
INSULATION DURABILITY	: 500 V. AC for more than one minute duration.		
LINE OUTPUT	: Output Impedance 100 Ohms. Required load impedance more than 25 K.Ohms. 1.23 V (+4 db) 8 Watts (r.m.s.) per channel, total 16 watts (External Speaker Jack) Impedance 8 ohms		
DIN OUTPUT	: 0.4 V Output Impedance 10 K.Ohms. Required load impedance more than 50 K.Ohms.		
LINE INPUT	: Above 50 mV (-25 db) Impedance 175 k.Ohms.		
DIN INPUT	: High Above 50 mV (-25 db) Impedance 150 mV (-45 db) Low Above 5 mV (-45 db) Impedance 27 K.Ohms.		
MIC. INPUT	: Above 0.5 mV (-65 db) Impedance 4.7 K.Ohms.		
FAST FORWARD AND REWIND TIME	: 85 seconds for a full 1,200 foot tape at 50 Hz. 65 seconds for a full 1,200 foot tape at 60 Hz.		

II. MEASURING METHOD

TAPE SPEED DEVIATION

1. Method involving use of pre-recorded tape.
For measuring the tape speed deviation, play back the pre-recorded tape at 1,000 Hz \pm 0.1%. Connect the appropriate output to a frequency counter meter in order to measure the tape speed deviation from the resulting deviation of the measured frequency.

2. Method involving use of timing tape. (designed for tape speed measurement)

This method utilizes a timing tape marked at intervals of 7-1/2". The running time of over 60 marked sections of tape is measured in order to calculate the deviation of the tape speed. In applying this method, however, it should be kept in mind that the timing tape stretch or contract measurement error is inevitable, so that it is necessary to measure the total length of the tape in advance.

WOW AND FLUTTER

Playback the 3,000 Hz pre-recorded tape of which the wow and flutter level is guaranteed to be smaller than 0.07% for measurement by means of a wow meter. It is also possible for a 3,000 Hz sine wave to be recorded and played for measurement by means of the wow meter. In this case, however, the wow meter indicates a value as much as twice the value given in the specifications on the first page.

FREQUENCY RESPONSE

RECORD :

- 1) Give a sine wave of 1,000 Hz to the Line Input of the recorder to be tested through an attenuator from an audio frequency generator.
- 2) Set the Record/Playback Knob to "Rec" position and adjust the line input volume so that the VU Meter needle indicates "0" VU.
- 3) Set the Equalizer Switch to 7-1/2" or 3-3/4" position.
- 4) Under the condition described in (2), lower the input level 16 db by means of the attenuator.
- 5) Record the spot frequency in the range of 30 Hz to 25,000 Hz from the audio frequency generator.

PLAYBACK :

- 6) Set the Record/Playback Knob to "Play" position.
- 7) Connect a Vacuum Tube Volt Meter to the Line Output Jack. (VTVM with milli volt scale.)
- 8) Playback the recorded tape.
- 9) Playback the recorded spot frequencies and make a memo of output level and plot the value on a graph.



TOTAL HARMONIC DISTORTION FACTOR



Connect the measuring instrument as shown above, and record the 1,000 Hz sine wave a "0" VU. Playback the resulting signal and measure the overall distortion factor. Measure the noise level of the tape recorder with the tape removed; connect the audio oscillator directly to the distortion meter for measurement of the distortion factor of the oscillator.

The required distortion factor may be obtained from the results of the above measurement by the following formula :

$$d_0 = d - d_1 \quad d_2$$

where, d_0 = Required

d = Overall distortion factor

d_1 = Noise level

d_2 = Distortion factor of the oscillator

(Note : New tape of particularly good quality should be used for measurement of the distortion factor.)

SIGNAL TO NOISE RATIO



Set the Equalizer Switch to "7-1/2 ips" position and playback a tape containing a 25 Hz sine wave recorded at "0" VU level on a standard recorder. Connect a V.T.V.M. to the line output jack of the recorder and measure its output. Then remove the tape and measure the noise level under the same condition. Convert into decibels each of the measured values.

CROSSTALK (Crosstalk between the tracks)

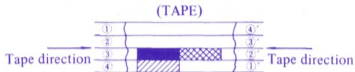

As shown in the figure, first record a 1,000 Hz sine wave on track No.3 at +3 VU level. Next, remove the 1,000 Hz input signal and record under a non-input condition. Then, Playback the tape on track No.3 and No. 1 (reversed condition of tape) through the 1,000 Hz B.P.F. (Band Pass Filter, Sensitivity 1 : 1) and obtain a ratio between the two from the following formula.

$$C = 20 \log \frac{E_0}{E_2 - E_1} \text{ (db)}$$

C = Desired crosstalk ratio (db)

E_0 = 1,000 Hz signal output level

E_2 = 1,000 Hz crosstalk output level

E_1 = Non-input signal record level



III. CONTROL LOCATIONS

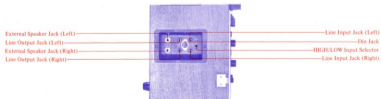
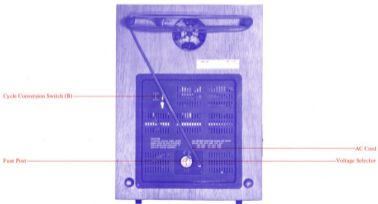
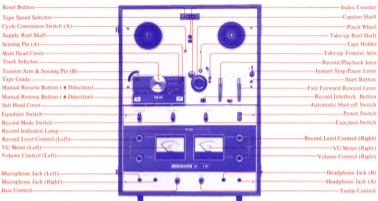

IV. DISMANTLING OF TAPE TRANSPORT UNIT & AMPLIFIERS

In case of trouble, etc, necessitating disassembly, please disassemble in the order shown in photographs. Remantle in reverse order.

DISASSEMBLY OF TAPE TRANSPORT

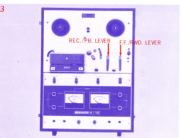
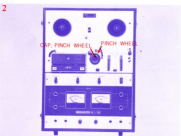
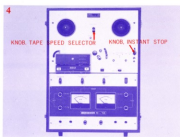

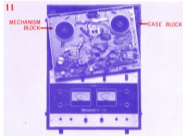
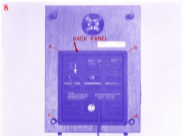
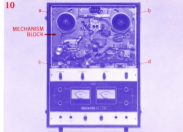
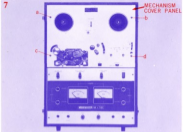

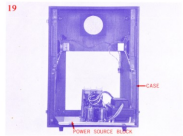
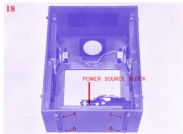
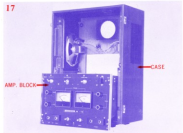
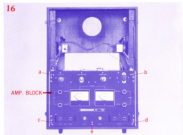
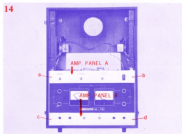
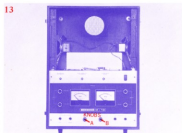
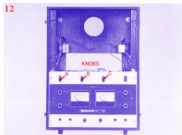

V. TRANSPORT MECHANISM

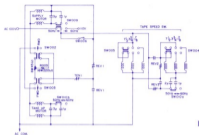

Fig. 5-1

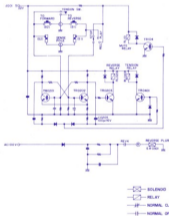

Fig. 5-2

1. SUPPLY VOLTAGE OF BOTH TORQUE MOTORS DURING RECORDING/PLAYBACK

	SUPPLY	TAKE-UP
Normal Play	30 V (50 to 60 gr)	60 W (180 gr)
First 4 to 8 Seconds	47 V (100 gr)	47 V (100 gr)
Reverse	60 V (180 gr)	30 V (50 to 60 gr)
RW/FF	100 V	100 V

2. PINCH ROLLER PRESSURE 1.5 Kgr TO 1.8 Kgr.

Recording/Playback (Normal Recording)

Set Recording/Playback Knob (A) to Playback Position. The Pinch Roller presses against Capstan to move the tape at the rated speed. The Brake Levers free the Brake and the Lever Spring (G) turns "ON" Microswitch (SW006) (F) so that both torque motors become operative (as shown in diagram illustration).

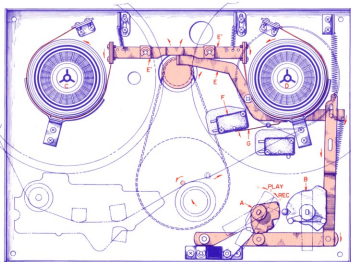

PLAYBACK / RECORDING / REVERSE

Fig. 5-3

3. REVERSE (BLOCK DIAGRAM ILLUSTRATION)

At Playback position, when Reverse button (B) is depressed or the sensing tape passes the sensing pole (S_1), the base of TR0202 is grounded. The operation of TR0202 is stopped and the voltage sent to the base of TR0203 and operates it. Reverse Relay RL0201 is actuated and Reverse is effected.

At the same time, the discharge current of Condenser C0205 (100M/16V) actuates TRO401 and TR104 which assume operating position within a period of from 4 to 8 seconds.

Tension Relay (RL0401) is actuated and a higher voltage than during reverse playback time (47 V) is supplied to the Take-Up torque motor. At the sametime Mute Relay (CRL1017) mutes the playback output signal.

Plunger (SR0301) operates and lowers the playback head.

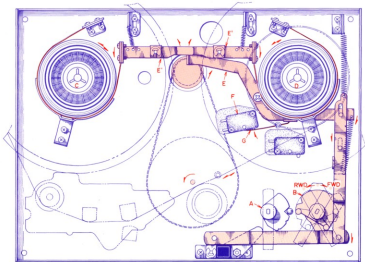

FAST - FORWARD / REWIND

Fig. 5-4

4. FAST FORWARD

When Fast Forward/Rewind Knob is set to Forward position, SW003 (block diagram) enters forward position. Brake Levers (E) free brake. Lever Spring (G) turns "ON" Microswitch (F) and the TAKE-UP Torque Motor rotates.

5. REWIND

When Fast Forward/Rewind Knob is set to Rewind position, SW002 (block diagram) enters rewind position. Brake Levers (E) free Brake. Lever Spring (G) turns "ON" Microswitch (F) and the SUPPLY Torque Motor rotates.

AUTOMATIC STOP MECHANISM

When the tape is threaded on pin (B), if the tape is accidentally broken or comes to the end, Automatic Stop Lever (A) drops to its original position.

When the tape is broken or comes to the end, Plate Spring (C), located below the Automatic Stop Lever, depresses a projected pin on Eccentric Gear (D). Eccentric Gear (D) gears into Flywheel (E) to begin rotation of the Eccentric Gear. This rotating action operates Lever (L), which is connected to the base of the Eccentric Gear, and pushes up Instant Stop Lever (G). When Instant Stop Lever (G) is lifted, Shut-Off Lever (J) contacts Micro Switch (K) and the current supply is cut off. Thus, automatic stop control is provided in Recording and Playback modes.

In Fast Forward and Rewind modes, the same operation takes place except that Lever (H) works to push back the FF, Rewind Shaft to "Stop" position.

(See Figs. 5-5 to 5-8)

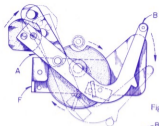
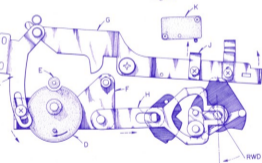

Fig. 5-5



Fig. 5-6



RWD Fig. 5-7

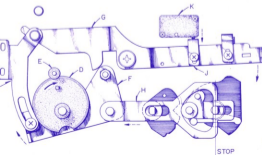

Fig. 5-8

VI. MECHANISM ADJUSTMENT

ILLUSTRATION OF 4TR X-FIELD HEAD

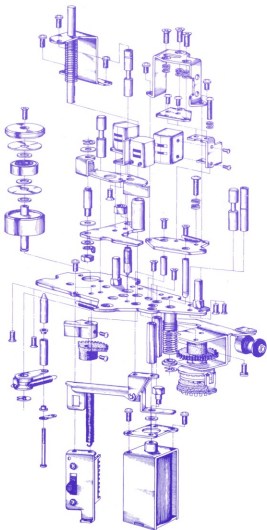

Fig. 6-1

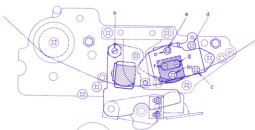

Fig. 6-2

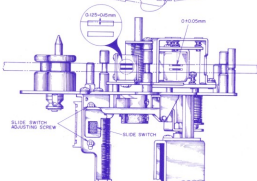

Fig. 6-3

1. ADJUSTMENT OF HEAD HEIGHT (SEE FIGURES 6-2 AND 3).

- 1) To adjust, turn screws (a) (b) (c) (Fig. 6-2) During "Normal Play" position so that the upper edge of the upper core of the Playback/Rec Head is the same height as the upper edge of the tape. Adjust by turning screw (d) (Fig. 6-2) during "Reverse Play" position so that the lower edge of the lower core of the Playback/Rec Head is the same height as the lower edge of the tape.

2) Erasing Head

Adjust screw (h) so that the upper edge of the upper core is 0.125 to 0.15 mm higher than the upper edge of the tape. In adjusting Head Height, make sure that the front of the Head is at right angles to the Chassis and that the upper and lower part of the Head firmly contacts the tape.

2. ADJUSTMENT OF AZIMUTH ALIGNMENT

- 1) Playback/Rec Head
Use a pre-recorded tape (16 KHz, 7-1/2 ips), and connect a high sensitivity V.T.V.M. to the line output jack. Adjust screws (c) (e) so that line output voltage is maximum.
- 2) Erasing Head
Visually check to assure that the center line of the Erasing Head is at right angles to the Head Chassis.

ILLUSTRATION OF REEL TABLE AND REEL MOTOR BLOCK

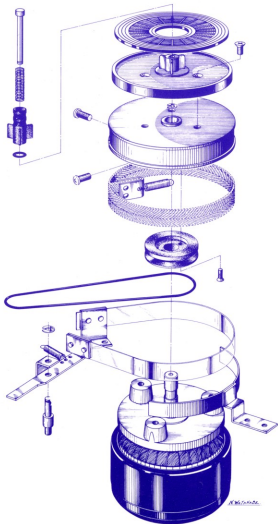

Fig. 6-4

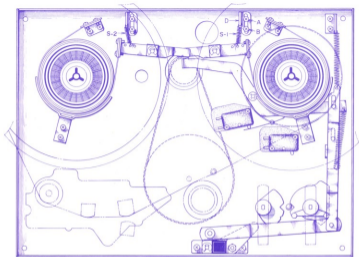

Fig. 6-5

BRAKE ADJUSTMENT

Using a Tension Gauge, and a 60 mm tape wound on a 5" Reel, measuring can be done as per drawing. Measure the brake tension as shown in the drawing, 300 gr is standard.

To regulate tension, change the position of the suspended springs (S₁ and S₂ in Fig. 6-5) or loosen screws (A) (B) and regulate position of the spring suspension metal fitting (D).

REEL HEIGHT ADJUSTMENT (SEE DIAGRAM ILLUSTRATION)

Loosen Reel Table Screws and regulate height.

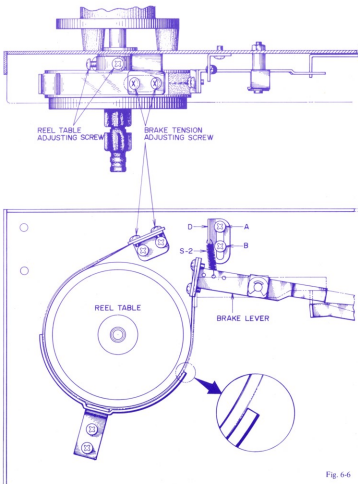

Fig. 6-6

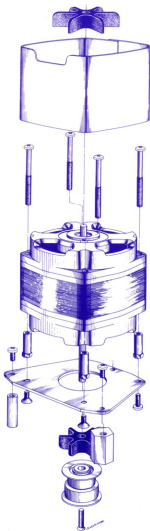

ILLUSTRATION OF SWITCH LEVER BLOCK

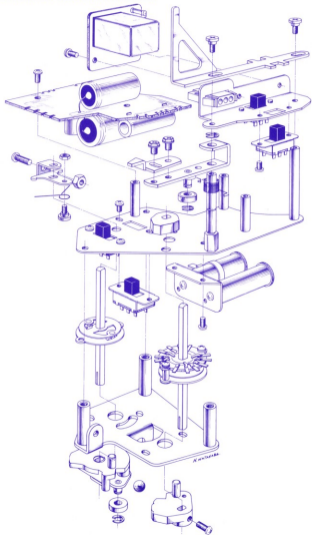

Fig. 6-8

ILLUSTRATION OF FLYWHEEL BLOCK

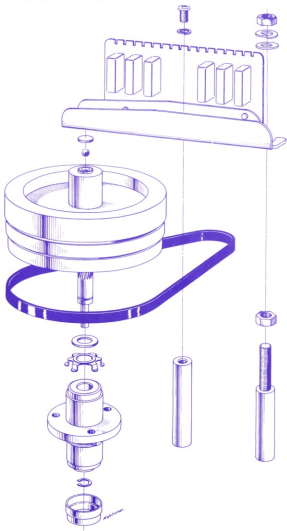

Fig. 6-9

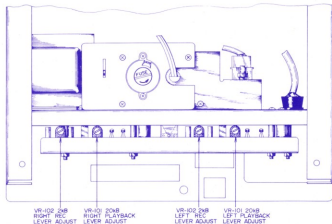

Fig. 7-1

1. PLAYBACK OUTPUT LEVEL (PRE-AMPLIFIER) ADJUSTMENT

- Connect a high sensitivity V.T.V.M. to the Line Output Jack.
- Set the Tape Speed Selector Switch to the "7-1/2" position.
- Playback at 250 Hz pre-recorded tape.
- Adjust the VR 101 (semi-fixed resistor 20 K-B, Fig. 7-1) of the pre-amplifier so that Line Output Voltage indicates 1.228 V (± 4 dbm).

2. ADJUSTMENT OF RECORDING LEVEL

Recording Amplifier Adjustment should be made only after Head Adjustment (vertical and horizontal azimuth) and Playback Amplifier Adjustments have been made.

- As shown in Fig. 7-2, connect an Audio Oscillator and Attenuator to the Line Input. Connect a High-sensitivity V.T.V.M. to the Line Output.
- Set Equalizer Switch and Tape Speed Selector to "7-1/2".
- Load a blank test tape (Scotch No. 150) on the tape recorder and set the Rec/Playback Knob to "Rec" position.
- Supply a 1000 Hz signal from the audio oscillator to the Line Input, and adjust the volume control so that the VU Meter indicates "0" VU (intermediate between red and black).
- Record the tape and check playback to see whether the VU Meter indicates "0" VU.
- If the pointer of the VU Meter fails to register "0" VU, repeat recording and playback by adjusting the semi-fixed resistor VR 102 (2 KB) on the recording pre-amplifier until the "0" VU reading is obtained both on recording and playback.



Fig. 7-2

3. ADJUSTMENT OF RECORDING BIAS FREQUENCY AND VOLTAGE

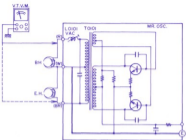

Fig. 7-3

Proper bias Frequency of the M-10 is 95 KC (± 5 KC). The frequency can be adjusted by converting the value of the condenser (C.104 1000p) and L0101 (VAC). Proper Bias Voltage is 105 V (± 2 V). The voltage can be adjusted by turning the V.A.C. (L0101) in the bias oscillator circuit.

Erasing Voltage is 90 V (± 5 db).

4. ADJUSTMENT OF D.C. BIAS CURRENT OF POWER OUTPUT TRANSISTORS WITH NO INPUT SIGNAL (SEE FIG. 7-4)

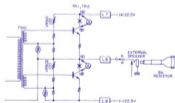

Fig. 7-4

- 1) Disconnect collector wire of Transistor TR1 and TR2
- 2) Connect the Ampere Meter (maximum scale 250 mA) to the collector circuit (a) and (b), (c) and (d)
- 3) Connect the 8 Ω resistor to the External speaker Jack
- 4) Turn the Volume control back to the minimum position

- 5) Adjust the potentiometer VR501 and VR502 (100 Ω) until the Collector Current reaches 35 ~ 40 mA

Caution: It is important that the potentiometer be adjusted so that both meters indicate equal levels.

5. ADJUSTMENT OF THE LEVEL CONTROL VR601



Fig. 7-5

- 1) Connect Audio Oscillator to the Line input and supply a 1000 Hz sine wave
- 2) Set Record Level control so that the VU meter indicate "0" VU
- 3) Connect 8 ohms (10 W) resistor to the External speaker Jack
- 4) Connect V.T.V.M. across 8 ohms resistor
- 5) Turn the Volume Control up to the maximum position
- 6) Adjust Level Control potentiometer so that Output Voltage reaches 8 volts.

VIII. MAINTENANCE PROCEDURES

1. LUBRICATION INSTRUCTION

For maximum service life and optimum performance, lubricate the parts identified below after each 500 hours of operation. Use only light machine oil of good quality;

Motor

Flywheel Assemble

Pinch Wheel 1 drop

Also apply a liberal film of light machine grease to each roller surface of all levers and cams.

CAUTION : DO NOT OVER-LUBRICATE. WIPE OFF EXCESS OIL WITH A COTTON SWAB SOAKED IN ALCOHOL. OTHERWISE, THE EXCESS LUBRICANT MAY BE SCATTERED DURING OPERATION, AND THE RUBBER COMPONENT PARTS WILL DETERIORATE.

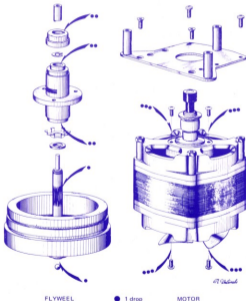

2. CLEANING TAPE HEADS AND OTHER PARTS

Wipe surface of tape heads, guide roller bearing, capstan bushing and pinch wheel periodically with a soft cloth soaked in alcohol or carbon-tet.

IX. COMPOSITE VIEWS OF COMPONENTS

PRE AMP. PRINTED CARD (MRA-501)

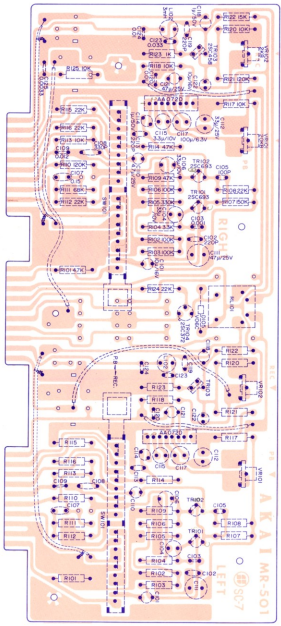

SYSTEM CONTROL PRINTED CARD (MR-504)

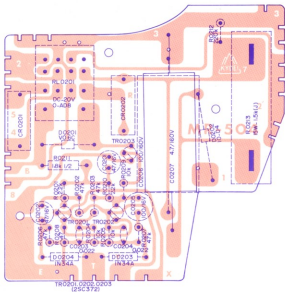

O.S.C. PRINTED CARD (MR-505)

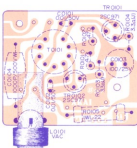

SPARK QUENCHER PRINTED CARD (MR-507)

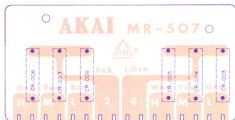

MAIN AMPLIFIER PRINTED CARD (MRA-508)

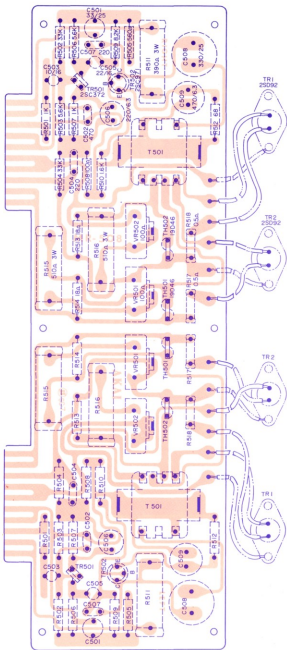

TONE CONTROL PRINTED CARD (MRA-509)

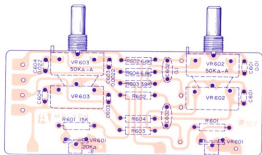

POWER SOURCE PRINTED CARD (MRA-510)

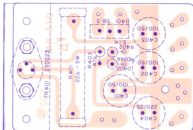

TENSION RELAY PRINTED CARD (MR-552, 558)

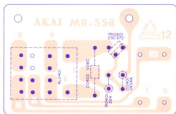
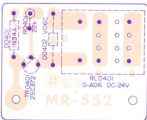

X. TROUBLE SHOOTING CHART

SECTION "A" TROUBLES WITH TAPE TRANSPORT MECHANISM



SECTION "B" TROUBLES WITH AMPLIFIER

I. Playback Mode

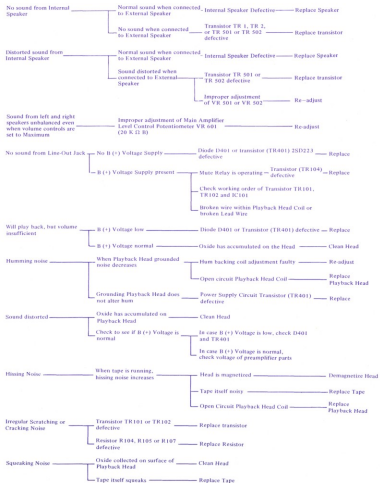



2. Recording Mode



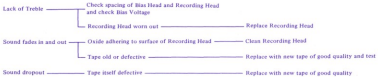

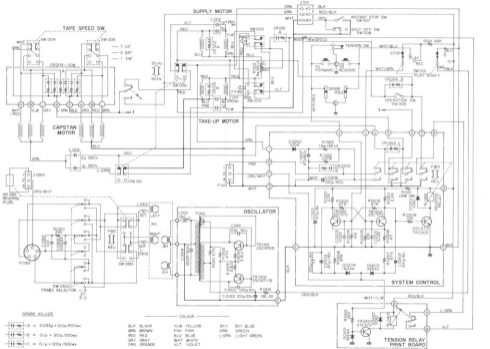

M-I-O MECHANISM SCHEMATIC DIAGRAM NO.2-1 I381654I

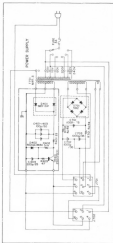
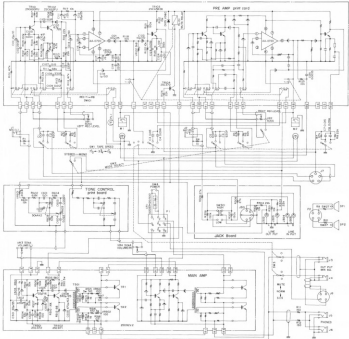

ALL RESISTOR 1/2 WATT UNLESS OTHERWISE NOTED.
 ALL CAPACITY µF UNLESS OTHERWISE NOTED.

**M-10 AMPLIFIER
 SCHEMATIC DIAGRAM**
 no. 2-2 13816560