

AKAI SERVICE MANUAL

S1000HD

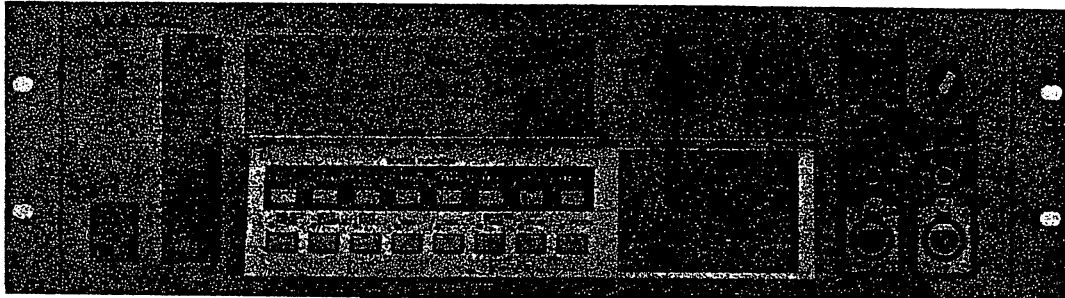

MIDI STEREO DIGITAL SAMPLER

MODEL S1000HD

SPECIFICATIONS

Display	320 characters graphic large display	STEREO OUT(L/mono & RCH)	-3 dBv/600 ohms
Disk drive	3.5 inch 2HD(2M bytes)	EFFECT SEND	-3 dBv/600 ohms
	3.5 inch 2DD(1M byte)	CH 1 to CH 8 OUT	-3 dBv/600 ohms
Internal memory	2M bytes	EFFECT RETURN(L & R CH)	-3 dBv/10k ohms
Data format	16 bit linear	Connectors	
Maximum number of samples	200	Front panel	REC INPUT
Maximum number of programs	100		CANON PLUG x2(L ch., R ch.)
Sampling rate	44.1/22.05 kHz, switchable		MIC PLUG x2(Lch., R ch.)
Sampling time	23.76 sec.(mono/sampling rate 44.1 kHz)	Rear panel	STEREO HEADPHONE x1
	47.52 sec.(mono/sampling rate 22.05 kHz)		STEREO OUT x2, EFFECT SEND x1, ASSIGNABLE MIX OUT x8, EFFECT RETURN x2, FOOT SW x1, MIDI IN x1, MIDI OUT x1, MIDI THRU x1
	11.88 sec.(stereo/sampling rate 44.1 kHz)	Power requirement	AC 100 v, 50/60 Hz for JAPAN
	23.76 sec.(stereo/sampling rate 22.05 kHz)		AC 120 v, 60 Hz for USA and canada
Frequency response	20 Hz to 20 kHz(sampling rate 44.1 kHz)		AC 220 v, 50 Hz for europe except UK
	20 Hz to 10 kHz(sampling rate 22.05 kHz)	Power consumption	17 w without option
Pitch shift	Interpolation and decimation digital algorithm(24 bit algorithm/custom LSI)	Dimensions	482.6(W)x132.6(H)x425(D) mm(EIA 3U RACK)
Filter	2 octave changeable, 1 cent/step	Weight	9.5 kg
Envelope generator	Digital moving low pass filter(-18 dB/oct)	Options	
Levels/impedance	2 sets/digital algorithm	EXM005	Memory expansion board(2M bytes)
REC INPUT	HI: -58 dBm	IB102	ATARI hard disk interface board
(CANON/MIC PLUG)	MID: -38 dBm	IB103	SCSI interface board
LOW: -18 dBm		IB104	Digital audio interface board
		BL1000	3.5 inch 2HD blank disk
		SL1001-	Sound library for S1000PB

* For improvement purposes, specifications and design are subjected to change without notice.

★ SAFETY INSTRUCTIONS

PRECAUTIONS DURING SERVICING

- Parts identified by the Δ (*) symbol are critical for safety. Replace only with parts number specified.
- In addition to safety, other parts and assemblies are specified for conformance with such regulations as those applying to spurious radiation. These must also be replaced only with specified replacements.
Examples: RF converters, tuner units, antenna selector switches, RF cables, noise blocking capacitors, noise blocking filters, etc.
- Use specified internal wiring. Note especially:
 - Wires covered with PVC tubing
 - Double insulated wires
 - High voltage leads
- Use specified insulating materials for hazardous live parts. Note especially:
 - Insulation Tape
 - PVC tubing
 - Spacers (Insulating Barriers)
 - Insulation sheets for transistors
 - Plastic screws for fixing microswitch (especially in turntable)
- When replacing AC primary side components (transformers, power cords, noise blocking capacitors, etc.), wrap ends of wires securely about the terminals before soldering.

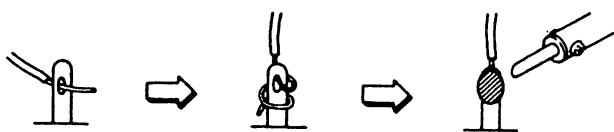

- Observe that wires do not contact heat producing parts (heatsinks, oxide metal film resistors, fusible resistors, etc.).

- Check that replaced wires do not contact sharp edged or pointed parts.
- Also check areas surrounding repaired locations.
- Use care that foreign objects (screws, solder droplets, etc.) do not remain inside the set.

SAFETY CHECK AFTER SERVICING

After servicing, make measurements of leakage-current or resistance in order to determine that exposed parts are acceptably insulated from the supply circuit.

The leakage-current measurement should be done between accessible metal parts (such as chassis, ground terminal, microphone jacks, signal-input/output connectors, etc.) and the earth ground through a resistor of 1500 ohms paralleled with a 0.15 μ F capacitor, under the unit's normal working conditions. The leakage-current should be less than 0.5 mA rms AC.

The resistance measurement should be done between accessible exposed metal parts and power cord plug prongs with the power switch (if included) "ON". The resistance should be more than 2.2 Mohms.

PRECAUTIONS FOR LITHIUM BATTERY

The lithium battery may explode when heated excessively. [OBSERVE THE FOLLOWING WHEN REPLACING]

- replace with the same make and type only.
- Use soldering iron in "recommended way" only.
- Place battery in correct polarity.
- Do not short the terminals.
- Do not recharge battery.
- Do not dispose of battery in fire.



[DANGER]



[RECOMMENDED WAY]

★ INFORMATION

SYMBOLS FOR PRIMARY DESTINATION

Alphabet indicates the destination of the units as listed below.

Symbols	Principal Destinations
A	USA
B	UK
C	Canada
E	Europe (except UK)
J	Japan
S	Australia
V	W. Germany only
U	Universal Area
Y*	Custom version

I. CONTROL

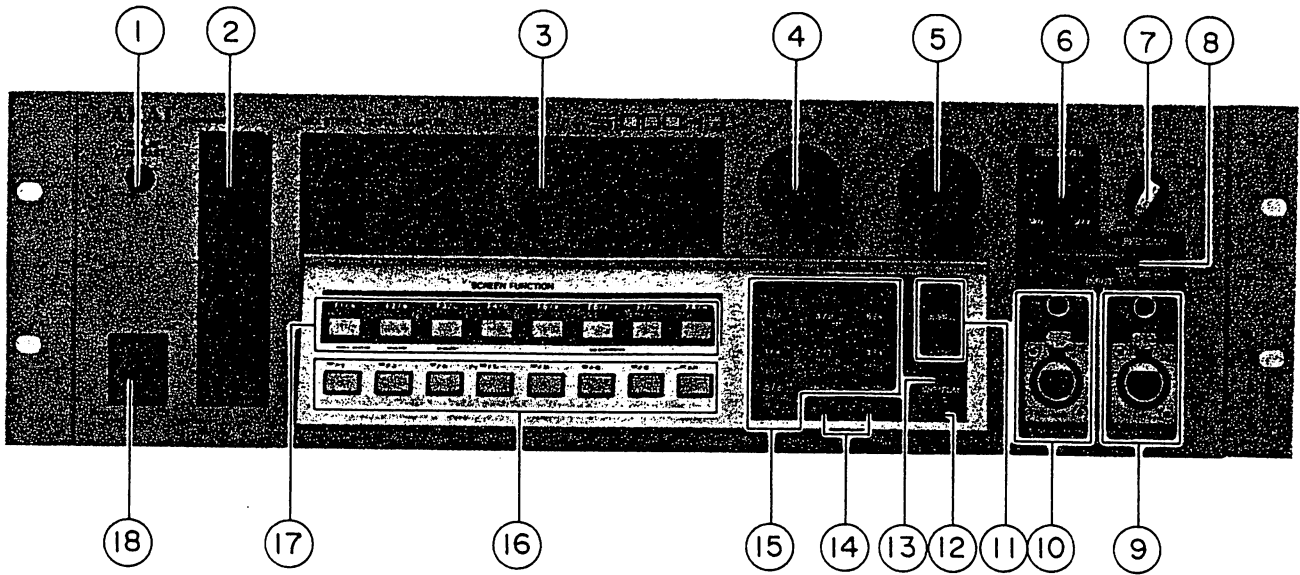
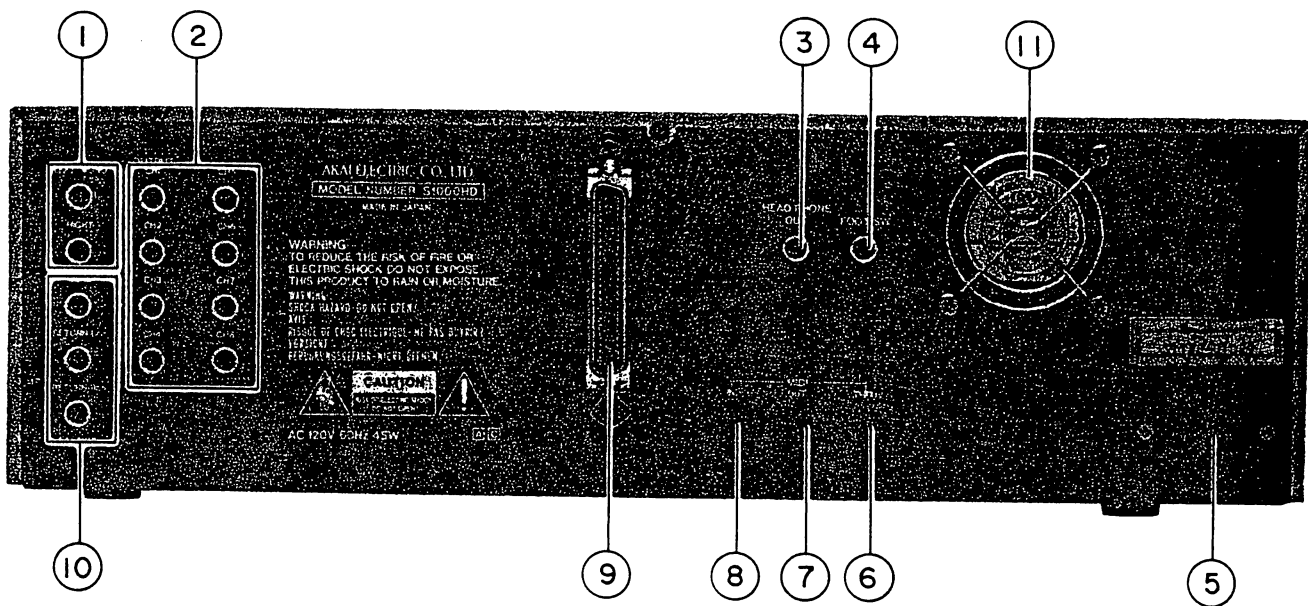

Fig. 1-1 Front panel

- | | |
|-----------------------------------|--------------------------|
| ① DISPLAY CONTRAST volume | ⑩ L ch. REC IN terminals |
| ② FLOPPY DISK DRIVE | ⑪ MARK and JUMP keys |
| ③ LCD screen | ⑫ ENT/PLAY key |
| ④ CURSOR control knob | ⑬ NAME key |
| ⑤ DATA control knob | ⑭ +/- <, -/> keys |
| ⑥ REC LEVEL control knob | ⑮ Numeric data keys |
| ⑦ MAIN VOLUME control | ⑯ Function keys |
| ⑧ REC GAIN(Low, MID, HI) selector | ⑰ Soft keys |
| ⑨ R ch. REC IN terminals | ⑱ POWER switch |



- ① Stereo output terminals (L CH./MONO, R CH.)
- ② Assignable output terminals (CH. 1 to CH. 8)
- ③ HEAD PHONE OUT terminal
- ④ FOOT SW terminal
- ⑤ AC inlet terminal
- ⑥ MIDI THRU(through) terminal
- ⑦ MIDI OUT terminal
- ⑧ MIDI IN terminal
- ⑨ SCSI terminal
- ⑩ EFFECT SEND and RETURN (L CH., R CH.) terminals
- ⑪ Fan

II. DISASSEMBLY

In case of trouble, etc. necessitating dismantling, please dismantle in the order shown in the photographs. Reassemble in the reverse order.

1. Removal of UPPER COVER

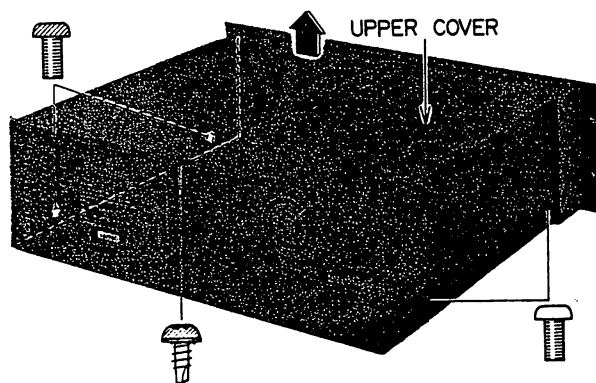

2. Removal of HARD DISK BLK

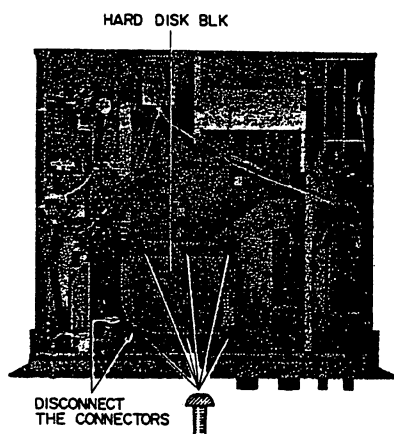

3. Removal of HARD DISK BASE

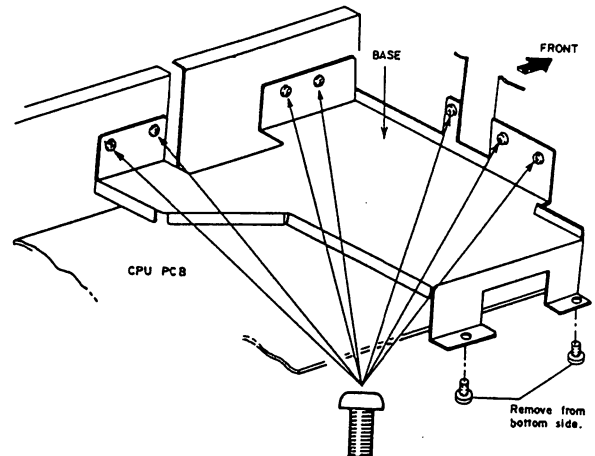

4. Removal of FRONT PANEL BLK

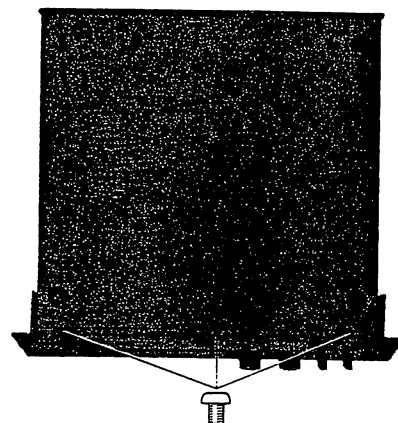

5.

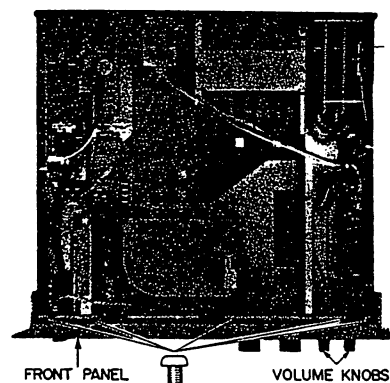

* Remove MAIN VOLUME and REC LEVEL knobs first, then remove the FRONT PANEL.

[NOTE]: Keep the disk from the dust, do not loosen any screws in the HARD DISK block.

III. PRINCIPAL PARTS LOCATION

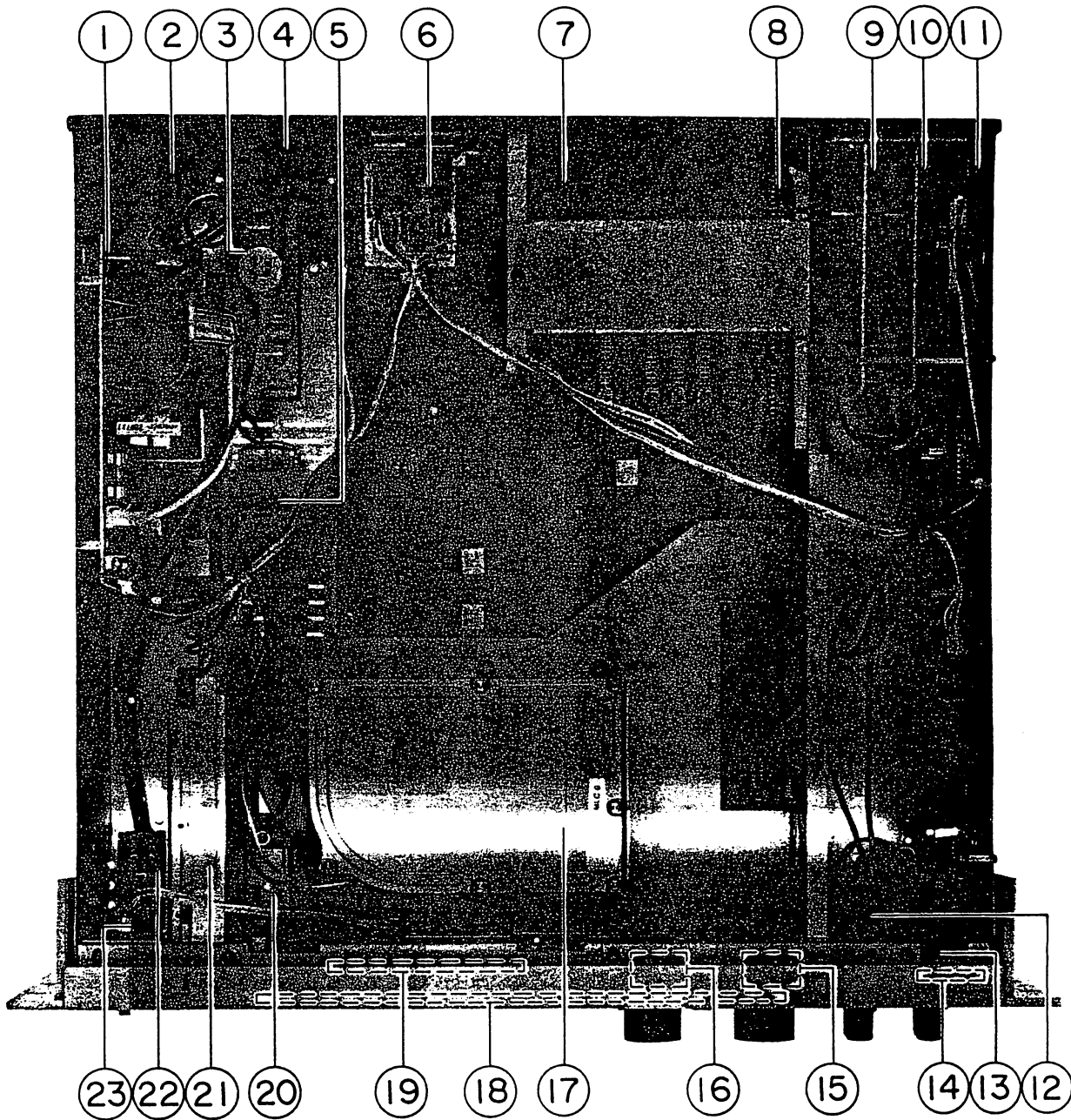

Fig. 3-1

- | | |
|---------------------------|-----------------------------------|
| ① SWITCHING REGULATOR BLK | ⑬ GAIN SW PCB |
| ② AC INLET | ⑭ REC IN(R ch.) CANON TYPE SOCKET |
| ③ FILTER PCB | ⑮ REC IN(L ch.) CANON TYPE SOCKET |
| ④ POWER TRANSFORMER | ⑯ ROTARY ENCODER (DATA) |
| ⑤ JACK (D) PCB | ⑰ ROTARY ENCODER (CURSOR) |
| ⑥ S1000HD SCSI PCB | ⑱ HARD DISK BLK |
| ⑦ MEMORY PCB | ⑲ PANEL PCB |
| ⑧ JACK (B) PCB | ⑳ LCD BLK |
| ⑨ JACK (A) PCB | ㉑ EL INV PCB |
| ⑩ VOICE PCB | ㉒ FDD BLK |
| ⑪ JACK (C) PCB | ㉓ POWER SW PCB |
| ⑫ VOLUME PCB | ㉔ CONTRAST VR PCB |

IV. ELECTRICAL ADJUSTMENT

4-1. INSTRUMENT CONNECTION

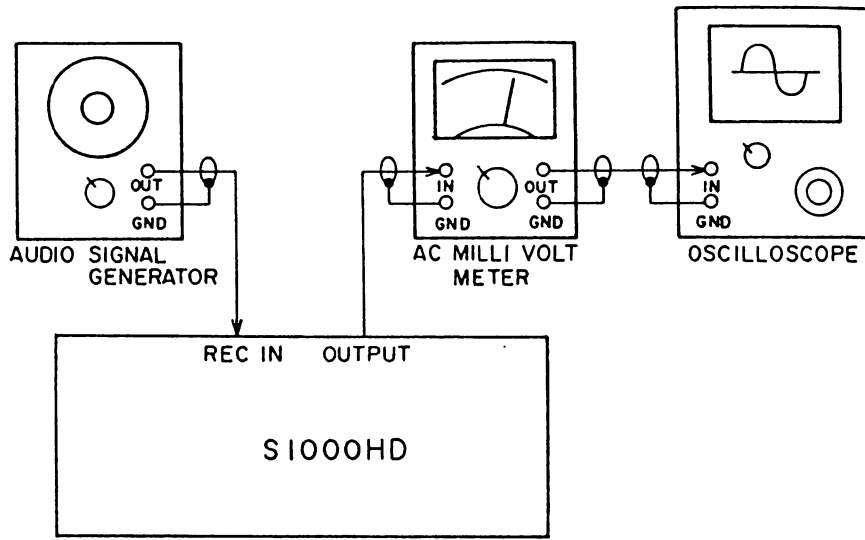
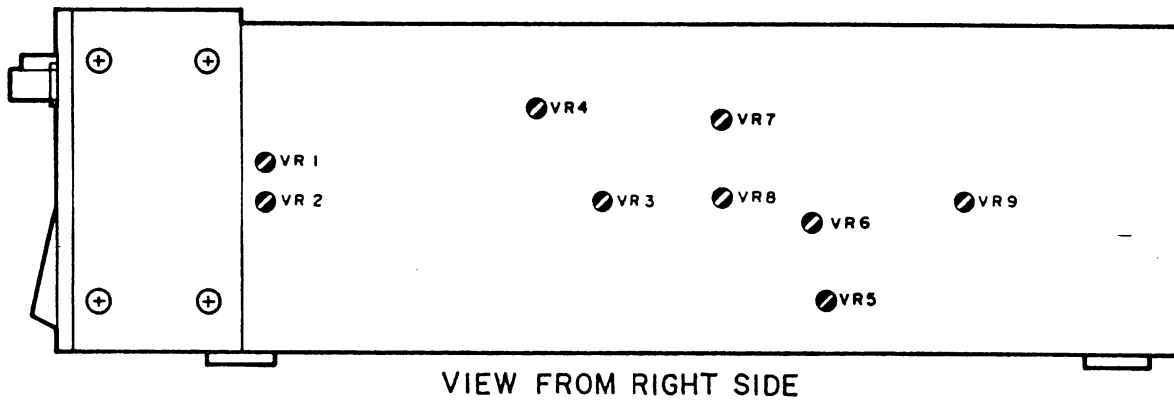

Fig. 4-1 Instrument connection

4-2. LOCATION OF ADJUSTMENT POINTS



VIEW FROM RIGHT SIDE

VR1: L CH ADC OFF SET NULL
VR2: R CH ADC OFF SET NULL
VR3: ADC MSB TRIM
VR4: ADC CLOCK
VR5: DAC MSB TRIM

VR6: ADC OUTPUT OFF SET TRIM
VR7: LCH. OUTPUT OFF SET TRIM
VR8: RCH. OUTPUT OFF SET TRIM
VR9: ECHO OUTPUT OFF SET TRIM

Fig. 4-2 View from right side

4-3 HARDWARE TEST

ABOUT THE HARDWARE TEST MODE

*This test mode used for adjustment and inspecting the unit.

[HOW TO SET THE HARDWARE TEST MODE]

- 1) Turn on the power, press the "MARK/#" and "NAME" buttons at the same time(all red indicators will light), then press the "+/◀" button.
- 2) The following menu(refire to Fig. 4-3) will appear on the LC-display when the model S1000HD is set to the HARDWARE TEST mode.

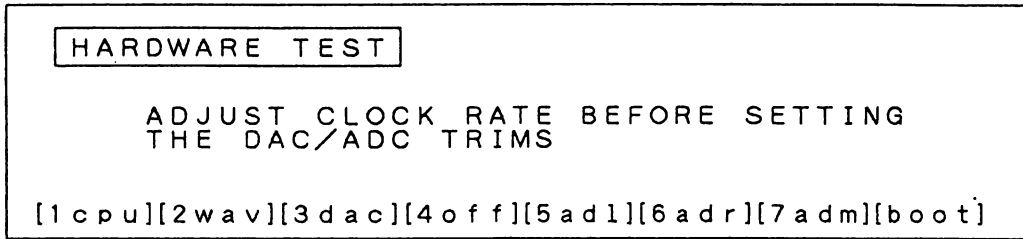

Fig. 4-3

- 3) If the model S1000HD is unable to record, check and adjust the CLOCK RATE befor carrying out the following adjustment.

[THE PROGRAM NAMES AND CORRESPONDING VR NUMBERS FOR EACH HARDWARE TEST]

S1000HD HARDWARE TEST

PRG. NO	VR No.	CONTENTS
1	—	CPU MEMORY TEST
2	—	WAVEFOME MEMORY TEST
3	VR 5	DAC MSB ADJUSTMENT
	VR 6	DAC OUTPUT OFF-SET ADJUSTMENT
4	VR 7	LEFT OUTPUT OFF-SET ADJUSTMENT
	VR 8	RIGHT OUTPUT OFF-SET DAJUSTMENT
	VR 9	EFFECT SEND OUTPUT OFF-SET ADJUSTMENT
5	VR 1	LEFT ADC OFF-SET NULL
6	VR 2	RIGHT ADC OFF-SET NULL
7	VR 4	ADC CLOCK TRIM
	VR 3	ADC MSB TRIM

Fig. 4-4 Hardware test and adjustment

[HOW TO RELEASE FROM THE HARDWARE TEST MODE]

- 1) During the HARDWARE TEST mode, press the "F8/H" button.

4-3-1. CPU MEMORY TEST

1) During the HARDWARE TEST mode, press the "F1/A" button. The following menu will appear on the LC-display(refer to Fig. 4-5).

```

HARDWARE TEST 1. CPU MEMORY TEST
BANK DATA>1514131211109876543210 RESULT
 1          .....
 2          .....

[1cpu][2wav][3dac][4off][5ad1][6adr][7adm][boot]
    
```

Fig. 4-5

2) A few second later, the LC-display will show the message "OK" as in Fig. 4-6. If the message "OK" does not appeared on the LC-display, this meaning is a malfunction in the memory circuit. In this case check the memory circuit and LSI.

```

HARDWARE TEST 1. CPU MEMORY TEST
BANK DATA>1514131211109876543210 RESULT
 1          ..... OK
 2          ..... OK

[1cpu][2wav][3dac][4off][5ad1][6adr][7adm][boot]
    
```

Fig. 4-6

4-3-2. WAVEFORM MEMORY TEST

1) During the HARDWARE TEST mode, press the "F2/B" button. The following menu will appear on the LC-display(refer to Fig. 4-7).

```

HARDWARE TEST 2. WAVEFORM MEMORY TEST
BANK DATA>1514131211109876543210 RESULT
 1          ..... testing 35sec
 2          EEEEEEEEEEEEEEEEEEE
 3          EEEEEEEEEEEEEEEEEEE
 4          EEEEEEEEEEEEEEEEEEE

[1cpu][2wav][3dac][4off][5ad1][6adr][7adm][boot]
    
```

Fig. 4-7

2) After 35 seconds the LC-display will show the message as shown Fig. 4-8. If this message does not appeared on the LC-display, this meaning is a malfunction in the waveform memory circuit. Check the waveform memory circuit and LSI.

```

HARDWARE TEST 2. WAVEFORM MEMORY TEST
BANK DATA>1514131211109876543210 RESULT
 1          ..... OK
 2          EEEEEEEEEEEEEEEEEEE NO CARD?
 3          EEEEEEEEEEEEEEEEEEE NO CARD?
 4          EEEEEEEEEEEEEEEEEEE NO CARD?

[1cpu][2wav][3dac][4off][5ad1][6adr][7adm][boot]
    
```

Fig. 4-8

4-3-3. ADJUSTMENT OF DAC MSB TRIM

* Set the MAIN VOLUME to the maximum position hereafter.

- 1) During the HARDWARE TEST mode, press the "F3/C" button. The following menu appear on the LC-display(refer to Fig. 4-9). This indicates that the sinewave(30 Hz) has been loaded and DAC MSB adjustment mode is set.

```
HARDWARE TEST 3. DAC MSB TRIM

ADJUST DAC MSB TRIM FOR PUREST
30HZ SINEWAVE AT OUTPUT 1

[1cpu][2wav][3dac][4off][5ad1][6adr][7adm][boot]
```

Fig. 4-9

- 2) Connect an AC milli-voltmeter to the OUTPUT(CH 1) terminal on the rear panel, and connect an oscilloscope to the output terminal of the AC milli-voltmeter. Choose the range of the AC milli-voltmeter so that the waveform on the oscilloscope does not clip.

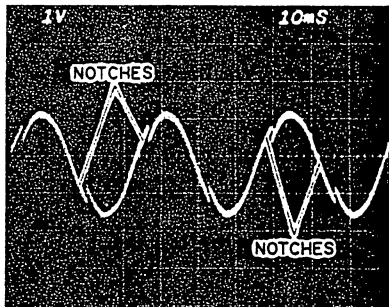

Fig. 4-10

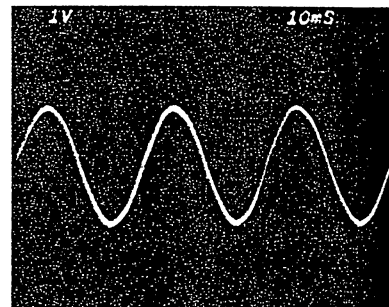

Fig. 4-11

- 3) If notches appear on the waveform as shown Fig. 4-10, adjust VR 5(DAC MSB) on the VOICE PCB(refer to Fig. 4-2), so that the notches on the waveform is disappeared as shown Fig. 4-11.

4-3-4. ADJUSTMENT OF OUTPUT OFF-SET TRIM

- 1) During the HARDWARE TEST mode, press the "F4/D" button. The following menu will appear on the LC-display(refer to Fig. 4-12). This indicate that the OUTPUT OFF-SET adjustment is set.

```
HARDWARE TEST 4. OUTPUT OFFSET TRIM

ADJUST TRIMS FOR MINIMUM 500HZ TONE :-
a.   ADC OUTPUT OFFSET : OUTPUT 1
b.   LEFT OUTPUT OFFSET : LEFT OUTPUT
c.   RIGHT OUTPUT OFFSET : RIGHT OUTPUT
d.   ECHO OUTPUT OFFSET : ECHO OUTPUT

[1cpu][2wav][3dac][4off][5ad1][6adr][7adm][boot]
```

Fig. 4-12

- 2) Connect an AC milli-voltmeter to the OUTPUT(CH 1) terminal and connect an oscilloscope to the output terminal of the AC milli-voltmeter.

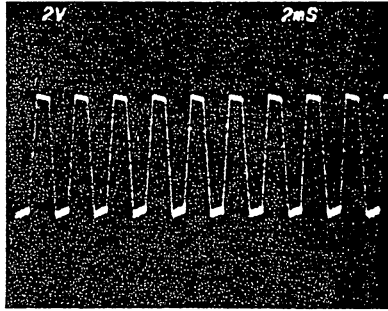

Fig. 4-13

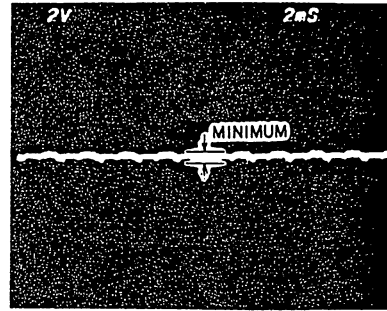

Fig. 4-14

- 3) Adjust VR 6(DAC OUTPUT OFF-SET) on the VOICE PCB(refer to Fig. 4-2), so that the levels on the oscilloscope and AC milli-voltmeter are minimum(refer to Fig. 4-14).

4-3-5. ADJUSTMENT OF LEFT OUTPUT OFF-SET TRIM

- 1) Connect an AC milli-voltmeter to the LEFT OUTPUT terminal and connect an oscilloscope to the output terminal of the AC milli-voltmeter.
- 2) Adjust VR 7(LEFT OUTPUT OFF-SET) on the VOICE PCB(refer to Fig. 4-2), so that the levels on the oscilloscope and AC milli-voltmeter are minimum(refer to Fig. 4-14).

4-3-6. ADJUSTMENT OF RIGHT OUTPUT OFF-SET TRIM

- 1) Connect an AC milli-voltmeter to the RIGHT OUTPUT terminal and connect an oscilloscope to the output terminal of the AC milli-voltmeter.
- 2) Adjust VR 8(RIGHT OUTPUT OFF-SET) on the VOICE PCB(refer to Fig. 4-2), so that the levels on the oscilloscope and AC milli-voltmeter are minimum(refer to Fig. 4-14).

4-3-7. ADJUSTMENT OF EFFECT SEND OFF-SET TRIM

- 1) Connect an AC milli-voltmeter to the EFFECT SEND OUTPUT terminal and connect an oscilloscope to the output terminal of the AC milli-voltmeter.
- 2) Adjust VR 9(EFFECT SEND OUTPUT OFF-SET) on the VOICE PCB(refer to Fig. 4-2), so that the levels on the oscilloscope and AC milli-voltmeter are minimum(refer to Fig. 4-14).

4-3-8. ADJUSTMENT OF ADC OFF-SET TRIM

- 1) During the HARDWARE TEST mode, press the "F5/E" button. The following menu will appear on the LC-display(refer to Fig. 4-15).

```

HARDWARE TEST 5. LEFT ADC OFFSET NULL
SET MIN. REC. LEVEL. LOW GAIN. SHORT INPUTS
ADJUST LEFT INPUT OFFSET TRIM
TO ZERO THE OFFSET: - _____ 0 _____
                        +1           ↑
[1cpu][2wav][3dac][4off][5ad1][6adr][7adm][boot]
  
```

Fig. 4-15

- 2) Set the REC LEVEL to the maximum position and the REC GAIN switch to the "LOW" position.
- 3) Adjust VR 1(L ch. ADC OFF-SET) on the VOICE PCB, so that the arrow(↑) on the LC-display is aligned with "0"(center position).
- 4) Next, press the "F6/F" button. The following menu will appear on the LC-display(refer to Fig. 4-16).

```

HARDWARE TEST 6. RIGHT ADC OFFSET NULL
SET MIN. REC. LEVEL, LOW GAIN, SHORT INPUTS
ADJUST RIGHT INPUT OFFSET TRIM
TO ZERO THE OFFSET: -      0
                        +1  ↑
[1cpu][2wav][3dac][4off][5ad1][6adr][7adm][boot]
  
```

Fig. 4-16

- 5) Adjust VR 2(R ch. ADC OFF-SET) on the VOICE PCB, so that the arrow() on the LC-display is aligned with the "0"(center position).

4-3-9. ADJUSTMENT OF ADC MSB AND CLOCK TRIMS

- 1) During the HARDWARE TEST mode, press the "F7/G" button. The following menu will appear on the LC-display(refer to Fig. 4-17).

```

HARDWARE TEST 7. ADC MSB TRIM
CONNECT 30HZ 40mV pp SINEWAVE TO
LEFT INPUT ON LOW GAIN
ADJUST REC. LEVEL FOR APPROX 1V pp
UNCLIPPED SINEWAVE AT OUTPUT 1.
SET ADC MSB TRIM FOR PUREST SINEWAVE
[1cpu][2wav][3dac][4off][5ad1][6adr][7adm][boot]
  
```

Fig. 4-17

- 2) Connect an audio signal generator(30Hz, 40mVp-p, sinewave) to the LEFT/MONO INPUT terminal and connect an oscilloscope to the OUTPUT CH 1 terminal.
- 3) Adjust the REC LEVEL control, so that the waveform on the oscilloscope is not clip at about 1 Vp-p). If the waveform 30Hz sine-wave is not appear on the oscilloscope, adjust VR 4(ADC CLOCK) on the VOICE PCB.

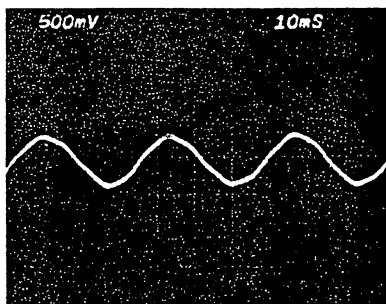

Fig. 4-18

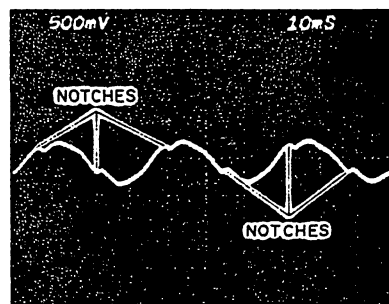

Fig. 4-19

- 4) If notches appear on the waveform on the oscilloscope as shown Fig. 4-19, adjust VR 3(ADC MSB) on the VOICE PCB, so that the correct sinewave is appeared as shown Fig. 4-18.

V. MIDI IMPLEMENTATION CHART

[MIDI DIGITAL SAMPLER]

Model S1000HD MIDI Implementation Chart Version : 1.0

FUNCTION	TRANSMITTED	RECOGNIZED	REMARKS
BASIC DEFAULT CHANNEL CHANGED	× ×	1 1 - 16	without Disk Memorized (Disk)
MODE MESSAGES ALTERED	× *****	Mode 3 Mode 1 - 4 Omni on/off,P/M ×	without Disk Memorized (Disk)
NOTE NUMBER : True voice	× *****	24 - 127 24 - 127	
VELOCITY NOTE ON NOTE OFF	× ×	○ 9n V=1 - 127 ○ 9n V=0 or × 8n V=0 - 127	used Velocity release
After KEY'S Touch CH'S	× ×	× ○	
PINCH BENDER	×	○	0 - 12 : Half tone step (7 bit)
CONTROL 1 CHANGE 7 64	× × ×	○ ○ ○	Modulation Wheel Volume Sustain pedal
PROG CHANGE : TRUE #	× *****	1 - 128 1 - 100	by Preset number value
SYSTEM EXCLUSIVE	○	○	AKAI ID : 47H S1000 ID : 48H
SYSTEM : SONG POS SONG SEL COMMON: TUNE	× × ×	× × ×	
SYSTEM : CLOCK REAL TIME : COMMANDS	× ×	× ×	
AUX : LOCAL ON/OFF ALL NOTES OFF MES- : ACTIVE SENSE SAGES : RESTE	× × × ×	× ○ (123) × ×	
Notes			

MODE 1 : OMNI ON, POLY
MODE 3 : OMNI OFF, POLY

MODE 2 : MONI ON, MONO
MODE 4 : 4MONI OFF, MONO

○=YES
×=NO

VI. PARTS LIST

ATTENTION

1. When placing an order for parts, be sure to list Part No., Model No. and the description of each part. Otherwise, the non-delivery of the part or the delivery of a wrong part may result.
2. Please make sure that Part No. is correct when ordering. If not, a part different from the one you ordered may be delivered.
3. Since the parts shown in Parts List of Preliminary Service Manual may have been the subject of changes, please use this Parts List for all future reference.

HOW TO USE THIS PARTS LIST

1. This Parts List lists those parts which are considered necessary for repairs. Other common parts, such as resistors and capacitors, are listed in the "Common List for Service Parts" from which these parts should be selected and stocked.
2. The Recommended Spare Parts List shows those parts in the Parts List which are considered particularly important for service.
3. Parts not shown in the Parts List and "Common List for Service Parts" will not in principle be supplied.
4. How to read the Parts List.

a) Mechanism Block

2. HEAD BASE BLOCK

REF. NO.	PART NO.	DESCRIPTION
1	BH-T2023A320A	HEAD BASE BLOCK
2	HP-H2206A010A	HEAD R/P PR4-8FU C
3	ZS-477876	PAN20×03STL CMT
4	ZS-536488	BID20×08STL CMT
5	ZG-402895	SP CS ANGLE ADJUST

↑ SP (Service Parts) Classification
 ↑ This number corresponds with the individual parts index number in that figure.

b) PC Board

6. MAIN PC BOARD

REF. NO.	PART NO.	DESCRIPTION
IC1	EI-324536	IC HD14049BP
IC2	EI-336801	IC MB8841-564M
C1A	EC-338399	C MMY V 223M 250AC [U,E,B,S]
C1B	EC-350949	C MMY V 223M 250DC [J]
C1C	EC-338397	C MMY V 223M 125AC [C,A]
X1	EI-318384	OSC X'TAL NC-18C

↑ Symbols for primary destination
 [A] : AAL (U.S.A) [S] : SAA (Australia)
 [B] : BEAB (England) [U] : U/T (Universa Area)
 [C] : CSA (Canada) Area
 [E] : CEE (Europe) [V] : VDE (W. Germany)
 [J] : JPN (Japan) [Y] : Custom Version

↑ SP (Service Parts) Classification
 These reference symbols correspond with component symbols in the Schematic Diagrams.

The available PC Board Blocks are listed separately.

5. When Part No. is known, Parts Index at end of Parts List can be used to locate where that part is shown in Parts List by its Reference No. listed at right of Part No.

WARNING

Δ(*) INDICATES SAFETY CRITICAL COMPONENTS. FOR CONTINUED SAFETY, REPLACE SAFETY CRITICAL COMPONENTS ONLY WITH MANUFACTURE'S RECOMMENDED PARTS.

AVERTISSEMENT

Δ(*) IL INDIQUE LES COMPOSANTS CRITIQUES DE SÉCURITÉ. POUR MAINTENIR LE DEGRÉ DE SÉCURITÉ DE L'APPAREIL, NE REMPLACER QUE DES PIÈCES RECOMMANDÉES PAR LE FABRICANT.

1. RECOMMENDED SPARE PARTS

Ref. No.	Part No.	Description	Ref. No.	Part No.	Description
1	BB-384741J	FLOPPY DISK DFP723F	64	EI-384778J	IC TC57512AD-15 S1000 V1.0-D
2	BB-387245J	HARD DISK ST-157	65	EI-384774J1	IC TC57512AD-15 S1000 V1.10-A
3	*BP-388946J	SW REGULATOR KFD40E-01A(H) [E,V,B,S]	66	EI-384775J1	IC TC57512AD-15 S1000 V1.10-B
4	*BP-389023J	SW REGULATOR KFD40E-01A(J) [J]	67	EI-360037	IC TC74HC00P
5	*BP-388947J	SW REGULATOR KFD40E-01A(L) [C,A,Y1]	68	EI-360039	IC TC74HC08P
6	*BT-384745J	TRANS POW S1000(C,A) [C,A]	69	EI-384789J	IC TC74HC10P
7	*BT-384746J	TRANS POW S1000(E,V,B,S) [E,V,B,S]	70	EI-360025	IC TC74HC138P
8	*BT-384744J	TRANS POW S1000(J) [J]	71	EI-356049	IC TC74HC139P
9	*BT-383935J	TRANS PULSE 2E16-1001-01	72	EI-360054	IC TC74HC174P
10	ED-359863	D LED LN81CV-(LF) AK ORANGE	73	EI-365101	IC TC74HC195P
11	*ED-330319	D SILICON DBA10B 100/1.0A	74	EI-360042	IC TC74HC259P
12	ED-301911	D SILICON H DS448	75	EI-366117	IC TC74HC279P
13	ED-344280	D SILICON H GMA-01-FY2 F05	76	EI-360036	IC TC74HC32P
14	*ED-370990	D SILICON 1SR35-100AHS F10	77	EI-384782J	IC TC74HC365P
15	ED-378219	DETECTOR PC 6N137	78	EI-365831	IC TC74HC393P
16	*EF-355226	FUSE BET T 250V 1.00A [B]	79	EI-384807J	IC TC74HC4051AP
17	*EF-355374	FUSE BET T 250V 500MA [B]	80	EI-375205	IC TC74HC541P
18	*EF-623103	FUSE SEMKO T 250V 1.00A [E,V,S]	81	EI-371361	IC TC74HC573P
19	*EF-593706	FUSE SEMKO T 250V 500MA [E,V,S]	82	EI-376387	IC TC74HC595P
20	*EF-309387	FUSE TSC A 250V 1.00A [J]	83	EI-360028	IC TC74HC74P
21	*EF-310229	FUSE TSC 125V 1.00A [C,A,Y1]	84	EI-360027	IC TC74HC86P
22	EH-388603J	COMP R EXB-RA13 221J	85	EI-384769J	IC TE7730
23	EH-388604J	COMP R EXB-RA13 331J	86	EI-384804J	IC UPD5201C
24	EH-384795J	FILTER LC LP BL-21TS 20KHZ	87	EI-384768J	IC UPD70216G-8
25	EH-384796J	FILTER LC LP BL-21TT 20KHZ	88	EI-384773J	IC UPD71065G
26	EH-384797J	FILTER LC LP BL-21TU 20KHZ	89	EI-378275	IC UPD72066C
27	EH-384792J	FILTER LC LP BL-21TY 10KHZ	90	EI-365811	OSC X'TAL NR18 16.000MHZ
28	EH-384793J	FILTER LC LP BL-21TZ 10KHZ	91	EI-384779J	OSC X'TAL TD308C 33.8688MHZ
29	EH-384794J	FILTER LC LP BL-21UA 10KHZ	92	EJ-364322	PHONE J 2P HLJ0520-110 W/NUT [L-RETURN]
30	EH-384798J	FILTER LC LP BL-21UB 20KHZ	93	EJ-354105	PHONE J 2P HLJ0520-110 6.3 [R-RETURN]
31	EH-384799J	FILTER LC LP BL-21UC 20KHZ	94	EM-382317J	IND LCD EDMIG245633B
32	EI-389144J	IC CD74ACT573E	95	*EO-360068	COIL LF LF-2 B [J,C,A,Y1]
33	EI-389146J	IC CD74AC00E	96	*EO-389172J	COIL LF LF-4N 502 [E,V,B,S]
34	EI-389143J	IC CD74AC04E	97	*ER-325114	R CB H S10 FS RDS 1/4W 330J
35	EI-389149J	IC CD74AC139E	98	*ER-302241	R CB H S10 FS RDS 1/4W 4R7J
36	EI-389150J	IC CD74AC158E	99	*ER-382385J	R CB H S12 FS RDS 1/2W 100J
37	EI-389148J	IC CD74AC32E	100	*ER-321619	R OMF H-S15 FS 1W 101J
38	EI-389142J	IC CD74AC541E	101	ES-365943	SW EWT-XDFK2550B
39	EI-379585	IC CD74HC4053	102	*ES-337902	SW PUSH SDDL1 01-1 [J,C,A,Y1]
40	EI-369660	IC CXK5816PN-12L	103	*ES-384812J	SW PUSH SDDSA3 02-1 [E,V,B,S]
41	EI-384770J	IC FLR-L6009	104	ES-384811J	SW SLIDE ESD-32243 [GAIN SW]
42	EI-384771J	IC ITP-L6009	105	ES-349474	SW TACT SKHHAM004A
43	EI-378276	IC LC7981	106	ET-308977	TR 2SC2274K F F05
44	EI-379657J	IC MB89255A-P-G	107	EV-384810J	VR ROTARY EVH-CCA363B53 B502 [CONTRAST VR]
45	EI-388602J	IC MB89352-P-G	108	EV-384809J	VR ROTARY EWK-EPA027B14 B103X2 [OUT PUT VR]
46	EI-375346	IC MM74HC04N	109	EV-384808J	VR ROTARY EWK-E9A027A14 A103X2 [REC VR]
47	EI-375347	IC MM74HC14N	110	ZZ-728379J	CARTON SHIPPING HARD DISK ST-157
48	EI-362553	IC MN41464-12			
49	EI-356160	IC M5216P			
50	EI-360043	IC M5220P			
51	EI-362588	IC M5238P			
52	*EI-336995	IC NJM78L05A			
53	*EI-326702	IC NJM78M05A			
54	*EI-375441	IC NJM78M12A			
55	*EI-356299	IC NJM79M05A			
56	*EI-375442	IC NJM79M12A			
57	EI-388409J	IC OPA602AM			
58	EI-378297	IC PCM54HP			
59	EI-382368J	IC PCM78P-J			
60	EI-364253	IC PST520D-2			
61	EI-384791J	IC TC511000AP-10			
62	EI-384777J	IC TC57512AD-15 [BLANK ROM]			
63	EI-384776J	IC TC57512AD-15 S1000 V1.0-C			

2. P.C BOARD BLK

Ref. No.	Part No.	Description
1	BA-L6009A060A	PC CPU BLK S1000
2	BA-L6009A030A	PC VOICE BLK S1000
3	BA-L6009A050A	PC PANEL BLK S1000
4	BA-L6009A020A	PC MEMORY BLK S1000
5A	BA-L6009A040A	PC(#) JACK BLK S1000(J) [J,C,A,Y1]
5B	BA-L6009A040B	PC(#) JACK BLK S1000(E) [E,V,B,S]

PC (#) JACK BLK CONSISTS OF FOLLOWING P.C BOARD.

- * JACK (A) P.C BOARD
- * JACK (B) P.C BOARD
- * JACK (C) P.C BOARD
- * JACK (D) P.C BOARD
- * GAIN SW P.C BOARD
- * VR P.C BOARD
- * CONSTANT VR P.C BOARD
- * FILTER P.C BOARD
- * POWER SW P.C BOARD
- * EL INV P.C BOARD

3. CPU P.C BOARD

Ref. No.	Part No.	Description
C72	EC-365619	C EC V CUT AS1 102M 25.0DC
C73	EC-365619	C EC V CUT AS1 102M 25.0DC
D1	ED-344280	D SILICON H GMA-01-FY2 F05
D2	*ED-330319	D SILICON DBA10B 100/1.0A
D3	*ED-370990	D SILICON 1SR35-100AHS F10
D4	*ED-370990	D SILICON 1SR35-100AHS F10
D5	*ED-370990	D SILICON 1SR35-100AHS F10
D6	*ED-370990	D SILICON 1SR35-100AHS F10
IC1	EI-384768J	IC UPD70216G-8
IC2	EI-384769J	IC TE7730
IC3	EI-384770J	IC FLR-L6009
IC4	EI-384771J	IC ITP-L6009
IC5	EI-378276	IC LC7981
IC6	EI-378275	IC UPD72066C
IC7	EI-384773J	IC UPD71065G
IC8	EI-379657J	IC MB889255A-P-G
IC9	EI-384774J1	IC TC57512AD-15 S1000 V1.10-A [PROGRAMED ROM]
*IC9	EI-384777J	IC TC57512AD-15 [BLANK ROM]
IC10	EI-384775J1	IC TC57512AD-15 S1000 V1.10-B [PROGRAMED ROM]
*IC10	EI-384777J	IC TC57512AD-15 [BLANK ROM]
IC11	EI-384776J	IC TC57512AD-15 S1000 V1.0-C [PROGRAMED ROM]
*IC11	EI-384777J	IC TC57512AD-15 [BLANK ROM]
IC12	EI-384778J	IC TC57512AD-15 S1000 V1.0-D [PROGRAMED ROM]
*IC12	EI-384777J	IC TC57512AD-15 [BLANK ROM]
IC13	EI-369660	IC CXK5816PN-12L
IC14	EI-362553	IC MN41464-12
IC15	EI-362553	IC MN41464-12
IC16	EI-362553	IC MN41464-12
IC17	EI-362553	IC MN41464-12
IC18	EI-389150J	IC CD74AC158E
IC19	EI-389150J	IC CD74AC158E
IC20	EI-360025	IC TC74HC138P
IC21	EI-360042	IC TC74HC259P
IC22	EI-384782J	IC TC74HC365P
IC23	EI-365831	IC TC74HC393P
IC24	EI-365101	IC TC74HC195P
IC25	EI-366117	IC TC74HC279P

Ref. No.	Part No.	Description
IC26	EI-356049	IC TC74HC139P
IC27	EI-360028	IC TC74HC74P
IC28	EI-376387	IC TC74HC595P
IC29	EI-376387	IC TC74HC595P
IC30	EI-371361	IC TC74HC573P
IC31	EI-371361	IC TC74HC573P
IC32	EI-389144J	IC CD74ACT573E
IC33	EI-389149J	IC CD74AC139E
IC34	EI-389142J	IC CD74AC541E
IC35	EI-389142J	IC CD74AC541E
IC36	EI-375347	IC MM74HC14N
IC37	EI-375346	IC MM74HCO4N
IC38	EI-360039	IC TC74HC08P
IC39	EI-389143J	IC CD74AC04E
IC40	EI-389146J	IC CD74AC00E
IC41	EI-389148J	IC CD74AC32E
IC42	EI-384789J	IC TC74HC10P
IC43	EI-375346	IC MM74HCO4N
IC44	EI-360037	IC TC74HC00P
IC45	EI-360036	IC TC74HC32P
IC46	EI-360039	IC TC74HC08P
IC47	EI-364253	IC PST520D-2
IC48	*EI-375441	IC NJM78M12A
IC49	*EI-375442	IC NJM79M12A
IC50	EI-362553	IC MN41464-12
IC51	EI-362553	IC MN41464-12
IC52	EI-362553	IC MN41464-12
IC53	EI-362553	IC MN41464-12
IC54	EI-389149J	IC CD74AC139E
IC55	EI-360036	IC TC74HC32P
J101	EJ-364256	DIN J M1704 3P [MIDI]
PH1	ED-378219	DETECTOR PC 6N137
P101	EJ-384780J	SOCKET 64S-6033-0431-2 64P
P102	EJ-384780J	SOCKET 64S-6033-0431-2 64P
P103	EJ-384780J	SOCKET 64S-6033-0431-2 64P
P104	EJ-384780J	SOCKET 64S-6033-0431-2 64P
P105	EJ-384780J	SOCKET 64S-6033-0431-2 64P
P106	EJ-384780J	SOCKET 64S-6033-0431-2 64P
P107	EJ-384780J	SOCKET 64S-6033-0431-2 64P
P108	EJ-365834	PLUG RK-H341TD-0190 34P
P109	EJ-384818J	PLUG RF-H262TD-1190 26P
P110	EJ-378280	PLUG RA-H502TD-1190 50P
R53	*ER-325114	R CB H S10 FS RDS 1/4W 330J
R54	*ER-382385J	R CB H S12 FS RDS 1/2W 100J
X1	EI-365811	OSC X'TAL NR18 16.000MHZ
X2	EI-365811	OSC X'TAL NR18 16.000MHZ
X3	EI-384779J	OSC X'TAL TD308C 33.8688MHZ
F2A	*EF-309387	FUSE TSC A 250V 1.00A [J]
F3A	*EF-309387	FUSE TSC A 250V 1.00A [J]
F2B	*EF-310229	FUSE TSC 125V 1.00A [C,A,Y1]
F3B	*EF-310229	FUSE TSC 125V 1.00A [C,A,Y1]
F2C	*EF-623103	FUSE SEMKO T 250V 1.00A [E,V,S]
F3C	*EF-623103	FUSE SEMKO T 250V 1.00A [E,V,S]
F2D	*EF-355226	FUSE BET T 250V 1.00A [B]
F3D	*EF-355226	FUSE BET T 250V 1.00A [B]
1	EZ-200473	SILICON RUBBER SHEET TC-30
2	ZW-632226	WASHER INSULATOR (BUSH M)
3	ZS-421806	PAN30X08STL CMT

4. VOICE P.C BOARD

Ref. No.	Part No.	Description
C29	EC-305429	C TT V DN 105M 25.0DC
C30	EC-305429	C TT V DN 105M 25.0DC
C31	EC-305429	C TT V DN 105M 25.0DC
C34	EC-303031	C TT V DN 335M 25.0DC
C35	EC-371580	C TT V DN 225M 25.0DC
C36	EC-303031	C TT V DN 335M 25.0DC
C37	EC-305429	C TT V DN 105M 25.0DC
C89	EC-305522	C TT V DN 106M 25.0DC
C91	EC-305522	C TT V DN 106M 25.0DC
C93	EC-305522	C TT V DN 106M 25.0DC
C95	EC-305522	C TT V DN 106M 25.0DC
C98	EC-305522	C TT V DN 106M 25.0DC
C99	EC-305522	C TT V DN 106M 25.0DC
C114	EC-347371	C MC V F05 FE92 180J 500DC
C115	EC-347371	C MC V F05 FE92 180J 500DC
C116	EC-347371	C MC V F05 FE92 180J 500DC
D1	ED-301911	D SILICON H DS448
F1	EH-384792J	FILTER LC LP BL-21TY 10KHZ
F2	EH-384792J	FILTER LC LP BL-21TY 10KHZ
F3	EH-384793J	FILTER LC LP BL-21TZ 10KHZ
F4	EH-384793J	FILTER LC LP BL-21TZ 10KHZ
F5	EH-384794J	FILTER LC LP BL-21UA 10KHZ
F6	EH-384794J	FILTER LC LP BL-21UA 10KHZ
F7	EH-384795J	FILTER LC LP BL-21TS 20KHZ
F8	EH-384795J	FILTER LC LP BL-21TS 20KHZ
F9	EH-384796J	FILTER LC LP BL-21TT 20KHZ
F10	EH-384796J	FILTER LC LP BL-21TT 20KHZ
F11	EH-384797J	FILTER LC LP BL-21TU 20KHZ
F12	EH-384797J	FILTER LC LP BL-21TU 20KHZ
F13	EH-384798J	FILTER LC LP BL-21UB 20KHZ
F14	EH-384798J	FILTER LC LP BL-21UB 20KHZ
F15	EH-384798J	FILTER LC LP BL-21UB 20KHZ
F16	EH-384799J	FILTER LC LP BL-21UC 20KHZ
F17	EH-384799J	FILTER LC LP BL-21UC 20KHZ
F18	EH-384799J	FILTER LC LP BL-21UC 20KHZ
IC1	EI-360043	IC M5220P
IC2	EI-360043	IC M5220P
IC3	EI-360043	IC M5220P
IC4	EI-360043	IC M5220P
IC5	EI-384804J	IC UPD5201C
IC6	EI-384804J	IC UPD5201C
IC7	EI-362588	IC M5238P
IC8	EI-362588	IC M5238P
IC9	EI-360027	IC TC74HC86P
IC10	EI-382368J	IC PCM78P-J
IC11	EI-360027	IC TC74HC86P
IC12	EI-360037	IC TC74HC00P
IC13	EI-378297	IC PCM54HP
IC14	EI-388409J	IC OPA602AM
IC15	EI-360054	IC TC74HC174P
IC16	EI-360054	IC TC74HC174P
IC17	EI-360054	IC TC74HC174P
IC18	EI-360054	IC TC74HC174P
IC19	EI-360054	IC TC74HC174P
IC20	EI-360054	IC TC74HC174P
IC21	EI-379585	IC CD74HC4053
IC22	EI-379585	IC CD74HC4053
IC23	EI-379585	IC CD74HC4053
IC24	EI-379585	IC CD74HC4053
IC25	EI-384807J	IC TC74HC4051AP
IC26	EI-384807J	IC TC74HC4051AP
IC27	EI-384804J	IC UPD5201C
IC28	EI-360043	IC M5220P
IC29	EI-360043	IC M5220P
IC30	EI-360043	IC M5220P
IC31	EI-360043	IC M5220P
IC32	*EI-326702	IC NJM78M05A
IC33	*EI-356299	IC NJM79M05A
IC34	*EI-336995	IC NJM78L05A
J301	EJ-364322	PHONE J 2P HLJ0520-110 W/NUT [L-RETURN]
J302	EJ-364322	PHONE J 2P HLJ0520-110 W/NUT [LEFT/MONO]
J303	EJ-354105	PHONE J 2P HLJ0520-110 6.3 [R-RETURN]

Ref. No.	Part No.	Description
J304	EJ-354105	PHONE J 2P HLJ0520-110 6.3 [RIGHT]
J305	EJ-354105	PHONE J 2P HLJ0520-110 6.3 [ECHO SEND]
L1	EO-379607	COIL FIX 2 8RBS 151K
L2	EO-379607	COIL FIX 2 8RBS 151K
R47	*ER-325114	R CB H S10 FS RDS 1/4W 330J
R48	*ER-325114	R CB H S10 FS RDS 1/4W 330J
R49	*ER-325114	R CB H S10 FS RDS 1/4W 330J
R50	*ER-325114	R CB H S10 FS RDS 1/4W 330J
VR1	EV-378357	R S-FIX H RH0645C 0.30W 104
VR2	EV-378357	R S-FIX H RH0645C 0.30W 104
VR3	EV-378359	R S-FIX H RH0645C P0.30W 224
VR4	EV-380457J	R S-FIX H RH0645C 0.30W 472
VR5	EV-386660J	R S-FIX H RH0645C 0.30W 105
VR6	EV-378357	R S-FIX H RH0645C 0.30W 104
VR7	EV-380457J	R S-FIX H RH0645C 0.30W 472
VR8	EV-380457J	R S-FIX H RH0645C 0.30W 472
VR9	EV-380457J	R S-FIX H RH0645C 0.30W 472
W304	EW-384803J	WIRE ASSY S1000 W304 50P

5. PANEL P.C BOARD

Ref. No.	Part No.	Description
D1	ED-359863	D LED LN81CV-(LF) AK ORANGE
D2	ED-359863	D LED LN81CV-(LF) AK ORANGE
D3	ED-359863	D LED LN81CV-(LF) AK ORANGE
D4	ED-359863	D LED LN81CV-(LF) AK ORANGE
D5	ED-359863	D LED LN81CV-(LF) AK ORANGE
D6	ED-359863	D LED LN81CV-(LF) AK ORANGE
D7	ED-359863	D LED LN81CV-(LF) AK ORANGE
D8	ED-359863	D LED LN81CV-(LF) AK ORANGE
SR1	EH-384815J	COMP R RKC1/8B12 103J
SR2	EH-384817J	COMP R RKC1/8B8 102J
SW1	ES-349474	SW TACT SKHHAM004A
SW2	ES-349474	SW TACT SKHHAM004A
SW3	ES-349474	SW TACT SKHHAM004A
SW4	ES-349474	SW TACT SKHHAM004A
SW5	ES-349474	SW TACT SKHHAM004A
SW6	ES-349474	SW TACT SKHHAM004A
SW7	ES-349474	SW TACT SKHHAM004A
SW8	ES-349474	SW TACT SKHHAM004A
SW9	ES-349474	SW TACT SKHHAM004A
SW10	ES-349474	SW TACT SKHHAM004A
SW11	ES-349474	SW TACT SKHHAM004A
SW12	ES-349474	SW TACT SKHHAM004A
SW13	ES-349474	SW TACT SKHHAM004A
SW14	ES-349474	SW TACT SKHHAM004A
SW15	ES-349474	SW TACT SKHHAM004A
SW16	ES-349474	SW TACT SKHHAM004A
SW17	ES-349474	SW TACT SKHHAM004A
SW18	ES-349474	SW TACT SKHHAM004A
SW19	ES-349474	SW TACT SKHHAM004A
SW20	ES-349474	SW TACT SKHHAM004A
SW21	ES-349474	SW TACT SKHHAM004A
SW22	ES-349474	SW TACT SKHHAM004A
SW23	ES-349474	SW TACT SKHHAM004A
SW24	ES-349474	SW TACT SKHHAM004A
SW25	ES-349474	SW TACT SKHHAM004A
SW26	ES-349474	SW TACT SKHHAM004A
SW27	ES-349474	SW TACT SKHHAM004A
SW28	ES-349474	SW TACT SKHHAM004A
SW29	ES-349474	SW TACT SKHHAM004A
SW30	ES-349474	SW TACT SKHHAM004A
SW31	ES-349474	SW TACT SKHHAM004A
SW32	ES-349474	SW TACT SKHHAM004A
W501	EW-384767J	WIRE ASSY S1000 W501 26P

6. MEMORY P.C BOARD

Ref. No.	Part No.	Description
IC1	EI-384791J	IC TC511000AP-10
IC2	EI-384791J	IC TC511000AP-10
IC3	EI-384791J	IC TC511000AP-10
IC4	EI-384791J	IC TC511000AP-10
IC5	EI-384791J	IC TC511000AP-10
IC6	EI-384791J	IC TC511000AP-10
IC7	EI-384791J	IC TC511000AP-10
IC8	EI-384791J	IC TC511000AP-10
IC9	EI-384791J	IC TC511000AP-10
IC10	EI-384791J	IC TC511000AP-10
IC11	EI-384791J	IC TC511000AP-10
IC12	EI-384791J	IC TC511000AP-10
IC13	EI-384791J	IC TC511000AP-10
IC14	EI-384791J	IC TC511000AP-10
IC15	EI-384791J	IC TC511000AP-10
IC16	EI-384791J	IC TC511000AP-10
IC17	EI-389142J	IC CD74AC541E
IC18	EI-389142J	IC CD74AC541E
IC19	EI-375205	IC TC74HC541P
IC20	EI-375205	IC TC74HC541P
J201	EJ-384790J	PLUG 64P-6033-0431-0 64P

7. JACK (A) P.C BOARD

Ref. No.	Part No.	Description
F1	EH-384798J	FILTER LC LP BL-21UB 20KHZ
F2	EH-384798J	FILTER LC LP BL-21UB 20KHZ
F3	EH-384798J	FILTER LC LP BL-21UB 20KHZ
F4	EH-384798J	FILTER LC LP BL-21UB 20KHZ
F5	EH-384799J	FILTER LC LP BL-21UC 20KHZ
F6	EH-384799J	FILTER LC LP BL-21UC 20KHZ
F7	EH-384799J	FILTER LC LP BL-21UC 20KHZ
F8	EH-384799J	FILTER LC LP BL-21UC 20KHZ
IC1	EI-360043	IC M5220P
IC2	EI-360043	IC M5220P
J401	EJ-364322	PHONE J 2P HLJ0520-110 W/NUT [CH 1]
J402	EJ-364322	PHONE J 2P HLJ0520-110 W/NUT [CH 2]
J403	EJ-354105	PHONE J 2P HLJ0520-110 6.3 [CH 3]
J404	EJ-354105	PHONE J 2P HLJ0520-110 6.3 [CH 4]

8. JACK (B) P.C BOARD

Ref. No.	Part No.	Description
F1	EH-384798J	FILTER LC LP BL-21UB 20KHZ
F2	EH-384798J	FILTER LC LP BL-21UB 20KHZ
F3	EH-384798J	FILTER LC LP BL-21UB 20KHZ
F4	EH-384798J	FILTER LC LP BL-21UB 20KHZ
F5	EH-384799J	FILTER LC LP BL-21UC 20KHZ
F6	EH-384799J	FILTER LC LP BL-21UC 20KHZ
F7	EH-384799J	FILTER LC LP BL-21UC 20KHZ
F8	EH-384799J	FILTER LC LP BL-21UC 20KHZ
IC1	EI-360043	IC M5220P
IC2	EI-360043	IC M5220P
J405	EJ-364322	PHONE J 2P HLJ0520-110 W/NUT [CH 5]
J406	EJ-364322	PHONE J 2P HLJ0520-110 W/NUT [CH 6]
J407	EJ-354105	PHONE J 2P HLJ0520-110 6.3 [CH 7]
J408	EJ-354105	PHONE J 2P HLJ0520-110 6.3 [CH 8]

9. JACK (C) P.C BOARD

Ref. No.	Part No.	Description
J409	EJ-379523	PHONE J 3P HLJ4305-3080 S.NUT [REC IN L]
J410	EJ-379523	PHONE J 3P HLJ4305-3080 S.NUT [REC IN R]

10. JACK (D) P.C BOARD

Ref. No.	Part No.	Description
IC1	EI-356160	IC M5216P
J411	EJ-353031	PHONE J 3P HLJ0520-010 [HEAD PHONE]
J412	EJ-379523	PHONE J 3P HLJ4305-3080 S.NUT [FOOT SW]
R5	*ER-321619	R OMF H S15 FS 1W 101J
R6	*ER-321619	R OMF H S15 FS 1W 101J

11. VR P.C BOARD

Ref. No.	Part No.	Description
VR401	EV-384808J	VR ROTARY EWK-E9A027A14 A103X2 [REC VR]
VR402	EV-384809J	VR ROTARY EWK-EPA027B14 B103X2 [OUT PUT VR]

12. GAIN SW P.C BOARD

Ref. No.	Part No.	Description
SW401	ES-384811J	SW SLIDE ESD-32243 [GAIN SW]

13. CONTRAST VR P.C BOARD

Ref. No.	Part No.	Description
VR403	EV-384810J	VR ROTARY EVH-CCA363B53 B502 [CONTRAST VR]

14. FILTER P.C BOARD

Ref. No.	Part No.	Description
C1	*EC-369670	C MMY V XE 683M 250AC
C2	*EC-358450	C CE V DNS102MBE B 102M 400AC
C3	*EC-358450	C CE V DNS102MBE B 102M 400AC
C4	*EC-358450	C CE V DNS102MBE B 102M 400AC [E,V,B,S]
FL1	*EO-360068	COIL LF LF-2 B [J,C,A,Y1]
FL1A	*EO-389172J	COIL LF LF-4N 502 [E,V,B,S]
F1A	*EF-309387	FUSE TSC A 250V 1.00A [J]
F1B	*EF-310229	FUSE TSC 125V 1.00A [C,A,Y1]
F1C	*EF-593706	FUSE SEMKO T 250V 500MA [E,V,S]
F1D	*EF-355374	FUSE BET T 250V 500MA [B]

15. POWER SW P.C BOARD

Ref. No.	Part No.	Description
C1	*EC-361942	C CE V DNS103ZV V 103Z 400AC [E,V,B,S]
C2	*EC-361942	C CE V DNS103ZV V 103Z 400AC [E,V,B,S]
SW1	*ES-384812J	SW PUSH SDDSA3 02-1 [E,V,B,S]

16. POWER SW P.C BOARD

Ref. No.	Part No.	Description
C1	*EC-361942	C CE V DNS103ZV V 103Z 400AC [J,C,A,Y1]
SW1	*ES-337902	SW PUSH SDDLD1 01-1 [J,C,A,Y1]

17. EL INV P.C BOARD

Ref. No.	Part No.	Description
R1	*ER-302241	R CB H S10 FS RDS 1/4W 4R7J
TR1	ET-308977	TR 2SC2274K F F05
T1	*BT-383935J	TRANS PULSE 2E16-1001-01

18. SCSI P.C BOARD

Ref. No.	Part No.	Description
D1	ED-301911	D SILICON H DS448
D2	ED-301911	D SILICON H DS448
FR1	EH-388603J	COMP R EXB-RA13 221J
FR2	EH-388603J	COMP R EXB-RA13 221J
FR3	EH-388604J	COMP R EXB-RA13 331J
FR4	EH-388604J	COMP R EXB-RA13 331J
IC1	EI-388602J	IC MB89352-P-G
J1	EJ-368452	PLUG 57LE-40500-7700(D12)
P1	EJ-384790J	PLUG 64P-6033-0431-0 64P
W101	EW-388606J	WIRE ASSY S1000HD W101 50P

FINAL ASSEMBLY BLOCK

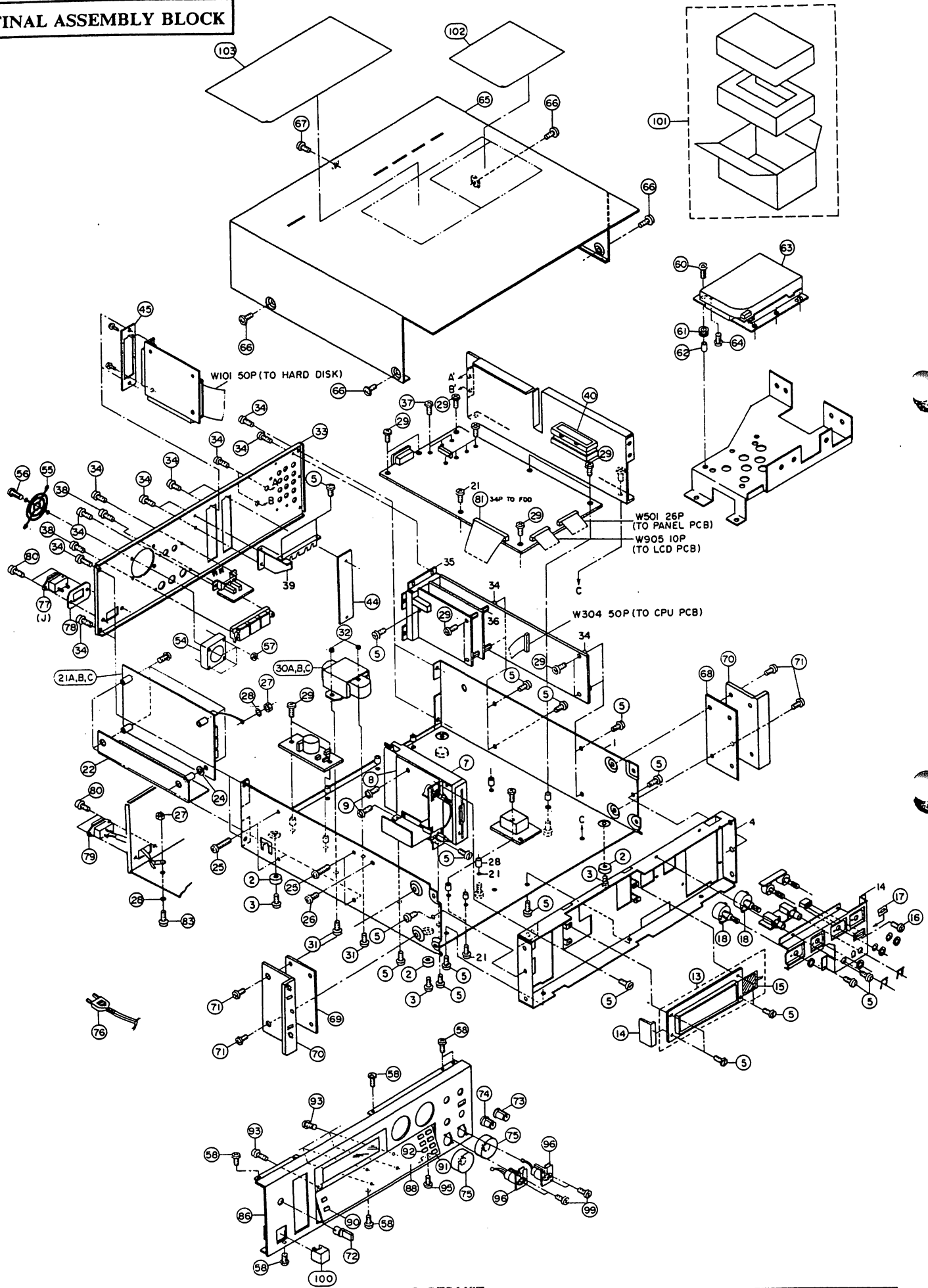

PARTS LIST

19. FINAL ASSEMBLY BLOCK

Ref. No.	Part No.	Description	Ref. No.	Part No.	Description
2	SA-349332	FOOT	79	*EJ-358632	SOCKET INLET SOT-16 3P [C,A,E,V,B,S,Y1]
3	ZS-344754	ST PAN30X06STL CMT C080	80	ZS-362534	T2CTS30X10STL BNI
5	ZS-320906	ST BR30X06STL CMT	81	EW-384754J	WIRE ASSY S1000 W904 34P
7	BB-384741J	FLOPPY DISK DFP723F	82	EW-384755J	WIRE ASSY S1000 W905 10P
8	SZ-389139J1	SHEET INSULATE FLOPPY	83	ZS-322580	ST BID40X08STL BNI
9	ZS-379405	BID30X06STL CMT	86	BD-388706J	PANEL FRONT S1000HD PART
13	EM-382317J	IND LCD EDMIG245633B	88	BD-384734J	PANEL FUNCTION PART
14	EJ-378269	PLUG B10P-ER 10P	90	SK-382418J	KNOB PUSH(A)
15	EL-728382J	EDMIG245633B EL BACK LIGHT	91	SK-382419J	KNOB PUSH(B)
16	ZS-608095	PAN20X05STL CMT	92	SK-382420J	KNOB PUSH(C)A
17	SZ-388412J	MASK SLIDE SW	93	ZS-323728	BID30X05STL CMT
18	ES-365943	SW EWT-XDFK2550B	95	ZS-325495	T2BR30X06STL CMT
21A	*BP-389023J	SW REGULATOR KFD40E-01A(J) [J]	96	EJ-384747J	SOCKET RECEPTACLE XLR-31-F77
21B	*BP-388947J	SW REGULATOR KFD40E-01A(L) [C,A,Y1]	99	ZS-355590	CTS26X06STL NI3
21C	*BP-388946J	SW REGULATOR KFD40E-01A(H) [E,V,B,S]	100	SK-343017J	KNOB POWER (C)
22	SZ-388942J	SHEET INSULATE	101	ZZ-728379J	CARTON SHIPPING HARD DISK ST-157
24	ZW-259503	PW31X080X050NYL	102	ZZ-389006J	CAUTION STICKER HD(J)
25	ZS-379405	BID30X06STL CMT	103	ZZ-389007J	CAUTION STICKER HD
26	ZS-322580	ST BID40X08STL BNI			
27	ZW-413267	N FRANGE 40STL CMT			
28	ZW-273892	TW40			
29	ZS-608321	PAN30X06STL CMT PW080			
30A	*BT-384744J	TRANS POW S1000(J)			
30B	*BT-384745J	TRANS POW S1000(C,A) [C,A]			
30C	*BT-384746J	TRANS POW S1000(E,V,B,S) [E,V,B,S]			
31	ZS-348375	ST BR30X08STL CMT			
32	ZW-609434	N FRANGE 30STL CMT			
33	SP-388608J	PANEL REAR S1000HD			
34	ZS-345272	ST BR30X06STL BNI			
37	ZS-421806	PAN30X08STL CMT			
38	ZS-350934	PT BR30X08STL BNI			
40	MZ-386851J	FERRITE CORE EFC-50-S [C,E]			
44	SC-384696J	COVER CONNECTOR(A)			
45	SC-385427J	COVER CONNECTOR(B)			
54	BM-388943J	MOTOR FAN M60BLF-1M 12V			
55	SC-388210J	FAN GUARD			
56	ZS-388940J	BID40X35STL BNI			
57	ZW-413188	N40STL CMT 1			
58	ZS-358936	ST BID30X06STL CMT			
60	ZS-352133	ST BR30X10STL CMT			
61	MB-282778	RUBBER BUSH			
62	MH-306736	SPACER 3X4			
63	BB-387245J	HARD DISK ST-157			
64	ZS-417150	PAN40X06STL CMT			
65	SP-388132J	COVER UPPER(B)			
66	ZS-341959	ST BID40X06STL NI3			
67	ZS-319460	T2BR30X06STL BZN PROJECTION			
68	SC-384717J	COVER MOUNT(R)			
69	SC-384718J	COVER MOUNT(L)			
70	SH-362361	HANDLE RACK			
71	ZS-322570	ST BID40X08STL NI3			
72	SK-384814J	KNOB VOL-C			
73	SK-386675J	KNOB SINGLE(2)PART			
74	SK-386676J	KNOB SINGLE(3)PART			
75	SK-384714J	KNOB CONTROL PART			
76A	*EW-365947	AC CORD 250 SKP210KS17B A [J]			
76B	*EW-368420	AC CORD200SKP30KS16 B AC [C,A,Y1]			
76C	*EW-368421	AC CORD200SKP4819DKS16 B E [E,V]			
76D	*EW-368422	AC CORD200 KS-116AGTBS [B]			
76E	*EW-368418	AC CORD200SKP550KS16 B S [S]			
77	*EJ-358633	SOCKET INLET SOT-17 2P [J]			
78	MZ-385430J	HOLDER INLET			

INDEX

Part No.	Ref. No.	Part No.	Ref. No.	Part No.	Ref. No.	Part No.	Ref. No.
BA-L6009A020A	2-4	EF-310229	1-21	EI-360028	3-IC27	EI-378297	4-IC13
BA-L6009A030A	2-2	EF-310229	3-F2B	EI-360036	1-76	EI-379585	1-39
BA-L6009A040A	2-5A	EF-310229	3-F3B	EI-360036	3-IC45	EI-379585	4-IC21
BA-L6009A040B	2-5B	EF-310229	14-F1B	EI-360036	3-IC55	EI-379585	4-IC22
BA-L6009A050A	2-3	EF-355226	1-16	EI-360037	1-67	EI-379585	4-IC23
BA-L6009A060A	2-1	EF-355226	3-F2D	EI-360037	3-IC44	EI-379585	4-IC24
BB-384741J	1-1	EF-355226	3-F3D	EI-360037	4-IC12	EI-379657J	1-44
BB-384741J	19-7	EF-355374	1-17	EI-360039	1-68	EI-379657J	3-IC8
BB-387245J	1-2	EF-355374	14-F1D	EI-360039	3-IC38	EI-382368J	1-59
BB-387245J	19-63	EF-593706	1-19	EI-360039	3-IC46	EI-382368J	4-IC10
BD-384734J	19-88	EF-593706	14-F1C	EI-360042	1-74	EI-384768J	1-87
BD-388706J	19-86	EF-623103	1-18	EI-360042	3-IC21	EI-384768J	3-IC1
BM-388943J	19-54	EF-623103	3-F2C	EI-360043	1-50	EI-384769J	1-85
BP-388946J	1-3	EF-623103	3-F3C	EI-360043	4-IC1	EI-384769J	3-IC2
BP-388946J	19-21C	EH-384792J	1-27	EI-360043	4-IC2	EI-384770J	1-41
BP-388947J	1-5	EH-384792J	4-F1	EI-360043	4-IC3	EI-384770J	3-IC3
BP-388947J	19-21B	EH-384792J	4-F2	EI-360043	4-IC4	EI-384771J	1-42
BP-389023J	1-4	EH-384793J	1-28	EI-360043	4-IC28	EI-384771J	3-IC4
BP-389023J	19-21A	EH-384793J	4-F3	EI-360043	4-IC29	EI-384773J	1-88
BT-383935J	1-9	EH-384793J	4-F4	EI-360043	4-IC30	EI-384773J	3-IC7
BT-383935J	17-T1	EH-384794J	1-29	EI-360043	4-IC31	EI-384774J1	1-65
BT-384744J	1-8	EH-384794J	4-F5	EI-360043	7-IC1	EI-384774J1	3-IC9
BT-384744J	19-30A	EH-384794J	4-F6	EI-360043	7-IC2	EI-384775J1	1-66
BT-384745J	1-6	EH-384795J	1-24	EI-360043	8-IC1	EI-384775J1	3-IC10
BT-384745J	19-30B	EH-384795J	4-F7	EI-360043	8-IC2	EI-384776J	1-63
BT-384746J	1-7	EH-384795J	4-F8	EI-360054	1-72	EI-384776J	3-IC11
BT-384746J	19-30C	EH-384796J	1-25	EI-360054	4-IC15	EI-384777J	1-62
EC-303031	4-C34	EH-384796J	4-F9	EI-360054	4-IC16	EI-384777J	3-IC9
EC-303031	4-C36	EH-384796J	4-F10	EI-360054	4-IC17	EI-384777J	3-IC10
EC-305429	4-C29	EH-384797J	1-26	EI-360054	4-IC18	EI-384777J	3-IC11
EC-305429	4-C30	EH-384797J	4-F11	EI-360054	4-IC19	EI-384777J	3-IC12
EC-305429	4-C31	EH-384797J	4-F12	EI-360054	4-IC20	EI-384778J	1-64
EC-305429	4-C37	EH-384798J	1-30	EI-362553	1-48	EI-384778J	3-IC12
EC-305522	4-C89	EH-384798J	4-F13	EI-362553	3-IC14	EI-384779J	1-91
EC-305522	4-C91	EH-384798J	4-F14	EI-362553	3-IC15	EI-384779J	3-X3
EC-305522	4-C93	EH-384798J	4-F15	EI-362553	3-IC16	EI-384782J	1-77
EC-305522	4-C95	EH-384798J	7-F1	EI-362553	3-IC17	EI-384782J	3-IC22
EC-305522	4-C98	EH-384798J	7-F2	EI-362553	3-IC50	EI-384789J	1-69
EC-305522	4-C99	EH-384798J	7-F3	EI-362553	3-IC51	EI-384789J	3-IC42
EC-347371	4-C114	EH-384798J	7-F4	EI-362553	3-IC52	EI-384791J	1-61
EC-347371	4-C115	EH-384798J	8-F1	EI-362553	3-IC53	EI-384791J	6-IC1
EC-347371	4-C116	EH-384798J	8-F2	EI-362588	1-51	EI-384791J	6-IC2
EC-358450	14-C2	EH-384798J	8-F3	EI-362588	4-IC7	EI-384791J	6-IC3
EC-358450	14-C3	EH-384798J	8-F4	EI-362588	4-IC8	EI-384791J	6-IC4
EC-358450	14-C4	EH-384799J	1-31	EI-364253	1-60	EI-384791J	6-IC5
EC-361942	15-C1	EH-384799J	4-F16	EI-364253	3-IC47	EI-384791J	6-IC6
EC-361942	15-C2	EH-384799J	4-F17	EI-365101	1-73	EI-384791J	6-IC7
EC-361942	16-C1	EH-384799J	4-F18	EI-365101	3-IC24	EI-384791J	6-IC8
EC-365619	3-C72	EH-384799J	7-F5	EI-365811	1-90	EI-384791J	6-IC9
EC-365619	3-C73	EH-384799J	7-F6	EI-365811	3-X1	EI-384791J	6-IC10
EC-369670	14-C1	EH-384799J	7-F7	EI-365811	3-X2	EI-384791J	6-IC11
EC-371580	4-C35	EH-384799J	7-F8	EI-365831	1-78	EI-384791J	6-IC12
ED-301911	1-12	EH-384799J	8-F5	EI-365831	3-IC23	EI-384791J	6-IC13
ED-301911	4-D1	EH-384799J	8-F6	EI-366117	1-75	EI-384791J	6-IC14
ED-301911	18-D1	EH-384799J	8-F7	EI-366117	3-IC25	EI-384791J	6-IC15
ED-301911	18-D2	EH-384799J	8-F8	EI-369660	1-40	EI-384791J	6-IC16
ED-330319	1-11	EH-384815J	5-SR1	EI-369660	3-IC13	EI-384804J	1-86
ED-330319	3-D2	EH-384817J	5-SR2	EI-371361	1-81	EI-384804J	4-IC5
ED-344280	1-13	EH-388603J	1-22	EI-371361	3-IC30	EI-384804J	4-IC6
ED-344280	3-D1	EH-388603J	18-FR1	EI-371361	3-IC31	EI-384804J	4-IC27
ED-359863	1-10	EH-388603J	18-FR2	EI-375205	1-80	EI-384807J	1-79
ED-359863	5-D1	EH-388604J	1-23	EI-375205	6-IC19	EI-384807J	4-IC25
ED-359863	5-D2	EH-388604J	18-FR3	EI-375205	6-IC20	EI-384807J	4-IC26
ED-359863	5-D3	EH-388604J	18-FR4	EI-375346	1-46	EI-388409J	1-57
ED-359863	5-D4	EI-326702	1-53	EI-375346	3-IC37	EI-388409J	4-IC14
ED-359863	5-D5	EI-326702	4-IC32	EI-375346	3-IC43	EI-388602J	1-45
ED-359863	5-D6	EI-336995	1-52	EI-375347	1-47	EI-388602J	18-IC1
ED-359863	5-D7	EI-336995	4-IC34	EI-375347	3-IC36	EI-389142J	1-38
ED-359863	5-D8	EI-356049	1-71	EI-375441	1-54	EI-389142J	3-IC34
ED-370990	1-14	EI-356049	3-IC26	EI-375441	3-IC48	EI-389142J	3-IC35
ED-370990	3-D3	EI-356160	1-49	EI-375442	1-56	EI-389142J	6-IC17
ED-370990	3-D4	EI-356160	10-IC1	EI-375442	3-IC49	EI-389142J	6-IC18
ED-370990	3-D5	EI-356299	1-55	EI-376387	1-82	EI-389143J	1-34
ED-370990	3-D6	EI-356299	4-IC33	EI-376387	3-IC28	EI-389143J	3-IC39
ED-378219	1-15	EI-360025	1-70	EI-376387	3-IC29	EI-389144J	1-32
ED-378219	3-PH1	EI-360025	3-IC20	EI-378275	1-89	EI-389144J	3-IC32
EF-309387	1-20	EI-360027	1-84	EI-378275	3-IC6	EI-389146J	1-33
EF-309387	3-F2A	EI-360027	4-IC9	EI-378276	1-43	EI-389146J	3-IC40
EF-309387	3-F3A	EI-360027	4-IC11	EI-378276	3-IC5	EI-389148J	1-37
EF-309387	14-F1A	EI-360028	1-83	EI-378297	1-58	EI-389148J	3-IC41

Part No.	Ref. No.	Part No.	Ref. No.	Part No.	Ref. No.	Part No.	Ref. No.
EI-389149J	1-35	ES-349474	5-SW13	ZS-322570	19-71		
EI-389149J	3-IC33	ES-349474	5-SW14	ZS-322580	19-26		
EI-389149J	3-IC54	ES-349474	5-SW15	ZS-322580	19-83		
EI-389150J	1-36	ES-349474	5-SW16	ZS-323728	19-93		
EI-389150J	3-IC18	ES-349474	5-SW17	ZS-325495	19-95		
EI-389150J	3-IC19	ES-349474	5-SW18	ZS-341959	19-66		
EJ-353031	10-J411	ES-349474	5-SW19	ZS-344754	19-3		
EJ-354105	1-93	ES-349474	5-SW20	ZS-345272	19-34		
EJ-354105	4-J303	ES-349474	5-SW21	ZS-348375	19-31		
EJ-354105	4-J304	ES-349474	5-SW22	ZS-350934	19-38		
EJ-354105	4-J305	ES-349474	5-SW23	ZS-352133	19-60		
EJ-354105	7-J403	ES-349474	5-SW24	ZS-355590	19-99		
EJ-354105	7-J404	ES-349474	5-SW25	ZS-358936	19-58		
EJ-354105	8-J407	ES-349474	5-SW26	ZS-362534	19-80		
EJ-354105	8-J408	ES-349474	5-SW27	ZS-379405	19-9		
EJ-358632	19-79	ES-349474	5-SW28	ZS-379405	19-25		
EJ-358633	19-77	ES-349474	5-SW29	ZS-388940J	19-56		
EJ-364256	3-J101	ES-349474	5-SW30	ZS-417150	19-64		
EJ-364322	1-92	ES-349474	5-SW31	ZS-421806	3-3		
EJ-364322	4-J301	ES-349474	5-SW32	ZS-421806	19-37		
EJ-364322	4-J302	ES-365943	1-101	ZS-608095	19-16		
EJ-364322	7-J401	ES-365943	19-18	ZS-608321	19-29		
EJ-364322	7-J402	ES-384811J	1-104	ZW-259503	19-24		
EJ-364322	8-J405	ES-384811J	12-SW401	ZW-273892	19-28		
EJ-364322	8-J406	ES-384812J	1-103	ZW-413188	19-57		
EJ-365834	3-P108	ES-384812J	15-SW1	ZW-413267	19-27		
EJ-368452	18-J1	ET-308977	1-106	ZW-609434	19-32		
EJ-378269	19-14	ET-308977	17-TR1	ZW-632226	3-2		
EJ-378280	3-P110	EV-378357	4-VR1	ZZ-389006J	19-102		
EJ-379523	9-J409	EV-378357	4-VR2	ZZ-389007J	19-103		
EJ-379523	9-J410	EV-378357	4-VR6	ZZ-728379J	1-110		
EJ-379523	10-J412	EV-378359	4-VR3	ZZ-728379J	19-101		
EJ-384747J	19-96	EV-380457J	4-VR4				
EJ-384780J	3-P101	EV-380457J	4-VR7				
EJ-384780J	3-P102	EV-380457J	4-VR8				
EJ-384780J	3-P103	EV-380457J	4-VR9				
EJ-384780J	3-P104	EV-384808J	1-109				
EJ-384780J	3-P105	EV-384808J	11-VR401				
EJ-384780J	3-P106	EV-384809J	1-108				
EJ-384780J	3-P107	EV-384809J	11-VR402				
EJ-384790J	6-J201	EV-384810J	1-107				
EJ-384790J	18-P1	EV-384810J	13-VR403				
EJ-384818J	3-P109	EV-386660J	4-VR5				
EL-728382J	19-15	EW-365947	19-76A				
EM-382317J	1-94	EW-368418	19-76E				
EM-382317J	19-13	EW-368420	19-76B				
EO-360068	1-95	EW-368421	19-76C				
EO-360068	14-FL1	EW-368422	19-76D				
EO-379607	4-L1	EW-384754J	19-81				
EO-379607	4-L2	EW-384755J	19-82				
EO-389172J	1-96	EW-384767J	5-W501				
EO-389172J	14-FL1A	EW-384803J	4-W304				
ER-302241	1-98	EW-388606J	18-W101				
ER-302241	17-R1	EZ-200473	3-1				
ER-321619	1-100	MB-282778	19-61				
ER-321619	10-R5	MH-306736	19-62				
ER-321619	10-R6	MZ-385430J	19-78				
ER-325114	1-97	MZ-386851J	19-40				
ER-325114	3-R53	SA-349332	19-2				
ER-325114	4-R47	SC-384696J	19-44				
ER-325114	4-R48	SC-384717J	19-68				
ER-325114	4-R49	SC-384718J	19-69				
ER-325114	4-R50	SC-385427J	19-45				
ER-382385J	1-99	SC-388210J	19-55				
ER-382385J	3-R54	SH-362361	19-70				
ES-337902	1-102	SK-343017J	19-100				
ES-337902	16-SW1	SK-382418J	19-90				
ES-349474	1-105	SK-382419J	19-91				
ES-349474	5-SW1	SK-382420J	19-92				
ES-349474	5-SW2	SK-384714J	19-75				
ES-349474	5-SW3	SK-384814J	19-72				
ES-349474	5-SW4	SK-386675J	19-73				
ES-349474	5-SW5	SK-386676J	19-74				
ES-349474	5-SW6	SP-388132J	19-65				
ES-349474	5-SW7	SP-388608J	19-33				
ES-349474	5-SW8	SZ-388412J	19-17				
ES-349474	5-SW9	SZ-388942J	19-22				
ES-349474	5-SW10	SZ-389139J1	19-8				
ES-349474	5-SW11	ZS-319460	19-67				
ES-349474	5-SW12	ZS-320906	19-5				

ABBREVIATIONS FOR THE SERVICE MANUAL

ABBREVIATION	EXPLANATION	ABBREVIATION	EXPLANATION
ADC	Analogue to Digital Converter	MIDI	Musical Instrument Digital Interface
AMP (Amp)	AMPlifier	MINI	MINIum
BBD	Backet Brigade Diode	MIX	MIXer
BCD	Binary Code Decimal	MOD	MODulation
B.DOWN	Brak DOWN	M.WHEEL	Modulation WHEEL
B.UP	Back UP	OSC	OSCillator
CE	Chip Enable	RAM	Random Access Memory
CH	CHannel	RD	ReaD
COMP	COMParator	REG	REGulator
CONT	CONTrol	RESO	RESOnance
CV	Control Voltage	RL	ReLay
DAC	Digital to Analogue Converter	ROM	Read Only Memory
EG	Envelope Generator	S/H	Sample and Hold
EXT	EXTernal	SW	SWitch
FREQ	FREQuency	THRU	THRoUgh
HPF	High Pass Filter	TRANS	TRANSpose
INH	INHibit	U	Upper
INT	INTerrupt	VA	Voltage Analog
INV	INVerter	VCA	Voltage Controlled Amplifier
L	Lower	VCF	Voltage Controlled Filter
LFO	Low Frequency Oscillator	VR	Variable Resistor
MAX	MAXimum	VREF	REFerence Voltage
MEMO	MEMOry	WR	WRite

AKAI ELECTRIC CO., LTD.

12-14, 2-Chome, Higashi-Kojiya, Ohta-Ku, Tokyo, Japan
 SERVICE DEPARTMENT TEL: Tokyo(745)9884 TOKYO TELEX: J28261

Printed No. 890322-A1-400

Printed Date: April 28, 1989

S1000HD