

Service Manual

MODEL: AMX 140FX-USB

CONTENT

1. INTRODUCTION.....	1
2. TECHNICAL SPECIFICATION.....	2
3. BLOCK DIAGRAM.....	4
4. SCHEMATIC DIAGRAM.....	5
5. WIRING DIAGRAM.....	13
6. PCB LAYOUT.....	14
7. TEST PROCEDURE.....	18
8. EXPLODED VIEW & MECHANICAL PARTS LIST.....	25
9. BOM.....	27

1. INTRODUCTION

- 5 MIC input channels with gold plated XLRs and balanced LINE input
- 2 stereo input channels with balanced TRS jacks
- Ultra-low noise discrete MIC pre-amps with +48 Phantom Power
- Extremely high headroom offering more dynamic range
- Balanced inputs for highest signal integrity
- Warm, natural 3-band EQ on each mono channel
- Switch-able Low-cut filter on each mono channel
- Peak LED on each channel
- AUX sends 1/2 per channel for external effects and monitoring
- 4 AUX returns for additional functionality
- 2-Track inputs assignable to main mix, control room/headphone outputs
- Highly accurate 12-segment bar graph meters
- 24 bit digital effects processor with 256 effects (16 presets *16 variations)
- Effect on/off by means of MUTE switch or a footswitch connected to the DFX

FOOTSWITCH

- No software drivers are need with Windows XP and MAC OSX.
- 16 bit 32~48KHz ADC/DAC USB input and output with selectable track
- Adjusts the input sensitivity on each stereo channel
- Performance and excellent noise figures
- Rugged construction ensures long life even under the most demanding conditions.
- Stereo USB Input and output with selectable track
- Manufactured under ISO9001 certified management system.

2. TECHNICAL SPECIFICATION

Mono Input channels	
Microphone Input	Electronically balanced, discrete input configuration
Frequency response	10Hz to 55KHz, +/-3dB
Distortion (THD & N)	0.005% at +4dBu, 1KHz
Gain range	0dB to 44dB (MIC)
SNR (Signal to Noise Ratio)	112dB
Line input	electronically balanced
Frequency response	10Hz to 55KHz, +/-3dB
Distortion (THD & N)	0.005% at +4dBu, 1KHz
Sensitivity range	+15dBu to -30dBu
Stereo input channels	
Line input	balanced
Frequency response	10Hz to 55KHz, +/-3dB
Distortion (THD & N)	0.005% at +4dBu, 1KHz
Impedances	
Microphone input	1.4kOhm
Channel Insert return	2.5kOhm
All other inputs	10kOhm or grater
Tape out	1kOhm
All other output	120Ohm
Equalization	
Hi shelving	+/-15dB @ 12KHz
Mid bell	+/-12dB @2.5KHz
Low shelving	+/-15dB @80Hz
Low Cut filter	75Hz, 18dB/oct.
DSP Section	
A/D and D/A converters	24 bit
DSP resolution	24 bit
Type of effects	Hall, Room, Vocal & Plate REVERBS
	Mono & Stereo DELAY (max DELAY TIME 650ms)
	Chorus, Flanger & Reverb MODULATIONS
	REVERB+DELAY, REVERB+CHOURS
	REVERB+FLANGER combinations
Presets	256
Controls	16-position PRESET Selector
	16-position VARIATION Selector
	PEAK LED

	MUTE SWITCH with LED indicator
USB SECTION	
ADC/DAC	16 Bit 32~48KHz
	Fully Compliant with USB 1.1 specification
	No software drivers are need with windows XP or MAC OSX
Main Mix Section	
Noise (Bus noise)	Fader 0dB, channels muted: -100dBr (ref: +4dBu)
	Fader 0dB, all input channels assigned and set to
	UNITY gain: -90dBr (ref: +4dBu)
Max output	+22dBu balanced XLR
	+22dBu unbalanced, 1/4" jacks
AUX Returns gain range	$-\infty$ to +15dB
AUX Sends max out	+22dBu
Power supply (AC/AC Adaptor)	
Main voltage	USA/Canada 100 - 120V~, 60Hz
	Europe 210 – 240V~, 50Hz
	U.K. /Australia 240V~, 50Hz
Power Consumption	27watts
Physical	
Dimension (WDH)	270mm310mm43mm
	(10.63"12.20"1.69)
Net weight	2.5Kg (6.61lb)

3. BLOCK DIAGRAM

AMX140FX-USB

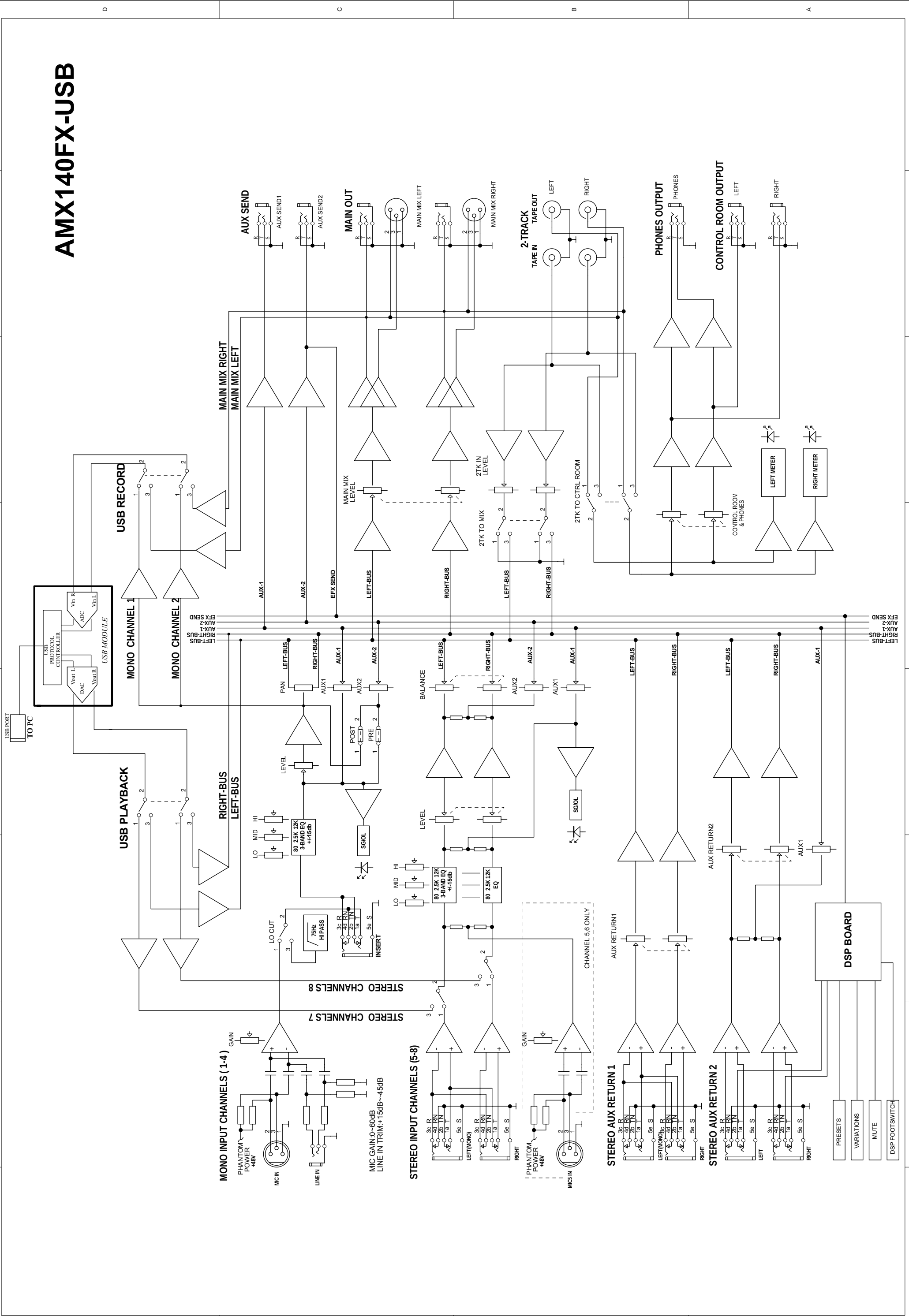

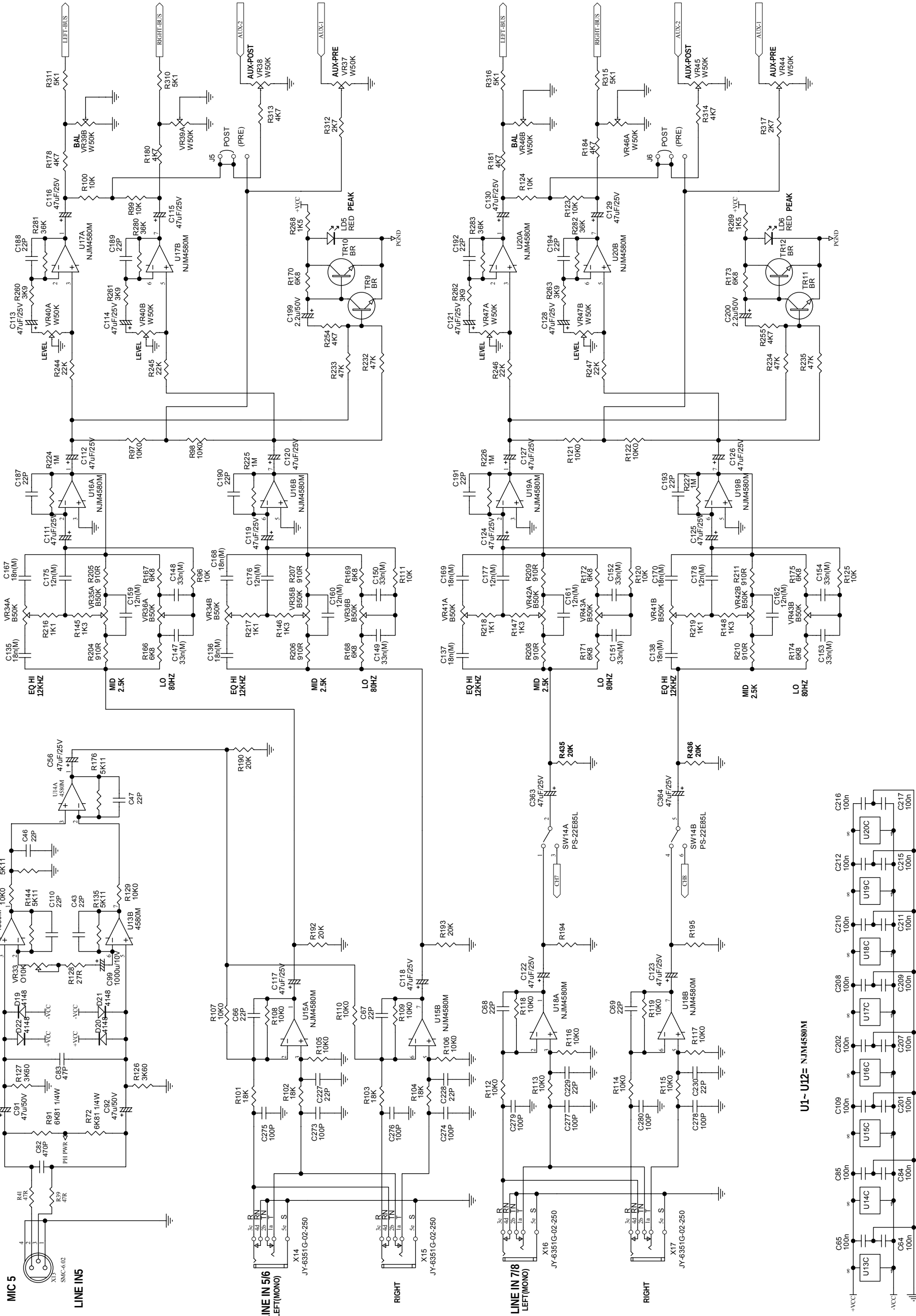

AMX140FX-USB(3/6)

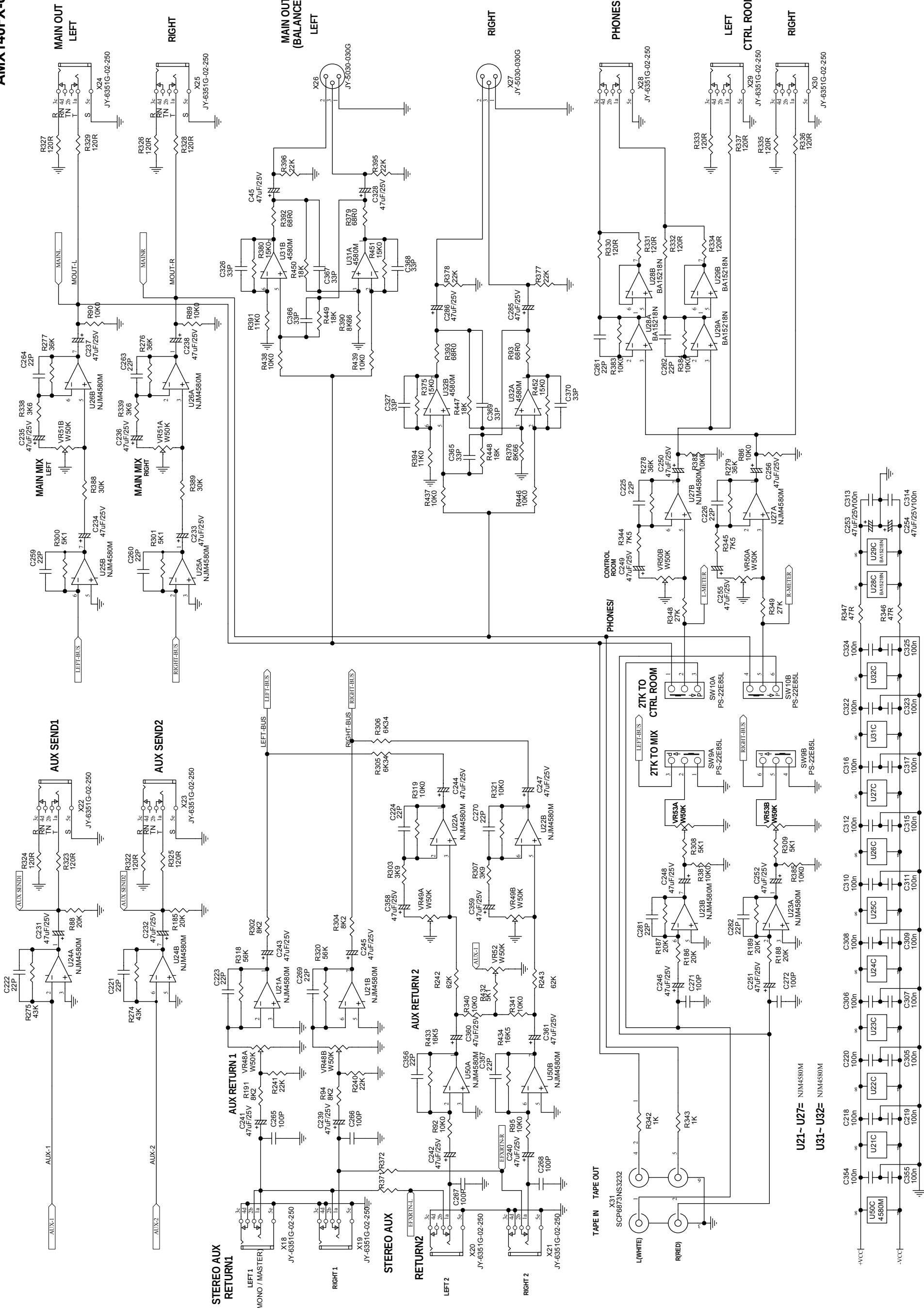

NEW

AMX140FX-USB (6/6)

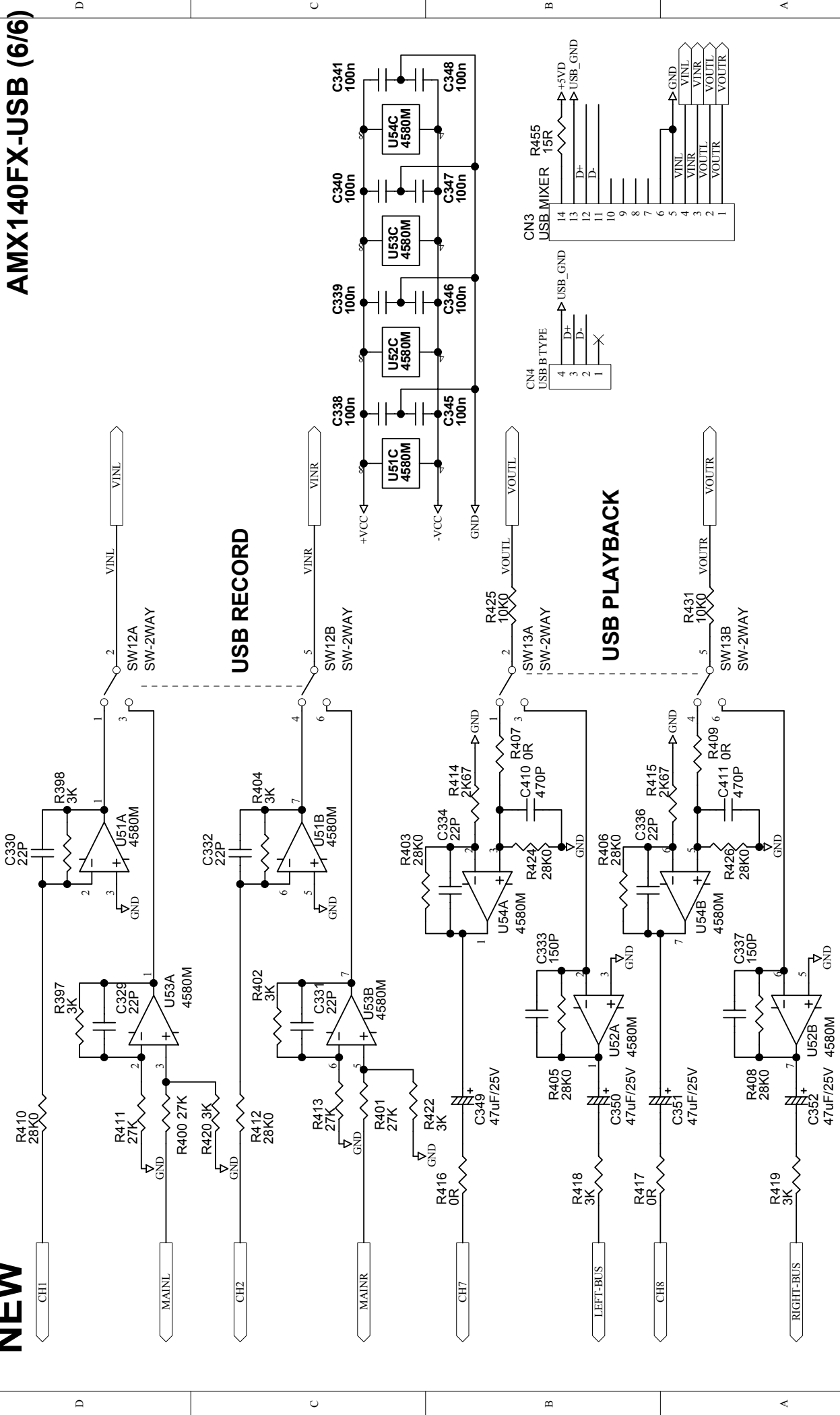

DSP-PRE

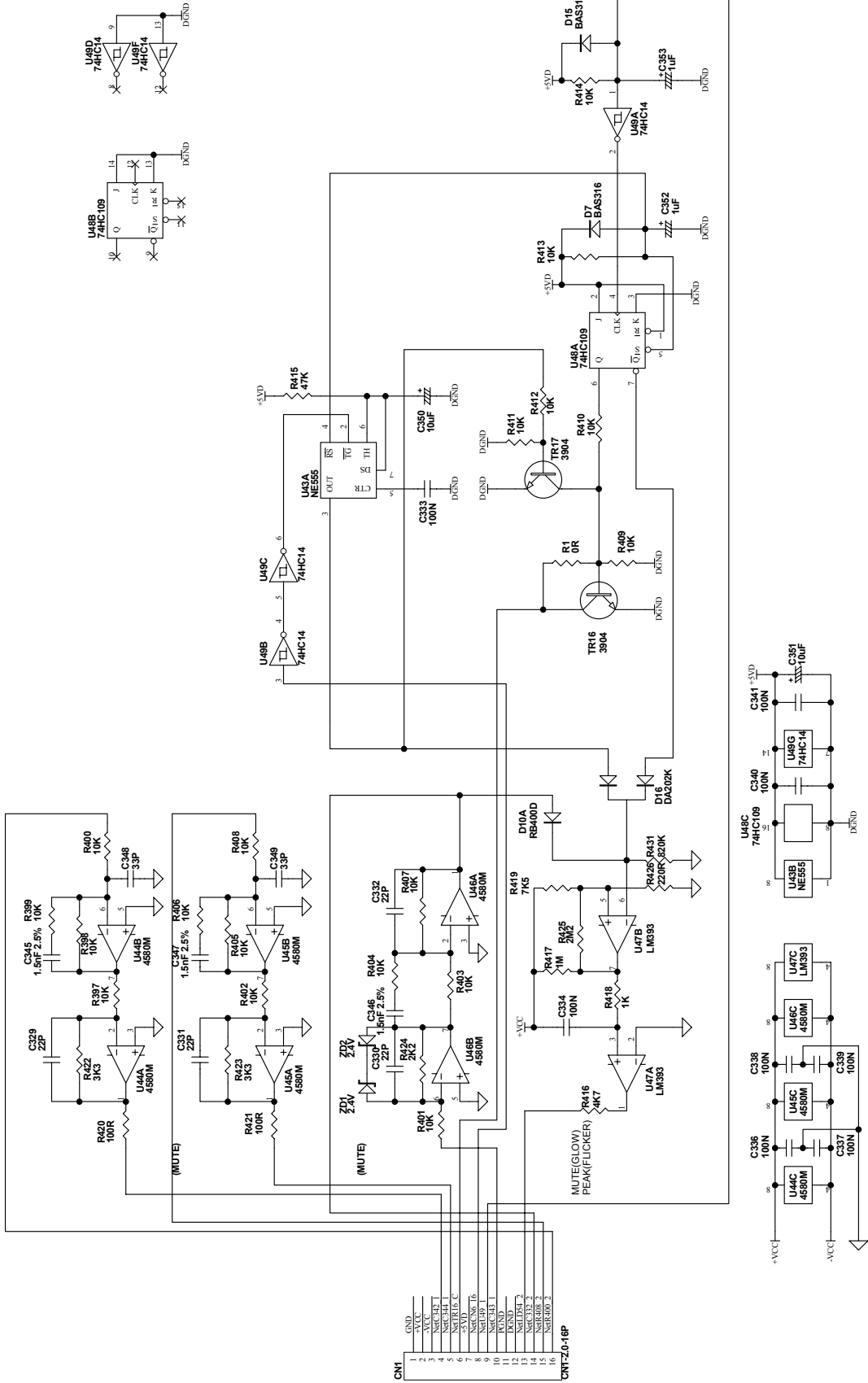

5. WIRING DIAGRAM

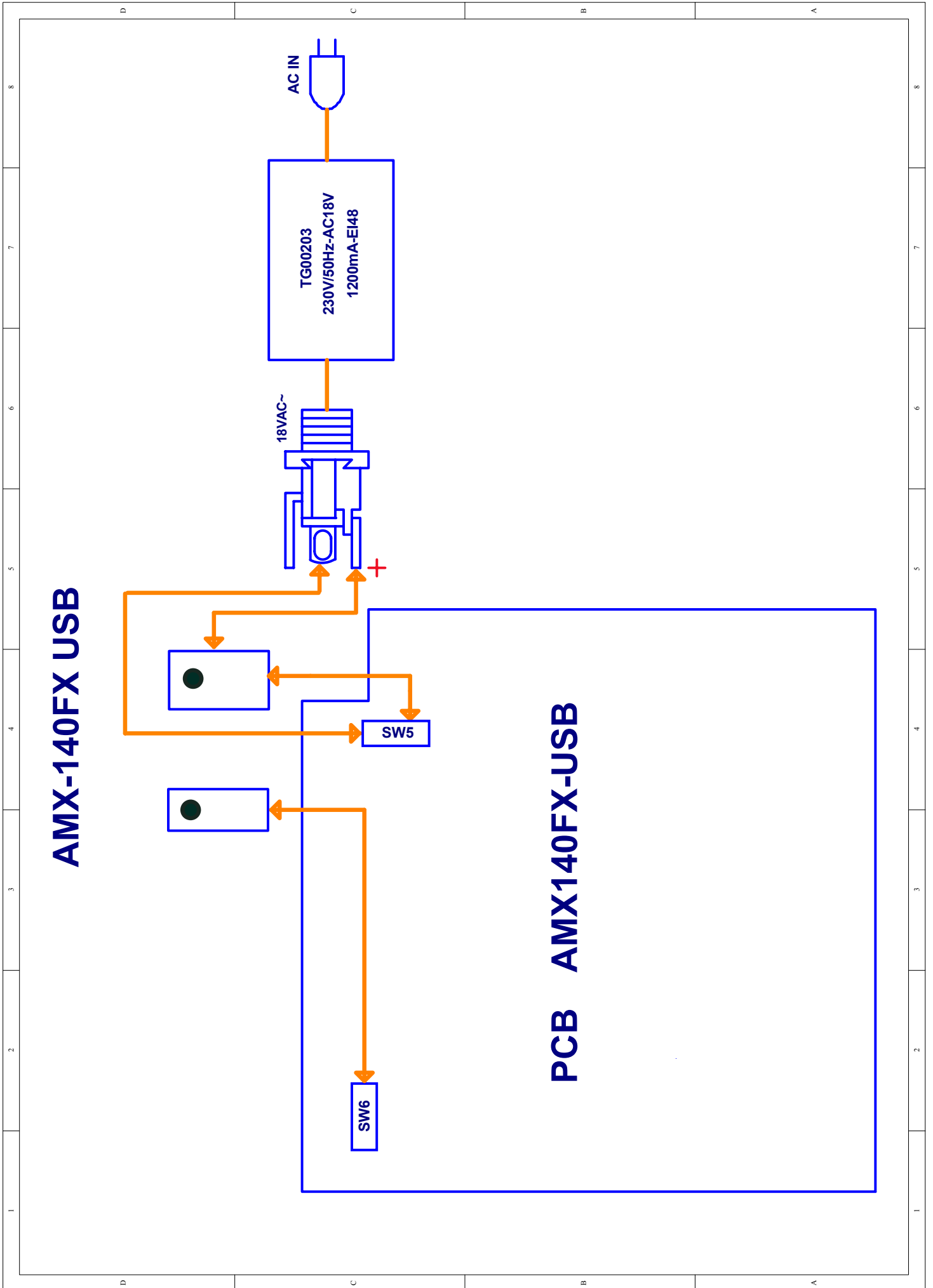

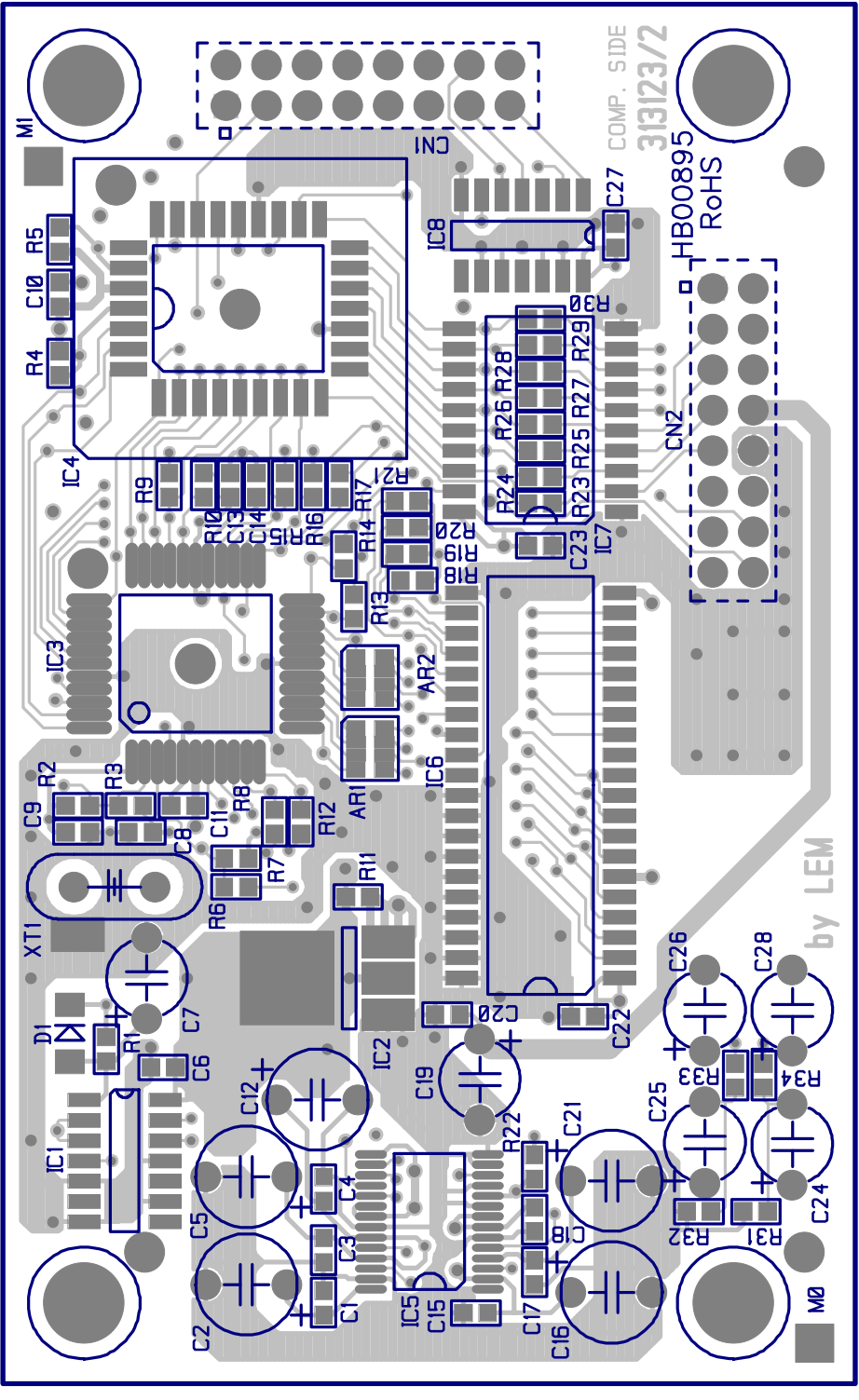
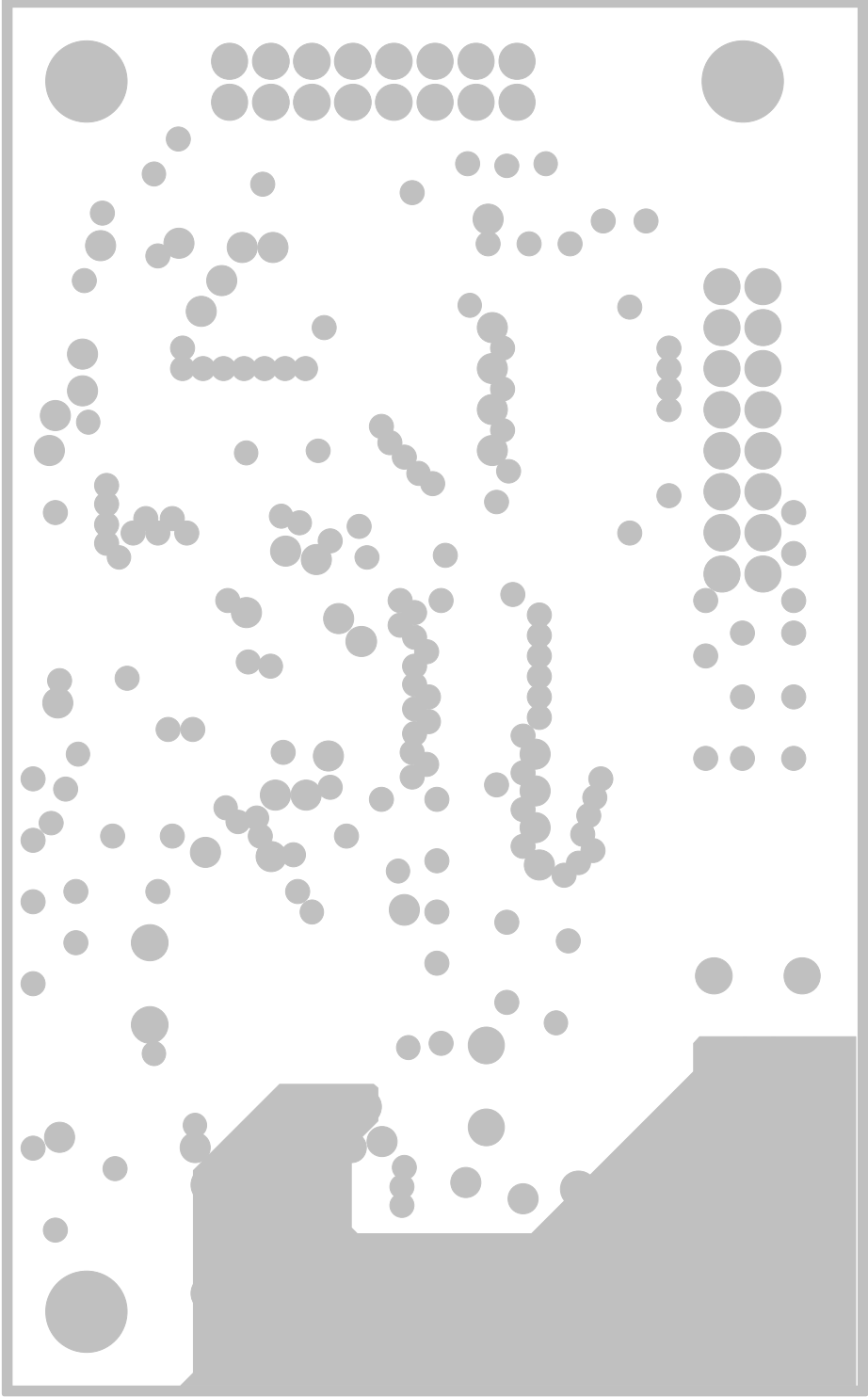
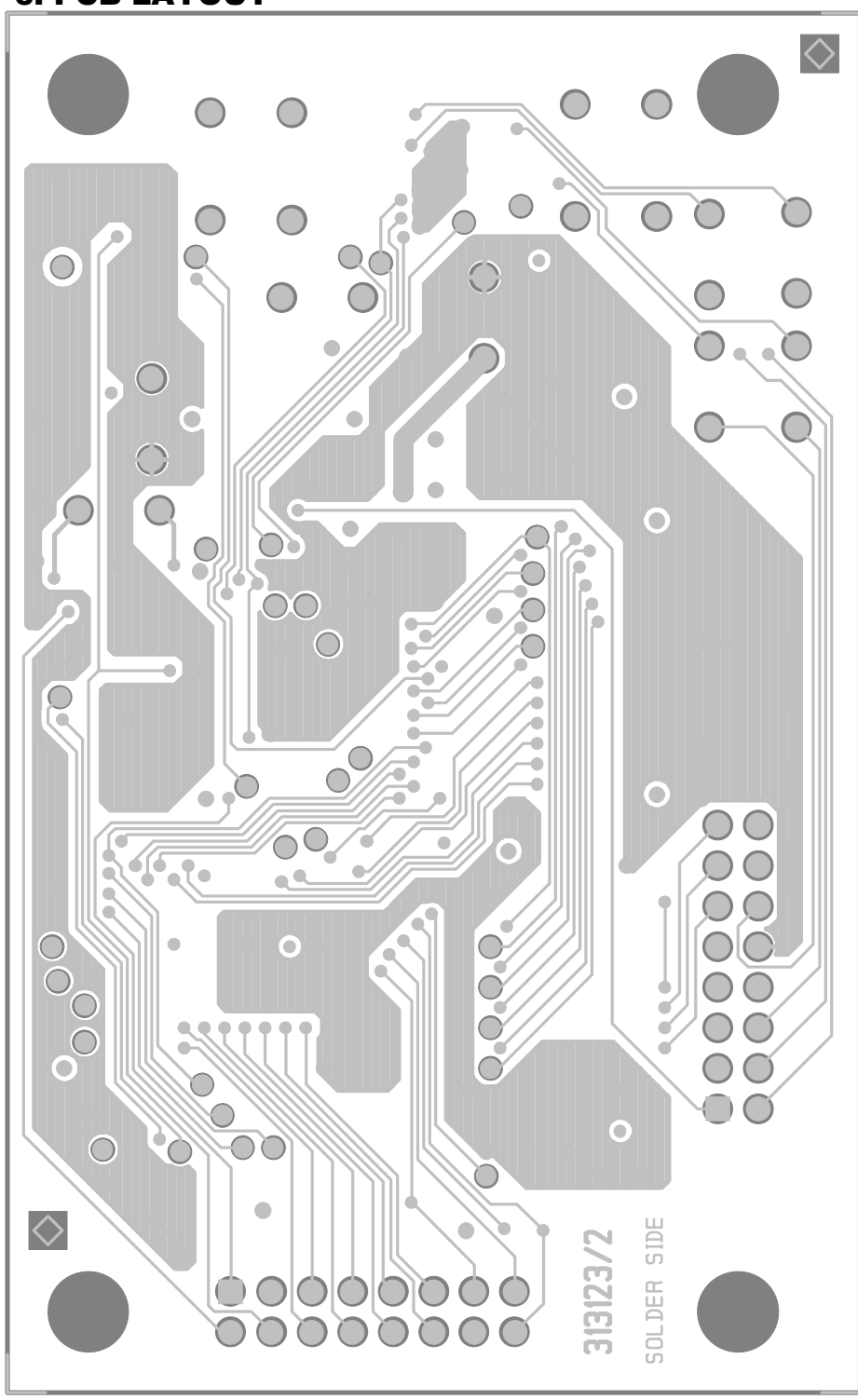
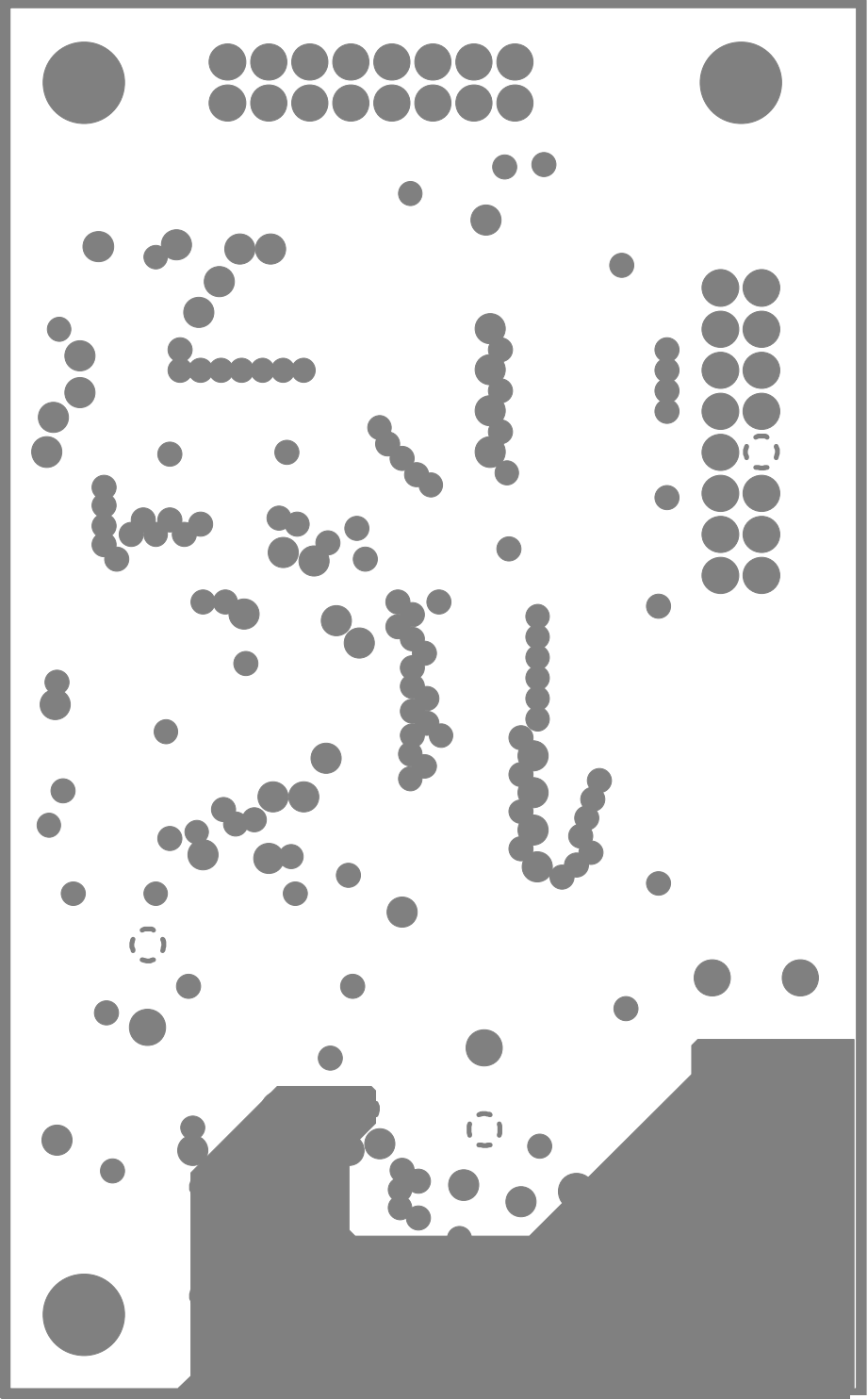

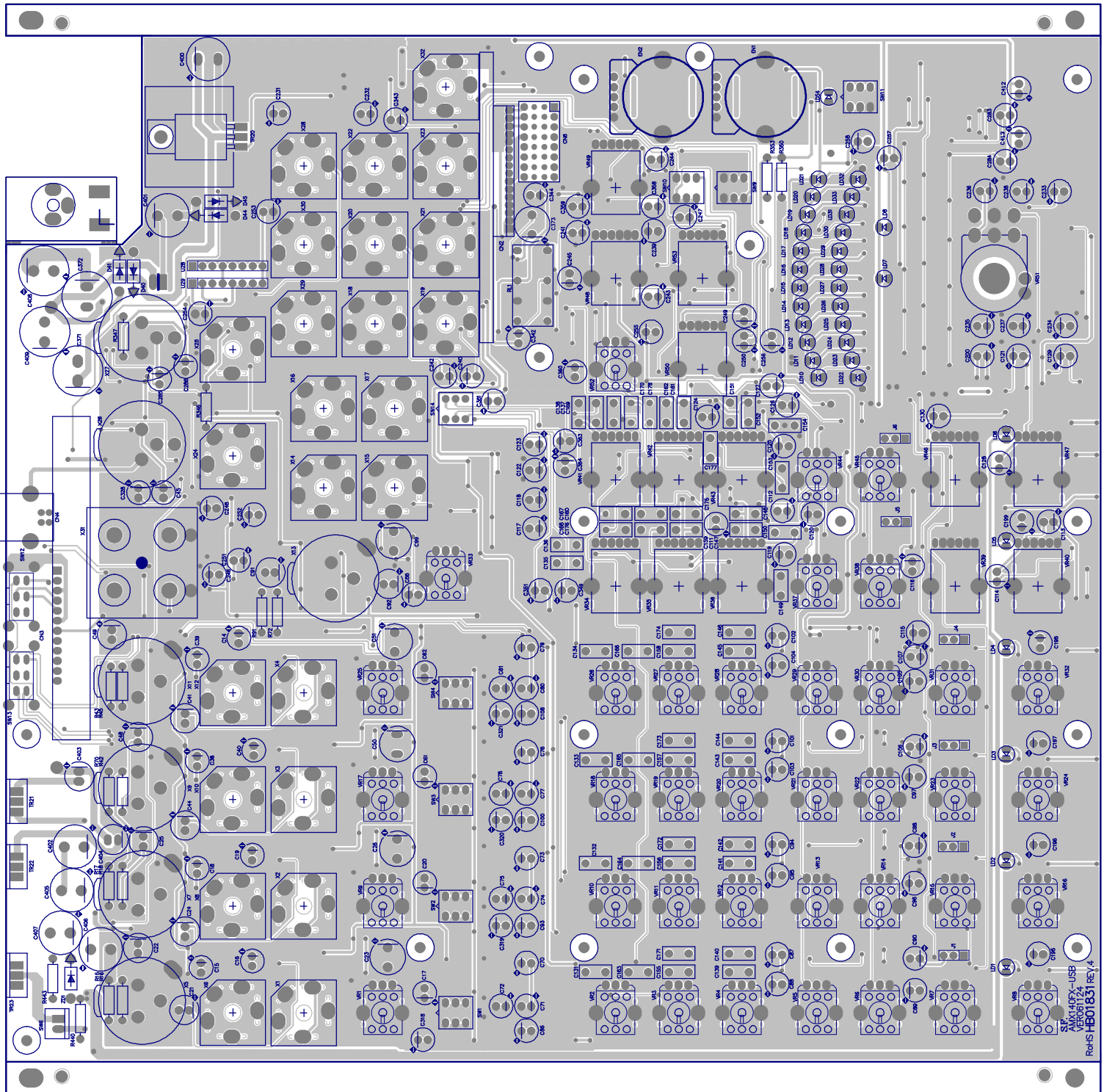
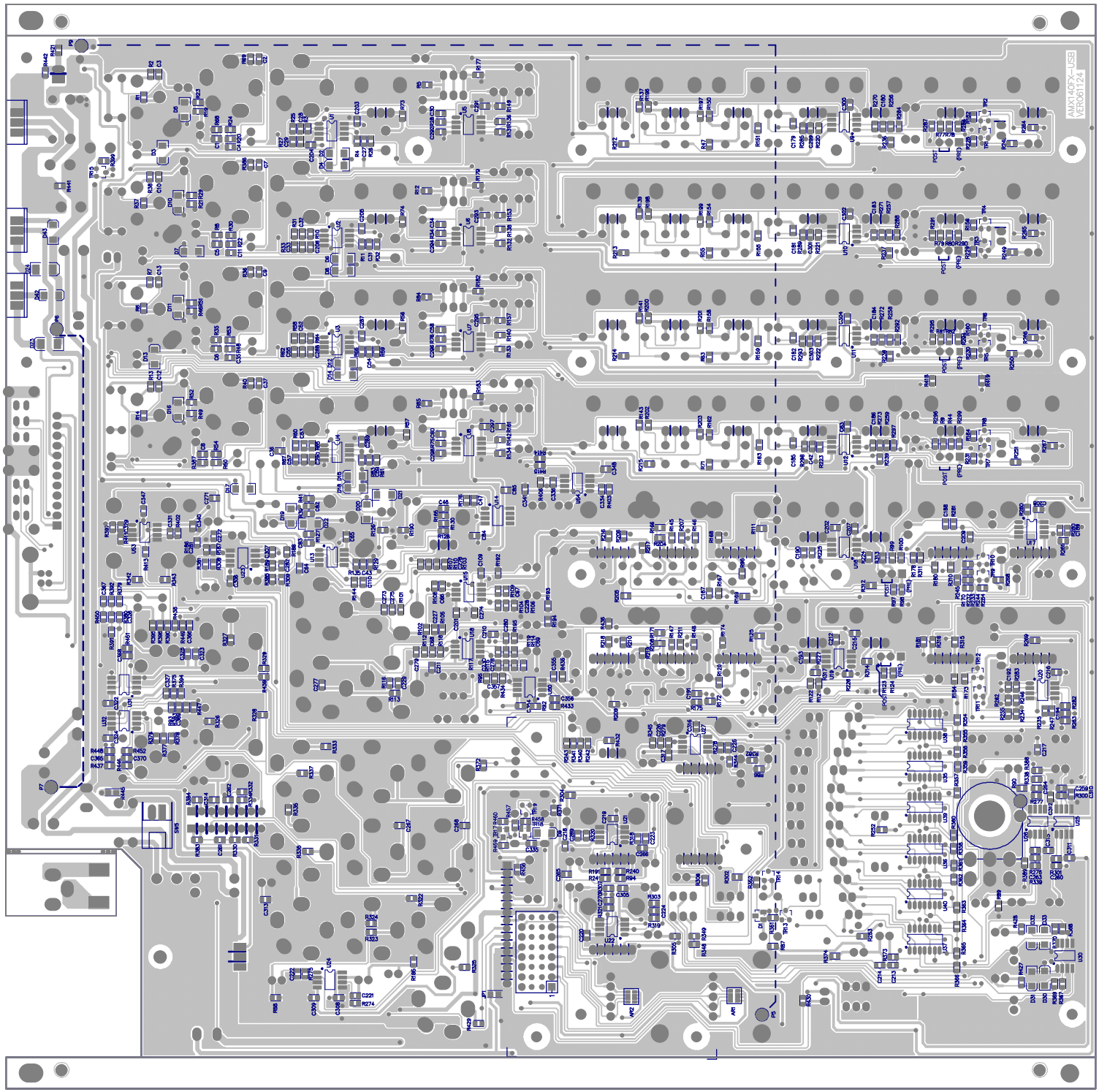

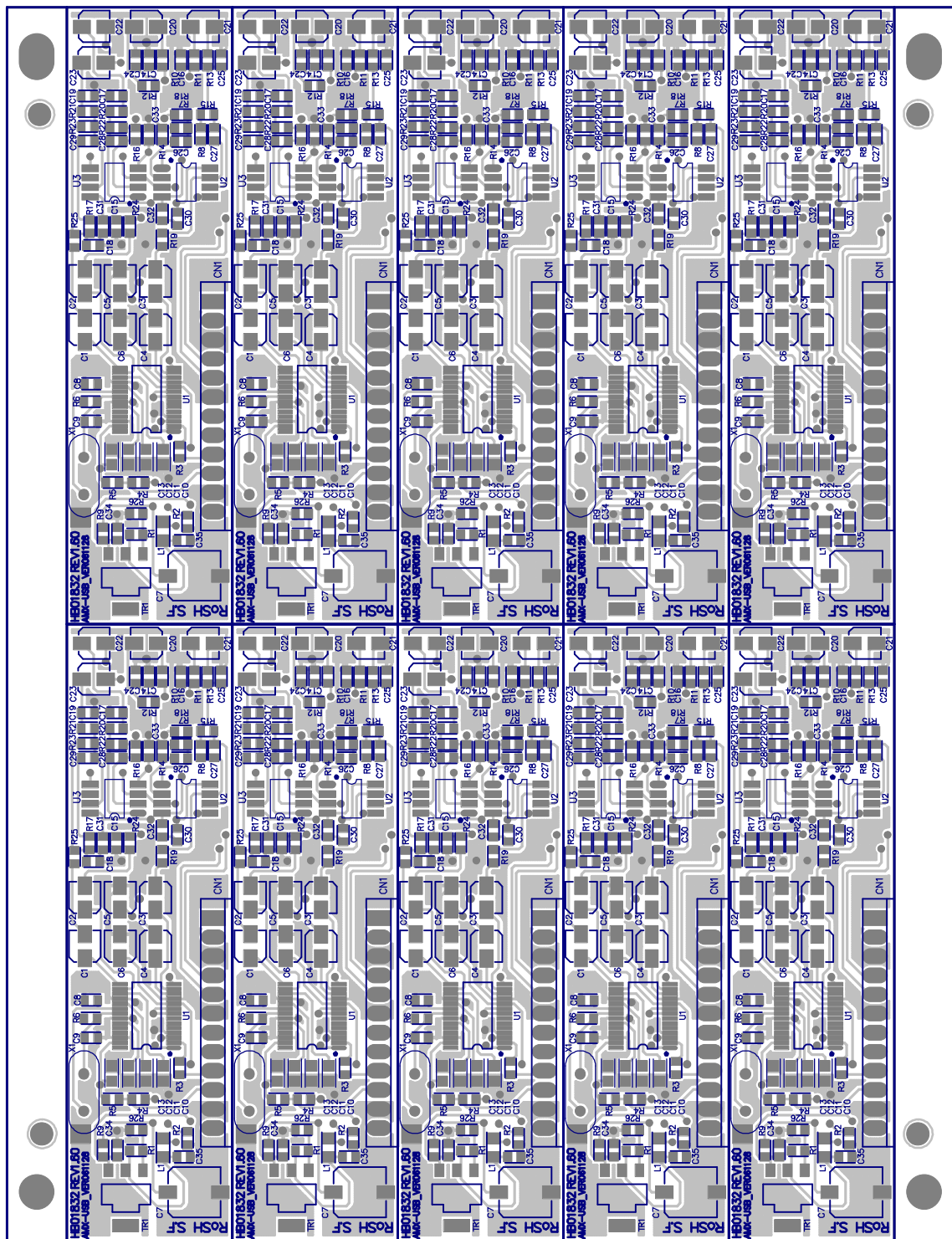
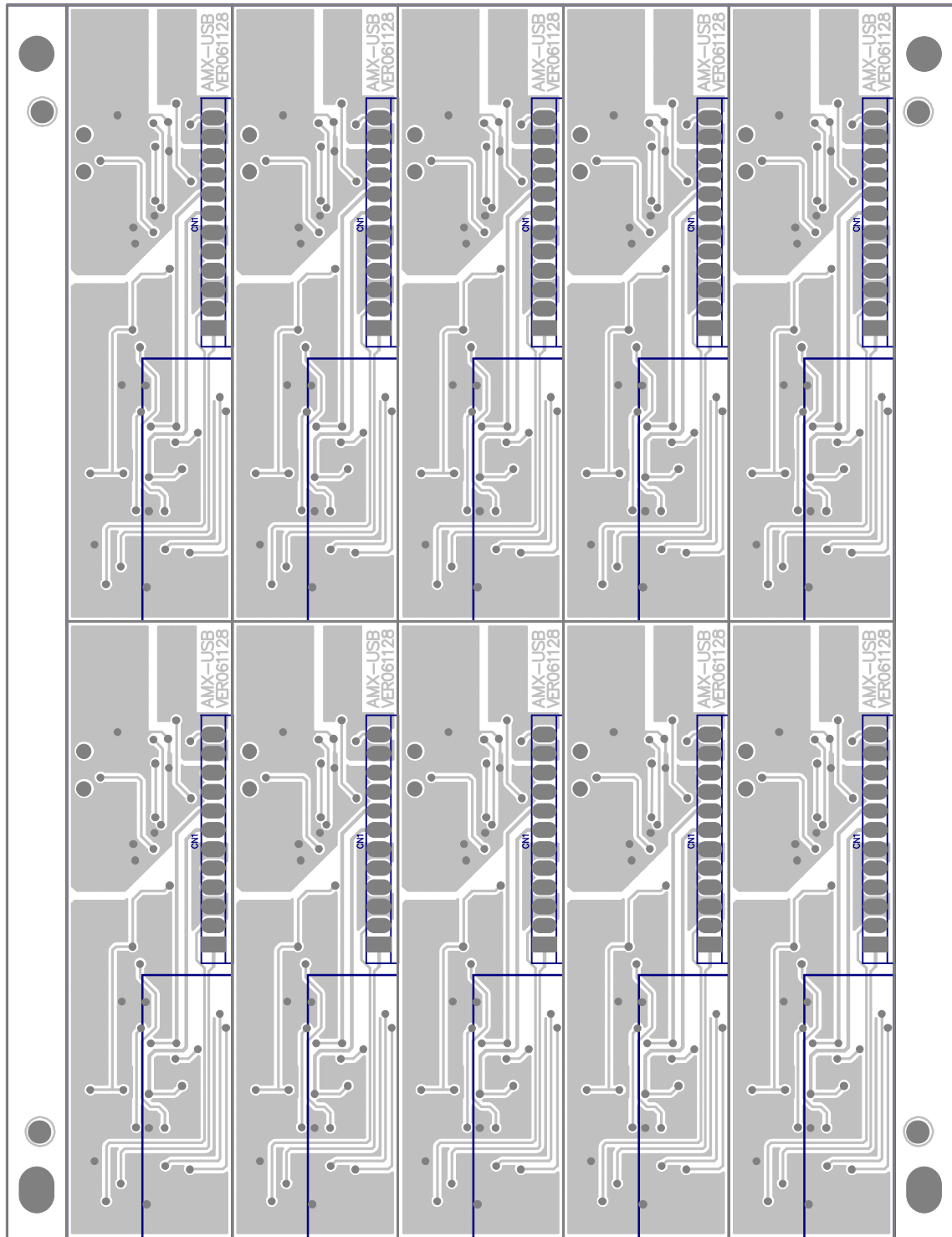

7. TEST PROCEDURE

1. Instruments:

- 1). AP (Audio Precision)
- 2). Dual oscillograph
- 3). Voltmeter
- 4). USB line

2. Instruments Setting:

- 1). AP output: 0dBu 1KHz SINE waveform, Load out 40Ω Bal-Gnd or Load out 20Ω Unbal-Gnd.
- 2). AP input: Load 100kΩ BNC-Float or Load 100KΩ XLR-Bal
BW: 22Hz~22KHz. Fitr: A-Weighting (1207):

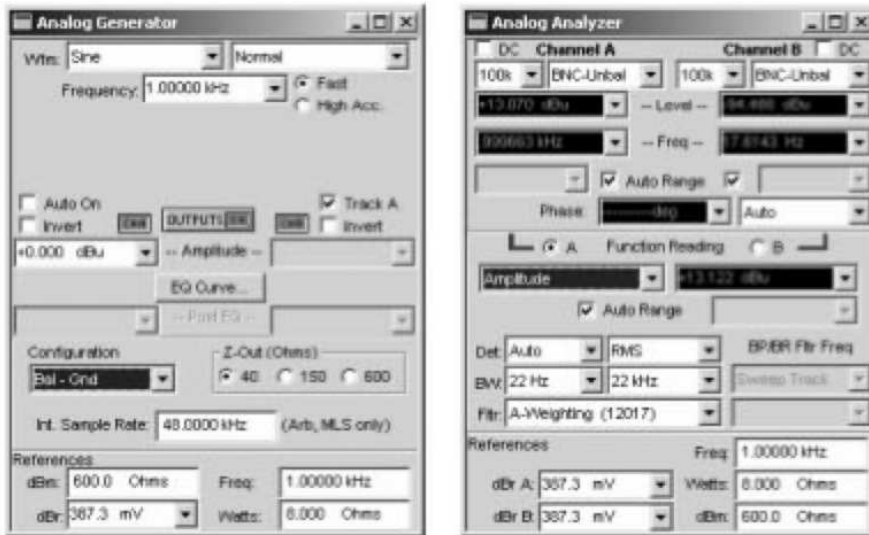

3. Visual Check: check the surface of AMX-140FX USB is OK; and be sure the potentiometer knob has no frication.

4. Functional Test:

- 1). After the surface testing is OK, input proper AC power voltage, open the main power switch, POWER led will light up (green). Then open the PHANTOM switch, the PHANTOM led will light up (red), it has 46V ($\pm 2V$) PHANTOM voltage of the second and third pin on each MIC {MIC1, MIC2, MIC3, MIC4, MIC (MONO)} which had been tested by voltmeter. At last, close the switch (Note: we should close this switch, or the instruments will be damaged).
- 2). Adjust all the TRIM knob to min, the LEVEL, EQ, AUX knob to 0, and the PAN to mid, turn all the keys to OFF.
- 3). Connect the balanced input to MIC {MIC1, MIC2, MIC3, MIC4, MIC (MONO)}, connect

the unbalanced input to LINE IN 5/6, rotate the PAN knob of the corresponding channel on LINE IN 7/8 to LEFT or RIGHT,

- a. The unbalanced output of AUX1, AUX2 which has tested is +2dBu (± 2 dB) THD+N=0.005%;
 - b. Adjust the AUX1, AUX2 knob to min, the unbalanced output (LEFT & RIGHT) of MAIN MIX OUTPUT is -5dBu (± 2 dB) THD+N=0.005% (when it is in MONO input, only the corresponding channel has output). When insert a disconnect stereo jack from CHANNEL INSERT, and input signal from the corresponding MIC channel, there has no output in MAIN MIX OUTPUT.
- 4). Connect the unbalanced input to AUX RETURN2, the unbalanced output (LEFT & RIGHT) on MAIN MIX OUTPUT is -5dBu (± 2 dB) THD+N<0.005%;
 - 5). Connect the unbalanced input to AUX RETURN1, the balanced output (LEFT & RIGHT) on MAIN MIX OUTPUT is -5dBu (± 2 dB) THD+N<0.005%;
 - 6). Connect the RCA terminal to L & R on TAPE IN (rotate the 2TK LEVEL to max),
 - a. Press the 2TK TO MIX key, we can test the unbalanced output (LEFT & RIGHT) on MAIN MIX OUTPUT and the output on CONTROL ROOM, the PHONE output (it should use the STEREO socket for testing) is 0dBu (± 2 dB) THD+N<0.005%, the TAPE OUT output is 0dBu (± 2 dB) THD+N<0.005%.
 - b. Release the 2TK TO MIX key (OFF), and the CONTROL ROOM has no output, when press the 2TK TO CONTROL ROOM, the output is 0dBu (± 2 dB) THD+N<0.005%.
 - 7). Input +15dBu from LINE1, 1KHz SINE waveform (Load out 600 Ω BNC-Gnd), rotate the MAIN MIX LEVEL to min in counterclockwise, and the LED LEVEL indicator will be decreased. Rotate the MAIN MIX LEVEL potentiometer in clockwise; the LED LEVEL indicator will light up in return. The MAIN MIX OUTPUT (LEFT & RIGHT) will match with the LED: whenever the LED point at which level, it will appear the corresponding level, and the max non-distortion is 20dBu (± 1 dB, THD+N<0.1%).
 - b. Rotate the TRIM knob on CHANNEL1 in clockwise; the PEAK led will light up (red). Use the same way to test and see if the corresponding PEAK led of CHANNEL2~CHANNEL4 in normal.
5. Frequency Response Test:
- Input signal from LINE1, LINE2, LINE3, LINE4, LINE5, LINE6, the output frequency curve on MAIN MIX OUTPUT (LEFT & RIHGT). (The initial setting for the entire knob and the functional test: 4.2)).
- 1). Open the AMX-140FX USBRESP1. at1, the curve can be tested when press and release the LOW CUT switch:

Audio Precision

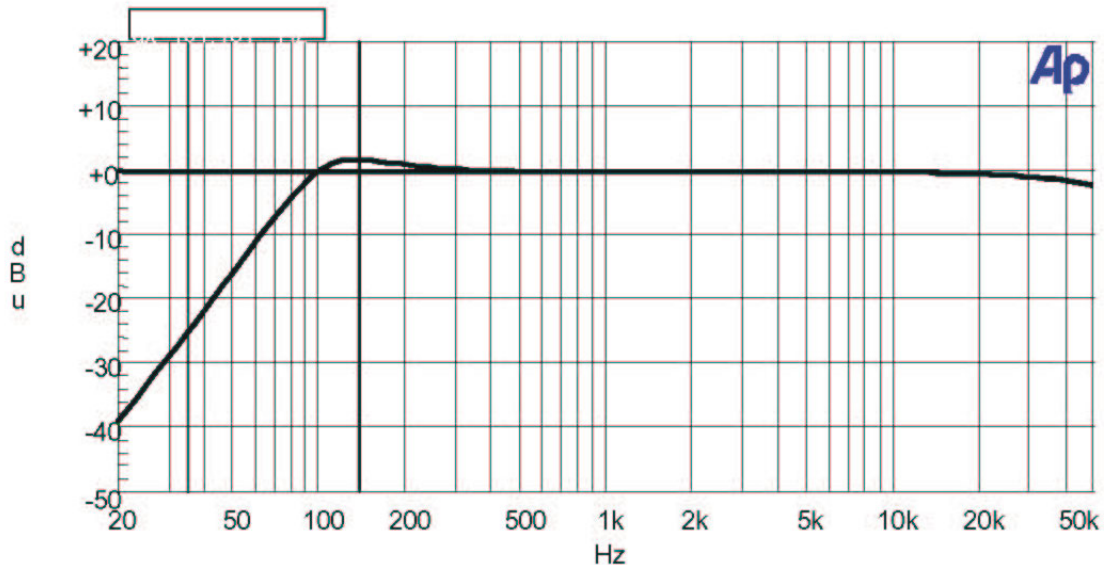

2). When set the EQ HI & LOW knob to max and min (EQ MID to mid), the frequency response curve is:

Audio Precision

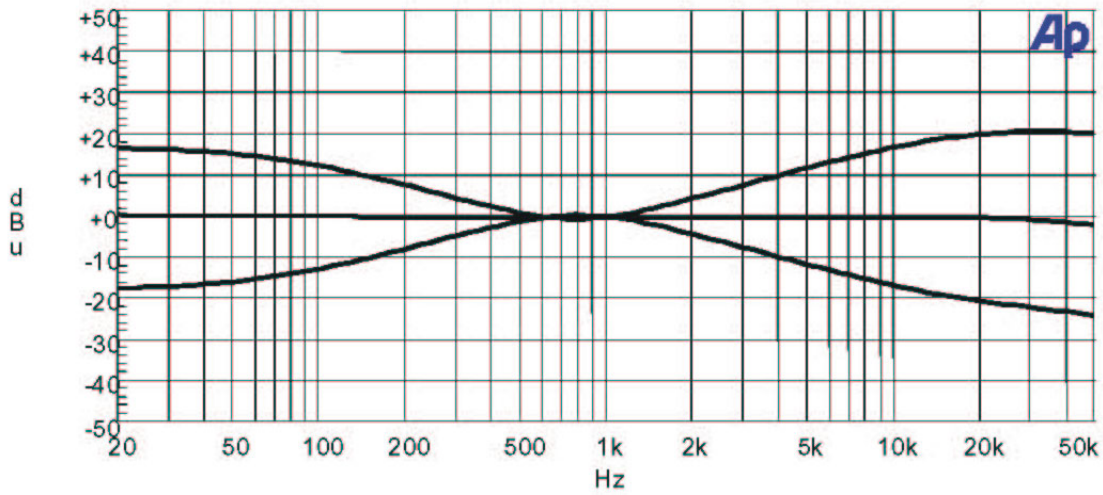

3). When set the EQ MID knob to max and min (EQ HI & LOW to mid), the frequency curve is:

Audio Precision

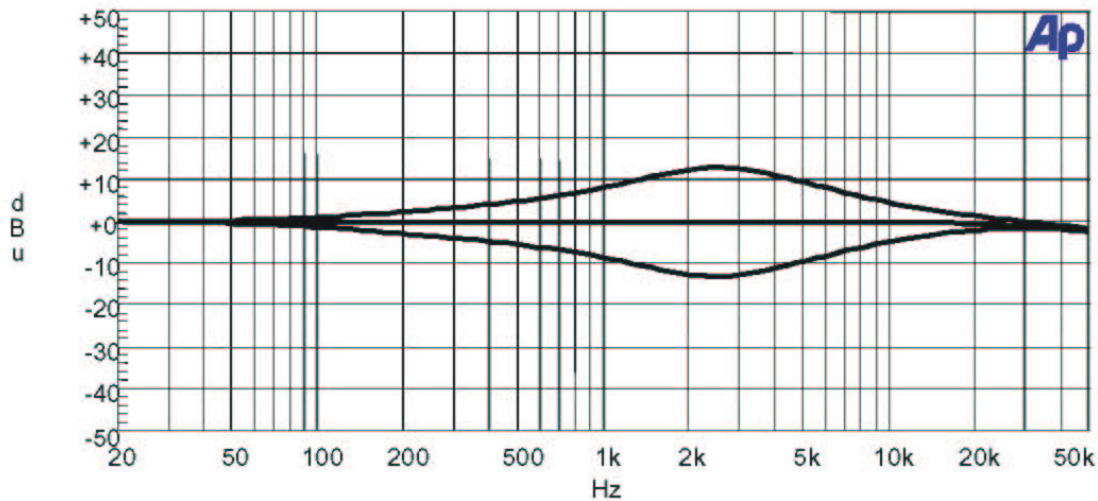

Note: The frequency response test for regular instrument:

- 1). Input signal from each channel, rotate the corresponding channel of EQ LOW knob to max (± 15) in clockwise, and the output is +15dBu (± 2 dBu); rotate the corresponding channel of EQ LOW to min (-15) in counterclockwise, and the output is -15dBu (± 2 dB);
 - 2). Change the input frequency to 2.5KHz, rotate the corresponding channel of EQ MID knob to max (+12) in clockwise, and the output is +12dBu (± 2 dB); rotate the corresponding channel of EQ MID to min, and the output is -12dBu (± 2 dB);
 - 3). Change the input frequency to 12KHz, rotate the corresponding channel of EQ HIGH to max (+15) in clockwise, and the output is +15dBu (± 3 dB).
6. The effect of DSP:
- 1). Input signal from MIC1 to MIC4, output signal from MAIN MIX OUTPUT, rotate the AUX RTN2 (DFX) to max in clockwise, rotate the PRESETS and ARATION knob, it will appear the signal which has been processed by DSP, if the INPUT signal is larger, the PEAK will light up (red), press the DFX MUTE key, it will appear the BYPASS signal.
 - 2). Input signal from MIC1 to MIC4, output signal from AUX SENDS1, rotate the AUX2 to min, rotate the AUX1, AUX RTN2 (DFX), AUX2/DFX TO AUX1 to max in clockwise, rotate the PRESETS and ARATION knob, it will appear the signal which has been processed by DSP, if the INPUT signal is larger, the PEAK led will light up (red), press the DFX MUTE key, it will appear the BYPASS signal.
7. USB Test:
- 1). Set the MAIN MIX LEVEL, PHONES/CONTROL ROOM, EQ, PAN, BAL knob to 0, the TRIM, AUX1, AUX RTN1, AUX RTN2 (DFX), AUX2/DFX TO AUX1, 2TK IN to min, rotate the PAN on CH1 to LEFT, the PAN knob on CH2 to RIGHT, and turn the entire

keys to OFF.

- 2). Input 0dBu to AP, connect the balanced input to MIC1, MIC2, rotate the LEVEL on CH1 CH2 to max, and connect the unbalanced output to MAIN MIX OUTPUT, the output is +10dBu (± 2 dB) THD+N<0.005%.
- 3). Switch the USB RECORD to CH1/2, the USB PLAYBACK to MAIN MIX, and connect the USB line to PC. Open the recorder to tape for 60 seconds:



- 4). Take off the input signal, and press the playing key, the output is +10dBu (± 2 dB) THD+N<0.1%.
- 5). Input 0dBu to AP, connect the balanced input to MIC1, MIC2, rotate the LEVEL on CH1, CH2 to max, the balanced output to MAIN MIX OUTPUT, and the output is +10dBu (± 2 dB) THD+N<0.005%.
- 6). Switch the USB RECORD to MAIN MIX, the USB PLAYBACK of CH7/8, and connect the USB line to PC. Open the recorder to tape for 60 seconds:



- 7). Take off the input signal, press the LINE/USB on CH11/12, rotate the CH LEVEL to 0, press the playing key, and the output is +4dBu (± 2 dB) THD+N<5%.

8). Open the C:\Apwin\S2\A-A FFT. At2 and set as following picture:

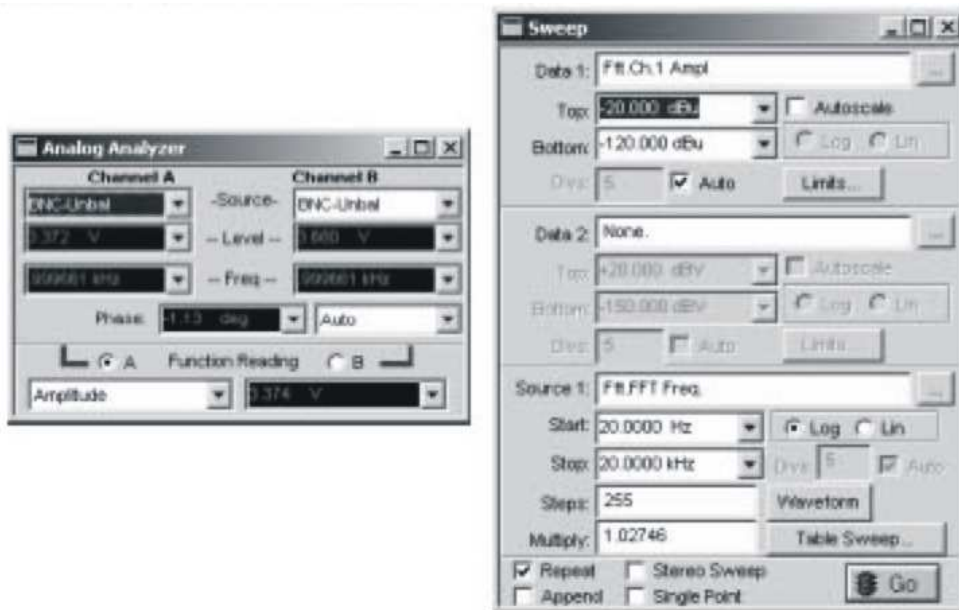

9). Do not input signal, connect the unbalanced output to MAIN MIX OUTPUT, switch the USB RECORD to MAIN MIX, the USB PLAYBACK to MAIN MIX, connect the USB line to PC. Open the recorder to tape for 60 seconds:



10). After recording, press the playing key, the AP will start to scan, the waveform of the picture has not changed much, and connect the high quality amplifier and speaker to see if it will appear high frequency sounding.

Audio Precision A-A FFT SPECTRUM ANALYSIS

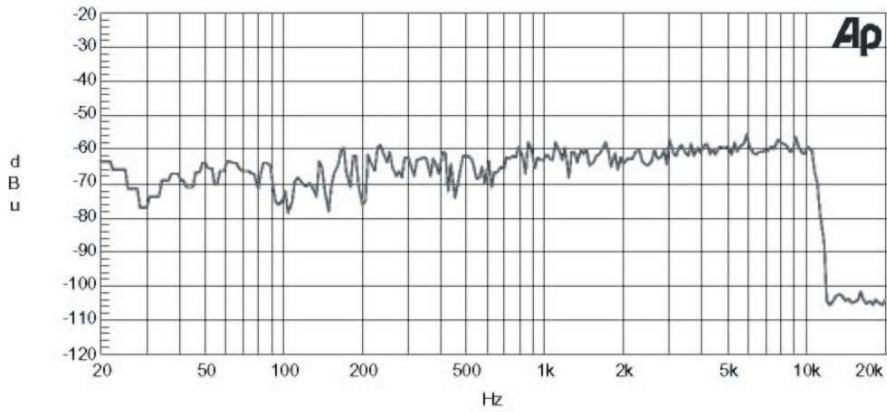

Sweep	Trace	Color	Line Style	Thick	Data	Axis	Comment
1	1	Red	Solid	1	Fit.Ch.1 Ampl	Left	

Requires DSP. Analog Analyzer input is A-D converted and analyzed with the FFT Digital analyzer. Signal source may be Generator or external. Click "Sweep Spectrum/Waveform" sweep button to switch between frequency and A-AFFT.d12

8. Selecting Check: connect the AMX-140FX USB to high quality amplifier and speaker, to see if it will appear abnormal noise.
9. Factory Presets: rotate the entire volume control knob to min, the other control knob to mid, and turn the entire switch OFF.

8. EXPLODED VIEW & PARTS LIST

SEKAKU

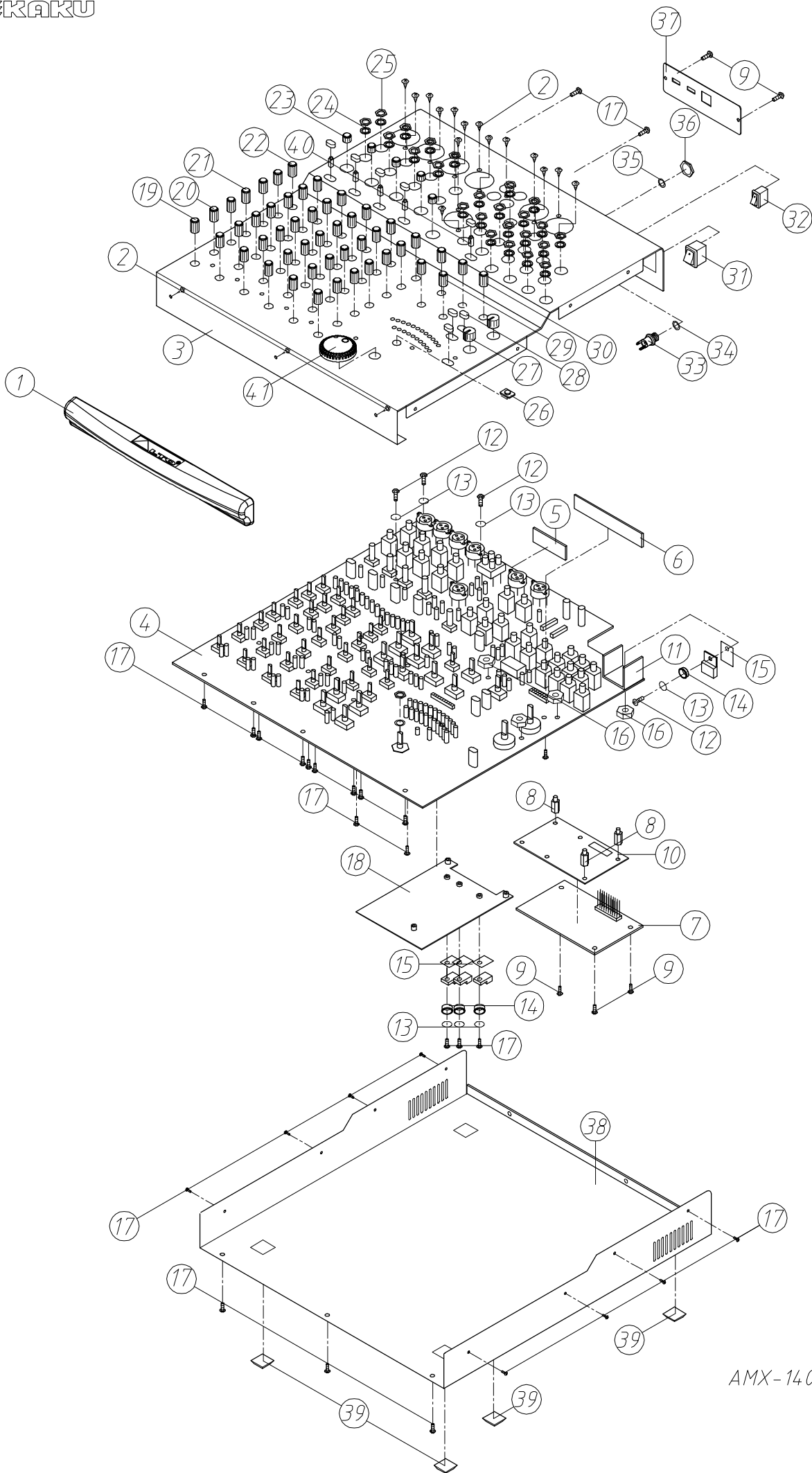

AMX-140FX USB

PARTS LIST

No.	Part No.	Description	Specification	Pcs
1	NI03064	ZC-handle	AMX-140; 140FX-V1.0	1
2	MG00061	screw-RS	M3*10	18
3	MA05704	ZC-panel	AMX-140FX USB ALTO-V1.4	1
4	HK06378	K-PC board	P-AMX140FX-USB-DIP	1
5	HK06381	K-PC board	AMX-USB-DIP	1
6	HK06352	K-PC board	P-DSP-PRE-DIP	1
7	HK01409	K-PC board	P-313123-DIP(AMX-140FX)	1
8	MG00243	copper pillar-RS	M3*5*0.5PH	3
9	MG00326	screw-RS	M3*4	5
10	NI02620	ZD-insulator board-L8-04	1*86.5*53 L-8	1
11	MI01953	ZD-heat sink-AMX100FX-02	AMX-100FX 1.5t*24*21*20.5mm	1
12	MG00162	nickel screw-RS	M3*8	4
13	MF00037	spring washer	φ3.2*φ5.5*1t	7
14	NI02249	insulator-RS	TW-1 (TO-220)	4
15	NC00005	sheet mica-RS	SB-9500DSP 18*13*0.1t-V1.0	4
16	ME00015	color nut-RS	3mm	4
17	MG00041	screw-RS	M3*6	28
18	MI03094	ZD-heat sink-AMX100FX USB-02	AMX-140FX USB 1t*87.5*123-V1.1	1
19	NI00826	plastic knob-RS-C	φ12*18mm dual	6
20	NI02082	plastic knob-RS-C	φ10.5*18mm dual	6
21	NI02081	plastic knob-RS-C	φ10.5*18mm dual	7
22	NI02083	plastic knob-RS-C	φ10.5*18mm dual	18
23	NI02714	plastic knob-RS-C	φ10.5*13.5mm dual	5
24	MF00061	washer	φ9.6*φ13*0.5t	24
25	MF00060	MIC jack nut-HC00125	JY-6351G-02-250	24
26	NI02836	Lens-RS-C	10*7*3mm AMX-140	1
27	NI02386	plastic knob-RS-C	φ14*13mm dual	2
28	NI01863	key-RS	φ5.5*W10*7.5 black	8
29	NI02817	plastic knob-RS-C	φ10.5*18mm dual	2
30	NI02633	plastic knob-RS-C	φ10.5*18mm dual	8
31	HI00026	power switch-RS	RA12KKATOF 2P	1
32	HI00171	power switch-RS	R612KKATOF 1	1
33	HC00601	DC socket-RS	SCD554CCS003000	1
34	NI00378	plastic washer-RS-C	φ9*φ13 used to PU socket	1
35	NC00037	ZD-washer-XM1602-07	1t*φ8*φ12.5mm XM1602-V1.0	1
36	ME00143	nickel screw-HC00601	10 5/6" *32W	1
37	MJ01317	ZC-fixed board	AMX-140FX USB-V1.2	1
38	MB04519	ZCC-chassis	AMX-140FX USB-V1.1	1
39	NI00498	self-adhere foot cushion-RS	12.7*7*6mm (SF-005)	4
40	NI01862	key-RS-C	5.5*5.5*14.5-V1.1	5
41	NI02837	plastic knob-RS-C-ABS	φ35*11mm 534C	1

9. BOM

No.	Part No.	Description	Specification	Remark
1	TG00203	transformer-RS-T	230V/50Hz-AC18V/1200mA-EI48	
2	NE15392	lable	AMX-140FX USB_V1.0	
3	NI00014	membrane	0.035*1M	
4	NH00012	bond paper	0.04*1M	
5	NF02624	user manual-RS	AMX-140FX USB ALTO_V1.0	
6	NI00826	knob	φ12*18mm double color	
7	NI00252	sleeve	φ4*20mm	
8	NI00248	sleeve	φ4*1000mm	
9	NI00498	self-adhere foot cushion	12.7*7*6mm(SF-005)	
10	NI00378	plastic washer	9*13 used to PU socket	
11	NI03064	handle	AMX-140;140FX_V1.0	
12	NI02835	handle	269*33*26mm AMX-140 black	
13	NI02837	knob	φ35*11mm 534C	
14	NI02836	acrylic panel	10*7*3mm AMX-140	
15	NI02714	knob	φ10*13.5mm	
16	NI02633	knob	φ10.5*18	
17	NI02386	konb	φ14*13mm	
18	NI01863	key-RS	φ5.5*W10*7.5	
19	NI01862	key	5.5*5.5*14.5_V1.1	
20	NI02817	knob	φ10.5*18mm	
21	NI02081	knob	φ10.5*18mm	
22	NI02083	knob	φ10.5*18mm	
23	NI02082	knob	φ10.5*18mm	
24	NI00218	cable tie	ALT-102SB	
25	NF00061	assurance card	ALTO	
26	NE05004	label	ALTO	
27	NH00334	cone paper	0.040*1m	
28	NB02752	carton	AMX-140;140FX	
29	NB02890	barrier	AMX-140_V1.0	
30	NB02889	barrier	AMX-140_V1.0	
31	NA00279	clip-chain bag	0.04*100*150mm_V1.0	
32	NA00123	PE bag	0.04*580*300mm	
33	MA05704	panel	AMX-140FX USB ALTO_V2.0	
34	MA05596	panel-RS	AMX-140FX.USB	
35	AE00343	solvent-RS	No330	
36	AE00177	paint-RS	4866	
37	MA05595	panel-RS	AMX-140FX.USB 0.8*43*266.5*293_V1.1	
38	MJ00068	iron board	0.8*2135*1220 16.35kg	
39	MB04519	chassis	AMX-140FX USB_V1.1	
40	MB04412	rear board-RS	AMX-140FX.USB	
41	AE00177	paint-RS	4866	
42	MB04411	rear board-RS	AMX-140FX.USB 0.8*43*269*293_V1.0	
43	MJ00067	single light board	0.8*2135*1220mm 18.69kg	
44	MJ01317	fixed board	AMX-140FX USB_V1.2	
45	MJ01298	fixed board-RS	AMX-140FX.USB	
46	AE00177	paint-RS	4866	
47	MJ01297	fixed board-RS	AMX-140FX.USB 0.8*33*103.5_V1.0	
48	MJ00068	iron board	0.8*2135*1220 16.35kg	
49	MG00041	screw	M3*6	
50	MG00061	screw-RS	M3*10	
51	MG00326	screw	3*4	
52	MF00061	MIC jack	φ9.6*φ13*0.5t	
53	MF00093	washer	φ8.10*φ10.10*0.3t	
54	ME00060	MIC jack	JY-6351G-02-250	
55	HI00171	power switch-RS	R612KKAT0F1	
56	HJ00006	dessicant	30g	

No.	Part No.	Description	Specification	Remark
57	HI00026	power switch-RS	RA12KKATOF 2P	
58	HA01388	wire-RS	2P 100mm UL1007 24AWG	
59	HA01835	wire-RS	70mm brown L5R5	
60	HA01531	wire-RS	2P 250mm UL1007 24AWG	
61	HK06378	PC board	P-AMX140FX-USB-DIP	
62	SD00074	integrated circuit	L7805CV(TO220)/(ST)	TR20
63	RC00369	potentiometer(A10K-41 stage)	W50KΩ RV16A01-30-25F-W50K-3F97	VR51
64	RC00356	potentiometer	Z10KΩ RD09F1130042-10KZ(SAS1);30F	VR1,VR9,VR17,VR25,VR33
65	SD00079	integrated circuit	L7915CV(TO220)/(ST)	TR22
66	SD00077	integrated circuit-RS	L7815CV(TO220)/(ST/MOROCCO)	TR21
67	SD00007	integrated circuit	BA15218N(M5218L)(SIP8)/(ROHM)	U28,U29
68	SB00043	transistor-RS-ACT	TIP122(TO220)/(ST)	TR23
69	SA00054	L.E.D	3m/m round(yellow)long foot 26	LD20,LD33
70	SA00052	L.E.D	φ3 round(green)long foot 26	LD7,LD10,LD11,LD12,LD13,LD14,LD15,LD16,LD17,LD18,LD19,LD22,LD23,LD24,LD25,LD26,LD27,LD28,LD29,LD30,LD31
71	SA00053	L.E.D	φ3 round(red)long foot 26mm	LD1,LD2,LD3,LD4,LD5,LD6,LD8,LD21,LD32,LD54
72	NI01782	LED spacer support	LEDS-11 11mm	LD1,LD2,LD3,LD4,LD5,LD6,LD8,LD54
73	NI01776	LED spacer support	LED-3 3mm	LD7
74	HI00161	relay	RY-5W-K,5V	RL1
75	HI00195	rotary switch	SDB161PVB15.5F-1-4-16-16PC	EN1,EN2
76	HI00238	push-button switch-RS	2 6P PS-92 26A(NON-LOCK)	SW11
77	HI00236	push-button switch-RS	2 6P PS-92 26A(SELF-LOCK)	SW1,SW2,SW3,SW4,SW9,SW10,SW14
78	HI00125	slide switch	SL20202-25Y-6mm	SW12,SW13
79	HC00403	RCA jack	SCP6873NS3232T2 4P	X31
80	HC00392	balance MIC jack-RS	JY-5030-030G 180°	X26,X27
81	HC00076	connector(male)	2P 2.5mm 180°	SW6
82	HC00126	balance MIC jack-RS	JY-5042-030G female plug 180°	X5,X7,X9,X11,X13
83	HC00473	connector-RS-ACT	2.45mm 180° 2*8P B25-2*8BG1(B)H=5mm	CN6
84	HC00125	MIC jack-RS	JY-6351G-02-250	X1,X2,X3,X4,X6,X8,X10,X12,X14,X15,X16,X17,X18,X19,X20,X21,X22,X23,X24,X25,X28,X29,X30,X32
85	HC00065	connector(male)	2P 2.5mm 90°	SW5
86	CB00187	electrolytic capacitor	100uF/100V φ10*20mm	C401,C402,C407,C405
87	HA00276	wire-RS	114mm black L3R3	P6 TO P7
88	HA01826	wire-RS	164mm L3R3	
89	CB00252	electrolytic capacitor	1500uF/25V φ12.5*20mm 5mm	C408,C409
90	CB00065	electrolytic capacitor	470uF/25V φ10*16mm	C371,C372
91	MI03094	heat-sink	AMX-140FX.USB 1t*87.5*123_V1.2	
92	MJ00999	AL plate-RS	1*2000*1000 5.44kg	
93	ME00032	iron pillar	hexagon6.35*M3*5.2	
94	ME00166	iron pillar	M3*3_V1.0	
95	NI03210	spacer support	AMX 140_V1.0	
96	NC00005	mica	SB-9500DSP 18*13*0.1t_V1.0	
97	NI02249	plastic washer	TW-1(TO-220)	
98	MF00037	washer	φ3.2*φ5.5*1t	
99	MG00166	screw	M3*10	
100	MG00041	screw	M3*6	
101	ME00015	color nut	3m/m	
102	MI01953	heat sink	AMX-100FX 1.5t*24*21*20.5mm_V1.2	
103	MJ00092	AL plate-RS	1.5*2000*1000 8.16kg	
104	HK06380	PC board	P-AMX140FX-USB-SMD	
105	RD00224	SMD precise resistor 1/10W	100KΩ ±1% 0603	R367,R368,R369,R370,R421
106	CI00059	SMD ceramic capacitor 0603	100PF/50V NPO ±5%	C265,C266,C267,C268,C271,C272,C273,C274,C275,C276,C277,C278,C279,C280,C334,C336

No.	Part No.	Description	Specification	Remark
107	CI00075	SMD ceramic capacitor 0603	0.1uF/50V Y5V +80,-20%	C42,C63,C64,C65,C84,C85,C109,C201,C202,C203,C204,C205,C206,C207,C208,C209,C210,C211,C212,C213,C214,C215,C216,C217,C218,C219,C220,C287,C288,C289,C290,C291,C292,C293,C294,C295,C296,C297,C298,C299,C300,C301,C302,C303,C304,C305,C306,C307,C308,C309,C310,C311,C312,C313,C314,C315,C316,C317,C322,C323,C324,C325,C335,C340,C341,C347,C348,C354,C355
108	RD00214	SMD precise resistor 1/10W	10.0KΩ ±1% 0603	R47,R55,R63,R71,R87,R96,R99,R100,R111,R120,R123,R124,R125,R428,R457,R458,R25,R26,R31,R32,R58,R59,R60,R61,R86,R89,R90,R92,R95,R97,R98,R105,R106,R107,R108,R109,R110,R112,R113,R114,R115,R116,R117,R118,R119,R121,R122,R129,R130,R319,R321,R340,R341,R381,R382,R383,R384,R385,R437,R438,R439,R446,R397,R402,R411,R413,R427,R414,R415
109	RD00334	SMD precise resistor 1/10W	11.0KΩ ±1% 0603	R19,R20,R21,R22,R46,R48,R49,R50,R391,R394
110	RD00069	SMD fixed resistor 1/10W	120Ω ±5% 0603	R322,R323,R324,R325,R326,R327,R328,R329,R330,R331,R332,R333,R334,R335,R336,R337,R355
111	RD00218	SMD precise resistor 1/10W	15.0KΩ ±1% 0603	R375,R380,R451,R452
112	RD00368	SMD precise resistor 1/10W	16.5KΩ ±1% 0603	R433,R434
113	RD00473	SMD precise resistor 1/10W	18.0KΩ ±1% 0603	R101,R102,R103,R104,R447,R448,R449,R450
114	RD00282	SMD precise resistor 1/10W	1.00KΩ ±1% 0603	R342,R343
115	RD00350	SMD fixed resistor 1/10W	1.1KΩ ±5% 0603	R212,R213,R214,R215,R216,R217,R218,R219
116	RD00351	SMD fixed resistor 1/10W	1.3KΩ ±5% 0603	R136,R137,R138,R139,R140,R141,R142,R143,R145,R146,R147,R148,R363
117	RD00085	SMD fixed resistor 1/10W	1.5KΩ ±5% 0603	R264,R265,R266,R267,R268,R269,R418,R419
118	RD00292	SMD precise resistor 1/10W	1.00MΩ ±1% 0603	R220,R221,R222,R223,R224,R225,R226,R227
119	RD00219	SMD precise resistor 1/10W	20.0KΩ ±1% 0603	R5,R12,R84,R85,R88,R177,R179,R182,R183,R185,R186,R187,R188,R189,R190,R192,R193,R435,R436,R456
120	RD00542	SMD precise resistance 1/10W	220Ω±1% 0603	R429,R430
121	RD00105	SMD fixed resistor 1/10W	22KΩ ±5% 0603	R236,R237,R238,R239,R240,R241,R244,R245,R246,R247,R366,R377,R378,R395,R396
122	CI00051	SMD ceramic capacitor 0603	22PF/50V C0G±5%(C1608C0G1H220JT)/T	C27,C28,C29,C30,C31,C32,C33,C34,C43,C46,C47,C52,C53,C54,C55,C57,C58,C59,C60,C66,C67,C68,C69,C110,C179,C180,C181,C182,C183,C184,C185,C186,C187,C188,C189,C190,C191,C192,C193,C194,C221,C222,C223,C224,C225,C226,C227,C228,C229,C230,C259,C260,C261,C262,C263,C264,C269,C270,C281,C282,C329,C331,C356,C357
123	RD00106	SMD fixed resistor 1/10W	27KΩ ±5% 0603	R348,R349
124	RD00265	SMD fixed resistor 1/10W	27Ω ±5% 0603	R56,R57,R73,R74,R128
125	RD00203	SMD precise resistor 1/10W	2.00KΩ ±1% 0603	R364
126	RD00089	SMD fixed resistor 1/10W	2.7KΩ ±5% 0603	R312,R317
127	RD00107	SMD fixed resistor 1/10W	30KΩ ±5% 0603	R388,R389
128	RD00076	SMD fixed resistor 1/10W	330Ω ±5% 0603	R359,R360
129	CI00053	SMD ceramic capacitor 0603	33PF/50V C0G±5%(C1608C0G1H330JT)/T	C326,C327,C365,C366,C367,C368,C369,C370
130	RD00407	SMD precise resistor 1/10W	36.0KΩ ±1% 0603	R270,R271,R272,R273,R276,R277,R278,R279,R280,R281,R282,R283
131	RD00345	SMD fixed resistor 1/10W	390KΩ ±5% 0603	R441
132	RD00406	SMD precise resistor 1/10W	3.60KΩ ±1% 0603	R23,R24,R29,R30,R51,R52,R53,R54,R126,R127,R338,R339
133	RD00092	SMD fixed resistor 1/10W	3.9KΩ ±5% 0603	R256,R257,R258,R259,R260,R261,R262,R263,R303,R307
134	SE00011	SMD rectifier diode	RLS4148 0.5A (LL-34)	D2,D3,D4,D5,D6,D7,D8,D10,D11,D12,D13,D14,D15,D16,D17,D18,D19,D20,D21,D22,D30,D31,D32,D33,D9,D42,D43
135	RD00110	SMD fixed resistor 1/10W	43KΩ ±5% 0603	R274,R275
136	SG00558	integrated circuit-RS	4580M(SOP8)/(YW)	U1,U2,U3,U4,U5,U6,U7,U8,U13,U14,U30,U31,U32,U50,U53,U54,U9,U10,U11,U12,U15,U16,U17,U18,U19,U20,U21,U22,U23,U24,U25,U26,U27
137	CI00063	SMD ceramic capacitor 0603	470PF/50V NPO ±5%	C1,C2,C3,C5,C6,C7,C8,C9,C10,C12,C13,C37,C82
138	RD00078	SMD fixed resistor 1/10W	470Ω ±5% 0603	R351,R352,R356,R357,R358,R460

No.	Part No.	Description	Specification	Remark
139	RD00339	SMD precise resistor 1/10W	47.0KΩ ±1% 0603	R228,R229,R230,R231,R232,R233,R234,R235,R399,R442,R459
140	CI00055	SMD ceramic capacitor 0603	47PF/50V COG±5%(C1608C0G1H470JT)/T	C4,C11,C35,C36,C83
141	RD00298	SMD precise resistor 1/10W	47.0Ω ±1% 0603	R1,R2,R6,R7,R13,R14,R37,R38,R39,R41,R373,R374
142	RD00093	SMD fixed resistor 1/10W	4.7KΩ ±5% 0603	R9,R44,R77,R78,R79,R80,R81,R82,R178,R180,R181,R184,R248,R249,R250,R251,R253,R254,R255,R313,R314
143	RD00371	SMD precise resistor 1/10W	51.1KΩ ±1% 0603	R35,R36,R68,R69,R8,R40,R386,R387
144	RD00347	SMD fixed resistor 1/10W	510Ω ±5% 0603	R361
145	RD00112	SMD fixed resistor 1/10W	56KΩ ±5% 0603	R318,R320,R403,R406
146	RD00346	SMD fixed resistor 1/10W	56Ω ±5% 0603	R354
147	SE00048	SMD Schottky barrier diode	1A/20V PRL5817(SOD87)/(PHI)	D23,D24
148	RD00094	SMD fixed resistor 1/10W	5.1KΩ ±5% 0603	R286,R287,R290,R291,R294,R295,R296,R299,R300,R301,R308,R309,R310,R311,R315,R316,R432
149	RD00210	SMD precise resistor 1/10W	5.11KΩ ±1% 0603	R3,R4,R10,R11,R27,R28,R33,R34,R62,R64,R65,R66,R67,R75,R76,R83,R135,R144,R165,R176
150	RD00095	SMD fixed resistor 1/10W	5.6KΩ ±5% 0603	R365
151	RD00348	SMD fixed resistor 1/10W	620Ω ±5% 0603	R362
152	RD00113	SMD fixed resistor 1/10W	62KΩ ±5% 0603	R131,R132,R133,R134,R242,R243
153	RE00011	SMD resistor networks 1/16W	680Ω*4 ±5% 8P 0603	AR1,AR2
154	RD00394	SMD precise resistor 1/10W	68.0Ω ±1% 0603	R93,R379,R392,R393
155	RD00287	SMD precise resistor 1/10W	6.34KΩ ±1% 0603	R305,R306
156	RD00097	SMD fixed resistor 1/10W	6.8KΩ ±5% 0603	R149,R150,R151,R152,R153,R154,R155,R156,R157,R158,R159,R160,R161,R162,R163,R164,R166,R167,R168,R169,R170,R171,R172,R173,R174,R175
157	RD00098	SMD fixed resistor 1/10W	7.5KΩ ±5% 0603	R344,R345
158	RD00082	SMD fixed resistor 1/10W	820Ω ±5% 0603	R252
159	RD00289	SMD precise resistor 1/10W	8.06KΩ ±1% 0603	R284,R285,R288,R289,R292,R293,R297,R298
160	RD00099	SMD fixed resistor 1/10W	8.2KΩ ±5% 0603	R94,R191,R302,R304
161	RD00328	SMD precise resistor 1/10W	8.66KΩ ±1% 0603	R376,R390
162	RD00349	SMD fixed resistor 1/10W	910Ω ±5% 0603	R196,R197,R198,R199,R200,R201,R202,R203,R204,R205,R206,R207,R208,R209,R210,R211
163	SF00056	transistor	MMBT3904(SOT23)/(PHI)	TR1,TR2,TR3,TR4,TR5,TR6,TR7,TR8,TR9,TR10,TR11,TR12,TR15,TR17,TR18
164	SE00008	SMD rectifier diode	DA204K/T-146	D1
165	SF00053	transistor	MMBT3906(SOT23)/(PHI)	TR13,TR14,TR19
166	SG00032	SMD integrated circuit	LM339DR(SO14)/(TI/ST)	U35,U36,U37,U38,U39,U40
167	AE00449	solder material without lead	9308/Sn Ag Cu	
168	HK06379	PC board	P-AMX140FX-USB-AI	
169	RA01325	fixed resistor 1/8W	4.7Ω	R443
170	RA01262	precise resistor 1/4W	6.81KΩ	R15,R16,R17,R18,R42,R43,R45,R70,R72,R91
171	RA01259	fixed resistor 1/4W	47Ω	R346,R347
172	RA01115	fixed resistor 1/4W	20KΩ	R440
173	RA01260	fixed resistor 1/4W	120Ω	R350,R353
174	SA00094	rectifier diode	1N4002/100V	D40,D41,D44,D45
175	SA00127	zener diode	1/2W 47V 1N5261	ZD1
176	CF00137	metal-film capacitor MSC	0.033uF/63V 5% CASE01	C139,C140,C141,C142,C143,C144,C145,C146,C147,C148,C149,C150,C151,C152,C153,C154
177	CF00136	metal-film capacitor MSC	0.018uF/63V 5% CASE01	C131,C132,C133,C134,C135,C136,C137,C138,C163,C164,C165,C166,C167,C168,C169,C170
178	CF00138	metal-film capacitor MSC	0.012uF/63V ±5% CASE01	C155,C156,C157,C158,C159,C160,C161,C162,C171,C172,C173,C174,C175,C176,C177,C178
179	CB00190	electrolytic capacitor	4.7uF/25V φ4*7mm	C342,C343,C344
180	CB00255	electrolytic capacitor	1000uF/10V φ8*11mm 5mm	C23,C26,C50,C51,C99
181	CB00248	electrolytic capacitor	2.2uF/50V φ4*5mm	C195,C196,C197,C198,C199,C200
182	CB00238	electrolytic capacitor	0.22uF/50V φ5*11mm	C70,C71,C72,C73,C74,C75,C76,C77,C78,C79,C80,C81
183	CB00276	electrolytic capacitor	220uF/25V φ6.3*11mm 5mm	C403,C404

No.	Part No.	Description	Specification	Remark
184	CB00268	electrolytic capacitor	330uF/16V φ8*11mm 5mm	C373
185	CB00254	electrolytic capacitor	47uF/100V φ10*12mm 5mm	C406
186	CB00334	electrolytic capacitor-RS	47uF/50V φ6.3*11mm	C21,C22,C24,C25,C41,C44,C48,C49,C91,C92
187	CB00194	electrolytic capacitor	47uF/25V φ5*11mm	C17,C20,C45,C56,C61,C62,C86,C87,C88,C89,C90,C93,C94,C95,C96,C97,C98,C100,C101,C102,C103,C104,C105,C106,C107,C108,C111,C112,C113,C114,C115,C116,C117,C118,C119,C120,C121,C122,C123,C124,C125,C126,C127,C128,C129,C130,C231,C232,C233,C234,C235,C236,C237,C238,C239,C240,C241,C242,C243,C244,C245,C246,C247,C248,C249,C250,C251,C252,C253,C254,C255,C256,C257,C258,C283,C284,C285,C286,C318,C319,C320,C321,C328,C349,C351,C358,C359,C360,C361,C363,C364,C412,C413
188	CB00253	electrolytic capacitor	1000uF/16V φ10*16mm 5mm	C400
189	CB00242	electrolytic capacitor	22uF/35V φ5*11mm	C14,C15,C16,C18,C19,C38,C39,C40
190	HB01831	PCB-RS	AMX140FX-USB_VER061124	
191	HK06381	PC board	P-AMX-USB-DIP	CN3
192	SC00003	crystal oscillator	12.000MHZ HC-49/US ±20PPM	X1
193	HK06382	PC board	P-AMX-USB-SMD	
194	RD00309	SMD fixed resistor 1/10W	10MΩ ±5% 0603	R6
195	RD00063	SMD fixed resistor 1/10W	22Ω ±5% 0603	R3,R4
196	RD00059	SMD fixed resistor 1/10W	0.0Ω ±5% 0603	R2
197	RD00085	SMD fixed resistor 1/10W	1.5KΩ ±5% 0603	R5
198	RD00272	SMD precise resistor 1/10W	10.0Ω ±1% 0603	R9
199	RD00492	SMD precise resistor 1/10W	1.82KΩ ±1% 0603	R1
200	RD00363	SMD precise resistor 1/10W	3.16KΩ ±1% 0603	R26
201	SG00412	SMD integrated circuit-RS	AZ1117H-ADJ(SOT223)/(BCD)	TR1
202	SG00489	SMD integrated circuit-RS	PCM2900E(SSOP28)/(TI)	U1
203	CJ00005	SMD AL electrolytic capacitor	10uF/16V CASE4φ	C1,C2,C3,C4,C5,C6,C20,C21,C22,C23
204	CI00051	SMD ceramic capacitor 0603	22PF/50V C0G±5%(C1608C0G1H220JT)/T	C8,C9
205	CI00030	SMD ceramic capacitor 0805	1uF/16V Y5V-0805(2012)	C10,C11,C12,C13
206	HB01832	PCB-RS	AMX-USB_VER061128	
207	CJ00012	SMD AL electrolytic capacitor-	100uF/16V CASE6.3φ	C7
208	AE00449	solder material without lead	9308/Sn Ag Cu	
209	CI00075	SMD ceramic capacitor 0603	0.1uF/50V Y5V +80,-20%	C34,C30,C31,C32,C33,C35
210	RD00068	SMD fixed resistor 1/10W	100Ω ±5% 0603	R18,R19,R20,R21
211	RD00106	SMD fixed resistor 1/10W	27KΩ ±5% 0603	R22,R23
212	RD00104	SMD fixed resistor 1/10W	18KΩ ±5% 0603	R24,R25
213	RD00102	SMD fixed resistor 1/10W	12KΩ ±5% 0603	R12,R13
214	RD00093	SMD fixed resistor 1/10W	4.7KΩ ±5% 0603	R10,R11
215	RD00092	SMD fixed resistor 1/10W	3.9KΩ ±5% 0603	R14,R15,R16,R17
216	CO00006	SMD chip inductance-RS-ACT	BLM21A102SPT/(MURATA)	L1
217	SG00558	integrated circuit-RS	4580M(SOP8)/(YW)	U2,U3
218	CI00090	SMD ceramic capacitor 0603	0.0047uF/50V X7R ±10%	C24,C25
219	CI00066	SMD ceramic capacitor 0603	0.0018uF/50V X7R ±10%	C15,C18
220	CI00065	SMD ceramic capacitor 0603	0.001uF/50V X7R ±10%	C26,C27
221	CI00062	SMD ceramic capacitor 0603	330PF/50V NPO ±5%	C14,C16,C17,C19
222	CI00061	SMD ceramic capacitor 0603	220PF/50V NPO ±5%	C28,C29
223	AC00179	tin without lead-RS	M705E Sn 3Ag-0.5Cu	
224	HC00555	connector	2.54 90° 12P 6/14	CN1
225	HK06352	PC board	P-DSP-PRE-DIP	CN2
226	HC00697	connector	2.0 90° 16P(gold-pated)2.5/9.5mm 2mm	CN1
227	HK06353	PC board	P-DSP-PRE-SMD	
228	HB01916	PCB-RS	DSP-PRE_VER051020	
229	CI00051	SMD ceramic capacitor 0603	22PF/50V C0G±5%(C1608C0G1H220JT)/T	C329,C330,C331,C332
230	CI00053	SMD ceramic capacitor 0603	33PF/50V C0G±5%(C1608C0G1H330JT)/T	C348,C349
231	CI00129	SMD ceramic capacitor 0603	0.0015uF/50V X7R ±10%	C345,C346,C347

No.	Part No.	Description	Specification	Remark
232	CI00075	SMD ceramic capacitor 0603	0.1uF/50V Y5V +80,-20%	C333,C334,C336,C337,C338,C339,C340,C341
233	CL00002	SMD tantalum capacitor-RS-ACT	1.0uF/16V case A	C352,C353
234	CL00006	SMD tantalum capacitor-RS-ACT	10uF/16V case B2	C350,C351
235	RD00068	SMD fixed resistor 1/10W	100Ω ±5% 0603	R420,R421
236	RD00073	SMD fixed resistor 1/10W	220Ω ±5% 0603	R426
237	RD00059	SMD fixed resistor 1/10W	0.0Ω ±5% 0603	R1
238	RD00083	SMD fixed resistor 1/10W	1.0KΩ ±5% 0603	R418
239	RD00088	SMD fixed resistor 1/10W	2.2KΩ ±5% 0603	R424
240	RD00091	SMD fixed resistor 1/10W	3.3KΩ ±5% 0603	R422,R423
241	RD00093	SMD fixed resistor 1/10W	4.7KΩ ±5% 0603	R416
242	RD00098	SMD fixed resistor 1/10W	7.5KΩ ±5% 0603	R419
243	RD00101	SMD fixed resistor 1/10W	10KΩ ±5% 0603	R397,R398,R399,R400,R401,R402,R403,R404,R405,R406,R407,R408,R410,R411,R412,R413,R414
244	RD00111	SMD fixed resistor 1/10W	47KΩ ±5% 0603	R415
245	RD00124	SMD fixed resistor 1/10W	820KΩ ±5% 0603	R431
246	RD00125	SMD fixed resistor 1/10W	1.0MΩ ±5% 0603	R417
247	RD00126	SMD fixed resistor 1/10W	2.2MΩ ±5% 0603	R425
248	SG00122	SMD integrated circuit-RS-ACT	NJM4580M-TE3(SOP8)/(JRC)	U44,U45,U46
249	SG00306	SMD integrated circuit	LM393DR(TI)/(MEXICO)	U47
250	SG00068	SMD integrated circuit	74HC14DT(SO14)/(PHI)	U49
251	SG00469	SMD integrated circuit-RS	SN74HC109DR(SO16)/(TI)	U48
252	SE00028	SMD rectifier diode-RS-ACT	BAS316,115	D7,D15
253	SE00009	SMD rectifier diode	DAN202K/T-146	D16
254	SE00007	SMD rectifier diode	RB400D(D3A)	D10
255	SF00056	transistor	MMBT3904(SOT23)/(PHI)	TR17
256	AE00449	solder material without lead	9308/Sn Ag Cu	
257	SE00085	SMD zener diode-RS	1/2W 2.4V ZMM55-C2V4	ZD1,ZD2
258	SG00243	SMD integrated circuit	NE555DR(SO8)/(TI)	U43
259	AC00179	tin without lead-RS	M705E Sn 3Ag-0.5Cu	
260	AC00179	tin without lead-RS	M705E Sn 3Ag-0.5Cu	
261	HC00920	DC jack-RS	SCD554CCS103BB4G	
262	HC00754	USB socket	CU02SAH0000 90°	CN4
263	MG00024	screw	M3*7 0.5PH	
264	RC00672	potentiometer-RS	B50KΩ XV09213YNPV30F-1B50K C.C	VR2,VR3,VR4,VR10,VR11,VR12,VR18,VR19,VR20,VR26,VR27,VR28
265	RC00703	potentiometer-RS	W50KΩ XV09213YNPV30F-4BP50K CC	VR5,VR6,VR7,VR8,VR13,VR14,VR15,VR16,VR21,VR22,VR23,VR24,VR29,VR30,VR31,VR32,VR37,VR38,VR44,VR45,VR52
266	RC00669	potentiometer-RS	B50KΩ XV012313YGPV30F-3B50K C.C	VR34,VR35,VR36,VR41,VR42,VR43
267	RC00670	potentiometer-RS	W50KΩ XV012313YGPV30F-4B50K C.C	VR39,VR40,VR46,VR47,VR48,VR49,VR50,VR53
268	MG00243	copper pillar	M3*5*0.5PH	
269	ME00015	color nut	3m/m	
270	MG00036	screw	M3*4	
271	HK06603	PC board	P-313123_2-V2-DIP	
272	SC00004	crystal oscillator	16.00MHZ	XT1
273	HC00484	connector	2.54 180° 2*8P(gold-plated) 13.5/19mm	CN2
274	SG00193	SMD integrated circuit	AT27LV010A-90JC/L-8	IC4
275	SG00168	SMD integrated circuit-RS	HT27LC010-90J(PLCC32)/(HOLTEK)	
276	NE11475	label	L-8	
277	NH00221	paper	0.055*1M	
278	NI00016	membrane	0.05*1M	
279	AC00179	tin without lead-RS	M705E Sn 3Ag-0.5Cu	
280	HK06604	PC board	P-313123_2-V2-SMD	
281	HB01963	PCB-RS	313123_2-V2	
282	CI00049	SMD ceramic capacitor 0603	15PF/50V C0G±5%(C1608C0G1H150JT)/TI	C8,C9
283	CI00075	SMD ceramic capacitor 0603	0.1uF/50V Y5V +80,-20%	C17,C15,C18,C6,C10,C22,C20,C13,C14,C1,C3,C4,C11
284	RD00059	SMD fixed resistor 1/10W	0.0Ω ±5% 0603	R35,R36
285	RD00061	SMD fixed resistor 1/10W	10Ω ±5% 0603	R22

No.	Part No.	Description	Specification	Remark
286	RD00068	SMD fixed resistor 1/10W	100Ω ±5% 0603	R12,R14,R7,R8,R34,R17,R13,R33
287	RD00073	SMD fixed resistor 1/10W	220Ω ±5% 0603	R3
288	RD00085	SMD fixed resistor 1/10W	1.5KΩ ±5% 0603	R16,R15,R21,R20,R4,R19,R10,R18,R9,R5
289	RD00088	SMD fixed resistor 1/10W	2.2KΩ ±5% 0603	R28,R27,R23,R24,R29,R30,R25,R26
290	RD00101	SMD fixed resistor 1/10W	10KΩ ±5% 0603	R32,R31,R1
291	RD00125	SMD fixed resistor 1/10W	1.0MΩ ±5% 0603	R2
292	CJ00013	SMD AL electrolytic capacitor-	100uF/6.3V CASE5φ	C19,C12,C5,C2,C24,C16,C21,C25,C26,C28,C7
293	RE00006	SMD resistor networks 1/16W	100Ω*4 ±5% 8P 0603	AR1,AR2
294	SE00011	SMD rectifier diode	RLS4148 0.5A (LL-34)	D1
295	SG00068	SMD integrated circuit	74HC14DT(SO14)/(PHI)	IC1
296	SG00410	SMD integrated circuit	IC41LV16256-35KG(SOJ40)/(ICSI)	IC6
297	SG00166	SMD integrated circuit	TY-2 ALTO(GMCODE:105022)	IC3
298	SG00147	SMD integrated circuit	CHEF DSP(GMCODE:105022)	
299	SG00037	SMD integrated circuit	LD1117DT33C(TO252)/(ST)	IC2
300	HC00611	IC socket (SMD)	PLCC32 (AMP S/N:822516-7)	IC4
301	SG00016	SMD integrated circuit	UDA1345TS(SSOP28)/(PHI)	IC5
302	AE00449	solder material without lead	9308/Sn Ag Cu	
303	NB02753	inner case-RS	AMX-140/140FX/140FX USB ALTO _V1.0	
304	MG00304	copper pillar	M3*14*0.5PH	
305	MI02091	fixed bracket	AMX-140 right_V1.0	
306	MI02090	fixed bracket-RS-ACT	AMX-140 1.0t*25*107*318_V1.2	
307	MJ00058	single light board	1*2135*1220 20.45kg	
308	MI02089	fixed bracket	AMX-140 left_V1.0	
309	MI02088	fixed bracket-RS-ACT	AMX-140 1.0t*25*107*318_V1.3	
310	MJ00058	single light board	1*2135*1220 20.45kg	