

Service *Manual*

MODEL: AMX-180(FX)



www.proaudio.com

Version 1.0

CONTENTS

1. Introduction.....	2
2. Specification.....	3
3. Block Diagram.....	4.
4. Schematic Diagram.....	5
5. Wiring Diagram.....	12
6. PCB Layout.....	13
7. Test Procedure.....	17
8. Exploded Views & Mechanical Parts List.....	20
9. BOM.....	24

1. Introduction

The AMX-180(FX) is 4 mono MIC/LINE channels with MIC PREAMPS plus 4 stereo channels. Perfect for keyboards MIDI equipment or other stereo sound sources and a 2-track input/output for recording and playback in a mixer small enough to carry in your board luggage. You can find great 3-band, mid-sweep equalizers in each channel plus switchable low-cut filters in the mono channels, 2 AUX sends, 2 stereo returns, phantom power and accurate peak LED and level meters plus of course our ultra low noise circuitry and exceptional build quality.

- 5 MIC input channels with gold plated XLRs and balanced Line inputs.
- 4 Stereo input channels with balanced TRS Jacks.
- Ultra-low noise discrete MIC Preamps with +48V Phantom power.
- 2 additional multi-functional Stereo Line Input.
- Extremely high headroom offering more dynamic range.
- Balanced input for highest signal integrity.
- Warm , natural 3-band EQ on each channel.
- Peak LED and switchable low-cut filter on each mono channel.
- Adjust the input sensitivity on each stereo channels.
- 2 AUX Sends per channel for external effects and monitoring.
- Balanced TRS and XLR outputs, Control Room and Headphone Outputs.
- 2-Track Input assignable to Main Mix, Control Room / Headphone Outputs.
- Highly accurate 12 segment Bar graph Meters.
- Inserts on MIC channels.
- Performance and excellent noise figures.
- Rugged construction ensures long life even under the most demanding conditions
- 24-bit DSP effect built in (for AMX-180FX only)

2. Specification

Mono input channels	Microphone input	Electronically balanced discrete input configuration
	Frequency response	10Hz to 55KHz \pm 3dB
	Distortion (THD&N)	0.005% at +4dBu 1KHz
	Gain range	0dB to 60dB(MIC)
	SNR(Signal Noise Rated)	115dB
	Line input	Electronically balanced
	Frequency response	10Hz to 55KHz, \pm 3dB
	Distortion (THD&N)	0.005% at +4dBu, 1KHz
	Sensitivity range	+15dBu to -45dBu
Stereo input channels	Line input	unbalanced
	Frequency response	10Hz to 55KHz \pm 3dB
	Distortion (THD&N)	0.005% at +4dBu 1KHz
Impedance	Microphone input	1.4K ohm
	Channel insert return	2.5K ohm
	All other inputs	10Kohm or greater
	Tape out	1K ohm
	All other output	120 ohm
Equalization	Hi shelving	\pm 15dB @ 12KHz
	Mid bell	\pm 12dB @2.5KHz
	Low shelving	\pm 15dB @80Hz
DSP SECTION (For AMX-100FX only)	A/D and D/A converters	24 bit
	DSP resolution	24 bit
	Type of effects	Hall , Room , Vocal & Plate REVERBS
		Mono & Stereo DELAY (max DELAY TIME 500ms)
		Chorus , Flanger & Vibrato MODULATIONS
		REV+DELAY,REV+CHORUS,REV+FLANGER,REV+VIBRATO combination
	Presets	256
	Controls	16-position PRESET BANK Selector
		16-position VARIATION selector
		CLIP LED
Power supply (AC/AC Adapter)	Main voltage	USA/ Canada 100-120V~,60Hz
		Europe 210-230V~,50Hz
		U.K/Australia 240V~,50Hz
	Power Consumption	25W
Physical	Dimension (W*D*H)	409mm X 330mm X43mm
	Net weight	3.9kg/3.97kg (Without Adapter)

3. Block Diagram

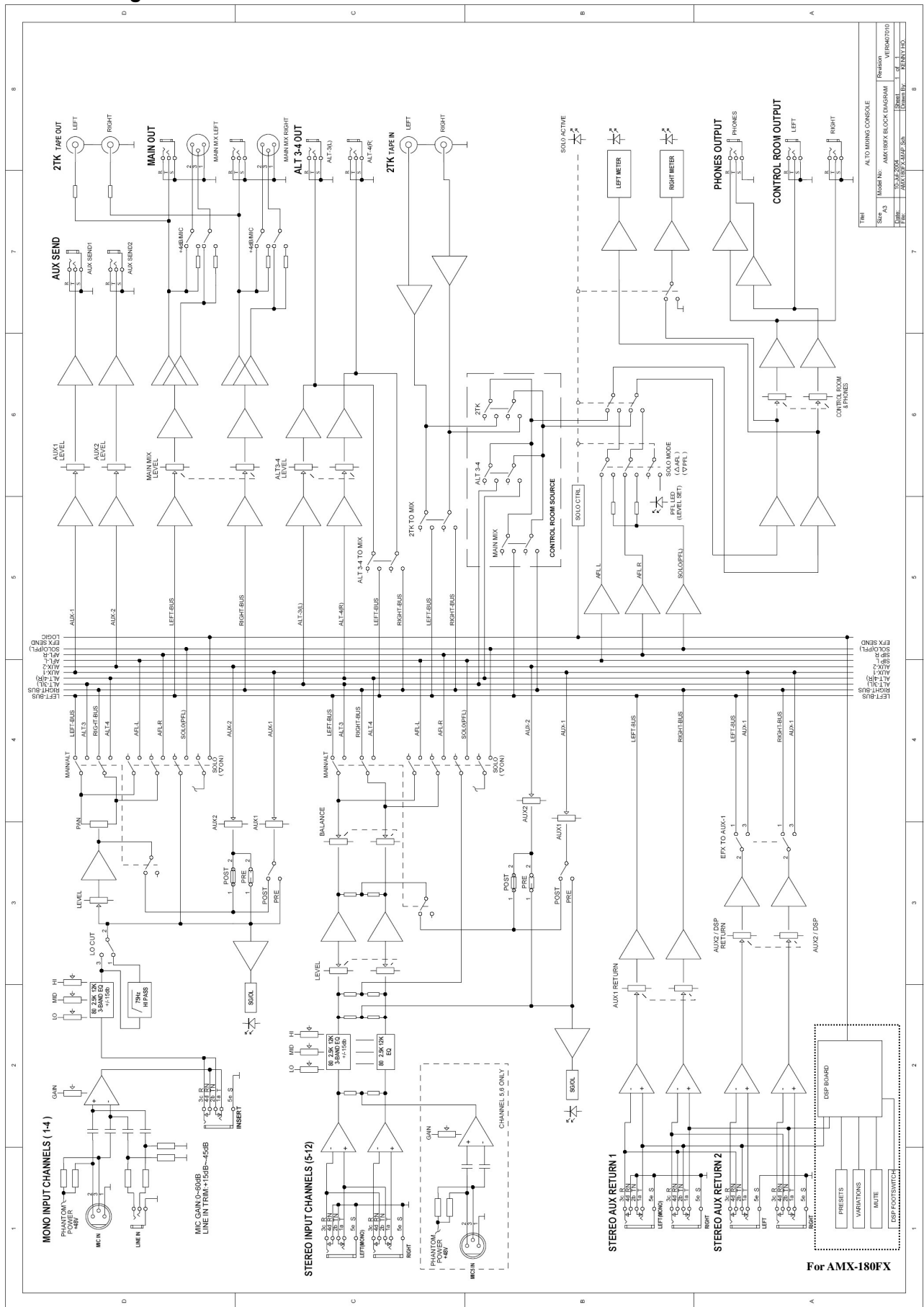

AMX180FXPU1-2

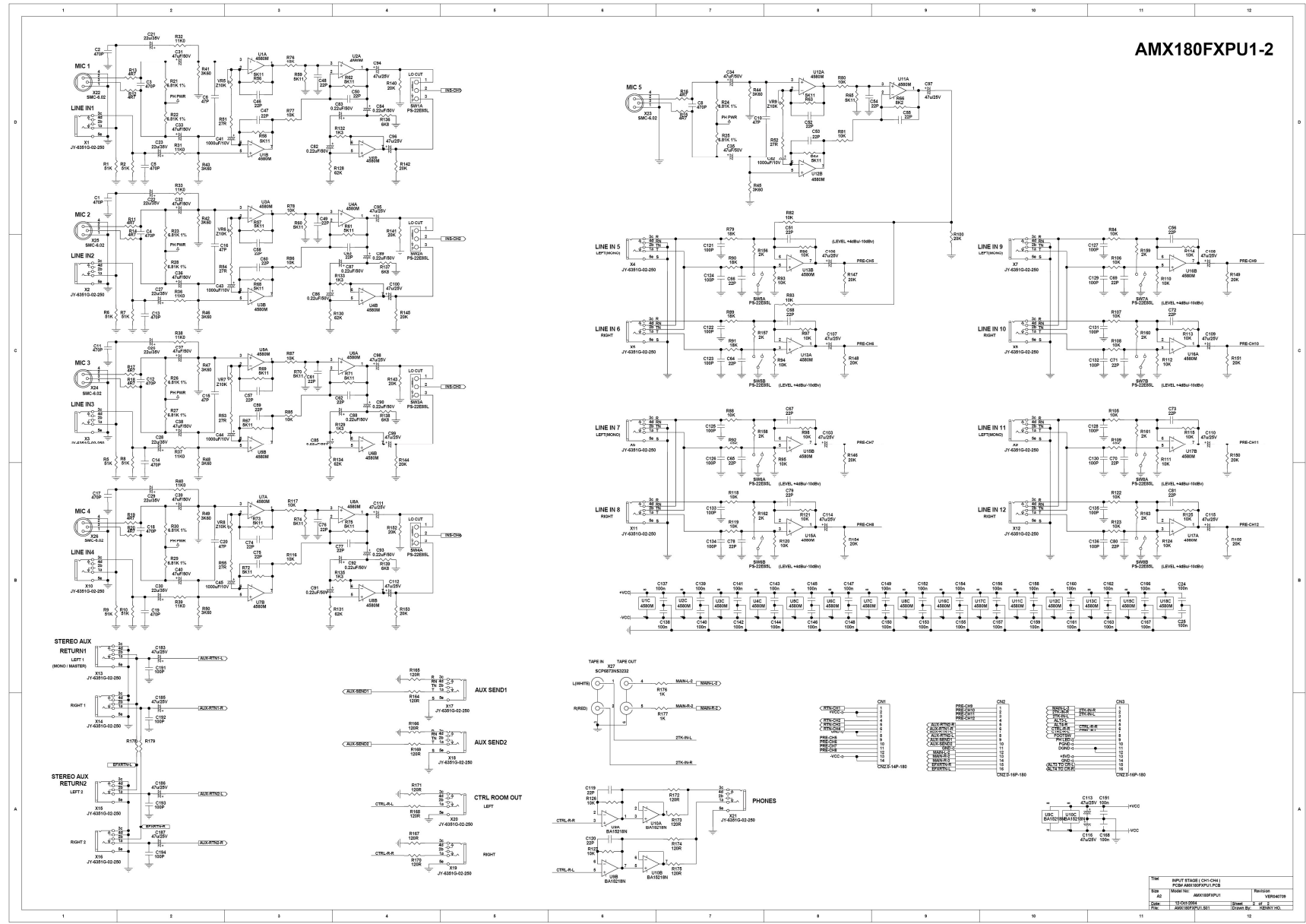

TRM	INPUT STAGE (CH1-CH4)	PCB ASSY (REV) P1-2	REV
REV	MODEL NO.	AMX180FXPU1	REV
DATE	15 OCT 2005	DESIGN BY	JEFF HAYTON
CHK	AMX180FXPU1-2	CHECKED BY	JEFF HAYTON

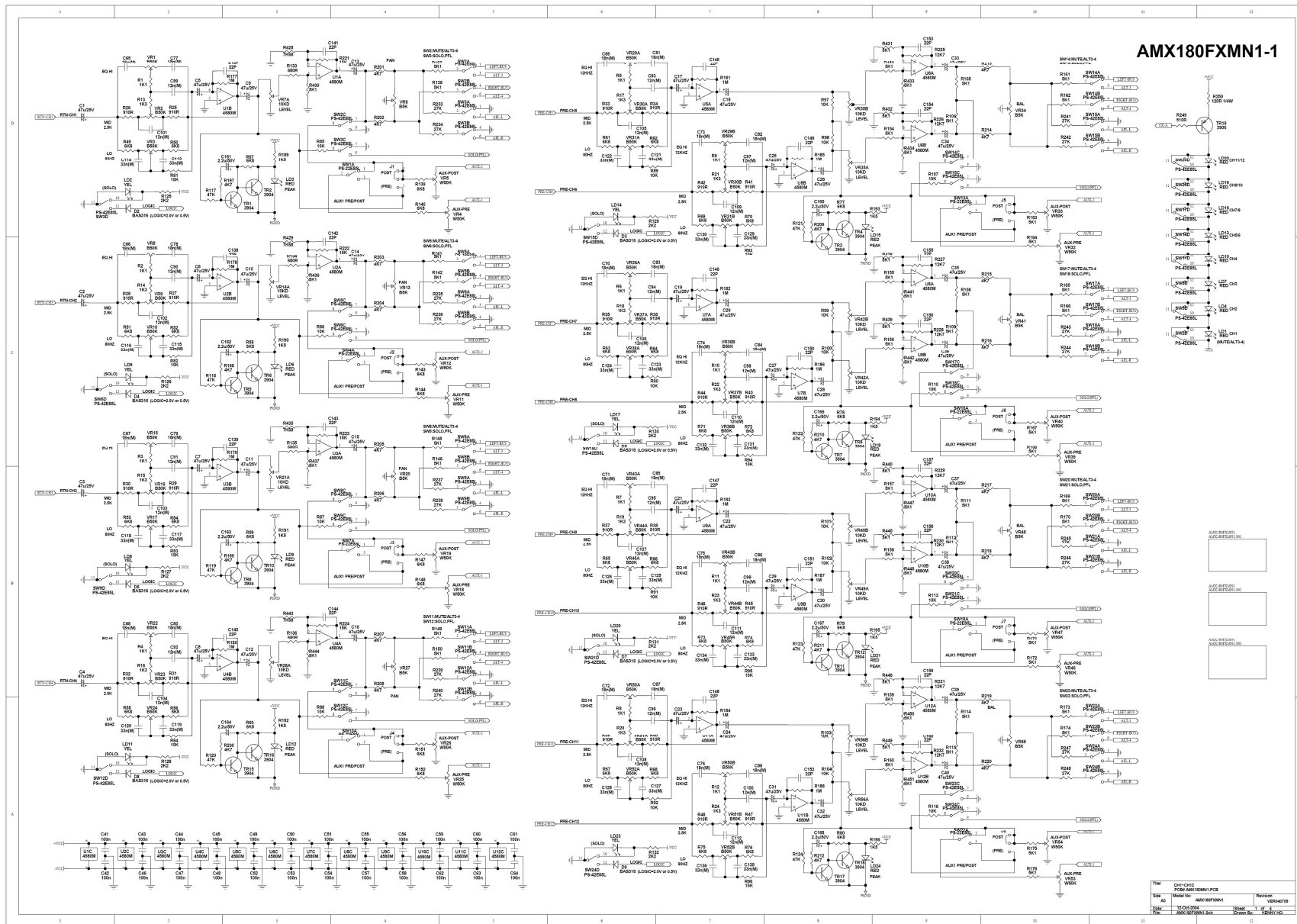

AMX180FXMN1-1

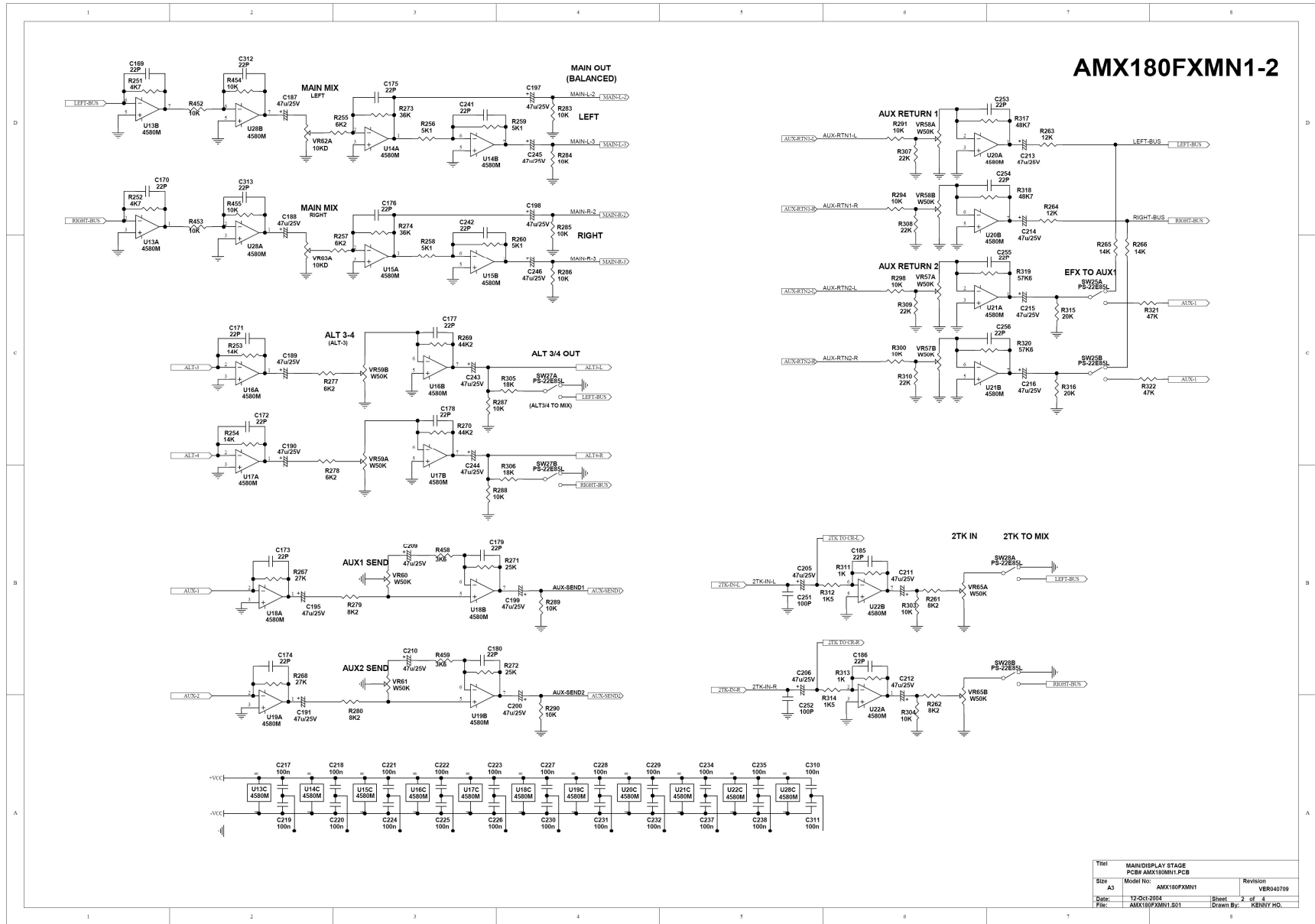

TITLE	MANUFACTURE STAGE		
Size	A3	Model No:	AMX180FXMN1
Date:	12-04-2004	Revision	VER040709
File:	AMX180FXMN1.001	Sheet	2 of 4
		Drawn By:	KBENNY HO

AMX180FXMN1-3

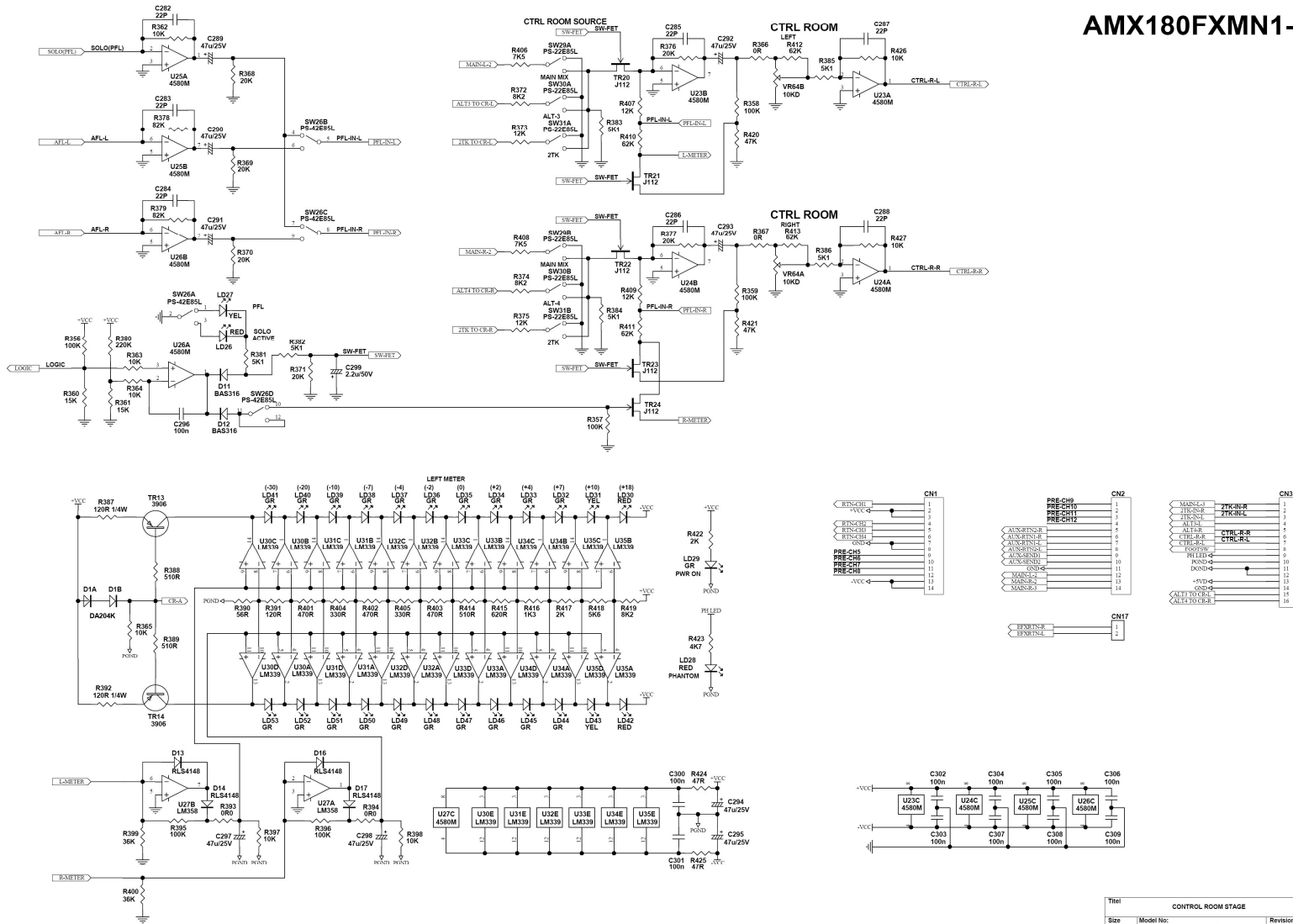

Title		
Model No:	AMX180FXMN1	Revision
Size:	A0(C)	VER040709
Date:	12-04-2004	Sheet 3 of 4
File:	AMX180FXMN1.B02	Drawn By: KENNY HO.

AMX180FXMN1-4

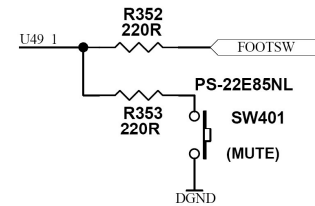
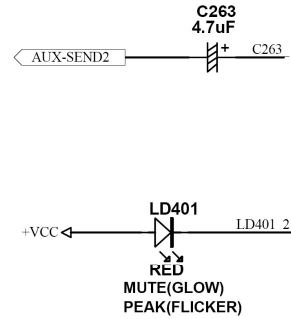
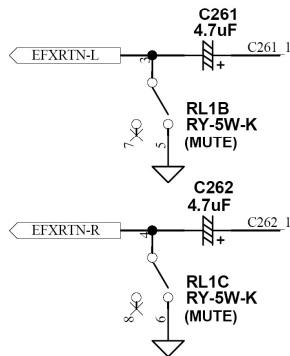
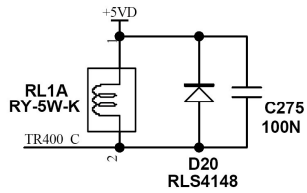
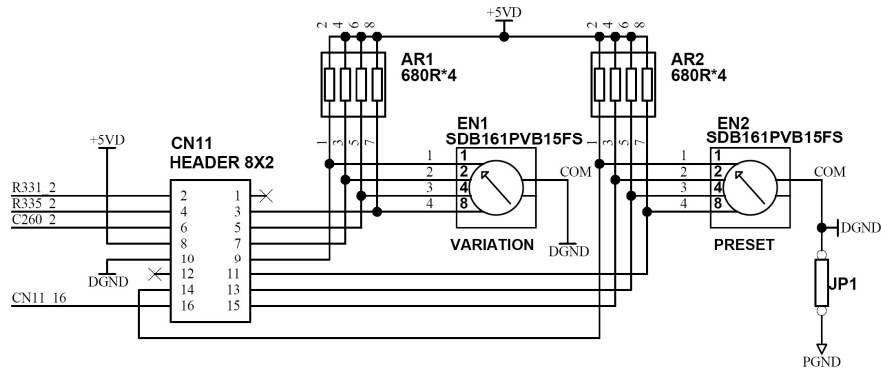
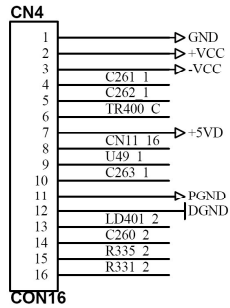

Titel		UDASP IN/OUT SECTION	
Size	Model No:	Revision	
A2(C)	AMX180FXMN1	VER040709	
Date:	12-Oct-2004	Sheet	4 of 4
File:	AMX180FXMN1.S03	Drawn By:	KENNY HO.

5. Wiring Diagram

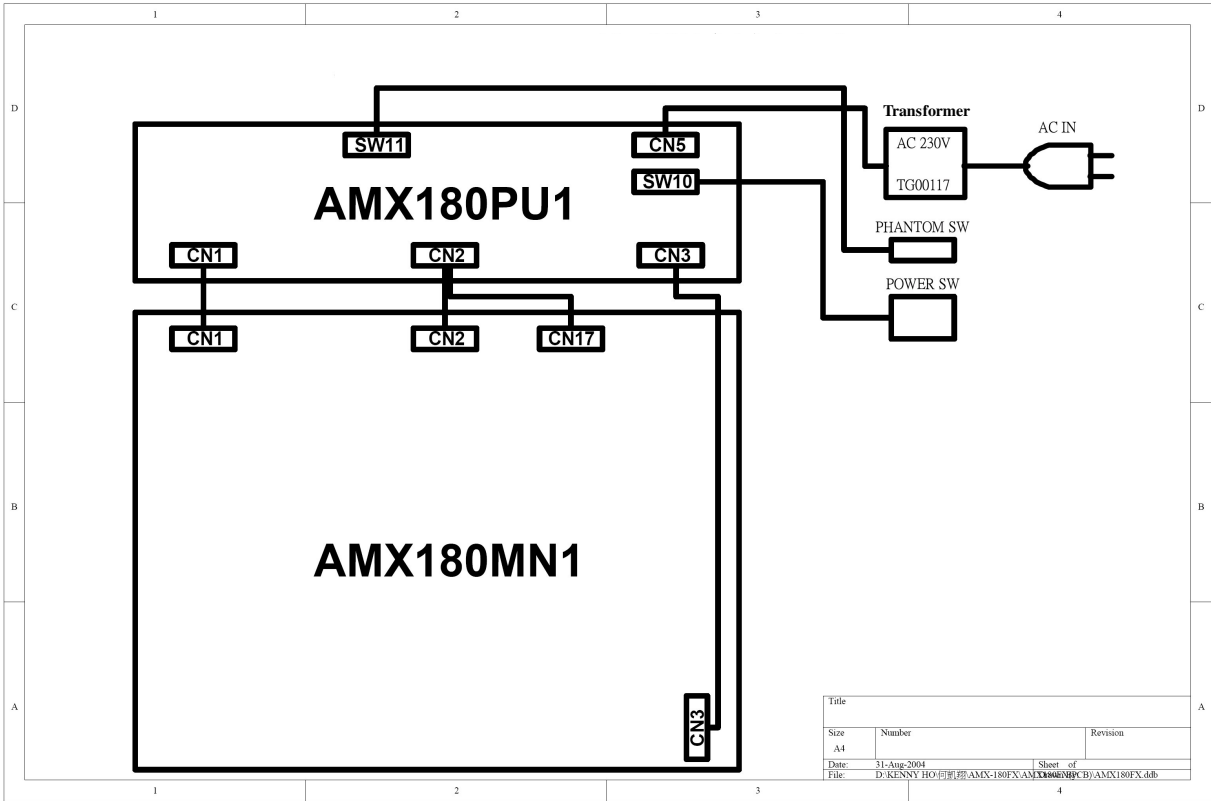

6. PCB Layout

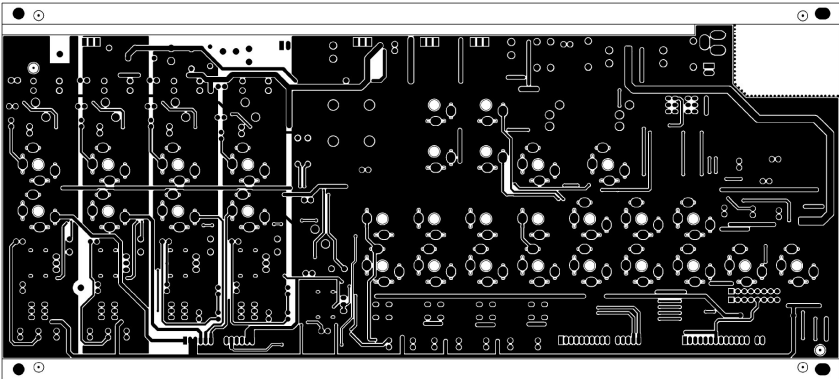

PCB : AMX180PU1 Top Layer

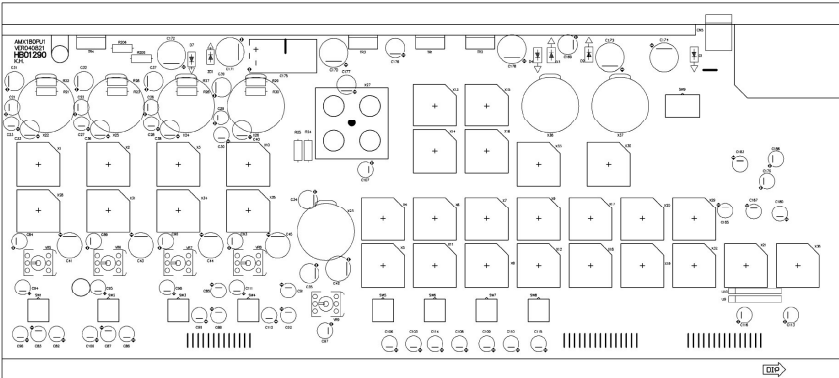

PCB : AMX180PU1 Top Overlay

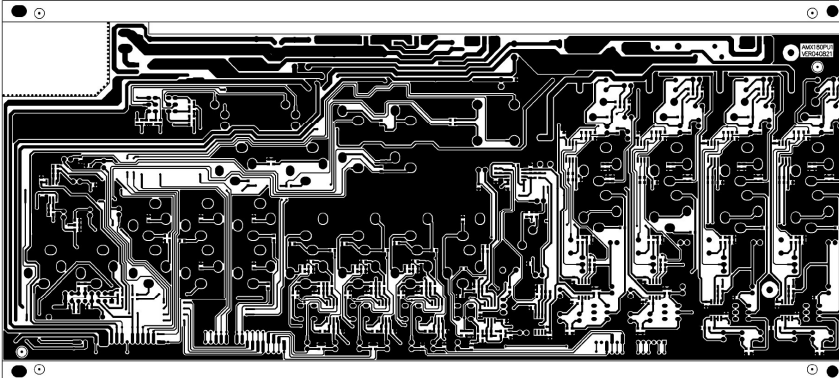

PCB : AMX180PU1 Bottom Layer

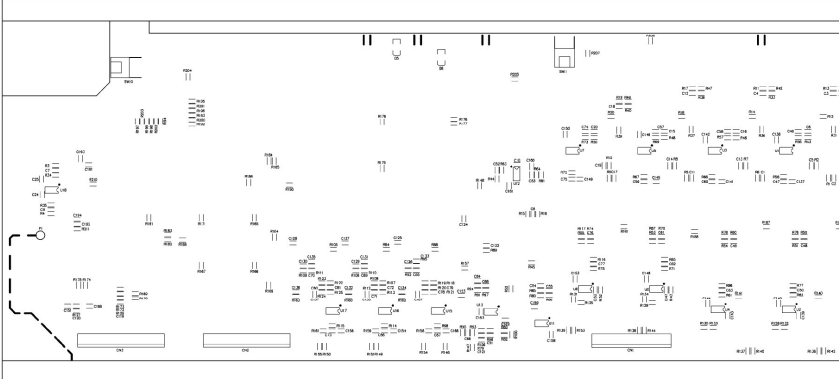

PCB : AMX180PU1 Bottom Overlay

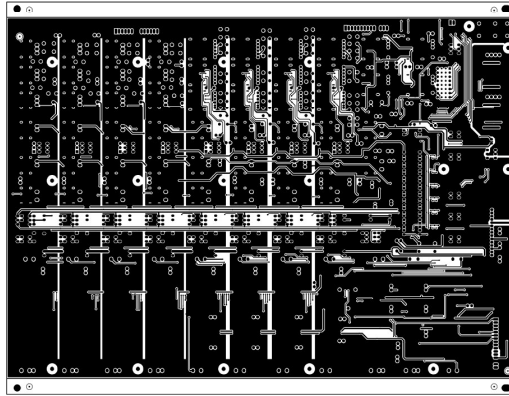

PCB : AMX180MN1 Top Layer

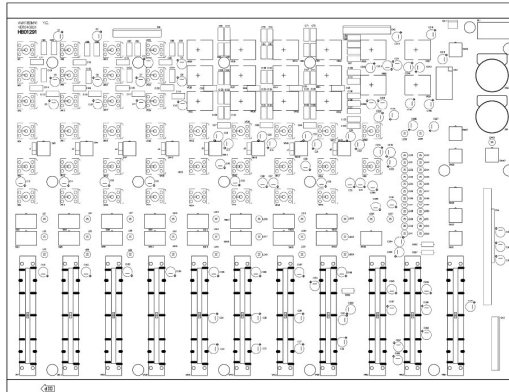

PCB : AMX180MN1 Top Overlay

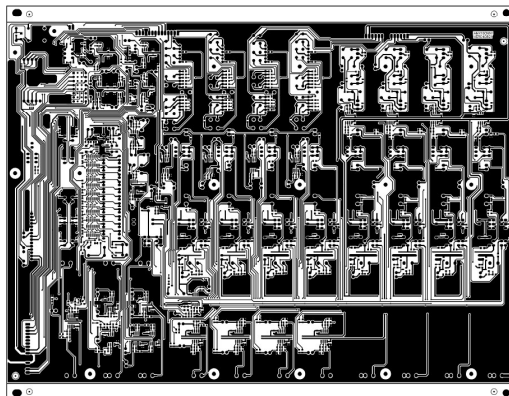

PCB : AMX180MN1 Bottom Layer

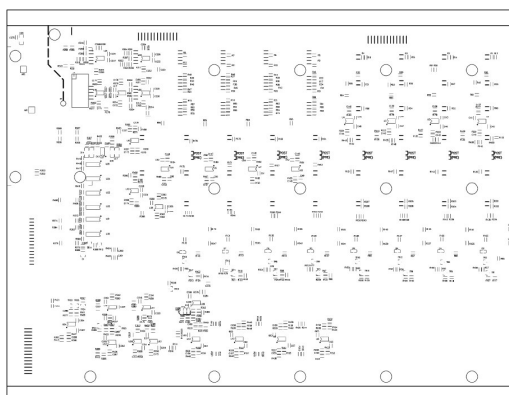

PCB : AMX180MN1 Bottom Overlay

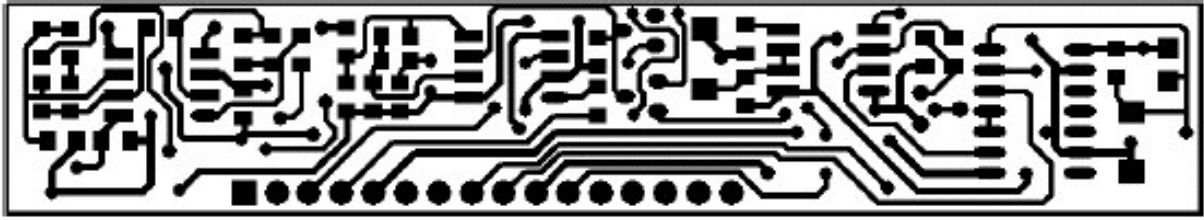

PCB : FX-DSP Top Layer

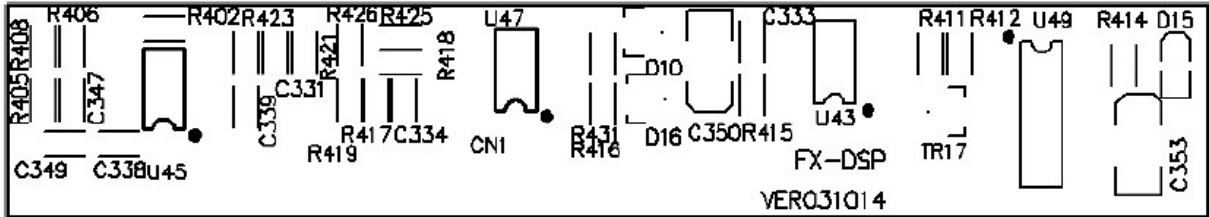

PCB : FX-DSP Top Overlay

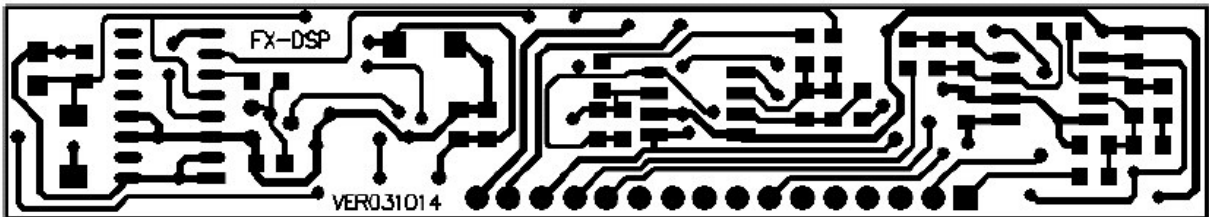

PCB : FX-DSP Bottom Layer

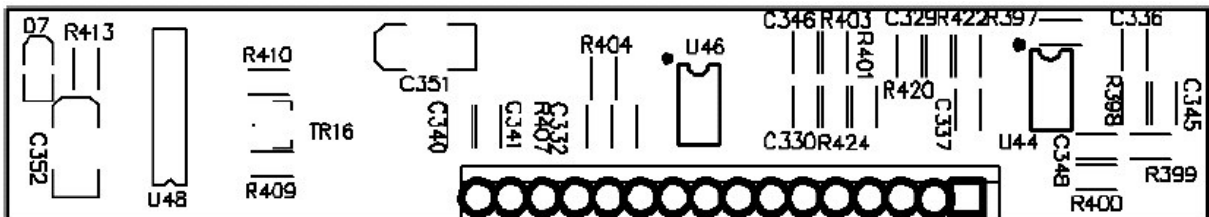

PCB : FX-DSP Bottom Overlay

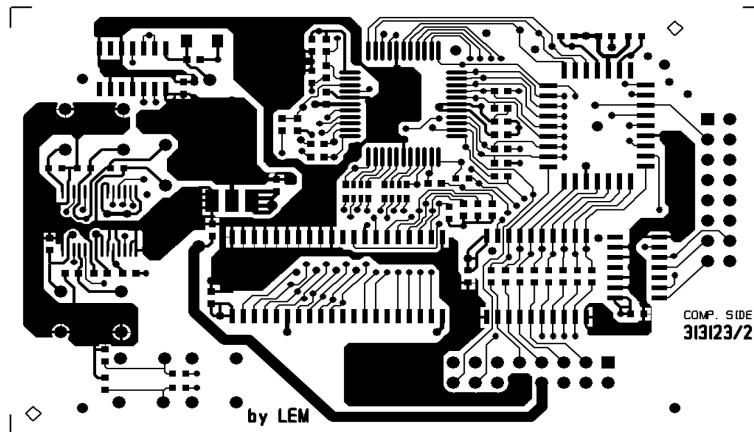

PCB : 313123/2 Top Layer

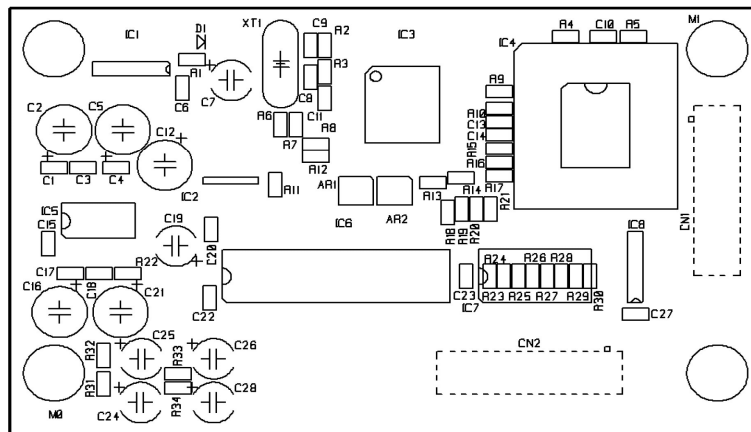

PCB : 313123/2 Top Overlay

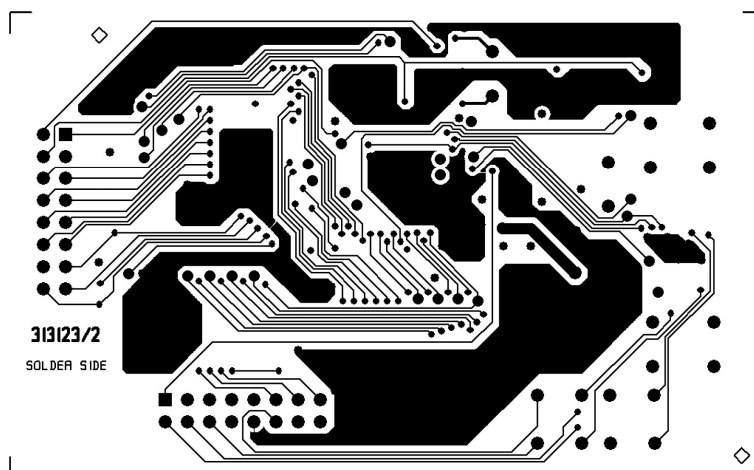

PCB : 313123/2 Bottom Layer

7. Test Procedure

1) Test Equipment:

1. AP (Audio precision)
2. Dual-track oscilloscope
3. Voltage meter

2) Equipment setting

1. AP Output: 0dBu 1KHz sine wave, Load out 40Ω Bal-Float or 600Ω BNC-Unbal
2. AP Input: Load 100KΩ BNC-Unbal or 100KΩ Bal-Float, BW: 22Hz~22KHz, Fitr: A-Weighting (1207)

3) Appearance inspection

Check the appearance of unit, the potentiometer knob shall be operated smoothly.

4) Function test

1. After visual check, connect the proper AC power supply and turn the main power switch on, the power indicator shall be lit in green. Then turn on the PHANTOM switch and its indicator shall be lit in red. Using voltage meter to measure the voltage between 2 & 3 pins of each MIC (MIC1, MIC2, MIC3 and MIC4 on mono channels) input socket and the phantom voltage shall be 48V(+/-2V). Now turn off the PHANTOM switch. (Note: this switch shall be off during following tests or the unit may be damaged.)
2. Set MAIN MIX LEVEL, PHONESS/CONTROL ROOM, EQ QUX, PAN and BAL knobs in zero position, turn the TRIM, AUX RTN 1 and AUX RTN 2 controls to minimum, all buttons off. (To test the LEVEL of CH1~CH12. you need to turn the respective LEVEL to maximum).
3. Connect balanced input to MIC1~MIC4 independently, to measure the balanced output of MAIN MIX OUTPUT, the measurement shall be 5dBu(+/-2dB) THD+N<0.005%.
4. Connect unbalanced input to AUX RETURN 2, measure the unbalanced output of MAIN MIX OUTPUT (LEFT & RIGHT) and it shall be 3dBu (+/-1dBu) THD+N<0.005%.
5. Connect unbalanced input to AUX RETURN 1, measure the balanced output of MAIN MIX OUTPUT (LEFT & RIGHT) and it shall be 9dBu (+/-1dBu) THD+N<0.003%.
6. Connect unbalanced input to the Left input of AUX RETURN 1. Press the EFX TO AUX1 switch, measure the output of AUX SEND 1 and it shall be -2dBu(+/-1dB) THD + N<0.005%.
7. Connect the RCA plug to the left and right inputs of TAPE IN:
 - (1) Press the 2TK TO MIX down, measure each output of balanced MAIN MIX OUTPUT (LEFT&RIGHT), of CONTROL ROOM and PHONE(need stereo plug), all measurements will be 0dBu(+/-2dB)THD+N<0.006%. Measure the output of TAPE OUT and it shall be -8dBu(+/-1dB) THD + N < 0.006%.
 - (2) Release the 2TK TO MIX (off), there will be no output on CONTROL ROOM. When press 2TK TO CONTROL ROOM down, the CONTROL ROOM output shall be 0dBu(+/-2dB) THD+N<0.002%.
8. (1) Input a +15dBu 1KHz sine wave from the LINE1 (load out 600Ω BNC-Unbal), turn MAIN MIX LEVEL to smallest in counterclockwise, then all LED LEVEL indicators will be off. Then slowly turn MAIN MIX LEVEL in clockwise, the LED LEVEL indicators will be lit in sequence. Now measure the MAIN MIX OUTPUT (LEFT & RIGHT) and it will be same as the LED indicators: i.e. that which indicator is lit and its value will be same as the output. Also, the maximum distortion-free value shall be 20dBu(+/-1dB THD+N<0.1%).

(2) Turn the TRIM knob of CHANNEL1 in clockwise so the peak LED will be lit in red. It will be same on CHANNEL 2~CHANNEL 8.

5). Frequency response test:

Test the frequency response of MAIN MIX OUTPUT (LEFT & RIGHT) while using input of LINE1, LINE2, LINE3, LINE4, LINE5 and LINE6 independently according to following procedures. (All controls setting is same as 4.2.)

1. Turn on the AMX-180FXRESP1.at1, the frequency response will be following while LOW CUT switch is not depressed.

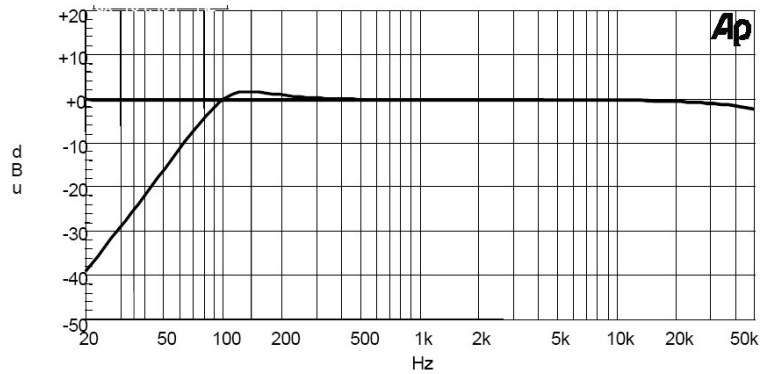

2. EQ HI & LOW in maximum and minimum independently (EQ MID in center), the test frequency response is as following.

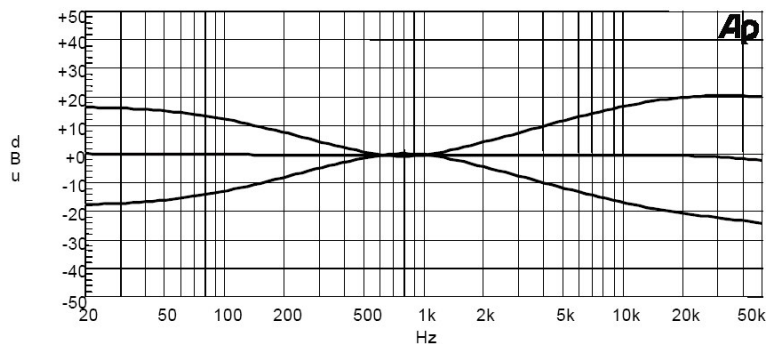

3. EQ MID in maximum and minimum independently (EQ HI & LOW in center), the frequency response is as following.

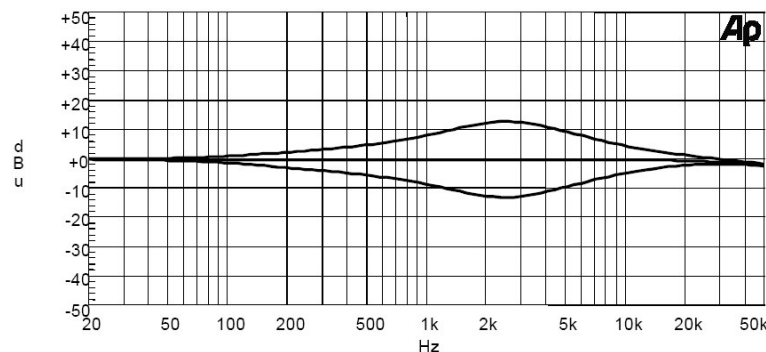

Note: normal frequency response test:

1. Input on each of channel, turn EQ LOW on this channel to maximum (+/-15) in clockwise, the output is +/-15dBu(+/-2dB).
Turn EQ LOW to smallest (-15) counterclockwise, the output is -15dBu (+/-2dB).
2. Change the input frequency to 2.5KHz, turn the EQ MID on respective channel to maximum (+12), the output is +12dBu(+/-2dB), and while the EQ MID in minimum the output will be -12dBu(+/-2dB).
3. Change the input frequency to 12KHz, turn the EQ HIGH to smallest (+15), the output is +15dBu(+/-3dB).

6) (1) Input a +15dBu 1KHz sine wave from the LINE1 (load out 600Ω BNC-Unbal), turn MAIN MIX LEVEL to smallest in counterclockwise, then all LED LEVEL indicators will be off. Then slowly turn MAIN MIX LEVEL in clockwise, the LED LEVEL indicators will be lit in sequence. Now measure the MAIN MIX OUTPUT (LEFT & RIGHT) and it will be same as the LED indicators: i.e. that which indicator is lit and its value will be same as the output. Also, the maximum distortion-free value shall be 20dBu(+/-1dB THD+N<0.1%).

(2) Turn the TRIM knob of CHANNEL1 in clockwise so that the peak LED will be lit in red. It will be same on CHANNEL 2 to CHANNEL 8.

7) DSP effect test (This step for AMX-180FX only)

(1) Input signal on MIC1 through MIC4 and output the signal from MAIN MIX OUTPUT, now turn AUX RTN2 (DFX) to maximum in clockwise, while turning PRESERS or ARATIONS knobs the processed signal by DSP effect will occur. If the input signal is too strong, the PEAK LED will be lit in red, press DFX MUTE key, the output signal is a bypass signal.

(2) Input signal on MIC1 through MIC4, output the signal from AUX SENDS1, now turn the AUX2/DFX TO AUX1 to maximum in clockwise, while turning PRESERS or ARATIONS knobs the processed signal by DSP effect will occur. If the input signal is too strong, the PEAK LED will be lit in red, press DFX MUTE key, the output signal is a bypass signal.

8) Connect the unit to a high quality amplifier and speaker, there shall be no noise while listening.

9) Setting before shipment: all level controls in minimum, others knobs in center, all switch in off.

10) Test finished.

8. Exploded Views & Mechanical Parts List

SEIKAKU

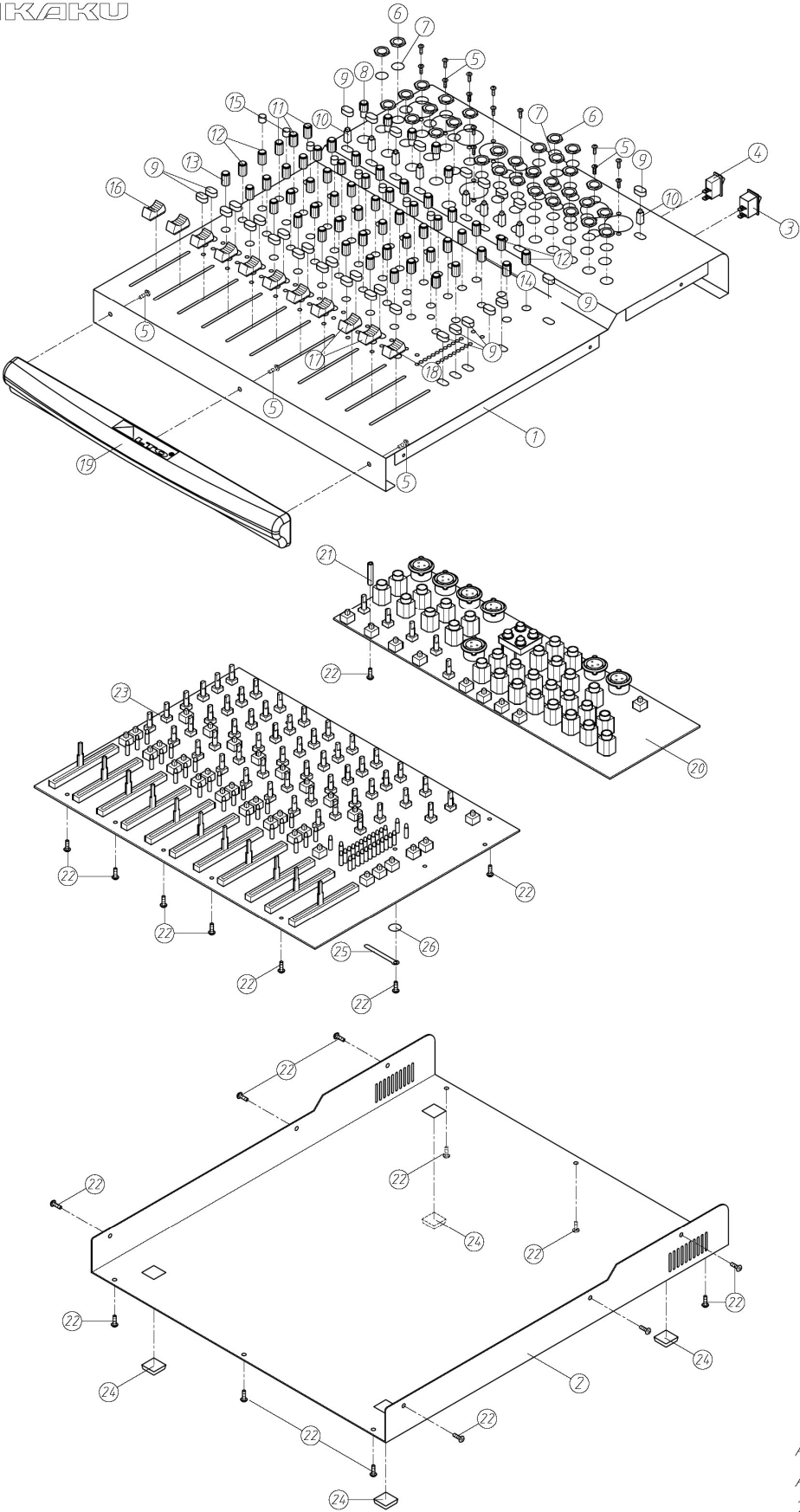

AMX-180
 AMX180-00
 2004/8/5

SEIKAKU

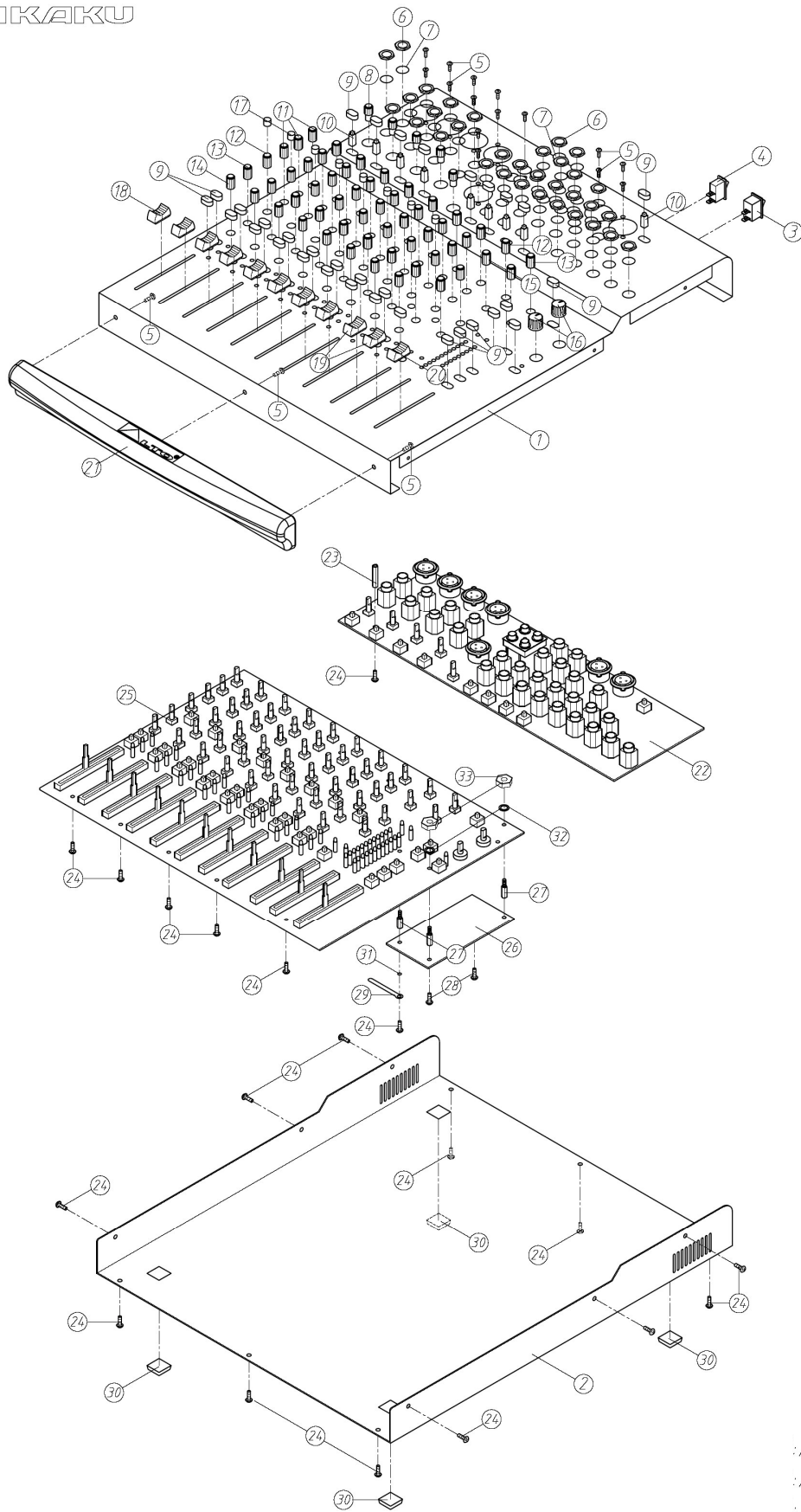

:AMX-180FX
:AMX180FX-00
...:2004/8/5

Mechanical Parts List (for AMX-180)

No.	Item Number	Description	Specification	Quantify
1	MA04586	panel	AMX-180FX ALTO	1
2	MB03115	chassis	AMX-180	1
3	HI00026	power switch	RA12KKATOF 2P	1
4	HI00171	power switch	R612KKATOF1	1
5	MG00061	black plated screw	M3*10	18
6	ME00060	MIC socket washer	For hexagon JY-6351G-02-250	29
7	MF00061	T-MIC socket washer	For round JY-6351G-02-250	29
8	NI02714	plastical knob	φ 10*13.5mm dual color	5
9	NNI01863	push button	φ 5.5*W10*7.5 black	32
10	NNI01862	button cap	5.5*5.5*14.5	9
11	NI02083	plastical knob	φ 10.5*18mm dual color	24
12	NI02081	plastical knob	φ 10.5*18mm dual color	20
13	NI02082	plastical knob	φ 10.5*18 dual color	8
14	NI02817	plastical knob	φ 10.5*18mm dual color	2
15	NI02377	push button	φ 5.5*7.5mm (inner 3.3*3.3mm)	8
16	NI02309	slide switch	24*11.5*11	8
17	NI02352	slide switch	24*11.5*11	2
18	NI02353	slide switch	24*11.5*11	1
19	NI01945	handle	AMX-180	1
20	HK04386	K-PCB	P-AMX180 PU1-DIP	1
21	MG00247	Copper post	M3*10mm*0.5PH total 16mm	1
22	MG00041	black plated screw -	M3*6	28
23	HK04348	K-PCB	P-AMX180 MN1-DIP	1
24	NI00501	Adhesive foot cushion	12.7*9*3t(SF-004)	4
25	MJ00808	Power fixing clamp	WL3-32T	1
26	NC00080	Wood washer	1* φ 3.17* φ 8.2	1

Mechanical Parts List (for AMX-180FX)

No.	Item Number	Description	Specification	Quantify
1	MA04586	panel	AMX-180FX ALTO	1
2	MB03115	chassis	AMX-180	1
3	HI00026	power switch	RA12KKATOF 2P	1
4	HI00171	power switch	R612KKATOF1	1
5	MG00061	black plated screw	M3*10	18
6	ME00060	MIC socket washer	For hexagon JY-6351G-02-250	30
7	MF00061	T-MIC socket washer	For round JY-6351G-02-250	30
8	NI02714	plastical knob	φ 10*13.5mm dual color	5
9	NNI01863	push button	φ 5.5*W10*7.5 black	33
10	NNI01862	button cap	5.5*5.5*14.5	9
11	NI02083	plastical knob	φ 10.5*18mm dual color	24
12	NI02081	plastical knob	φ 10.5*18mm dual color	10
13	NI02633	plastical knob	φ 10.5*18mm dual color	10
14	NI02082	plastical knob	φ 10.5*18 dual color	8
15	NI02817	plastical knob	φ 10.5*18mm dual color	2
16	NI02386	plastical knob	φ 14*13 dual color	2
17	NI02377	push button	φ 5.5*7.5mm (inner 3.3*3.3mm)	8
18	NI02309	slide switch	24*11.5*11	8
19	NI02352	slide switch	24*11.5*11	2
20	NI02353	slide switch	24*11.5*11	1
21	NI01945	handle	AMX-180	1
22	HK04391	K-PCB	P-AMX180FXPU1-DIP	1
23	MG00247	Copper post	M3*10mm*0.5PH total 16mm	1
24	MG00041	black plated screw -	M3*6	28
25	HK04388	K-PCB	P-AMX180FXMN1-DIP	1
26	HK03894	PCB semi-finished product	P-313123	1
27	MG00243	Copper post	M3*5*0.5PH	3
28	MG00036	black plated screw	M3*4	2
29	MJ00808	Power fixing clamp	WL3-32T	1
30	NI00501	Adhesive foot cushion	12.7*9*3t(SF-004)	4
31	NC00080	Wood washer	1* φ 3.17* φ 8.2	1
32	MF00037	Spring washer	φ 3* φ 5*1t	2
33	ME00015	Color nut	3mm	2

9. BOM

AMX-180 Parts List

No.	Part No.	Description	Specification	Remark
1	MA04589	panel	AMX-180 ALTO_V1.1	
2	MA04590	panel	AMX-180	
3	MA04591	panel	AMX-180 1.0t*327.5*384*42mm_V1.1	
4	MJ00061	Zn-plated board	1*2135*1220 20.45kg	
5	ME00113	iron pillar	M3*13.8*0.5PH_V1.1	
6	MB03115	rear board	AMX-180	
7	MB03116	bottom board	AMX-180 1.0t*330*384*43mm	
8	MJ00058	iron board	1*2135*1220 20.45kg	
9	HI00026	power switch	RA12KKATOF 2P	
10	HI00171	power switch	R612KKATOF1	
11	NI01863	key	ϕ 5.5*W10*7.5	
12	NI01862	key	5.5*5.5*14.5	
13	NI02377	knob	ϕ 5.5*7.5mm(内径3.3*3.3mm)	
14	NI02083	knob	ϕ 10.5*18mm	
15	NI02082	knob	ϕ 10.5*18mm	
16	NI02817	knob	ϕ 10.5*18mm	
17	NI02081	knob	ϕ 10.5*18mm	
18	NI02714	knob	ϕ 10*13.5mm	
19	NI02309	knob	24*11.5*11	
20	NI02352	knob	24*11.5*11	
21	NI02353	knob	24*11.5*11	
22	MG00041	screw	M3*6	
23	MG00061	screw	M3*10	
24	MG00247	copper pillar	M3*10*0.5PHsingle length16	
25	ME00060	nut	JY-6351G-02-250	
26	MF00061	washer	JY-6351G-02-250	
27	NI01945	handle	AMX-180;180FX_V1.0	
28	NI02878	handle	330*33*26mm AMX-180 black	
29	HA01388	row-wire connector wiring	2P 100	
30	HA01442	row-wire connector wiring	2P 200	
31	TG00144	adapter	100V~50/60Hz_AC18V/1500mA_EI-57	
32	MJ00808	power clip	WL3-32T	
33	NC00080	wood washer	ϕ 3.17* ϕ 8.2*1	
34	NC00014	insulator	0.65M*60M*1t	
35	NI00252	sleeve	ϕ 4*20mm	

AMX-180 Parts List

No.	Part No.	Description	Specification	Remark
36	NI00248	sleeve	φ 4*1000mm	
37	NI00498	foot cushion	12.7*7*6mm(SF-005)	
38	NA00135	PE bag	0.05t*610*500mm	
39	HJ00006	desiccant	30g	
40	NF00061	assurance card	ALTO	
41	NE05004	label	ALTO	
42	NH00334	cone paper	0.040*1m	
43	NB03034	box	AMX-180 ALTO_V1.0	
44	NE12357	label	AMX-180	
45	NH00012	bond paper	0.04*1M	
46	NI00014	membrane	0.035*1M	
47	NB03033	paper outer case 6 hole	AMX-180 ALTO_V1.0	
48	NI02911	handle	ALTO 072C	
49	NE02717	label	MADE IN CHINA	
50	NH00038	paper	0.115*1M	
51	NI00028	membrane	0.110*1M	
52	HK04386	PC board	P-AMX180PU1-DIP	
53	CB00061	electrolytic capacitor	220uF/100V φ 13*26mm	C175
54	HC00321	row-wire header(male)	14P 2.0mm 180°	CN1
55	HC00505	row-wire header(male)	16P 2.0mm 180°	CN2,CN3
56	HC00183	DC power jack	KJ-36-S φ 3.5	CN5
57	HI00236	push-button switch	2-stage 6P PS-9226A(SELF-LOCK)	SW1,SW2,SW3,SW4,SW5,SW6,SW7,SW8
58	HI00237	push-button switch	2stage 12P PS-13422R(SELF-LOCK)	SW9
59	HC00065	row-wire header(male)	2P 2.5mm 90°	SW10,SW11
60	SD00077	integrated circuit	L7815CV(TO-220)(ST)	TR1
61	SD00079	integrated circuit	L7915CV(TO-220)(ST)	TR3
62	SB00043	transistor	TIP122(ST)	TR4
63	SD00007	integrated circuit	BA15218N (M5218L substitute)	U9,U10
64	RC00356	potentiometer	Z10K Ω RD09F1130042-10KZ(SAS1);30F	VR5,VR6,VR7,VR8,VR9
65	HC00392	XLR MIC jack	JY-5030-030G 180°	X37,X38
66	HC00125	MIC jack	JY-6351G-02-250	X1,X2,X3,X4,X5,X6,X7,X8,X9,X10,X11,X12,X13,X14,X15,X16,X17,X18,X19,X20,X21,X28,X29,X30,X31,X32,X33,X34,X35
67	HC00403	RCA jack	SCP6873NS3232T2 4P	X27
68	HC00126	XLR MIC jack	JY-5042-030G female plug 180°	X22,X23,X24,X25,X26
69	MI02232	heat sink	AMX-180_V1.0	
70	MJ00055	AL board	2*2000*1000 10.88kg	

AMX-180 Parts List

No.	Part No.	Description	Specification	Remark
71	NI02249	insulate bean	TW-1(TO-220)	
72	NC00005	silicone insulator	TO-220 square type	
73	MG00162	screw	M3*8	
74	ME00015	nut	3m/m	
75	HK04362	PC board	P-AMX180PU1-AI	
76	CB00238	electrolytic capacitor	0.22uF/50V ϕ 5*11mm	C82,C83,C84,C85,C86,C87,C88,C89,C90,C91,C92,C93
77	CB00242	electrolytic capacitor	22uF/35V ϕ 5*11mm	C21,C22,C23,C26,C27,C28,C29,C30
78	CB00194	electrolytic capacitor	47uF/25V ϕ 5*11mm	C94,C95,C96,C97,C98,C99,C100,C103,C106,C107,C108,C109,C110,C111,C112,C113,C114,C115,C116,C179,C180,C183,C185,C186,C187
79	CB00254	electrolytic capacitor	47uF/100V ϕ 10*12mm 5mm	C170,C171,C172
80	CB00249	electrolytic capacitor	47uF/50V ϕ 6.3*11mm 2.5mm	C169,C31,C32,C33,C34,C35,C36,C37,C38,C39,C40
81	CB00251	electrolytic capacitor	220UF/25V ϕ 8*11mm	C176,C177
82	CB00255	electrolytic capacitor	1000uF/10V ϕ 8*11mm 5mm	C41,C42,C43,C44,C45
83	SA00094	rectifier diode	1N4002/100V	D1,D2,D3,D4
84	RA00158	fixed resistor 1/4W	0.0 Ω M type	D7
85	RA01258	fixed resistor 1/4W	10 Ω	R206
86	RA01115	fixed resistor 1/4W	20K Ω	R209
87	RA01262	precise resistor 1/4W	6.81K Ω	R21,R22,R23,R24,R25,R26,R27,R28,R29,R30
88	SA00127	zener diode	1/2W 47V 1N5261	ZD1
89	HK04387	PC board	P-AMX180PU1-SMD	
90	HB01290	PCB	AMX180PU1_VER040821	
91	CI00051	SMD ceramic capacitor 0603	22PF/50V NPO \pm 5%	C7,C9,C46,C47,C48,C49,C50,C51,C52,C53,C54,C55,C56,C57,C58,C59,C60,C61,C62,C63,C64,C65,C66,C67,C68,C69,C70,C71,C72,C73,C74,C75,C76,C77,C78,C79,C80,C81,C119,C120
92	CI00055	SMD ceramic capacitor 0603	47PF/50V NPO \pm 5%	C6,C10,C15,C16,C20
93	CI00059	SMD ceramic capacitor 0603	100PF/50V NPO \pm 5%	C121,C122,C123,C124,C125,C126,C127,C128,C129,C130,C131,C132,C133,C134,C135,C136,C191,C192,C193,C194
94	CI00063	SMD ceramic capacitor 0603	470PF/50V NPO \pm 5%	C1,C2,C3,C4,C5,C8,C11,C12,C13,C14,C17,C18,C19
95	CI00075	SMD ceramic capacitor 0603	0.1uF/50V Y5V +80,-20%	C24,C25,C137,C138,C139,C140,C141,C142,C143,C144,C145,C146,C147,C148,C149,C150,C151,C152,C153,C154,C155,C156,C157,C158,C159,C160,C161,C162,C163,C166,C167,C168
96	SE00011	SMD rectifier diode	RLS4148 0.5A (LL-34)	D5,D6
97	RD00059	SMD fixed resistor 1/10W	0.0 Ω \pm 5% 0603	R178,R179,R204
98	RD00355	SMD fixed resistor 1/10W	4.7 Ω \pm 5% 0603	R11,R12,R13,R14,R15,R16,R17,R18,R19,R20
99	RD00265	SMD fixed resistor 1/10W	27 Ω \pm 5% 0603	R51,R52,R53,R54,R55
100	RD00069	SMD fixed resistor 1/10W	120 Ω \pm 5% 0603	R164,R165,R166,R167,R168,R169,R170,R171,R172,R173,R174,R175,R180,R181,R182,R183,R184,R185,R186,R187,R188,R189,R190,R191,R192,R193,R194,R195,R196,R197,R198,R199
101	RD00083	SMD fixed resistor 1/10W	1.0K Ω \pm 5% 0603	R176,R177
102	RD00351	SMD fixed resistor 1/10W	1.3K Ω \pm 5% 0603	R132,R133,R129,R135
103	RD00087	SMD fixed resistor 1/10W	2.0K Ω \pm 5% 0603	R156,R157,R158,R159,R160,R161,R162,R163
104	RD00352	SMD fixed resistor 1/10W	3.6K Ω \pm 5% 0603	R41,R42,R43,R44,R45,R46,R47,R48,R49,R50
105	RD00094	SMD fixed resistor 1/10W	5.1K Ω \pm 5% 0603	R3,R4,R34,R35,R200,R201,R202,R203

AMX-180 Parts List

No.	Part No.	Description	Specification	Remark
106	RD00097	SMD fixed resistor 1/10W	6.8KΩ ±5% 0603	R136,R137,R138,R139
107	RD00101	SMD fixed resistor 1/10W	10KΩ ±5% 0603	R76,R77,R78,R80,R81,R82,R83,R84,R85,R86,R87,R88,R92,R93,R94, R95,R96,R97,R98,R105,R106,R107,R108,R109,R110,R111,R112,R113, R114,R115,R116,R117,R118,R119,R120,R121,R122,R123,R124,R125, R126,R127,R208,R210,R211
108	RD00104	SMD fixed resistor 1/10W	18KΩ ±5% 0603	R79,R89,R90,R91
109	RD00306	SMD fixed resistor 1/10W	20KΩ ±5% 0603	R140,R141,R142,R143,R144,R145,R146,R147,R148, R149,R150,R151,R152,R153,R154,R155,R100
110	RD00354	SMD fixed resistor 1/10W	51KΩ ±5% 0603	R1,R2,R5,R6,R7,R8,R9,R10
111	RD00113	SMD fixed resistor 1/10W	62KΩ ±5% 0603	R128,R134,R130,R131
112	RD00345	SMD fixed resistor 1/10W	390KΩ ±5% 0603	R207
113	RD00210	SMD precise resistor 1/10W	5.11KΩ ±1% 0603	R56,R57,R58,R59,R60,R61,R62,R63,R64,R65, R67,R68,R69,R70,R71,R72,R73,R74,R75
114	RD00334	SMD precise resistor 1/10W	11.0KΩ ±1% 0603	R31,R32,R33,R36,R37,R38,R39,R40
115	SG00122	SMD integrated circuit	NJM4580M-TE3	U1,U2,U3,U4,U5,U6,U7,U8,U11,U12,U13,U15,U16,U17,U18
116	RD00099	SMD fixed resistor 1/10W	8.2KΩ ±5% 0603	R66
117	CB00252	electrolytic capacitor	1500uF/25V φ 12.5*20mm 5mm	C173,C174
118	MF00037	washer	φ 3* φ 5*1t	
119	HK04348	PC board	P-AMX180MN1-DIP	
120	HA03075	wire	14P(male)-14P(female) 40mm UL1007 28AWG	CN1
121	HA03177	wire	16-14P/2P 50/40mm UL1007 28AWG	CN2,CN17
122	HA03173	wire	16P-16P 300mm UL1007 28AWG	CN3
123	SA00052	L.E.D high intensity	3m/m round(green)long foot 26	LD29,LD32,LD33,LD34,LD35,LD36,LD37,LD38,LD39, LD40,LD41,LD44,LD45,LD46,LD47,LD48,LD49, LD50,LD51,LD52,LD53
124	SA00053	L.E.D high intensity	3m/m round(red)long foot 26mm	LD1,LD3,LD4,LD6,LD7,LD9,LD10,LD12,LD13,LD15,LD16,LD18, LD19,LD22,LD24,LD26,LD28,LD30,LD42,LD21
125	SA00054	L.E.D high intensity	3m/m round(yellow)long foot 26	LD2,LD5,LD8,LD11,LD14,LD17,LD20,LD23,LD27,LD31, LD43
126	NI01782	LED spacer support	LEDS-11 11mm	
127	HI00236	push-button switch	2-stage 6P PS-9226A(SELF-LOCK)	SW1,SW4,SW7,SW10,SW13,SW16,SW19,SW22, SW25,SW27,SW28,SW29,SW30,SW31
128	HI00237	push-button switch	2stage 12P PS-13422R(SELF-LOCK)	SW2,SW3,SW5,SW6,SW8,SW9,SW11,SW12,SW14,SW15, SW17,SW18,SW20,SW21,SW23,SW24,SW26
129	RC00284	potentiometer	D10KΩ RF6011YP600F-10KD(SAS1)	VR7,VR14,VR21,VR28,VR62,VR63
130	RC00285	potentiometer	D10KΩ RF60112P600G-10KD*2(SAS1)	VR35,VR42,VR49,VR56,VR64
131	RC00358	potentiometer	B50KΩ -RD09F113A223-50K2BT(SAS1);30F-C	VR1,VR2,VR3,VR8,VR9,VR10,VR15,VR16,VR17, VR22,VR23,VR24
132	RC00360	potentiometer	B50KΩ RD12L12CA23A-50K3BT*2(SAS1);30F-C	VR29,VR30,VR31,VR36,VR37,VR38,VR43,VR44, VR45,VR50,VR51,R52
133	RC00359	potentiometer	W50KΩ RD09F113A224-50K4BT(SAS1);30F-C	VR4,VR5,VR11,VR12,VR18,VR19,VR25,VR26,VR32,VR33, VR39,VR40,VR46,VR47,VR53,VR54,VR60,VR61
134	RC00361	potentiometer	W50KΩ RD12L12CA60B-50K4BT*2(SAS1);30F-C	VR57,VR58,VR59,VR65
135	HK04345	PC board	P-AMX180MN1-AI	
136	CF00138	metal-film capacitor MSC	0.012uF/63V ±5% CASE01	C89,C90,C91,C92,C93,C94,C95,C96,C97,C98,C99,C100,C101, C102,C103,C104,C105,C106,C107,C108,C109,C110,C111,C112
137	CF00136	metal-film capacitor MSC	0.018uF/63V 5% CASE01	C65,C66,C67,C68,C69,C70,C71,C72,C73,C74,C75,C76,C77, C78,C79,C80,C81,C82,C83,C84,C85,C86,C87,C88
138	CF00137	metal-film capacitor MSC	0.033uF/63V 5% CASE01	C113,C114,C115,C116,C117,C118,C119,C120,C121,C122, C123,C124,C125,C126,C127,C128,C129,C130,C131,C132, C133,C134,C135,C136
139	CB00239	electrolytic capacitor	2.2uF/50V φ 5*11mm	C161,C162,C163,C164,C165,C166,C167,C168,C299
140	CB00194	electrolytic capacitor	47uF/25V φ 5*11mm	C1,C2,C3,C4,C5,C6,C7,C8,C9,C10,C11,C12,C13,C14,C15,C16,C17,C18,C19, C20,C21,C22,C23,C24,C25,C26,C27,C28,C29,C30,C31,C32,C33,C34,C35,C36, C37,C38,C39,C40,C187,C188,C189,C190,C191,C195,C197,C198,C199,C200, C205,C206,C209,C210,C211,C212,C213,C214,C215,C216,C243,C244,C245, C246,C289,C290,C291,C292,C293,C294,C295,C297,C298

AMX-180 Parts List

No.	Part No.	Description	Specification	Remark
141	RA01260	fixed resistor 1/4W	120 Ω	R250,R387,R392
142	HK04385	PC board	P-AMX180MN1-SMD	
143	HB01291	PCB	AMX180MN1_VER040821	
144	CI00051	SMD ceramic capacitor 0603	22PF/50V NPO ±5%	<small>C137,C138,C139,C140,C141,C142,C143,C144,C145,C146,C147,C148,C149,C150,C151,C152,C153,C154,C155,C156,C157,C158,C159,C160,C169,C170,C171,C172,C173,C174,C175,C176,C177,C178,C179,C180,C185,C186,C241,C242,C253,C264,C265,C266,C282,C283,C284,C285,C286,C287,C288,C312,C313</small>
145	CI00059	SMD ceramic capacitor 0603	100PF/50V NPO ±5%	C251,C252
146	CI00075	SMD ceramic capacitor 0603	0.1uF/50V Y5V +80,-20%	<small>C41,C42,C43,C44,C45,C46,C47,C48,C49,C50,C51,C52,C53,C54,C55,C56,C57,C58,C59,C60,C61,C62,C63,C64,C217,C218,C219,C220,C221,C222,C223,C224,C225,C226,C227,C228,C229,C230,C231,C232,C234,C235,C237,C238,C296,C300,C301,C302,C303,C304,C305,C306,C307,C308,C309,C310,C311</small>
147	SE00008	SMD rectifier diode	DA204K/T-146	D1
148	SE00028	diode	BAS316,115	D2,D3,D4,D5,D6,D7,D8,D9,D11,D12
149	SE00011	SMD rectifier diode	RLS4148 0.5A (LL-34)	D13,D14,D16,D17
150	RD00059	SMD fixed resistor 1/10W	0.0 Ω ±5% 0603	R366,R367,R393,R394
151	RD00065	SMD fixed resistor 1/10W	47 Ω ±5% 0603	R424,R425
152	RD00346	SMD fixed resistor 1/10W	56 Ω ±5% 0603	R390
153	RD00069	SMD fixed resistor 1/10W	120 Ω ±5% 0603	RD00391
154	RD00076	SMD fixed resistor 1/10W	330 Ω ±5% 0603	R404,R405
155	RD00078	SMD fixed resistor 1/10W	470 Ω ±5% 0603	R401,R402,R403
156	RD00347	SMD fixed resistor 1/10W	510 Ω ±5% 0603	R249,R388,R389,R414
157	RD00348	SMD fixed resistor 1/10W	620 Ω ±5% 0603	R415
158	RD00080	SMD fixed resistor 1/10W	680 Ω ±5% 0603	R133,R134,R135,R136
159	RD00349	SMD fixed resistor 1/10W	910 Ω ±5% 0603	<small>R25,R26,R27,R28,R29,R30,R31,R32,R33,R34,R35,R36,R37,R38,R39,R40,R41,R42,R43,R44,R45,R46,R47,R48</small>
160	RD00083	SMD fixed resistor 1/10W	1.0K Ω ±5% 0603	R311,R313
161	RD00350	SMD fixed resistor 1/10W	1.1K Ω ±5% 0603	R1,R2,R3,R4,R5,R6,R7,R8,R9,R10,R11,R12
162	RD00351	SMD fixed resistor 1/10W	1.3K Ω ±5% 0603	R13,R14,R15,R16,R17,R18,R19,R20,R21,R22,R23,R24,R416
163	RD00085	SMD fixed resistor 1/10W	1.5K Ω ±5% 0603	R189,R190,R191,R192,R193,R194,R195,R196,R312,R314
164	RD00087	SMD fixed resistor 1/10W	2.0K Ω ±5% 0603	R417,R422
165	RD00088	SMD fixed resistor 1/10W	2.2K Ω ±5% 0603	R125,R126,R127,R128,R129,R130,R131,R132
166	RD00352	SMD fixed resistor 1/10W	3.6K Ω ±5% 0603	R458,R459
167	RD00093	SMD fixed resistor 1/10W	4.7K Ω ±5% 0603	<small>R197,R198,R199,R200,R201,R202,R203,R204,R205,R206,R207,R208,R209,R210,R211,R212,R213,R214,R215,R216,R217,R218,R219,R220,R423,R251,R252</small>
168	RD00094	SMD fixed resistor 1/10W	5.1K Ω ±5% 0603	<small>R105,R106,R108,R109,R111,R112,R114,R115,R137,R138,R141,R142,R145,R146,R149,R150,R153,R154,R155,R156,R157,R158,R159,R160,R161,R162,R163,R164,R165,R166,R167,R168,R169,R170,R171,R172,R173,R174,R175,R176,R256,R258,R259,R260,R381,R382,R383,R384,R385,R386,R430,R431,R432,R433,R434,R436,R437,R438,R439,R440,R441,R442,R444,R445,R446,R447,R448,R449,R450,R451</small>
169	RD00095	SMD fixed resistor 1/10W	5.6K Ω ±5% 0603	R418
170	RD00096	SMD fixed resistor 1/10W	6.2K Ω ±5% 0603	R255,R257,R277,R278
171	RD00097	SMD fixed resistor 1/10W	6.8K Ω ±5% 0603	<small>R49,R50,R51,R52,R53,R54,R55,R56,R57,R58,R59,R60,R61,R62,R63,R64,R65,R66,R67,R68,R69,R70,R71,R72,R73,R74,R75,R76,R77,R78,R79,R80,R139,R140,R143,R144,R147,R148,R151,R152</small>
172	RD00099	SMD fixed resistor 1/10W	8.2K Ω ±5% 0603	R261,R262,R279,R280,R372,R374,R419
173	RD00101	SMD fixed resistor 1/10W	10K Ω ±5% 0603	<small>R81,R82,R83,R84,R85,R86,R87,R88,R89,R90,R91,R92,R93,R94,R95,R96,R97,R98,R99,R100,R101,R102,R103,R104,R107,R110,R113,R116,R283,R284,R285,R286,R287,R288,R289,R290,R291,R294,R296,R300,R303,R304,R362,R363,R364,R365,R397,R398,R426,R427,R462,R463,R494,R495</small>
174	RD00102	SMD fixed resistor 1/10W	12K Ω ±5% 0603	R263,R264,R373,R375,R407,R409
175	RD00103	SMD fixed resistor 1/10W	15K Ω ±5% 0603	R221,R222,R223,R224,R360,R361

AMX-180 Parts List

No.	Part No.	Description	Specification	Remark
176	RD00306	SMD fixed resistor 1/10W	20K Ω \pm 5% 0603	R315,R316,R368,R369,R370,R371,R376,R377
177	RD00105	SMD fixed resistor 1/10W	22K Ω \pm 5% 0603	R307,R308,R309,R310
178	RD00106	SMD fixed resistor 1/10W	27K Ω \pm 5% 0603	R233,R234,R235,R236,R237,R238,R239,R240,R241, R242,R243,R244,R245,R246,R247,R248,R267,R268
179	RD00353	SMD fixed resistor 1/10W	36K Ω \pm 5% 0603	R273,R274,R399,R400
180	RD00111	SMD fixed resistor 1/10W	47K Ω \pm 5% 0603	R117,R118,R119,R120,R121,R122,R123,R124, R321,R322,R420,R421
181	RD00113	SMD fixed resistor 1/10W	62K Ω \pm 5% 0603	R410,R411,R412,R413
182	RD00116	SMD fixed resistor 1/10W	100K Ω \pm 5% 0603	R356,R357,R358,R359,R395,R396
183	RD00119	SMD fixed resistor 1/10W	220K Ω \pm 5% 0603	R380
184	RD00125	SMD fixed resistor 1/10W	1.0M Ω \pm 5% 0603	R177,R178,R179,R180,R181,R182,R183,R184, R185,R186,R187,R188
185	RD00468	SMD precise resistor 1/10W	7.68K Ω \pm 1% 0603	R428,R429,R435,R443
186	RD00432	SMD precise resistor 1/10W	12.7K Ω \pm 1% 0603	R225,R226,R227,R228,R229,R230,R231,R232
187	RD00217	SMD precise resistor 1/10W	14.0K Ω \pm 1% 0603	R253,R254,R265,R266
188	RD00450	SMD precise resistor 1/10W	48.7K Ω \pm 1% 0603	R317,R318
189	RD00303	SMD precise resistor 1/10W	57.6K Ω \pm 1% 0603	R319,R320
190	SF00056	transistor	MMBT3904(SOT-23)/(PHI)	TR1,TR2,TR3,TR4,TR5,TR6,TR7,TR8,TR9,TR10,T R11,TR12,TR15,TR16,TR17,TR18
191	SF00053	transistor	MMBT3906(SOT-23)/(PHI)	TR13,TR14,TR19
192	SF00039	SMD field effect transistor	MMBFJ112(SOT-23)/(FAIRCHILD)	TR20,TR21,TR22,TR23,TR24
193	SG00122	SMD integrated circuit	NJM4580M-TE3	U1,U2,U3,U4,U5,U6,U7,U8,U9,U10,U11,U12,U13,U14,U15,U16, U17,U18,U19,U20,U21,U22,U23,U24,U25,U26,U27,U28
194	SG00032	SMD integrated circuit	LM339DR/(TI)	U30,U31,U32,U33,U34,U35
195	RD00115	SMD fixed resistor 1/10W	82K Ω \pm 5% 0603	R378,R379
196	RD00358	SMD precise resistor 1/10W	18.2K Ω \pm 1% 0603	R305,R306
197	RD00437	SMD precise resistor 1/10W	44.2K Ω \pm 1% 0603	R269,R270
198	RD00294	SMD precise resistor 1/10W	24.9K Ω \pm 1% 0603	R406,R408
199	RD00098	SMD fixed resistor 1/10W	7.5K Ω \pm 5% 0603	R271,R272
200	RC00465	potentiometer	B5K Ω RD09F113A225-5K2BT(SAS1);30F-C	VR6,VR13,VR20,VR27,VR34,VR41,VR55,VR48
201	NF01882	instruction	AMX-180/180FX ALTO_V1.1	
202	NH00149	paper	889*640mm	
203	NB03166	cushion	AMX-180 left_V1.0	
204	NB03165	cushion	AMX-180 right_V1.0	
205	AD00012	twin adhesive	90*120mm_V1.0	
206	NA00279	clip-chain bag	0.04t*100*150mm_V1.0	
207	ND00234	non woven	0.35t*294*80mm	
208	NA00127	PE bag	0.1t*610*200mm	
209	MI02093	fixed bracket	AMX-180 left_V1.0	
210	MI02092	fixed bracket	AMX-180 left_V1.0	
211	MJ00058	iron board	1*2135*1220 20.45kg	
212	MI02095	fixed bracket	AMX-180 right_V1.0	
213	MI02094	fixed bracket	AMX-180 right_V1.0	
214	MJ00058	iron board	1*2135*1220 20.45kg	

AMX-180FX Parts List

No.	Part No.	Description	Specification	Remark
1	MA04751	panel	AMX-220 ALTO_V1.1	
2	MA04746	panel	AMX-220	
3	MA04747	panel	AMX-220 1.0t*439.5*402*42mm_V1.3	
4	ME00113	iron pillar	M3*13.8*0.5PH_V1.1	
5	MJ00061	Zn-plated board	1*2135*1220 20.45kg	
6	MB03216	rear board	AMX-220	
7	MB03217	bottom board	AMX-220 1.2t*442*402*43mm	
8	MJ00063	Zn-plated board	1.2*2135*1220 24.54kg	
9	HI00026	power switch	RA12KKATOF 2P	
10	HI00171	power switch	R612KKATOF1	
11	NI01863	key	φ 5.5*W10*7.5	
12	NI01862	key	5.5*5.5*14.5	
13	NI02377	knob	φ 5.5*7.5mm(内3.3*3.3mm)	
14	NI02083	knob	φ 10.5*18mm	
15	NI02082	knob	φ 10.5*18mm	
16	NI02817	knob	φ 10.5*18mm	
17	NI02081	knob	φ 10.5*18mm	
18	NI02714	knob	φ 10*13.5mm	
19	NI02309	knob	24*11.5*11	
20	NI02352	knob	24*11.5*11	
21	NI02353	knob	24*11.5*11	
22	MG00041	screw	M3*6	
23	MG00061	screw	M3*10	
24	MG00247	copper pillar	M3*10*0.5PHsingle length16	
25	ME00060	nut	JY-6351G-02-250	
26	MF00061	washer	JY-6351G-02-250	
27	TG00144	adapter	100V~50/60Hz_AC18V/1500mA_EI-57	
28	NI00252	sleeve	φ 4*20mm	
29	NI00248	sleeve	φ 4*1000mm	
30	NI00498	foot cushion	12.7*7*6mm(SF-005)	
31	NA00136	PE bag	0.05t*820*540mm	
32	HJ00006	desiccant	30g	
33	NE05004	label	ALTO	
34	NH00334	cone paper	0.040*1m	
35	NE13198	label	AMX-220_V1.0	

AMX-180FX Parts List

No.	Part No.	Description	Specification	Remark
36	NH00012	bond paper	0.04*1M	
37	NI00014	membrane	0.035*1M	
38	NI00218	cable tie-black	ALT-102SB	
39	HA01388	row-wire connector wiring	2P 100	
40	HA01442	row-wire connector wiring	2P 200	
41	NI01947	handle	AMX-220;220FX_V1.0	
42	NI02960	handle	442*33*26mm AMX-220 black	
43	NF00061	assurance card	ALTO	
44	NB03028	box	AMX-220 ALTO_V1.0	
45	NB03029	paper outer case 6 hole	AMX-220/220FX ALTO_V1.0	
46	HK04363	PC board	P-AMX-220MN1-DIP	
47	SA00052	L.E.D high intensity	3m/m round(green)long foot 26	LD16,LD17,LD18,LD19,LD20,LD21,LD22,LD23,LD24,LD25,LD26,LD27,LD28,LD29,LD30,LD31,LD32,LD33,LD34,LD35,LD36
48	SA00053	L.E.D high intensity	3m/m round(red)long foot 26mm	LD1,LD2,LD3,LD4,LD5,LD6,LD7,LD8,LD37,LD38,LD39,LD40
49	SA00054	L.E.D high intensity	3m/m round(yellow)long foot 26	LD9,LD10,LD11,LD12,LD13,LD14,LD15
50	NI01782	LED spacer support	LEDS-11 11mm	
51	RC00359	potentiometer	W50KΩ RD09F113A224-50K4BT(SAS1);30F-C	VR4,VR5,VR89,VR90,VR91,VR92,VR93,VR94,VR95,VR96
52	RC00360	potentiometer	B50KΩ RD12L12CA23A-50K3BT*2(SAS1);30F-C	VR33,VR34,VR35,VR36,VR37,VR38,VR39,VR40,VR41,VR42,VR43,VR45,VR46,VR47,VR48,VR52
53	RC00361	potentiometer	W50KΩ RD12L12CA60B-50K4BT*2(SAS1);30F-C	VR3,VR6,VR7,VR97
54	HC00261	row-wire header(male)	12P 2.0mm 180°	CN1,CN3,CN5,CN7
55	HC00505	row-wire header(male)	16P 2.0mm 180°	CN4
56	RC00285	potentiometer	D10KΩ RF60112P600G-10KD*2(SAS1)	VR49,VR50,VR51,VR56,VR64
57	RC00284	potentiometer	D10KΩ RF6011YP600F-10KD(SAS1)	VR1,VR2
58	HI00236	push-button switch	2-stage 6P PS-9226A(SELF-LOCK)	SW1,SW2,SW3,SW4,SW5,SW6,SW8,SW9,SW10,SW11
59	HI00237	push-button switch	2stage 12P PS-13422R(SELF-LOCK)	SW12,SW13,SW14,SW15,SW16,SW17,SW18,SW19,SW20
60	HK04364	PC board	P-AMX-220MN1-AI	
61	RA01260	fixed resistor 1/4W	120Ω	R317,R320,R346
62	CF00146	metal-film capacitor	0.001uF/63V 5% CASE01	C177,C178,C179,C180,C181,C182,C183,C184
63	CF00138	metal-film capacitor MSC	0.012uF/63V ±5% CASE01	C161,C162,C163,C164,C165,C166,C167,C168,C169,C170,C171,C172,C173,C174,C175,C176
64	CF00148	metal-film capacitor	0.0033uF/100V 5% CASE01	C205,C206,C207,C208,C209,C210,C211,C212,C213,C214,C215,C216,C217,C218,C219,C220
65	CF00147	metal-film capacitor	0.047uF/100V 5% CASE01	C221,C222,C223,C224,C225,C226,C227,C228
66	CB00248	electrolytic capacitor	2.2uF/50V φ 4*5mm	C229,C230,C231,C232,C233
67	CB00194	electrolytic capacitor	47uF/25V φ 5*11mm	C34,C35,C36,C37,C41,C42,C43,C44,C45,C46,C47,C48,C49,C50,C51,C56,C57,C63,C64,C65,C66,C67,C68,C69,C70,C71,C72,C73,C74,C75,C76,C77,C78,C79,C80,C81,C82,C83,C84,C85,C86,C87,C88,C89,C90,C91,C92,C93,C94,C97,C98,C99,C100,C101,C102,C243,C244
68	HK04365	PC board	P-AMX-220MN1-SMD	
69	HB01286	PCB	AMX-220MN1_VER040828	
70	RD00059	SMD fixed resistor 1/10W	0.0Ω ±5% 0603	R325,R326

AMX-180FX Parts List

No.	Part No.	Description	Specification	Remark
71	RD00065	SMD fixed resistor 1/10W	47Ω ±5% 0603	R343,R344
72	RD00069	SMD fixed resistor 1/10W	120Ω ±5% 0603	R176,R177
73	RD00347	SMD fixed resistor 1/10W	510Ω ±5% 0603	R321,R322,R345
74	RD00085	SMD fixed resistor 1/10W	1.5KΩ ±5% 0603	R295,R296,R297,R298
75	RD00086	SMD fixed resistor 1/10W	1.8KΩ ±5% 0603	R180,R181,R182,R183,R184,R185,R186,R187,R188,R189,R190,R191,R192,R193,R194,R195,R196,R197,R198,R199,R200,R201,R202,R203,R204,R205,R206,R207,R208,R209,R210,R211
76	RD00087	SMD fixed resistor 1/10W	2.0KΩ ±5% 0603	R342
77	RD00088	SMD fixed resistor 1/10W	2.2KΩ ±5% 0603	R291,R292,R293,R294
78	RD00093	SMD fixed resistor 1/10W	4.7KΩ ±5% 0603	R66,R71,R75,R76,R77
79	RD00094	SMD fixed resistor 1/10W	5.1KΩ ±5% 0603	R5,R6,R7,R8,R9,R10,R11,R12,R13,R17,R18,R23,R24,R25,R26,R27,R28,R29,R30,R34,R35,R36,R37,R38,R41,R42,R43,R46,R331,R333,R341,R348,R350,R353,R354,R355,R356,R355,R337,R339
80	RD00095	SMD fixed resistor 1/10W	5.6KΩ ±5% 0603	R330,R332,R334,R336,R338,R340,R347,R349
81	RD00096	SMD fixed resistor 1/10W	6.2KΩ ±5% 0603	R137
82	RD00097	SMD fixed resistor 1/10W	6.8KΩ ±5% 0603	R241,R242,R243,R244,R245,R246,R247,R248,R249,R250,R251,R252,R253,R254,R255,R256,R257,R258,R259,R260
83	RD00099	SMD fixed resistor 1/10W	8.2KΩ ±5% 0603	R2,R3,R49,R50
84	RD00101	SMD fixed resistor 1/10W	10KΩ ±5% 0603	R86,R87,R88,R89,R90,R91,R92,R93,R94,R95,R96,R97,R98,R104,R105,R106,R107,R108,R109,R110,R111,R112,R113,R114,R115,R116,R117,R118,R119,R120,R121,R122,R123,R124,R125,R126,R127,R128,R129,R130,R131,R132,R133,R134,R178,R179,R229,R329,R431,R432,R433,R434,R435,R436
85	RD00102	SMD fixed resistor 1/10W	12KΩ ±5% 0603	R47,R48,R156,R157,R158,R163,R164,R165,R166,R167,R168,R169
86	RD00103	SMD fixed resistor 1/10W	15KΩ ±5% 0603	R82,R83,R313,R314,R136,R135
87	RD00104	SMD fixed resistor 1/10W	18KΩ ±5% 0603	R1,R4,R44,R45,R51,R52,R53,R57
88	RD00306	SMD fixed resistor 1/10W	20KΩ ±5% 0603	R14,R15,R16,R31,R32,R33,R39,R40,R138,R139,R140,R141,R142,R143,R144,R145,R146,R147,R148,R149,R150,R151,R152,R154
89	RD00105	SMD fixed resistor 1/10W	22KΩ ±5% 0603	R63,R64,R65,R70,R221,R222,R223,R224,R227,R228,R229,R230,R231,R232,R351,R352,R19,R20,R21,R22,R153,R155,R311,R312,R315,R316
90	RD00106	SMD fixed resistor 1/10W	27KΩ ±5% 0603	R299,R300,R301,R302,R303,R304,R305,R306
91	RD00353	SMD fixed resistor 1/10W	36KΩ ±5% 0603	R318,R319
92	RD00110	SMD fixed resistor 1/10W	43KΩ ±5% 0603	R54,R55,R56,R58,R59,R60,R61,R62
93	RD00111	SMD fixed resistor 1/10W	47KΩ ±5% 0603	R277,R278,R279,R280,R281,R282,R283,R284,R285,R286,R287,R288,R289,R290,R80,R81
94	RD00112	SMD fixed resistor 1/10W	56KΩ ±5% 0603	R307,R308,R309,R310
95	RD00116	SMD fixed resistor 1/10W	100KΩ ±5% 0603	R170,R171,R172,R173,R174,R175,R323,R324
96	RD00263	SMD fixed resistor 1/10W	200KΩ ±5% 0603	R233,R234,R235,R236,R237,R238,R239,R240
97	RD00119	SMD fixed resistor 1/10W	220KΩ ±5% 0603	R212,R213,R214,R215,R216,R217,R218,R219,R220
98	RD00125	SMD fixed resistor 1/10W	1.0MΩ ±5% 0603	R261,R262,R263,R264,R265,R266,R267,R268,R269,R270,R271,R272,R273,R274,R275,R276
99	CI00075	SMD ceramic capacitor 0603	0.1uF/50V Y5V +80,-20%	C103,C104,C105,C106,C107,C108,C109,C110,C111,C112,C113,C114,C115,C116,C117,C122,C123,C124,C125,C126,C127,C128,C129,C130,C131,C132,C133,C134,C135,C136,C137,C138,C139,C140,C141,C142,C143,C144,C145,C146,C147,C148,C149,C150,C151,C152,C153,C154,C155,C156,C157,C158,C159,C160,C238,C248,C249,C250,C251
100	CI00051	SMD ceramic capacitor 0603	22PF/50V NPO ±5%	C1,C2,C3,C4,C5,C6,C7,C8,C9,C10,C11,C12,C13,C14,C15,C16,C17,C18,C19,C24,C25,C26,C27,C28,C29,C30,C31,C32,C33,C34,C35,C36,C37,C38,C39,C46,C186,C187,C188,C189,C190,C191,C192,C193,C194,C195,C196,C197,C198,C199,C200,C201,C202,C203,C204,C245,C246,C247
101	CI00055	SMD ceramic capacitor 0603	47PF/50V NPO ±5%	C239,C240
102	CI00059	SMD ceramic capacitor 0603	100PF/50V NPO ±5%	C241,C242
103	SE00011	SMD rectifier diode	RLS4148 0.5A (LL-34)	D3,D4,D5,D6,D7,D8
104	SE00028	diode	BAS316,115	D1,D2,D9,D10,D11,D12
105	SF00039	SMD field effect transistor	MMBFJ112(SOT-23)/(FAIRCHILD)	TR11,TR12,TR13,TR14,TR15

AMX-180FX Parts List

No.	Part No.	Description	Specification	Remark
106	SF00056	transistor	MMBT3904(SOT-23)/(PHI)	TR1, TR2, TR3, TR4, TR5, TR6, TR7, TR8
107	SF00053	transistor	MMBT3906(SOT-23)/(PHI)	TR9, TR10, TR16
108	SG00122	SMD integrated circuit	NJM4580M-TE3	U1,U2,U3,U4,U5,U6,U7,U10,U11,U12,U13,U14,U15,U16,U17,U24,U25,U26,U27,U28,U29,U30,U31,U32,U33,U34,U35,U8,U9
109	RD00089	SMD fixed resistor 1/10W	2.7K Ω \pm 5% 0603	R67,R69,R73,R74,R78,R79,R68,R72
110	RD00303	SMD precise resistor 1/10W	57.6K Ω \pm 1% 0603	R85,R84
111	HK04376	PC board	P-12VMETER-DIP(AMX-220)	CN8,CN9
112	HC00698	row pin (single)#5100	2.0 90° 17P(gold-plated)2.5/9.5mm 2mm	CN6
113	HK04377	PC board	P-12VMETER-SMD(AMX-220)	
114	HB01285	PCB	12VMETER(2*5)_VER040611	
115	RD00304	SMD fixed resistor 1/10W	33 Ω \pm 5% 0603	R1
116	RD00069	SMD fixed resistor 1/10W	120 Ω \pm 5% 0603	R2
117	RD00076	SMD fixed resistor 1/10W	330 Ω \pm 5% 0603	R4,R6
118	RD00078	SMD fixed resistor 1/10W	470 Ω \pm 5% 0603	R3,R5,R7
119	RD00347	SMD fixed resistor 1/10W	510 Ω \pm 5% 0603	R8
120	RD00348	SMD fixed resistor 1/10W	620 Ω \pm 5% 0603	R9
121	RD00351	SMD fixed resistor 1/10W	1.3K Ω \pm 5% 0603	R10
122	RD00087	SMD fixed resistor 1/10W	2.0K Ω \pm 5% 0603	R11
123	RD00101	SMD fixed resistor 1/10W	10K Ω \pm 5% 0603	R12
124	RD00115	SMD fixed resistor 1/10W	82K Ω \pm 5% 0603	R13
125	CI00075	SMD ceramic capacitor 0603	0.1uF/50V Y5V +80,-20%	C1,C2
126	SG00210	SMD integrated circuit	LM339DT/(ST)	U1,U2,U3
127	RC00465	potentiometer	B5K Ω RD09F113A225-5K2BT(SAS1);30F-C	VR69,VR70,VR71,VR72
128	HK04367	PC board	P-AMX-220MN2-DIP	
129	SA00053	L.E.D high intensity	3m/m round(red)long foot 26mm	LD9,LD10,LD11,LD12,LD13,LD14,LD15,LD16,LD17,LD18,LD19,LD20,LD21,LD22,LD23,LD24
130	SA00054	L.E.D high intensity	3m/m round(yellow)long foot 26	LD1,LD2,LD3,LD4,LD5,LD6,LD7,LD8
131	NI01782	LED spacer support	LEDS-11 11mm	
132	RC00358	potentiometer	B50K Ω -RD09F113A223-50K2BT(SAS1);30F-C	VR9,VR10,VR11,VR12,VR13,VR14,VR15,VR16,VR17,VR18,VR19,VR20,VR21,VR22,VR23,VR24,VR25,VR26,VR27,VR28,VR29,VR30,VR31,VR32
133	RC00359	potentiometer	W50K Ω RD09F113A224-50K4BT(SAS1);30F-C	VR73,VR74,VR75,VR76,VR77,VR78,VR79,VR80,VR81,VR82,VR83,VR84,VR85,VR86,VR87,VR88
134	RC00284	potentiometer	D10K Ω RF6011YP600F-10KD(SAS1)	VR53,VR54,VR55,VR56,VR57,VR58,VR59,VR60
135	HC00259	row-wire header(male)	8P 2.0mm 180°	CN3,CN6
136	HC00261	row-wire header(male)	12P 2.0mm 180°	CN1
137	HA03123	wire	16P-16P 230mm UL1007 28AWG	CN2
138	HI00236	push-button switch	2-stage 6P PS-9226A(SELF-LOCK)	SW1,SW4,SW7,SW10,SW32,SW35,SW38,SW41
139	HI00237	push-button switch	2stage 12P PS-13422R(SELF-LOCK)	SW2,SW3,SW5,SW6,SW8,SW9,SW11,SW12,SW33,SW34,SW36,SW37,SW39,SW40,SW42,SW43
140	RC00366	potentiometer	C500K Ω RD12L123A43D-500K15C*2(SAS1)30F-C	VR1,VR2,VR3,VR4,VR5,VR6,VR7,VR8

AMX-180FX Parts List

No.	Part No.	Description	Specification	Remark
141	HK04368	PC board	P-AMX-220MN2-AI	
142	RA01260	fixed resistor 1/4W	120Ω	R57
143	CB00248	electrolytic capacitor	2.2uF/50V φ 4*5mm	C249,C250,C251,C252,C253,C254,C255,C256
144	CB00194	electrolytic capacitor	47uF/25V φ 5*11mm	C201,C202,C203,C204,C205,C206,C207,C208,C209,C210,C211,C212,C213,C214,C215,C216,C217,C218,C219,C220,C221,C222,C223,C224
145	CF00143	metal-film capacitor MSC	0.0015uF/100V 5% CASE01	C57,C58,C59,C60,C61,C62,C63,C64
146	CF00137	metal-film capacitor MSC	0.033uF/63V 5% CASE01	C65,C66,C67,C68,C69,C70,C71,C72,C73,C74,C75,C76,C77,C78,C79,C80
147	CF00141	metal-film capacitor MSC	0.0068uF/100V 5% CASE01	C1,C2,C3,C4,C5,C6,C7,C8,C9,C10,C11,C12,C13,C14,C15,C16,C17,C18,C19,C20,C21,C22,C23,C24
148	HK04369	PC board	P-AMX-220MN2-SMD	
149	HB01287	PCB	AMX-220MN2_VER040828	
150	RD00347	SMD fixed resistor 1/10W	510Ω ±5% 0603	R58
151	RD00085	SMD fixed resistor 1/10W	1.5KΩ ±5% 0603	R317,R318,R319,R320,R321,R322,R323,R324
152	RD00088	SMD fixed resistor 1/10W	2.2KΩ ±5% 0603	R181,R182,R183,R184,R185,R186,R187,R188,R249,R250,R251,R252,R253,R254,R255,R256,R267,R261,R262,R263,R264,R265,R266,R268
153	RD00090	SMD fixed resistor 1/10W	3.0KΩ ±5% 0603	R1,R2,R3,R4,R5,R6,R7,R8
154	RD00092	SMD fixed resistor 1/10W	3.9KΩ ±5% 0603	R85,R86,R87,R88,R89,R90,R91,R92
155	RD00093	SMD fixed resistor 1/10W	4.7KΩ ±5% 0603	R245,R246,R247,R248,R258,R259,R260,R257
156	RD00094	SMD fixed resistor 1/10W	5.1KΩ ±5% 0603	R60,R62,R64,R66,R68,R70,R72,R74,R93,R94,R95,R96,R97,R98,R99,R100,R103,R104,R107,R108,R111,R112,R115,R116,R117,R118,R119,R120,R121,R122,R123,R124,R127,R128,R131,R132,R135,R136,R139,R140
157	RD00095	SMD fixed resistor 1/10W	5.6KΩ ±5% 0603	R59,R61,R63,R65,R67,R69,R71,R73,R165,R166,R167,R168,R169,R170,R171,R172,R173,R174,R175,R176,R177,R178,R179,R180
158	RD00096	SMD fixed resistor 1/10W	6.2KΩ ±5% 0603	R9,R10,R11,R12,R13,R14,R15,R16,R17,R18,R19,R20,R21,R22,R23,R24
159	RD00097	SMD fixed resistor 1/10W	6.8KΩ ±5% 0603	R217,R218,R219,R220,R221,R222,R223,R224
160	RD00101	SMD fixed resistor 1/10W	10KΩ ±5% 0603	R25,R26,R27,R28,R29,R30,R31,R32,R33,R34,R35,R36,R37,R38,R39,R40,R41,R42,R43,R44,R45,R46,R47,R48,R49,R50,R51,R52,R53,R54,R55,R56
161	RD00306	SMD fixed resistor 1/10W	20KΩ ±5% 0603	R101,R102,R105,R106,R109,R110,R113,R114,R125,R126,R129,R130,R133,R134,R137,R138
162	RD00106	SMD fixed resistor 1/10W	27KΩ ±5% 0603	R329,R330,R331,R332,R333,R334,R335,R336,R337,R338,R339,R340,R341,R342,R343,R344
163	RD00111	SMD fixed resistor 1/10W	47KΩ ±5% 0603	R281,R282,R283,R284,R285,R286,R287,R288
164	RD00114	SMD fixed resistor 1/10W	68KΩ ±5% 0603	R301,R302,R303,R304,R305,R306,R307,R308
165	RD00125	SMD fixed resistor 1/10W	1.0MΩ ±5% 0603	R193,R194,R195,R196,R197,R198,R199,R200
166	CI00075	SMD ceramic capacitor 0603	0.1uF/50V Y5V +80,-20%	C81,C82,C83,C84,C85,C86,C87,C88,C89,C90,C91,C92,C93,C94,C95,C96,C97,C98,C99,C100,C101,C102,C103,C104,C105,C106,C107,C108,C109,C110,C111,C112
167	CI00051	SMD ceramic capacitor 0603	22PF/50V NPO ±5%	C25,C26,C27,C28,C29,C30,C31,C32,C33,C34,C35,C36,C37,C38,C39,C40,C137,C138,C139,C140,C141,C142,C143,C144
168	SE00028	diode	BAS316, 115	D1,D2,D3,D4,D5,D6,D7,D8
169	SF00056	transistor	MMBT3904(SOT-23)/(PHI)	TR1,TR2,TR3,TR4,TR5,TR6,TR7,TR8,TR9,TR10,TR11,TR12,TR13,TR14,TR15,TR16
170	SF00053	transistor	MMBT3906(SOT-23)/(PHI)	TR17
171	SG00122	SMD integrated circuit	NJM4580M-TE3	U1,U2,U3,U4,U5,U6,U7,U8,U9,U10,U11,U12,U13,U14,U15,U16
172	RC00465	potentiometer	B5KΩ RD09F113A225-5K2BT(SAS1);30F-C	VR61,VR62,VR63,VR64,VR65,VR66,VR67,VR68
173	HK04370	PC board	P-AMX-220PU1-DIP	
174	CB00082	electrolytic capacitor	2200uF/25V φ 16*21mm	C57,C58,C81,C82
175	CB00052	electrolytic capacitor	100uF/100V φ 13*21mm	C61

AMX-180FX Parts List

No.	Part No.	Description	Specification	Remark
176	SB00043	transistor	TIP122(ST)	TR3
177	SD00077	integrated circuit	L7815CV(TO-220)(ST)	TR1
178	SD00079	integrated circuit	L7915CV(TO-220)(ST)	TR2
179	SD00007	integrated circuit	BA15218N (M5218L substitute)	U5,U6
180	HI00236	push-button switch	2-stage 6P PS-9226A(SELF-LOCK)	SW1,SW2,SW3,SW4
181	HI00237	push-button switch	2stage 12P PS-13422R(SELF-LOCK)	SW5
182	HC00183	DC power jack	KJ-36-S ϕ 3.5	CN6
183	HC00403	RCA jack	SCP6873NS3232T2 4P	X3
184	HC00125	MIC jack	JY-6351G-02-250	X4,X5,X6,X7,X8,X9,X10,X11,X12,X13,X14,X15,X16,X17,X18,X19,X20
185	HC00392	XLR MIC jack	JY-5030-030G 180°	X1,X2
186	HC00065	row-wire header(male)	2P 2.5mm 90°	SW9
187	HA03124	wire	8P/8P-8P 120/200mm UL1007 28AWG	CN4
188	HA03128	wire	12P(male)-12P(female) 60mm UL1007 28AWG	CN1,CN2,CN3
189	HA03129	wire	12P(male)-12P(female) 280mm UL1007 28AW	CN5
190	MG00166	screw	M3*10	TR1,TR2,TR3
191	NC00005	silicone insulator	TO-220 square type	TR1,TR2,TR3
192	MF00037	washer	ϕ 3* ϕ 5*1t	TR1,TR2,TR3
193	ME00015	nut	3m/m	TR1,TR2,TR3
194	NI00863	insulate bean	TO220B	TR1,TR2,TR3
195	HK04371	PC board	P-AMX-220PU1-AI	
196	RA01258	fixed resistor 1/4W	10 Ω	R89
197	RA01115	fixed resistor 1/4W	20K Ω	R90
198	CB00253	electrolytic capacitor	1000uF/16V ϕ 10*16mm 5mm	C62
199	CB00256	electrolytic capacitor	1000uF/25V ϕ 10*20mm 5mm	C59,C60
200	CB00194	electrolytic capacitor	47uF/25V ϕ 5*11mm	C43,C44,C45,C46,C47,C48,C49,C50,C51,C52,C65,C66,C67,C68,C69,C70,C71,C72
201	CB00254	electrolytic capacitor	47uF/100V ϕ 10*12mm 5mm	C53,C54,C55,C56
202	SA00094	rectifier diode	1N4002/100V	D1,D2,D3,D4
203	SA00127	zener diode	1/2W 47V 1N5261	ZD1
204	HK04372	PC board	P-AMX-220PU1-SMD	
205	HB01288	PCB	AMX-220PU1_VER040828	
206	RD00059	SMD fixed resistor 1/10W	0.0 Ω \pm 5% 0603	R91
207	RD00065	SMD fixed resistor 1/10W	47 Ω \pm 5% 0603	R79,R80
208	RD00069	SMD fixed resistor 1/10W	120 Ω \pm 5% 0603	R43,R44,R45,R46,R47,R48,R49,R50,R51,R52,R53,R54,R55,R56,R57,R58,R59,R60,R61,R62,R63,R64,R65,R66,R67,R68,R69,R70
209	RD00083	SMD fixed resistor 1/10W	1.0K Ω \pm 5% 0603	R81,R82
210	RD00087	SMD fixed resistor 1/10W	2.0K Ω \pm 5% 0603	R35,R36,R37,R38,R39,R40,R41,R42

AMX-180FX Parts List

No.	Part No.	Description	Specification	Remark
211	RD00094	SMD fixed resistor 1/10W	5.1KΩ ±5% 0603	R83,R84,R85,R86
212	RD00097	SMD fixed resistor 1/10W	6.8KΩ ±5% 0603	R160,R161
213	RD00101	SMD fixed resistor 1/10W	10KΩ ±5% 0603	R1,R2,R3,R4,R5,R6,R7,R8,R9,R10,R11,R12,R13,R14,R15, R16,R17,R18,R19,R20,R21,R22,R23,R24,R25,R26,R27,R2 8,R29,R30,R31,R32,R33,R34,R88,R100,R101,R102,R103
214	RD00102	SMD fixed resistor 1/10W	12KΩ ±5% 0603	R159,R162
215	RD00306	SMD fixed resistor 1/10W	20KΩ ±5% 0603	R71,R72,R73,R74,R75,R76,R77,R78
216	RD00345	SMD fixed resistor 1/10W	390KΩ ±5% 0603	R87
217	CI00051	SMD ceramic capacitor 0603	22PF/50V NPO ±5%	C1,C2,C3,C4,C5,C6,C7,C8,C9,C10,C11,C12,C 13,C14,C15,C16,C63,C64,C78,C79,C77,C80
218	CI00059	SMD ceramic capacitor 0603	100PF/50V NPO ±5%	C17,C18,C19,C20,C21,C22,C23,C24,C25,C26,C2 7,C28,C29,C30,C31,C32,C234,C235,C236,C237
219	CI00075	SMD ceramic capacitor 0603	0.1uF/50V Y5V +80,-20%	C33,C34,C35,C36,C37,C38,C39,C40,C41,C42, C73,C74,C75,C76
220	SE00011	SMD rectifier diode	RLS4148 0.5A (LL-34)	D5,D6
221	SG00122	SMD integrated circuit	NJM4580M-TE3	U1,U2,U3,U4,U8,U9
222	MJ00312	heat sink	AMX-220_V1.0	
223	MJ00055	AL board	2*2000*1000 10.88kg	
224	HK04373	PC board	P-AMX-220PU2-DIP	
225	HI00236	push-button switch	2-stage 6P PS-9226A(SELF-LOCK)	SW1,SW2,SW3,SW4,SW5,SW6,SW7,SW8
226	RC00356	potentiometer	Z10KΩ RD09F1130042-10KZ(SAS1);30F	VR1,VR2,VR3,VR4,VR5,VR6,VR7,VR8
227	HC00125	MIC jack	JY-6351G-02-250	X9,X10,X11,X12,X13,X14,X15,X16,X17,X18, X19,X20,X21,X22,X23,X24
228	HC00126	XLR MIC jack	JY-5042-030G female plug 180°	X1,X2,X3,X4,X5,X6,X7,X8
229	HC00259	row-wire header(male)	8P 2.0mm 180°	CN2
230	HA03128	wire	12P(male)-12P(female) 60mm UL1007 28AWG	CN1
231	HK04374	PC board	P-AMX-220PU2-AI	
232	RA01262	precise resistor 1/4W	6.81KΩ	R65,R66,R67,R68,R69,R70,R71,R72,R73,R 74,R75,R76,R77,R78,R79,R80
233	CB00238	electrolytic capacitor	0.22uF/50V φ 5*11mm	C137,C138,C139,C140,C141,C142,C143,C144,C145, C146,C147,C148,C149,C150,C151,C152,C153,C154, C155,C156,C157,C158,C159,C160
234	CB00255	electrolytic capacitor	1000uF/10V φ 8*11mm 5mm	C129,C130,C131,C132,C133,C134,C135,C136
235	CB00242	electrolytic capacitor	22uF/35V φ 5*11mm	C97,C98,C99,C100,C101,C102,C103,C104,C105, C106,C107,C108,C109,C110,C111,C112
236	CB00194	electrolytic capacitor	47uF/25V φ 5*11mm	C161,C162,C163,C164,C165,C166,C167,C168,C1 69,C170,C171,C172,C173,C174,C175,C176,C177, C178,C179,C180,C181,C182,C183,C184
237	SA00093	rectifier diode	1N4148 0.5A	D1
238	HK04375	PC board	P-AMX-220PU2-SMD	
239	HB01289	PCB	AMX-220PU2_VER040828	
240	RD00355	SMD fixed resistor 1/10W	4.7Ω ±5% 0603	R1,R2,R3,R4,R5,R6,R7,R8,R9,R10,R11,R12 ,R13,R14,R15,R16
241	RD00265	SMD fixed resistor 1/10W	27Ω ±5% 0603	R81,R82,R83,R84,R85,R86,R87,R88
242	RD00351	SMD fixed resistor 1/10W	1.3KΩ ±5% 0603	R137,R138,R139,R140,R141,R142,R143,R144
243	RD00306	SMD fixed resistor 1/10W	20KΩ ±5% 0603	R153,R154,R155,R156,R157,R158,R159,R160,R1 69,R170,R171,R172,R173,R174,R175,R176
244	RD00113	SMD fixed resistor 1/10W	62KΩ ±5% 0603	R145,R146,R147,R148,R149,R150,R151,R152
245	RD00406	SMD precise resistor 1/10W	3.60KΩ ±1% 0603	R49,R50,R51,R52,R53,R54,R55,R56,R57,R58, R59,R60,R61,R62,R63,R64

AMX-180FX Parts List

No.	Part No.	Description	Specification	Remark
246	RD00210	SMD precise resistor 1/10W	5.11K Ω \pm 1% 0603	R105,R106,R107,R108,R109,R110,R111,R112,R113,R114,R115,R116,R117,R118,R119,R120,R121,R122,R123,R124,R125,R126,R127,R128,R129,R130,R131,R132,R133,R134,R135,R136
247	RD00097	SMD fixed resistor 1/10W	6.8K Ω \pm 5% 0603	R161,R162,R163,R164,R165,R166,R167,R168
248	RD00214	SMD precise resistor 1/10W	10.0K Ω \pm 1% 0603	R89,R90,R91,R92,R93,R94,R95,R96,R97,R98,R99,R100,R101,R102,R103,R104
249	RD00334	SMD precise resistor 1/10W	11.0K Ω \pm 1% 0603	R33,R34,R35,R36,R37,R38,R39,R40,R41,R42,R43,R44,R45,R46,R47,R48
250	RD00371	SMD precise resistor 1/10W	51.1K Ω \pm 1% 0603	R17,R18,R19,R20,R21,R22,R23,R24,R25,R26,R27,R28,R29,R30,R31,R32
251	CI00075	SMD ceramic capacitor 0603	0.1uF/50V Y5V \pm 5%,-20%	C33,C34,C35,C36,C37,C38,C39,C40,C41,C42,C43,C44,C45,C46,C47,C48,C49,C50,C51,C52,C53,C54,C55,C56,C57,C58,C59,C60,C61,C62,C63,C64
252	CI00051	SMD ceramic capacitor 0603	22PF/50V NPO \pm 5%	C65,C66,C67,C68,C69,C70,C71,C72,C73,C74,C75,C76,C77,C78,C79,C80,C81,C82,C83,C84,C85,C86,C87,C88,C89,C90,C91,C92,C93,C94,C95,C96
253	CI00055	SMD ceramic capacitor 0603	47PF/50V NPO \pm 5%	C25,C26,C27,C28,C29,C30,C31,C32
254	CI00063	SMD ceramic capacitor 0603	470PF/50V NPO \pm 5%	C1,C2,C3,C4,C5,C6,C7,C8,C9,C10,C11,C12,C13,C14,C15,C16,C17,C18,C19,C20,C21,C22,C23,C24
255	SG00122	SMD integrated circuit	NJM4580M-TE3	U1,U2,U3,U4,U5,U6,U7,U8,U9,U10,U11,U12,U13,U14,U15,U16
256	CB00249	electrolytic capacitor	47uF/50V ϕ 6.3*11mm 2.5mm	C113,C114,C115,C116,C117,C118,C119,C120,C121,C122,C123,C124,C125,C126,C127,C128
257	NE02717	label	MADE IN CHINA	
258	NH00038	paper	0.115*1M	
259	NI00028	membrane	0.110*1M	
260	AD00012	twin adhesive	90*120mm_V1.0	
261	NA00279	clip-chain bag	0.04t*100*150mm_V1.0	
262	NB03168	cushion	AMX-220 left_V1.0	
263	NB03167	cushion	AMX-220 right_V1.0	
264	NF01910	instruction	AMX-220/220FX ALTO_V1.1	
265	NH00149	paper	889*640mm	
266	ND00233	non woven	0.35t*402*79mm	
267	NA00127	PE bag	0.1t*610*200mm	
268	MI02097	fixed bracket	AMX-220 left_V1.0	
269	MI02096	fixed bracket	AMX-220 left_V1.0	
270	MJ00088	iron board	1.5*2135*1220 30.67kg	
271	MI02099	fixed bracket	AMX-220 right_V1.0	
272	MI02098	fixed bracket	AMX-220 right_V1.0	
273	MJ00088	iron board	1.5*2135*1220 30.67kg	