

Service Manual

Model: **CONTROL30**

15+15 BAND DIGITAL EQUALIZER



www.altoproaudio.com

Version: 1.1

CONTENTS

- 1. Specification**
- 2. Block Diagram**
- 3. Schematic Diagram**
- 4. Printed Circuit Board**
- 5. Wiring Diagram**
- 6. Test Procedure**
- 7. Electrical Parts List**
- 8. Exploded Views & Mechanical Parts List**
- 9. Notes**

1. SPECIFICATION (CONTROL30)

Analog Input section

Inputs: Analog variable gain, 2 XLR-F electronically balanced
Input Impedance: 44 kOhms
Max. input Level: 15 dBu (4.4V RMS)
Sensitivity: -22 dBu (63mV RMS)

Analog Output section

Outputs: Analog variable gain, 2 XLR-M electronically balanced
Output Impedance <150 Ohms
Max. output level: 17 dBu on 600 Ohms (5.5V RMS)

Digital / Analog Interface

Amplitude Response: 20 Hz - 20 kHz + 0.2 / - 2.5 dB
Signal to Noise Ratio 90 dB (A wtg. / 20 Hz-20kHz)
THD+N 0.03 % @ 1kHz -6 dB (VU-meter level)
Group Delay 700 us
Sampling Frequency 46.875 kHz
Conversion 1 bit Sigma-Delta

Digital

Processor Speed: 12 MIPS
DSP Resolution: 24x32bits
Control: Microprocessor

MIDI Section

Connections: Input/Output/Thru
Sockets 5-poles DIN (female)
Mode Photocoupled

Power Supply

Connector type: 3-pole IEC, grounded
Type: Servo controlled, stabilized
Mains supply: 115V or 230V 50/60 Hz
Power Rating: 9 W

User Interface

numeric LCD Display: 2x20 characters
Keyboard: 7 user keys / 5 LEDs
VU meter: 2x6 LEDs

Physical

Size: Standard 19" rack mounting
Dimensions (W/H/D): 483mm 44mm 232.5mm (19.32" 1.76" 9.3")
Net Weight: 3.8Kg

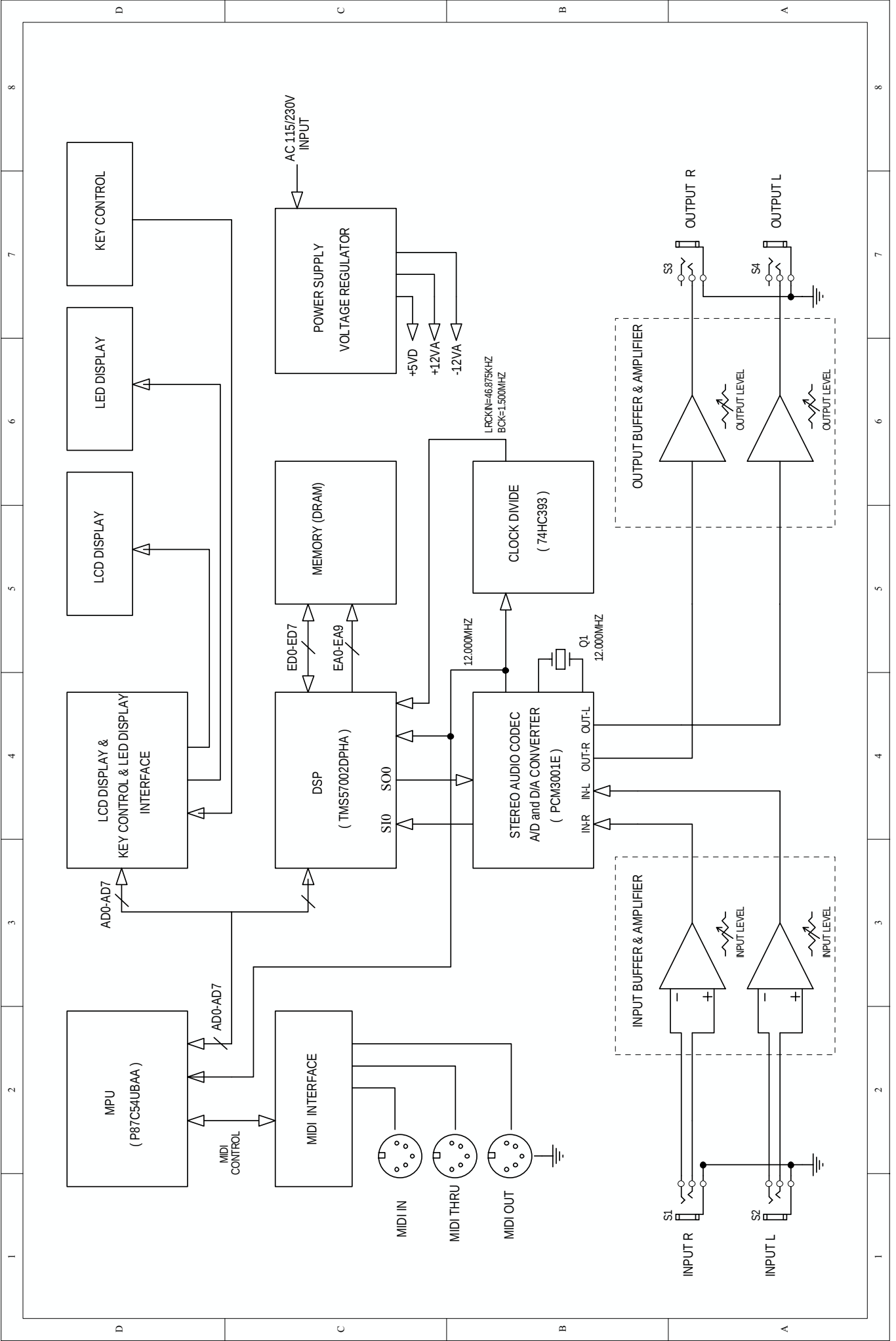

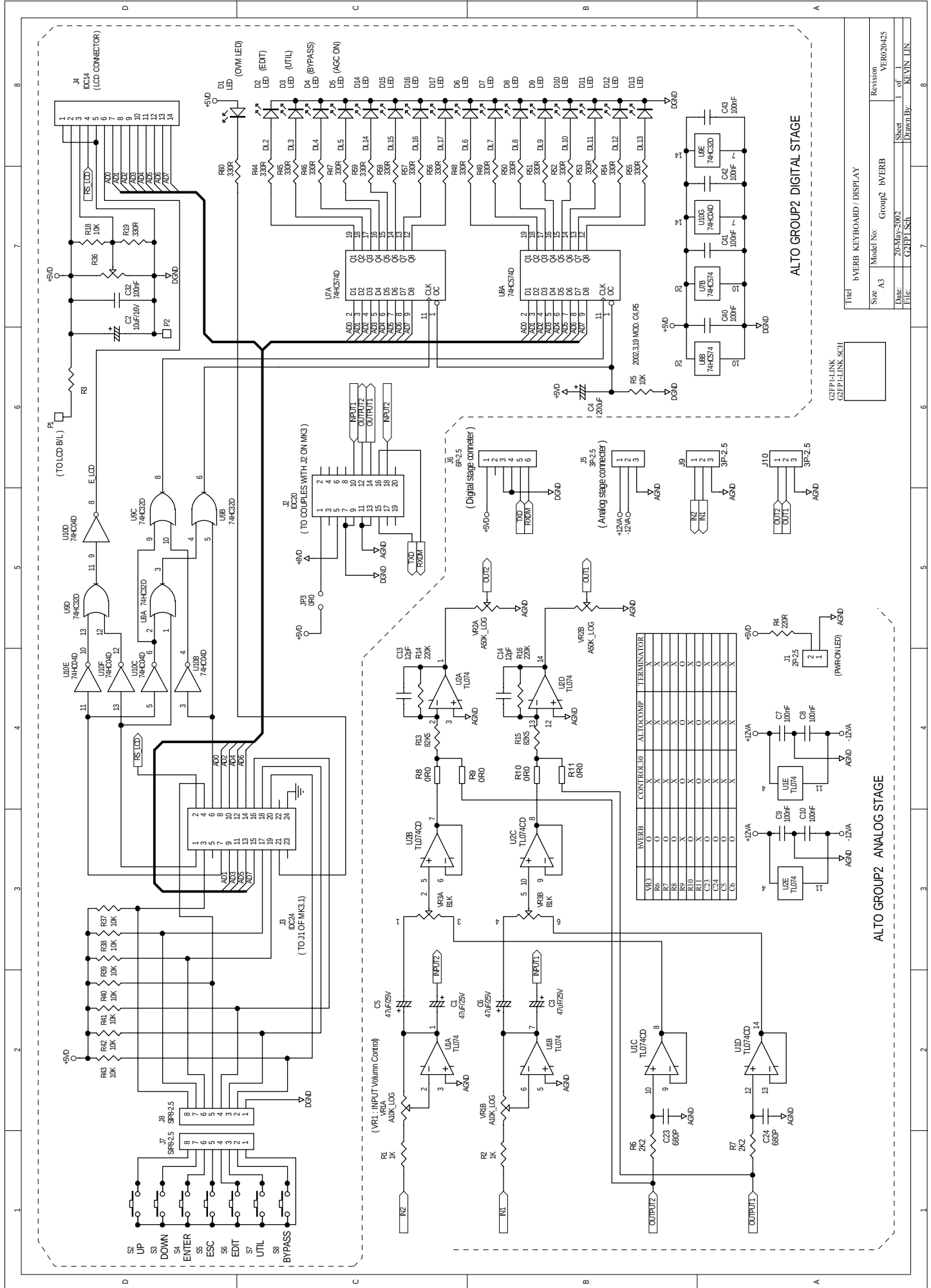

ALTO GROUP2 ANALOG STAGE

ALTO GROUP2 DIGITAL STAGE

Model No: Group2_I/VERB

Revision: VER020425

Date: 20-May-2002

File: G2PPLINK.SCH

Sheet: 1 of 1

Drawn By: KEVIN LIN

G2PPLINK
G2PPLINK.SCH

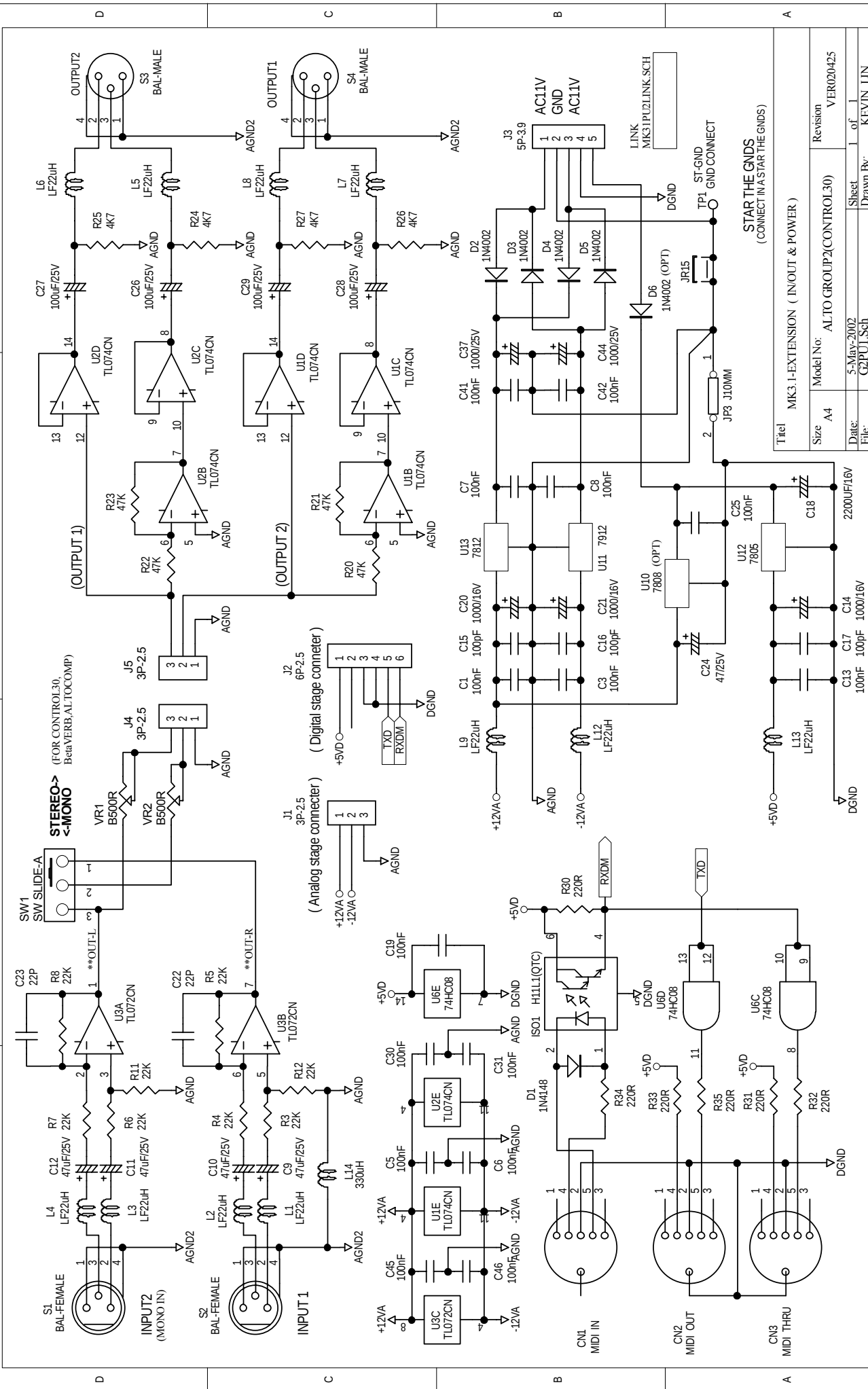

MK31 PCB LAYOUT

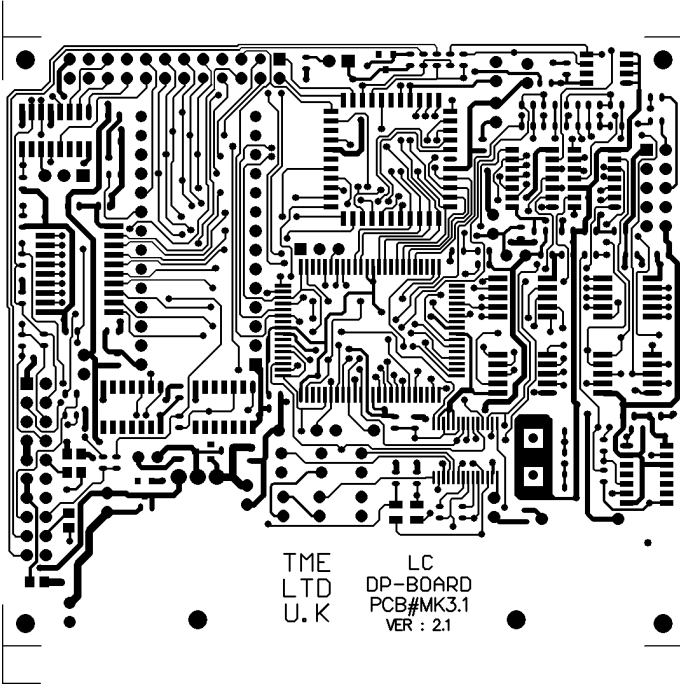

TOP LAYER

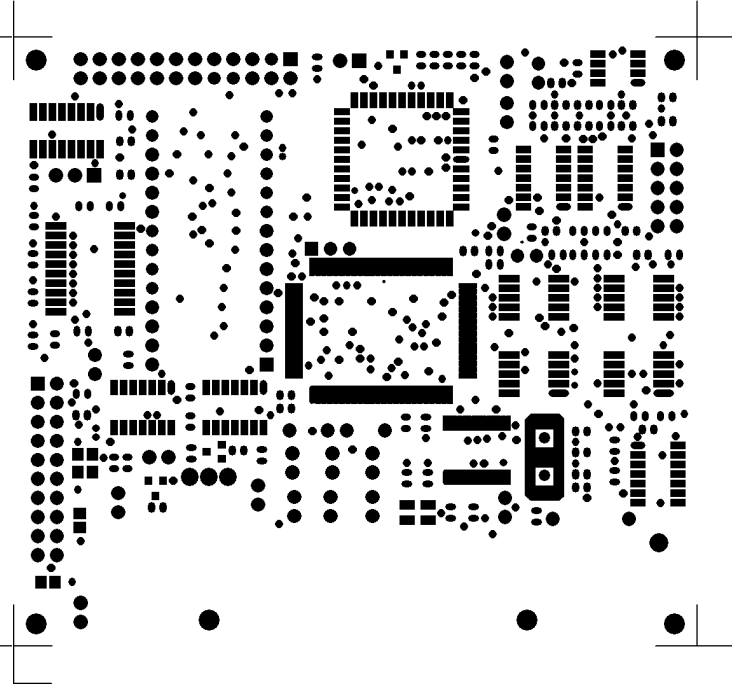

TOP SOLDER MASK

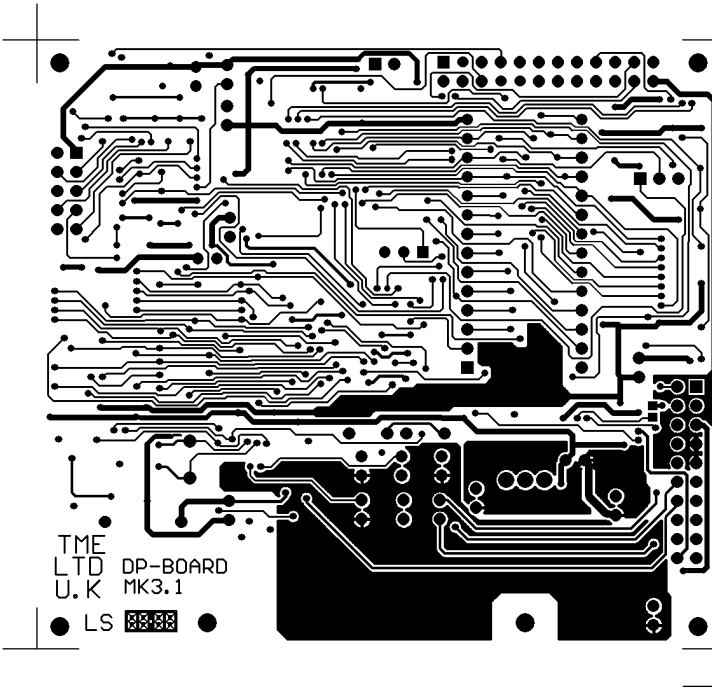

BOTTOM LAYER

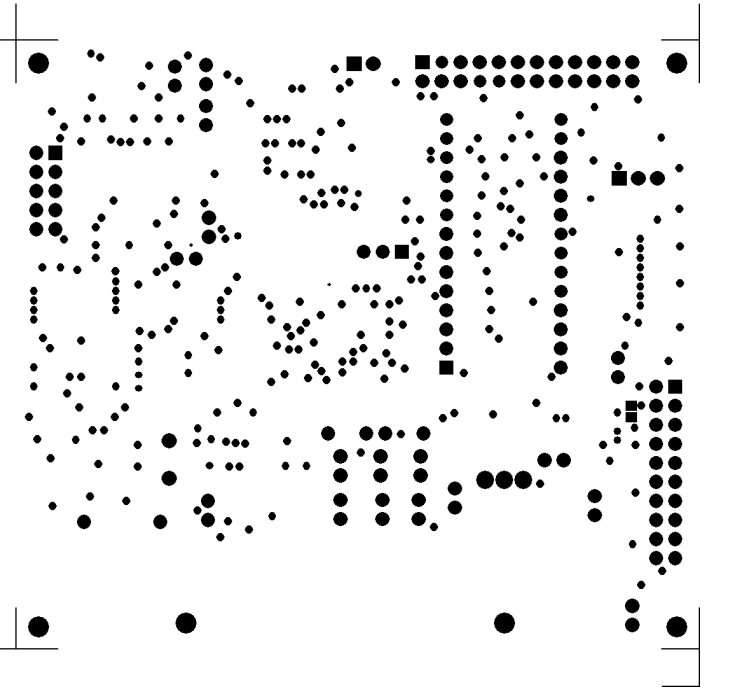

BOTTOM SOLDER MASK

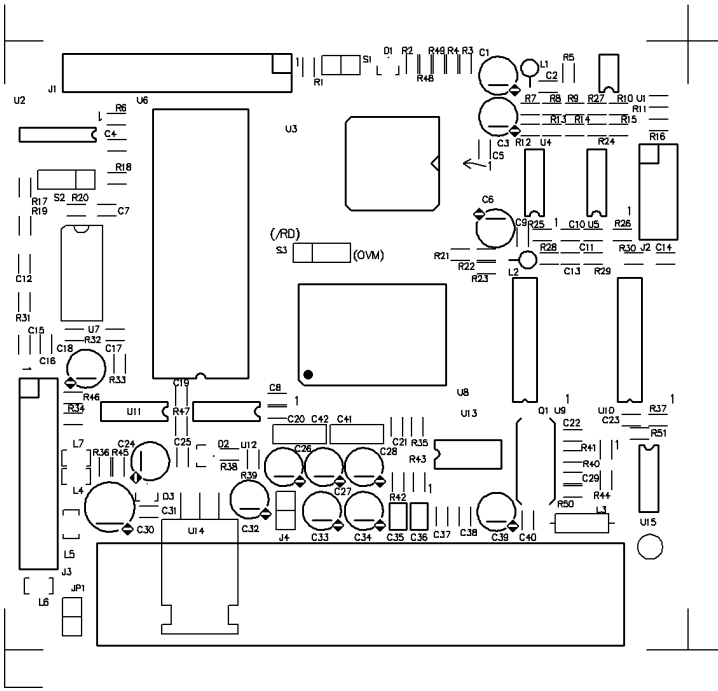

TOP SILKSCREEN

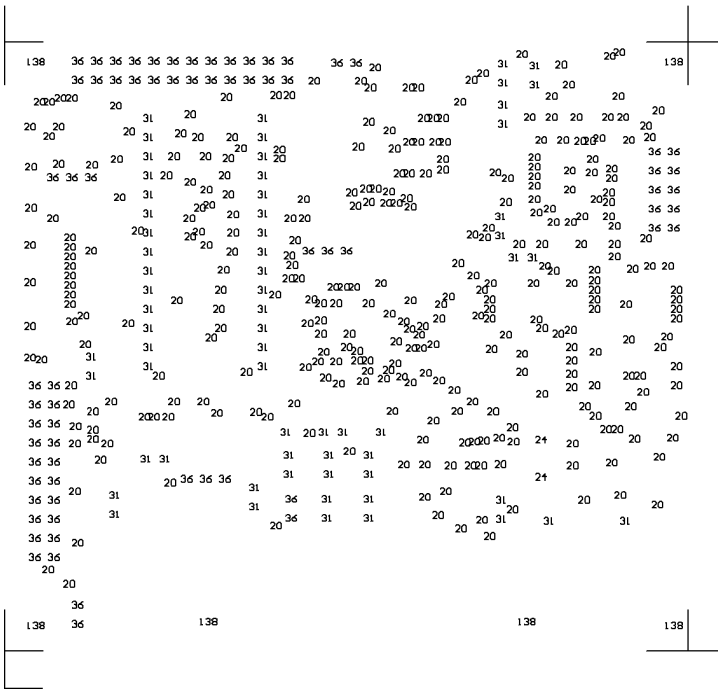

DRILL DRAWING

 NCDrill File Report For: MK31-EMI.PCB

Layer Pair : TopLayer to BottomLayer
 ASCII File : NCDrillOutput.TXT
 EIA File : NCDrillOutput.DRL

Tool	Hole Size	Hole Count Plated
T1	20mil (0.50mm)	328
T2	24mil (0.60mm)	2
T3	31mil (0.80mm)	64
T4	36mil (0.90mm)	69
T5	138mil (3.50mm)	6 NPTH
Totals		469

MK31 排片方式

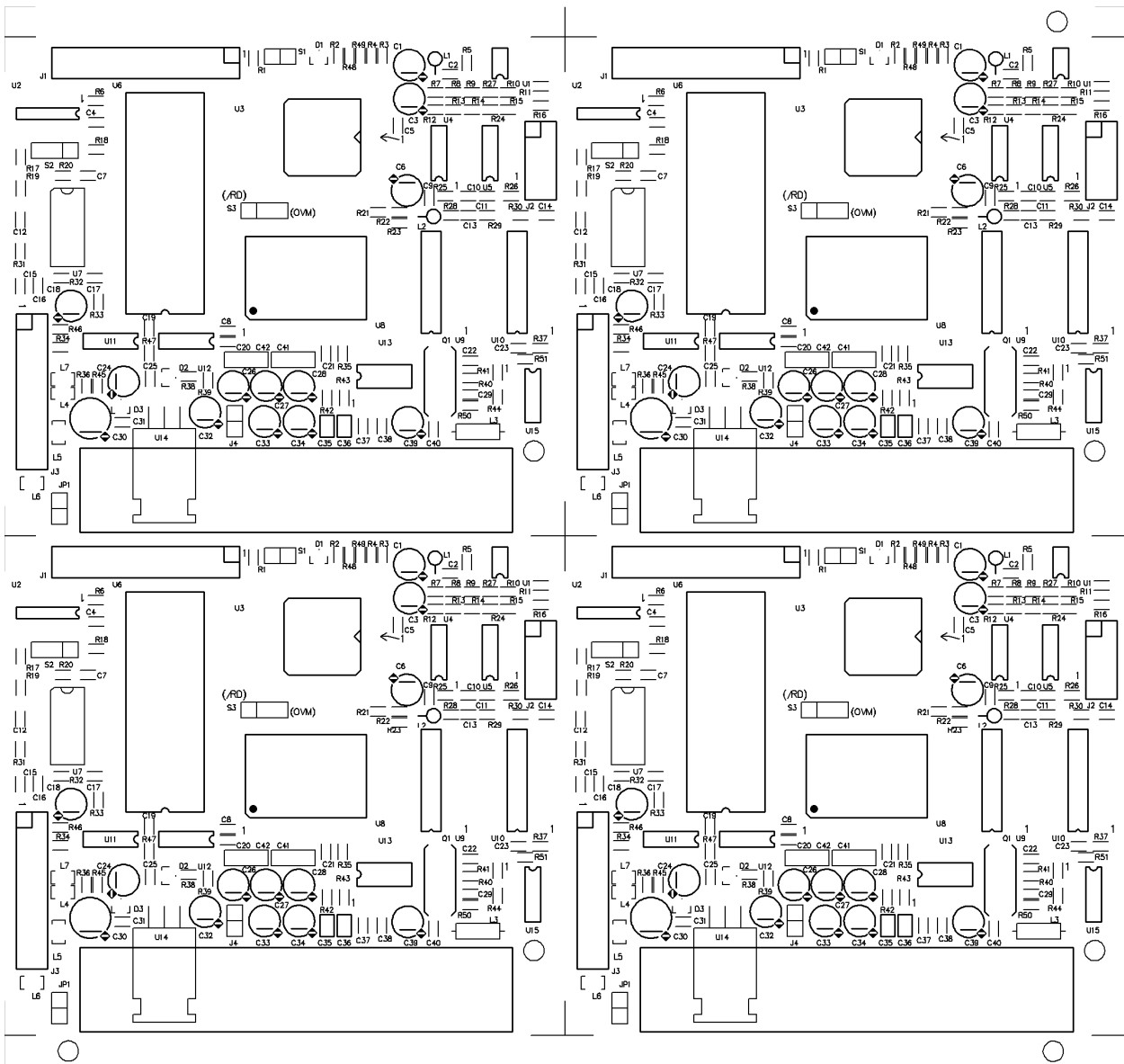

MK31-FDKB PCB LAYOUT

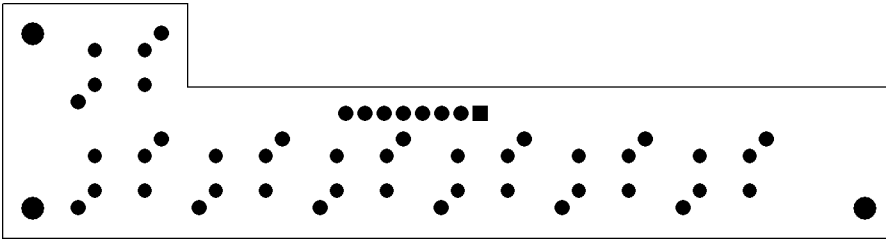

BOTTOM SOLDER MASK

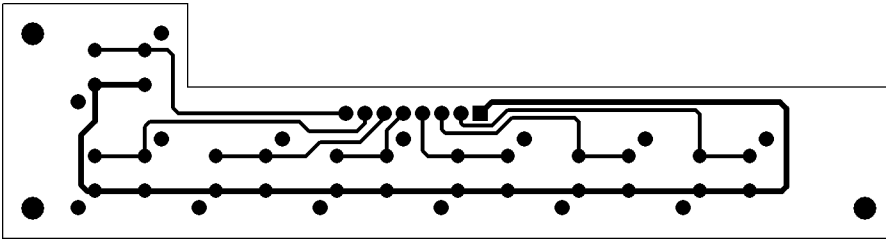

BOTTOM LAYER

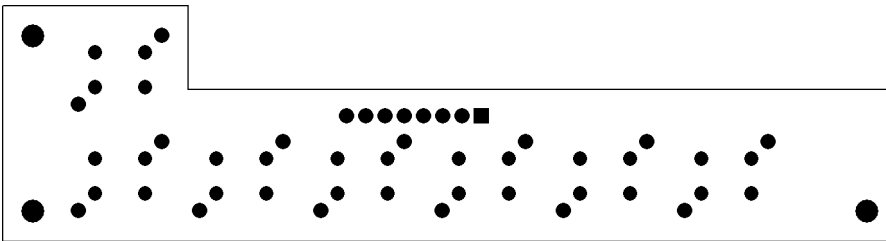

TOP LAYER & TOP SOLDER MASK

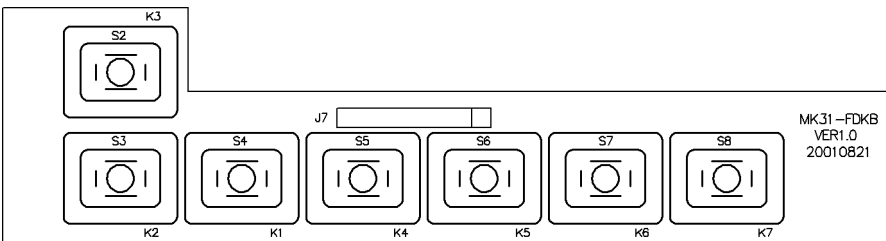

TOP SILKSCREEN

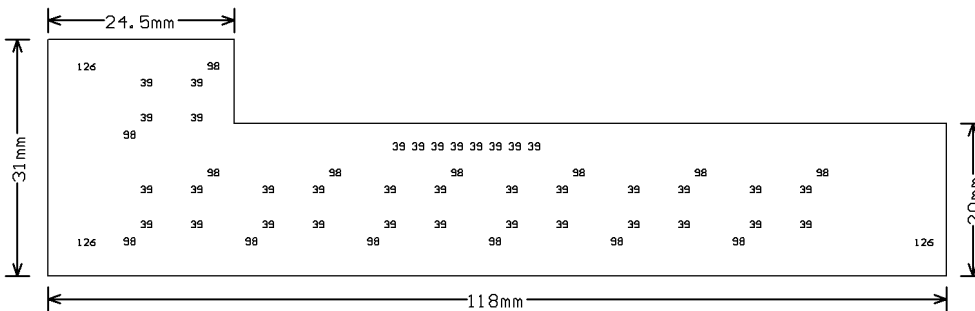

DRILL DRAWING

Tool	Hole Size	Hole Count	Plated
T1	39mil (1.00mm)	36	
T2	98mil (2.50mm)	14	NPTH
T3	126mil (3.20mm)	3	NPTH
Totals		53	

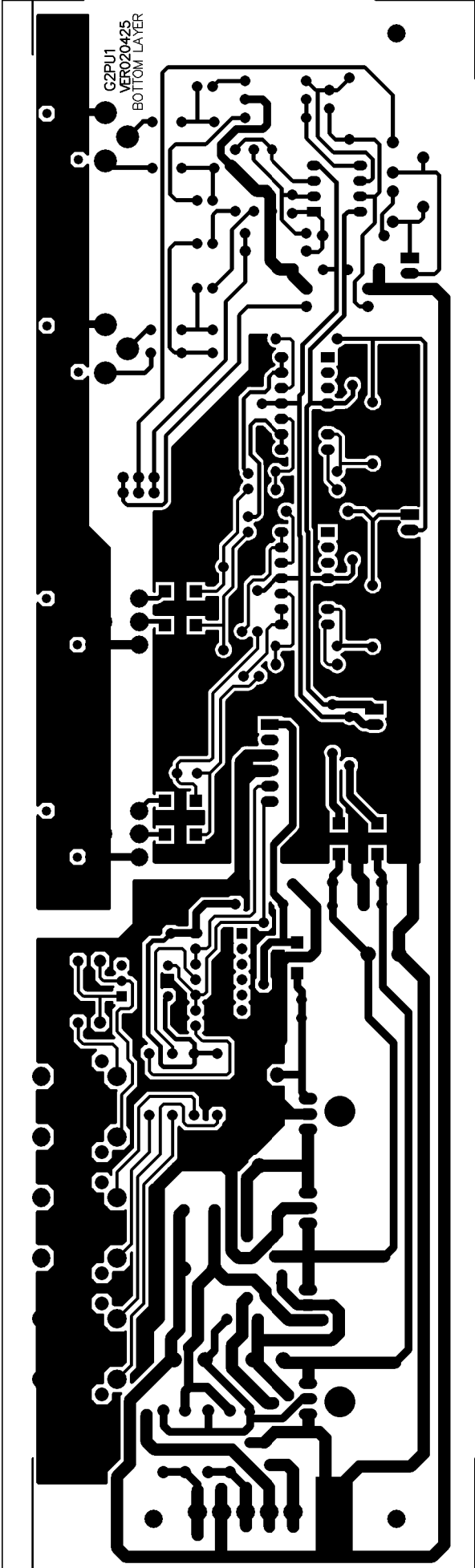

G2PU1 Solder Side

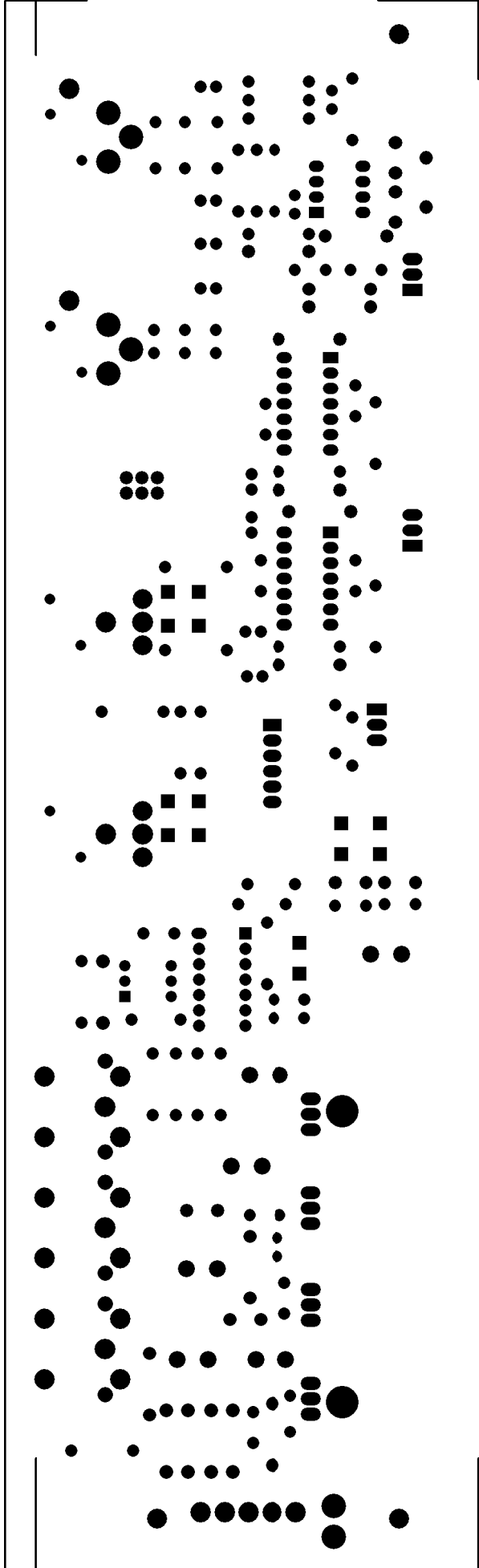

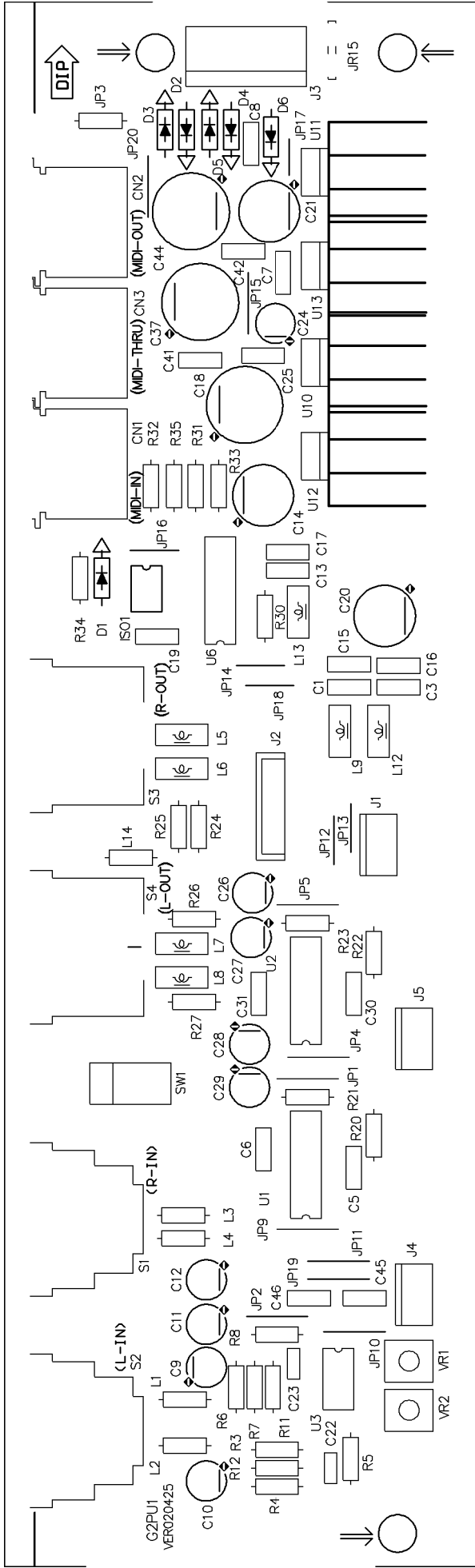

G2PU1 Top silkscreen

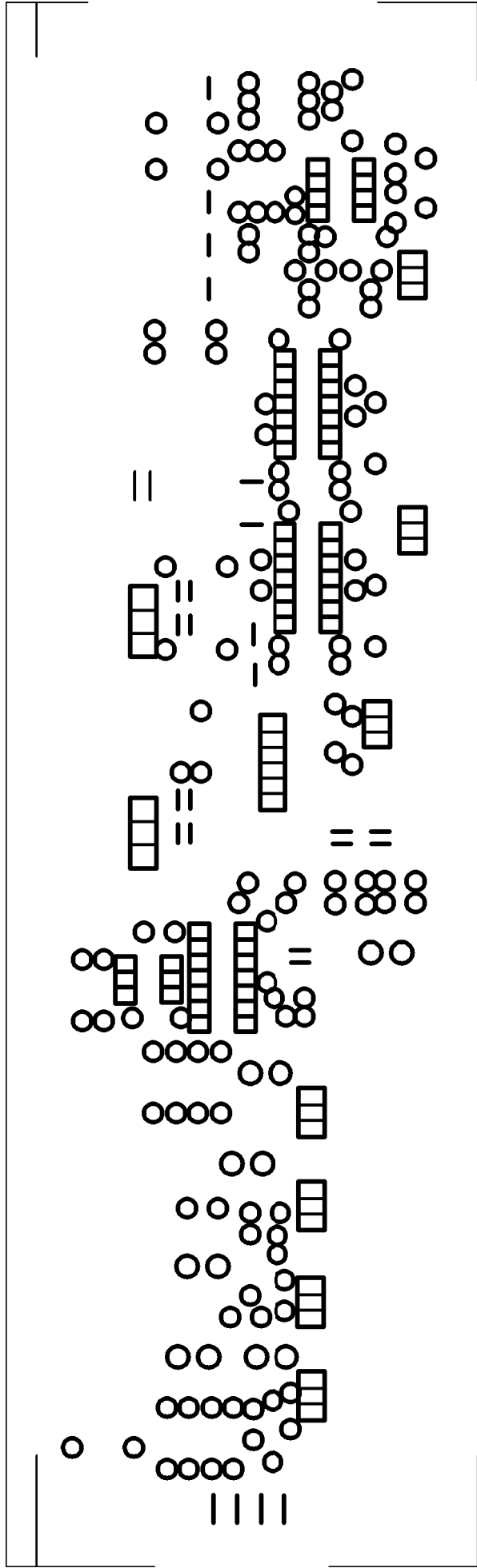

G2PU1 Bottom silkscreen

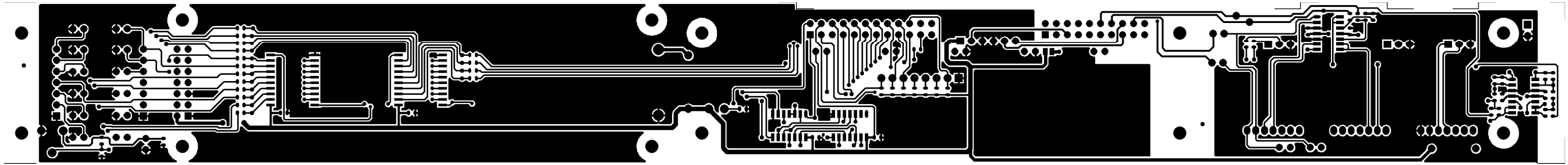

Top Layer

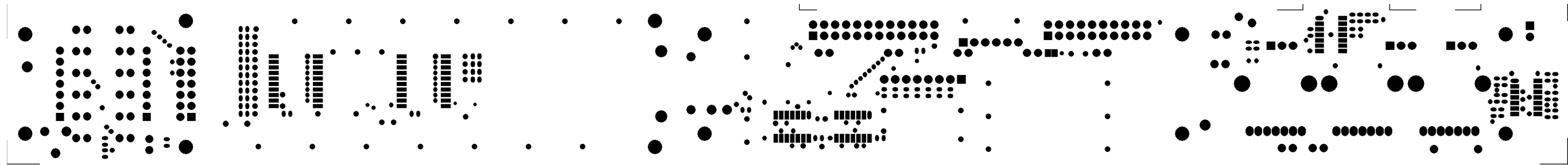

Top Solder Mask

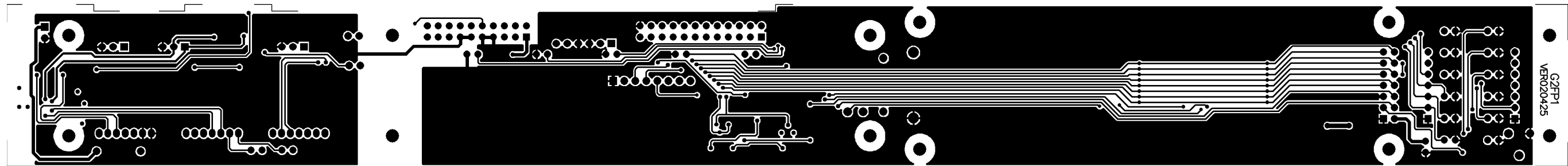

Bottom Layer

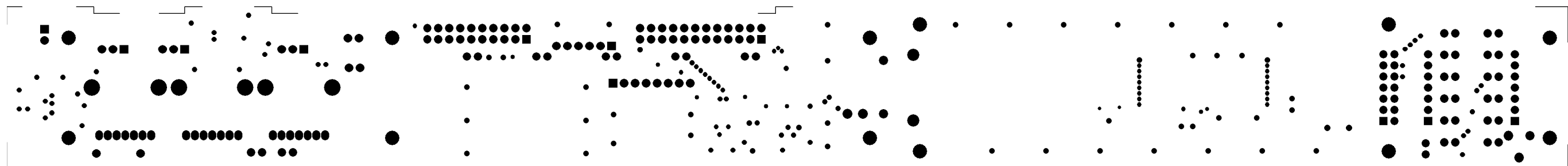

Bottom Solder

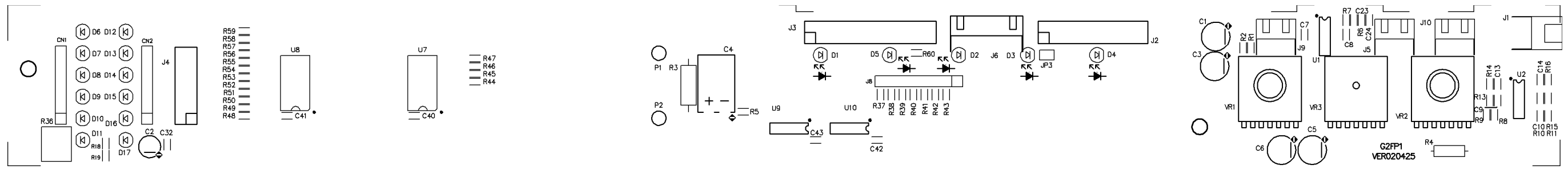

Top Overlay

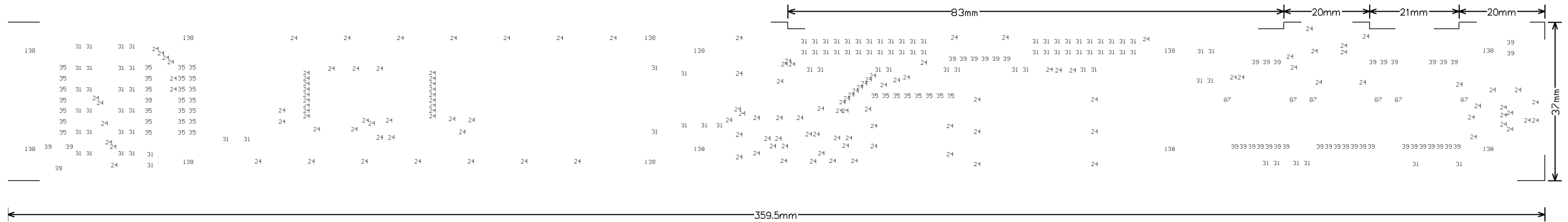

Drill Drawing

NCDrill File Report For: G2FP1.PCB 13-May-2002

Layer Pair : TopLayer to BottomLayer
 ASCII File : NCDrillOutput.TXT
 EIA File : NCDrillOutput.DRL

Tool	Hole Size	Hole Count Plated
T1	24mil (0.60mm)	145
T2	31mil (0.80mm)	98
T3	35mil (0.90mm)	35
T4	39mil (1.00mm)	42
T5	87mil (2.20mm)	6
T6	118mil (3.00mm)	3
T7	138mil (3.50mm)	12 NPTH
Totals		341

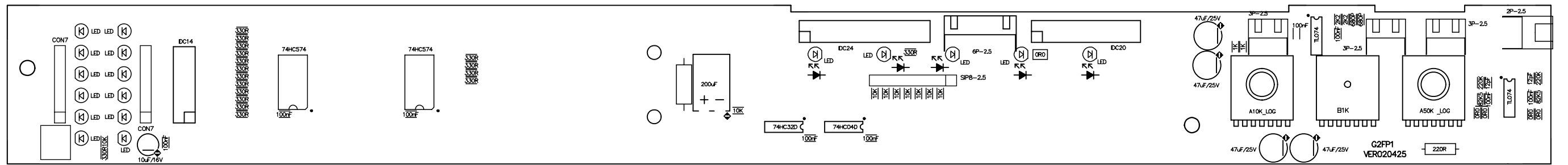

CONTROL30 WIRING DIAGRAM

(BETAVERB,ALTOCOMP,TERMINATOR共用)

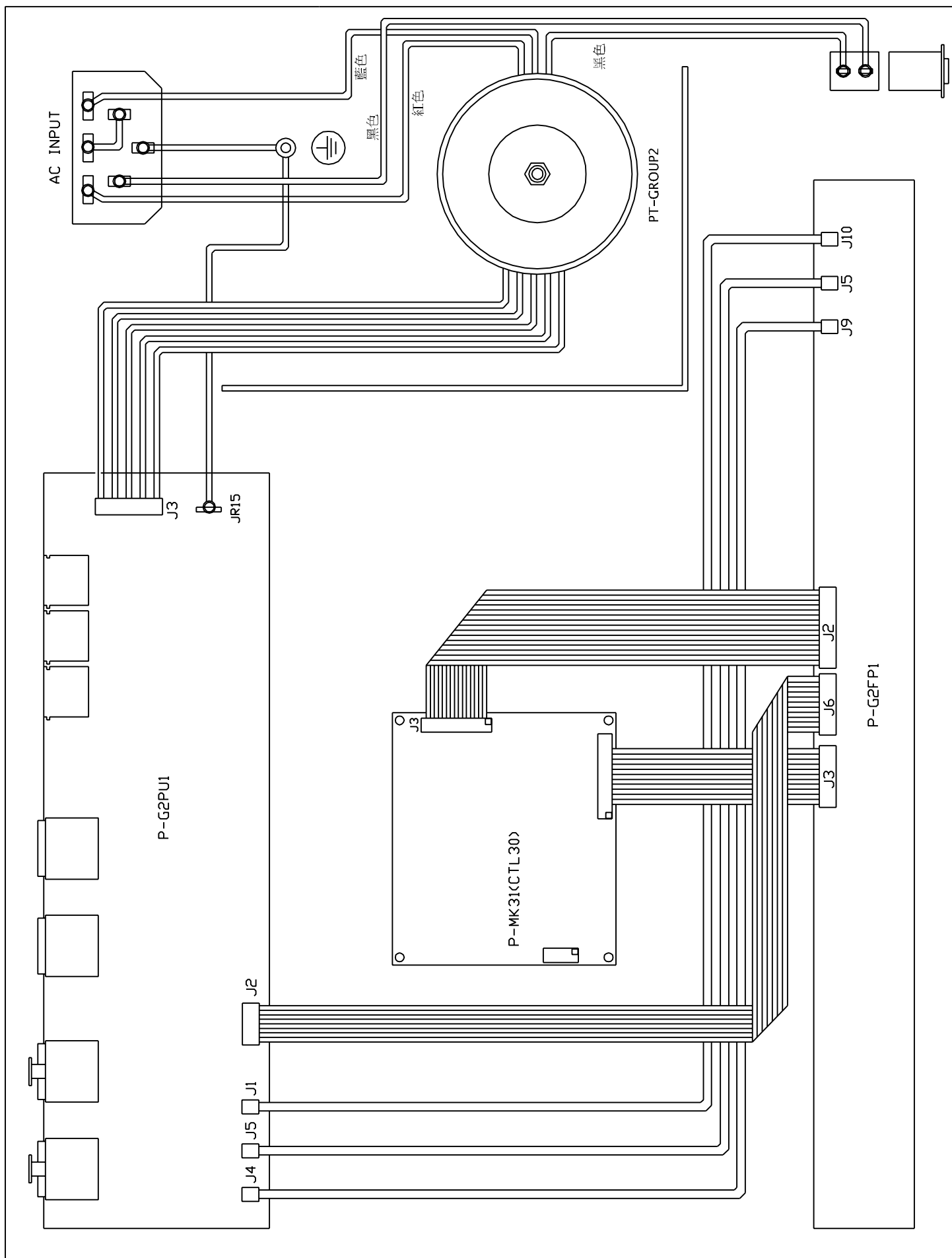

Test Procedures for CONTROL30, TERMINATOR, ALTOCOMP

Amplitude response test

On PC:

-Load file: **control30_amplitude** (APWin File menu / Open / Test)

Test Connections:

- Output A of Audio Precision System Two → input 1 of the device under test.
- Output B of Audio Precision System Two → input 2 of the device under test.
- Output 1 of the device under test → A input of Audio Precision System Two.
- Output 2 of the device under test → B input of Audio Precision System Two.

On the device under test

- Turn on the power switch.
- Set INPUT volume to maximum.
- Set OUTPUT volume to maximum.
- Push BYPASS switch (on the TERMINATOR push the UTIL key then navigate the menu up to SYSTEM BYPASS and hit the ENTER key)

Start the sweep (F9) and control the results (Page3-Graph)

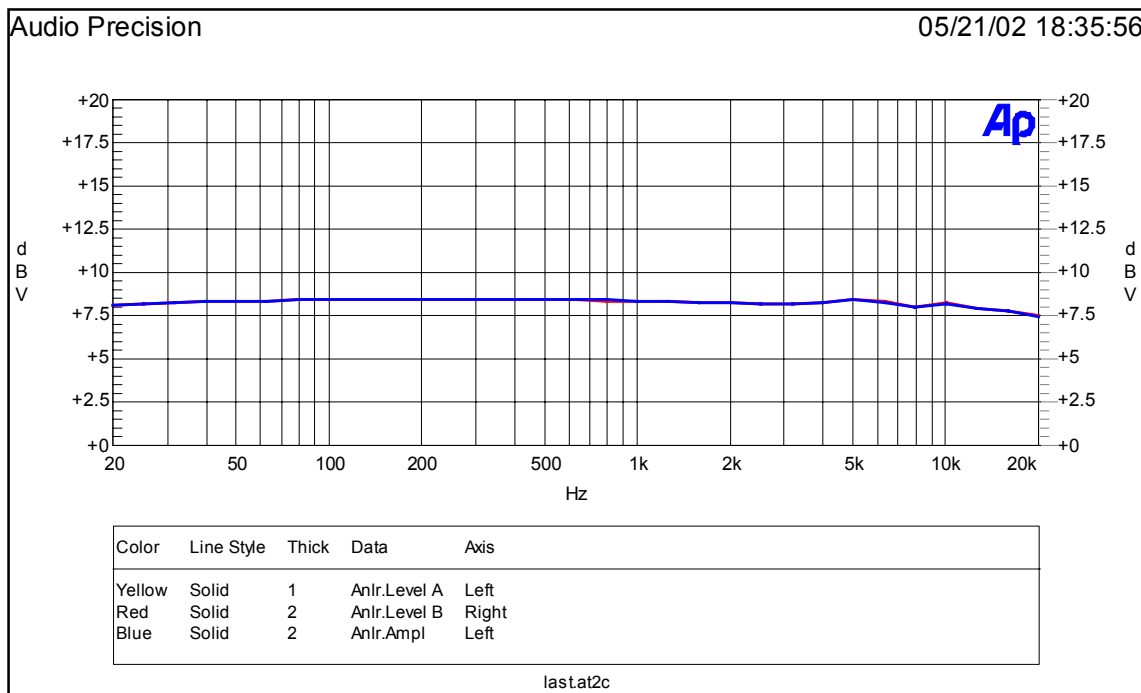

THD test

On PC:

-Load file: **control30_THD** (APWin File menu / Open / Test)

Test Connections:

- Output A of Audio Precision System Two → input 1 of the device under test.
- Output B of Audio Precision System Two → input 2 of the device under test.

On the device under test

- Turn on the power switch.
- Set INPUT volume to maximum.
- Set OUTPUT volume to maximum.
- Push BYPASS switch (on the **TERMINATOR** push the UTIL key then navigate the menu up to SYSTEM BYPASS and hit the ENTER key)

Start the sweep (F9) and control the results (Page3-Graph) in the following conditions:

- Output 1 of the device under test → A input of Audio Precision System Two.
- Output 2 of the device under test → B input of Audio Precision System Two.

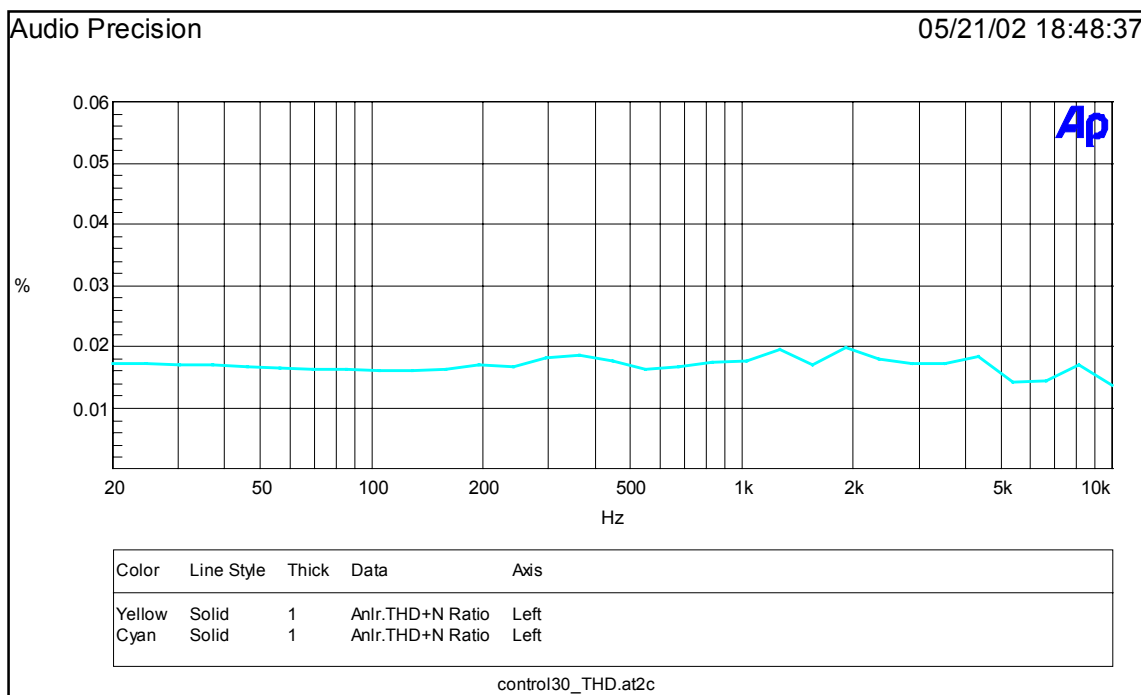

S/N test

On PC:

-Load file: **control30_SN** (APWin File menu / Open / Test)

Test Connections:

- Output A of Audio Precision System Two → input 1 of the device under test.
- Output B of Audio Precision System Two → input 2 of the device under test.

On the device under test

- Turn on the power switch.
- Set OUTPUT volume to maximum.
- Push BYPASS switch (on the **TERMINATOR** push the UTIL key then navigate the menu up to SYSTEM BYPASS and hit the ENTER key)
- increase the INPUT level until the device's outputs clip, and after reduce the INPUT level itself until the outputs exit from clipping state.

Start the sweep (F9) and control the results (Page3-Graph) in the following conditions:

- Output 1 of the device under test → A input of Audio Precision System Two.
- Output 2 of the device under test → B input of Audio Precision System Two.

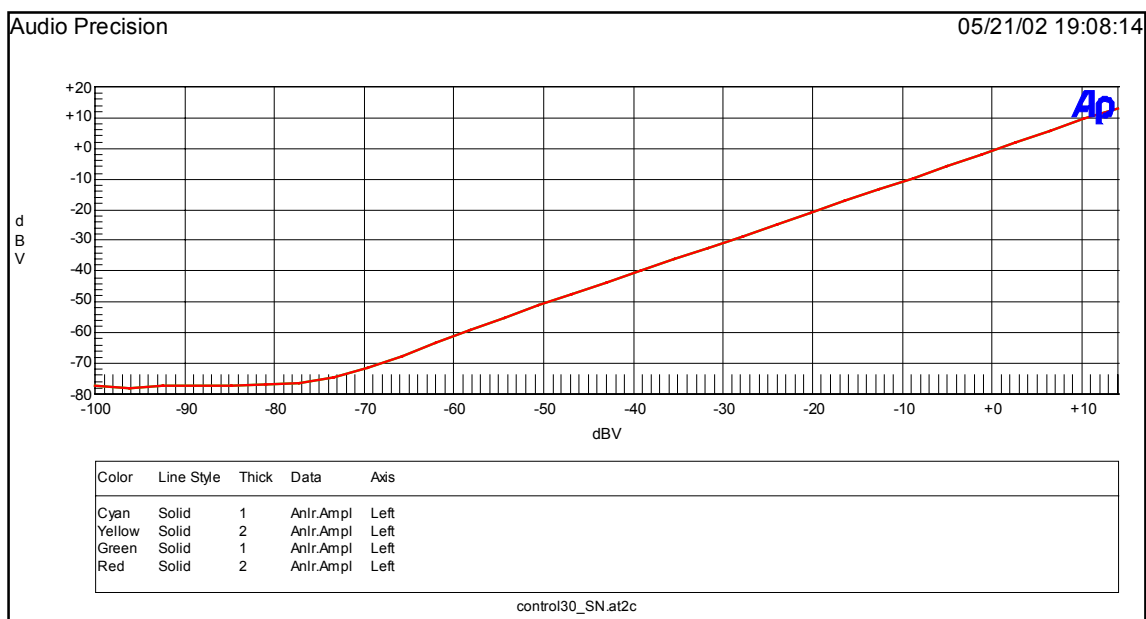

Dynamics test

On PC:

-Load file: **control30_dyn** (APWin File menu / Open / Test)

Test Connections:

- Output A of Audio Precision System Two → input 1 of the device under test.
- Output B of Audio Precision System Two → input 2 of the device under test.

On the device under test

- Turn on the power switch.
- Set INPUT volume to maximum.
- Set OUTPUT volume to maximum.
- Push BYPASS switch (on the **TERMINATOR** push the UTIL key then navigate the menu up to SYSTEM BYPASS and hit the ENTER key)

Start the sweep (F9) and control the results (Page3-Graph) in the following conditions:

- Output 1 of the device under test → A input of Audio Precision System Two.
- Output 2 of the device under test → B input of Audio Precision System Two.

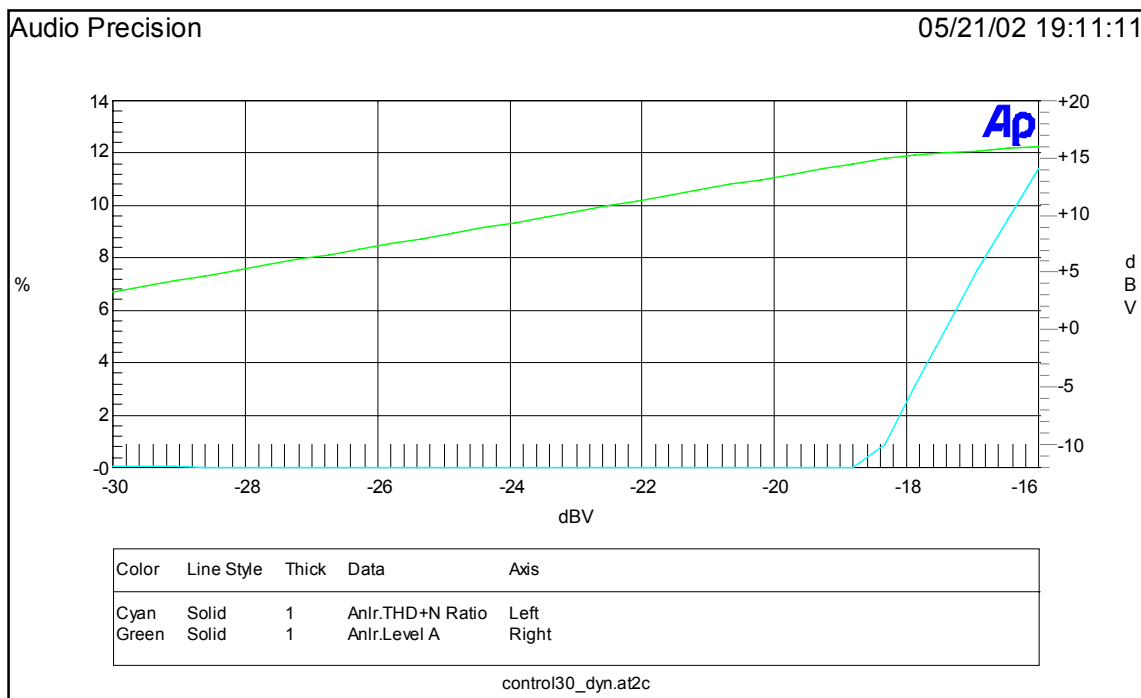

Stability test

On PC:

-Load file: **control30_stability** (APWin File menu / Open / Test)

Test Connections:

- Output A of Audio Precision System Two** → **input 1 of the device under test.**
- Output B of Audio Precision System Two** → **input 2 of the device under test.**
- Output 1 of the device under test** → **A input of Audio Precision System Two.**
- Output 2 of the device under test** → **B input of Audio Precision System Two.**

On the device under test

- Turn on the power switch.
- Turn MIX control counterclockwise (DRY).
- Set OUTPUT volume to maximum.
- Set INPUT volume to zero.
- Push BYPASS switch (on the **TERMINATOR** push the UTIL key then navigate the menu up to SYSTEM BYPASS and hit the ENTER key)
- Load **ROOM 1** Preset (Preset #001)

Test:

Move the input level knob from 0 to maximum 3 times and control the output waveforms: NO PERMANENT SINE WAVEFORMS should be visible. IF PERMANENT WAVEFORMS WITH FREQUENCY > 20kHz should become visible on whatever output channel, THE UNIT IS TO BE INSPECTED.

CONTROL30-ALTO-歐洲-230V**Structure Needing Material Detail List**

建檔日: 2002/01/30 修正日: 2002/05/21

<u>NO.</u>	<u>Midprod NO</u>	<u>Quantity</u>	<u>Unit</u>
1	A-CONTROL30-ALTO-歐規-230V	1.000	PCS
2	A-CONTROL30 底后板組合	1.000	PCS
3	A-CONTROL30 前板組合	1.000	PCS
4	P-MK3.1-SMD (CTL30)	1.000	PCS
5	P-MK3.1-DIP (CTL30)	1.000	PCS
6	P-G2PU1 (CONTROL30)	1.000	PCS
7	P-G2FP1-SMD (CONTROL30)	1.000	PCS
8	P-G2FP1-DIP (CONTROL30)	1.000	PCS
9	P-MK31-FDKB-DIP	1.000	PCS
10	P-MK31-LED-SMD	1.000	PCS
11	P-G2FP1-半成品組合	1.000	PCS

Item No: CONTROL30

specify: AMP

Mid No: A-CONTROL30-ALTO-歐規-230V standard quantity: 1.000

NO	Material No	Item Name	Specific	Quantity	Unit	Ps
	1 MFR397ZZ	panel(white)	CONTROL30 ALTO	1.000	PCS	
MARK:						
	2 MB02195	rear board	bVERB	1.000	PCS	
MARK:						
	3 MTP312ZZ	top cover black	CONTROL30	1.000	PCS	
MARK:						
	4 NMCA46ZZ	lacid plastic panel	CONTROL30 ALTO(142*30mm)	1.000	PCS	
MARK:						
	5 NMBP64	plastic knob double ϕ 1	COOL GRAY 8C	2.000	PCS	
MARK:						
	6 NPL272	cover	ϕ 8.5*4 blue 072C	2.000	PCS	
MARK:						
	7 NMBA01	power push button	ϕ 15*12	1.000	PCS	
MARK:						
	8 NPL286	switch cap	ϕ 14.5*10 YELLOW C	1.000	PCS	
MARK:						
	9 NMB022	button	15*12*21 CONTROL 072Cb1u	7.000	PCS	
MARK:						
	10 DL43RG	L.E.D	LG2043 green	1.000	PCS	
MARK:						
	11 HSWA13	alimentation SW	SDDLB 1007U	1.000	PCS	
MARK:						
	12 HCSA16	AC outlett	(S)315-B (AC select)	1.000	PCS	
MARK:						
	13 HDFM000250	fuse	250mA ϕ 5*20mm VDE	1.000	PCS	
MARK:						
	14 MWI067	copper pole M3*P0.5	8mm single,length14mm	3.000	PCS	
MARK:						
	15 MSCB13	black-plated screw	cross-head pan head 3*6	13.000	PCS	上蓋7,底板3,前
MARK:						
	16 MSCB38	black plated screw	3*7	4.000	PCS	面板側
MARK:						
	17 MSCB58	black plated screw	iron-board pill 3*10	8.000	PCS	平衡座用
MARK:						
	18 MSCB34	black plated screw	pill 3*6	17.000	PCS	MK31,MK31-PU,
MARK:						
	19 MSCC40	colour screw	pill 4*30	1.000	PCS	環形PT
MARK:						
	20 MSCB35	black plated screw	cross-head pan head 3*10	2.000	PCS	AC座用
MARK:						
	21 MSTC04	colour nut	4m/m	2.000	PCS	PT,地線
MARK:						
	22 MFSC02	washer	ϕ 4* ϕ 12*1t	1.000	PCS	PT
MARK:						
	23 MFSS04	washer	ϕ 4* ϕ 7*1t	2.000	PCS	地線,PT
MARK:						
	24 MFST01	washer	ϕ 4* ϕ 8*0.5t	2.000	PCS	地線
MARK:						
	25 NFSW05ZZ	wood washer	3.17*8.2 black	4.000	PCS	
MARK:						
	26 HLSF126	row-wire connector wirin2P	100m/m	1.000	PCS	
MARK:						

Item No: CONTROL30

specify: AMP

Mid No: A-CONTROL30-ALTO-歐規-230V standard quantity: 1.000

NO	Material No	Item Name	Specific	Quantity	Unit	Ps
27	HLSC56	single terminal wiring	C green/yellow 100m/m	1.000	PCS	
MARK:						
28	HLSC163	single terminal wiring	C green/yellow 170m/m	1.000	PCS	
MARK:						
29	HLSF348	row-wire connector	wire in 6P-6P 320mm	1.000	PCS	
MARK:						
30	HA02128	wire	3P-3P 450mm	1.000	PCS	
MARK:						
31	HLSP164	P.V.C wiring	UL1617 AWG22 250mm black	1.000	PCS	
MARK:						
32	HLSP71	P.V.C single wave wired	UL1617 22AWG 80m/m brown	1.000	PCS	
MARK:						
33	HLSA31	power cord	Europe 3P LT-312+LT-501	1.000	PCS	
MARK:						
34	NLXC07	rubber coil	φ 20* φ 60*2tB	1.000	PCS	
MARK:						
35	NMCT16WW0010	sleeving flame retardant	2.5 φ *10m/m	2.000	PCS	
MARK:						
36	NMCT19WW0020	sleeving flame retardant	4 φ *20m/m	8.000	PCS	
MARK:						
37	NMCR01	cable tie(black)	ALT-102SB	3.000	PCS	
MARK:						
38	NPLN92	tie belt fixed bracket	CM-19S	1.000	PCS	
MARK:						
39	NLXM39	self-paste foot pad	(SF-0 12.7*9.0*3.0t	4.000	PCS	
MARK:						
40	NWCP04	lockable bag	5*7	1.000	PCS	
MARK:						
41	NWCP01WW0300*0580	PE bag	30*58cm	1.000	PCS	
MARK:						
42	HEM083	desiccant	30g	1.000		
MARK:						
43	NMLZ779	label	SCL-2020 black/white	1.000		
MARK:						
44	NMCQ-073	assurance book	ALTO	1.000		
MARK:						
45	NMLB1387-05ZZ	label	CONTROL30 ALTO	2.000		貼內箱用
MARK:						
46	PIA1055	paper inner box	ALTO 19"	1.000	PCS	
MARK:						
47	PKMS153	sponge barrier	ALTO 19"	1.000	PCS	
MARK:						
48	PKMS156	barrier	ALTO19"	1.000	PCS	
MARK:						
49	NMCQA-331	instruction	CONTROL30 ALTO	1.000		
MARK:						
50	POA182	paper outer case 4 hole	ALTO 19"	0.250	PCS	
MARK:						
51	TD00103	loop transformer	PT-GROUP2	1.000	PCS	
MARK:						
52	NMLM374ZZ	label	CONTROL30	4.000		
MARK:						

Item No: CONTROL30

specify: AMP

Mid No: standard quantity:

<i>NO</i>	<i>Material No</i>	<i>Item Name</i>	<i>Specific</i>	<i>Quantity</i>	<i>Unit</i>	<i>Ps</i>
53	NE05004	label	ALTO	4.000		
MARK:						
54	NMLH31	label	MADE IN P.R.C.	2.000		
MARK:						
55	NA00154	box	ALTO	2.000	PCS	
MARK:						
56	HA02129	wire	3P-3P 450mm	2.000	PCS	
MARK:						
57	NMBA07	power push button		1.000	PCS	
MARK:						

Item No: CONTROL30

specify: AMP

Mid No: standard quantity:

<i>NO</i>	<i>Material No</i>	<i>Item Name</i>	<i>Specific</i>	<i>Quantity Unit</i>	<i>Ps</i>
1	MBT325ZZ	bottom pate	CONTROL30	1.000 PCS	
MARK:					
2	MMC014	iron pillar	hexagon 6.35*M3*9.2	3.000 PCS	
MARK:					
3	MMC013	iron pillar	hexagon 6.35*M3*6	4.000 PCS	
MARK:					
4	MSC023	screw pillar	M4*10*0.7PH	1.000 PCS	
MARK:					
5	MSDE36ZZ	barrier board(black)	CONTROL30	1.000 PCS	
MARK:					
6	MAPR80ZZ	L-shape fixed bracket	1.2*28*20*10(CLE2.0)	1.000 PCS	
MARK:					

Item No: CONTROL30

specify: AMP

Mid No: standard quantity:

<i>NO</i>	<i>Material No</i>	<i>Item Name</i>	<i>Specific</i>	<i>Quantity Unit</i>	<i>Ps</i>
1	MSDF39ZZ	front board	CONTROL30	1.000 PCS	
MARK:					
2	MMC013	iron pillar	hexagon 6.35*M3*6	8.000 PCS	
MARK:					

Item No: CONTROL30

specify: AMP

Mid No: standard quantity:

NO	Material No	Item Name	Specific	Quantity	Unit	Ps
1	NPC385	PCB	MK3.1(1*4)	1.000	PCS	
MARK:						
2	RFCF000	SMD 1/10W fixed resistor	0Ω ±5% 0603	5.000	PCS	
MARK:	R 22 41 44 45 46					
3	RFCF010	SMD 1/10W fixed resistor	10Ω ±5% 0603	11.000	PCS	
MARK:	R 1 20 25 26 28 30 33 35 37 5 6					
4	RFCF110	SMD 1/10W fixed resistor	100Ω ±5% 0603	2.000	PCS	
MARK:	R 3 4					
5	RFCF133	SMD 1/10W fixed resistor	330Ω ±5% 0603	1.000	PCS	
MARK:	R 38					
6	RFCF147	SMD 1/10W fixed resistor	470Ω ±5% 0603	1.000	PCS	
MARK:	R 51					
7	RFCF210	SMD 1/10W fixed resistor	1.0KΩ ±5% 0603	1.000	PCS	
MARK:	R 39					
8	RFCF215	SMD 1/10W fixed resistor	1.5KΩ ±5% 0603	1.000	PCS	
MARK:	R 2					
9	RFCF247	SMD 1/10W fixed resistor	4.7KΩ ±5% 0603	1.000	PCS	
MARK:	R 50					
10	RFCF410	SMD 1/10W fixed resistor	100KΩ ±5% 0603	2.000	PCS	
MARK:	R 42 43					
11	CCE022B	SMD0603 ceramic capacitor	22PF NPO ±5% -50	2.000	PCS	
MARK:	C 22 29					
12	CCE110B	SMD0603 ceramic capacitor	100PF NPO ±5% -50	2.000	PCS	
MARK:	C 19 20					
13	CCE147B	SMD0603 ceramic capacitor	470PF NPO ±5% -50	2.000	PCS	
MARK:	C 37 38					
14	CCE410F	SMD0603 ceramic capacitor	0.1uF Y5V+80 -20%50V	16.000	PCS	
MARK:	C 10 11 13 14 17 2 21 23 25 31 4 40 5 7 8 9					
15	CCC510F	SMD0805 ceramic capacitor	1uF/16V Y5V-0805(201	2.000	PCS	
MARK:	C 35 36					
16	DRS0004	SMD rectifier diode	BAS16(SOT-23)	3.000	PCS	
MARK:	D 1 2 3					
17	SICS305	SMD integratd circuit	PCM3001E	1.000	PCS	
MARK:	U 13					
18	HBE004	SMD integrated circuit	SEED TMS57002DPHA	1.000	PCS	
MARK:	U 8					
19	HBE005	SMD integrated circuit	SEED MB81C4256A-60	2.000	PCS	
MARK:	U 10 9					
20	SICS207	SMD integratd circuit	24LC64I/SN	1.000	PCS	
MARK:	U 1					
21	SICS716	SMD integrated circuit	M74HC148M1R	1.000	PCS	
MARK:	U 2					
22	SICS717	SMD integrated circuit	SN74HC574DW	1.000	PCS	
MARK:	U 7					
23	SICS723	SMD integrated circuit	74F14DT	1.000	PCS	
MARK:	U 4					
24	SICS713	SMD integrated circuit	74HC32DT	1.000	PCS	
MARK:	U 5					

Item No: CONTROL30

specify: AMP

Mid No: standard quantity:

<i>NO</i>	<i>Material No</i>	<i>Item Name</i>	<i>Specific</i>	<i>Quantity</i>	<i>Unit</i>	<i>Ps</i>
25	SICS708	SMD integratd circuit	74HC393DT	1.000	PCS	
MARK:	U 15					
26	HCSS79	IC socket (SMD)	PLCC44 (D03-44T.A.4)	1.000	PCS	
MARK:						
27	RFCE000	SMD 1/10W fixed resistor	0 Ω \pm 5% 0805	4.000	PCS	
MARK:	L 4 5 6 7					

Item No: CONTROL30

specify: AMP

Mid No: standard quantity:

NO	Material No	Item Name	Specific	Quantity	Unit	Ps
	1 CC082B-1	ceramic capacitor	82PF NPO	2.000	PCS	
MARK:	C 41 42					
	2 CE510S	electrolytic capacitor	1/50V ψ 4*7	5.000	PCS	
MARK:	C 18 24 3 39 6					
	3 CE610N	electrolytic capacitor	10/16V ψ 4*7	5.000	PCS	
MARK:	C 26 27 28 33 34					
	4 CE647D-2	electrotytic capacitor	47/16V (5 ψ *7mm)	2.000	PCS	
MARK:	C 1 32					
	5 SIC213VV	integrated circuit (epro 27C512-70		1.000	PCS	需燒錄程式
MARK:	U 6					
	6 SQR12.000	quartz crystalloid 11.05 HC-49/US \pm 20PPM		1.000	PCS	
MARK:	Q 1					
	7 MC0049	indutor	330uH (LGA0308-331K)	3.000	PCS	
MARK:	L 1 2 3					
	8 HCSP05002	row-pin(double)#2200	2.54 180° 2*12P (gold-pl	1.000	PCS	
MARK:	J 3					
	9 HCSP05001	row-pin(double)#2200	2.54 180° 2*10P (gold-pl	1.000	PCS	
MARK:	J 2					
	10 HCSP01002	row-pin(single)#1100	2.54 180° 2P (gold-plate	1.000	PCS	
MARK:	J 4					
	11 MMCJ17	jumper wire	2.5m/m	2.000	PCS	
MARK:	S 2 3					
	12 HCSS56	IC socket	3301-28P 2.54mm	1.000	PCS	
MARK:						
	13 NMLH1035ZZ	label	CONTROL30-EP	1.000		標志內容依程
MARK:						
	14 NMLH1036ZZ	label	CONTROL30-MI	1.000		標志內容依程
MARK:						
	15 SICS802	SMD integratd circuit	P87C52SBAA (UBAA)	1.000	PCS	需燒錄程式
MARK:						

Item No: CONTROL30

specify: AMP

Mid No: standard quantity:

NO	Material No	Item Name	Specific	Quantity	Unit	Ps
	1 HB00700	PCB	G2PU1_VER020425	1.000	PCS	
MARK:						
	2 RFB122S	1/4W fixed resistor	220Ω S type	6.000	PCS	
MARK:	R 30 31 32 33 34 35					
	3 RFB247S	1/4W fixed resistor	4.7KΩ S type	4.000	PCS	
MARK:	R 24 25 26 27					
	4 RFB322S	1/4W fixed resistor	22KΩ S type	8.000	PCS	
MARK:	R 11 12 3 4 5 6 7 8					
	5 RFB347S	1/4W fixed resistor	47KΩ S type	4.000	PCS	
MARK:	R 20 21 22 23					
	6 RCB302	carbon trimmer resistor	6FE horizontal EVND8A 50	2.000	PCS	
MARK:	VR 1 2					
	7 CC022B	ceramic capacitor	22PF NPO	2.000	PCS	
MARK:	C 22 23					
	8 CC110C-1	ceramic capacitor	100PF SL	3.000	PCS	
MARK:	C 15 16 17					
	9 CU410A-1	heap-layer capacitor (st)	0.1uF 50V Y5V PH5mm	15.000	PCS	
MARK:	C 1 13 16 19 25 3 30 31 41 42 45 5 6 7 8					
	10 CE647E	electrotytic capacitor	47/25V	5.000	PCS	
MARK:	C 10 11 12 24 9					
	11 CE810D	electrolytic capacitor	1000/16V	3.000	PCS	
MARK:	C 14 20 21					
	12 CE810E	electrotytic capacitor	1000/25V	2.000	PCS	
MARK:	C 37 44					
	13 CE822D	electrotytic capacitor	2200/16V	1.000	PCS	
MARK:	C 18					
	14 DR0005	rectifier diode	1N4148 0.5A	1.000	PCS	
MARK:	D 1					
	15 DR001A	rectifier diode	1N4002/100V	5.000	PCS	
MARK:	D 2 3 4 5 6					
	16 SIC002	integrated circuit	TL074CN (S&T)	2.000	PCS	
MARK:	U 1 2					
	17 SIC003	integrated circuit	TL072CN	1.000	PCS	
MARK:	U 3					
	18 SIC705	integrated circuit	7812	1.000	PCS	
MARK:	U 13					
	19 SD00124	integrated circuit	7912	1.000	PCS	
MARK:	U 11					
	20 SIC714	integrated circuit	7805	1.000	PCS	
MARK:	U 12					
	21 SIC727	IC	74HC08N	1.000	PCS	
MARK:	U 6					
	22 SLE006	light-electron transisto	H11L1 (QTC)	1.000	PCS	
MARK:	ISO 1					
	23 HCSW0206	row-wire header	6P 2.5mm 180°	1.000	PCS	
MARK:	J 2					
	24 HCSW0203	row-wire header	JST2.5(S 3P 2.5mm 180°	3.000	PCS	
MARK:	J 1 4 5					

Item No: CONTROL30

specify: AMP

Mid No: standard quantity:

NO	Material No	Item Name	Specific	Quantity	Unit	Ps
25	HCSR0205	row-wire header	5P 3.96mm 180°	1.000	PCS	
MARK:	J 3					
26	HCSM40	MIC jack for balance	99M-108SP1	2.000	PCS	
MARK:	S 1 2					
27	HCSM41	MIC jack for balance	99M-107SP1-2	2.000	PCS	
MARK:	S 3 4					
28	HCSS66	DIN socket	5PIN(JY-5005)	3.000	PCS	
MARK:	CN 1 2 3					
29	MC0049	inductor	330uH(LGA0308-331K)	1.000	PCS	
MARK:	L 14					
30	C00038	EMI FILTER (filter)	LF-22UH(WAH TAYI)	12.000	PCS	
MARK:	L 1 10 12 13 2 3 4 5 6 7 8 9					
31	MMCJ04	jumper wire	6m/m	1.000	PCS	
MARK:	JP 17					
32	MMCJ06	jumper wire	8m/m	5.000	PCS	
MARK:	JP 12 13 14 16 18					
33	MMCJ09	jumper wire	10m/m	11.000	PCS	
MARK:	JR 1 10 11 15 19 2 20 3 4 5 9					
34	HCTT25	connect terminal	6.5m/m (PCF250)	1.000	PCS	
MARK:	JR 15					
35	MSCN16	Ni screw	pill 3*6 thin tooth P0.	3.000	PCS	
MARK:						
36	MSCB44	black-plated screw	cut-tail pill 3*8	2.000	PCS	鎖散熱片用
MARK:						
37	MFSS03	washer	φ 3* φ 5*1t	3.000	PCS	
MARK:						
38	STR802-T2	silicone insulator	T0-220 square type	3.000		
MARK:						
39	MI00944	heat-sink	CONTROL30	1.000	PCS	
MARK:						
40	HSWE05	swith	SP70300-0202-11F1-N	1.000	PCS	
MARK:	SW 1					
41	NPL029	insulate bean	T0220B	3.000	PCS	
MARK:						

Item No: CONTROL30

specify: AMP

Mid No: standard quantity:

NO	Material No	Item Name	Specific	Quantity	Unit	Ps
1	HB00701	PCB	G2FP1_VER020425	1.000	PCS	
MARK:						
2	RFCE000	SMD 1/10W fixed resistor	0Ω ±5% 0805	1.000	PCS	
MARK:	JP	3				
3	RFCE133	SMD 1/10W fixed resistor	330Ω ±5% 0603	18.000	PCS	
MARK:	R	19 44 45 46 47 48 49 50 51 52 53 54 55 56 57 58 59 60				
4	RFCE210	SMD 1/10W fixed resistor	1.0KΩ ±5% 0603	2.000	PCS	
MARK:	R	1 2				
5	RFCE310	SMD 1/10W fixed resistor	10KΩ ±5% 0603	9.000	PCS	
MARK:	R	18 37 38 39 40 41 42 43 5				
6	RFCE422	SMD 1/10W fixed resistor	220KΩ ±5% 0603	2.000	PCS	
MARK:	R	14 16				
7	RPCA2825	SMD 1/10W precise resis	82.5KΩ ±1% 0603	2.000	PCS	
MARK:	R	13 15				
8	CCE410F	SMD0603 ceramic capacitor	0.1uF Y5V+80 -20%50V	9.000	PCS	
MARK:	C	10 32 40 41 42 43 7 8 9				
9	SICS003	SMD integrated circuit	TL074CDT	2.000	PCS	
MARK:	U	1 2				
10	SICS705	SMD integrated circuit	74HC04DT	1.000	PCS	
MARK:	U	10				
11	SICS713	SMD integrated circuit	74HC32DT	1.000	PCS	
MARK:	U	9				
12	SICS717	SMD integrated circuit	SN74HC574DW	2.000	PCS	
MARK:	U	7 8				
13	RFCE000	SMD 1/10W fixed resistor	0Ω ±5% 0603	2.000	PCS	
MARK:	R	11 9				

Item No: CONTROL30

specify: AMP

Mid No: standard quantity:

NO	Material No	Item Name	Specific	Quantity	Unit	Ps
1	CE610N	electrolytic capacitor	10/16V ψ 4*7	1.000	PCS	
MARK:C	2					
2	CE647E	electrotytic capacitor	47/25V	2.000	PCS	
MARK:C	1 3					
3	CE722D	electrolytic capacitor	220/16V	1.000	PCS	
MARK:C	4					
4	RFB110S	1/4W fixed resistor	100 Ω S type	1.000	PCS	
MARK:R	4					
5	RVS096	potentiometer	R1411G0A-V1A103FN00-00	1.000	PCS	
MARK:VR	1					
6	RVS097	potentiometer	R1411G0A-V1A503FN00-00	1.000	PCS	
MARK:VR	2					
7	DL37RR	L.E.D high intensity	3m/m round(red) long foot	5.000	PCS	
MARK:D	1 2 3 4 5					
8	HCSI0202	row-wire header	2P 2.5mm 180°	1.000	PCS	
MARK:J	1					
9	HCSW0106	row-wire header	6P 2.5mm/小型 90°	1.000	PCS	
MARK:J	6					
10	HCSW0103	row-wire header	3P 2.5mm 90°	3.000	PCS	
MARK:J	10 5 9					
11	HLSG014	header wiring FL-0464A	20P-20P PH1.27 220mm	1.000	PCS	
MARK:J	2					
12	HLSG015	header wiring FL-0464A	24P-24P PH1.27 120mm	1.000	PCS	
MARK:J	3					
13	HCSP01009	row pin	2.54 180° 8P(gold-plate)	1.000	PCS	
MARK:J	8					
14	HCSP05004	row-pin(double)#2200	2.54 180° 2*7P(gold-pla)	1.000	PCS	
MARK:J	4					
15	HCSP01001	row-pin(dual)	2.54 180° 10P(gold-plat)	2.000	PCS	
MARK:CN	1 2					
16	NI01793	LED spacer support	LEDS-17 17mm	5.000	PCS	
MARK:						
17	MMCJ01	jump	3m/m	2.000	PCS	
MARK:JP	1 2					

Item No: CONTROL30

specify: AMP

Mid No: standard quantity:

<i>NO</i>	<i>Material No</i>	<i>Item Name</i>	<i>Specific</i>	<i>Quantity</i>	<i>Unit</i>	<i>Ps</i>
1	NPC389	PCB	MK31-FDKB (1*6)	1.000	PCS	
MARK:						
2	HSWE09	button swith	6*6*5	7.000	PCS	
MARK:						
3	HCSB04	row-pin header (single) #2 2.54 180°	8P (gold-plate)	1.000	PCS	
MARK:						

Item No: CONTROL30

specify: AMP

Mid No: standard quantity:

<i>NO</i>	<i>Material No</i>	<i>Item Name</i>	<i>Specific</i>	<i>Quantity</i>	<i>Unit</i>	<i>Ps</i>
1	NPC388	PCB	MK31-LED (1*15)	1.000	PCS	
MARK:						
2	DLS002AR	SMD1210 L.E.D	67-21SURC/S530-A2/TR8 (re	2.000	PCS	
MARK:						
3	DLS004AY	SMD1210 L.E.D	67-21UYC/S530-A2/TR8 (ye1	2.000	PCS	
MARK:						
4	DLS003AG	SMD1210 L.E.D	67-21SYGC/S530-E1/TR8 (gr	8.000	PCS	
MARK:						

Item No: CONTROL30

specify: AMP

Mid No: standard quantity:

<i>NO</i>	<i>Material No</i>	<i>Item Name</i>	<i>Specific</i>	<i>Quantity Unit</i>	<i>Ps</i>
1	MWI012	copper pole M3*P0.5	6m/m dual flat	4.000 PCS	
MARK:					
2	MSCN75	Ni screw	M3*4	8.000 PCS	
MARK:					
3	HE00019	LCD	LMC-SSC2A20DLYY-01	1.000 PCS	
MARK:					

