

AMPEX
PROFESSIONAL PRODUCTS
COMPANY

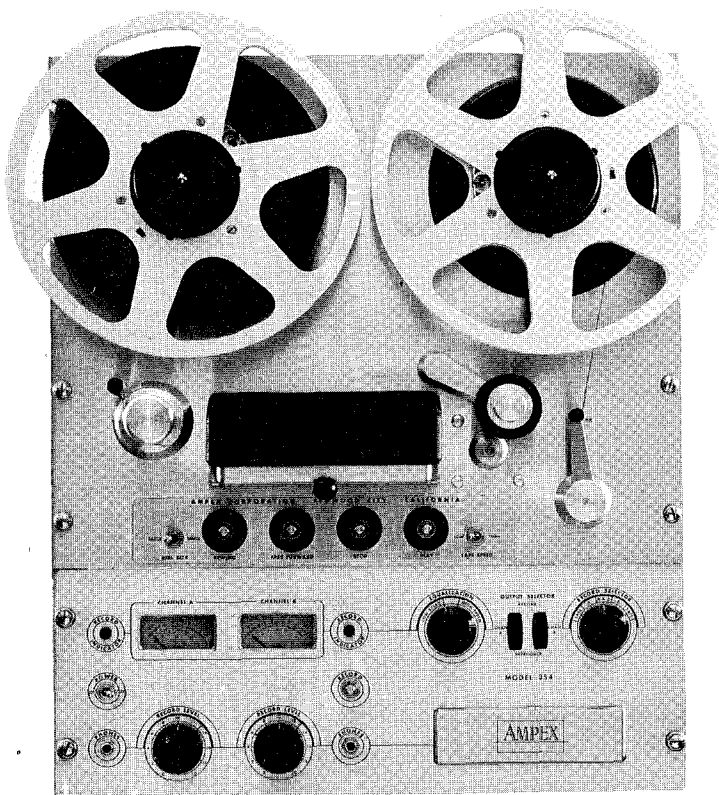

AMPEX SERIES



TWO TRACK STEREOGRAPHIC
RECORDER/REPRODUCER

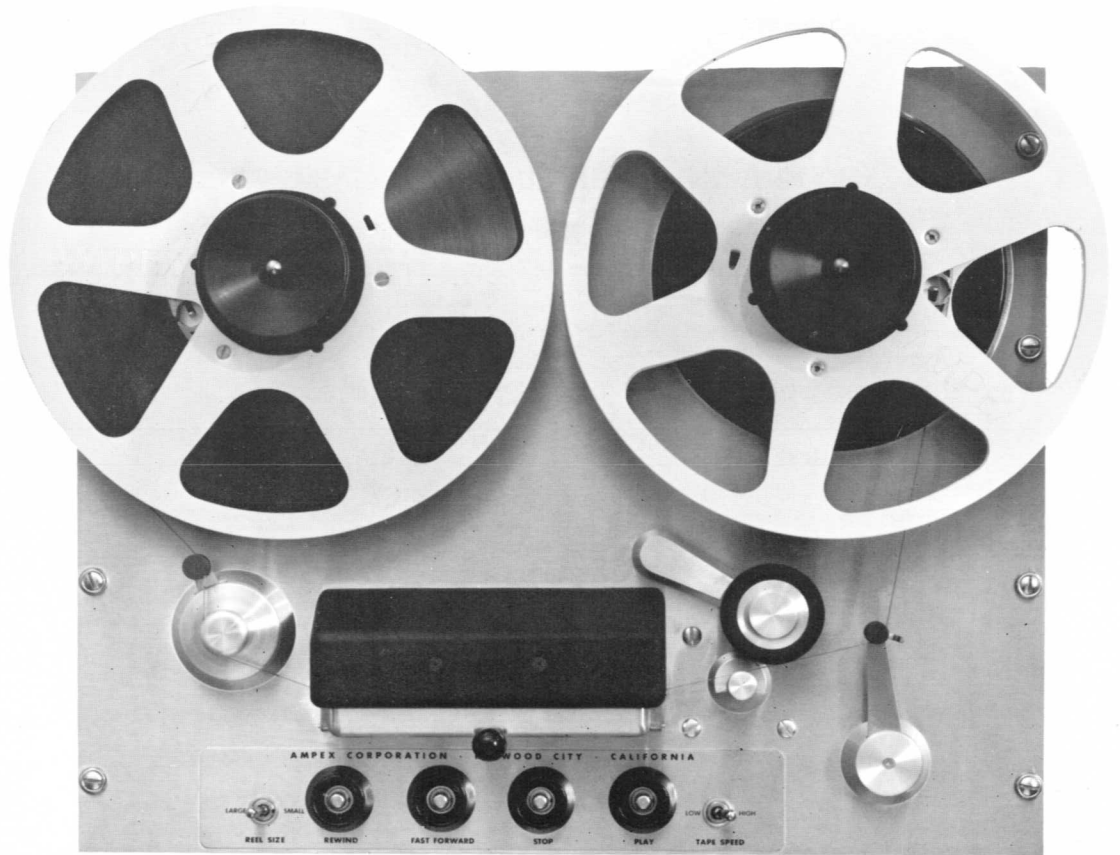

AMPEX SERIES

354

TM 2011A

JUNE 1960

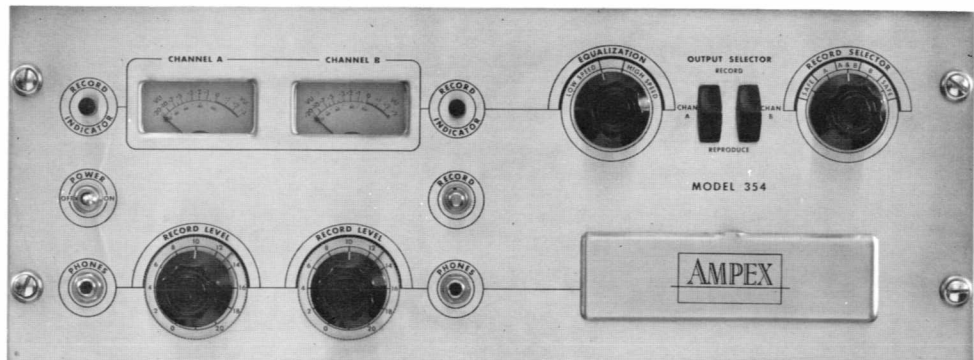

table of Contents

section

topic

page

1	DESCRIPTION AND PERFORMANCE CHARACTERISTICS	
	General	1-1
	Performance Characteristics	1-2
	Equipment Available	1-4
2	INSTALLATION	
	General	2-1
	Interconnecting	2-1
	Mounting	2-1
	Power Connection	2-3
	Output	2-3
	Input	2-3
	Phones	2-3
	Remote Control	2-3
	60 Cycle Amplifier	2-4
	Overall Performance Check	2-4
	Distortion	2-4
	Flutter and Wow	2-4
3	OPERATION	
	General	3-1
	Summary of Controls, Switches and Indicators	3-2
	Operating Techniques	3-4
4	THE DEVELOPMENT AND THEORY OF MAGNETIC TAPE RECORDING	
	Theory of Magnetic Tape Recording	4-2
5	TAPE TRANSPORT MECHANISM	
	General	5-1
	Tape Supply and Take-Up Systems	5-1
	Tape Drive System	5-4
	Brake Operation	5-4
	Control Circuit	5-5
	Routine Maintenance	5-7
	Adjustments	5-10
	Spring Scale Reading	5-11
	Parts List, Tape Transport	5-15
6	THE AMPEX HEAD	
	General	6-1
	Individual Replaceable Head Parts	6-2
7	ELECTRONIC ASSEMBLY	
	General	7-1
	Record Amplifier	7-2
	Reproduce Amplifier	7-4
	Bias and Erase Oscillator	7-4
	Power Supply	7-5
	Alignment and Performance Checks	7-5
	Maintenance and Troubleshooting	7-13
	Ordering Parts	7-15
	Parts List, Electronic Assembly	7-16

list of Illustrations

Section

Topic

Page

	Ampex Series 354 Recorder/Reproducer.....	iv
2	Series 354 Recorder/Reproducer— $\frac{3}{4}$ View	2-2
	Rack Layout (Model 354).....	2-2
	Interconnecting	2-5
3	Tape Threading Path.....	3-4
4	Valdemar Poulsen	4-1
	Magnetization of Tape.....	4-2
	Record Head	4-2
	Recording Medium Magnetization Curve.....	4-2
	Reproduce Head Characteristics.....	4-3
	Achieving Flat Over-All Response.....	4-4
5	Component and Assembly Callouts.....	5-2
	Tape Tensioning	5-3
	Take-Up and Rewind Motor Assemblies.....	5-5
	Control Circuit Box.....	5-6
	Demagnetizing the Heads.....	5-9
	Control Circuit Box Callouts.....	5-10
	Capstan Idler Pressure Measurement.....	5-11
	Brake Band Replacement.....	5-13
	Remote Control.....	5-14
	Schematic Diagram Tape Transport Control Circuits (Foldout Sheet).....	
	Simplified Schematic Diagram Control Circuit Model 354 Tape Transport (Foldout Sheet).....	
6	Two-Track Head Assembly.....	6-2
7	Location of Electronic Subassemblies.....	7-2
	Block Diagram, Record Circuit.....	7-2
	Amplifier Chassis, Front Panel.....	7-3
	Amplifier Chassis, Rear View.....	7-3
	Block Diagram, Reproduce Circuit.....	7-4
	Simplified Schematic Diagram, Line Output Amplifier.....	7-4
	Block Diagram, Reproduce Alignment Connections.....	7-6
	Reproduce Alignment Controls.....	7-6
	Record Amplifier Bias Adjustment Controls.....	7-8
	Record Level Calibration Controls.....	7-8
	Record Head Azimuth Adjustment.....	7-9
	Record Head Azimuth Controls.....	7-9
	Frequency Response Adjustment Controls.....	7-10
	Noise Balance Adjustment Controls.....	7-11
	Signal-To-Noise Ratio Computations.....	7-12
	Noise Measurement Controls.....	7-12
	Troubleshooting the Reproduce Amplifier.....	7-13
	Troubleshooting the Record Amplifier.....	7-14
	Applicable Response Curves.....	
	Parts Location (Etched Board) (Foldout Sheet).....	
	Schematic Diagram (Foldout Sheet).....	



Ampex Series 354 Recorder/Reproducer

DESCRIPTION AND PERFORMANCE CHARACTERISTICS

GENERAL

The AMPEX Series 354 Magnetic Tape Recorder/Reproducers are high quality precision instruments designed for the professional user who requires the finest and most faithful recording and reproduction.

A basic recorder/reproducer in the 354 series consists of a tape transport for operation at tape speed pairs of $3\frac{3}{4}$ inches per second (ips) and $7\frac{1}{2}$ ips or $7\frac{1}{2}$ and 15 ips; a two-track head assembly for use with the $\frac{1}{4}$ -inch magnetic tape; and an electronic assembly which contains two record amplifiers, two reproduce amplifiers, a bias and erase oscillator, and a power supply — all featuring etched board construction.

CCIR equalization can be obtained on request when ordering equipment.

Several mounting arrangements are offered — console, two case portable, and rack mount. In the portable equipment, one case contains the tape transport and the other houses the electronic assembly.

PERFORMANCE CHARACTERISTICS

<i>Tape Width</i>	1/4-inch	
<i>Tape Speed Pairs</i>	3 3/4-7 1/2 ips 7 1/2-15 ips	
<i>Frequency Response</i>	<i>Speed (ips)</i>	<i>Response (Cycles per second)</i>
	3 3/4	±2 db 40 to 8,000
	7 1/2	±2 db 40 to 12,000
	15	±2 db 30 to 18,000
<i>Signal-to-Noise Ratio</i>	<i>Speed (ips)</i>	<i>Peak Record Level to Unweighted Noise (db)</i>
	3 3/4	50
	7 1/2	55
	15	Same as 7 1/2 ips

Peak record level is that level at which the overall (input to output) total rms harmonic distortion does not exceed 3 percent when measured on a 400 cycle tone. Noise is measured after erasing a signal of peak recording level in the absence of new signal. Bias, erase and reproduce amplifier noise are included in the measurement. All frequencies between 50 and 15,000 cycles are measured.

<i>Flutter and Wow</i>	<i>Speed (ips)</i>	<i>Flutter and Wow (percentage rms)</i>
	3 3/4	.25%
	7 1/2	.2 %
	15	.15%

Flutter and wow measurements include all components between 0 and 300 cycles using an rms value of constant amplitude sine wave flutter.

<i>Recording or Reproducing Time</i> (NAB 10 1/2 Inch Diameter Reels, 2400 feet of tape)	<i>Speed (ips)</i>	<i>Half Track</i>		<i>Two Track</i>	
		<i>(hrs)</i>	<i>(min)</i>	<i>(hrs)</i>	<i>(min)</i>
	3 3/4	4	16	2	8
	7 1/2	2	8	1	4
	15	1	4		32

Starting Time The tape is accelerated to full speed in less than 1/10 of a second.

Stopping Time When operating at 15 ips, the tape moves less than two inches after the STOP button is pressed.

<i>Reproduce Timing Accuracy</i>	<i>Accuracy (percentage)</i>	<i>Accuracy (second)</i>	<i>Length of Recording (min)</i>
	±.2%	±3.6	30

Rewind Time Approximately 1 minute for a full 2,400 foot NAB reel.

Controls

- Tape Motion** All tape motion is controlled by four pushbuttons, PLAY, STOP, FAST FORWARD and REWIND.
- Record Control** A separate RECORD button on the face of the electronic assembly, when pressed, energizes the record relay which drops out when the STOP button is pressed. Selection of record channel(s) desired, is accomplished by the RECORD SELECTOR switch on the electronic assembly.
- Tape Speed** Tape speed can be changed by the TAPE SPEED switch. LOW or HIGH positions are used to select drive motor windings.
- Equalization** An EQUALIZATION switch on the face of the electronic assembly provides a means for selecting LOW or HIGH speed equalization appropriate to the tape speed used.
- Reel Size** A REEL SIZE toggle switch on the tape transport makes possible selection of the proper tape tensioning for the NAB 10½ inch diameter reel or the EIA 5 inch and 7 inch reels.
- Record Inputs** Two inputs are supplied; one for each channel. With plug-in pre-amplifiers, plug-in transformers or dummy plugs, the inputs can accommodate microphones, balanced lines or unbalanced lines respectively. A RECORD LEVEL control is supplied for each channel.

Reproduce Output

Zero indication on the v-u meter corresponds to +4 dbm (± 1 db). Sufficient power handling capabilities exist to feed a +20 dbm line output into 600 ohms balanced or unbalanced. The center tap of the output transformer can be strapped to ground for balanced output.

Head Housing

The erase, record, and reproduce heads are contained in a single head housing (See SECTION 6 on HEAD ASSEMBLIES).

Monitoring (aural and visual)

The signal on the tape can be monitored while the equipment is recording. Two phone jacks are available to allow monitoring the record input signal, or the output signal from the reproduce head. A switch provides a means for making direct comparison between the original program and the recorded program. Two 2½-inch vu meters are provided for level comparison and visual monitoring of each channel.

Power Requirements

Two track equipment requires 2.5 amperes at 117 volts ac, 50 or 60 cycles. When the Ampex Model 375 Precision Frequency 60 cycle amplifier is used with the equipment, power requirements are greater by 2.5 amperes.

EQUIPMENT AVAILABLE

<i>Dimensions and Weight (in.) (lb.)</i>	<i>Item</i>	<i>Height</i>	<i>Depth</i>	<i>Width</i>	<i>Weight</i>
<i>Rack Mount</i>	Tape Transport	15¾ (rack space)	8 (behind rack)	19	50
	Electronic Assembly	7 (rack space)	8½ (behind rack)	19	18
<i>Console</i>	Console	48 (max)	28½ (max)	24½	155
<i>Two Case Portable</i>	Tape Transport Case (Equipment in Case)	15½	17	20¼	69
	Electronic Ass'y. Case (Equipment in Case)	9	13	21	38

Remote Control

Part Numbers for Remote Control units are located
in the Electronic Section Parts List.

INSTALLATION

NOTE

Before operating the equipment read this SECTION AND SECTION 3, OPERATION.

GENERAL

The 354 Series equipment is shipped mounted in consoles or portable cases after a thorough inspection and performance check at the factory. In the event that the equipment is requested disassembled, for customer rack mounting, all assembly hardware is provided.

INTERCONNECTING

See the appropriate interconnecting diagrams at the back of this section.

MOUNTING

Console Models

To assemble the console model proceed as follows:

- Step 1:* Install the tape transport in the cabinet frame, securing the 8 oval-head screws and finishing washers.
- Step 2:* Place the two springs in the holes for the electronic assembly cabinet frame.
- Step 3:* Attach the two rails to the electronic assembly using the number 8 screws.
- Step 4:* Slide the cabinet back panel up and out to allow connecting of the a-c power cable and plug the input cable and the output cable into their receptacles on the back of the electronic

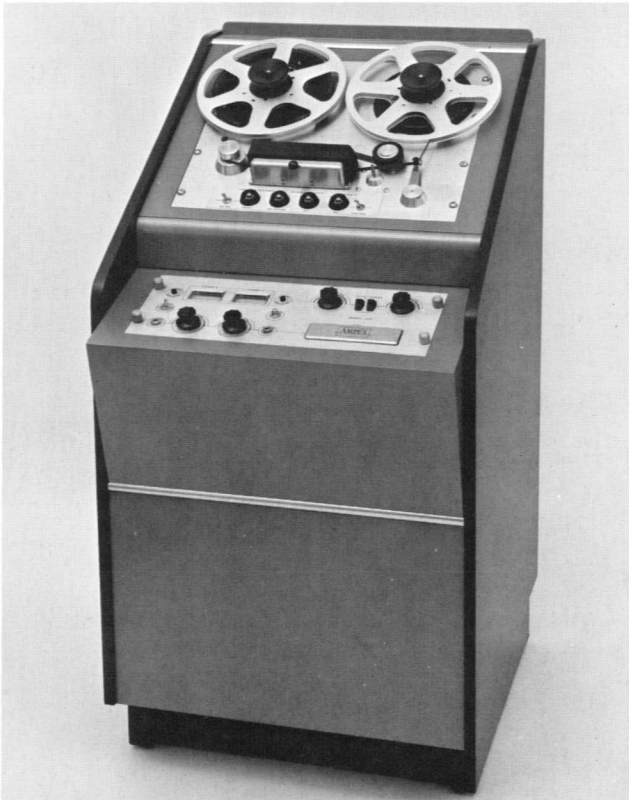

Series 354 Recorder/Reproducer— $\frac{3}{4}$ View

assembly.

- Step 5: Install the electronic assembly, tightening the four knurled nuts to fasten it to the frame.
- Step 6: Connect the captive head cables at their locations on the electronic assembly.
- Step 7: Connect the captive CABLE TO ELECTRONICS to the electronic assembly.
- Step 8: Replace the back panel, making certain that all cables run freely through the semi-circular cut-outs at the bottom of the sliding panel.

Two Case Portable Models

The two case portable models are shipped in a ready to operate condition, except for the connection of interconnecting cables. Convenient rubber feet are located at both ends of each case, and metal rests are provided on the

backs of each case. To set up the equipment follow these steps:

- Step 1: Arrange the cases so that the mechanical assembly case is to the right of the electronic assembly case.
- Step 2: Unlatch and remove the top cover and the side access door on the mechanical assembly case.
- Step 3: Unlatch and remove the front and rear covers on the electronic assembly case.
- Step 4: Uncoil the interconnecting cables from behind the cable access door on the tape transport case and plug them into mating receptacles at the rear of the electronic assembly.
- Step 5: Connect the a-c power, and the input and output to the rear of the electronic assembly.

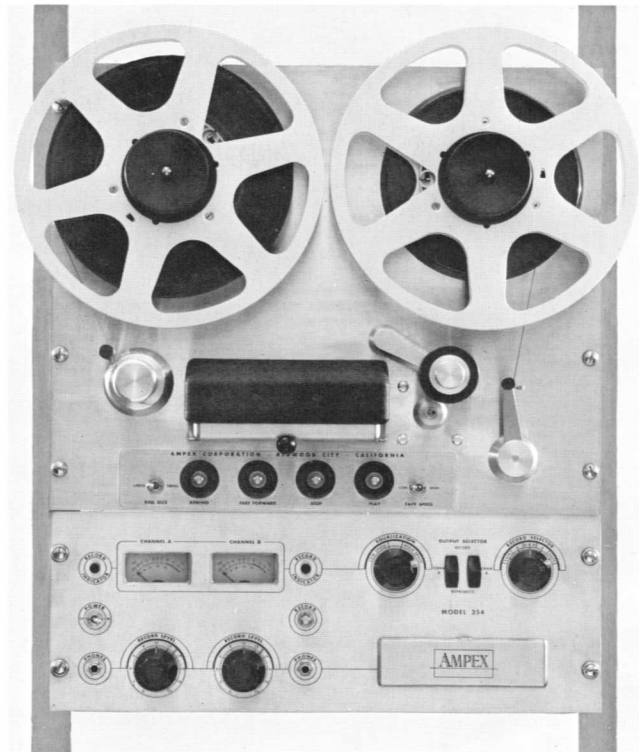

Rack Layout (Model 354)

Rack Mounted Models

Mount these versions of the equipment on a standard 19-inch relay rack with the mechanical assembly above the main electronic panel.

POWER CONNECTION

Connect the power cable from the a-c POWER input connector, J20, on the electronic assembly to a convenient 117 volt a-c power source.

OUTPUT

A mating connector for LINE OUTPUT is supplied. The user must fabricate his own cables, using the connectors supplied with the recorder.

Studio Line

Plus 4 v-u, 600 ohm line output, balanced or unbalanced, is available across terminals 2 and 3 of the line output connectors J3 and J4. Pin 1 is the chassis ground. Connector J3 is the output connector for channel A, while connector J4 is the output connector for channel B.

If unbalanced output is desired, wire the mating connector so that the pin 2 side of the line is tied to ground.

High Impedance Amplifier Input

Wire the mating connector so that pin 3 of the line output connector, J3 or J4, is connected to the high side of the amplifier input. Strap pins 1 and 2 of the mating connector for connection to the ground side of the amplifier input.

INPUT

During this discussion refer to the foldout illustration — Schematic Diagram-Electronic Assemblies at the back of SECTION 7.

Microphone Input

Any low impedance microphone having a nominal impedance between 30 and 250 ohms can be plugged directly into the equipment.

Wire the mating connector so that the microphone is connected to pins 2 and 3 of the line connector, J1 (channel A) or J2 (channel B). The cable shield must be connected to pin 1 and the plug-in microphone preamplifier must be inserted into the transformer socket.

High impedance microphones are not recommended for use in this equipment because, in general, the quality is not satisfactory for professional work.

Bridging a Balanced Studio Line

Connect a balanced line to pins 2 and 3 of the input connector, J1 or J2. Pin 1 is ground. The plug-in line input transformer must be inserted into the transformer socket. Rms input levels of zero to plus five dbm can be accommodated. The load placed on the line is approximately 20K ohms.

Bridging an Unbalanced Source

Connect an unbalanced line, radio tuner, etc., to pins 1 and 3 of the input connector. Pin 1 is the ground side. The shorting bar must be inserted between pins 3 and 8 of the transformer socket. This connection provides a 100K ohm bridging input. An rms program voltage of one volt is adequate.

PHONES

High impedance head phones must be used. To monitor the incoming line or reproduce output, plug the high impedance phones into phone jack J17 (channel A) or J18 (channel B) on the amplifier face panel. To preserve low frequency response, feed into an input impedance of 50K ohms or higher. To reserve high frequency response the cable should have not over 500 pf of capacitance.

REMOTE CONTROL

Operation of the tape transport mechanism can be remotely controlled by a Remote Control Unit. The catalog No. 5763-02 unit is supplied in a plastic case, completely wired and ready to plug into the remote control connector, J502S, on the tape transport circuits assembly.

The catalog No. 5763-03 unit is mounted on a flat plate for installation in studio consoles, and is not wired. To install, wire as shown in the figure (Schematic Diagram, Remote Control Unit) located in SECTION 5, and plug into J502S.

NOTE

Whenever the remote control unit is not connected, the dummy plug P502P, supplied with the equipment, must be plugged into J502S.

60 CYCLE AMPLIFIER

The Ampex Model 375 Precision 60 Cycle Amplifier can be plugged directly into the equipment at J503S. No other connections are necessary. The Model 375 is used where power sources are erratic and there is need for a precision 60 cycle time base for driving the capstan.

CAUTION

If this unit is used with the Recorder/Reproducer, the control circuit fuse F402 must be increased to 5 amperes.

NOTE

Do not remove the dummy plug P503P unless the 60 cycles amplifier is connected.

OVERALL PERFORMANCE CHECK

(Read SECTION 3, OPERATION before making these checks.)

Make the following equipment performance checks at the time of installation and when necessary thereafter:

- REPRODUCE (Playback) LEVEL
- REPRODUCE (Playback) RESPONSE
- REPRODUCE (Playback) NOISE MEASUREMENT
- RECORD CALIBRATION
- FREQUENCY RESPONSE
- RECORD NOISE MEASUREMENT

NOTE

It should be noted that this machine has been adjusted at the factory to produce frequency response within specifications when recording on an average tape. In the last few years the high frequency output from tape has improved tremendously. In order to keep pace with these improvements, in the summer of 1959 Ampex selected a new "average" tape to adjust bias and record equalization.

Complete instructions for making the above checks are given in SECTION 7 ALIGNMENT AND PERFORMANCE CHECKS.

DISTORTION

Overall distortion can be measured by connecting any standard distortion measurement apparatus across the output. The readings from a wave analyzer or selective frequency distortion meter will be more accurate than those from a null type instrument at lower distortion levels. Distortion readings are somewhat dependent on tape. A reading of 1% is normal at operating level while a reading of 3% is normal at 6 db above operating level. Second harmonic distortion is negligible; measured distortion is predominately third order.

FLUTTER AND WOW

Flutter and wow are produced by periodic irregularities in tape speed and appear as cyclic frequency deviations in recording or reproduction. They can be measured by means of any standard flutter bridge. Variations in amplitude as indicated on level measurements do not constitute flutter and are entirely due to tape coating variations. Readings will be near or below .15% rms at 15 inch, .2% rms at 7½ inch, and .25% rms at 3¾ inch speed. The Ampex Professional Products Division primary standard of measurements is based on the use of a flutter meter calibrated to indicate the deviation from mean carrier frequency of any rate between .5 and 300 cps expressed in percent rms. Flutter and wow checks should be made at the peak record level or higher.

INTERCONNECTING

<i>Cable</i>	<i>Catalog Number</i>	<i>Qty.</i>	<i>From Receptacle</i>	<i>Chassis</i>	<i>To Receptacle</i>	<i>Chassis</i>
A-c	2413-00	(1)	J20 POWER	Electronic Assembly	A-c Source	
Power Inter-connecting		(1)	J19 TAPE TRANSPORT	Electronic Assembly	CABLE TO ELECTRONICS	Captive at Tape Transport
Reproduce Head (Ch. A)		(1)	J9 PLAYBACK HEAD	Electronic Assembly		Captive at Tape Transport
Reproduce Head (Ch. B)		(1)	J10 PLAYBACK HEAD	Electronic Assembly		Captive at Tape Transport
Record Head (Ch. A)		(1)	J7 RECORD HEAD	Electronic Assembly		Captive at Tape Transport
Record Head (Ch. B)		(1)	J8 RECORD HEAD	Electronic Assembly		Captive at Tape Transport
Erase Head (Ch. A)		(1)	J5 ERASE HEAD	Electronic Assembly		Captive at Tape Transport
Erase Head (Ch. B)		(1)	J6 ERASE HEAD	Electronic Assembly		Captive at Tape Transport

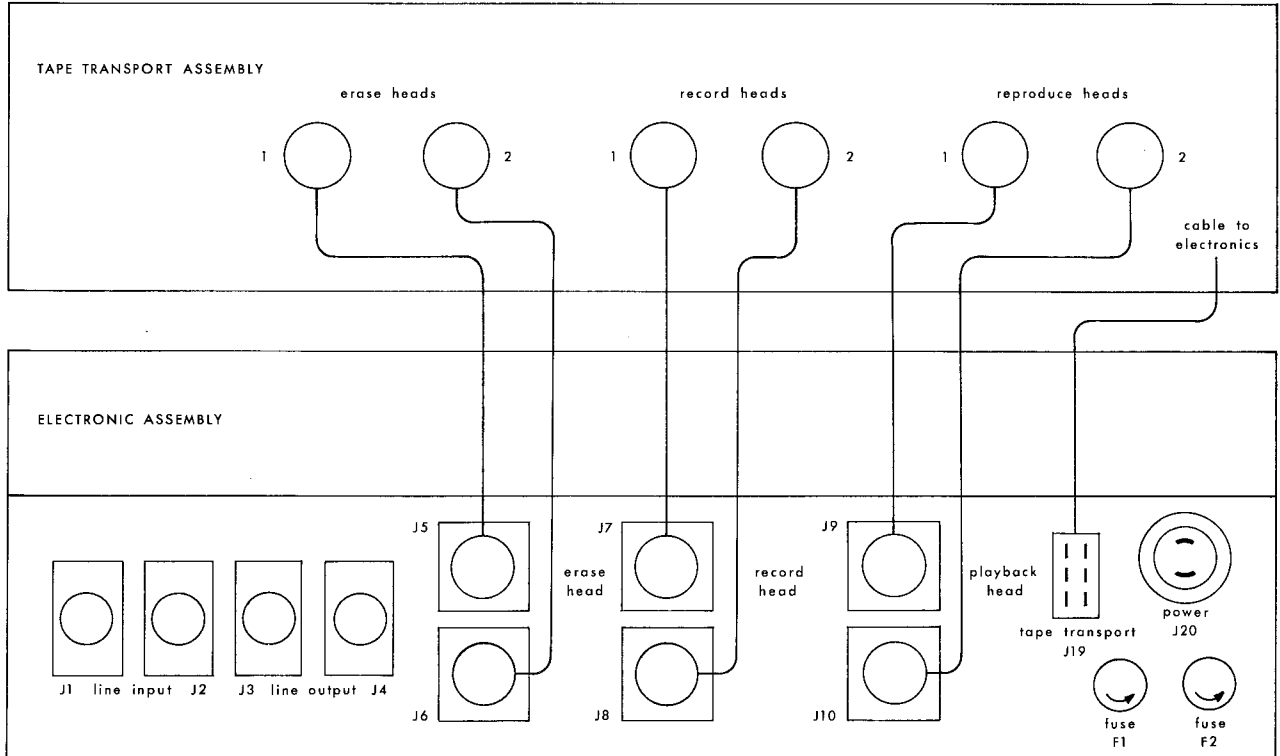

Interconnecting

OPERATION

GENERAL

The 354 Series recorder/reproducers are available for two track stereophonic operation. All operating controls are located on the tape transport with the exception of the record control which is on the front panel of the electronic assembly. When the remote control unit is furnished, duplicate tape motion controls, a RECORD button, a RECORD INDICATOR light and a TAPE MOTION indicator light are mounted on the remote unit.

The equipment can accommodate the NAB 10½ inch diameter tape reels or the EIA 5 and 7-inch reels. Provision is made for selection of proper tape tensioning at the REEL SIZE switch on the tape transport for the LARGE or SMALL size reels.

NOTE

In the LARGE reel position both the rewind and take-up reels must be NAB type and in the SMALL reel position both reels must be EIA.

Either of two capstan drive motor speeds can be selected at the LOW-HIGH TAPE SPEED switch on the tape transport.

On the front panel of the electronic assembly are facilities for setting RECORD LEVEL, selecting the channel(s) to be recorded, and selecting LOW SPEED or HIGH SPEED EQUALIZATION. Two phone jacks (PHONES) for monitoring, a RECORD button, two RECORD INDICATOR lights, and a POWER ON-OFF switch are also mounted on the electronic assembly front panel.

SUMMARY OF CONTROLS, SWITCHES AND INDICATORS

<i>Item</i>	<i>Schematic Reference Symbol</i>	<i>Location</i>	<i>Function</i>
POWER OFF-ON SWITCH	S6	Electronic Assembly front panel	Controls power to the electronic and mechanical assemblies. When power is on capstan will rotate if tape is properly threaded or the safety switch is mechanically closed. The v-u meter lamps light when power is on, and are unaffected by the safety switch, remaining lighted till the power is turned off.
TAPE SPEED	S503	Tape Transport control cluster	Determines speed of the capstan drive motor by high or low speed winding. Used in conjunction with EQUALIZATION switch S2.
EQUALIZATION LOW SPEED HIGH SPEED	S1	Electronic Assembly front panel	Used to select appropriate equalization circuitry for tape speed chosen.
REEL SIZE LARGE SMALL SWITCH	S504	Tape Transport	Adjusts tape tensioning circuitry for the reel size used. The switch is closed when (LARGE position) NAB 10½ inch reels are used. In the SMALL position the switch is open, connecting resistance R502 in series with the torque motors, thereby reducing holdback and take-up tension.
RECORD SELECTOR	S4	Electronic Assembly front panel	Provides bias and erase current to channel A only when in channel "A" position if RECORD button is pressed; provides bias and erase current to channel B when in channel "B" position if RECORD button is pressed; provides bias and erase current to both channels when in "A & B" position if RECORD button is pressed; and does not provide bias or erase current to either channel when in either SAFE position regardless of whether or not the RECORD button is pressed.
RECORD LEVEL	R1 R2	Electronic Assembly front panel	Adjusts record level.
VU METER	M1 M2	Electronic Assembly front panel	Provides a means for visually monitoring record input level, reproduce level, and bias and erase.
PLAY button	S505	Tape Transport control cluster	Controls tape motion in the reproduce (PLAY) and record modes. Interlocked with rewind and fast forward modes.

RECORD button	S5	Electronic Assembly front panel	Controls the record relay in the electronic assembly. Power is applied to the bias erase oscillator when this button is pressed. The PLAY button must be pressed to put the tape in motion before the record button is used.
REWIND button	S507	Tape Transport control cluster	Controls the rewind relay. Full a-c power is connected directly to the rewind (supply) motor when this button is pressed, the resistance R504 is placed in the a-c circuit to the take-up motor.
FAST FORWARD button	S506	Tape Transport control cluster	Controls the fast forward relay. Connects full a-c power to the take-up motor and places resistance R504 in the a-c circuit to the rewind motor when this button is pressed.
STOP button	S502	Tape Transport control cluster	When this button is pressed, the brake solenoids and all relays are de-energized.
OUTPUT SELECTOR	S2 S3	Electronic Assembly front panel	In the REPRODUCE position, the v-u meters indicate the signal level at the secondary of the output transformer. In the RECORD position, the v-u meters indicate a "flat" reading of the input signal.

OPERATING TECHNIQUES

Threading the Tape

Thread the tape as shown in the illustration. Unwind and inspect all new factory wound reels of tape by running them through in the FAST FORWARD mode. New tapes may be looped to the hub in such a manner that the tape will not come free at the end of the reel. This will prevent the safety switch (S501) from disengaging the capstan idler from the capstan, which in turn results in a flat being worn on the capstan idler wheel. (Any adhesive material accumulation on the reel hub may also keep the tape from coming free at the end of the reel, and should therefore be removed with solvent.)

Power

Power is supplied through power switch S6 which must be turned on to operate the electronic and mechanical assemblies. The mechanical assembly and electronic assembly are individually fused by the 3 ampere control circuit fuse F1 and the ¾ ampere electronic fuse F2.

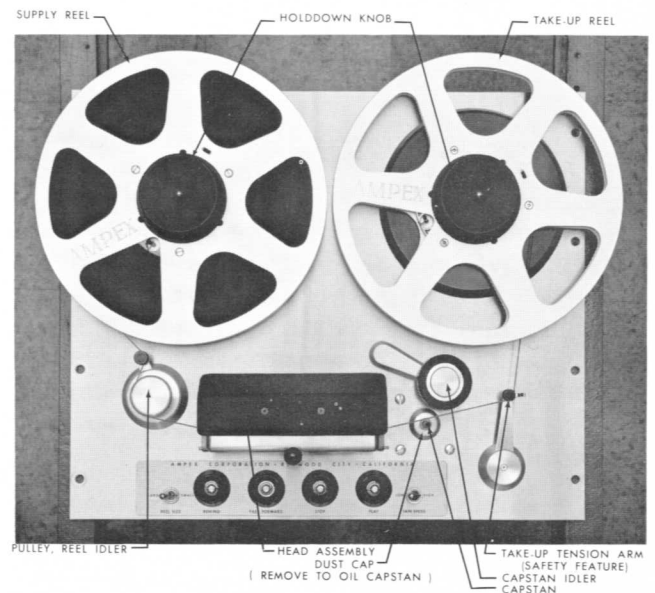

Tape threading path

Speed Switches

There are two switches associated with operating speed. The tape speed switch S503 determines the speed of the capstan drive motor, and the equalization switch S1 changes the equalization in the amplifiers appropriately.

Tape Motion

The tape motion is controlled by means of four pushbuttons labeled REWIND, FAST FWD, STOP and PLAY.

PLAY OR RECORD

The tape is set into play motion at the speed selected by the tape speed switch when the PLAY button S505 is pressed. To change from play to the record mode with the tape in motion, press the RECORD button S5 on the electronic assembly.

STOP

To stop the tape while it is moving in any mode, press the STOP button S502. The equipment will stop automatically if the tape breaks or runs off either reel.

FAST FORWARD

The equipment can be started in fast forward or switched to fast forward from any of the operating modes by pressing the fast forward button S506.

REWIND

The equipment can be started in rewind or switched to rewind from any of the operating modes by pressing the rewind button S507.

NOTE

In using either the fast forward or rewind mode, it is desirable to remove the tape from direct contact with the heads by opening the gate of the head assembly. This will reduce wear on the heads and prevent the oxide coating on the tape from depositing on the heads and impairing their performance.

Editing and Cueing

Indexing the tape as in editing or cueing, or when approaching the end of the reel, is simplified by holding down a combination of buttons. Tape motion can be reduced by holding down the fast forward and rewind buttons simultaneously, and then alternating between the two to control tape direction. When the desired point is reached, the STOP button must be held down until the fast forward and rewind buttons are released.

CAUTION

Never press the STOP and PLAY buttons in rapid sequence when the tape is traveling at high speed in the REWIND or FAST FORWARD modes. This will almost invariably break the tape since it does not allow the tape to stop before the capstan idler locks it to the capstan.

Reproduce (Playback)

To reproduce a previously recorded tape, place the OUTPUT SELECTOR switch, S2 or S3 or both, in the REPRODUCE position, then start the tape in motion as indicated under PLAY. RECORD SELECTOR switch, S4, should be in either of the two SAFE positions.

Record

To record a new program on previously recorded tape, or on blank tape, place the OUTPUT SELECTOR switch, S2 or S3 or both, in the RECORD position and the RECORD SELECTOR switch, S4, in either of the SAFE positions. Turn the RECORD LEVEL control, R1 or R2 or both, clockwise until the level reads 0 (zero) on the associated vu meter on the most intense program peaks. The program can be audibly monitored through either the phone jacks (PHONES), J17 and J18, or the line out connectors (LINE OUTPUT), J3 and J4, before the tape is in motion. This direct monitor feature allows the program to be set up through the machine without actually recording during the set up period.

When the program level is properly set, turn the RECORD SELECTOR switch, S4, to the "A," "A & B," or "B" position as applicable and start the tape in motion as indicated under PLAY. Then press the RECORD button, S5. The RECORD INDICATOR, DS1 or DS2 or both, will now glow and the equipment is recording.

Remote Control

For remote operation, remove the dummy plug P502P from the receptacle J502S on the control box of the tape transport and connect the remote control cable from J502S to the remote control unit (see TAPE TRANSPORT MECHANISM—REMOTE CONTROL).

THE DEVELOPMENT AND THEORY OF MAGNETIC TAPE RECORDING

There is no definite beginning to the history of magnetic recording but we can be certain that credit for building the first magnetic recorder belongs to Valdemar Poulsen. This Danish telephone engineer who is often referred to as the "Father of Magnetic Recording" designed the microphonograph which was an invention of great scientific significance. In this apparatus a steel wire was moved with considerable velocity between the poles of a small electromagnet. By using this device a conversation could be permanently recorded for reproduction at any time.

In the early 1900's many scientists were attempting to use magnetic tape in preference to the earlier idea of wire. About 1927 a German inventor named PFleumer was experimenting with powdered coatings on tape. So far as we know he did not use magnetic oxide but coated his tapes with powdered metallic materials. Development continued and finally about the year 1939 the Germans produced a tape using a durable plastic backing. This began a new era in the improvement of magnetic tapes, culminating in the superior fidelity we all know.

Valdemar Poulsen



To understand completely the uses and operating techniques of your Ampex Series 354 Tape Transport, the basic theory of Magnetic Tape Recording should be emphasized at this time . . .

THEORY OF MAGNETIC TAPE RECORDING

If a material capable of being magnetized is placed in the proximity of a magnetic field the molecules of that material will be oriented according to the direction of the field. Any of several methods may be used to produce a magnetic field, but of most interest in magnetic recording is the field produced by a current flowing through a coil of wire. The current itself may be derived from a transducer such as a microphone which converts the mechanical energy of sound to electric current.

Magnetic recording tape consists of finely divided iron-oxide particles deposited upon a plastic backing. During the recording process this tape is moved through a magnetic field in which the magnetizing force is alternating, and the iron oxide particles are aligned according to the instantaneous direction and magnitude of the field.

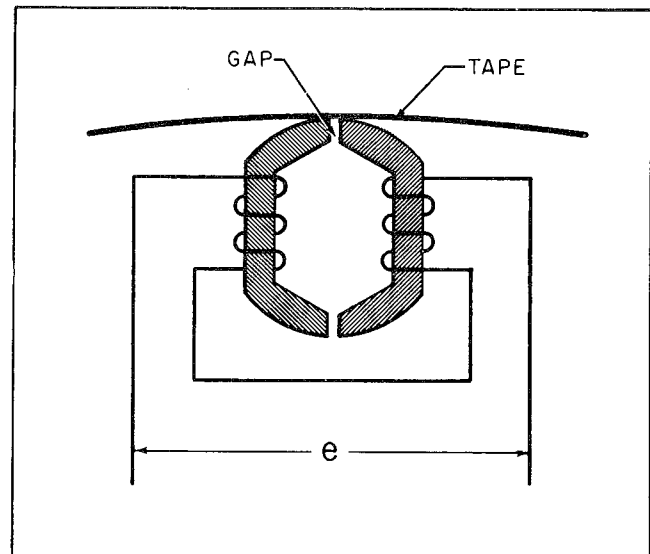

Record Head

The magnetization curve of the iron oxide used as the recording medium is similar to that shown as the heavy line in the illustration above.

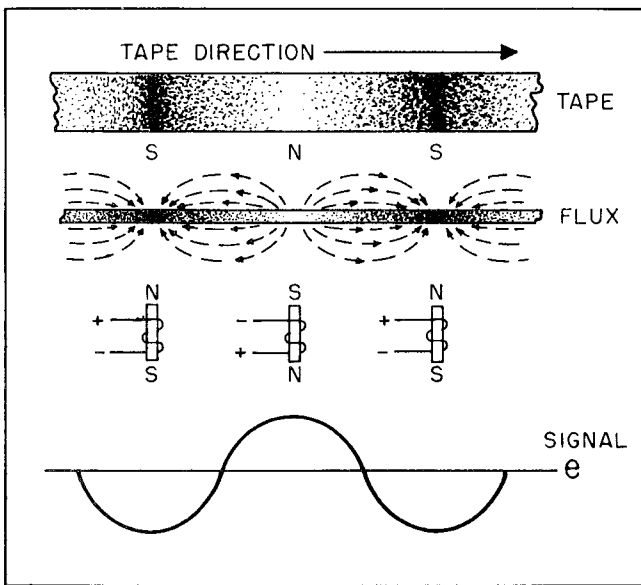

Magnetization of Tape

The magnetic field is produced in the gap of a recording head (which is essentially an electro-magnet) over which the recording tape passes. The head consists of an incomplete ring of highly permeable material inserted in a coil of wire. The discontinuity in the ring forms the gap, and the ring itself is the core of the electromagnet. The recording head and its gap thus constitute a series magnetic circuit.

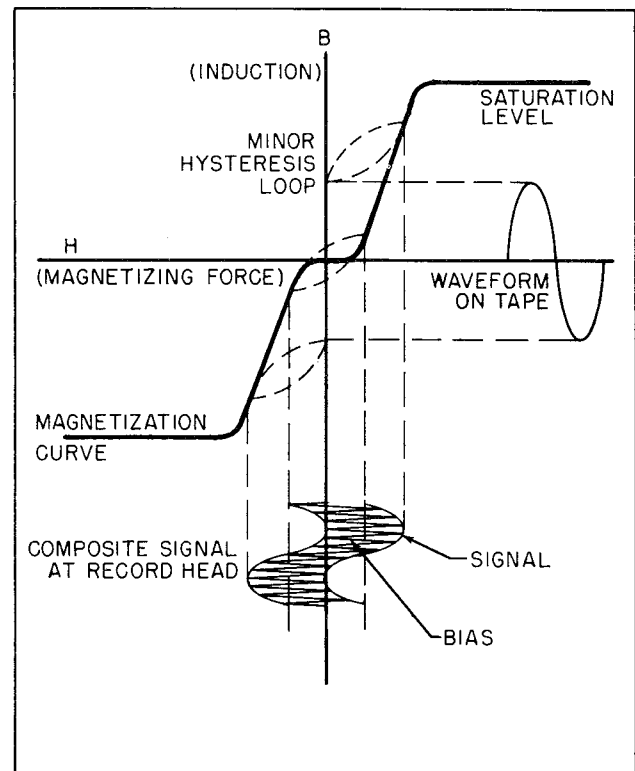

Recording medium magnetization curve

At points near the origin the curve is extremely non-linear and, without some corrective factor, the signal recorded on the tape would not be directly proportional to the signal applied to the head, resulting in a high degree of distortion when the tape was reproduced. This distortion is greatly reduced by mixing a high frequency, constant amplitude, bias signal with the actual signal being recorded, so that operation is obtained on the linear portion of the curve. This may be likened to applying a d-c bias to a tube to force it to work on the linear portion of its curve. The bias signal is generally selected to be at least five times the highest frequency to be recorded so that no beating will occur between the bias frequency and the harmonics of the recorded signal.

While the tape is in the recording gap the bias causes the magnetization characteristics of the iron oxide to follow the dashed line loops known as the "minor hysteresis loops." As the tape leaves the gap the influence of the magnetic field created by the bias is reduced to zero and the tape assumes a permanent state of magnetization (known as "remanent induction") determined by the gap influx at that time.

After the recording process there exists on the tape a flux pattern which is proportional in magnitude and direction to the signal recorded. If the tape is then moved past a reproduce head—which is similar in construction to the record head—the magnetic flux on the moving tape will induce a voltage in the coil of the reproduce head. This induced voltage is proportional to the number of turns of wire on the head and the rate of change of flux. This is expressed by the equation $E=N(d\phi/dt)$

Where

- E=induced voltage
- N=number of turns of wire
- $d\phi/dt$ =rate of change of flux

It is desirable that the gap in the reproduce head be as small as possible so it will intercept less than one wave length of the signal on the tape at the highest frequency to be reproduced. However, as the gap is made smaller the induced voltage decreases, so there is a practical limitation in decreasing the gap and still maintaining an adequate signal-to-noise ratio.

The voltage induced in the reproduce head during reproduction is computed by the equation $E=B_M V \text{SIN} \pi \omega / \lambda$

Where

- E=induced voltage
- B_M =maximum flux density of the recording material
- V=velocity of tape over the head
- ω =width of the gap
- λ =wavelength of the signal on the tape

From this equation it can be seen that the voltage across the coil increases directly as the velocity increases and as the wavelength decreases (frequency increases). If the tape velocity and gap width are assumed to be constant, the output voltage from the head is directly proportional to the frequency as long as the wavelength on the tape is large compared to the gap width. This results in an output vs. frequency characteristic such as is shown in curve A of the figure below.

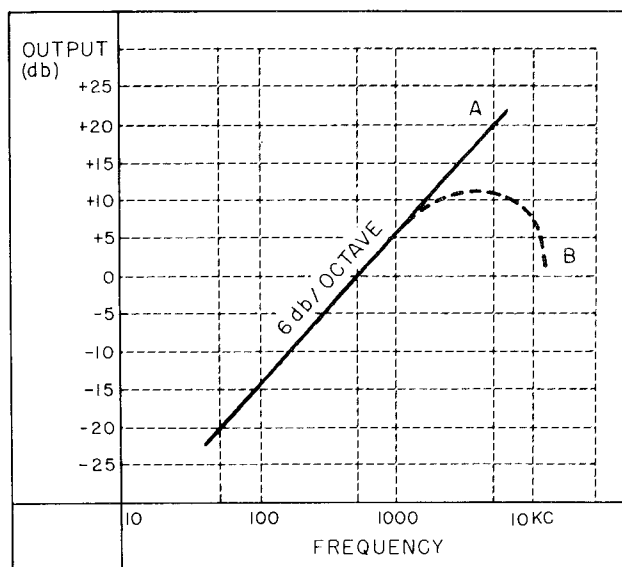

Reproduce head characteristics

The voltage does not continue to rise indefinitely. As electrical losses in the core material increase and as the wavelength on the tape approaches the same dimensions as the reproduce head gap, the actual output resembles curve B in the same figure.

In order to provide an over-all frequency response that is flat (see the figure below) an equalization circuit consisting of a series resistance and capacitance is inserted in one of the early stages of the reproduce amplifier. This equalizing circuit has a high-frequency droop characteristic (curve B) which is the inverse of

the reproduce head characteristic curve A of above figure. In order to extend the high frequency response, additional equalization is included in the record amplifier in the form of a high frequency boost circuit designed to compensate for the droop in record and reproduce head characteristics caused by core losses, self-demagnetization of the tape at the short wavelengths and the wave length approaching the gap dimensions.

Disregarding the response of the associated amplifiers, the physical aspects of maintaining constant tape speed and good head-to-tape contact, and core losses in the head—all of which can be placed at a high performance level by good engineering design—there are certain inherent properties which define the frequency limits in recording and reproducing information on a specific magnetic tape recorder-reproducer. While these properties can be varied to meet differing requirements, the over-all result represents a compromise arrangement in which frequency response, signal-to-noise, and distortion are interrelated.

In this respect the high frequency response is primarily limited by the dimension of the reproduce head gap, and the frequency at which the head resonates with the capacity in the circuit.

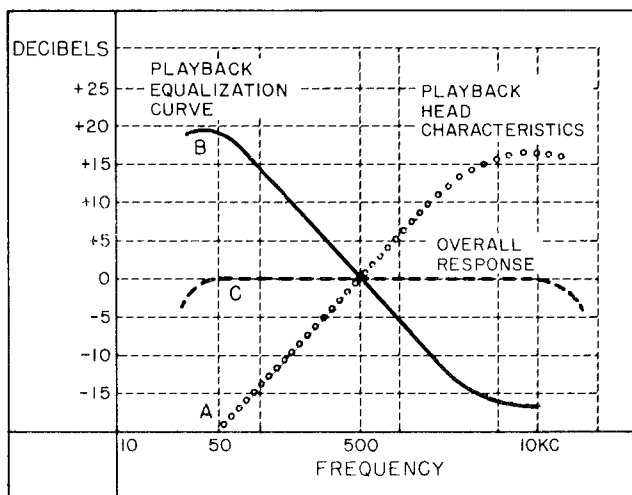

Achieving flat overall response

During the recording process the tape assumes a permanent state of magnetization as it leaves the head gap, thus the record head gap width is relatively uncritical. However,

in the reproduce mode the magnetic flux on the moving tape must induce a voltage differential across the reproduce head coil if a current is to flow in that coil. This induced voltage is attained as the flux travels through each branch of the head core, forced into that path by the high reluctance of the head gap. Therefore, an instantaneous difference in the magnitude of the moving flux must exist across the head gap to cause the flux to travel through the core and magnetically induce a voltage difference in the head winding.

When the recorded frequency rises to a degree where the reproduce head gap intercepts a complete wavelength of the signal (as it appears on the tape) there can be no difference in flux magnitude across the gap, and head output will reduce to zero. This cancellation effect will occur at multiples of the represented frequency, and for all practicable purposes the output is useless.

There are two means of counter-acting this "gap effect"—either the reproduce head gap width can be reduced or the record-reproduce tape speed can be increased. There are limitations in reducing the gap width and retaining adequate signal level and realistic manufacturing tolerances; as these limitations are reached any further extension of high frequency requirements must be accompanied by corresponding increases in record-reproduce tape speed. (In instrumentation applications it is also possible to record at a high tape speed and reproduce at a low tape speed, thus providing a signal expansion characteristic. For example, a 10 kc signal recorded at $7\frac{1}{2}$ ips, will reproduce as a 5 kc signal if the reproduce tape speed is $3\frac{3}{4}$ ips. This procedure of course cannot be used in standard audio applications where music or voice is recorded, and will result in the loss of the low frequency components of the signal.) Increasing the record-reproduce tape speed lengthens the wavelength of the signal as it appears on the tape, with the result that higher frequency wavelengths do not approach the gap dimension. (It also decreases the "self-demagnetizing" effect which occurs as the opposite poles of individual magnetic fields on the tape come closer and closer together.)

The resonant frequency of the inductance of the head coil and the capacitance—either actual or distributed—of its circuit must normally be

either outside the pass band of the system (so the drop in output following the point of resonance will not adversely effect the frequency response) or so placed at the extreme upper limit so that the increased output at the moment of resonance actually provides an extended response. When good engineering design has reduced circuit capacitance to an irreducible minimum, the only means of placing head resonance at a higher frequency is to reduce the inductance of the head coil by reducing the number of turns of wire. This adversely affects the output over the entire frequency range, and will particularly influence the low frequency limit.

Low frequency response is primarily determined by the relationship of the required signal-to-noise ratio, the characteristic curve of the reproduce head, the distortion which can be tolerated, and the bandwidth which must be recorded.

As previously explained the output of a reproduce head rises directly with frequency at an approximate 6 db per octave rate. Stated conversely, the reproduce head output drops directly with frequency at an approximate 6 db per octave rate. The low frequency limit is determined by how far this decreasing output can be tolerated while maintaining an adequate

signal-to-noise ratio. Thus, the noise generated by the associated electronic assemblies will have a definite effect on low frequency response. Increasing the record level to offset this decreasing output will eventually result in an increase in distortion.

Bandwidth is a determining factor in low frequency response because the 6 db per octave drop off in reproduce head output normally starts at the highest frequency which must be reproduced, and is constant regardless of tape speed. Thus as the upper frequency requirement is extended, the lower frequency limit—dictated by the required signal-to-noise ratio rises inexorably with it, octave for octave. A general rule is that the maximum bandwidth which can be effectively reproduced by any magnetic tape device is approximately ten octaves.

It should now be apparent that compromises are necessary in designing a magnetic tape recorder for a given purpose. If a high frequency requirement is imposed, then low frequency, signal-to-noise, or distortion must be limited (or perhaps a modulating-demodulating system employed which will effectively compress the bandpass requirements). Conversely, a low frequency requisite limits the high frequency response which can be obtained.

TAPE TRANSPORT MECHANISM

GENERAL

The tape transport mechanism provides tape motion for all modes of operation. Interaction of four basic assemblies and their associated components—the tape supply system, the tape take-up system, the tape drive system, and the control circuit—insures smooth, positive movement of the tape across the head assembly, and proper tape tension. All tape motion controls, a reel size selector, a safety microswitch and the head assembly are located on the tape transport.

TAPE SUPPLY AND TAKE-UP SYSTEMS

From the supply reel, on the left side of the tape transport as the operator faces the equipment, tape is delivered to the take-up reel when the PLAY or FAST FORWARD buttons are pressed, tape is rewound onto the supply reel when the REWIND button is pressed. Proper tape tensioning is maintained during all modes by means of two induction torque motors.

The reel idler assembly on the supply side of the tape transport is composed of a pulley, a spring-pivot-mounted arm and a flywheel for smoothing out transient speed variations in the supply turntable assembly.

On the take-up side of the tape transport, the tension arm assembly with a spring-pivot-mounted arm performs two main functions. The first function of this assembly is to provide a small tape storage loop which prevents tape breakage during the starting and stopping of tape motion. Secondly, this arm is used to stop

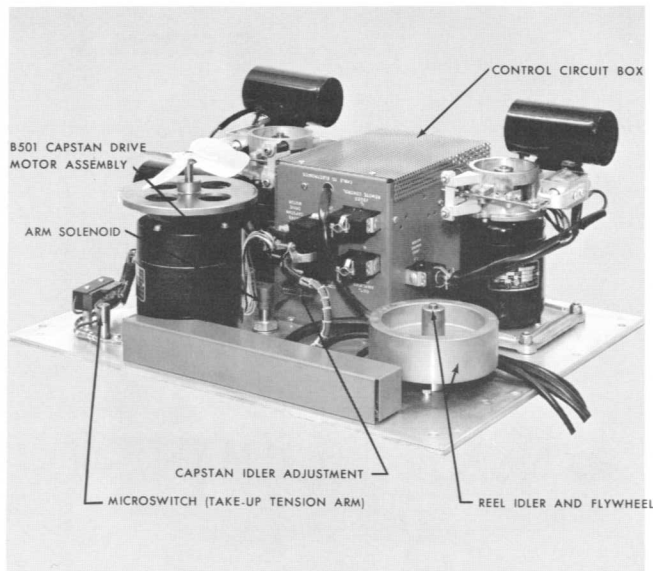

Component and assembly callouts

the machine if tension is lost due to tape breakage at the end of the tape or other failure. Near the base of the shaft on which the tension arm is mounted, a drive-lock pin actuates the safety switch (S501).

Both the tape supply and take-up assemblies are composed of induction torque motors (B503 supply-rewind, B502 take-up), a turntable mounted directly on each motor shaft, a brake housing assembly and a flange for mounting the entire assembly. Because the brake housings are mirror images of each other, these assemblies are not interchangeable although the motors are identical. The brakes are solenoid operated, remaining in the braking position until the brake solenoids K505 and K506 are energized at which time the brakes are released.

During all operating modes, the two induction torque motors B502 and B503 act as tensioning devices and in the fast forward and rewind modes the motors respond to the commands from either pushbutton by alternately operating each motor at maximum torque in the selected function.

The supply (rewind) and take-up induction torque motors are so connected that when power is applied with no tape threaded, the turntables, fixed to their shafts, will rotate in opposite directions. The tape supply turntable will rotate clockwise and the tape take-up turntable, counterclockwise.

Motor torque in the reproduce and record

modes is adjusted to equality by the tensioning adjustment resistors (R503 TAKE-UP and R503 HOLDBACK) in series with each motor. In the fast forward mode, the torque of the supply (rewind) motor is reduced considerably by introduction of a series resistance (R504). In the rewind mode, R504 is in series with the take-up motor. Basic tape tensioning operation is shown in the illustrations.

In the fast forward mode, the take-up motor operates at full torque, the supply motor at reduced torque, and the tape is pulled from the tape supply reel. Because the torque of the tape supply turntable motor (rewind motor) is applied in the opposite direction to the turntable rotation, the tape is held under continuous tension as it is pulled from the reel.

In the rewind mode, the supply motor operates at full torque and the take-up motor holds the tape under continuous tension by its opposite and reduced torque.

In the reproduce or record modes, both torque motors operate at the same value of reduced torque. The tape drive capstan and the capstan idler, between which the tape is clamped, then determines the tape speed, and the tensioning system supplies tape or takes it up as metered by the capstan drive.

From the point of view of the tape supply turntable, the capstan and idler action exerts sufficient pull on the tape to overcome the opposing torque of the supply motor, which constitutes the hold back tension. From the point

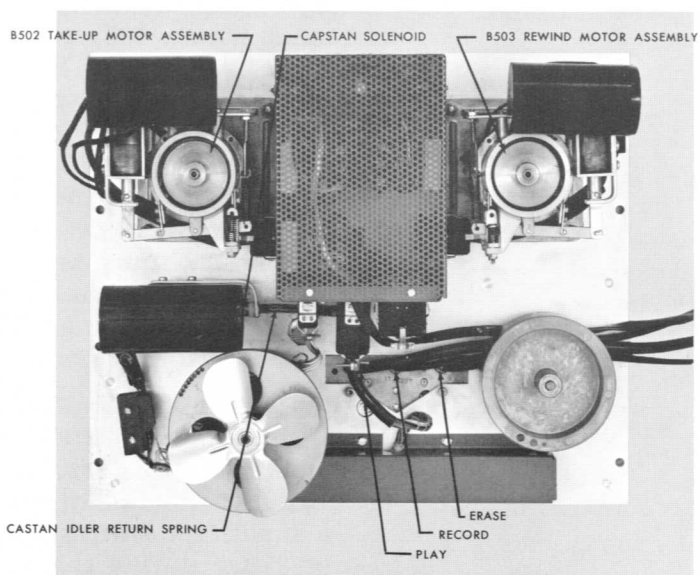

Component and assembly callouts

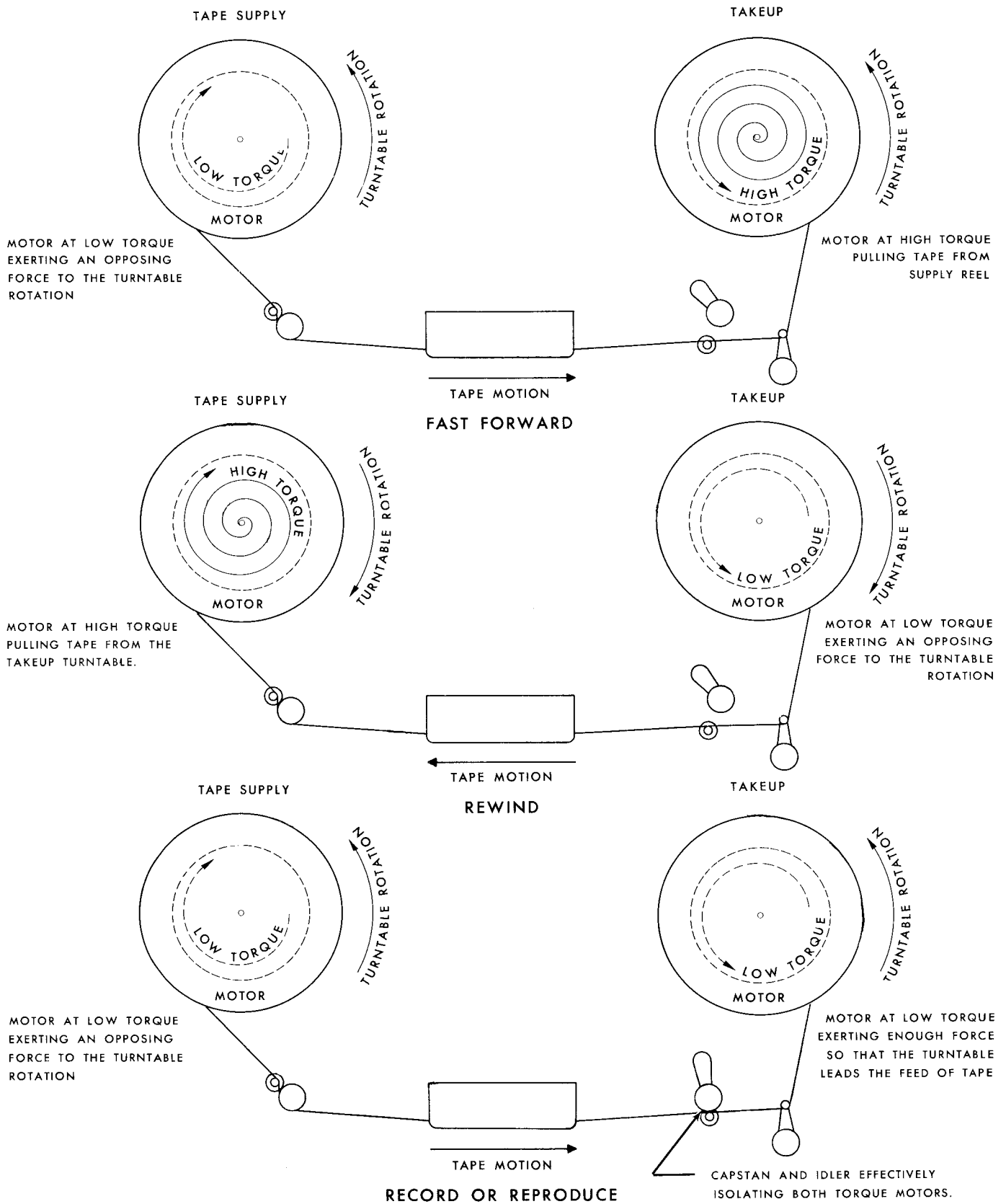

Tape tensioning

of view of the tape take-up turntable, the capstan and idler action is feeding the tape to it. The tape is held under tension here, because the take-up rate exceeds the feed rate (a tape loop will be thrown on the right side of the capstan whenever any malfunction causes the feed rate to exceed the take-up rate).

If a tape loop is thrown, or the tape breaks, the take-up tension arm will actuate the safety switch S501 and stop the equipment. The take-up tension arm is not a part of the tape tension system. Its function is to take up tape slack, especially when starting, and to operate the safety switch.

The reel idler assembly smooths out transients in the supply reel system. For example, when starting the tape in the reproduce mode, the momentary strain transmitted through the tape to the tape supply turntable when the capstan idler forces the tape against the capstan is considerable. Under some circumstances, this impulse tends to stretch or break the tape. A momentary decrease in holdback tension might be sufficient to start a transient oscillation in the tape tension system which would be reflected as a periodic variation in the distance of the tape from the heads. This variation might be of sufficient magnitude to appear as an undesirable fluctuation in the signal level at the start of recording or reproduction. The reel idler arm absorbs most of the starting strain, and prevents or minimizes this type of oscillation. The reel idler pulley and flywheel provide additional stability in the tape tension system, by smoothing out such transients as motor torque fluctuations and irregularities due to faulty tape wrap on the supply reel. This is accomplished because the high inertia of the reel idler pulley and flywheel effectively isolate the reel assembly from the heads.

TAPE DRIVE SYSTEM

The tape drive system is composed of the drive motor, the extended shaft of which forms the capstan, the capstan idler arm and idler, and the tape guides at the tape entrance and exit within the head assembly.

The purpose of the tape drive system is to transport the tape across the heads at a uniform speed during the record and reproduce processes. By means of a hysteresis synchron-

ous capstan drive motor (B501) and a capstan idler, the magnetic tape is driven at a constant speed after power has been applied to the equipment and the PLAY button is pressed. (The drive motor has two sets of windings to provide two tape speeds, either of which can be selected at TAPE SPEED toggle switch S503).

After the POWER switch at the electronic assembly has been placed in the ON position and the tape is threaded actuating the safety switch, the drive motor operates continuously, its capstan awaiting the PLAY command (the RECORD function is selected at the amplifier). When the PLAY button is pressed, the capstan solenoid (K501) and the brake solenoids (K505 and K506—releasing brake pressure) are energized. The capstan solenoid pulls the rubber tired capstan idler wheel, which is mounted on a swivel type arm, against the tape, causing the tape to make firm positive contact with the capstan. The tape is then driven at a constant speed across the head assembly.

BRAKE OPERATION

Smooth brake operation is extremely important in maintaining proper tape tension when stopping the tape. Because the holdback tension, supplied by the trailing turntable motor torque, is lost after the STOP button is pressed, maintenance of tape tension then becomes a function of brake operation. The braking force acting on the turntable from which the tape is being pulled (trailing turntable) in any of the modes of operation must exceed the braking force acting on the turntable taking up the tape (the leading turntable) to prevent tape loops forming.

One end of the brake band is fixed to the cross head by a roll pin and two socket head cap screws which is attached to the anchor mounted on the brake housing. The other end is linked to the brake lever by a drivelock pin and is free to move. When the brake solenoid is de-energized, the brake tension spring acting on the brake lever draws the brake band against the brake drum.

If the brake drum of the supply motor, as viewed from the brake housing end, is rotating clockwise when the brake band is applied, the frictional force will cause the band to wrap

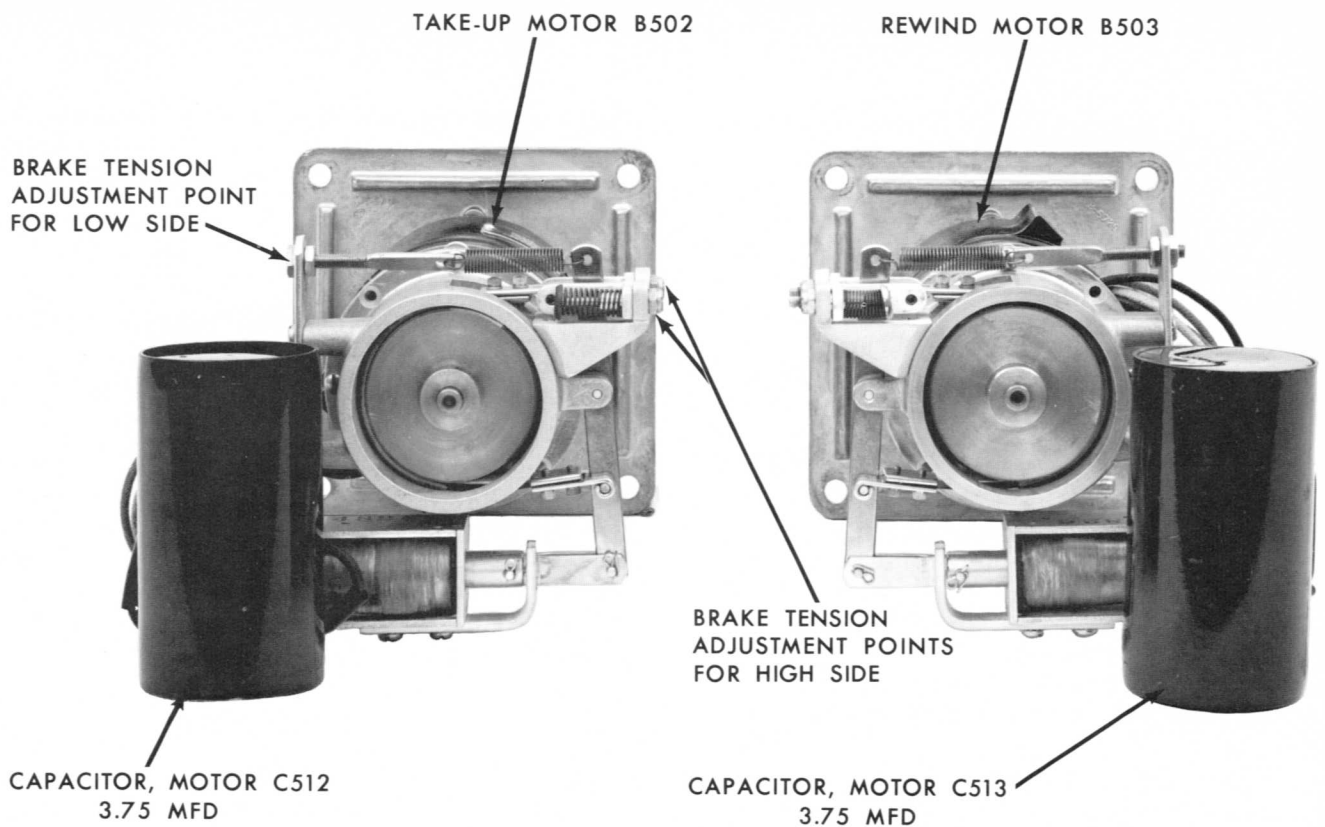

Take-up and rewind motor assemblies

itself tightly around the brake drum as the brake lever end of the band moves to the right, increasing braking force. When the drum is rotating counterclockwise, the process is reversed, causing the band to tend to pull away from the drum, decreasing the braking force.

The ratio of the braking force in one direction to the braking force in the other — the brake differential — is approximately two to one on this equipment.

In all modes of operation, the greater braking force always acts on the trailing turntable, maintaining the proper tape tension as the system is stopped.

CONTROL CIRCUIT

(Refer to schematic diagram—Tape Transport Control Circuits)

Located in the control circuit box underneath the tape transport are all relays, the tension adjustment resistors, and electronic components such as the capacitors and resistors shown in the foldout illustration, Tape Trans-

port Control Circuits, with the exception of the three motor starting capacitors, the capstan solenoid, the brake solenoids and the safety microswitch (which are mounted adjacent to the assemblies they serve).

On the outside of the control circuit box receptacles are available for cables from the drive motor, supply motor, take-up motor and control cluster. Female receptacles and plugs (cables not supplied) are also available for interconnecting the tape transport and accessory units such as remote control panels and a precision frequency source when furnished.

NOTE

The special connector jumper plugs supplied for receptacles J503S 60 CYCLE AMPLIFIER and J502S REMOTE CONTROL must be plugged into their receptacles when these accessory units are not used because jumpers in these plugs complete the necessary circuits in the system for proper operation.

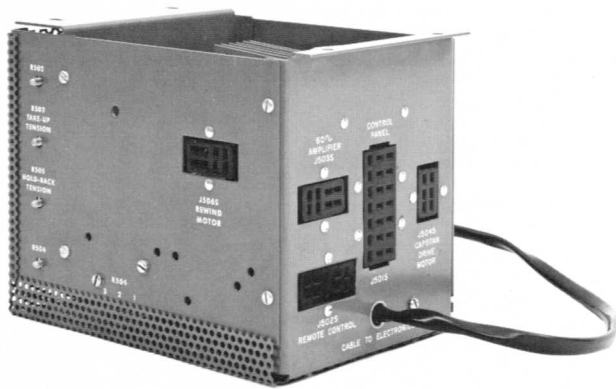

Control circuit box

All functional control of the tape transport, with one exception, takes place at the control circuit switch assembly comprising four push-buttons: REWIND, FAST FORWARD, STOP and PLAY. Two toggle switches REEL SIZE and TAPE SPEED are mounted at either end of the control cluster. The exception is the RECORD function which is controlled at the amplifier. The safety switch (not an operating control) is mounted under the tape transport.

Play

When PLAY button S505 is pressed, play relay K502 is energized. Capstan solenoid K501 is energized through K502-1. Contact sets K502-1, K503-1, K504-3, and the normally closed STOP button S502 form a holding circuit. Power is connected to the turntable reel motors through contact K502-2. Through contact K502-3, D.C. voltage is applied to the brake solenoids K505 and K506. The reel motors are powered and the brakes are released simultaneously, causing the equipment to operate in the reproduce mode at the speed selected by TAPE SPEED SWITCH S503.

Rewind

When REWIND button S507 is pressed, rewind relay K504 is energized and held in this condition by relay contact sets K504-1, K503-3 and the normally closed STOP button S502. Contact set K504-2 connects the full a-c power directly to the rewind (supply) motor, and places R504 in the a-c circuit to the take-up motor. The rewind motor thus operates at full torque and the take-up motor at reduced torque, and tape is pulled at a maximum speed from

the take-up to the rewind reel. Contact set K504-3 completes the d-c circuit to the brake solenoids at each reel assembly, thus releasing the brakes.

Fast Forward

When FAST FORWARD button S506 is pressed, fast forward relay K503 is energized and held through contacts K503-1, K504-3 and the normally closed STOP button S502. Contact set K503-2 connects the full a-c power to the take-up motor, and places R504 in the circuit to the rewind motor. The take-up motor now operates at full torque and the rewind motor at reduced torque, causing the tape to be pulled at a maximum speed from the rewind to the take-up reel.

Stop

When the tape is moving in any mode and the STOP button (S502) is pressed, the brake solenoids and all relays are de-energized. The brakes are applied to both turntable motors. The capstan drive motor will continue to operate so long as the tape remains properly threaded.

NOTE

The record mode is not a tape motion control function, but it is interlocked and dependent on the PLAY button, which must be pressed before the record mode can be energized at the amplifier.

Safety Interlocks

When the tape is moving in either of the high speed modes (fast forward or rewind) it is impossible to switch to the play mode without first pushing the STOP button. In fast forward, contact K503-1 interlocks the play relay and capstan solenoid. In rewind, K504-3 is the interlock.

CAUTION

If the STOP and PLAY buttons are pressed in too rapid a sequence when the tape is in either fast winding mode, tape will almost invariably be broken or deformed. Always allow

time for the tape to stop completely when switching from either of the fast modes to play.

Reel Size Switch

Selection of proper holdback tension, depending on reel hub size, is made at the two position toggle switch labeled LARGE-SMALL. Holdback tension is not a constant in any mode of operation, varying directly as a function of the trailing turntable motor torque, and inversely as a function of the effective trailing reel hub diameter (hub meter includes the tape wound on the hub). For a given torque on the trailing motor, the holdback tension will increase as the effective hub diameter of the trailing reel decreases. Reducing the torque on the trailing turntable motor will decrease the holdback tension.

The holdback tension resistors for adjustment of take-up and rewind motor torques are factory-set for NAB 10½ inch reels. If the smaller (7 or 5 inch) EIA (formerly RETMA) reels are used, compensation for the overall increase in holdback tension must be made by placing the switch in the SMALL position. This places resistor R502 in series with the take-up and rewind motors, thus reducing the torque of both motors in any mode of operation when the EIA reels are used. If it is desired to accelerate faster in the rewind or fast forward modes, the switch may be placed in the LARGE position during these modes. The REEL SIZE switch is a SPST switch placed across the resistor R502. It is closed when the LARGE position for 10½ inch diameter NAB is selected; and open (resistor R502 in the torque motor circuits) when the SMALL position is selected.

NOTE

In the LARGE reel position both the rewind and take-up reels must be NAB type and in the SMALL reel position both reels must be EIA.

NOTE

The Catalog Number 5700 tape transports used on earlier models changed PLAY tension only when in the SMALL reel position.

ROUTINE MAINTENANCE

Carefully follow the routine maintenance program outlined below if proper performance is to be expected of the equipment at all times. It is recommended that an Operation and Maintenance Log be kept.

Cleaning

Clean the capstan, the head faces and tape guides daily. Clean the capstan idler wheel weekly. Great care must be taken to see that oil does not reach the rubber tire. Avoid, as much as possible, touching the tire with the fingers.

The agent for cleaning Ampex head assemblies is a mixture of Xylene and 0.1% Aerosol, and is available in 4 oz. bottles (Ampex Catalog No. 087-007). Other solvents can have detrimental effects on these precision parts.

To clean any head assembly, wind a clean, lintless cloth on a wooden swab-stick and moisten with this mixture. Swab the heads periodically to remove all dirt and accumulated oxide deposited from some tapes.

CAUTION

Do not use any other solvents as there are some which may damage the laminations of the head assembly. Do not use metal swab-sticks.

Cleanliness of all parts of the tape drive mechanism is required for consistent optimum performance. Clean all parts except the head assembly using a lintless cloth moistened with Iso-Propyl alcohol (easily obtained). This cleaning is of particular importance because most tape manufacturers lubricate their tapes, and the lubricant will gradually form a coating on the components in the tape threading path which will result in a loss of positive drive at the capstan, flutter and wow, drop-outs or poor high frequency response.

NOTE

It is imperative that Iso-Propyl alcohol be used on the cleaning of the capstan idler wheel (rubber) and not the recommended Xylene cleaner for heads.

Lubrication

The following parts of the tape transport mechanism require lubrication every three months, or after every thousand hours of operation, whichever occurs first.

CAPSTAN DRIVE MOTOR LUBRICATION

Lubricate the upper sleeve bearing of the capstan drive motor with this oil or its equivalent:

Caloil OC-11 (Ampex Catalog Number 087-005) Standard Oil Company, San Francisco, California. Class "C"

Medium turbine oil, petroleum base with inhibitor additives to increase oxidization and corrosion preventive properties. Essential characteristics are as follows:

<i>Characteristics</i>	<i>Required (Limit)</i>
Viscosity in Centistokes at 130° F	40.0-48.0
Pour Point	25° F (Max.)
Flash Point	370° F (Min.) ±20° F

There are two ways to lubricate the drive motor, the first of which requires its removal. The second, and simpler method, does not require removal of the motor. See alternate method. To remove the drive motor proceed as follows:

- Step 1:* Unplug the motor connector P504P from its receptacle J504S at the control circuit box.
- Step 2:* Remove the capstan idler by loosening the Allen head screw on the idler arm and gently pulling the idler assembly away (the capstan idler must be removed because one of the mounting screws is beneath it).
- Step 3:* Support the motor in one hand and remove the four mounting screws that hold it to the tape transport.
- Step 4:* Now pull the motor free.
- Step 5:* Locate the oil hole which will be on the top or the side of the motor end bell.
- Step 6:* Place not more than four drops of a recommended lubricant in the oil hole (OC-11).

CAUTION

Do not over-lubricate. Wipe off excess oil.

- Step 7:* Replace the motor.
- Step 8:* Replace the capstan idler.

CAUTION

The capstan idler must be properly placed in relation to the tape. Thread tape on the equipment along the prescribed tape thread-path, and set the idler so that the tape travel is centered on the tire. Placement is not critical and visual alignment is adequate.

- Step 9:* Readjust the capstan idler pressure if necessary (see *Capstan Idler Pressure*).

The alternate method for drive motor lubrication is:

- Step 1:* Gently pry up and remove the capstan dust cap.
- Step 2:* Before activating the safety switch, apply not more than four drops of lubricant (OC-11) to the exposed bearing surface.
- Step 3:* Replace the capstan dust cap.
- Step 4:* Start the drive motor by placing the POWER switch in the ON position, activate the safety switch and allow the motor to warm up (requires about 15 minutes).
- Step 5:* Turn off the equipment when the warm-up period is complete.
- Step 6:* If the bearing appears dry after the motor has cooled, repeat the above procedure.
- Step 7:* Wipe the capstan dry of any excess oil that may have been applied accidentally.

CAPSTAN IDLER LUBRICATION

Gently pry the dust cap from the wheel hub (a knife blade can be used) and oil with not more than 3 drops of OC-11, on the felt washer. Failure to perform capstan idler lubrication can result in the felt washer becoming completely dry, and a dragging idler can contribute to flutter.

CAUTION

DO NOT OVER-LUBRICATE or the wheel will throw oil in operation. If oil spills on the rubber tire, clean it immediately with Iso-Propyl. Oil will deteriorate the rubber wheel.

NOTE

The reel idler assembly, the take-up tension arm assembly and the take-up and rewind motors contain permanently lubricated bearings, and require no lubrication.

Head Demagnetization

Occasionally, the heads may become permanently magnetized through electrical faults in the amplifiers, improper use of the equipment, or by contact with magnetized objects. Magnetized heads may cause an increase of 5 to 10 db in background noise level, and can impair good recordings by partially erasing high frequencies. The full dynamic range of the equipment cannot be realized if the heads are magnetized.

Any phenomena that tend to put large unbalanced pulses through the record head will magnetize it. Observe these precautions and no difficulty should be experienced. Do not remove any tube from the record amplifier while the equipment is recording. Do not connect or disconnect the input leads or the head leads while recording.



Demagnetizing the heads

Do not saturate the record amplifiers with abnormally high input signals. Such signals would be 10 db greater than tape saturation or approximately 30 db greater than normal operating level.

If it becomes necessary to test the heads with an ohmmeter, they must be demagnetized afterwards.

If the heads become magnetized, proceed as follows, using an Ampex Demagnetizer, Catalog No. 704:

- Step 1: Place the equipment power switch in the OFF position.
- Step 2: Plug the demagnetizer into a 117-volt a-c source.

NOTE

If the plastic coating wears off, place one layer of electrical friction tape on the demagnetizer tips. Scratching the heads will then be prevented.

- Step 3: Bring the tips of the demagnetizer to within approximately $\frac{1}{8}$ -inch (if the demagnetizer tips are taped or covered, contact with the heads can be made) of the record head core stack, straddle the head gap and draw the demagnetizer tips up and down the length of the core stack three or four times.
- Step 4: Remove the demagnetizer slowly from the head stack to a distance of 3 or 4 feet, thus allowing its a-c field to diminish gradually. This slow removal is extremely important.

CAUTION

Do not unplug the demagnetizer while it is near the heads; the collapse of its magnetic field may re-magnetize the head.

- Step 5: Repeat Steps 3 and 4 at the reproduce and erase heads.
- Step 6: If necessary, repeat the process till complete demagnetization is effected in each case.

NOTE

The erase head, under certain conditions, is susceptible to magnetization by spurious sources and can require demagnetization.

If the capstan, tape guides or other metal parts become magnetized, a few passes of the demagnetizer along their lengths and the slow withdrawing technique should be adequate.

ADJUSTMENTS

The mechanical assembly is shipped from the factory with all adjustments set for correct performance. It should be unnecessary to change any adjustment before putting the equipment into service, unless shipping damage has occurred. In the course of wear in normal service, or in the event of component failure, and replacement of parts, some readjustments may be necessary.

Equipment Required:

- Spring Scale 0-16 oz.
- Spring Scale 0-80 oz.
- 3/8-inch Nut Driver
- 3/16-inch Screwdriver
- Nylon Lacing Twine or Strong String
- 7/16-inch Socket Wrench
- 5/64-inch Allen Wrench

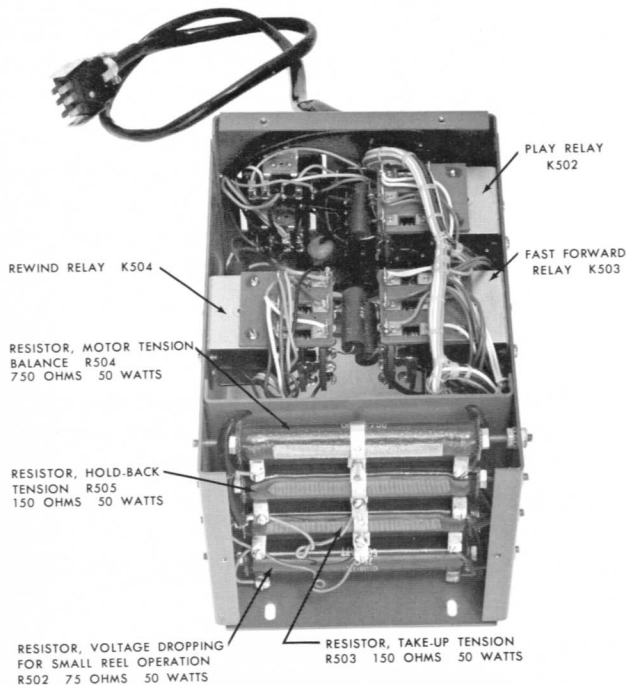

Control circuit box callouts

Take-up and Supply (Rewind) Tension

Take-up and supply tensions are determined by the positioning of the sliders on resistors R503 and R505 located in the tape transport control circuit box. The torque of both the rewind and take-up motors must be adjusted to between 5½ and 6 ounces as read on the 16 oz. spring scale at NAB reel hub diameter. Checking techniques are not difficult and should be performed carefully.

- Step 1: Place an empty 10½ inch NAB reel on the tape supply turntable.
- Step 2: Place the POWER switch in the ON position.
- Step 3: Place the REEL SIZE switch in the LARGE position.
- Step 4: Hold the take-up tension arm so that the safety switch is activated (a rubber band or piece of masking tape will hold the arm as though tape were threaded on the equipment).
- Step 5: Make small loops at both ends of a thirty inch piece of nylon lacing twine.
- Step 6: Attach one loop to the tape anchor on the reel hub and the other to a 0 to 16 oz. spring scale.
- Step 7: Press the PLAY button and allow the clockwise motion of the supply reel (torque motor tension) to draw a turn of twine onto the hub.
- Step 8: Make certain that the twine is now parallel to the plane of the top of the tape transport and that the twine is centered and not touching either reel flange.
- Step 9: Now, let the torque motor pull the twine slowly onto the hub by following the torque motor force with the scale.
- Step 10: Using this "following" technique, observe the readings on the scale until a constant reading is obtained.
- Step 11: If necessary, adjust the slide on resistor R505 in the control circuit box until a scale reading between 5½ and 6 ounces is achieved.
- Step 12: A good check consists in placing the REEL SIZE switch in the SMALL position, then checking the torque using the same procedure as above. The

scale should indicate tape tension as 1½-3 ounces.

Step 13: Use the procedures in the preceding steps to check and adjust the take-up tension which is set at R503 (note that the reel on this side will move counterclockwise).

Brake Adjustment

Brake adjustment is made (*with no power applied to the equipment*) at the point shown in the illustration.

Step 1: Place an empty 10½ NAB reel on the tape supply turntable.

Step 2: Make small loops at both ends of a thirty inch piece of nylon lacing twine.

Step 3: Attach one loop to the tape anchor on the reel hub and the other to a 0-16 oz. spring scale.

Step 4: Manually rotate the reel clockwise to wind several turns of twine onto the hub.

Step 5: Pull the scale, making certain that the twine does not touch either flange of the reel. The turntable will rotate counterclockwise. Take a reading only when the turntable is in steady motion, because the force required to overcome the static friction will produce a false and excessively high initial reading.

Step 6: Adjust the supply and takeup motors' brakes for scale readings listed below. Points of adjustment are shown by illustration.

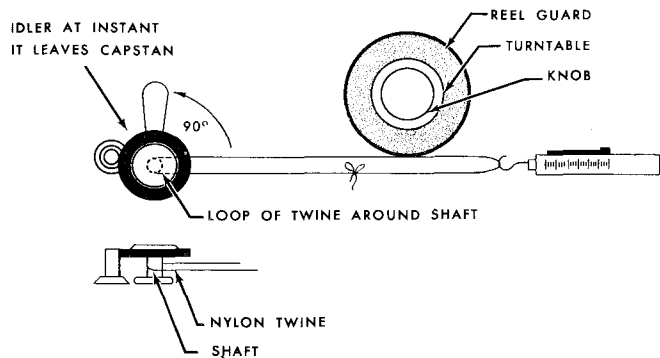

Capstan idler pressure measurement

Step 7: Now wind the twine on the hub by rotating the reel counterclockwise; pull, and take a reading. The turntable will rotate clockwise.

Step 8: Repeat the entire process on the take-up turntable.

SPRING SCALE READING

Tape Width	Direction of Most Resistance—Supply	Direction of Least Resistance—Supply
	Counterclockwise Takeup	Clockwise—Takeup Counterclockwise
¼ inch	15 to 16 ounces	2:1 ratio ±1 ounce in accordance with High Side

Capstan Idler Pressure

The capstan idler is forced against the capstan by the action of capstan solenoid K501. Idler pressure is supplied by the capstan idler pressure spring, and is adjusted by a lock nut on the capstan solenoid spade bolt. See the illustration. Tightening the lock nut increases idler pressure until a point is reached where the solenoid will not bottom. At this point, idler pressure drops to a value which is inadequate to permit the capstan to drive the tape, and slippage will occur unless the nut is backed off. Excessive pressure also throws an unnecessary load on the upper sleeve bearing of the drive motor. The recommended procedure for adjusting idler pressure is as follows:

Step 1: Hold the take-up arm so that the safety switch is activated.

Step 2: With the POWER switch in the ON position, press the PLAY button, and note whether the capstan solenoid is bottomed. (The capstan idler can be pushed off the capstan easily by pushing on the idler arm, if the solenoid is not bottomed). If necessary, back off the lock nut until the solenoid does bottom at 90 volts a-c when cold, or 105 volts when warm (after ½ hour running). The pressure ("dig") against the capstan shaft should be approximately 5 pounds.

NOTE

In the course of normal operation in the reproduce or record modes, the

temperature of the capstan solenoid will rise, and its d-c resistance will increase. Therefore, the minimum line voltage required to bottom the solenoid when it is hot will be greater than that required when it is cold. If the equipment is operating on unusually low line voltage (below 100 to 105v), sometimes encountered in areas where regulation is poor, the solenoid may fail to bottom after it has reached normal operating temperature. It is advisable, therefore, to allow the equipment to operate in the reproduce mode for about half an hour before making any necessary solenoid adjustments. This will allow the widest margin of safety with respect to line voltage variations. The solenoid is factory-adjusted to bottom at 90 line volts cold and 105 line volts hot.

- Step 3:** If it is desired to measure capstan dig, press the STOP button at this point and select a piece of nylon lacing twine about 30 inches long and tie the ends together.
- Step 4:** Slip the twine loop just formed between the idler and idler arm so that the nylon rests against the idler shaft.
- Step 5:** Attach the other side of the loop to a 0 to 80 oz. scale, letting the nylon twine remain slack.
- Step 6:** Press the PLAY pushbutton, causing the capstan idler to clamp against the capstan.
- Step 7:** Pull the scale away so that the nylon twine is taut and makes a 90 degree angle with the idler arm.
- Step 8:** Now, slowly pull the scale away with sufficient power to cause the capstan idler to leave the capstan, reading the scale at the instant the capstan idler leaves the capstan. The scale reading should be 5 lbs \pm 1/2 lb. If necessary, adjust the capstan dig at the point shown in the illustration.

Replacement of Parts

All sub-assemblies of the tape transport mechanism can be easily dismantled with the use of a screwdriver and a few small socket-head screw keys.

CAUTION

Do not attempt complete disassembly of any of the sub-assemblies. The list of individually replaceable parts under each assembly listing in the parts list should be used as a guide to disassembly limits. Replacement of parts other than those listed calls for precision work which should not be attempted in the field. Assemblies with defects in parts other than those listed as replaceable should be returned to the factory or to an Ampex Authorized Service Center for repair or replacement.

Write the Service Department for a proper authorized equipment return tag. Do NOT ship unidentified parts to factory; Ampex can assume no responsibility for their proper care or return under such circumstances.

BRAKE BAND REPLACEMENT

NOTE

Brake Bands may be replaced without removing motor from tape transport on rackmount machines and deleting the first three steps.

The most convenient method for changing the brake band is first to remove the entire motor assembly.

- Step 1:** With a 7/16-inch socket wrench remove the four mounting nuts and washers at the motor mounting plate, carefully holding the motor with one hand to prevent it from falling. The turntable will remain attached to the motor assembly.
- Step 2:** Take the motor to a convenient work area.
- Step 3:** Unhook the brake tension spring from the brake lever.
- Step 4:** Remove the two screws holding the capacitor. Disconnect the capacitor wires at the knife disconnects and free the capacitor from the bracket.

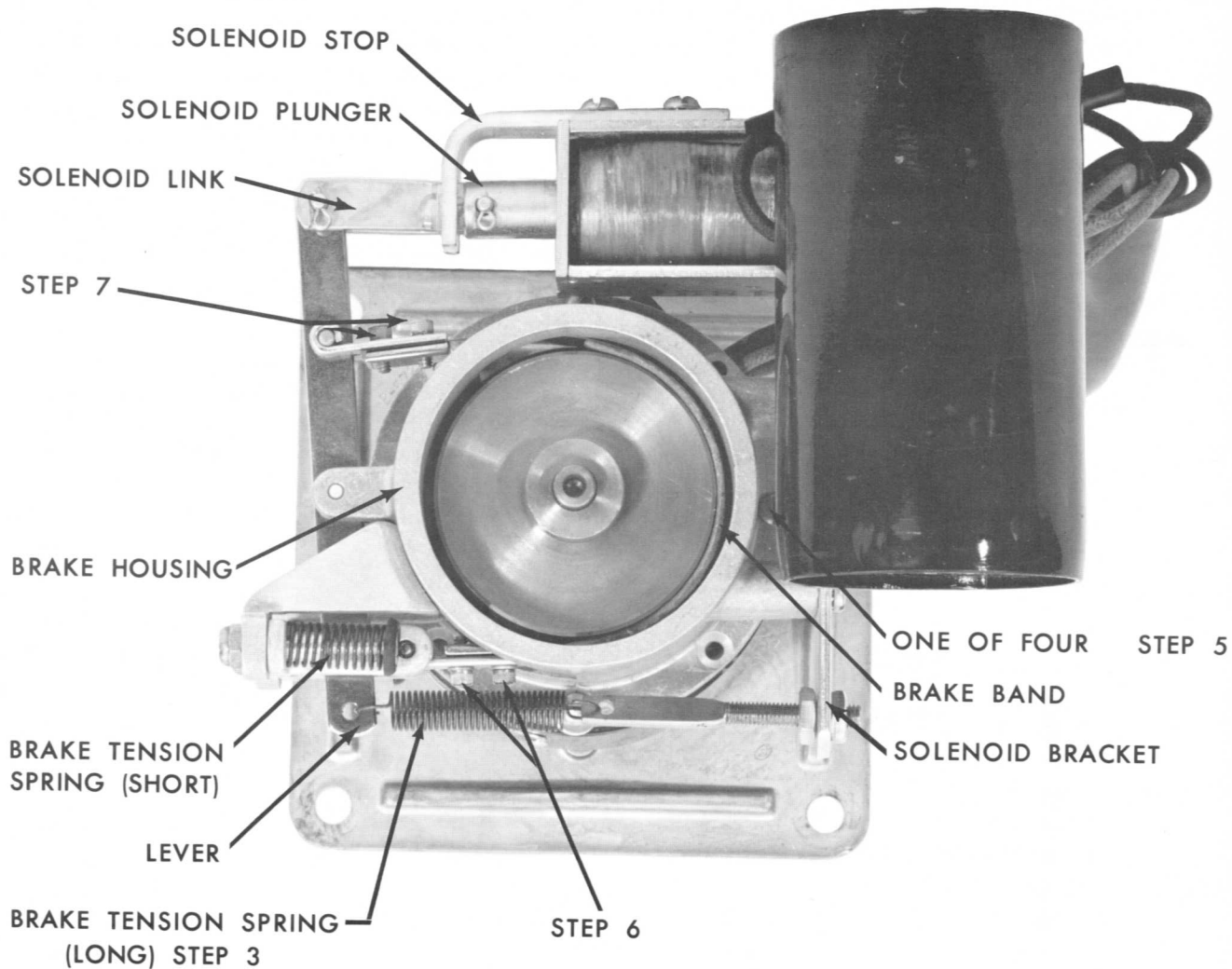

Brake band replacement

- Step 5:* Remove the screws that hold the brake housing to the motor, noting the positioning of the washers, and spacers, and remove the entire housing.
- Step 6:* Remove the two cap screws holding one end of the brake band between the brake lever spring and the housing using a 5/64-inch Allen wrench.
- Step 7:* Loosen (do not remove) the two cap screws at the end of the brake band next to the solenoid.
- Step 8:* The brake band may now be removed taking caution not to lose the band leaf on the solenoid side. There is only one band leaf per assembly.

- Step 9:* Position the new brake band through the hole in the housing and place between the clamp and tighten the two cap screws loosened in Step 8.
- Step 10:* Replace the brake housing, making certain that the spacers, the housing, the washers and the screws are replaced in that order, and tighten the screws.
- Step 11:* Insert the brake band between the band link and band link clamp. Replace the two cap screws but **DO NOT TIGHTEN**.
- Step 12:* Push the solenoid in until it bottoms. Adjust the depth of insertion of the brake band between the link and

clamp so that the brake drum rotates freely with no drag; then tighten the screws.

CAUTION

If the band is set too far forward in the link, it will buckle slightly when the solenoid plunger is bottomed by hand. If this condition exists the plunger may not bottom when the solenoid is energized. The purpose of the band leaf is to keep the band from splitting when it buckles at the band clamp.

Step 13: Interconnect the wires at the knife disconnects and replace the capacitor to the bracket with the two screws

removed in Step 5.

Step 14: Hook the brake spring to the brake lever. Step 4.

Step 15: Replace the motor assembly tightening the four screws that were removed in Step 1.

PACKING PRECAUTIONS FOR MOTORS

In packing motors for return to the factory, take particular care to prevent the bending of their shafts in transit.

REMOTE CONTROL

NOTE

Pin 5 of the tape transport is connected to pin 4 of the slave electronics by means of an internal connection in cable number 30812.

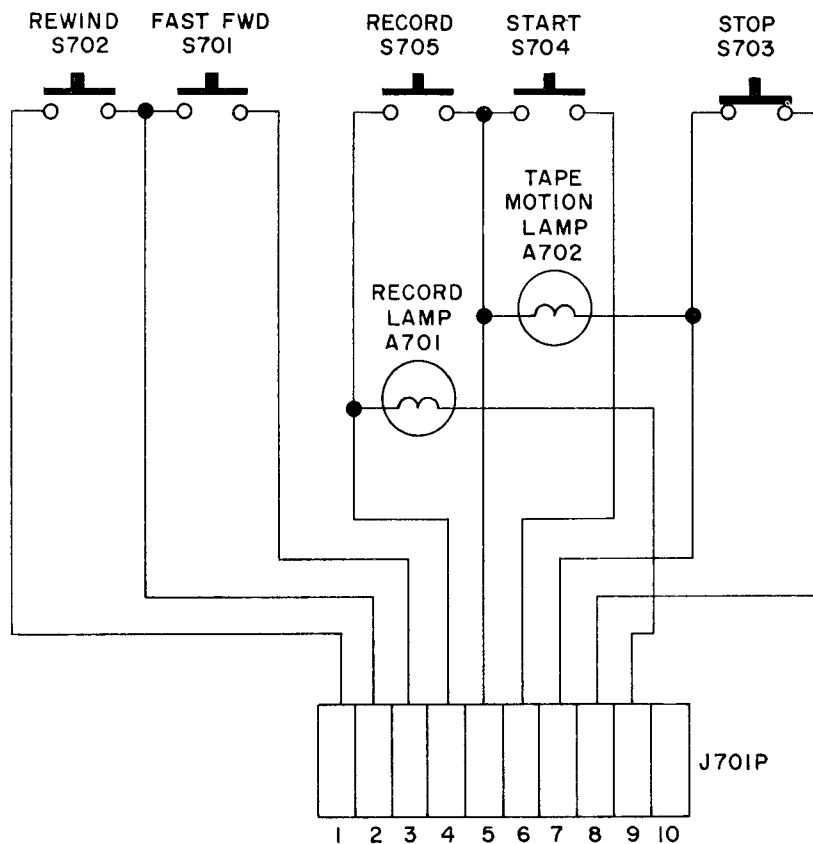

Remote control

REF. NO.	PART DESCRIPTION	AMPEX PART NO.
----------	------------------	----------------

TAPE TRANSPORT MECHANISM

B501	DRIVE MOTOR ASSEMBLY	
	7-1/2 - 15 ips, 60 cycle motor	31210-01
	7-1/2 - 15 ips, 50 cycle motor	31210-02
	3-3/4 - 7-1/2 ips, 60 cycle motor	31210-04
	3-3/4 - 7-1/2 ips, 50 cycle motor	31210-03
	Each includes:	
C501	Capacitor	9487-02
	Flywheel - Bodine motor	981
	Ashland motor	2212
	Set screw, 10-32 x 1/4	477-118
	Plug, 6-contact, Jones	145-012
	 FAN	
B502	TAKEUP ASSEMBLY	9451-03
	(Alternate)	9451-04
	Turntable Motor Assembly	7558
	includes motor, mounting flange, brake drum and turntable with pad.	
	Turntable	61462-01
	Pad	958-00
C512	Capacitor 3.75 mfd (60 cycle)	035-111
	Brake Assembly, complete	17327-01
	Brake Housing	17614-01
	Brake Band	17612-01
	Brake Band Leaf, 1-1/8" long	61460-01
	Brake Tension Spring long	322-01
	Brake Tension Spring short	17323-00
	Eye Bolt	396-06
	Crosshead	17324-01
	Anchor	17322-01
	Spacer	406-031
	Roll Pin - 1/8 inch x 3/4 inch	406-031
	Screw, Socket head cpa stl. cad. pl.	470-008
	Brake Band Link	330-00
	Brake Band Clamp	331-00
	Brake Lever	332-00
	Drivelock Pin - 1/8 inch x 1/2 inch	403-008
	Cotter - 1/16 inch x 1/2 inch	401-005
	Clevis Pin - 1/8 inch x 9/32 inch	400-002
	Plug, 8-contact, Jones	17313-01
K505-K506	Brake Solenoid	337
B503	REWIND ASSEMBLY (60 cycle)	9452-03, 04
	(50 cycle)	9452-05
	Turntable Motor Assembly	
	includes motor, mounting flange, brake drum and turntable with pad.	
	Turntable	61462-01
	Pad	958-00
C513	Capacitor 3.75 mfd. (60 cycle)	035-111
	Capacitor 5 mfd. (50 cycle)	035-117

REF. NO.	PART DESCRIPTION	AMPEX PART NO.
	Brake Assembly, complete	17327-02
	Brake Housing	17614-02
	Brake Band	17612-01
	Brake Band Leaf, 1-1/8" long	61480-01
	Brake Tension Spring long	322-00
	Brake Tension Spring short	17323-01
	Plug, 8-contact, Jones	17313-01
	Brake Solenoid	337
	TAKEUP TENSION ARM ASSEMBLY	425-0
	Individually replaceable parts:	
	Takeup Tension Arm Spring	30546-01
	Tape Guide	675-00
	Tape Guide Hook	355-00
	REEL IDLER ASSEMBLY, with arm and guide, but without flywheel.	
	For 7-1/2 - 15 ips machine	4459-00
	For 3-3/4 - 7-1/2 ips machine	4459-03
	Tape Guide	257-00
	Pulley Assembly (7-1/2 - 15 ips)	5893-00
	Pulley Assembly (3-3/4 - 7-1/2 ips)	5893-01
	Reel Idler Flywheel	636-01
	CAPSTAN IDLER WHEEL ASSEMBLY	
	For 7-1/2 - 15 ips machine	30945-01
	For 3-3/4 - 7-1/2 ips machine	6092-01
	Capstan Idler Arm	372-01
	Capstan Idler Arm Bushing	5755-00
	Capstan Dust Cap	
	For 7-1/2 - 15 ips machine	3506-00
	For 3-3/4 - 7-1/2 ips machine	3506-01
	Individually replaceable parts:	
	Felt Washer	3583-02
	Retaining Ring	432-007
	CAPSTAN IDLER SOLENOID ASSEMBLY	5783-01
	Individually replaceable parts:	
K501	Capstan solenoid	670-00
	Capstan solenoid eye-bolt	306-03
	Capstan solenoid stop	388-00
	Capstan solenoid felt washer 1/4" thick	503-015
	1/8" thick	503-017
	Capstan solenoid pressure spring	389-00
	Capstan solenoid return spring	400-00
	PUSHBUTTON GUARDS	361-00
	REEL GUARD	5708-00
	SWITCH HARNESS ASSEMBLY	5782-01
	Individually replaceable parts:	
	Connector, plug: Male, 21-contact	145-022
	Microswitch, safety switch assy, SPST, normally open	6582-00
	Microswitch shield	5730-00
	PUSHBUTTON SWITCHES:	
	Step (SPST)	120-014
	Play, fast forward, rewind, normally open	120-013

REF. NO.	PART DESCRIPTION	AMPEX PART NO.
----------	------------------	----------------

TOGGLE SWITCHES

	Tape Speed (DPST)	120-004
	Reel Size (SPST) LG Shank	120-005
	TOP PLATE CONTROL BOX ASSEMBLY	5700-03
	Individually replaceable parts:	
	Chassis cover	5739-01
P502P	Connector, Plug: Male 10 contacts (Remote Dummy)	3461-00
P503P	Connector, Plug: Male 8 contacts (60 Cycle Dummy)	567-01

ORDER BY AMPEX CATALOG NUMBER

CONTROL CIRCUIT ASSEMBLY

Catalog No. 5703-03

C502	CAPACITOR, fixed: electrolytic tubular, 150 uf, 150 vdcw; Cornel Dubilier Part No. 15015	031-045
C503	CAPACITOR, fixed: metallized tubular, axial leads, .05 uf, $\pm 20\%$, 400 vdcw; Astron Part No. ML-4-05	033-006
C504	CAPACITOR, fixed: metallized tubular, axial leads, .25 uf, $\pm 20\%$, 400 vdcw; Astron Part No. ML-4-25	033-008
C505	Same as C503	033-006
C506	Same as C503	033-006
C507	CAPACITOR, fixed: metallized tubular, axial leads, .01 uf, $\pm 20\%$, 400 vdcw; Astron Part No. ML-4-01	033-005
C508	Same as C507	033-005
C509	Same as C503	033-006
C510	Same as C503	033-006
C511	Same as C503	033-006
J501S	CONNECTOR, receptacle: female, 21 contacts chassis mounted; Jones Part No. S-321-AB	146-057
J502S	CONNECTOR, receptacle: female, 10 contacts chassis mounted; Jones Part No. S-310-AB	146-018
J503S	CONNECTOR, receptacle: female, 8 contact chassis mounted; Jones Part No. S-308-AB	146-003
J504S	CONNECTOR, receptacle: female, 6 contact chassis mounted; Jones Part No. S-306-AB	146-004
J505S	Same as J503S	146-003
J506S	Same as J503S	146-003
K502	RELAY, PLAY: 3PDT, 115 volt dc coil std. 10 amp contact; Philtrol Part No. 33QA	020-006
K503	RELAY, FAST FWD: Same as K502	020-006
K504	RELAY, REWIND: Same as K502	020-006
P501P	CONNECTOR, plug, male, 21 contacts; Jones Part No. P-321-CCT-L	145-022
P504P	CONNECTOR, plug, male, 6 contacts; Jones Part No. P-306-CCT-L	145-012
P505P	CONNECTOR, plug, male, 8 contacts; Jones Part No. P-308-CCT-L	145-013
P506P	Same as P505P	145-013
P507P	Same as P504P	145-012

REF. NO.	PART DESCRIPTION	AMPEX PART NO.
R501	RESISTOR, fixed: wirewound, 20 ohm $\pm 10\%$, 5 watts; Tru-Ohm Part No. type FRL-5	043-154
R502	RESISTOR, fixed: wirewound, 75 ohm $\pm 5\%$, 75 watts; Tru-Ohm Part No. FR-50	043-002
R503	RESISTOR, adjustable: wirewound, 150 ohm $\pm 5\%$, 50 watts; Tru-Ohm Part No. AR-50	040-011
R504	RESISTOR, adjustable: wirewound, 750 ohm $\pm 5\%$, 50 watts; Tru-Ohm Part No. AR-50	040-007
R505	Same as R503	040-011
R506	RESISTOR, fixed: composition, 100 ohm $\pm 10\%$, $\frac{1}{2}$ W; MIL-R-11A, RC20GF101K	041-038
R507	Same as R506	041-038
R508	Same as R506	041-038
R509	Same as R506	041-038
R510	Same as R506	041-038
SR501	RECTIFIER, selenium: single phase, half wave; G. E. Part No. 6RS25PH6ATD1	582-016

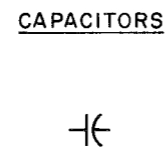
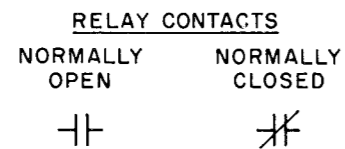
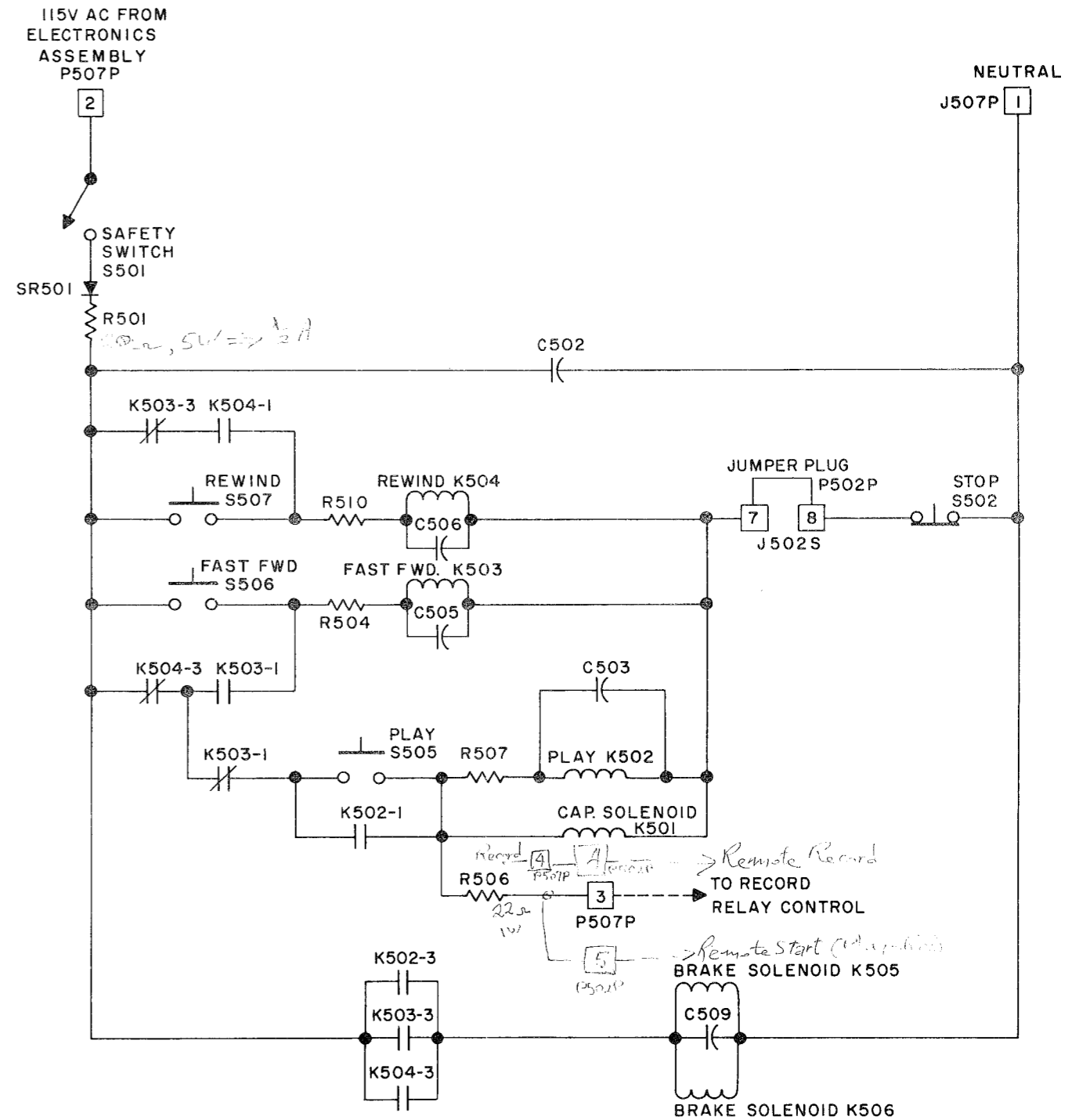
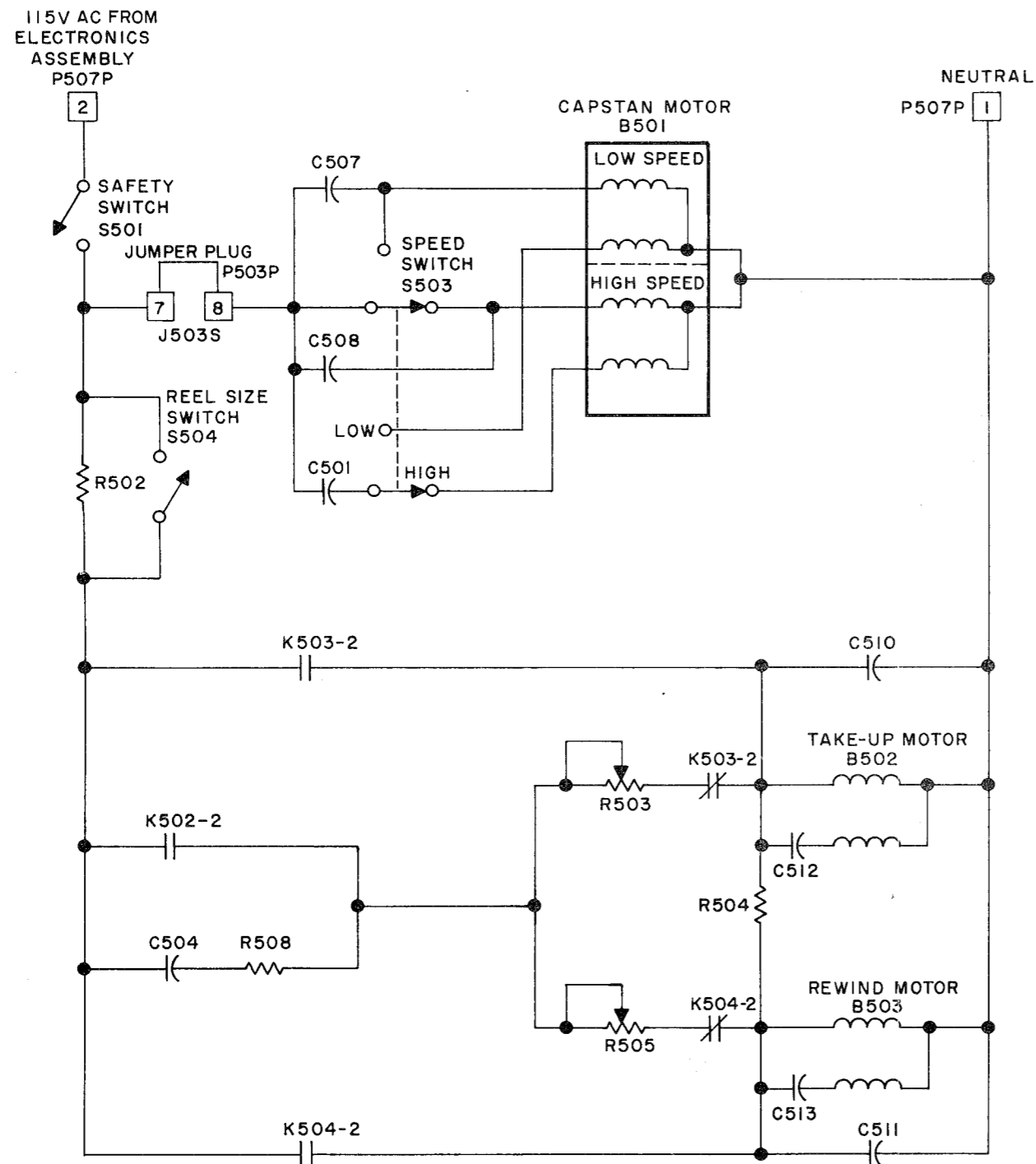

A-C CONTROL CIRCUIT

D-C CONTROL CIRCUIT

SIMPLIFIED CONTROL CIRCUIT SCHEMATIC MODEL 354 TAPE TRANSPORT

**SCHEMATIC DIAGRAM
MODEL 354 TAPE TRANSPORT
CONTROL CIRCUITS
CATALOG NUMBER 30970
30972 D**

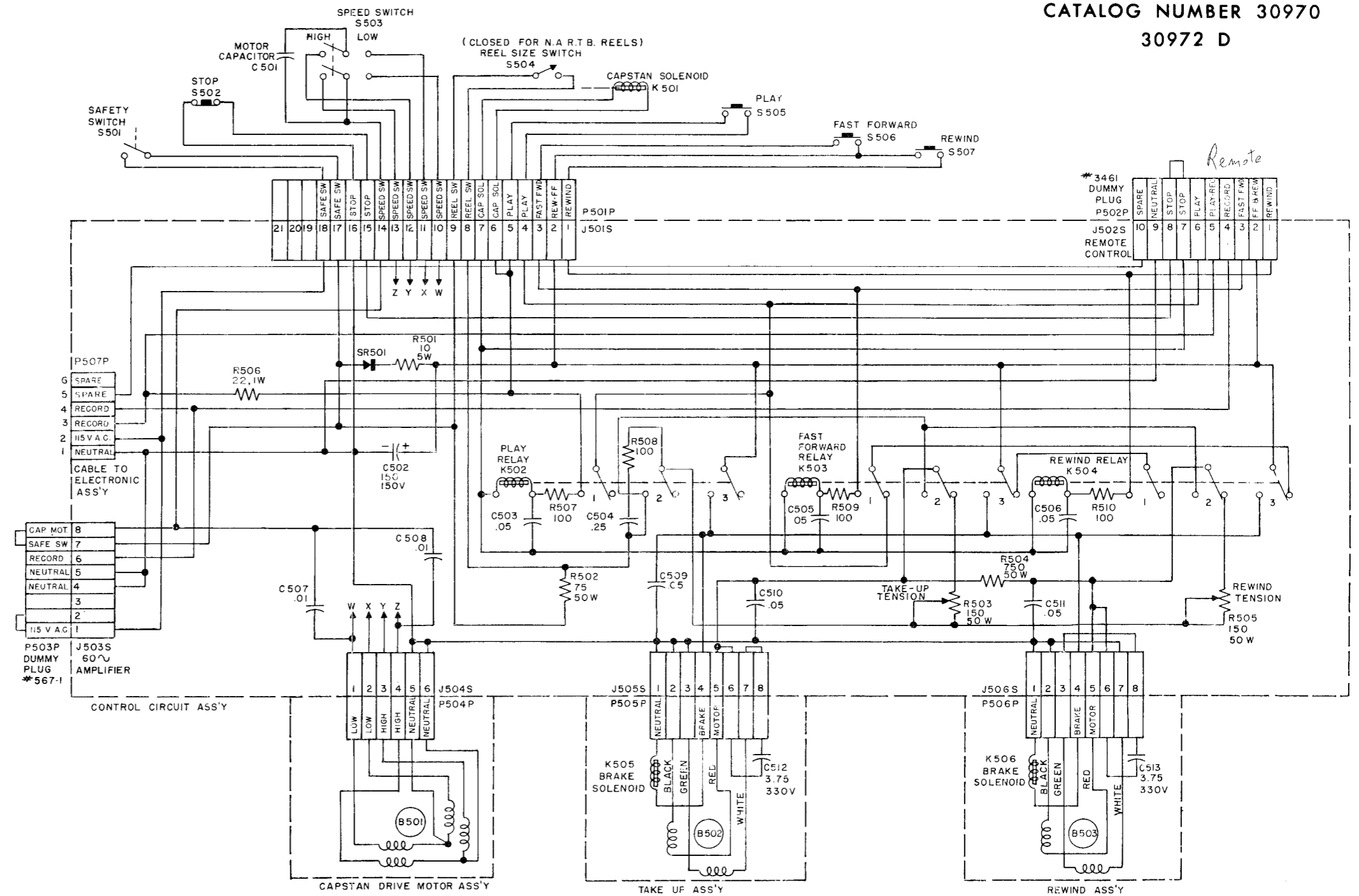

NOTE
 1 ALL RESISTORS IN OHMS & RATED 1/2 WATT UNLESS OTHERWISE NOTED
 2 ALL CONDENSERS IN MICROFARADS AND RATED 400 V UNLESS OTHERWISE SPECIFIED.

THE AMPEX HEAD

GENERAL

The head assembly of an Ampex magnetic tape recorder is the heart of the equipment. The technical and detailed know-how required for the fabrication of these head assemblies has made Ampex the foremost manufacturer of magnetic recording equipment in the world today.

In theory, a tape recorder head assembly is a simple device. In practice however, building a head assembly is a complicated task requiring extremely precise manufacturing techniques. There are three head stacks in an assembly—erase, record and playback. In recording, the erase head eliminates any previous recording from the tape. The record head puts a new signal on the tape by magnetizing the iron oxide particles in the coating on the tape. In playback, the magnetic flux in the *moving* tape induces a voltage in the playback head.

The design and construction of these heads is extremely critical. Their surfaces are lapped to finishes so smooth that variations are measured in wave lengths of light. In typical playback heads the gap is .00025 inch, which give an indication of the precision required in building the heads.

Each of these heads is designed for a specific function with *no compromise* in the overall head assembly. Professional use demands top performance and there is no room for design compromise.

The superb design, engineering and manufacturing care built into Ampex head assemblies assures dependable long life and economical operation at the lowest cost per operating hours.

Head Assembly

The head assembly is housed in a die cast housing and contains three heads used in the operating process. The heads are respectively erase, record and playback as viewed from left to right when facing the machine. The gate on the assembly holds the playback and record shield covers and the tape-lifting fingers. The function of the tape lifting fingers is to remove the tape from the heads when the gate is open during the REWIND and FAST FORWARD operation. The tape may leave a deposit on the heads if allowed to contact them at high speeds. Such a deposit will seriously impair the performance of the machine and should be guarded against by always opening the gate in the FAST FORWARD and REWIND modes.

If a deposit is left, it may be removed by xylene on a soft cloth or tissue. Never use metal of any kind to touch the head surfaces. The gates should never be allowed to spring shut, but should be closed gently.

INDIVIDUAL REPLACEABLE HEAD PARTS

<i>Part Description</i>	<i>Ampex Part Number</i>
Gate spring, two required	438-01
Gate pin, two required	403-006
Glass rod, tape guide, 1/2-inch long, four required	1372-00
Gate assembly (1/4-inch tape)	479-00
Housing (1/4-inch tape)	433-01

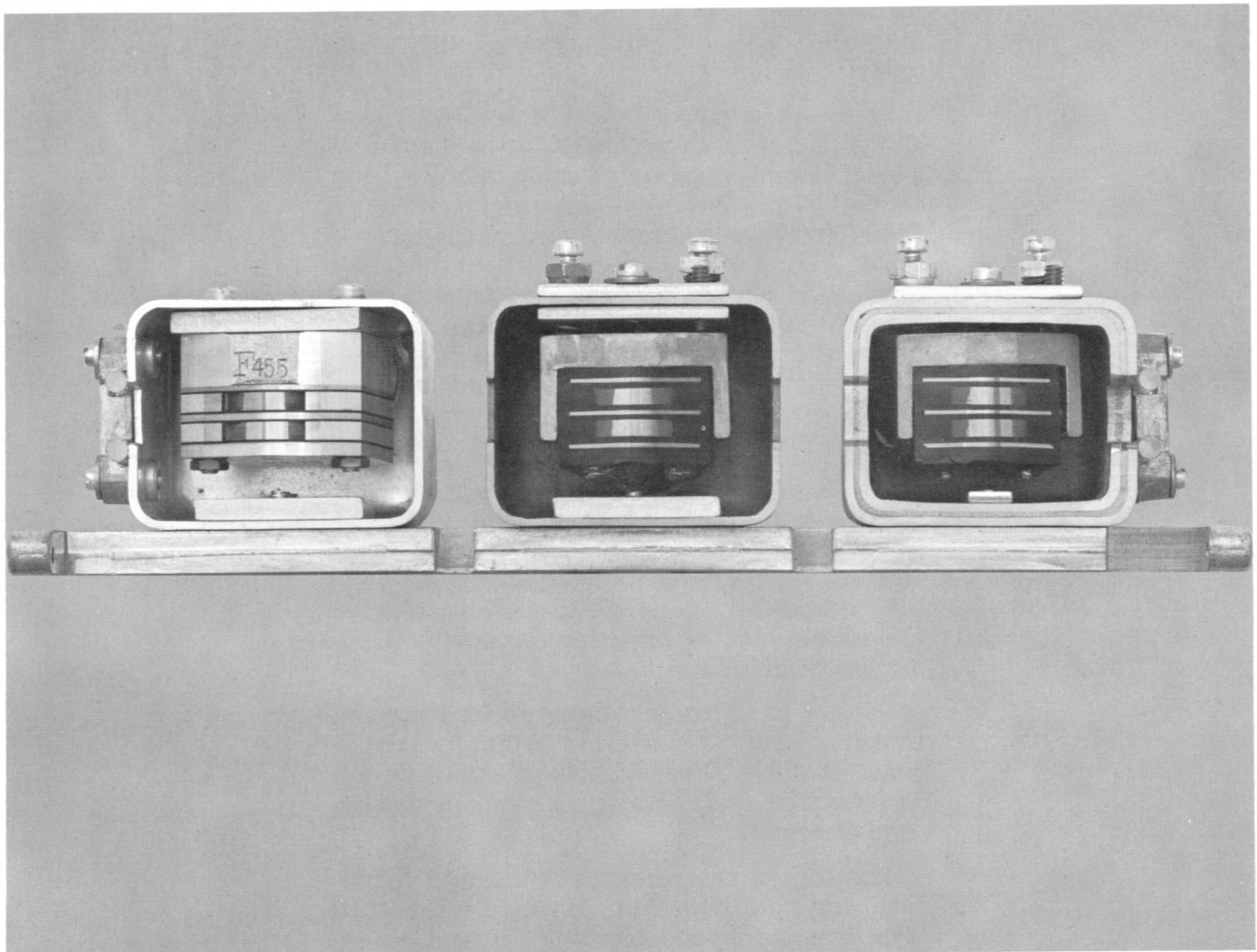

Two-track head assembly

ELECTRONIC ASSEMBLY

GENERAL

The electronic assembly consists of a single chassis on which is mounted an etched board subassembly containing two record amplifiers, two reproduce amplifiers, a bias and erase oscillator, and the power supply. On the face panel, facilities are available for setting record levels, selecting high or low speed equalization circuitry, and switching output circuitry. Visual monitoring of reproduce and record levels is provided by the two vu meters on the face panel. Two phone jacks for aural monitoring are provided on the face panel. Power on-off is controlled at the front of the assembly. A control for the record function, signified by accompanying indicator lights, and a record channel selector completes the front panel arrangement.

On the back panel of the electronic assembly chassis are all connecting and inter-connecting provisions for power input, line input, line output, power to the tape transport, and head connections. Two screw-type fuse posts are also provided on the chassis back panel.

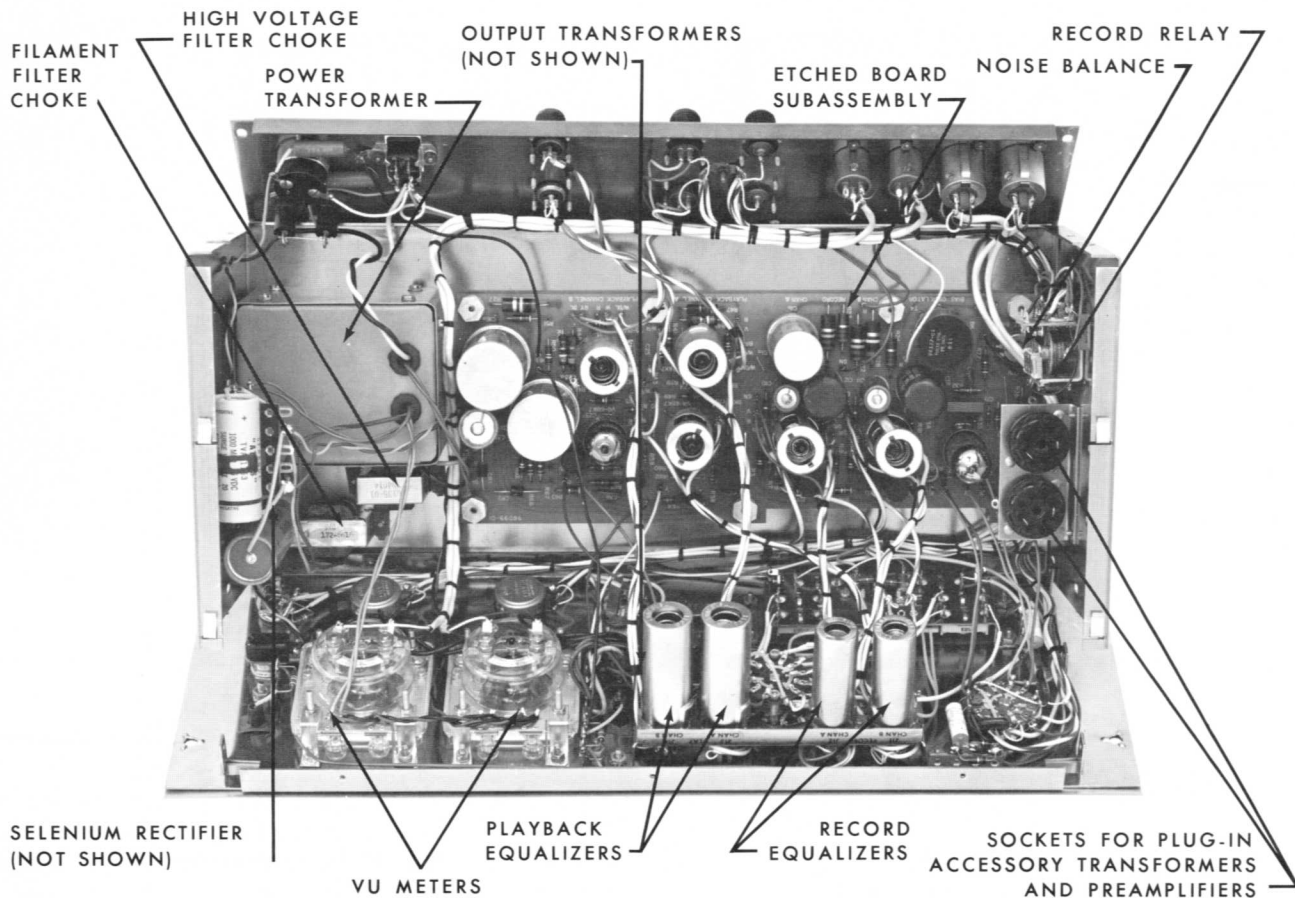

Location of electronic subassemblies

RECORD AMPLIFIER

The two record sections of the electronic assembly each consist of a two stage, high gain, resistance coupled amplifier. Two triode-pentodes, V1 and V2 and their associated circuitry, form the stages of amplification for both channels. To simplify the discussion, only channel "A", V1 and its related circuitry, will be described. Channel "B" is identical except for reference symbol numbers.

When using an unbalanced-bridging line input, the signal from J1 appears at the grid of tube V1a through transformer socket J15, dummy plug P15, potentiometer R1, and resistor R3. Potentiometer R1 provides a means of setting RECORD LEVEL. Bias is attained by un-bypassed resistor R5. Capacitor C1a and resistor R51 form a plate decoupling network for the first stage of both channels. Capacitor C2, resistor R11 and potentiometer R13 (RECORD CALI-

Brate) provide record calibration circuitry. Resistors R3 and R7 establish negative feedback around V1a. Capacitor C2 in conjunction with resistors R7, R11 and potentiometer R13 provides low frequency pre-emphasis.

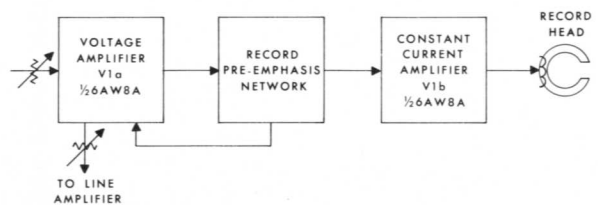

Block diagram, record circuit

NOTE

When reading *vu* meter indications with the OUTPUT SELECTOR switch

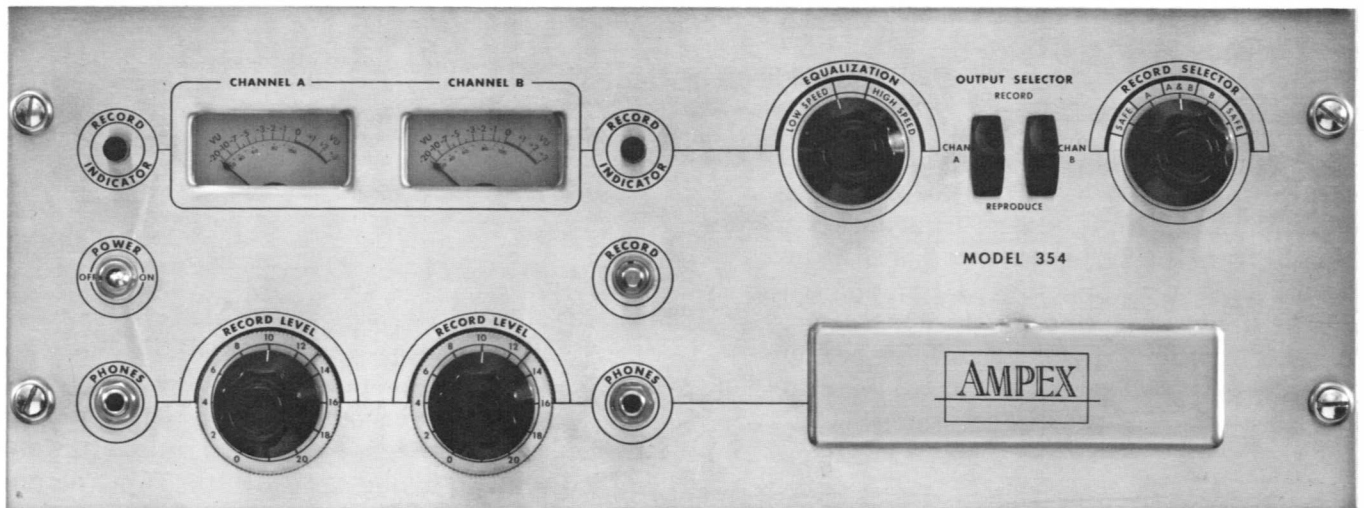

Ampex chassis, front panel

in the RECORD position, only the first stage of the record amplifier and the last two stages of the reproduce amplifier are connected in the circuit. This omits record pre-emphasis and reproduce equalization circuitry so that meter indications will reflect only the flat response of each amplifier.

The signal is now coupled to the grid of tube V1b through capacitor C4, the plug-in pre-

emphasis network, and resistor R17. Negative feedback is provided through unbypassed resistor R19. Bias for tube V1b is provided by the difference in voltages developed across resistor R5 and resistor R19 by returning the control grid of V1b to the cathode of V1a through a resistance in the plug-in pre-emphasis circuitry for high and low tape speeds provide the necessary high frequency pre-emphasis to the control grid of tube V1b. Tube V1b delivers an audio signal current

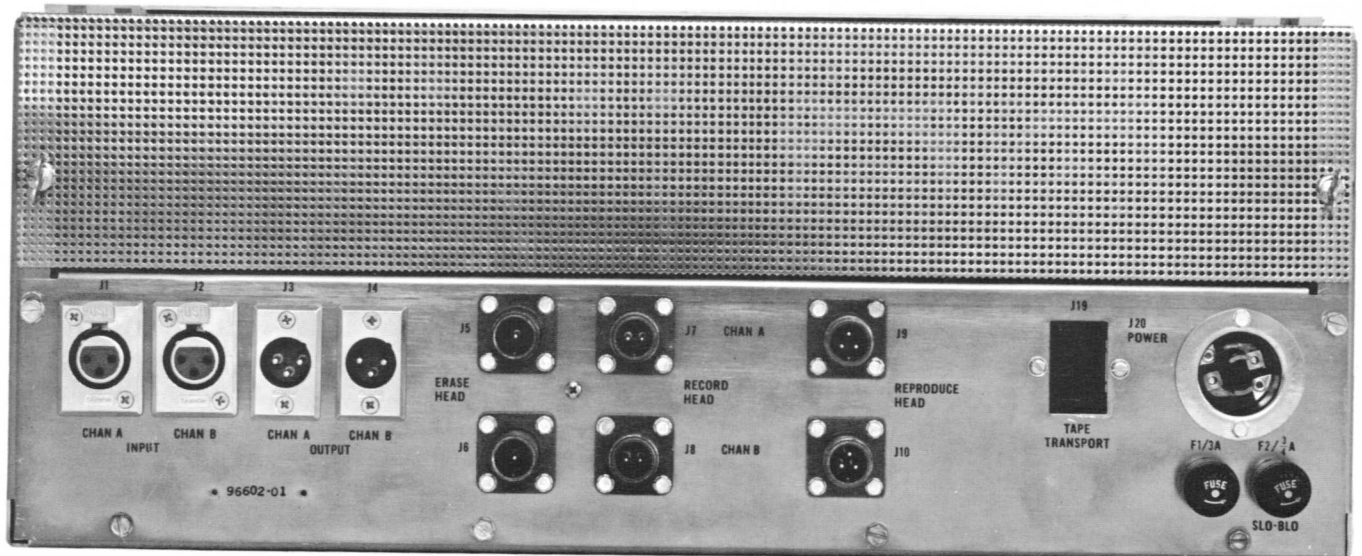

Ampex chassis, rear view

to the record head that is directly proportional to the signal voltage at the control grid. A 100 kc bias signal current from the bias and erase oscillator output is coupled into the record head through capacitor C14.

In the balanced-bridging line input arrangement, operation is identical to that for unbalanced-bridging input except that an accessory plug-in transformer is used in place of dummy plug P15 so that one side of the signal input line will not be connected to chassis ground. When a microphone is used with the equipment an accessory plug-in transistorized preamplifier is used in place of the dummy plug.

REPRODUCE AMPLIFIER

The reproduce section of the electronic assembly is a resistance coupled audio amplifier. Two dual triodes are used to provide two stages of amplification and a single-ended push-pull output for each channel.

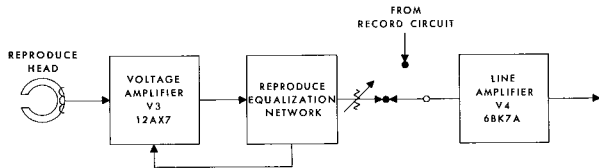

Block diagram, reproduce circuit

Signals on the moving magnetic tape induce voltages in the reproduce head. This induced voltage appears across resistor R37 and then the grid of tube V3a. Bias on this first stage is derived from the voltage divider network consisting of resistors R49, R47 and R45. The amplifier output of this first stage is coupled to the second stage grid through capacitor C24. Contact bias is used on V3b. Capacitor C23a and resistor R52 form a plate decoupling network for the first two stages. Reproduce equalization is achieved by means of the plug-in equalizer network.

The signal is now delivered to the push-pull output amplifier V4, the tube receiving the signal through coupling capacitor C26, *PlayBack LEVEL* potentiometer R54 and *OUTPUT SELECTOR* switch S2 when the switch is in the *REPRODUCE* position.

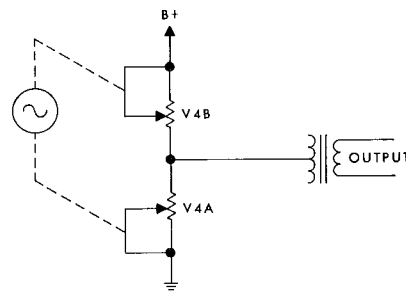

Simplified Schematic, Line Output Amplifier

Operation of the output stage is similar to the operation of the potentiometers in the simplified schematic diagram with the input signal voltage controlling the position of the arms of both potentiometers. As the signal voltage goes positive, the effective resistance of the potentiometer marked "V4A" decreases and the effective resistance of the potentiometer marked "V4B" increases. As the signal voltage goes negative, the opposite occurs.

Load proportional current feedback is applied from the bottom of the transformer T2 primary winding to the junction of resistors R60 and R64 to provide output stability. Negative voltage feedback is applied from the top of the transformer primary winding to the grid of tube V4A through capacitor C37 and resistor R58 to reduce distortion. Capacitor C28 provides a bypass that compensates for high frequency losses.

BIAS AND ERASE OSCILLATOR

A dual triode tube V7, connected as a push-pull oscillator, provides high frequency bias and erase currents. The output of each plate is coupled to the grid of the other triode section through taps on the oscillator transformer primary. Any signal on the grid of either tube section will be amplified in the plate circuit of that section and coupled to the grid of the other tube section. The signal then will appear at the second plate and be coupled back to the first grid in phase with the original signal. Frequency of oscillation of approximately 100 kc is determined by the inductance of the primary of transformer T4 and the effective capacity across the primary.

The oscillator output is fed through *RECORD SELECTOR* switch S4 and through capacitors C21 (for channel A) and C22 (for channel B) to the two-channel erase head. The oscillator

output is also fed to BIAS ADJust variable capacitors C14 (for channel A) and C15 (for channel B) where record bias current adjustments take place. The bias signals are then mixed with the record signals and delivered to the two-channel record head. Plate voltage is supplied to the center tap of oscillator transformer T4 through relay contact K1B only when the equipment is in the record mode.

NOISE BALANCE control, potentiometer R31, in the oscillator cathode circuits is adjusted to correct for any asymmetry in the waveform, which would cause random noise during reproduction and distortion while recording.

POWER SUPPLY

Silicon rectifiers CR1 and CR2 are used in a conventional full-wave voltage doubler rectifier circuit to supply plate power for all tubes in the electronic assembly as well as the RECORD INDICATOR lights DS1 and DS2. Selenium rectifier CR3 is connected as a conventional full wave center tap rectifier to provide dc filament voltage for all tubes except V7.

The center tap of the V5 tube filament provides a ground for the dc filaments. Even though this tube is only used for the reproduction of channel two, it must be in its socket for proper operation of all functions. Ac power input is connected at J20 POWER receptacle and is controlled by POWER switch S6. The power is fed through fuse F2 and impressed across the primary of power transformer T1 and also through fuse F1 to the tape transport.

There are three secondary windings on the power transformer—two for filament supply and one for high voltage. One filament winding serves oscillator tube V7 and the panel lights, the second filament winding provides 12.6 volts dc after rectification, and the other winding furnishes high voltages for the plate supply. The plate supply ripple is filtered by a capacitance-input choke filter formed by choke L1, capacitors C16b, C16c, and C35; additional filtering is supplied by the decoupling capacitors.

High voltage is applied to the bias oscillator through record relay K1b. Whenever the PLAY button on the tape transport is pressed, approximately 150 volts dc is available at pin 3 of J19. When the RECORD SELECTOR switch S4 is in the "A", "A&B" or "B" position and when the

RECORD button S5 is pressed, the dc voltage is applied to the record relay coil. As long as the dc voltage is available at pin 3 of J19 and as long as the RECORD SELECTOR switch is in one of the positions mentioned above, contact K1a holds the record relay energized. When the STOP button on the tape transport is pressed or when the RECORD SELECTOR switch is turned to one of the SAFE positions, the dc voltage no longer reaches the relay coil, the relay is de-energized and drops out.

NOTE

The RECORD SELECTOR switch can be turned from one position to another during the recording process provided that it is not turned to one of the SAFE positions. However, for click-free performance it is preferable to pre-select the setting of the RECORD SELECTOR for the mode of operation desired.

ALIGNMENT AND PERFORMANCE CHECKS

General:

In the following alignment and performance checks, each channel should be treated separately except where noted. In cases where, in the middle of a procedure, the second channel must be checked simultaneously with the first channel, all steps preceding should be performed on both channels.

Equipment Required:

AMPEX Standard Alignment Tapes for ¼-inch machines:

Speed	Catalog Number
3¾ inches per second	31331-01
7½ inches per second	31321-01
15 inches per second (NAB)	31311-01
15 inches per second (AME)	31312-01

Ac Vacuum Tube Voltmeter capable of indicating rms voltages of 0.004 or less.

Audio Oscillator with stable output from 50 cps to 15 kc.

Earphones or Speaker - Amplifier for aural monitoring.

Nutdriver, number 8 (¼ inch).

Reel of unrecorded tape.

Small screwdriver.

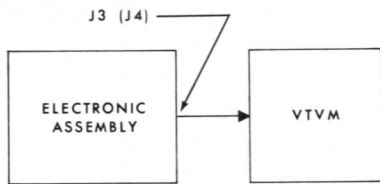

Block diagram, reproduce alignment connections

Reproduce Alignment:

CAUTION

The standard alignment tape used in the following procedures may be partially erased if the record and reproduce heads are permanently magnetized. Demagnetize the heads before proceeding.

- Step 1: Lift the head cover.
- Step 2: With the equipment connected as shown and all power switches in the ON position, thread the appropriate AMPEX standard alignment tape along the prescribed path.
- Step 3: Set the EQUALIZATION switch to the desired speed.
- Step 4: Place the OUTPUT SELECTOR switch in the REPRODUCE position.

Step 5: Start the standard tape. The first tone on all standard tapes is a reference level, 700 cycles for 7½ and 15 inches per second, and 500 cycles for 3¾ inches per second. Adjust the Playback LEVEL control to a convenient meter reading for checking alignment and response.

Step 6: The next tone will be 15,000 cycles at 7½ and 15 inches per second, and 7500 cycles at 3¾ inches per second for adjusting reproduce head alignment. Take the number 8 nut driver and adjust the left hand stop nut on the reproduce head for maximum output on VU meter or VTVM. If the peak is broad adjust for minimum output variation. Because there are two heads in the head stack, make the azimuth adjustment for an average maximum meter indication, adjusting first one head and then the other, and finally adjusting for the average maximum meter indication.

NOTE

If the head azimuth is far out of alignment (possible if inexperienced personnel without proper equipment have

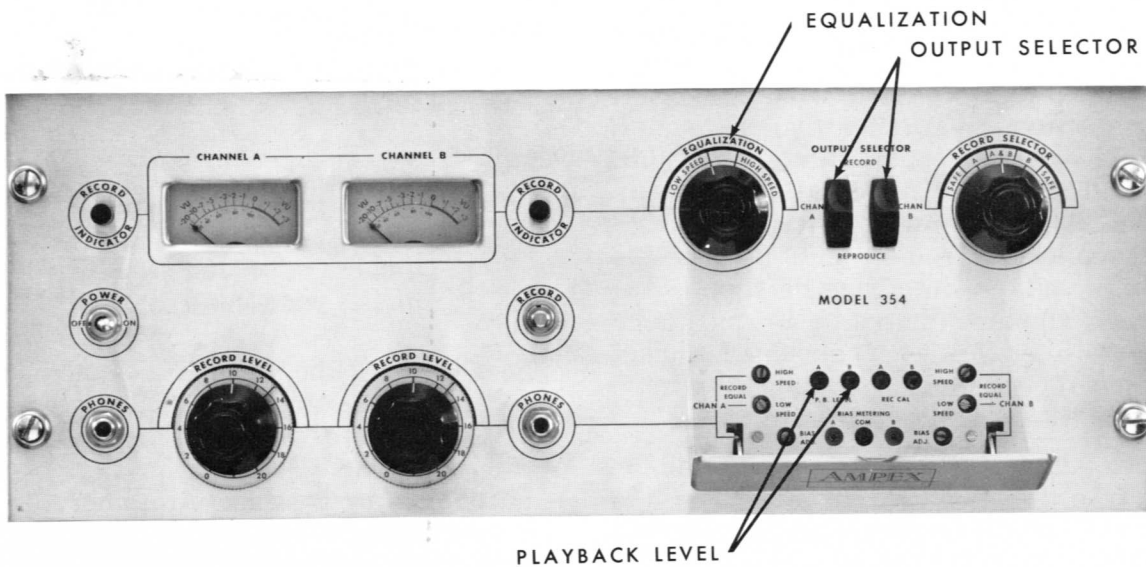

Reproduce alignment controls

attempted alignment procedures) minor peaks may be observed on both sides of the maximum. The proper setting is 15 to 20 db higher than these peaks.

Step 7: Depending on tape speed, tones from 15,000 cycles to 30 cycles now will be reproduced from the standard tape. High frequency response (above 300 cycles) should not vary more than 2 db from the standard curve.

NOTE

When reproducing AMPEX standard alignment tapes on multitrack equipment, the bass end of the frequency spectrum will rise in response. The actual amount of rise will vary with the width and location of the track. This phenomena is present because the reproduce head "sees" additional flux on each side of the head at long wavelengths since the standard tapes are recorded across the complete width of the tape. This fringing effect is not present when recording a track the same width as the reproduce head.

Step 8: The next tone to be heard on the 3¾ and 7½ inch per second standard tapes is a reference tone at operating level. (For 15 inches per second, rewind the standard tape to the first tone.) Adjust the *PlayBack LEVEL* control to obtain a zero reading on the vu meter or a +4 dbm output on a VTVM.

NOTE

Do not change this playback level setting for the remainder of the adjustments. Remove the standard tape upon completion of the reproduce alignment.

Reproduce Amplifier Noise Measurement:

Step 1: After performing the reproduce alignment checks, stop the tape motion.

Step 2: Read the noise level on the VTVM. Noise should be below the level speci-

fied in the performance characteristics. Inaudible low-frequency bounce can cause the meter to read higher than performance characteristics tolerances. Disregard these momentary readings because they are frequencies far below the operating range.

Record Amplifier Bias Adjustment:

NOTE

This adjustment should be made using the brand and type of tape that normally will be used on the equipment.

Step 1: Place the *OUTPUT SELECTOR* switch in the *REPRODUCE* position.

Step 2: Place the equipment in the record mode at 7½ ips tape speed.

Step 3: Set the oscillator frequency at 500 cycles per second (cps) with an output of approximately 1 volt.

NOTE

Bias is set at a specific wavelength. If it is desired to set bias at 15 inch tape speed, use a frequency of 1000 cps.

Step 4: Set the *RECORD LEVEL* control at a position that will obtain an on-scale vu meter reading.

Step 5: Set peak bias by adjust the *BIAS AD* *Just* control clockwise until the 500 cycle signal drops ½ db below the maximum reading on the vu meter. Note the current reading on the VTVM, (current = voltage on meter - 100). Turn the bias control counter-clockwise until the 500 cycle signal again drops ½ db and note the current reading on the VTVM. Set the bias control at the median of these two readings.

NOTE

Provided that the head assembly and the type of tape is not changed, the current reading found in step 5 may be used to set the bias current.

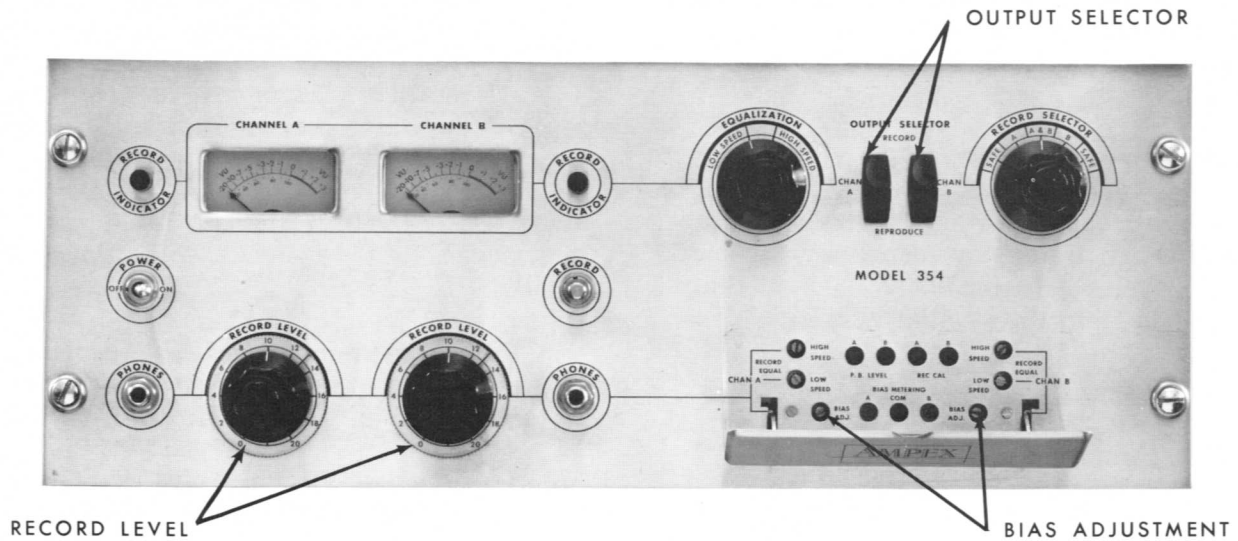

Record Amplifier bias adjustment controls

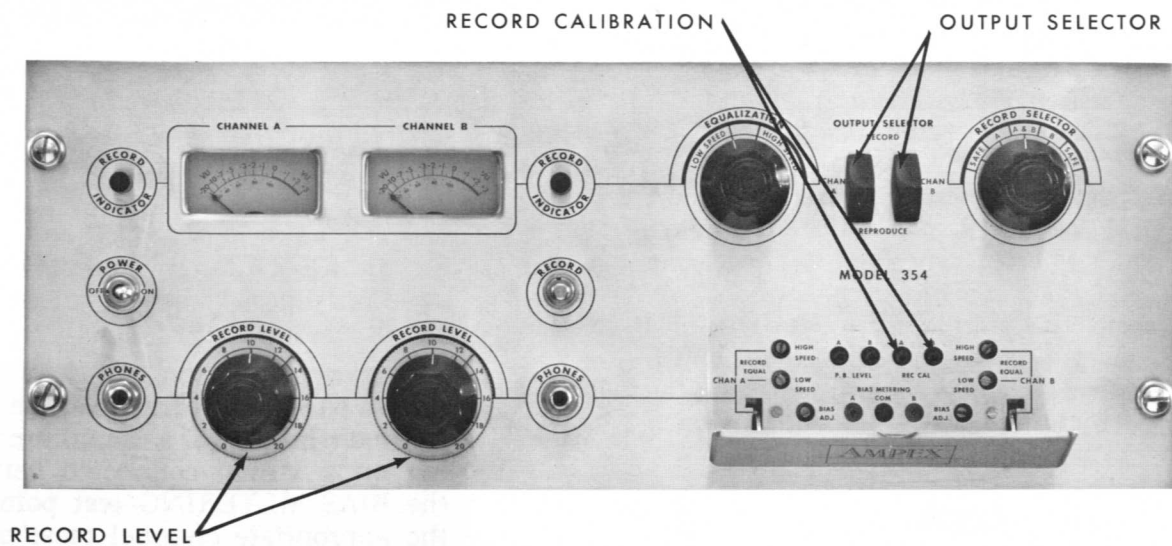

Record level calibration controls

Record Level Calibration:

NOTE

The reproduce level must be calibrated using standard tape before calibrating the record level (see Reproduce Alignment).

- Step 1: Set the audio oscillator to 500 cps. Leave the OUTPUT SELECTOR switch in the REPRODUCE position.
- Step 2: Place the equipment in the record mode at 7½ ips tape speed.

- Step 3: Set the RECORD LEVEL control at a position that will obtain a zero reading on the vu meter.
- Step 4: Place the OUTPUT SELECTOR switch in the RECORD position.
- Step 5: Adjust the REcOrd CALIBRate potentiometer for a zero vu reading.

Record Azimuth Adjustment:

- Step 1: Set the audio oscillator at 500 cps.
- Step 2: Place the OUTPUT SELECTOR switch in the RECORD position.
- Step 3: Set the RECORD LEVEL control to obtain a vu meter reading of approximately -20 (-16 dbm on VTVM).
- Step 4: Place the OUTPUT SELECTOR switch in the REPRODUCE position.
- Step 5: Set the audio oscillator to 7500 cps for 3¾ ips, 15 kc for 7½ or 15 ips.
- Step 6: With the nut driver, rotate the adjustment nut on the left side of the record head (as the user faces the front of the equipment) to obtain a maximum VTVM reading. Several peaks may appear, but the maximum peak is obvious because it is much greater than the minor peaks.

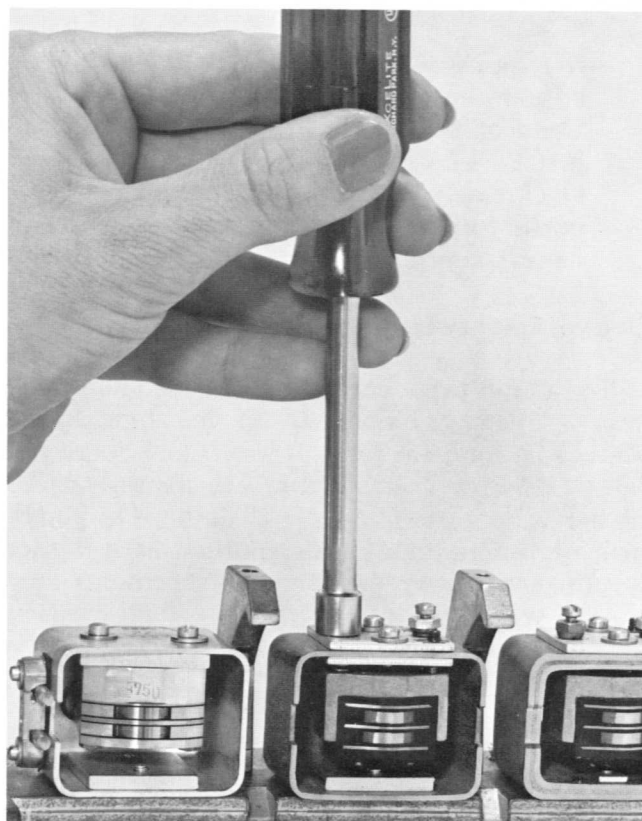

Record head azimuth adjustment

CAUTION

The right hand nuts are factory set. DO NOT ADJUST THEM.

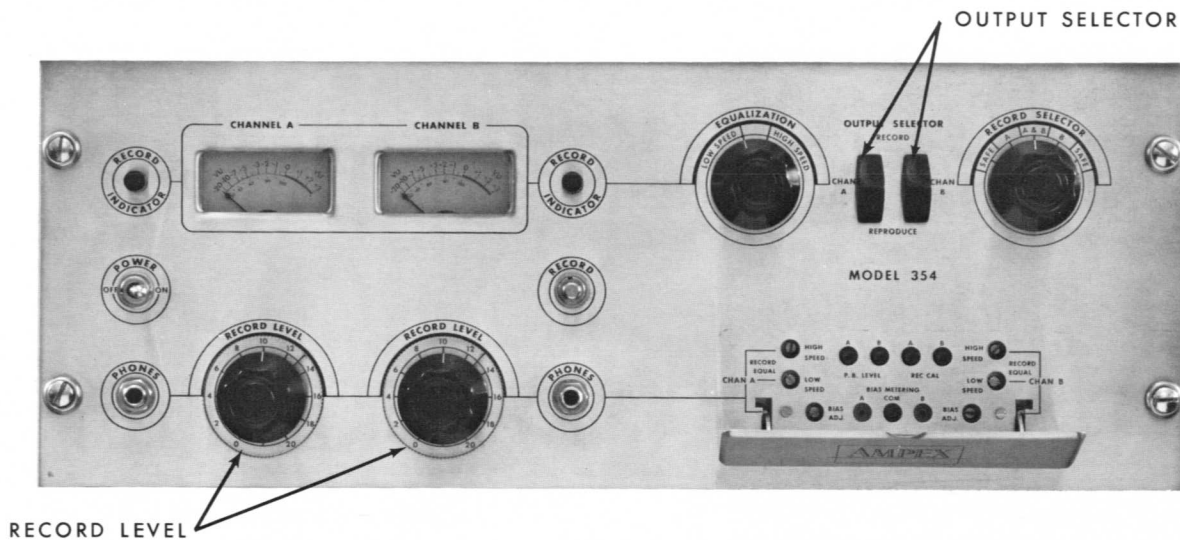

Record head azimuth controls

NOTE

If it is desired to make this azimuth adjustment using the VU meter instead of the VTVM, place the PLAYBACK LEVEL control in the full clockwise position and adjust the azimuth nut to obtain a maximum VU meter reading.

Overall Frequency Response:

To avoid tape compression, frequency response measurements at 15 ips tape speed should be made at least 10 db below operating level (-6 dbm), at 3¾ and 7½ ips at least 20 db below operating level (-16 dbm). The standard alignment tapes are recorded at a higher level to facilitate reproduce measurements only on the vu meter.

- Step 1: Place the OUTPUT SELECTOR switch in the RECORD position.
- Step 2: Set the audio oscillator at 500 cycles and adjust the RECORD LEVEL control to obtain a VTVM reading of approximately -16 dbm.
- Step 3: Place the OUTPUT SELECTOR switch in the REPRODUCE position.
- Step 4: Place the equipment in the record mode at the desired operating speed.

Step 5: Make a frequency response check by using at least ten discrete frequencies between 50 and 15,000 cycles. The high frequency response may vary with tapes of different manufacturers. This machine was adjusted at the factory to give optimum performance within specifications with an average tape. The RECOrd EQUALizer controls may be re-adjusted to give the flattest possible response with the tape you intend to use. The bias setting will also change the high frequency response, especially at the lower tape speeds (3¾ and 7½ ips). Before adjusting the RECOrd EQUALizers be certain that the bias has been correctly adjusted as previously described.

CAUTION

Changing bias may change the RECOrd level CALIBration which may require re-adjustment as described earlier in this section.

Record Noise Balance Adjustment:

- Step 1: Position the RECORD LEVEL control for channel one completely counter-clockwise.

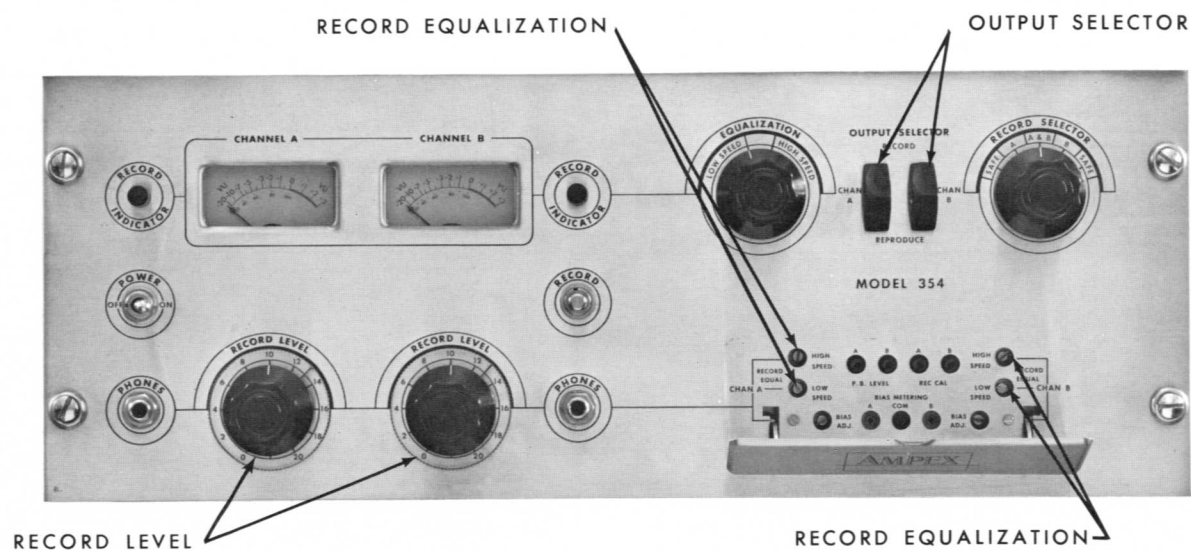

Frequency response adjustment controls

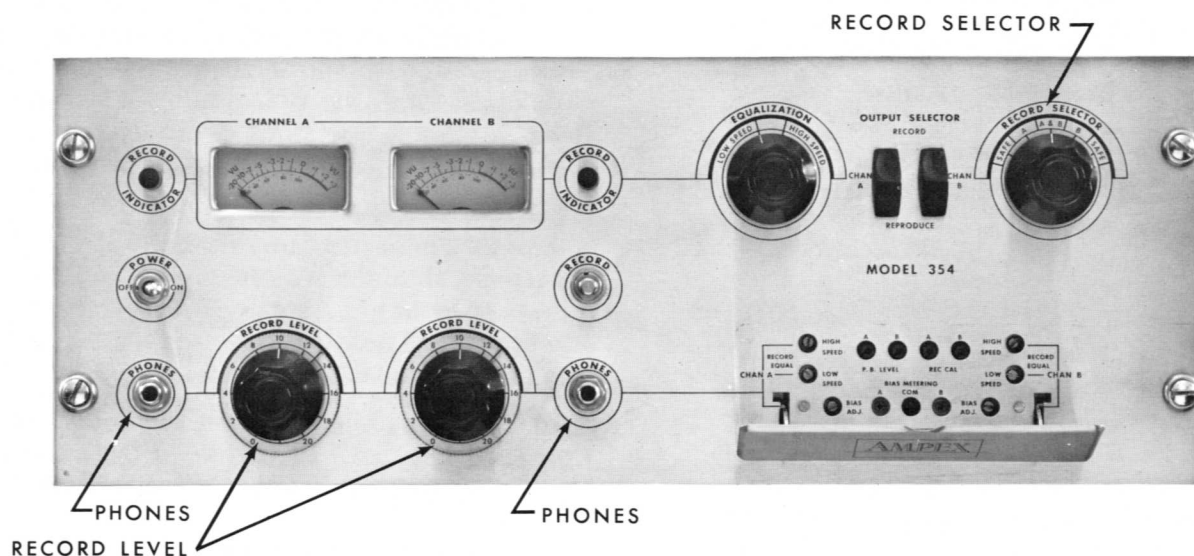

Noise balance adjustment controls

- Step 2: Disconnect any input.
- Step 3: Place the RECORD SELECTOR switch in the "A" position.
- Step 4: Place the equipment in the record mode.
- Step 5: Plug a set of headphones into the monitor jack for channel one and listen for the minimum noise location while adjusting the noise balance control. Note the position of the slot on the noise balance control.
- Step 6: Stop the recorder.
- Step 7: Perform steps 1 through 6 for channel "B".
- Step 8: Set the noise balance control to the position midway between the positions found in step 5. The control slot should be within 45 degrees of a line parallel the face panel of the chassis.

NOTE

This adjustment is not critical and noise will normally not be heard. This adjustment can, however, be used to balance out second harmonic distortion in the oscillator using a wave analyzer. If noise is present and can-

not be nulled in either steps 5 or 8, it indicates excessive leakage in capacitor C12 or C13, trouble in the oscillator circuitry, or magnetized heads and troubleshooting is indicated.

Record Noise Measurement:

To translate VTVM readings into specific signal-to-noise ratios when the vu meter is so calibrated that zero vu corresponds to +4 dbm output, add 6 db to obtain the output value from the 3% distortion level, arriving at a total of 10 dbm. Having made this computation, bear in mind that, although the noise reading taken on the VTVM is dbm, the measurement is a *ratio* which must include the 10 dbm computed to arrive at the 3% distortion level. Therefore, the VTVM reading must be converted to the signal-to-noise *ratio*.

Example: 10 (dbm, includes 4 dbm normal level and 6 dbm to the 3% distortion level)
 -50 (dbm, vtm reading)
 60 db signal-to-noise ratio

Any reading below -50 dbm meets performance characteristics specifications of 60 db signal-to-noise and satisfies the signal-to-noise ratio definition.

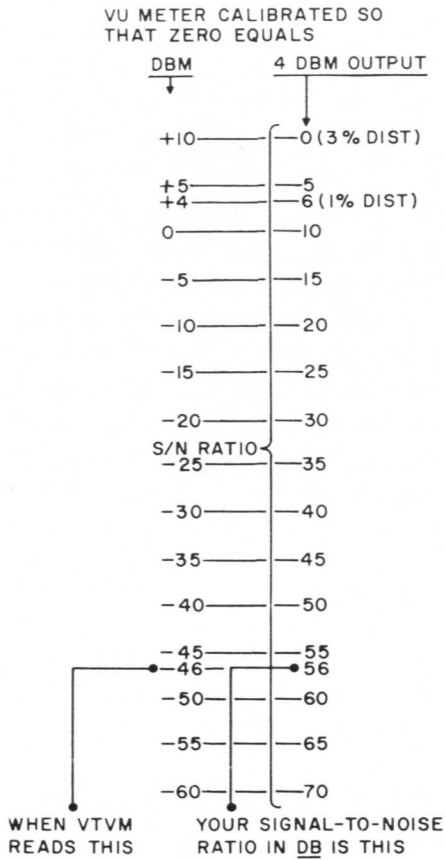

Signal-to-noise ratio computations

AMPEX signal-to-noise ratio specifications on audio instruments define in decibels the ratio existing between the level of a steady 1000 cycle tone, recorded at a level at which distortion produced by the approach of tape saturation equals 3% total rms, and that level of total rms noise, in the band from 30 to 15,000 cycles, which exists in reproduction under the same gain conditions.

AMPEX audio instruments normally are calibrated so that the vu meter reads zero level when reproducing a steady 1000 cycle tone the level of which produces 1% total rms distortion due to the approach of tape saturation.

A recorded 1000 cycle tone at the 3% distortion level will be 6 db higher in level than the same tone recorded at the 1% distortion level.

- Step 1: Place the OUTPUT SELECTOR switch in the RECORD position.
- Step 2: Set the audio oscillator at 1000 cps.
- Step 3: Adjust the RECORD LEVEL control to obtain a VTVM reading 6 db above operating level (+10 dbm).
- Step 4: Record the 1000 cps on a section of tape, noting where the recording begins for later reference.
- Step 5: Disconnect the oscillator.

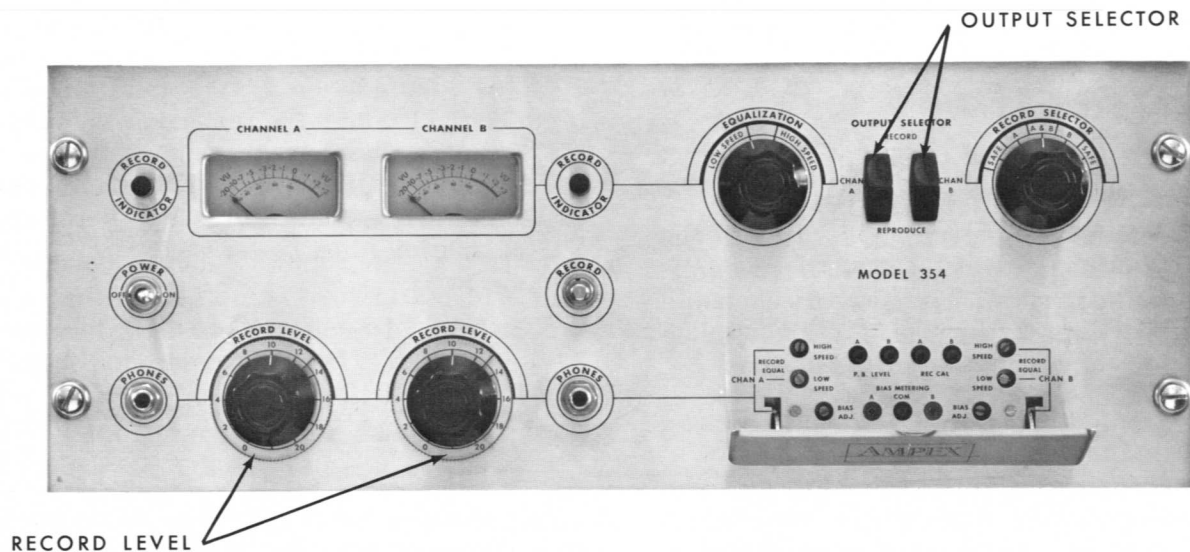

Noise measurement controls

- Step 6: Set the RECORD LEVEL control to zero (fully counterclockwise).
- Step 7: Rewind the tape to the beginning of the 1000 cps recording.
- Step 8: Erase the tape by recording with no input signal.
- Step 9: Rewind again to the beginning of the recording.
- Step 10: Place the OUTPUT SELECTOR switch in the REPRODUCE position.
- Step 11: Reproduce the tape, reading the VTVM, and checking the reading against the table.

MAINTENANCE AND TROUBLESHOOTING

General Maintenance Information

Faithful adherence to the recommended ROUTINE MAINTENANCE found in SECTION 5 TAPE TRANSPORT MECHANISM and careful performance checks will insure excellent equipment operation. When the cleaning, lubricating and demagnetizing procedures are followed as prescribed and the system is set up according to the instructions in this manual, equipment performance should meet the high Ampex standards.

Neglect of maintenance procedures, such as failure to clean the capstan, the head faces and the tape guides daily can cause deficiencies that are reflected in the amplifiers. For instance, poor tape-to-head contact, due to tape oxide accumulations, will diminish high end frequency response.

Improper head azimuth adjustment will also affect high frequency response.

When the user suspects faults, the above information should be considered, and, if satisfied that the cause is in the amplifier, he then can begin troubleshooting.

Progressive Maintenance of the Amplifiers

Check B+ voltage at junction of filter choke L1 and capacitor C16b; voltages measured will vary with line voltage, the voltages indicated on the schematic diagram were measured with a 117 volt line voltage. Check all tubes using a

tube tester. Make certain that tubes are returned to same socket from which they were removed. Check dc filament voltage to note aging of CR3. Clean the relay contacts by inserting a burnishing tool between contacts and pull it back and forth several times.

Corrective Maintenance

The first step in any corrective maintenance procedure is localizing the faulty circuit. If a tape recorded on the equipment itself does not reproduce correctly, the trouble can be in either the record or the reproduce circuit. In this case, the faulty circuit can be identified by reproducing a standard alignment tape or a commercially recorded tape; if, while reproducing the standard tape, trouble still exists the fault is in the reproduce circuit, if the reproduce function is normal, the fault is in the record circuit. A run through of the alignment and performance checks for the offending circuit will further isolate the trouble or may rectify it, and the faulty component or mechanical device then should be identified easily.

Troubleshooting the Reproduce Amplifier

A circuit for troubleshooting the reproduce amplifier is shown below (see also, PARTS LOCATION PRINTED CIRCUIT BOARD SUB-ASSEMBLY, and fold out SCHEMATIC DIAGRAM—ELECTRONIC ASSEMBLY).

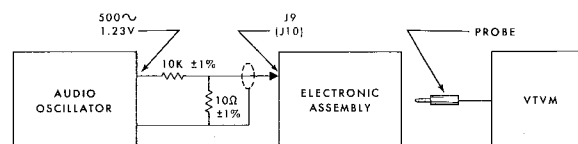

Troubleshooting the reproduce amplifier

Disconnect the head cable at J9 (or J10) when using this circuit. Using a vtvm probe and working back from the output toward the input, check at the grid and plate of each stage until the point at which a signal is indicated on the vtvm. The trouble then is probably in the stage immediately following that point. When the faulty stage is located, the individual components can be isolated by a check of resistances and voltages. Typical voltage values are shown on the foldout schematic diagram. After the

completion of any troubleshooting procedures, using the circuit shown above, check the reproduce amplifier response against the appropriate curve to insure that the equipment conforms to performance characteristics.

Troubleshooting the Record Amplifier

The circuit for troubleshooting the record amplifier is shown below (see also, PARTS LOCATION PRINTED CIRCUIT BOARD SUB-ASSEMBLY, and foldout SCHEMATIC DIAGRAM — ELECTRONIC ASSEMBLY).

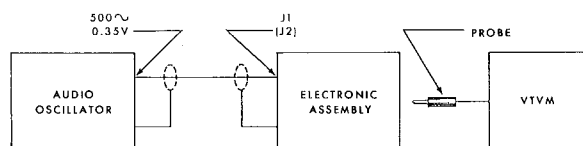

Troubleshooting the record amplifier

Proceed as in troubleshooting the reproduce amplifier. Typical voltage readings are shown on the foldout schematic diagram. Using the circuit above, check the record amplifier against the appropriate response curve. Response of the amplifier should be checked with the bias oscillator tube removed from its socket and the record relay energized.

Servicing and Repairing Printed Circuits

Because of the uniform wiring layout and translucent boards, printed circuits can be traced more easily than conventional circuits, troubleshooting is less difficult, and any qualified person will be able to service and repair the equipment including replacement of components by following the instructions, suggestions and procedures in this section. The translucency of the board makes locating connections and test points easier if a light bulb is placed underneath the circuit to be traced. Continuity checks and measurement of resistors, coils and some types of capacitors can be made at the component side of the etched board. Very small breaks in wiring can be located by means of a magnifying glass. The parts location illustrations and the schematic diagram in this section can be used to advantage when tracing circuitry, especially where tube sockets are concerned. Pin numbers are plainly marked.

Precautions

Be careful when removing components from the board to avoid damaging the components themselves or the copper foil wiring. If damage occurs, small breaks can be joined with solder, new foil can be cut to simulate the damaged sections, and large breaks can be repaired with hook-up wire. When applying new foil, first remove all coatings such as flux, grease and wax from the damaged portion and place the adhesive side of the foil toward the board. With the tip of the smooth wedge-shaped soldering iron heat the new foil, sliding the tip slowly along the copper surface for about a minute to cure the bond.

Excessive pressure can crack the boards. Access to certain components may not be possible when the boards are in the chassis. To remove the board from the chassis, remove the four mounting nuts carefully. When disconnecting the edge-on harness connectors, make certain that the diagonal pliers grasping the individual connector will not strike and break an adjacent component. To prevent this type of damage, insert a screw driver or similar protective device between the diagonal pliers and the vulnerable component. A vise with protected jaws can be used to hold the boards while servicing. Avoid excessive pressure against the boards when using the vise.

Another source of damage can come from overheating during the soldering process. Excessive heat can cause breaks in the bond between the board and foil, necessitating costly repair of the foil connections. Use 60/40 resin core solder, the melting point of which is 375 degrees F. Some soldering irons are available with tip temperature of 650 degrees F., but the more skilled repair man can speed up the soldering process by using an iron with a tip temperature in the neighborhood of 750 degrees F.

Equipment and Tools Required

- Diagonal cutters
- Long-nosed pliers
- Pocket knife
- 1/4-inch nut driver
- Solder pick
- Small wire brush
- Pencil soldering iron
- 60/40 resin core solder

Removing a Resistor

A convenient method of removing resistors is to clip the leads with cutters, leaving sufficient wire at each point so that wiring terminals remain. New components can be soldered to these remnant leads.

Replacing the Resistor

Make mechanical joints by wrapping a turn of each new resistor wire around the remnant wires left from the old component. Perform the soldering quickly and efficiently.

Solder Method of Removing and Replacing Components

On the wiring side of the board at the component to be replaced, heat the connections with an iron until the solder melts. Quickly remove the iron and brush away the solder using the wire brush. Two or more heating passes may be required; but take special care to avoid excessive heat.

Now the mechanical joint will be revealed. Insert a knife blade between the board and the exposed wire, and carefully raise the wire until it is perpendicular to the board and will come free in the next step. Again apply the soldering iron to the connection point while simultaneously moving the lead back and forth until it breaks free of the molten solder.

Take the replacement component, cut the leads to the desired length, insert them into the holes, bending the leads against the board to make mechanical connections, and solder the connections.

Replacing Electrolytic Capacitors,

Relays and Coils

The replacement of these types of components can be accomplished as follows:

- Step 1:* With the soldering iron, heat each connection and brush away melted solder. Some parts may require prying the mounting lugs perpendicular to the board in order to brush away the melted solder.
- Step 2:* Trim the lugs as close as possible to the board.
- Step 3:* Again apply the soldering iron to the connections, brush away the melted

solder.

- Step 4:* Insert replacement component and solder the connections.

Replacing of Tube Sockets

- Step 1:* With soldering iron, heat each connection and brush away melted solder. If the connections do not come free on the first pass, repeat the heating process until connections are broken.
- Step 2:* With a pen knife inserted between the socket lug and wiring foil, bend each lug upward — except the grounding lug.
- Step 3:* When all socket lugs have been freed from the wiring foil, heat the grounding lug until the solder melts and slowly pull the socket away from the board.

ORDERING PARTS

The purpose of the parts list is to aid you in ordering replacement parts. Ampex can offer fast and efficient service in providing normally replaceable parts of the components in the system when proper information is furnished. Parts listed according to the schematic reference symbol, a description of the part and the Ampex part number. The Ampex Corporation offers some replacement parts that are not necessarily exact replicas of those used on the original version of the equipment; but these parts are interchangeable with the original parts. The description column names the part, its composition, electrical value and manufacturer's number (or military specification when available)—and the AMPEX PART NUMBER.

Ampex part numbers are the exact designation for all parts used in Ampex equipment. For example, CAPACITOR, fixed: ceramic, .02 uf + 80%-20%, 500 vdcw; Sprague Part No. 36C205 will always bear the Ampex catalog number 030-059. **THIS IS THE NUMBER YOU SHOULD USE WHEN ORDERING REPLACEMENT PARTS.** The schematic reference number should NOT be used for ordering purposes as it will vary with different equipment types. Include the following information when ordering parts: Equipment Type, Equipment Serial Number, Ampex Part Number, Description of Part. Example: 4-030-059 capacitors for Series 354.

MODEL 354 ELECTRONIC ASSEMBLY PARTS LIST

Catalog Number 96601-01 thru -04

ELECTRONIC SUBASSEMBLY Catalog Number 96602-01

REF. NO.	PART DESCRIPTION	AMPEX PART NO.
1C1	CAPACITOR, Electrolytic: 3X15/450V	30770-03
1C2	CAPACITOR, Ceramic: disc, .05 mfd, 500 v, dcw, +80% -20%: Sprague Part No. 5HK-55	030-066
1C3	Same as 1C2	030-066
1C4	CAPACITOR, Paper: tubular, .068 mfd, ±10%, 400 vdcw: Sprague Part No. 89P68394	035-299
1C5	Same as 1C4	035-299
3C6	CAPACITOR, Variable: trimmer, 50-240 pfd, 175 vdcw: Arco Part No. 584	038-998
3C7	Same as 3C6	038-998
3C8	CAPACITOR, Variable: trimmer, 19-160 pfd, 175 vdcw: Arco Part No. 583	038-999
3C9	Same as 3C8	038-999
1C10	CAPACITOR, Electrolytic: tubular, 2 mfd, -10% +80%, 450 vdcw: Sprague Type DEE	031-991
1C11	Same as 1C10	031-991
1C12	CAPACITOR, Mylar: tubular, .47 mfd, ±20%, 400 vdcw: Goodall Type 600UPE	035-997
1C13	Same as 1C12	035-997
3C14	CAPACITOR, Variable: mica, 19-160 pfd, 175 vdcw: Arco Part No. 583	038-999
3C15	Same as 3C14	038-999
1C16	CAPACITOR, electrolytic: 40-10/450v, 40/250v	30769-05
1C17	CAPACITOR, Ceramic: 2000 pfd, 20%, 1000 vdcw: Sprague Formulation Part No. C-27 Case Size 33C	030-995
1C18	Same as 1C17	030-995
1C19	CAPACITOR, Mica: 300 pfd, 5%, 2000 vdcw: Cornell Dubilier Part No. 1AP20T3	034-990
3C20	CAPACITOR, Mica: .0012 mfd, 5%, 500 vdcw: Elmenco Part No. DM20F122J	034-230
3C21	Same as 3C20	034-230
1C23	CAPACITOR, Electrolytic: 4X 10/450 volts	30769-06
1C24	CAPACITOR, Ceramic: .02 mfd, +80% -20%, 500 vdcw: Sprague Part No. 36C205	030-059

REF.NO.	PART DESCRIPTION	AMPEX PART NO.
1C25	Same as 1C24	030-059
3C26	CAPACITOR, Mylar: tubular, .1 mfd, $\pm 10\%$, 400 vdcw: Cornell Dubilier Part No. WMF4P1E	035-999
3C27	Same as 3C26	035-999
1C28	CAPACITOR, Ceramic: disc, 33 pfd, 1000 vdcw, $\pm 5\%$: Sprague Part No. C27-40C	030-994
1C29	Same as 1C28	030-994
1C30	CAPACITOR, Electrolytic: 4 mfd, +150% -10%, 200 vdcw: Cornell Dubilier Part No. ECPB-EX9674	031-997
1C31	Same as 1C30	031-997
1C32	CAPACITOR, Electrolytic: tubular, 4 mfd, -10% +100%, 6 vdcw: Sprague Part No. 89D122	031-986
1C33	Same as 1C32	031-986
3C34	CAPACITOR, Ceramic: .01 mfd, 500 vdcw, Erie Part No. 811-.01	030-002
1C35	CAPACITOR, Electrolytic: tubular, 40 mfd, -10% +80%, 250 vdcw: Sprague Part No. type DEE	031-996
1C37	Same as 1C24	030-059
1C38	Same as 1C24	030-059
4C42	CAPACITOR, Electrolytic: tubular, 2000 mfd, 15 volts	96147-01
4C41	CAPACITOR, Electrolytic: tubular, 1000 mfd, -10% +250%, 15 vdcw: Cornell Dubilier Part No. BRHM-1510	031-034
2C43	CAPACITOR, paper: tubular, .0047 mfd, 20%, 600 vdcw: Sprague Part No. 73P47206	035-028
2C44	Same as 2C43	035-028
3C45	CAPACITOR, Paper: tubular, .047 mfd, 20%, 400 vdcw: Cornell Dubilier Part No. WMF4S47E	035-985
3C46	Same as 3C45	035-985
3C47	Same as 3C45	035-985
4C48	CAPACITOR, Ceramic: disc, .02 mfd, 500 vdcw: Erie Part No. 817-.02	030-001
3C49	CAPACITOR, Electrolytic: tubular, 25 mfd, 6 vdcw: Sprague Part No. 30D131A1	031-140
3C50	Same as 3C49	031-140
1CR1	DIODE, crystal: diffused silicon, 600 volts P.I.V.: Texas Instrument Part No. 1N2071	013-995

REF. NO.	PART DESCRIPTION	AMPEX PART NO.
1CR2	Same as 1CR1	013-995
4CR3	RECTIFIER, Selenium: single phase full wave center tap; 2.2 amps, 26v input: Radio Receptor Part No. C16S1C1E1G	582-999
3DS1	LAMP, Neon: miniature, red: Eldema Part No. type 1B9 Part 4774	060-999
3DS2	Same as DS1	060-999
3DS3	LAMP, Miniature: 6.3 vacw: 2 pin: General Electric Part No. 12	060-041
3DS4	Same as 3DS3	060-041
3DS5	Same as 3DS3	060-041
3DS6	Same as 3DS3	060-041
2F1	FUSE, Cartridge: 1/4 x 1-1/4, 3 amps, fast blow, 250V: Littelfuse Part No. 312003	070-001
2F2	FUSE, Cartridge: 1/4 x 1-1/4, .75 amps, slow-blow, 125V: Littelfuse Part No. 313.750	070-048
2J1	CONNECTOR, Receptacle: female, 3 contact: Cannon Part No. XLR-3-31	146-998
2J2	Same as 2J1	146-998
2J3	CONNECTOR, Receptacle: male, 3 contacts: Cannon Part No. XLR-3-32	147-999
2J4	Same as 2J4	147-999
2J5	CONNECTOR, Receptacle: male, 2 contacts: MS3102A-12S-3P	143-014
2J6	Same as 2J5	143-014
2J7	CONNECTOR, Receptacle: male, 2 contacts: MS3102A-10SL-4P	143-009
2J8	Same as 2J7	143-009
2J9	CONNECTOR, Receptacle: male, 3 contacts: MS-3102A-10S-3P	143-008
2J10	Same as 2J9	143-008
3J11	SOCKET, Turret: miniature, 7 pin: Vector Part No. 10-MB-12JW	150-013
3J12	Same as 3J11	150-013
3J13	SOCKET, Turret: miniature, 9 pin: Cinch Part No. 53F12621	150-020
3J14	Same as 3J13	150-020
4J15	SOCKET, Octal: mica: Cinch Part No. 12272 8 AM	150-010

REF. NO.	PART DESCRIPTION	AMPEX PART NO.
4J16	Same as 4J15	150-010
3J17	JACK, Phone: 3 conductor, single closed circuit: Carter Part No. J4	148-024
3J18	Same as 3J17	188-024
2J19	CONNECTOR, Receptacle: female, 6 contacts, 10 amps, 730 v rms: Jones Part No. S-306-AB	146-004
2J20	CONNECTOR, Receptacle: male, 2 contacts, 10 amps, 250 v: Hubbell Part No. 7466	147-013
4K1	RELAY: 3 contact; 20 mfd, 2 HY, .030 amps, dc at 350 volts, 1/2 amp dc at 130 volts	96133-01
4L1	CHOKER: 5.5 HY., $\pm 10\%$ with 50 ma dc	96135-01
4L2	CHOKER: 15 MH with 1.4 amps	96126-01
3M1	VU METER, zero $\pm 1/2$ DB at 25°C	96130-01
3M2	Same as 3M1	96130-01
3R1	RESISTOR, Variable: carbon, .100 K ohms, 2 watt, 10%: Allen Bradley Part No. JA1N056S104AZ	044-015
3R2	Same as 3R1	044-015
1R3	RESISTOR, Fixed: carbon, 100 K ohms, 1/2 watt, 10%: MIL-R-11-RC20GF104K	041-022
1R4	Same as 1R3	041-072
1R5	RESISTOR, Fixed: carbon, 2.2K ohms, 1/2 watt, 10%: MIL-R-11:RC20GF222K	041-052
1R6	Same as 1R5	041-052
1R7	RESISTOR, Fixed: composition, 750 K ohms, 1/2 watt, $\pm 5\%$: Allen Bradley Part No. type ED	041-971
1R8	Same as 1R7	041-971
1R9	RESISTOR, Fixed: carbon, 47K ohms, 1/2 watt, 10%: MIL-R-11:RC20GF473K	041-068
1R10	Same as 1R9	041-068
3R11	RESISTOR, Fixed: carbon, 220 K ohms, 1/2 watt, 20%: Allen Bradley Part No. Type E-B	041-243
3R12	Same as 3R11	041-243
3R13	TRIMMER, Potentiometer: linear taper, 250 K ohms, $\pm 30\%$	96131-01
3R14	Same as 3R13	96131-01
1R17	RESISTOR, Fixed: composition, 1K ohms, 1/4 watt, 10%: Allen Bradley Part No. Type C-B	041-979

REF. NO.	PART DESCRIPTION	AMPEX PART NO.
1R18	Same as 1R17	041-979
1R19	RESISTOR, Fixed: carbon, 560 ohms, 1/2 watt, 10%: MIL-R-11:RC20GF561K	041-045
1R20	Same as 1R19	041-045
1R21	RESISTOR, Fixed: carbon, 22K ohms, 2 watts, 10%: MIL-R-11:RC42GF223K	041-216
1R22	Same as 1R21	041-216
1R23	RESISTOR, Fixed: carbon, 8.2K ohms, 1 watt, 10%: MIL-R-11:RC32GF822K	041-157
1R24	Same as 1R23	041-157
3R25	RESISTOR, Fixed: carbon, 47K ohms, 1/2 watt, 10%: MIL-R-11:RC20GF474K	041-080
3R26	Same as 3R25	041-080
1R27	RESISTOR, Fixed: carbon, 100K ohms, 2 watts, 10%: MIL-R-11:RC42GF104K	041-224
1R28	Same as 1R27	041-224
3R29	RESISTOR, Fixed: carbon, 100 ohms, 1/2 watt, 5%: MIL-R-11:RC20GF101J	041-003
3R30	Same as 3R29	041-003
1R31	RESISTOR, Variable: linear taper, 1k Ohms, 3 watts, $\pm 20\%$: Chicago Telephone Supply Type UPE-200	044-995
1R32	RESISTOR, Fixed: carbon, 22K ohms, 1/2 watt, 5%: MIL-R-11:RC20GF223J	041-016
1R33	Same as 1R32	041-016
1R34	RESISTOR, Fixed: composition, 1 K ohms, 1/4 watt, 10%: Allen Bradley Part Type C-B	041-979
1R35	Same as 1R34	041-979
1R36	RESISTOR, Fixed: carbon, 470 ohms, 1 watt, 10%: MIL-R-11:RC32GF471K	041-141
1R37	RESISTOR, Fixed: carbon, 330 K ohms, 1/2 watt, 5%: MIL-R-11:RC20GF334J	041-028
1R38	Same as 1R37	041-028
1R39	RESISTOR, Fixed: wirewound, 330 K ohms, 1/2 watt, $\pm 2\%$: Cinema Part No. CE516E	043-995
1R40	Same as 1R39	043-995
1R41	RESISTOR, Fixed: carbon, 10 megohms, 1/2 watt, 10%: MIL-R-11:RC20GF106K	041-090
1R42	Same as 1R41	041-090

REF. NO.	PART DESCRIPTION	AMPEX PART NO.
1R43	RESISTOR, Fixed: carbon, 220 K ohms, 1/2 watt, 10%: MIL-R-11:RC20GF224K	041-076
1R44	Same as 1R43	041-076
1R45	RESISTOR, Fixed: wirewound, 24 ohms, 1/2 watt, ±5%: International Rectifier Corporation Type BW-1/2	043-996
1R46	Same as 1R45	043-996
1R47	RESISTOR, Fixed: wirewound, 820 ohms, 1/2 watt, ±5%: International Rectifier Corporation Type BW-1/2	043-997
1R48	Same as 1R47	043-997
1R49	RESISTOR, Fixed: carbon, 120 K ohms, 1/2 watt, 10%: MIL-R-11:RC20GF124K	041-073
1R50	Same as 1R49	041-073
1R51	RESISTOR, Fixed: carbon, 4.7 K ohms, 1/2 watt, 10%: MIL-R-11:RC20GF472K	041-056
1R52	Same as 1R3	041-072
1R53	Same as 1R3	041-072
3R54	Same as 3R13	96131-01
3R55	Same as 3R13	96131-01
1R56	RESISTOR, Fixed: carbon, 270 K ohms, 1/2 watt, 10%: MIL-R-11:RC20GF274K	041-077
1R57	Same as 1R56	041-077
1R58	RESISTOR, Fixed: composition, 2.4 megohm, 1/4 watt, 10%: Allen Bradley Part No. Type C-B	041-967
1R59	Same as 1R58	041-967
1R60	RESISTOR, Fixed: carbon, 270 ohms, 1/2 watt, 10%: MIL-R-11:RC20GF271K	041-041
1R61	Same as 1R60	041-041
1R62	RESISTOR, Fixed: carbon, 470 ohms, 1/2 watt, 10%: MIL-R-11:RC20GF471K	041-044
1R63	Same as 1R62	041-044
1R64	RESISTOR, Fixed: carbon, 200 ohms, 1/2 watt, 5%: MIL-R-11:RC20GF201J	041-334
1R65	Same as 1R64	041-334
1R66	RESISTOR, Fixed: carbon, 3.3K ohms, 1/2 watt, 10%: MIL-R-11:RC20GF332K	041-054
1R67	Same as 1R66	041-054

REF. NO.	PART DESCRIPTION	AMPEX PART NO.
3R68	RESISTOR, Fixed: carbon, 12K ohms, 1/2 watt, 10%: MIL-R-11:RC20GF123K	041-061
3R69	Same as 3R68	041-061
3R70	Same as 3R68	041-061
3R71	Same as 3R68	041-061
1R72	RESISTOR, Fixed: carbon, 2.2K ohms, 1 watt, 10%: MIL-R-11:RC20GF222K	041-150
1R73	RESISTOR, Fixed: carbon, 470 ohms, 1 watt, 10%: MIL-R-11:RC32GF471K	041-141
1R75	RESISTOR, Fixed: composition, 1 megohm, 1/4 watt, 10%: Allen Bradley Part No. Type C-B	041-968
1R76	Same as 1R75	041-968
1R77	RESISTOR, Fixed: carbon, 470 ohms, 1/2 watt, 10%: MIL-R-11:RC20GF471K	041-044
3R78	RESISTOR, Fixed: carbon, 100 ohms, 1/2 watt, 10%: MIL-R-11:RC20GF101K	041-038
3R79	Same as 3R78	041-038
3R80	Same as 3R78	041-038
2R81	Same as 3R78	041-038
4R82	RESISTOR, Fixed: carbon, 150 K ohms, 1 watt, 10%: MIL-R-11:RC30GF154K	041-172
4R83	Same as 4R82	041-172
3S1	SWITCH, Equalization: 2 position, shorting, 30° throw	96138-01
3S2	SWITCH, Slide A-B: 2 pole, 2 position, non shorting	96139-02
3S3	Same as 3S2	96139-02
3S4	SWITCH, Channel selector Rec.: 5 position, non- shorting, 30° throw	96142-01
3S5	SWITCH, pushbutton: No., single pole, Arrow H and H Part No. 3391 EPA	120-013
3S6	SWITCH, toggle: SPST, 6 amp, 125V; 3 amp 250V, Arrow H and H Part No. 86994-N	120-005
4T1	TRANSFORMER, Power: 117V 50 or 60 cycle at 25° C = 3 ohms ±10%	96144-01
3T2	TRANSFORMER, Output: 600 ohms (2 to 1) input 1.3 HY., output +18 dbm less than 1% distortion at 50 to 15 kc	96137-01
3T3	Same as 3T2	96137-01
1T4	COIL, Oscillator: 6.4 MHY ±5%	96103-01

REF. NO.	PART DESCRIPTION	AMPEX PART NO.
3TP1	JACK, Tip: red: E. F. Johnson Part No. 105-802	148-999
3TP2	Same as 3TP1	148-999
3TP3	JACK, Tip: black: E. F. Johnson Part No. 105-803	148-998
1V1	TUBE, Electron: 9 pin, 6AW8A: R.C.A. Part No.	021-099
1V2	Same as 1V1	012-099
1V3	TUBE, Electron: 9 pin, miniature, 12AX7: TeleFunken Part No.	012-024
1V4	TUBE, Electron: 9 pin, 6BK7A: General Electric Part No.	012-093
1V5	Same as 1V3	012-024
1V6	Same as 1V4	012-093
1V7	TUBE, Electron: 9 pin, miniature, 12BH7: R.C.A. Part No.	012-065
	BRACKET ASSEMBLY, Equalization (with sockets J11, J12, J13 and J14)	96092-01
	BRACKET ASSEMBLY, Plug-in input (with sockets J15 and J16)	96094-01
	NUT, Sleeve (circuit board mounting)	21078-01
	BOARD ASSEMBLY (includes all items with Prefix 1)	96057-01
	PLUG ASSEMBLY (Dummy) input	17420-01
	FUSEPOST, Finger operated short body: Littelfuse Part No. 342012	085-001
	HOLDER, Pilot Light	96140-01
	KNOB: 1-1/2 inch skirt, 1-1/8" wide: Harry Davies Part No.	230-003
	INDICATOR ASSEMBLY, Reset	50735-02
	SOCKET, Tube: 9 pin	30818-01
	SOCKET, Octal (board mounting)	150-078
	SHIELD, Tube: 9 pin 2-3/8"	160-020
	SHIELD, Tube: 7 pin 2-1/2"	160-999
	SHIELD, Tube: 9 pin 1-15/16"	160-012
	SHIELD, Tube: 9 pin, ventilated	160-998
	CABLE ASSEMBLY, Power line	2413-01
	CABLE ASSEMBLY, Transport power extension	3768-01
	CASE ASSEMBLY, Portable; electronics	4100-00

REF. NO.	PART DESCRIPTION	AMPEX PART NO.
	CASE ASSEMBLY, Portable; transport	5727-00
	CABINET CONSOLE	
	Includes:	
	Cabinet	5797-00
	Rail, right hand	5792-00
	Rail, left hand	5793-00
	Knob, electronics mounting (4 required)	5798-00
	Spring, compression (2 required)	5700-00
	Screw, oval head 12-24 x 1-1/4 (8 required)	471-654
	Washer, finishing +12 (8 required)	506-002
	KNOB, Reel Editing (NAB reels)	1917-00
	KNOB, Reel-holddown (NAB reels)	9093-00
	KNOB, Reel-holddown (EIA reels)	30971-01
	CONNECTOR, Receptacle: output, 24 contacts: MS3102A-24-28P	144-003
	CONNECTOR, Receptacle: input, 2 contacts: MS3102A-10SL-4P	145-009
	HEAD ASSEMBLY	30028-02
	SCREW, Allen head; black, 6-32 x 3/8 (2 required)	471-476

3.75 (120 u sec)/7.5 NAB REPRODUCE EQUALIZER, Cat. No. 96110-01

CAPACITOR, Mica: 750 pfd, 500 vdcw, 5%: Elmenco Part No. CM20C751J	034-144
PLUG and SHIELD: 9 pin, Vector Part No. G2.1-8F	099-006
RESISTOR, Fixed: carbon, 68 K ohms, 1/2 watt, 1%: Electra Part No. Type DC-1/2	042-088
RESISTOR, Fixed: carbon, 160 K ohms, 1/2 watt, ±1%: Electra Part No. DC-112	042-993
RESISTOR, Fixed: carbon, 82 K ohms, 1/2 watt, 1%: Electra Part No. DC-1/2	041-090

3.75 (200 u sec)/7.5 NAB REPRODUCE EQUALIZER, Cat. No. 96114-01

CAPACITOR, Mica: 750 pfd, 500 vdcw, 5%: Elmenco Part No. CM20C751J	034-144
PLUG and SHIELD: 9 pin: Vector Part No. G2.1-8F	099-006

REF. NO.	PART DESCRIPTION	AMPEX PART NO.
	RESISTOR, Fixed: carbon, 10 megohm, 1/2 watt, 10%: MIL-R-11:RC20GF106K	041-090
	RESISTOR, Fixed: carbon, 68K ohms, 1/2 watt, 1%: Electra Part No. Type DC-1/2	042-088
	RESISTOR, Fixed: carbon, .27 megohm, 1/2 watt, 1%: Electra Part No. Type DC-1/2	042-098

3.75/7.5 NAB RECORD EQUALIZER, Cat. No. 96120-01

	CAPACITOR, Mica: 470 pfd, 500 vdcw, 5%: Elmenco Part No. CM15C470J	034-108
	PLUG and SHIELD: 7 pin: Vector Part No. G2.2-8F	099-005
	RESISTOR, Fixed: carbon, .33 megohm, 1/2 watt, 1%: Electra Part No. Type DC-1/2	042-100
	RESISTOR, Fixed: carbon, 47K ohms, 1/4 watt, 5%: MIL-R-11:RC07GF473J	041-411

7.5/15 NAB REPRODUCE EQUALIZER, Cat. No. 96111-01

	CAPACITOR, Mica: 750 pfd, 500 vdcw, 5%: Elmenco Part No. CM20C751J	034-144
	PLUG and SHIELD: 9 pin, Vector Part No. G2.1-8F	099-006
	RESISTOR, Fixed: composition, 6.8 megohm, 1/4 watt, 10%: Allen Bradley Part No. Type C-B	041-975
	RESISTOR, Fixed: carbon, 68 K ohms, 1/2 watt, 1%: Electra Part No. Type DC-1/2	042-088
	RESISTOR, Fixed: carbon, 22 megohm, 1/2 watt, 10%: MIL-R-11:RC20GF226K	041-315

7.5/15 NAB RECORD EQUALIZER, Cat. No. 96121-01

	CAPACITOR, Mica: 150 pfd, 500 vdcw, 5%: MIL-C-5A: CM20C151J	034-049
	PLUG and SHIELD: 7 pin: Vector Part No. G2.2-8F	099-005
	RESISTOR, Fixed: carbon, .27 megohm, 1/2 watt, 1%: Electra Part No. Type DC-1/2	042-098

REF. NO.	PART DESCRIPTION	AMPEX PART NO.
----------	------------------	----------------

	RESISTOR, Fixed: carbon, 36 K ohm, 1/2 watt, 5%: MIL-R-11:RC20GF363J	041-456
--	---	---------

7.5 NAB/15 AME REPRODUCE EQUALIZER, Cat. No. 96112-01

	CAPACITOR, Mica: 750 pfd, 500 vdcw, 5%: Elmenco Part No. CM20C751J	034-144
	CAPACITOR, Mylar: tubular, 4.7 pfd, 200 vdcw, ±2%: Goodall Part No. Type 663-UW	035-992
	CAPACITOR, Mylar: tubular, 1 K pfd, 200 vdcw, ±2%: Goodall Part No. Type 663-UW	035-993
	PLUG and SHIELD: 9 pin: Vector Part No. G2, 1-8F	099-006
	RESISTOR, Fixed: composition, 6.8 megohm, 1/4 watt, 10%: Allen Bradley Part No. Type C-B	041-975
	RESISTOR, Fixed: carbon, 47 K ohms, 1/2 watt, 1%: Electra Part No. Type DC-1/2	042-086
	RESISTOR, Fixed: carbon, 68 K ohms, 1/2 watt, 1%: MIL-R-10509A:RN15X6802F	042-136
	RESISTOR, Fixed: carbon, 12 K ohms, 1/2 watt, ±1%: Electra Part No. Type DC-1/2	042-990

7.5 NAB/15 AME RECORD EQUALIZER, Cat. No. 96122-01

	CAPACITOR, Mica: 100 pfd, 500 vdcw, 5%: Elmenco Part No. CM15E101J	034-140
	CAPACITOR, Mica: 430 pfd, 300 vdcw, 5%: Elmenco Part No. Type DM-15	034-991
	PLUG and SHIELD: 7 pin: Vector Part No. G2, 2-8F	099-005
	RESISTOR, Fixed: carbon, .12 megohm, 1/2 watt, 1%: MIL-R-10509A:RN15R1203F	042-117
	RESISTOR, Fixed: carbon, .18 megohm, 1/2 watt, 1%: Electra Part No. Type DC-1/2	042-096
	RESISTOR, Fixed: carbon, .33 megohm, 1/2 watt, 1%:	042-100
	RESISTOR, Fixed: carbon, 47 K ohms, 1/4 watt, 5%: MIL-R-11:RC07GF473J	041-411

REF. NO.	PART DESCRIPTION	AMPEX PART NO.
----------	------------------	----------------

7.5/15 CCIR REPRODUCE EQUALIZER, Cat. No. 96113-01

CAPACITOR, Mica: 750 pfd, 500 vdcw, 5%: Elmenco Part No. CM20C751J	034-144
PLUG and SHIELD: 9 pin: Vector Part No. G2.1-8F	099-006
RESISTOR, Fixed: carbon, 47 K ohms, 1/2 watt, 1%: Electra Part No. Type DC-1/2	042-086
RESISTOR, Fixed: carbon, .12 megohm, 1/2 watt, 1%: MIL-R-10509A:RN15R1203F	042-117
RESISTOR, Fixed: carbon, 2.4K ohms, 1/2 watt, 5%: MIL-R-11:RC20GF242J	041-315

7.5/15 CCIR RECORD EQUALIZER, Cat. No. 96123-01

CAPACITOR, Electrolytic: tubular, 4 mfd, 6 vdcw; -10 +100%: Sprague Part No. TE-1083	031-229
CAPACITOR, Paper: tubular, .012 mfd., 100 vdcw, 10%: Cornell Dubilier Part No. WMF1512E	035-984
PLUG and SHIELD: 7 pin: Vector Part No. G2.2-8F	099-005
RESISTOR, Fixed: carbon, 47 K ohms, 1/4 watt, 5%: MIL-R-11:RC07GF473J	041-411
RESISTOR, Fixed: carbon, .237 megohm, 1/2 watt, 1%: Electra Part No. Type DC-1/2	042-983
RESISTOR, Fixed: carbon, 23.7K ohms, 1/2 watt, 1%: Electra Part No. Type DC-1/2	042-984

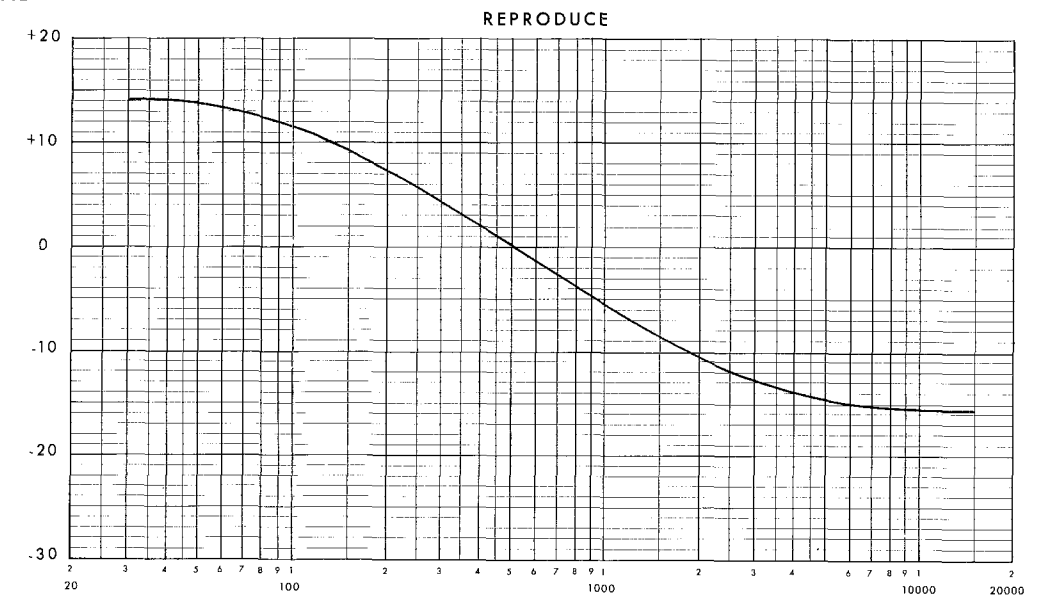
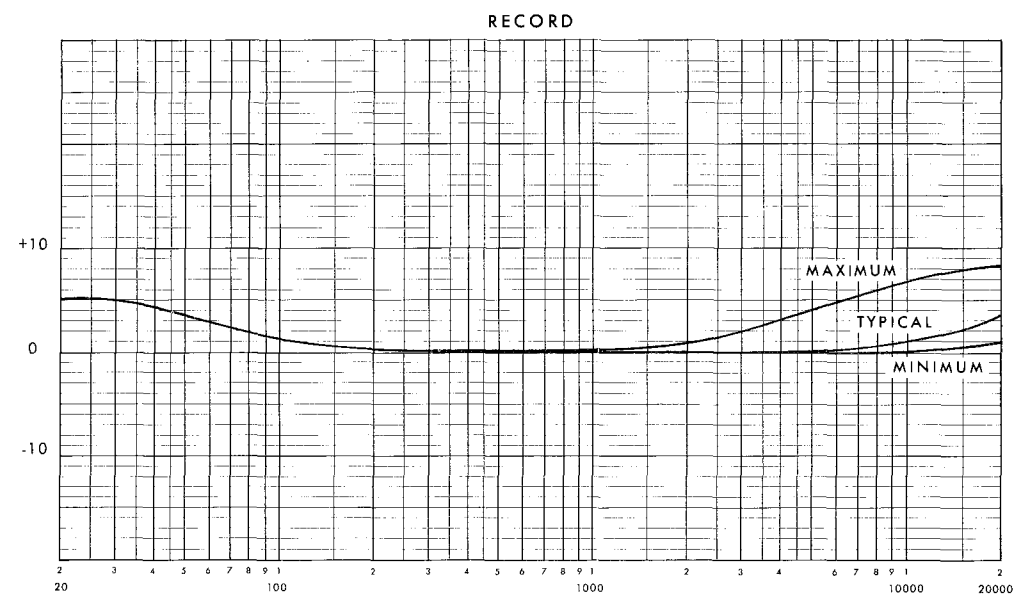
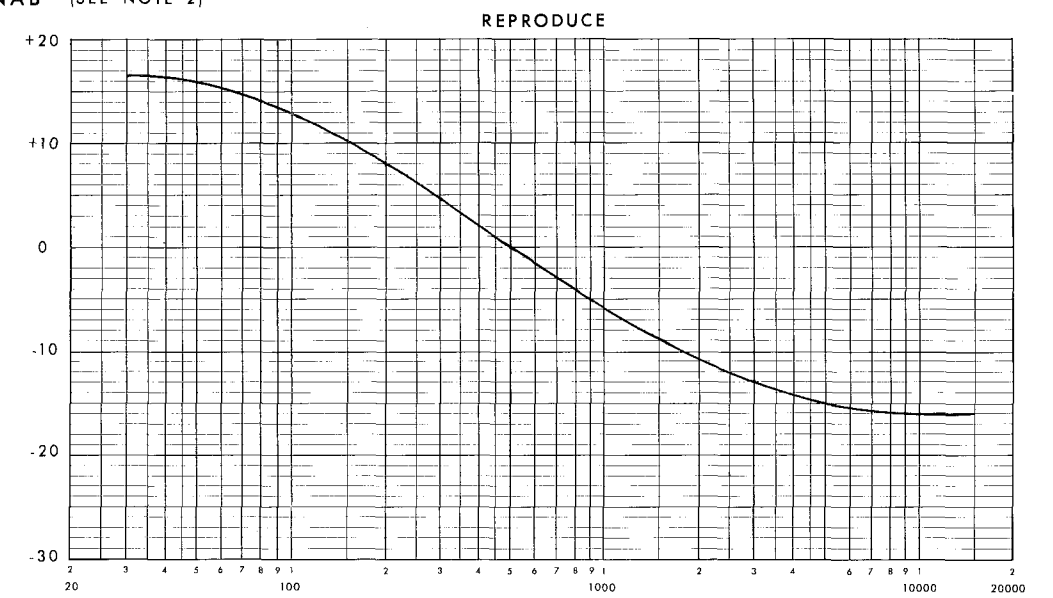
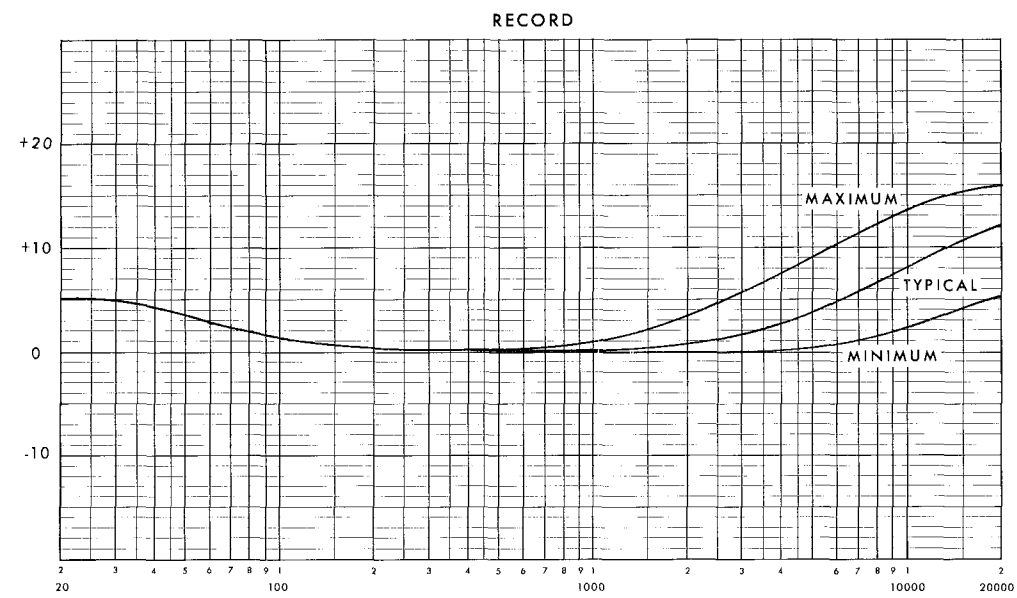
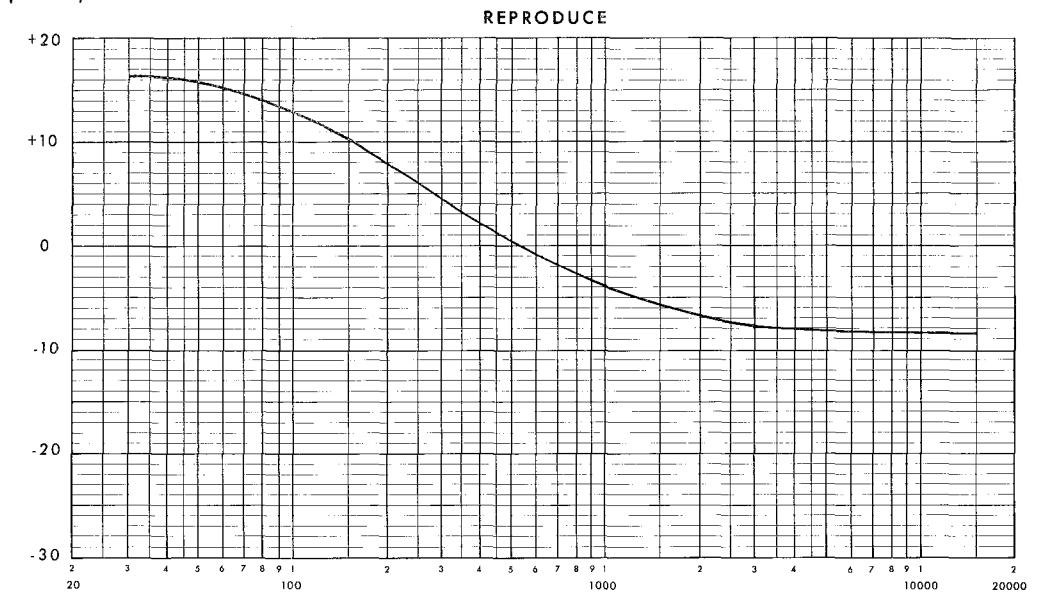
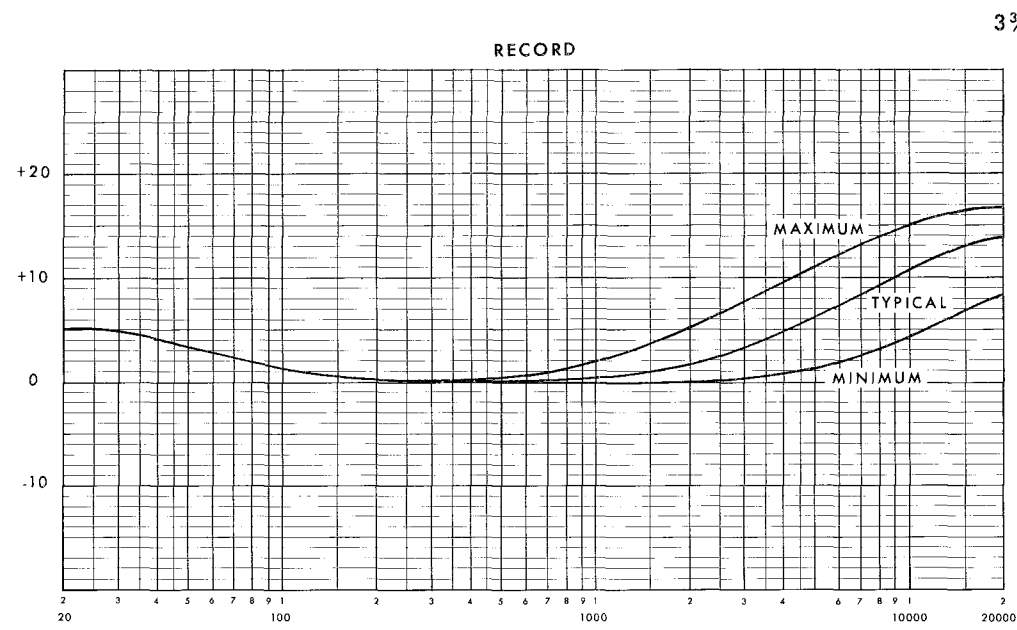

NOTE 1
RECORD CURVES SHOWN ARE APPROXIMATE AND WILL VARY WITH TAPE TO MAINTAIN FLAT OVERALL RESPONSE.

NOTE 2
USE THE 7 1/2 NAB REPRODUCE CURVE FOR THE 3 3/4 (120 μ sec)/7 1/2 NAB AND THE 7 1/2 NAB/15 NAB EQUALIZERS. FOR THE 7 1/2 NAB/15 NAB EQUALIZERS USE THE 15 NAB REPRODUCE CURVE.

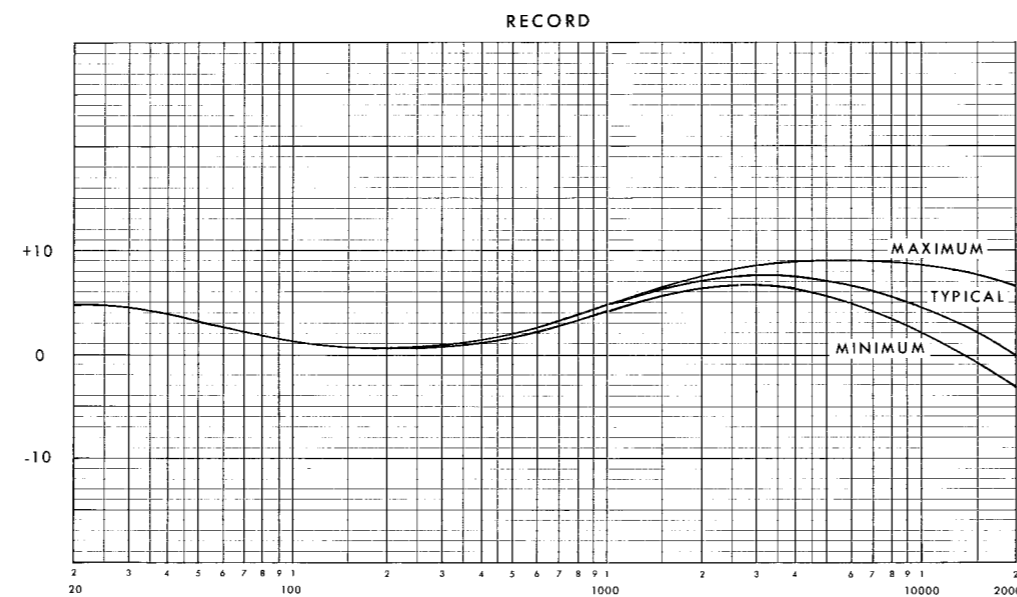

15ips AME

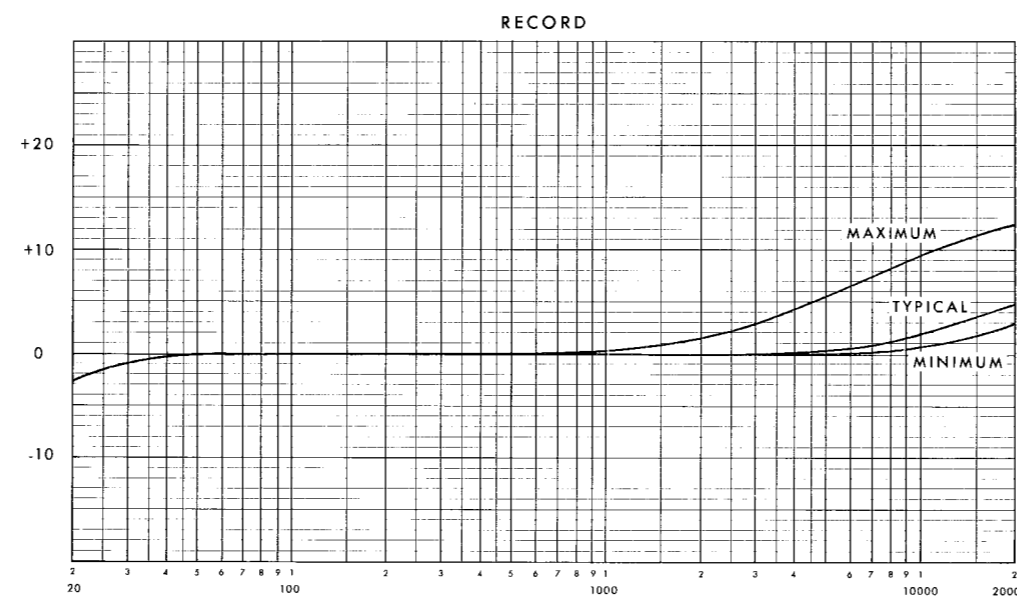
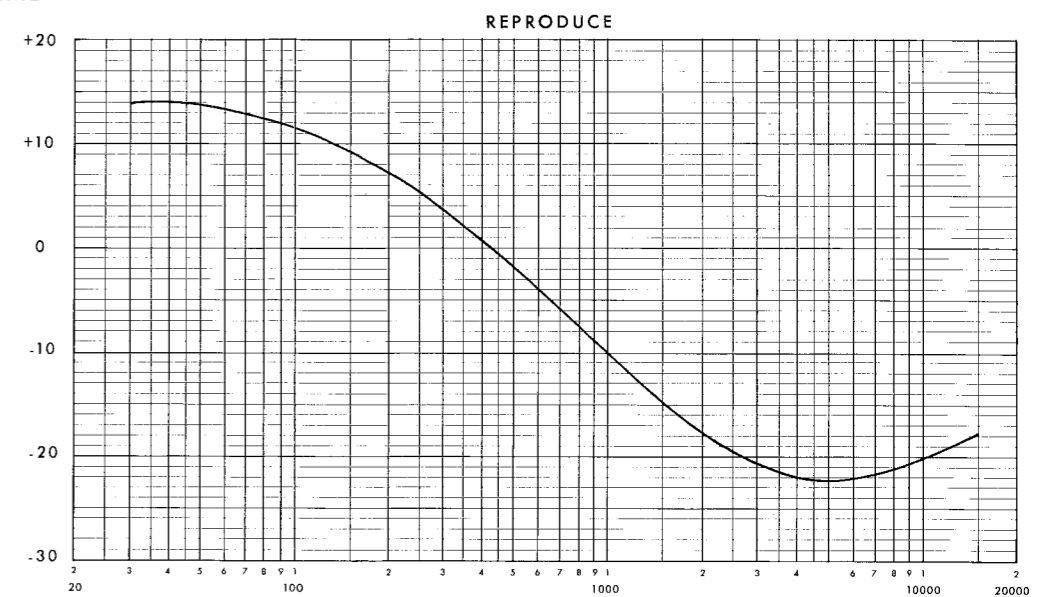

7 1/2ips CCIR

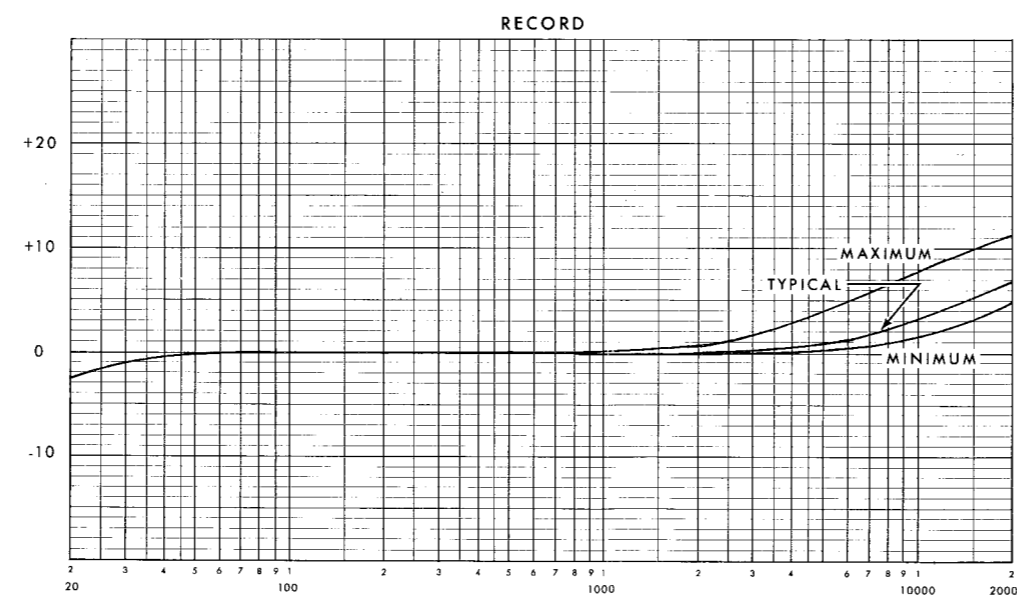
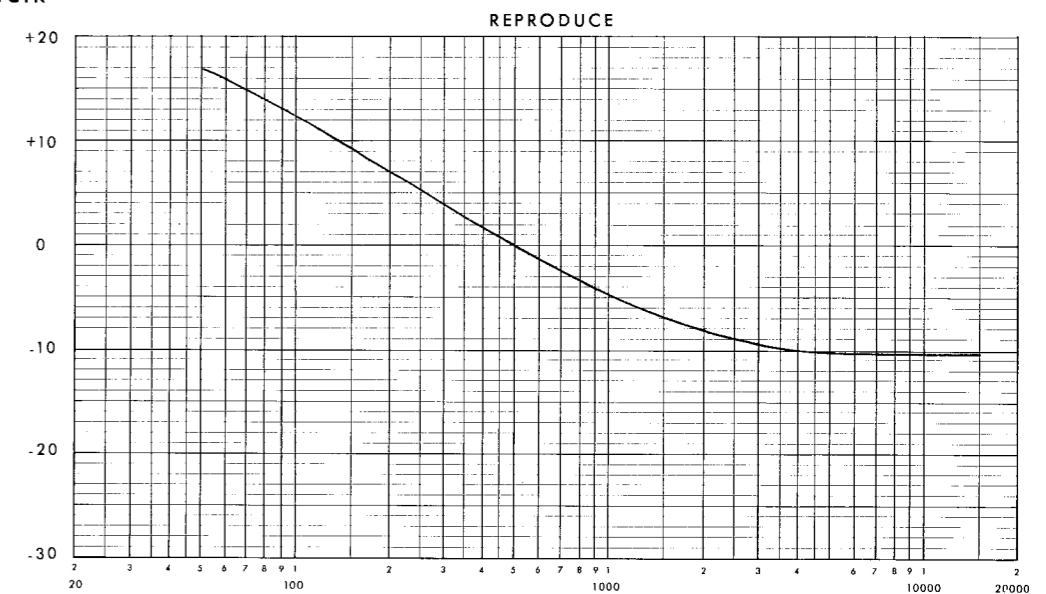

15ips CCIR

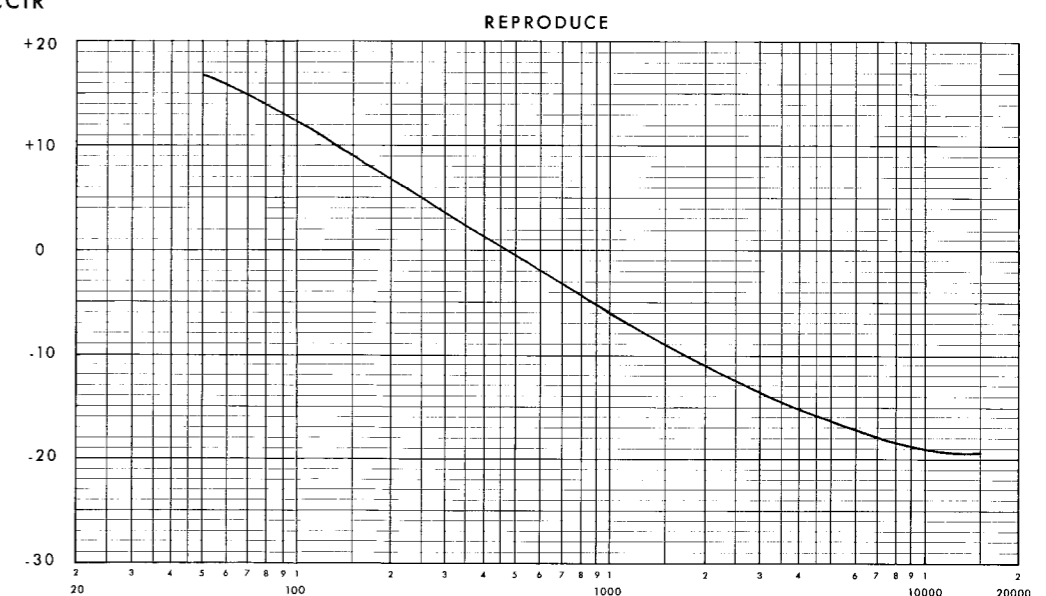

NOTES:
(SEE SHEET 1)

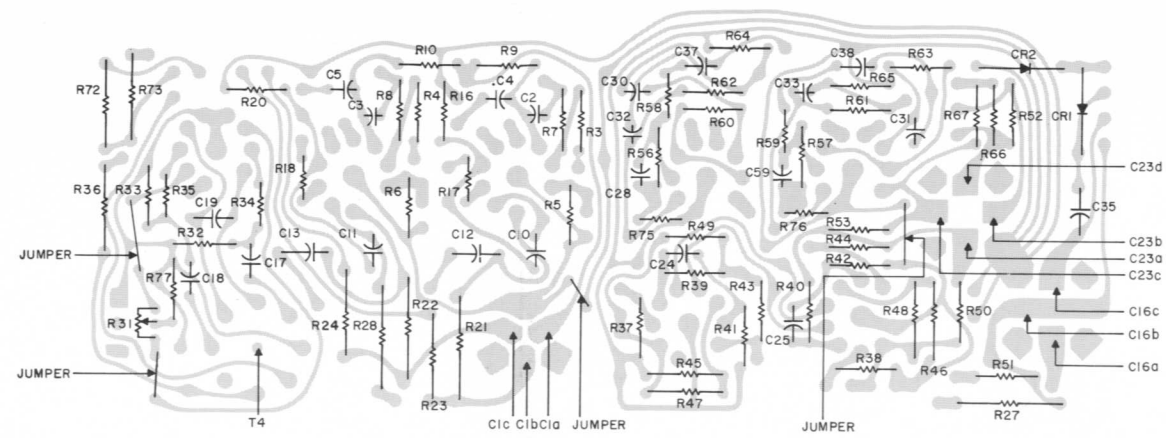

ETCHED BOARD COMPONENTS (TOP)*

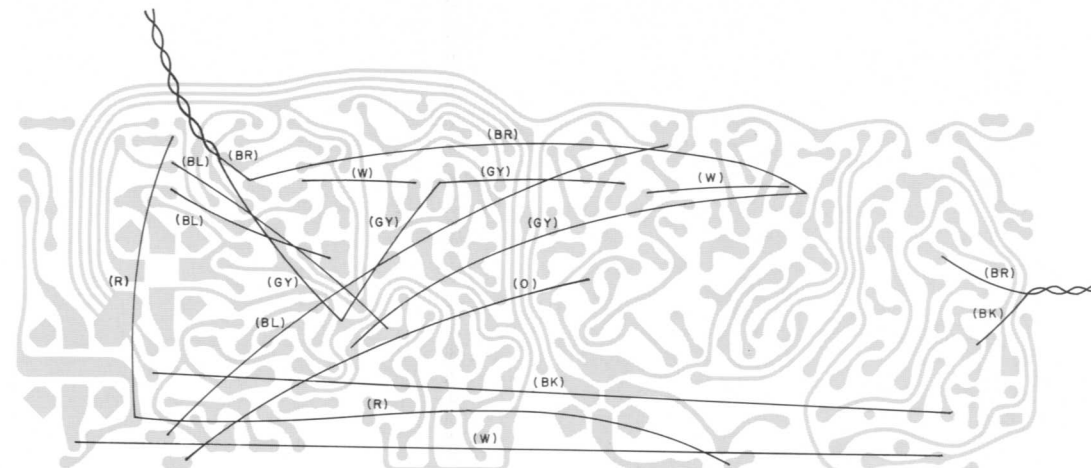

ETCHED BOARD JUMPERS (BOTTOM)

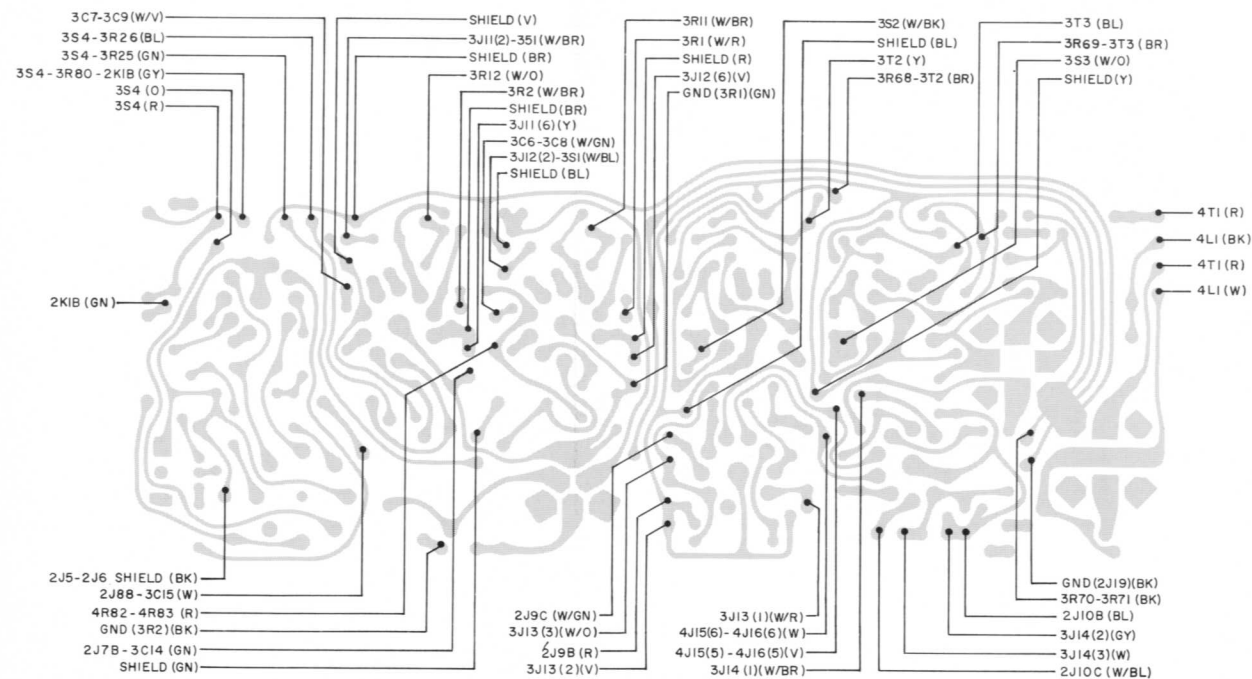

ETCHED BOARD CONNECTIONS (TOP)*

* CIRCUIT PATHS VIEWED THROUGH THE ETCHED BOARD.

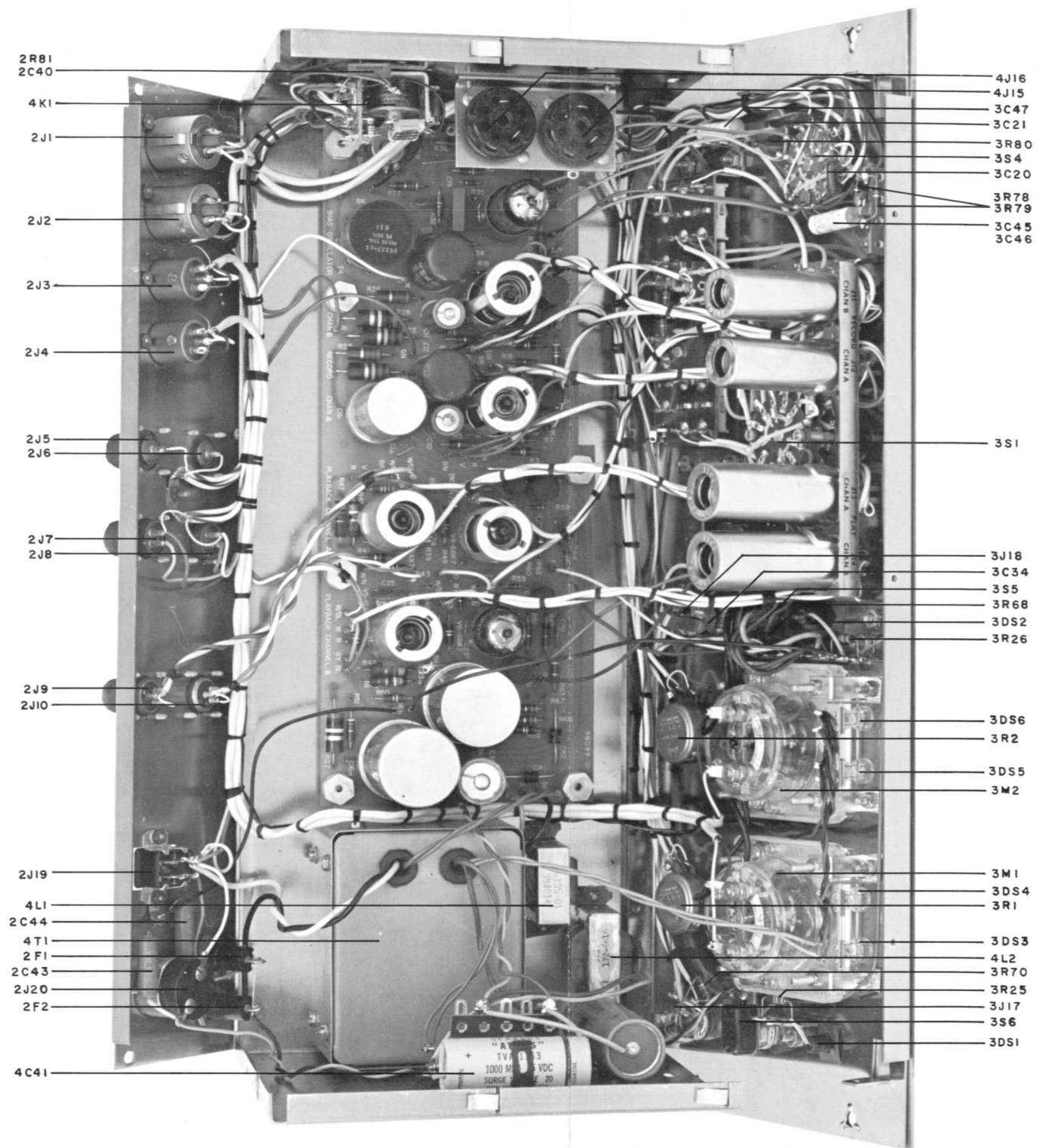

CHASIS PARTS LOCATION

PARTS LOCATION-ETCHED BOARD

**SCHEMATIC DIAGRAM -
354 ELECTRONIC ASSEMBLY**
Catalog No. 96601-01 thru -04
D-96603
(Sheet 1 of 2)

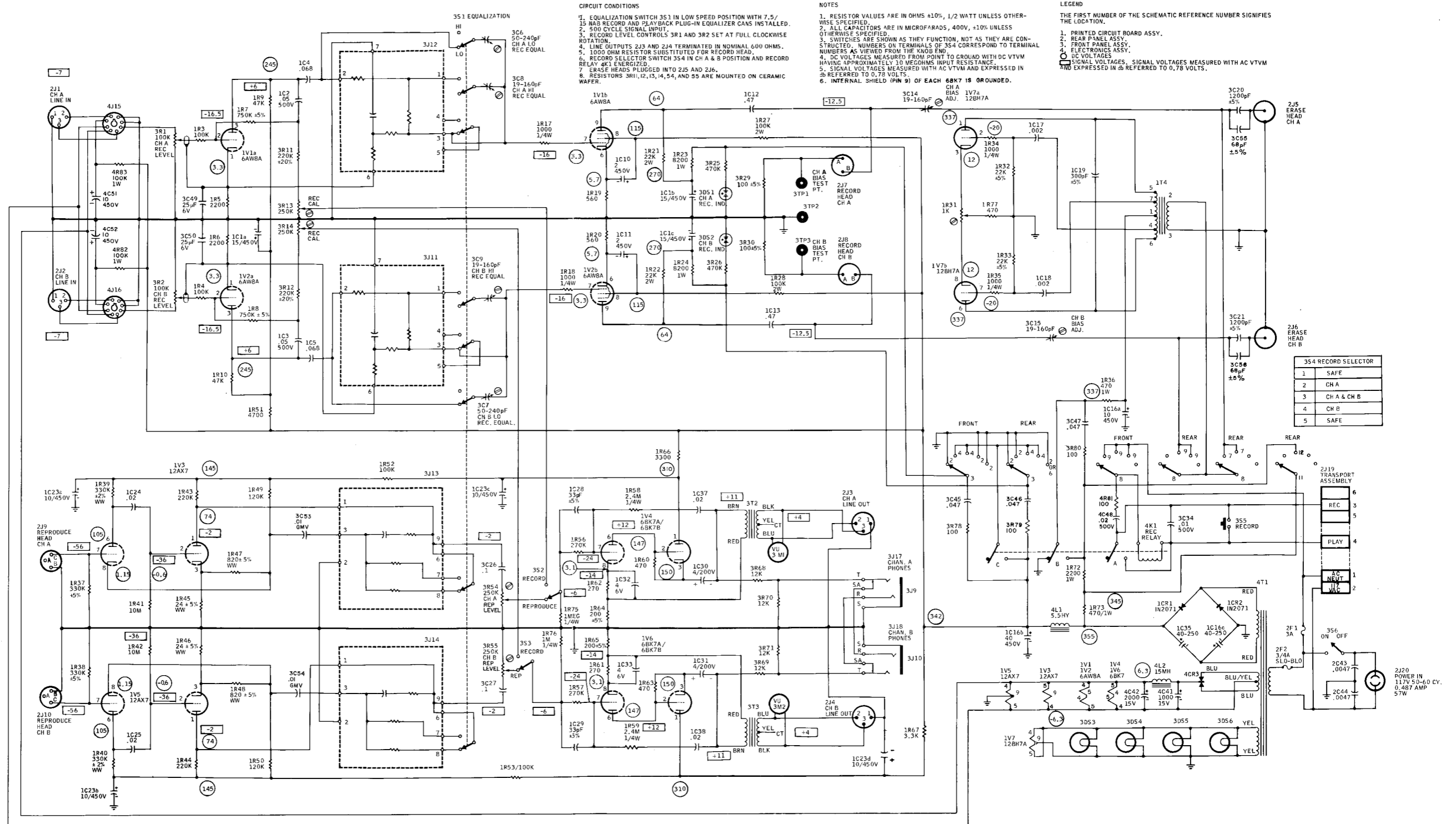

CIRCUIT CONDITIONS

1. EQUALIZATION SWITCH 3S1 IN LOW SPEED POSITION WITH 7.5/15 NAB RECORD AND PLAYBACK PLUG-IN EQUALIZER CANS INSTALLED.
2. 500 CYCLE SIGNAL INPUT.
3. RECORD LEVEL CONTROLS 3R1 AND 3R2 SET AT FULL CLOCKWISE ROTATION.
4. LINE OUTPUTS 2J3 AND 2J4 TERMINATED IN NOMINAL 600 OHMS.
5. 1000 OHM RESISTOR SUBSTITUTED FOR RECORD HEAD.
6. RECORD SELECTOR SWITCH 3S4 IN CH A & B POSITION AND RECORD RELAY 4K1 ENERGIZED.
7. ERASE HEADS PLUGGED INTO 2J5 AND 2J6.
8. RESISTORS 3R1, 12, 13, 14, 54, AND 55 ARE MOUNTED ON CERAMIC WAFER.

NOTES

1. RESISTOR VALUES ARE IN OHMS $\pm 10\%$, 1/2 WATT UNLESS OTHERWISE SPECIFIED.
2. ALL CAPACITORS ARE IN MICROFARADS, 400V, $\pm 10\%$ UNLESS OTHERWISE SPECIFIED.
3. SWITCHES ARE SHOWN AS THEY FUNCTION, NOT AS THEY ARE CONSTRUCTED. NUMBERS ON TERMINALS OF 3S4 CORRESPOND TO TERMINAL NUMBERS AS VIEWED FROM THE KNOB END.
4. DC VOLTAGES MEASURED FROM POINT TO GROUND WITH DC VTVM HAVING APPROXIMATELY 10 MEGOHMS INPUT RESISTANCE.
5. SIGNAL VOLTAGES MEASURED WITH AC VTVM AND EXPRESSED IN μ REFERRED TO 0.78 VOLTS.
6. INTERNAL SHIELD (PIN 9) OF EACH 6BK7 IS GROUNDED.

LEGEND

- THE FIRST NUMBER OF THE SCHEMATIC REFERENCE NUMBER SIGNIFIES THE LOCATION.
1. PRINTED CIRCUIT BOARD ASSY.
 2. REAR PANEL ASSY.
 3. FRONT PANEL ASSY.
 4. ELECTRONICS ASSY.
 5. DC VOLTAGES
 6. SIGNAL VOLTAGES. SIGNAL VOLTAGES MEASURED WITH AC VTVM AND EXPRESSED IN μ REFERRED TO 0.78 VOLTS.

354 RECORD SELECTOR	
1	SAFE
2	CH A
3	CH A & CH B
4	CH B
5	SAFE

SCHEMATIC DIAGRAM
 354 ELECTRONIC ASSEMBLY
 Catalog No. 96601-01 thru -04
 D-96603
 (Sheet 2 of 2)

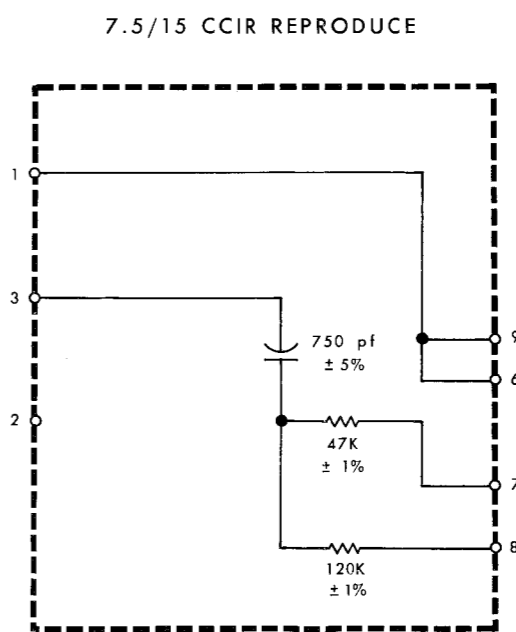
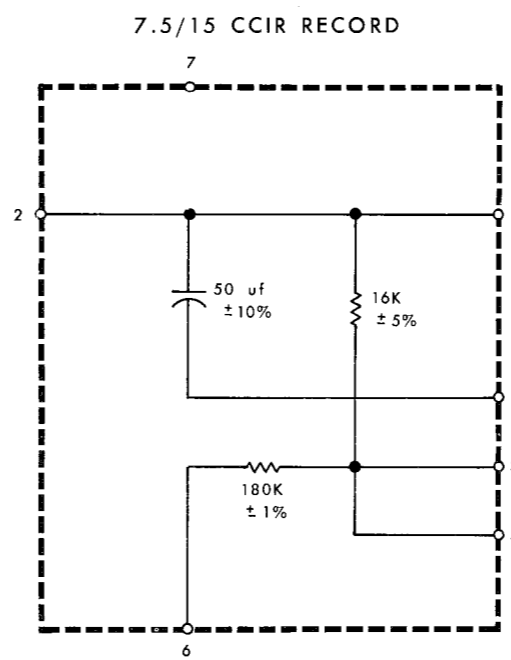
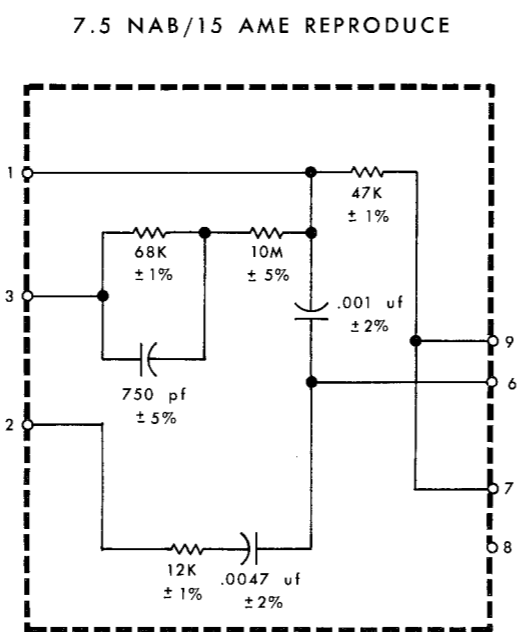
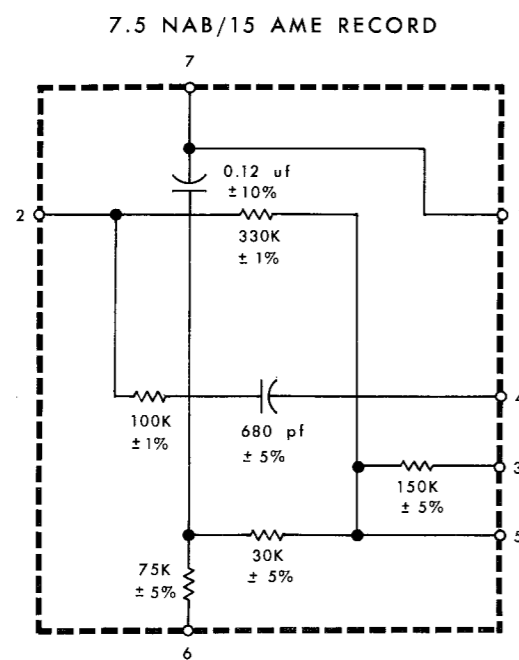
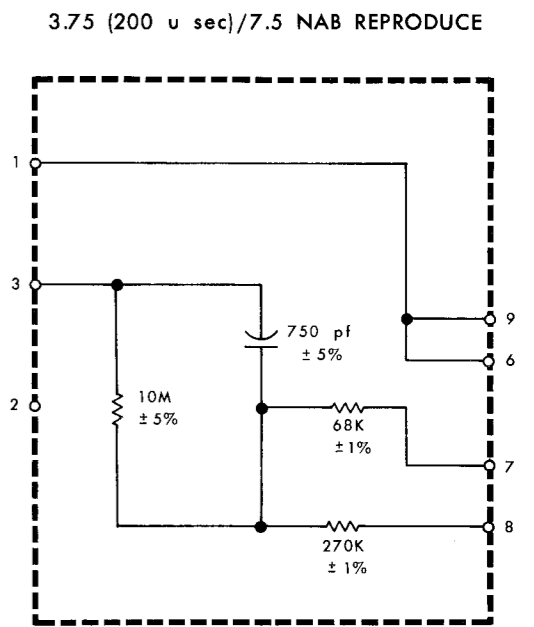
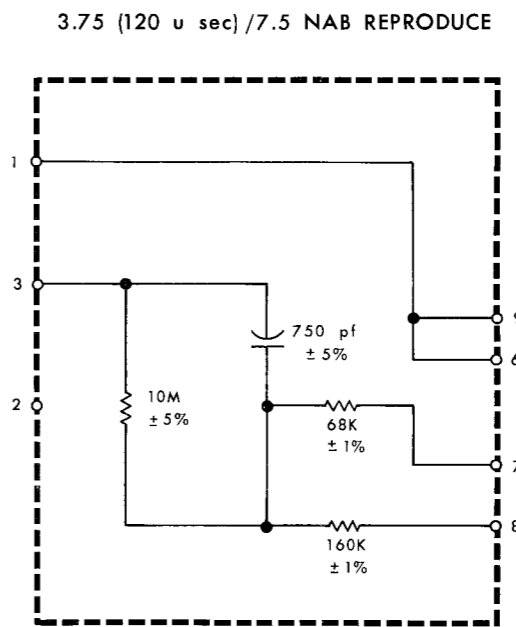
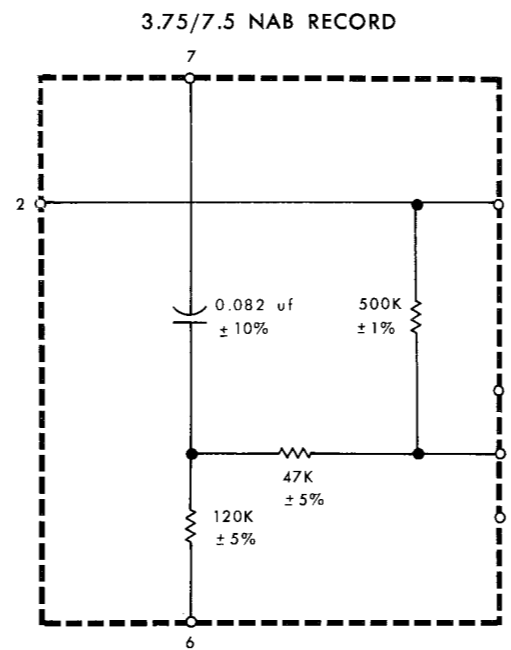
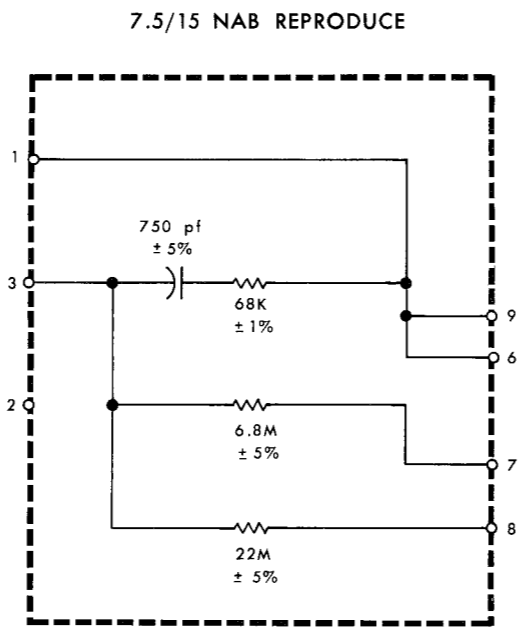
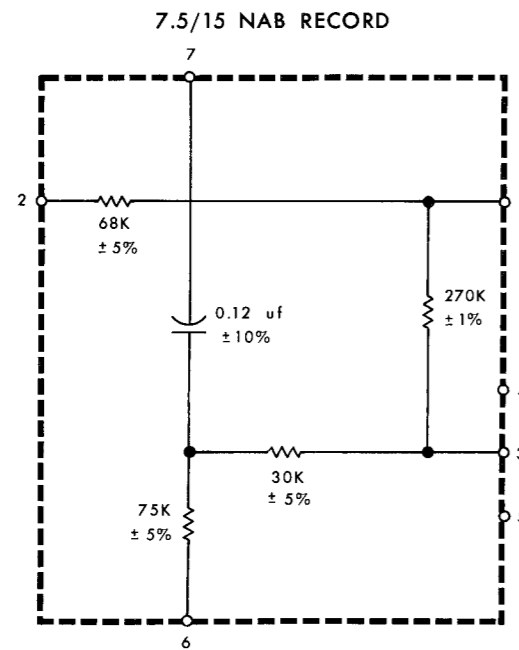

NOTE:
 The schematic diagrams shown here are of the plug-in equalizer assemblies for the 354 electronics. Typical plug-in equalizers are shown on the schematic diagram for the electronic assembly.

These equalizer schematics are included so that they may be cut out and posted on the main schematic diagram.

