

SERVICE NOTES

RADIO

3211A/00/01

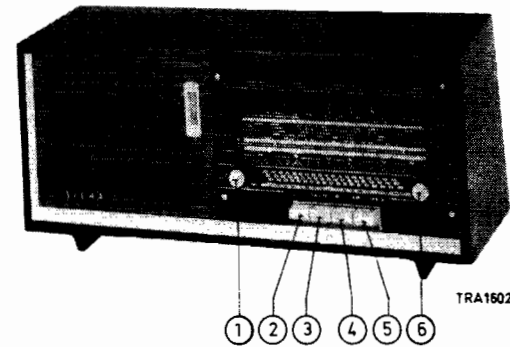

- | | | | | | | | | |
|---|---|--------------|---|---|--------------|---|--|------|
| ① | Volume control+
tone switch
Volumeregelaar+
toonschakelaar
Contrôle de volume+
commutateur de tonalité
Lautstärkereglert+
Klangschalter
Control de volumen+
comutador de tonalidad | R31
R31 | ③ | MW switch
MG-schakelaar
Commutateur PO
MW-Schalter
Commutador OM | SK-M | ⑤ | LW switch
LG-schakelaar
Commutateur GO
LW-Schalter
Commutador OL | SK-L |
| ② | Mains switch
Netschakelaar
Commutateur secteur
Netzschalter
Commutador de red | SK-B
SK-A | ④ | FM switch
FM-schakelaar
Commutateur FM
UKW-Schalter
Commutador FM | SK-F | ⑥ | Tuning
Afstemming
Syntonisation
Abstimmung
Sintonía | |
| | | | ③ | PU switch
PU-schakelaar
Commutateur PU
TA-Schalter | SK-M
SK-F | | | |
| | | | ④ | Commutador PU | | | | |

Loudspeaker	AD 3714	Luidspreker	Haut-parleur	Lautsprecher	AD 3714	Altavoz
IF	452 kc/s (AM) 10,7 Mc/s (FM)	MF	FI	ZF	452 kc/s (AM) 10,7 Mc/s (FM)	FI
Mains voltages	110-127-220 V~	Netspanningen	Tensions de secteur	Netzspannungen	110-127-220 V~	Tensiones de red
Consumption	32 W (220 V)	Verbruik	Consommation	Verbrauch	32 W (220 V)	Consumo
Output	1,5 W	Uitgangsvermogen	Puissance	Ausgangsleistung	1,5 W	Tension de salida
Dimensions	447x200x159 mm	Afmetingen	Dimensions	Abmessungen	447x200x159 mm	Dimensiones

WAVE RANGES - GOLFGEBIEDEN - GAMMES D'ONDES - WELLENBEREICHE - MARGENES DE ONDAS

MW - MG - PO - MW - OM	: 185 - 588 m	(1620 - 510 kc/s)
FM - FM - FM - UKW - FM	: 108 - 87,5 Mc/s	
LW - LG - GO - LW - OL	: 1154 - 2000 m	(260 - 150 kc/s)

VALVES - BUIZEN - TUBES - ROEHRN - VALVULAS

B1	-	ECH81
B2	-	EBF89
B3	-	ECL86
B4	-	EM87
L1	-	8024D/71

DIODES - TRANSISTORS

GR1	-	0A90
GR2,3	-	2- AA119
GR4	-	BA102
GR5	-	B 250 C100
TS1	-	AF124
TS2	-	AF125

SERVICE INFORMATION									
---------------------	--	--	--	--	--	--	--	--	--

HFD/PG

Copyright Central Service. N.V. PHILIPS' GLOEILAMPENFABRIEKEN, Eindhoven

93 750 06.1.90

Confidential information for Philips Service Dealers

Printed in Holland

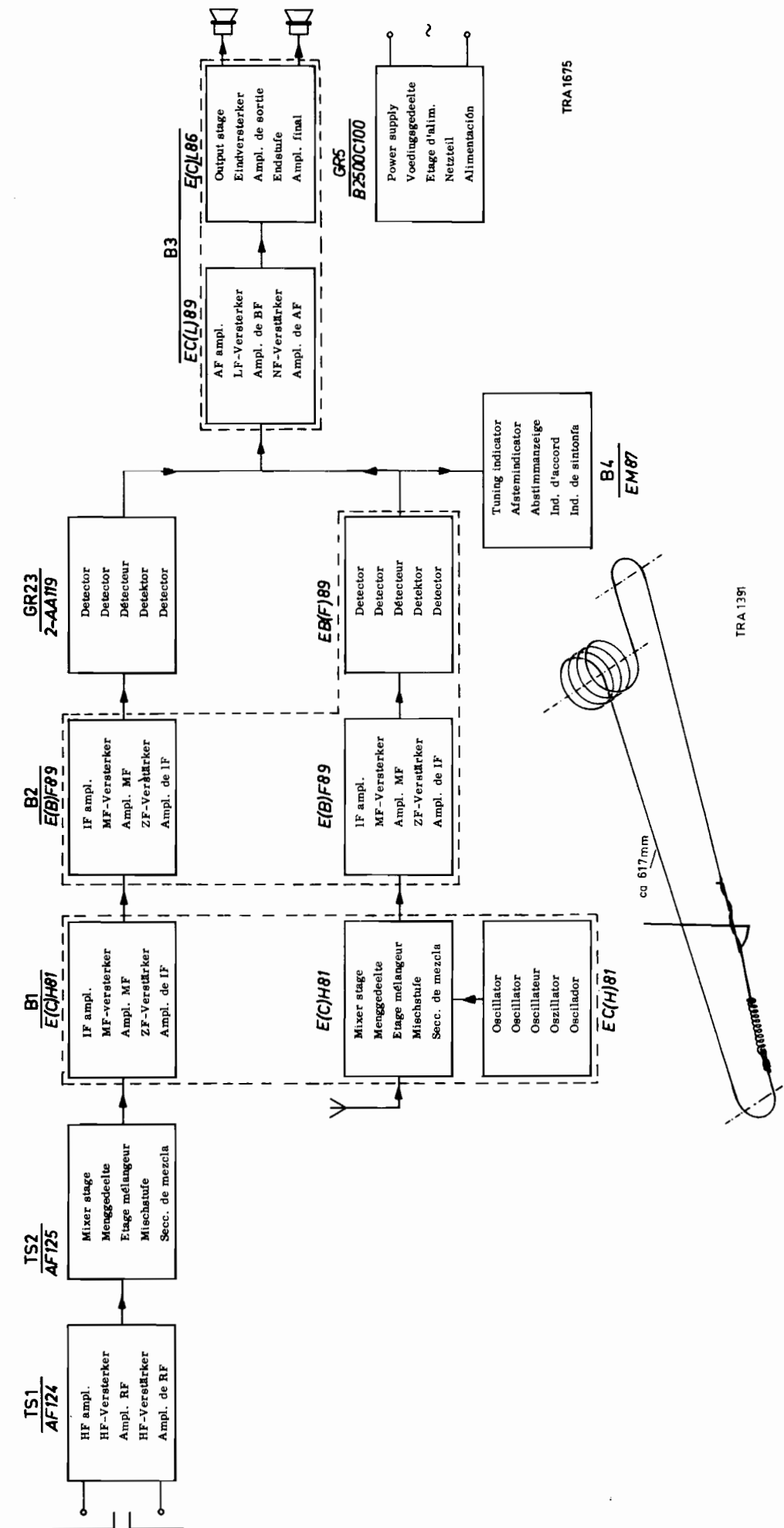

TRA 1675

TRA 1391

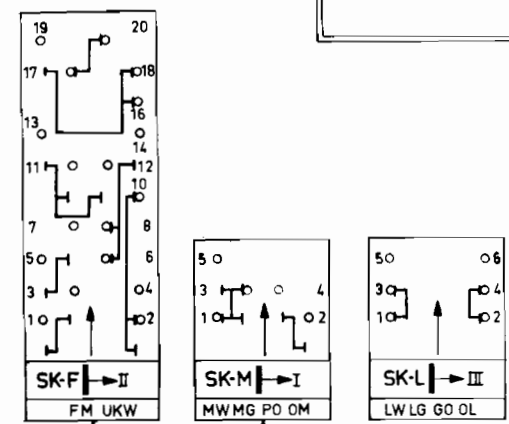
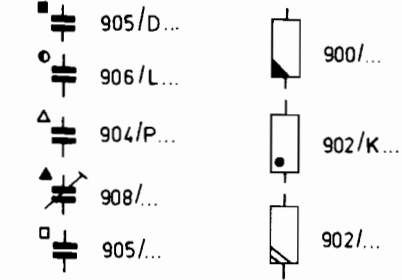
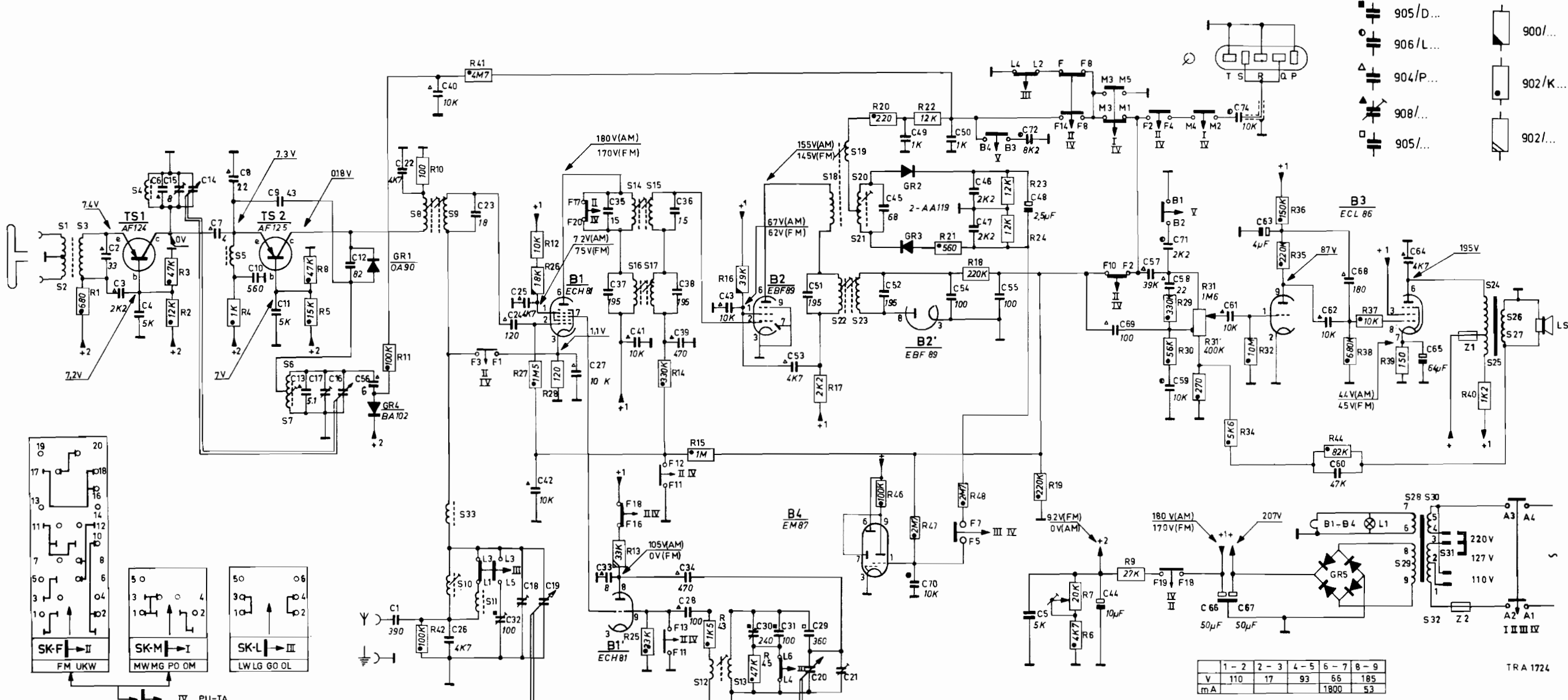
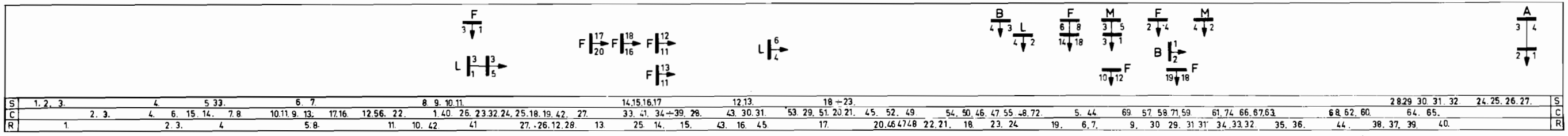

IV PU-TA
 SK-B V TONE-TOON-TONALITE-TON-TONOS.
 SK-A ON-IN-MARCHE-EIN-CONECTADO.

	1-2	2-3	4-5	6-7	8-9
V	110	17	93	65	185
mA				1800	53

Take original Service parts, then you are safe
 Utilisez les pièces détachées d'origine - c'est plus sûr
 Nimm doch original Service Teile, dann geht mann sicher
 Gebruik originele Service-onderdelen
 Para mayor seguridad - úsense las piezas de recambio primitivas

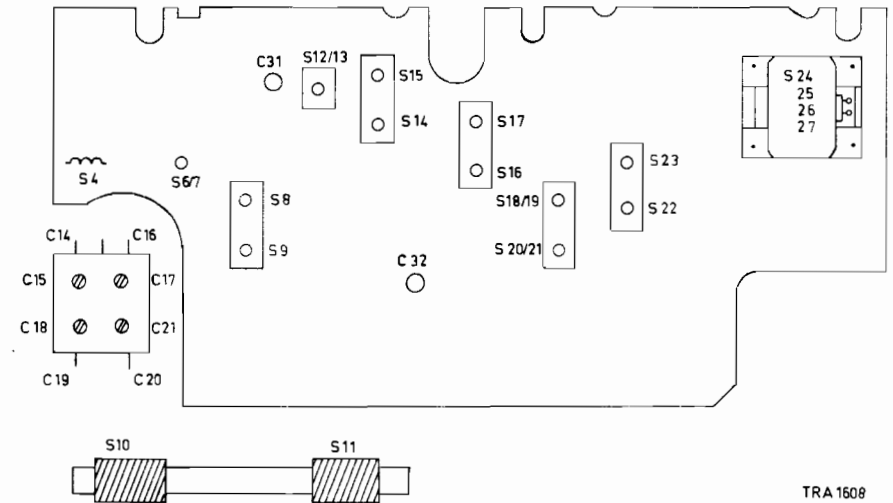

S	24252627										F	E										D	C										B	A										7	6	5	3 2 1 4			S
R	40.	38.	39.	31.	31.	37.	35.	36.	30.	29.	32.	33.	17.	16.	34.	44.	47.	2.20	19.	23.	21.	24.	48.	15.	41.	14.	13.	25.	27.	9.	43.	28.	6.	26.	12.	11.	42.	2.	5.	8.	4.	3.	12.	R						
C	63.	66.	67.	65.	64.	71.	72.	68.	59.	62.	61.	58.	60.	53.	70.	43.	57.	46.	47.	48.	40.	75.	39.	42.	74.	32.	41.	27.	24.	28.	34.	26.	25.	44.	56.	13.	12.	11.	5.	10.	1.	8.	9.	7.	6.	3.	2.	C		

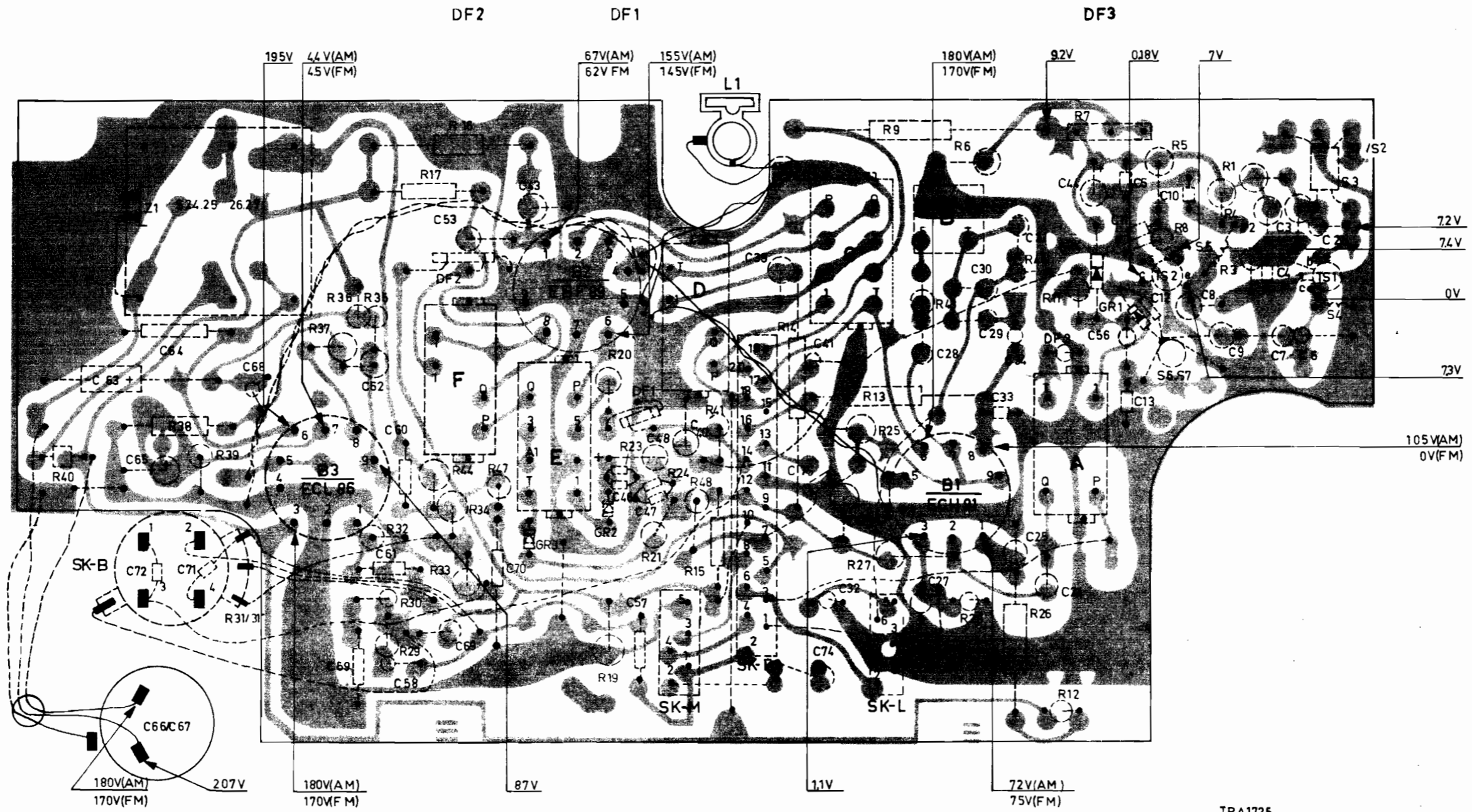

TRA1725

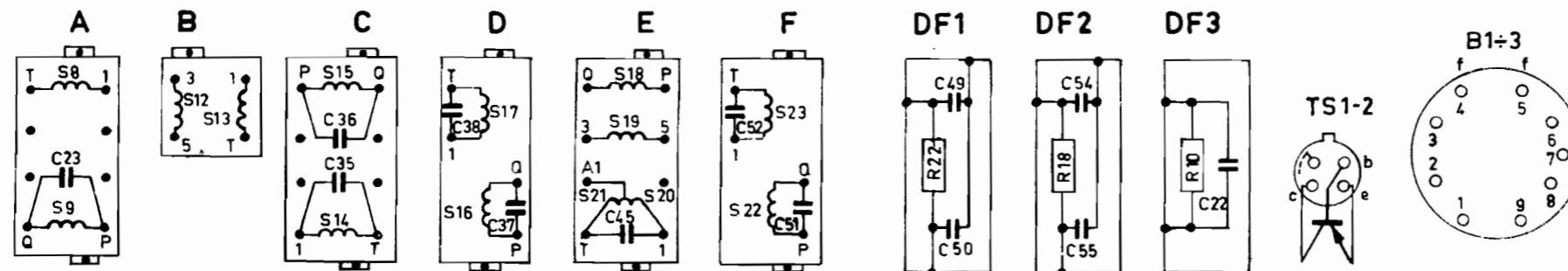

S	4	1	2	3	33	10	5	6	7	A	B	11	C	D	E	F	24	27	25	26	S																																						
R	2	1	3	4	8	5	7	42	11	12	26	6	43	28	9	25	13	27	14	41	15	48	24	21	23	19	20	47	44	34	16	33	17	32	29	30	36	35	37	31	31	39	38	40	R														
C	14	15	16	17	2	4	3	6	7	18	19	20	21	9	8	1	10	11	5	12	13	53	44	26	2	25	29	34	28	27	41	32	42	74	39	75	40	8	7	6	55	43	70	53	69	60	58	61	60	59	68	71	64	65	72	63	66	67	C

DF3

DF1

DF2

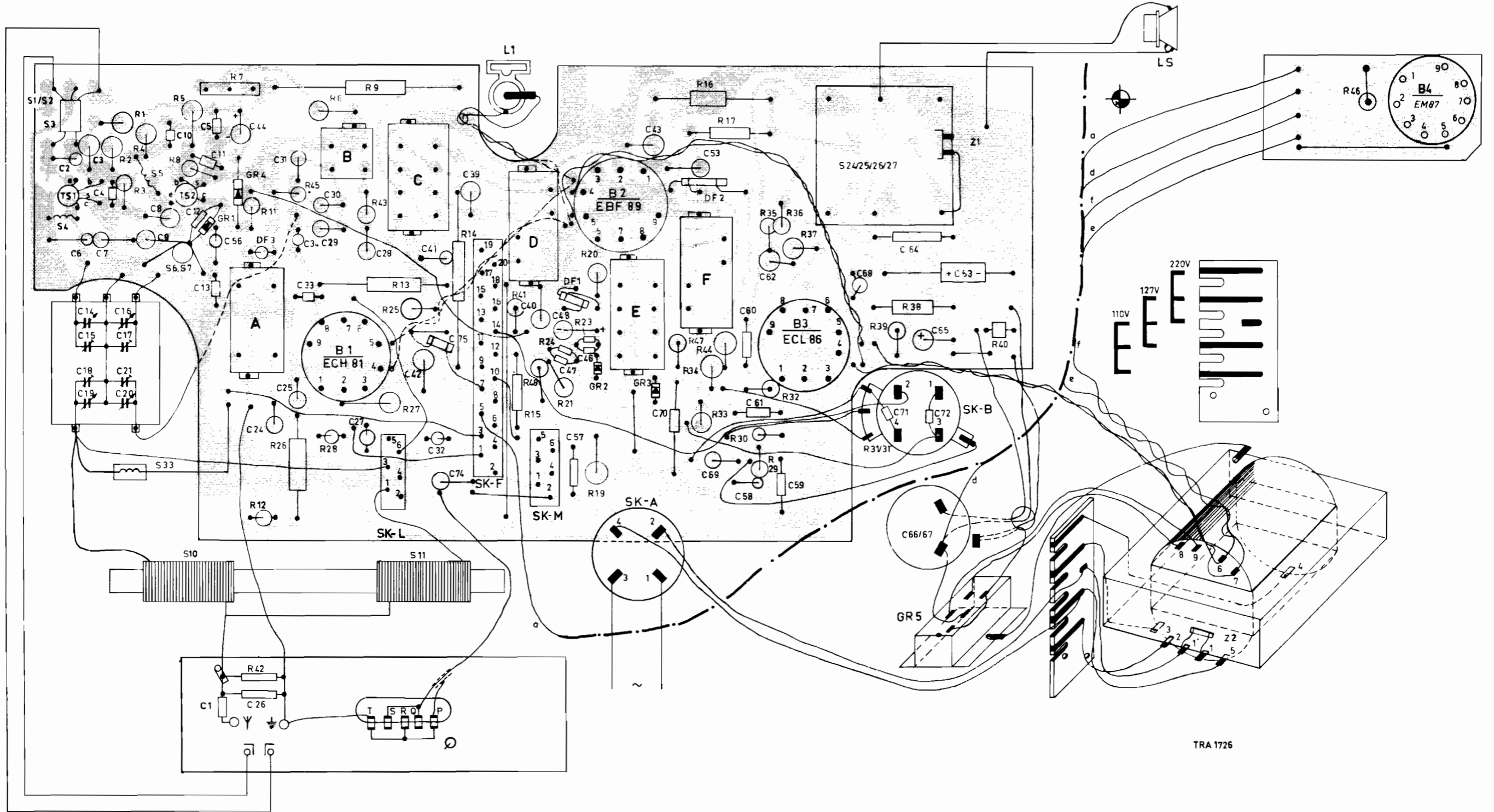

TRA 1726

Serv-o-mecum E-a-1 E-a-2 E-a-3	Wave range Golfgebied Gamme d'ondes Wellenbereich Margen de ondas	Trimming point Trimpunt Point de réglage Trimpunkt Punto de ajusta	Signal Signaal Signal Signal Señal	Trim Afregele Régler Abgleichen Ajustense	Indication Aanwijzing Indication Anzeige Indicación
IF-MF-FI-ZF-FI (AM)	MW-MG-PO-MW-OM	1620 kc/s	452 kc/s - 2B1 via 33000 pF	S22,S23,S16,S17	Max. output
RF-HF-HF-HF-RF (AM)	MW-MG-PO-MW-OM	510 kc/s	510 kc/s	S12,S13	Max. output
		1620 kc/s	1620 kc/s	C21	
	LW-LG-GO-LW-OL	510 kc/s	150 kc/s	C31	
		155 kc/s	155 kc/s	S10	
	MW-MG-PO-MW-OM	550 kc/s	550 kc/s	S11	
		1550 kc/s	1550 kc/s	C18	
	LW-LG-GO-LW-OL	155 kc/s	155 kc/s	S11	
		255 kc/s	255 kc/s	C32	
IF-MF-FI-ZF-FI (FM)	FM-UKW	87,2 Mc/s	1) 10,7 Mc/s via 15000 pF	2B2 S18 2) 2B1 S14,S15,S18 S8,S9,S18 S20,S21 4)	3) 5)
RF-HF-HF-HF-RF (FM)	FM-UKW	87,2 Mc/s	87,2 Mc/s	S6,S7	Max. DV 6)
		108,5 Mc/s	108,5 Mc/s	C17	
		88,5 Mc/s	88,5 Mc/s	S4	
		107,5 Mc/s	107,5 Mc/s	C15	

- 1) The signal to be applied is FM-modulated with 20 kc/s sweep.
- 2) Disconnect C48. Connect an oscilloscope to junction R24, R21, C47 via the accompanying network.
- 3) Adjust the response curve to maximum height and symmetry.
- 4) Connect C48. Shift the network to junction DF1, R41.
- 5) Adjust the S-curve to maximum height and symmetry.
- 6) Connect the DV across C48.

- 1) Het toe te voegen signaal is FM-gemoduleerd met zwaai van 20 kHz.
- 2) C48 losmaken. Sluit een oscillograaf aan via bijgeaand netwerk op het knooppunt R24, R21, C47.
- 3) Afregelen op max. hoogte en symmetrie van de doorlaatkromme.
- 4) C48 vastmaken. Netwerk verleggen naar knooppunt DF1, R41.
- 5) Afregelen op max. hoogte en symmetrie van de S-kromme.
- 6) Sluit de DV aan over C48.

- 1) Le signal a appliquer est modulé en fréquence avec une excursion de 20 kHz.
- 2) Déconnect C48. Connecter un oscilloscope au point nodal R24, R21, C47 via le réseau joint.
- 3) Ajuster à la hauteur et à la symétrie maximales de la courbe de réponse.
- 4) Connecter C48. Déplacer le réseau au point nodal DF1, R41.
- 5) Ajuster à la hauteur et à la symétrie maximales de la courbe S.
- 6) Connecter le voltmètre à diode à travers C48.

- 1) Das zuzuführende Signal ist FM-moduliert mit einem Hub von 20 kHz.
- 2) C48 lösen. Einen Oszillografen über das beigefügte Netzwerk an den Knotenpunkt R24, R21, C47 anschliessen.
- 3) Auf maximale Höhe und Symmetrie der Durchlasskurve abgleichen.
- 4) C48 befestigen. Netzwerk nach Knotenpunkt DF1, R41 verlagern.
- 5) Auf maximale Höhe und Symmetrie der S-Kurve abgleichen.
- 6) Das Diodevoltmeter über C48 anschliessen.

- 1) La señal a aplicar está modulada en frecuencia con una excursión de 20 kc/s.
- 2) Suéitese C48. Conéctese un oscilógrafo a través de la red adyacente a la unión R24, R21, C47.
- 3) Ajustese a altura máxima y simetría de la curva de paso.
- 4) Fijése C48. Trasládese la red a la unión DF1, R41.
- 5) Ajustese a altura máxima y simetría de la curva S.
- 6) Conéctese el voltímetro de diodo en paralelo a C48.

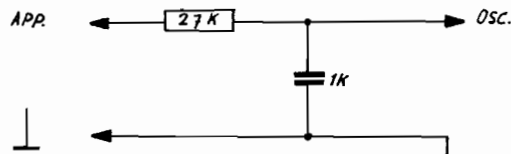

Cabinet /00 (light)	4822 193 00819	Kast /00 (licht)	Ebénisterie /00 (clair)	Gehäuse /00 (hell)	4822 193 00819	Mueble /00 (claro)
Cabinet /01 (dark)	4822 193 00825	Kast /01 (donker)	Ebénisterie /01 (obscur)	Gehäuse /01 (dunkel)	4822 193 00825	Mueble /01 (obacuro)
Push button (3,4,5)	4822 193 00823	Druktoets (3,4,5)	Touche pousseur (3,4,5)	Drucktaaste (3,4,5)	4822 193 00823	Pulsador (3,4,5)
Push button (2)	4822 193 00824	Druktoets (2)	Commuteur secteur	Netzschalter	4822 193 00824	Commutador de red
Mains switch	4822 072 00083	Nettschakelaar	Commutateur secteur	Netzschalter	4822 072 00083	Commutador de red
Mains switch lever	4822 193 00774	Hefboom netschakelaar	Levier comm. secteur	Hebel Netzschalter	4822 193 00774	Palanca commutador de red
Link for slide	4822 193 00776	Koppelstuk voor schuif	Fièver de couplage pour tiroir	Kopplungsstück für Schieber	4822 193 00776	Pieza de acoplo para deslizador
Knob (1,6)	4822 116 00903	Knop (1,6)	Bouton (1,6)	Knopf (1,6)	4822 116 00903	Botón (1,6)
Tuning spindle with pulley	4822 193 00827	Afstemas met rol	Axe de syntonisation avec rouleau	Abstimmachse mit Seilrolle	4822 193 00827	Eje de sintonía con rollo
Voltage adaptor	4822 193 00768	Spanningsomschakelaar	Carrrousel de tension	Spannungswähler	4822 193 00768	Selecteur de tension
Spring in knob (1,6)	A3 818 38	Veer in knop (1,6)	Ressort dans bouton (1,6)	Feder in Knopf (1,6)	A3 818 38	Resorte en botón (1,6)
Pulley (9 mm)	4822 208 00255	Rol (9 mm)	Rouleau (9 mm)	Seilrolle (9 mm)	4822 208 00255	Rollo (9 mm)
Lampholder	A3 311 15	Lamphouder	Supporte de lampe	Lampenfassung	A3 311 15	Soporte de lampe
Socket aerial	4822 193 00782	Stekerbuis antenne	Bouille antenne	Steckerbuchse Antenne	4822 193 00782	Enchufe hembra PU
Socket FU	979/F5x1	Stekerbuis FU	Fiche femelle FU	Kontrastecker TA	979/F5x1	
Slide switch MW	4822 193 00809	Schuifschakelaar MG	Comm. à glisser PO	Schiebeschalter MW	4822 193 00809	Comm. deslizante OM
Slide MW	4822 193 00811	Schuif MG	Tiroir PO	Schieber MW	4822 193 00811	Deslizador OM
Slide switch FM	4822 193 00812	Schuifschakelaar FM	Comm. à glisser FM	Schiebeschalter UKW	4822 193 00812	Comm. deslizante FM
Slide FM	4822 193 00813	Schuif FM	Tiroir FM	Schieber UKW	4822 193 00813	Deslizador FM
Slide switch LW	4822 193 00814	Schuifschakelaar LG	Comm. à glisser GO	Schiebeschalter LW	4822 193 00814	Commutador deslizante OL
Slide LW	4822 193 00815	Schuif LG	Tiroir GO	Schieber LW	4822 193 00815	Deslizador OL
Screw fix. scale	A3 136 92	Schroef bev. schaal	Vis fix. cadran	Schraube Bef. Skala	A3 136 92	Tornillo fij. escala
S1		Input coil FM	Oscillator coil MW+LW	S22)		IF band-pass filter AM
S2		Ingangspoel FM	Oscillatorspoel MG+LG	S23)		MF-bandfilter AM
S3	4822 193 00789	Bobine d'entrée FM	Oszillatorspule FO+GO	C51)	A3 910 39	Filterre passe-bande FI,AM
		UKW-Eingangsspule	Oszillatorspule MW+LW	C52)		ZF-Bandfilter, AM
		Bobina de entrada FM	Bobina de oscilador OM+OL			Filterre de pasabanda FI,AM
S5	4822 193 00792	IF coil FM	IF band-pass filter FM	S24)		Loudspeaker transformer
		Ingangspoel FM	MF-bandfilter FM	S25)		Luidsprekertransformator
		Bobine FI,FM	Filterre passe-bande FI,FM	S26)	4822 193 00798	Transformateur de h-p
		ZF-Spule UKW	ZF-Bandfilter UKW	S27)		Lautsprechertransformator
		Bobina FI,FM	Filterre de pasabanda FI,FM	Z1)		Transformador de altavoz
S8		IF band-pass filter FM	IF band-pass filter AM	S28)		Mains transformer
S9		MF-bandfilter FM	MF-bandfilter AM	S29)		Nettransformator
C23	4822 193 00794	Filterre passe-bande FI,FM	Filterre passe-bande FI,AM	S30)	4822 193 00799	Transformateur secteur
		ZF-Bandfilter UKW	ZF-Bandfilter AM	S31)		Nettransformator
		Filterre de pasabanda FI,FM	Filterre de pasabanda FI,AM	S32)		Transformador de red
S10		Ferroreceptor MW+LW	Ratio detector			Loudspeaker
S11	4822 193 00816	Ferroreceptor FO+GO	Ratiodetector	LS	940/AD3700M	Luidspreker
		Ferroreceptor MW+LW	Ratiodetektor			Haut-parleur
		Ferroreceptor OM+OL	Detector de razon			Lautsprecher
C4,5,11		4822 069 00627	C60		1200 Ω	4822 220 00362
C10	5000 pF	4822 069 00575	C63	V	100 Ω+4700 pF	E 551 AA/24+44
C12	82 pF	4822 069 00634	C65	V		4822 071 00886
C14-21		4822 059 00354	C66,77	V	220 kΩ+2x100 pF	4822 071 00887
C26	4700 pF	4822 069 00545	R7	Ω	12 kΩ+2x1000 pF	4822 071 00888
C29	360 pF	4822 069 01025	R9	Ω	12 kΩ+2200 pF	955/D6, 3x320
C30	240 pF	4822 069 01024	R12	Ω		A3 425 53
C31,32	100 pF	907/25E-100E	R17	Ω		
C44	10 pF	909/W10	R28	Ω		
C48	2,5 pF	4822 069 00579	R31	Ω		
C57	39000 pF	4822 069 01097	R39	Ω		
C59,61	10000 pF	4822 069 01093				