

Service manual



B1.39

powered subwoofer

Technical data B1.39

Amplifier:	400 Watt RMS
Woofers:	10" Long throw woofer
Frequency range:	20 - 100 Hz
Low pass filter:	50 - 100Hz, variable 12dB/octave
High pass filter:	100Hz, 12dB/octave
Power requirements:	AC 230V 50HZ
Power consumption (max):	400W
Dimensions(WxHxD):	290 x 520x 420 mm
Weight:(net)	24 Kg

Bias adjustment B1.39

Input signal 50-60Hz.

Connect a 4 Ω load to output.

Adjust output level to 3.5-4V RMS and leave the amp to warm up for about 20 minutes.

Set output level to 0 and adjust VR1 for 1.5-3mV after about 1 minute.

Note! Check that Q07A (2SC3421) has a perfect contact surface against the cooling flange.

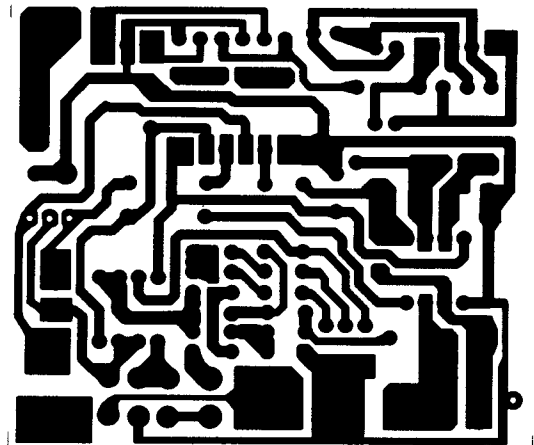
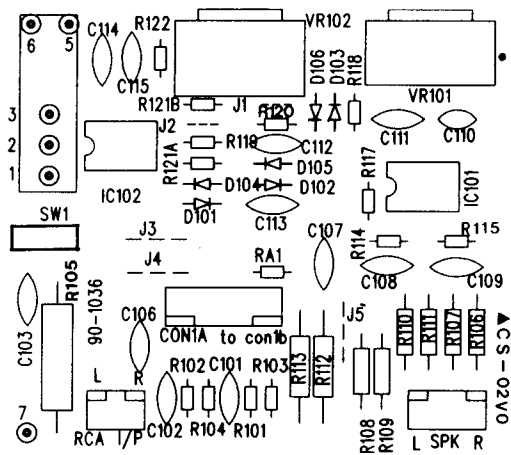

Speaker IN / OUT PCB

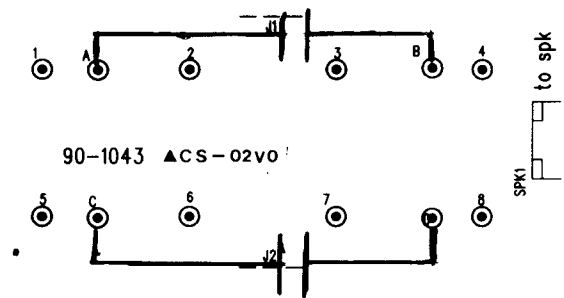
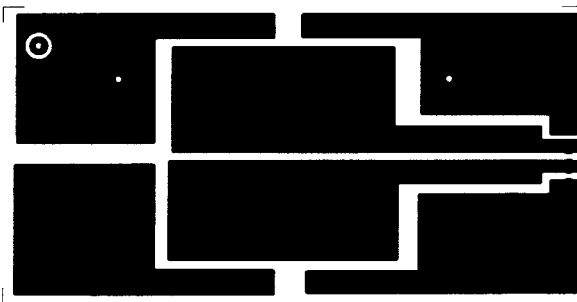

2 x 100 μ F / 100V

B1.39

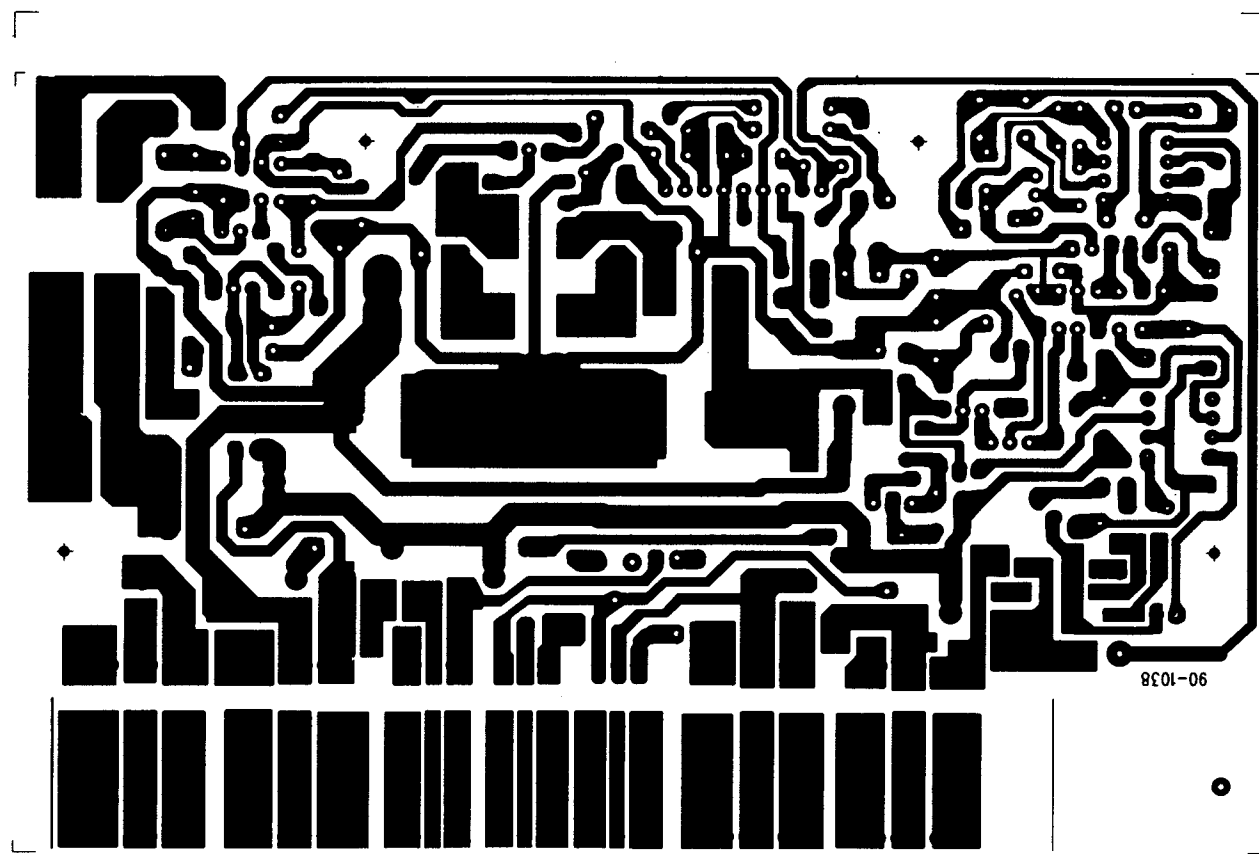
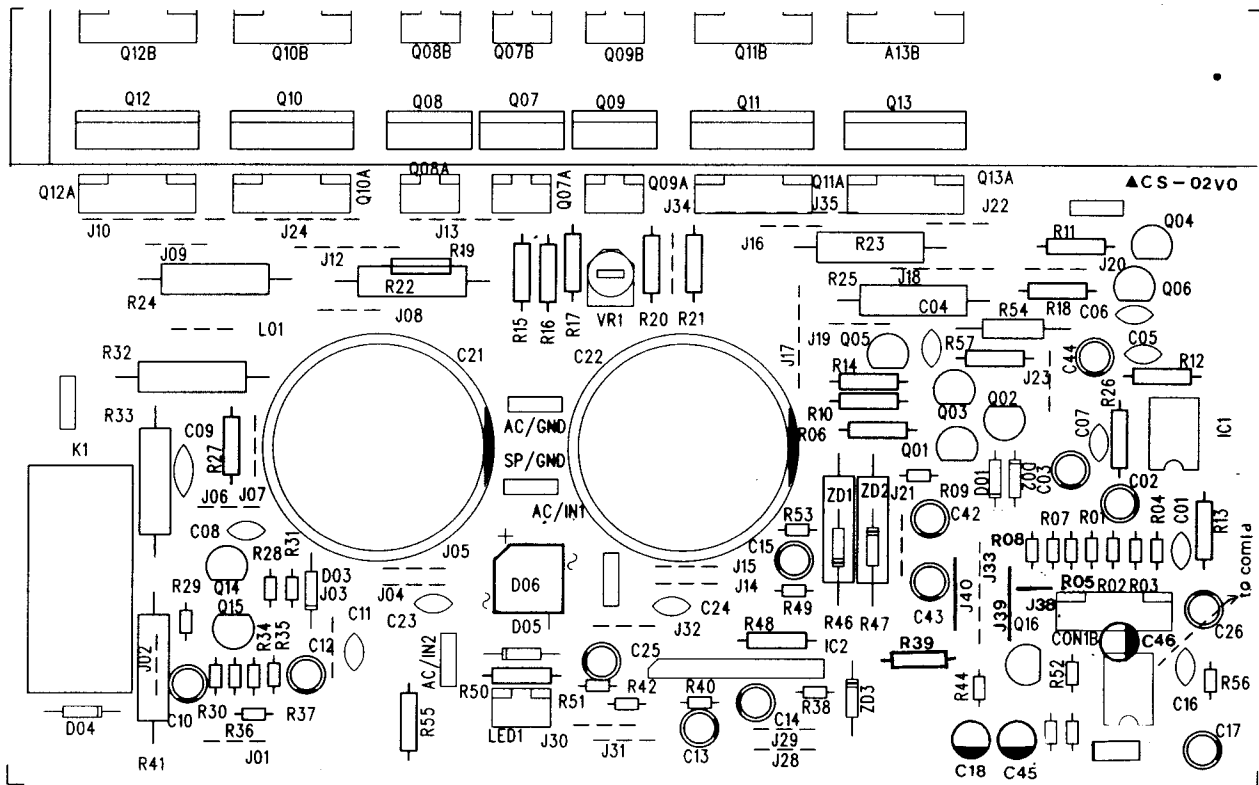

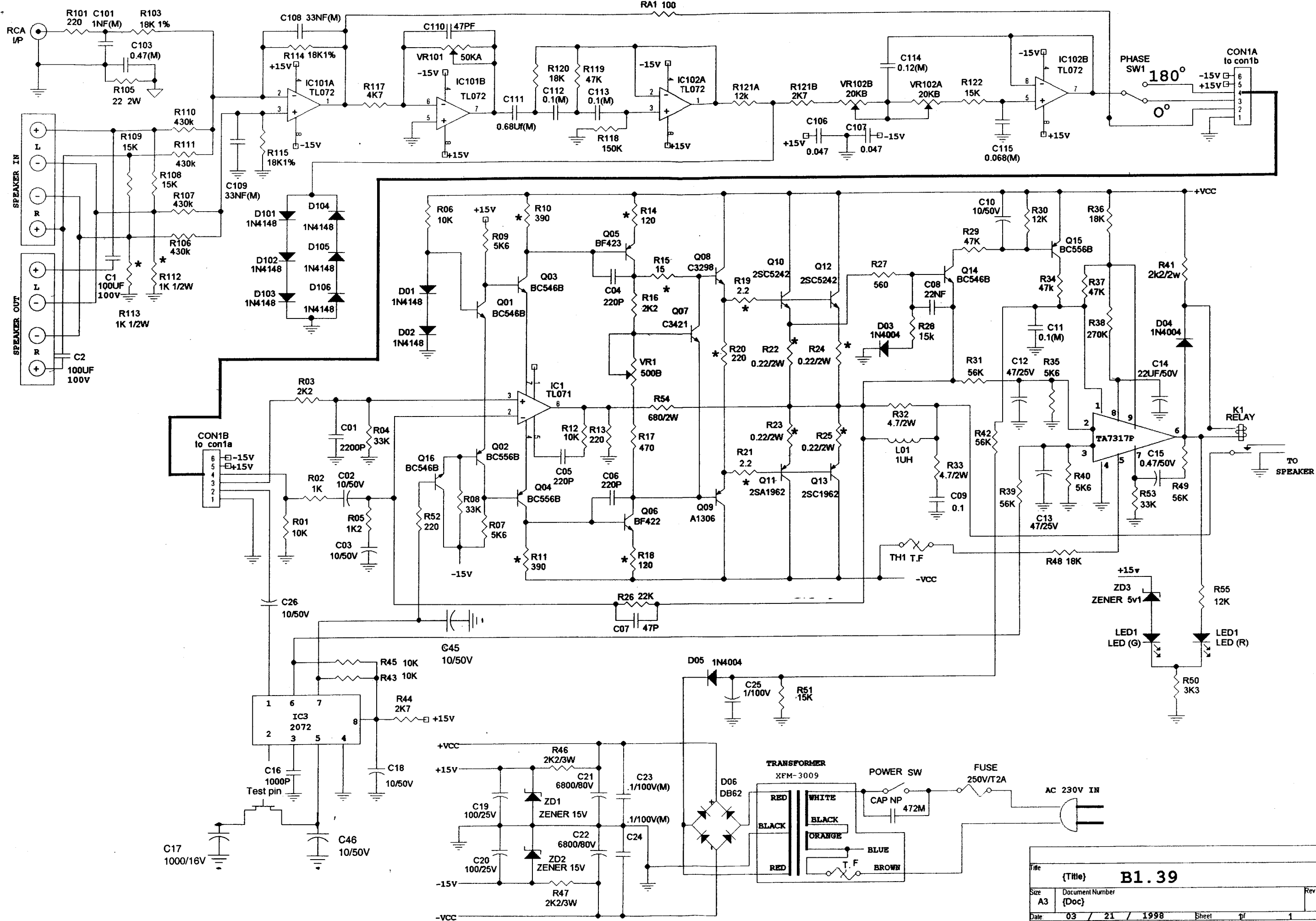

Title	{Title}	B1.39	Rev
Size	A3	Doc	
Date	03 / 21 / 1998	Sheet	1 / 1

B1.39

PART-NUMBER	DESCRIPTION	LOCATION
	ASS'Y PCB POWER AMP AND SUPPLY BOARD	
ADB-BR62	DIODE BRIDGE BR62 200V 6A	D06
AIC-NJM2072D	IC SIGNAL LEVEL SENSOR SYSTEM NJM2072D	IC3
AIC-TA7317P	IC TA7317P	IC2
AIC-TL071	IC TL071	IC1
ARL-01-7001	RELAY 24V 1P1T OMIT-SS-124LM	K1
ADD-1N4004*TAP52	DIODE RECTI 1N4004 TAPING 52MM	D03-05
ADD-1N4148*TAP52	DIODE SWITCH 1N4148 52MM	D01,02
ADZ-1N5231B	DIODE ZENER 1N5231B 0.5W 5.1V +-5%	ZD3
ADZ-1N5245B	DIODE ZENER 1N5245B 0.5W 15V +-5%	ZD1-2
ATR-BC546B	TR BC546B (&)	Q01,03,14,16
ATR-BC556B	TR BC556B	Q02,04,15
ATR-BF422	TR BF422	Q06
ATR-BF423	TR BF423	Q05
ECD-050T102M	CAP CER NP 1NF/50 +-20%	C16
ECD-050T104M	CAP CER 50V 0.1UF +-20%	C09
ECD-050T221M	CAP CER 50V 220P +-20%	C04,05,06
ECD-050T222M	CAP CER 50V 0.0022uF +-20%	C01
ECD-050T223M	CAP CER 50V 0.022UF +-20%	C08
ECD-050T470M	CAP CER 50V 47PF +-20%	C07
ECE-025T107M	CAP ELE 25V 100UF +-20%	C42,43
ECE-025T226M	CAP ELE 25V 22U +-20%	C14
ECE-025T476M	CAP ELE 25V 47U +-20%	C12,13
ECE-050T106M	CAP ELE 50V 10UF +-20%	C02,03,10,18,26,45,46
ECE-050T474M	CAP ELE 50V 0.47UF +-20%	C15
ECE-100T105M	CAP ELE 100V 1U +-20%	C25
ECM-050T104J	CAP MYLAR 50V 0.1u +-5%	C11
ECM-100T104J	CAP MYLAR 100V 0.1uF +-5%	C23,24
ERB-251Y121J	RES FR 1/4W Y 120 +-5%	R14,18
ERB-251Y150J	RES MO 1/4W Y 15 +-5%	R15
ERB-251Y221J	RES FR 1/4W Y 220 +-5%	R20
ERB-251Y2R2J	RES FR 1/4W Y 2.2 +-5%	R19,21
ERB-251Y391J	RES FR 1/4W Y 390 +-5%	R10,11
ERC-121Y102J	RES CF 1/8W Y 1K +-5%	R02
ERC-121Y103J	RES CF 1/8W Y 10K +-5%	R01,43,45

B1.39

PART-NUMBER	DESCRIPTION	LOCATION
ERC-121Y122J	RES CF 1/8W Y 1.2K +-5%	R05
ERC-121Y123J	RES CF 1/8W Y 12K +-5%	R30
ERC-121Y153J	RES CF 1/8W Y 15K +-5%	R51
ERC-121Y183J	RES CF 1/8W Y 18K +-5%	R36
ERC-121Y221J	RES CF 1/8W Y 220 +-5%	R52
ERC-121Y222J	RES CF 1/8W Y 2.2K +-5%	R03
ERC-121Y272J	RES CF 1/8W Y 2.7K +-5%	R44
ERC-121Y274J	RES CF 1/8W Y 270K +-5%	R38
ERC-121Y333J	RES CF 1/8W Y 33K +-5%	R04,08,53
ERC-121Y473J	RES CF 1/8W Y 47K +-5%	R28,29,34,37
ERC-121Y562J	RES CF 1/8W Y 5.6K +-5%	R07,09,35,40
ERC-121Y563J	RES CF 1/8W Y 56K +-5%	R31,42,49
ERC-251Y103J	RES CF 1/4W Y 10K +-5%	R06,12
ERC-251Y123J	RES CF 1/4W Y 12K +-5%	R55
ERC-251Y152J	RES CF 1/4W Y 1.5K +-5%	R27
ERC-251Y183J	RES CF 1/4W Y 18K +-5%	R48
ERC-251Y221J	RES CF 1/4W Y 220 +-5%	R13
ERC-251Y222J	RES CF 1/4W Y 2.2K +-5%	R16
ERC-251Y223J	RES CF 1/4W Y 22K +-5%	R26
ERC-251Y332J	RES CF 1/4W Y 3.3K +-5%	R50
ERC-251Y471J	RES CF 1/4W Y 470 +-5%	R17
ERC-251Y563J	RES CF 1/4W Y 56K +-5%	R39
ECE-016V108M	CAP ELE 16V 1000U +-20%	C17
ECE-080V688M	CAP ELE 80V 6800uF +-20% (30*50)	C21,22
ELC-02-7001	COIL CHK 2UH +-10% L-R2U	L01
ERB-202L152J	RES MO 2W L 1K5 +-5% P=20mm	R41
ERB-202L4R7J	RES MO 2W L 4.7 +-5% P=20mm	R32,33
ERB-202L681J	RES MO 2W L 680 +-5% P=20mm	R54
ERB-202LR22J	RES MO 2W L 0.22 +-5% P=20mm	R22-25
ERB-302L222J	RES MO 3W L 2K2 +-5% P=20mm	R46,47
ERV-F07-501B01	VR SEMI ST F 7MMD 500B	VR1
TRL-7002	THERMAL PROTECTOR 17AM024A5	TH1
	ASS'Y PCB HIGH/LOW LEVEL IN/OUT	
ECJ-100A107K	CAP ELND 100V/100uF +-10%	C1-2
	ASS'Y PCB INPUT AND FILTER BOARD	

B1.39

PART-NUMBER	DESCRIPTION	LOCATION
AIC-TL072	IC DVAL OP AMP TL072	IC101-2
ADD-1N4148*TAP52	DIODE SWITCH 1N4148 52MM	D101-6
ECD-050T470M	CAP CER 50V 47PF +-20%	C110
ECD-050T473M	CAP CER NP .047U/50 +-20%	C106-7
ECM-050T102J	CAP MYLAR 50V 1000pF +-5%	C101
ECM-050T104J	CAP MYLAR 50V 0.1u +-5%	C112-3
ECM-050T124J	CAP MYLAR 50V 0.12U +-5%	C114
ECM-050T333J	CAP MYLAR 50V 0.033U +-5%	C108-9
ECM-050T683J	CAP MYLAR 50V 0.068U +-5%	C115
ECZ-063T474J-1	CAP MTLZ 63V 0.47uF +-5% MINI	C103
ECZ-063T684J-1	CAP MTLZ 63V 0.68uF +-5% MINI	C111
ERB-501Y102J	RES MO 1/2W Y 1K +-5%	R112-3
ERC-121Y101J	RES CF 1/8W Y 100 +-5%	RA1
ERC-121Y123J	RES CF 1/8W Y 12K +-5%	R121A
ERC-121Y153J	RES CF 1/8W Y 15K +-5%	R122
ERC-121Y154J	RES CF 1/8W Y 150K +-5%	R118
ERC-121Y183J	RES CF 1/8W Y 18K +-5%	R120
ERC-121Y221J	RES CF 1/8W Y 220 +-5%	R101
ERC-121Y272J	RES CF 1/8W Y 2.7K +-5%	R121B
ERC-121Y472J	RES CF 1/8W Y 4.7K +-5%	R117
ERC-121Y473J	RES CF 1/8W Y 47K +-5%	R119
ERC-251Y153J	RES CF 1/4W Y 15K +-5%	R108-9
ERM-121Y1002F	RES MF 1/8W Y 10K +-1%	R103
ERM-121Y1802F	RES MF 1/8W Y 18K +-1%	R114,115
ERM-251Y3903F	RES MF 1/4W Y 390K +-1%	R106,107,110,111
ERB-202P220J	RES MO 2W P 22 +-5%	R105
SWL-7016	SW TOGGLE	SW1
VRR-7045	VR ROT 16MMD 20KB*2 H=15mm	VR102
VRR-7049	VR ROT 16MMD 50KA*1 +-20%	VR101
ADL-8S704	LED DC 5mmD L-59EGW	
ATR-2SA1306B	TR 2SA1306B	Q09
ATR-2SA1962	TR 2SA1962	Q11,13
ATR-2SC3298B	TR 2SC3298B	Q08
ATR-2SC3421	TR 2SC3421	Q07
ATR-2SC5242	TR 2SC5242	Q10,12

B1.39

PART-NUMBER	DESCRIPTION	LOCATION
	MISCELLANEOUS	
ECW-250V472M	CAP Y-TYPE 4700pF/250V +-20%	
FUH-1004	FUSE HOLDER FOR 5*20MM SEMKO	
FUS-01-2001S	FUSE UL/CSA 5*20mm 2A/250V SB	
JK3-L01-709	JACK RCA L 1P GOLD PLATED	
JK7-7012	JACK BINDING POST CL-B261	
M04-P631	BINDING POST PLUG BLACK (A414B-3)	
M04-P632	BINDING POST PLUG RED (A414R-3)	
M11-P652	KNOB A KGA003-01	
WPC-7019	POWER CORD H05VV-F 1.8M	
XFM-3009	XFORMER AUDIO I/P EI-86 115/230V KGA008-	
WAS-7369	WIRE ASS'Y 1P RCA PLUG*2(GOLD) 6M BAK	