



00350

13130 SOUTH YUKON AVENUE
PHONE (213) 973-8090

HAWTHORNE, CALIFORNIA 90250
TELEX NO. 86-4494

OWNER'S MANUAL
MODEL 620
COMMERCIAL POWER AMPLIFIER

TABLE OF CONTENTS

<u>DESCRIPTION</u>	<u>FORM NUMBER</u>
Important.....	00601
Description.....	01650
Specifications.....	02220
Unpacking and Set-Up.....	02510
Input Connections.....	03081
Direct Output Connections.....	03541
Damping Factor Chart.....	03510
Speaker Fuse Nomograph.....	03530
25/70v Line Applications.....	03241
25/70v Line vs. Impedance Chart.....	03250
Power Mains Connection.....	04000
Operating Precautions.....	05001
Circuit Description, 620.....	06250
Schematic, Amplifier Module.....	12110
Schematic, Chassis.....	12120
Parts List.....	12190
Power Mains Voltage Conversion.....	04502

-IMPORTANT-

PLEASE READ THIS PAGE BEFORE OPERATING
YOUR
BGW POWER AMPLIFIER

Your new BGW amplifier is designed to provide years of trouble free performance.

Observing these few precautions will insure proper operation.

- . All connections should be made to the power amplifier with the power OFF.
- . Speaker fuses should be used to afford maximum speaker protection.
- . Never connect the output of one channel to that of another.
- . Connect the power cord to the proper voltage mains as indicated on the rear of the amplifier. Conversion to another voltage requires internal rewiring.
- . Do not remove the amplifier's cover. Amplifiers may not be covered under warranty if they are tampered with. There are NO adjustments within. Potentially lethal voltages exist within the amplifier. Refer all service work to an authorized BGW service station.

DESCRIPTION

The BGW Model 620 is a basic, high-power, stereo amplifier, designed for background sound distribution systems and other professional use. Circuitry, connectors, and cosmetics have been kept to a minimum for simple operation and overall economy.

Gain controls, indicator lights and the on/off switch are located on the front panel. Input, output, and ground connectors are on the rear panel.

Input connections are made with either standard single-channel, 1/4-inch phone plugs, spade lugs, or bare wires. Output connections are made to the barrier strips with either spade lugs or bare wires. Amplifiers have built-in output transformers and will drive either 25-volt or 70-volt distribution systems. Export versions will drive 70 volt and 100 volt lines distribution systems. Signal ground can be separated from chassis ground, if desired, by removing the connecting link on the rear panel barrier strip.

The LED's located above the gain controls on the front panel serve as clipping indicators. They are activated when the amplifier output level (peak) equals the power supply voltage. Distortion rises significantly, when this occurs, because there is not enough energy available to accurately reproduce the signal. As this condition can occur at a rate too fast for the eye to follow, the LED's remain for 1/4 second once clipping is sensed. A third red LED is employed as a "power on" indicator.

Features include: an error-sensing op-amp input stage, to stabilize performance; a heat sink mounted bias circuit, to provide precise temperature compensation; and a full complementary output stage, featuring ten 150-watt transistors in each channel (3000 watt total dissipation capability). Temperature activated switches and magnetic circuit breaker protection, safeguard the unit.

Mechanical features include: a 16-gauge steel chassis, teflonTM insulated wiring, massive heat sinks, and modular construction.

All active audio circuit components are contained in two modules, one for each channel. These modules consist of a glass epoxy circuit board mechanically coupled to a large aluminum heat sink. Vertical fin arrangement allows natural convection currents to flow upward and away from the amplifier. Removal of the modules for service is easily accomplished by removing the support screws and the plug-in electrical connectors.

SPECIFICATIONS MODEL 620DIRECT OUTPUTOUTPUT POWER AND TOTAL HARMONIC DISTORTIONOUTPUT POWER

200 watts minimum sine wave continuous average power output per channel with both channels driving a constant voltage line over a power band from 20Hz to 20kHz. The maximum Total Harmonic Distortion at any power level from 250 milliwatts to 200 watts shall be no more than 0.25%.

1 kHz Power: 240 watts into 8-ohms per channel, both channels operating. 0.25% Total Harmonic Distortion.

Small Signal Response:	+0, -3dB, 10Hz to 70kHz Frequency +0, -1dB, 20Hz to 20kHz
Intermodulation Distortion:	Less than 0.06% from 250 milliwatts to rated output (60 Hz & kHz, 4:1)
Hum and Noise Level:	Better than 100dB below rated output into 8 ohms (unweighted, 20 Hz to 20 kHz)
Damping Factor:	Greater than 120 to 1 at 8 ohms, 1 kHz
D.C. Offset Voltage:	Less than 10mV
Load Impedance:	Equal to or greater than 4 ohms

UNPACKING AND SET-UP

Your BGW Power Amplifier is shipped in an advanced packing container.

SAVE THE CONTAINER AND ALL PACKING MATERIAL!

The container should be saved in the event the unit is moved or shipped at some future date. Replacement containers are available from BGW Systems for \$14.00, freight included.

Inspect the unit for damage in transit immediately upon receipt. If damage is found, notify the transportation company immediately. Only the consignee may institute a claim with the carrier for shipping damage. BGW will cooperate fully in such an event. Be sure to save the container as evidence of damage for the shipper to inspect.

The amplifier's mounting position must be chosen carefully, so that the air flow around the unit is not restricted. Inadequate ventilation may cause failure of the amplifier. For rack mounting, the four rubber feet on the bottom of the unit may be removed and no hardware will be loosened inside the unit.

The size of the amplifier is convenient for a wide variety of applications. However, please note the following precautions:

- 1.) Do not use the front panel as the sole support for the amplifier. Side rails or rack shelves should be employed.
- 2.) Do not stack amplifiers. A minimum of 1 3/4" above each amplifier should be provided for free air circulation.

DO NOT PLUG THE AMPLIFIER IN YET!

All connections should be made before power is applied.

INPUT CONNECTIONS

1/4 inch phone jacks and a barrier terminal strip are provided on the rear of the amplifier for input connections.

1/4 INCH PHONE JACKS

The 1/4" phone jacks are for unbalanced lines only (single conductor, shielded). Simply connect the shield to the outer sleeve of the plug and the inner conductor to the tip, or buy ready-made cables. See diagram below.

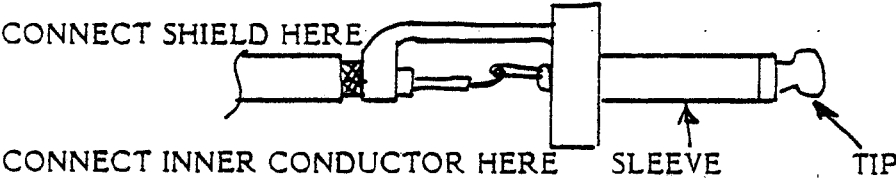

BARRIER INPUTS

The barrier strip inputs are for unbalanced lines only (single conductor, shielded). Simply connect the shield to the terminal marked signal ground and the inner connector to the terminal marked (in). See diagram below.

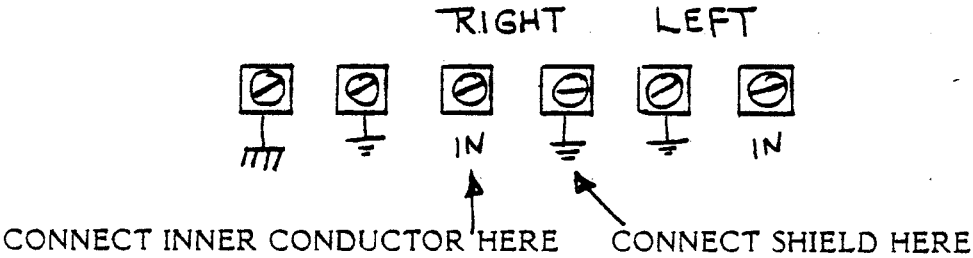

DIRECT OUTPUT CONNECTIONS

Make certain that the speakers are properly phased. Connect the black or minus (-) terminal on the speaker cabinet to the appropriate barrier strip screw (amp out -) on the amplifier. Connect the red or plus (+) terminal to the barrier strip screw (amp out +). Check to see that the stereo-mono switch on the rear of the amplifier is in the stereo position.

SPEAKER PROTECTION

All speakers can be damaged by having too much power applied to them. Fuse protection is an effective and inexpensive way of preventing this from occurring. If your speaker system does not contain a fuse or a circuit breaker, a fuse should be placed in series with each speaker and the wire going to the red terminal on the rear of the amplifier.

Maximum protection can be obtained with fast-acting fuses. Use the value recommended by the manufacturer. If no value is specified, use the chart provided to select the correct value. (MFRM 03530)

To use the chart, take a straightedge, such as a ruler, and line up the speaker's impedance with its peak music power rating. The proper fuse value can then be read from the center column. Choose a fuse that is closest to, and below, the value indicated.

WIRE SIZE AND DAMPING FACTOR

The high damping factor of BGW amplifiers results in a very clean bass response. Excessively long, and small diameter speaker wires can lower the damping factor and distort the lower frequencies. A damping factor of at least 50 should be maintained to insure good audio quality.

The relationship between wire length and diameter, and damping factor can be calculated using the chart (MFRM 03510) on the following page. Proceed as follows:

1. Using a straight-edge, line up the gauge of the speaker wire with its length. Mark off the resulting source resistance where this line crosses the center column.
2. Line up the source resistance, determined in step #1, with the manufacturer's impedance* of the speaker system. The damping factor can now be read.

*The impedance of a speaker system can be approximated by measuring the resistance across the speaker terminals, with the amplifier disconnected. Multiplying this result by 1.33, gives you the approximate impedance.

Note: This method cannot be used with electrostatic speakers.

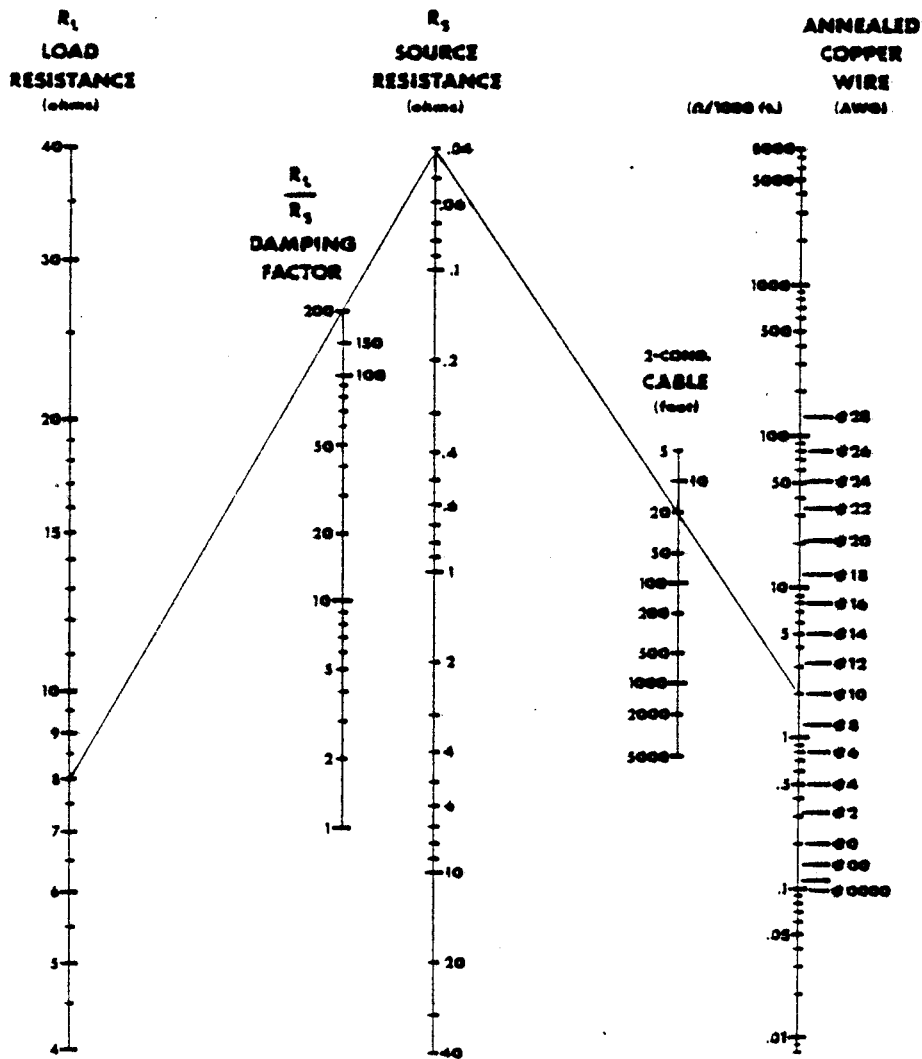

EXAMPLE: $R_L = 8\Omega$, $R_S = .04\Omega$ OR D.F. = 200
 CABLE LENGTH OF 20 FT. ANSWER: #10 WIRE

SOURCE RESISTANCE AND DAMPING FACTOR VS. LENGTH AND SIZE OF OUTPUT LEADS

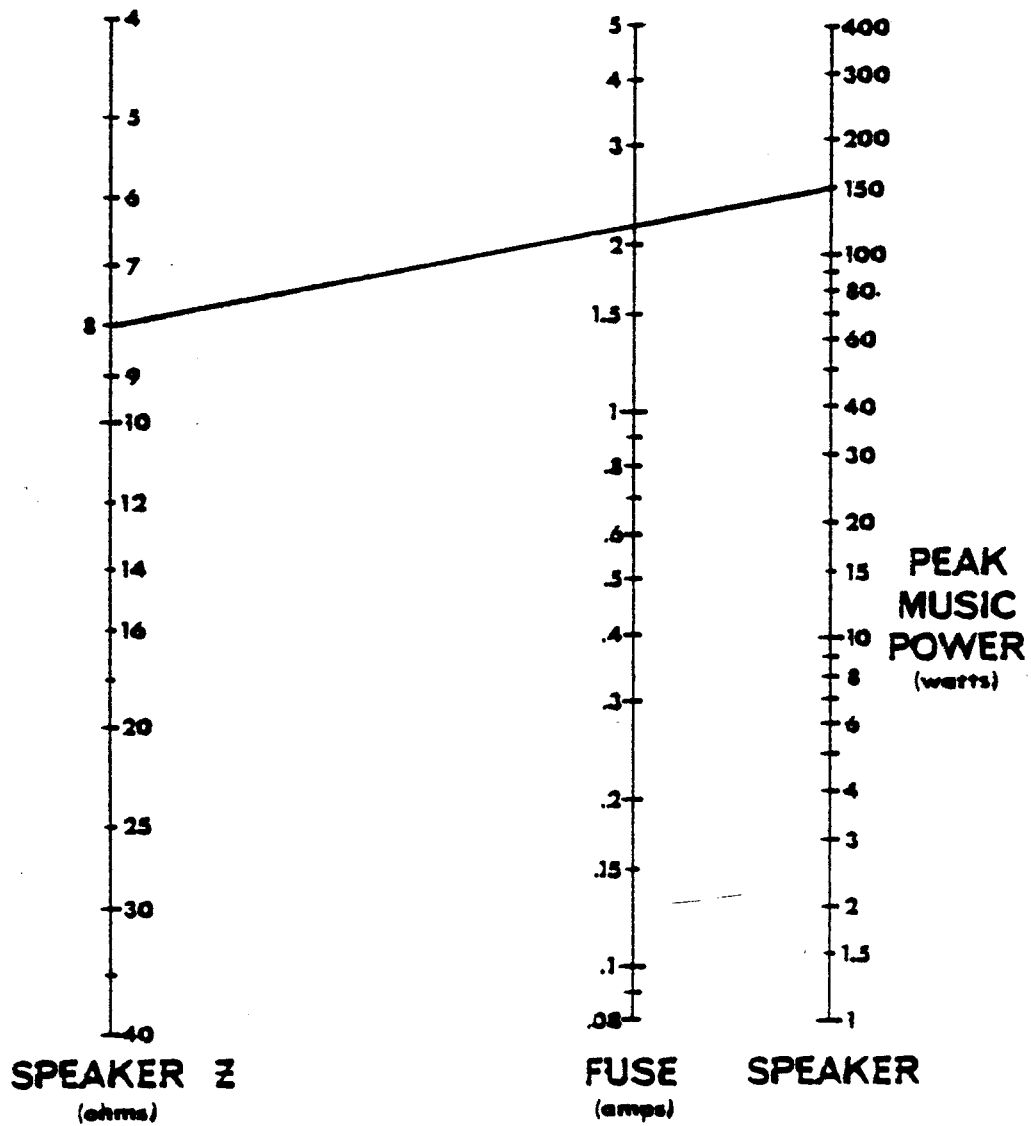

EXAMPLE: $Z = 8\Omega$, PEAK POWER = 150W. ANSWER: FUSE = 2 AMPS

FUSE SELECTOR NOMOGRAPH FOR LOUDSPEAKER PROTECTION

MFRM -03530

25/70 VOLT DISTRIBUTION SYSTEMS

A constant voltage distribution system is a method of connecting loudspeakers to an amplifier wherein the output voltage of the amplifier and the amount of power delivered to any particular loudspeaker remains constant once the system is properly installed. The amplifier will produce 70 volts at rated power while a five-watt speaker will receive five watts regardless of how many loudspeakers are added to, or subtracted from, the distribution system.

The output voltage of an amplifier, properly set up in a constant voltage distribution system, is not dependent upon the load connected to the amplifier. It is determined by the input signal applied to the amplifier, and is limited only by the amplifier's output power capability.

An analagous constant voltage system is the power generating station that delivers electrical power to your home. Just as appliances can be turned on and off without affecting the operation of other appliances connected to the electrical system as a whole, speakers can be added to, or subtracted from, the distribution system without affecting its overall operation.

This occurs because both the amplifier and the generating station have extremely low output impedances with respect to their loads. The ratio between source (amplifier) and load (speaker) in a constant voltage distribution system is generally between 1:100 and 1:1000. A change in the load impedance would have to be very great to have any effect on the amplifier's output voltage.

The most common voltage used in a constant voltage distribution system is 70.7 volts. In most areas of the USA, 70.7 volts is the maximum voltage that a pair of wires can carry without being enclosed in a metal conduit. Amplifiers used to power such a system must develop 70.7 volts across their output terminals when driven to their full rated power. The 70.7-volt figure is the maximum voltage value. The output of the amplifier, in actuality, swings from 0 to 70.7 volts in response to changes in its input signals. One other value used in constant voltage systems is 25 volts.

*Note: Some local electrical codes may have power and/or other limitations.

Transformers are used to connect loudspeakers to the amplifier. They are usually designed for a specific constant voltage level (i.e. 70.7 volts) and have primary winding taps rated in watts and secondary winding taps rated in ohms. A transformer may have several primary and secondary winding taps, each with different ratings.

Primary windings are connected in parallel across the output terminals of the amplifier, while secondary windings are connected across a loudspeaker or loudspeaker system. Secondary winding taps are selected to match the impedance of the loudspeaker(s) to the impedance of the transformer. For example, an eight-ohm speaker system would be connected to an eight ohm tap on a transformer secondary winding. A speaker will receive the power (watts) determined by its primary winding tap only when the amplifier is at its full rated power. Power delivered to a speaker varies in proportion to the amplifier's output voltage.

Transformers are connected in parallel across the output terminals of the amplifier

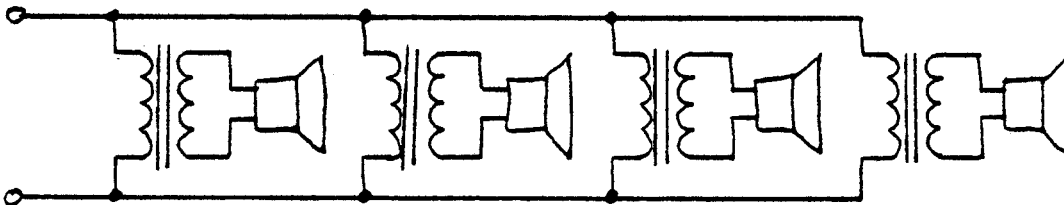

Primary windings of certain transformers are rated in ohms instead of watts. To select a transformer for a specific power level, the following formula can be used :

$$Z = \frac{E^2}{P} \text{ where } Z \text{ is the impedance of the primary winding of the transformer (ohms).}$$

E is the constant voltage level of the system.

P is the desired power (watts).

For a 70.7 volt system, where 5 watts are desired at a particular speaker, the primary winding of the transformer must have an impedance of:

$$Z = \frac{5000}{5} = 1000 \text{ ohms.}$$

Note: 70.7^2 is approximately 5000

Two factors must be considered when setting up a constant voltage distribution system. The amplifier must have sufficient power and the speaker system must have sufficient impedance.

The amplifier must have enough power at the system voltage level to drive all of the loudspeakers in the system. For example, in a 70.7-volt system where there are (ten) 2 watt and (twenty) five watt loudspeakers, an amplifier that can produce more than 120 watts is required. Use a more powerful amplifier than calculated if the system is to be expanded.

The total impedance of the speaker system must be maintained above a certain minimum value to insure constant voltage operation. This impedance can be determined by the following formula:

$$Z = \frac{E^2}{P}$$

where Z is the total impedance of the speaker system (ohms)
 E is the output voltage of the amp at full power
 P is the full rated power of the amplifier (watts)

For a 50-watt amplifier to power a 70.7 volt system, the minimum impedance is:

$$Z = \frac{(70.7)^2}{50} = \frac{5000}{50} = 100 \text{ ohms} \quad (70.7)^2 \text{ is approximately } 5000$$

CONSTANT VOLTAGE LINES
WATTS vs OHMS vs VOLTS

WATTS	OHMS			VOLTS		
	25V	70V	100V	4Ω	8Ω	16Ω
25	25.0	196.0	400.0	10.0	14.1	20.0
50	12.5	98.0	200.0	14.1	20.0	28.3
75	8.33	65.3	133.3	17.3	24.5	34.6
<u>100</u>	6.25	<u>49.0</u>	100.0	20.0	28.3	40.0
125	5.00	39.2	80.0	22.4	31.6	44.0
150	4.17	32.7	66.7	24.5	34.6	49.0
175	3.57	28.0	57.1	26.5	37.4	52.9
200	3.13	24.5	50.0	28.3	40.0	56.6
<u>225</u>	2.78	21.8	44.4	30.0	42.4	<u>60.0</u>
250	2.50	19.6	40.0	31.6	44.7	63.3
300	2.08	16.3	33.3	34.6	49.0	69.3
400	1.56	12.3	25.0	40.0	56.6	80.0
500	1.25	9.8	20.0	44.7	63.3	89.5
600	1.04	8.2	16.7	49.0	69.3	98.0
700	0.89	7.0	14.3	53.0	74.8	105.8
750	0.83	6.5	13.3	54.8	77.5	109.5
800	0.78	6.1	12.5	56.6	80.0	113.1

$$E = \sqrt{PR}$$

$$P = \frac{E^2}{R}$$

$$R = \frac{E^2}{P}$$

E = volts

P = watts

R = resistance

To use chart you will have two of the known values; ohm, volts or watts. On the first horizontal line select one known value watts, constant volts or resistance. Then move down the column until you find the second known value. Then move horizontally to the unknown value.

Example 1 70V constant line and 49 ohms = 100 watts

Example 2 16 ohms and 60 volts = 225 watts

POWER MAINS CONNECTIONS

The unit should be plugged in only when it has been established that it is wired for the correct power mains voltage and after all other connections have been made.

The mains (AC line) voltage is indicated on the label on the rear of the unit. Products supplied for use in the United States and Canada are factory wired for 120 volts. Only the indicated mains voltage should be used. If the mains voltage must be changed, see POWER MAINS VOLTAGE CONVERSION.

A molded, parallel blade, U-ground plug is supplied. This connector is standard in the United States and Canada. For use elsewhere, the plug must be replaced with the correct connector. The color-code of the cord is as follows:

HI (switched Leg) - Brown (or Black)

LO (neutral Leg) - Blue (or White)

EARTH (chassis ground) - Green with Yellow tracer (or Green)

OPERATION

PRECAUTIONS

1. Speaker destruction is often due to improper equipment operation. This often occurs when someone, without the proper appreciation for the components of a high power, high quality music system, has the opportunity to change records or adjust levels. The best protection here is caution. Keep the equipment out of the reach of untrained adults and children.

Make sure the speaker is properly protected with fuses (Output Connections Section).
2. Never parallel the two amplifier outputs together.
3. When driving any load with an impedance of less than 4 ohms, the load should be isolated from the amplifier with a series capacitor in order to avoid both damage to the load, and wasting of output power.
4. If the amplifier continuously shuts off, something is wrong - refer to Warranty and Service Station.
5. Do not connect an input ground lead to an output ground lead; to do so may cause a ground loop and oscillations.
6. Do not operate the amplifier from power mains which exceed the indicated mains voltage by more the 10%.
7. Never connect the output of the amplifier to another power source such as a battery or power main.
8. Do not expose the amplifier to corrosive chemicals such as lye, soft drinks, salt water, etc. Also, never immerse the amplifier in any liquid.
9. Do not remove the amplifier's cover.
10. The amplifier is designed for full power operation over the 20-20kHz audio band. High power operation above 20kHz should be avoided.
11. Neither the amplifier, nor any of its leads, should be exposed to areas likely to be struck by lightning.

620 CIRCUIT DESCRIPTION

POWER SUPPLY

The AC input power goes through the power switch circuit breaker CB101 to the power transformer T101.

The low voltage secondary (sec 2) 12 volts AC, is rectified and current limited through D101 and R101 to light the power-ON LED, DS101.

The high voltage center taped secondary (sec 1), 106 volts AC, is connected to a full wave bridge rectifier, D102 and a capacitor input filter, C102 and C103, to give a ± 76 volts DC output.

Capacitor C101 across the Bridge Rectifier suppresses any high frequency noise that might be coupled through the transformer or generated by the Bridge Rectifier.

INPUT CIRCUIT

Input from the Barrier Strip TB103 or Input Jack J101 (J102) is fed to Input Step Attenuator Control R102 (R103). The Output from the controls goes to the amplifier circuit through the plug P102 (P103).

AMPLIFIER

The input signal from pin 9 of J1 is applied to the inverting input (pin 2) of op amp IC1 through the coupling network C1, C2, R1, and R3. This network provides a high input impedance to the amplifier and filters out DC and radio frequency interference.

Q1 and Q2 divide the signal into positive and negative components respectively. They are connected common emitter and provide voltage gain. Q8 and Q9 are connected common collector to provide the current gain necessary to drive the driver transistors Q10 and Q11. Q10 and Q11 drive the output stage, Q12-Q21. The output appears across flyback clipping diodes D5 and D6, then passes through compensation networks L1/R48 and R49/C19 through the thermal switch S1 then to pins 1 and 2 of J1. If the temperature of the output transistors reach 100°C, S1 opens and disconnects the load.

To maintain overall amplifier stability, linearity, and low distortion, degenerative feedback is used throughout the amplifier. Voltage divider R6/R2 applies the correct amount of feedback to the non-inverting input (pin 3) of op amp IC1. Except for the input, the amplifier uses direct coupling throughout.

Q3 is a Vbe multiplier, providing the correct bias voltage for all operating temperatures.

Q4-Q7 provide the current limiting necessary to protect the output stage.

Q22-Q24 comprise the clipping indicator circuit. When the amplifier is driven into clipping, a voltage of sufficient magnitude to turn on Q22 appears at pin 6 of IC1 and is coupled to the base of Q22 through R10 and C9. This voltage appears because the amplifier is trying to compensate for the fact that the clipped feedback signal does not match the unclipped input signal. When Q22 turns on, the base of Q24 is driven positive through R18, so Q24 turns on,. This turns on the LED clipping indicator, and pulls the base of Q23 negative, through R30 and C21, which shuts off Q23. As long as Q23 is off, the base of Q24 is not held negative through R26 and Q23, so Q24 stays on. As C21 charges through R29, the base of Q23 becomes positive until Q23 turns on, which shuts off Q24 and the LED. Thus the length of time that the LED is held on is determined by R29 and C21. The zener diode D7 limits the open circuit voltage to the clip indicator LED to prevent a shock hazard.

OUTPUT TRANSFORMERS

With output autotransformers, the power amplifier can drive 25 and 70 volt lines.

All input/output connections to the autotransformers are located on the rear panel of the amplifier.

The autotransformers step up or down the output voltage of the amplifier, to power match 25 or 70 volt distribution systems.

Export products are supplied with different autotransformers and can drive 70 and 100 volt lines.

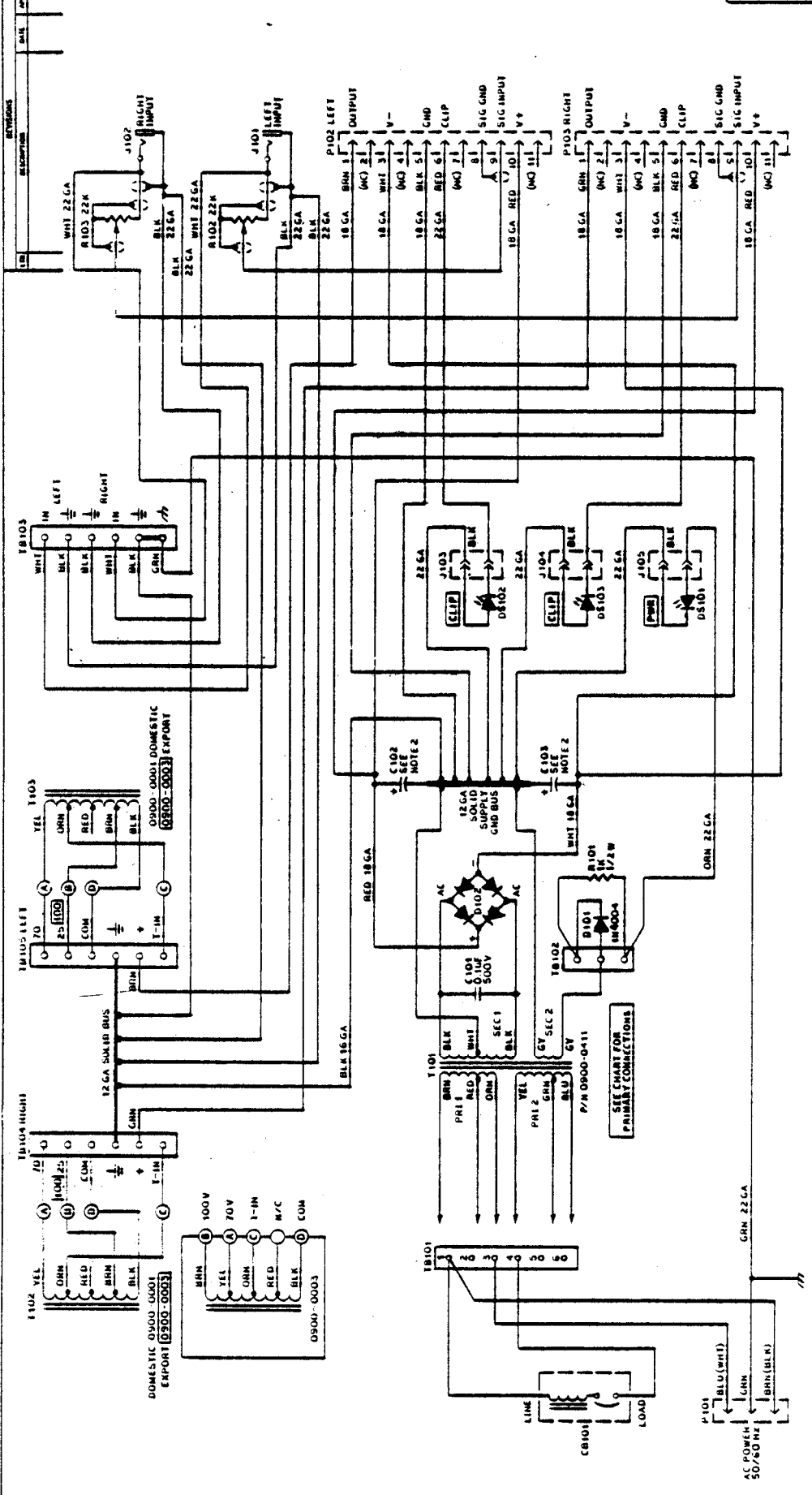

PRIMARY CONNECTIONS TO T101

AC VOLTS	100	120	200	220	240
XMFR - BRN	3	3	3	3	3
- RED	4	5	2	2	2
- GRN	5	4	2	2	2
- YEL	3	3	5	5	5
- GRN	4	2	4	4	4
XMFR BLU	2	4	6	6	6

CB101	100V	10AMP
	120V	0650-1104
	200V	UAMP
	220V	0650-1604
	240V	

NUMBERS SHOWN ARE TERMINALS ON T101. TOP TO BOTTOM AS SHOWN ON THIS Dwg. T101 IS LOCATED INSIDE UNIT ON REAR PANEL.

2 - SEE PARTS LIST
1 - REF. MODEL 62D

NOTES: 1. USE INSULATED WIRE PER MIL-W-100

UNLESS OTHERWISE SPECIFIED, ALL DIMENSIONS ARE IN INCHES. DIMENSIONS IN PARENTHESES ARE FOR INFORMATION ONLY. CHECK DIMENSIONS AGAINST DRAWING BEFORE STARTING WORK. ALL DIMENSIONS ARE TO CENTER UNLESS OTHERWISE SPECIFIED.

TITLE: SCHEMATIC, CHASSIS WIRING, POWER AMPLIFIER
 DRAWN: [Signature]
 CHECKED: [Signature]
 DATE: 1-11-60
 FORM NUMBER: MFRM-12120
 SHEET NUMBER: D
 SHEET TOTAL: 1 OF 1

ENG NO	DESCRIPTION	PART NO
***	PARTS LIST MODEL 620	***
	AMPLIFIER SCHEMATIC MFRM-12110	
	CHASSIS WIRING MFRM-12120	
***	CAPACITORS	***
C1	10UF 25V DIPPED TANTALUM	0226-0010
C2	220PF 1KV DISC CERAMIC	0100-0220
C3	50UF 12V ELECTROLYTIC	0456-0050
C4	.047UF 25V DISC CERAMIC	0129-0047
C5	.047UF DISC CERAMIC	0129-0047
C6	20PF 100V DIPPED MICA	0060-0020
C7	100PF 500V DIPPED MICA	0360-0100
C8	47PF 1KV DISC CERAMIC	0100-0047
C9	.005UF 1KV DISC CERAMIC	0100-0005
C10	120PF 500V DIPPED MICA	0090-0120
C11	20UF 100V ELECTROLYTIC	0436-0020
C12	20UF 100V ELECTROLYTIC	0486-0020
C13	120PF 500V DIPPED MICA	0090-0120
C14	120PF 500V DIPPED MICA	0090-0120
C15	.1UF 25V DISC CERAMIC	0129-0100
C16	2500PF 1KV DISC CERAMIC	0100-2500
C17	2500PF 1KV DISC CERAMIC	0100-2500
C18	.1UF 100V DIPPED MYLAR	0369-0100
C19	.1UF 100V DIPPED MYLAR	0369-0100
C20	1000PF 300V DIPPED MICA 5%	0080-1000
C21	.47UF 100V DIPPED MYLAR 10%	0369-0471
C22	1000PF 300V DIPPED MICA 5%	0080-1000
C23	.1UF 100V DIPPED MYLAR	0369-0100
C101	.1UF 500V DISC CERAMIC	0199-0100
C102	9800UF 100V ELECTROLYTIC	0566-9810
C103	9800UF 100V ELECTROLYTIC	0566-9810
	10000UF 100V ELECTROLYTIC	0566-0010
	9800UF OR 10000UF MAY BE USED	
	FDR 9800UF USE 2 1/2 CLAMP	1235-0025
	FDR 10000UF USE 2 CLAMP	1235-0001
***	DIODES	***
D1	IN4740A 10 VOLT ZENER	1900-4740
D2	IN4740A 10 VOLT ZENER	1900-4740
D3	IN4148 SI SWITCHING DIODE	1900-4148
D4	IN4148 SI SWITCHING DIODE	1900-4148
D5	IN4004 1 AMP 400V	1900-4004
D6	IN4004 1 AMP 400V	1900-4004
D7	IN4740A 10 VOLT ZENER	1900-4740
D101	IN4004 1 AMP 400V	1900-4004
D102	BRIDGE RECTIFIER 25A 200V	1886-2502

ENG NO	DESCRIPTION	PART NO
*** LED INDICATOR LAMPS ***		
DS101	LED, RED	1900-5053
DS102	LED, RED	1900-5053
DS103	LED, RED	1900-5053
*** INTEGRATED CIRCUITS ***		
IC1	LM318 OP AMP	1885-0318
*** JACKS AND PLUGS ***		
J101	1/4 PHONE JACK	9999-0111
J102	1/4 PHONE JACK	9999-0111
J103	2 PIN JACK FOR LED	1200-2021
J104	2 PIN JACK FOR LED	1200-2021
J105	2 PIN JACK FOR LED	1349-0114
PI01	AC PLUG MOLDED ON POWER CABLE	8709-0153
PI02	PLUG, 11 PIN	1350-0011
PI03	PLUG, 11 PIN	1350-0011
*** TRANSISTORS ***		
Q1	MJE350 PNP TRANSISTOR	1853-0350
Q2	MJE340 NPN TRANSISTOR	1854-0340
Q3	MJE720 NPN TRANSISTOR	1854-0720
Q4	MPSA93 PNP TRANSISTOR	1853-0093
Q5	MPSA43 NPN TRANSISTOR	1854-0043
Q6	MPSA43 NPN TRANSISTOR	1854-0043
Q7	MPSA93 PNP TRANSISTOR	1853-0093
Q8	MJE340 NPN TRANSISTOR	1854-0340
Q9	MJE350 PNP TRANSISTOR	1853-0350
Q10	SJ7394 NPN TRANSISTOR	1854-7394
Q11	SJ7407 PNP TRANSISTOR	1853-7407
Q12	SJ7394 NPN TRANSISTOR	1854-7394
Q13	SJ7407 PNP TRANSISTOR	1853-7407
Q14	SJ7394 NPN TRANSISTOR	1854-7394
Q15	SJ7407 PNP TRANSISTOR	1853-7407
Q16	SJ7394 NPN TRANSISTOR	1854-7394
Q17	SJ7407 PNP TRANSISTOR	1853-7407
Q18	SJ7394 NPN TRANSISTOR	1854-7394
Q19	SJ7407 PNP TRANSISTOR	1853-7407
Q20	SJ7394 NPN TRANSISTOR	1854-7394
Q21	SJ7407 PNP TRANSISTOR	1853-7407
Q22	MPSA93 NPN TRANSISTOR	1853-0093
Q23	MPSA43 NPN TRANSISTOR	1854-0043
Q24	MPSA43 NPN TRANSISTOR	1854-0043

ENG NO	DESCRIPTION	PART NO
	*** RESISTORS ***	
R1	47K OHM 1/2W 5%	5005-4703
R2	2.49K OHM 1/2W 1%	5001-2491
R3	1K OHM 1/2W 5%	5005-1003
R4	1K OHM 1/2W 5%	5005-1003
R5	3.9K OHM 2W 10%	6020-3902
R6	133K OHM RN55 1%	5011-1333
R7	3.9K OHM 2W 10%	6020-3902
R8	4.7K OHM 1/2W 5%	5005-4702
R9	100 K OHM 1/2W 5%	5005-1002
R10	47K OHM 1/2W 5%	5005-4703
R11	680 OHM 1/2W 5%	5005-6801
R12	15K OHM 1/2W 5%	5005-1503
R13	15K OHM 1/2W 5%	5005-1503
R14	680 OHM 1/2W 5%	5005-6801
R15	47K OHM 1/2W 5%	5005-4703
R16	100 OHM 1/2W 5%	5005-1002
R17	110 OHM 1/2W 5%	5005-1101
R18	100K OHM 1/2W 5%	5005-1005
R19	100K OHM 1/2W 5%	5005-1005
R20	100 OHM 1/2W 5%	5005-1002
R21	680 OHM 1/2W 5%	5005-6801
R22	SEE NOTE ON SCHEMATIC	
R23	100 OHM 1/2W 5%	5005-1002
R24	SEE NOTE ON SCHEMATIC	
R25	10K OHM 1/2W 5%	5005-1004
R26	47K OHM 1/2W 5%	5005-4703
R27	10K OHM 1/2W 5%	5005-1004
R28	10K OHM 1/2W 5%	5005-1004
R29	100K OHM 1/2W 5%	5005-1005
R30	4.7K OHM 1/2W 5%	5005-4702
R31	2.7K OHM 1/2W 5%	5005-2702
R32	2.7K OHM 1/2W 5%	5005-2702
R33	4.7K OHM 1/2W 5%	5005-4702
R34	100 OHM 1/2W 5%	5005-1002
R35	100 OHM 1/2W 5%	5005-1002
R36	2.7 OHM 1/2W 5%	4025-2070
R37	2.7 OHM 2W 5%	4025-2070
R38	.33 OHM 5W 10%	4050-0330
R39	.33 OHM 5W 10%	4050-0330
R40	.33 OHM 5W 10%	4050-0330
R41	.33 OHM 5W 10%	4050-0330
R42	.33 OHM 5W 10%	4050-0330
R43	.33 OHM 5W 10%	4050-0330
R44	.33 OHM 5W 10%	4050-0330
R45	.33 OHM 5W 10%	4050-0330
R46	.33 OHM 5W 10%	4050-0330
R47	.33 OHM 5W 10%	4050-0330
R48	2.7 OHM 2W 5%	4025-2070
R49	30 OHM 5W 10%	4050-3001

BGW SYSTEMS, INC.

12190-4

ENG NO	DESCRIPTION	PART NO
R50	1.8K OHM 1/2W 5%	5005-1802
R51	1.8K OHM 1/2W 5%	5005-1802
R52	100 OHM 1/2W 5%	5005-1002
R101	1K OHM 1/2W 5%	5005-1003
R102	22K OHM STEP ATTENUATOR	7006-2015
R103	22K OHM STEP ATTENUATOR	7006-2015
*** SWITCHES ***		
S1	SWITCH, THERMAL OOR 212F MODEL 600	0630-3444
C3101	CIRCUIT BREAKER 100/120V 10 AMP 200/220/240V 6 AMP	0650-1104 0650-1502
*** TRANSFORMERS ***		
T101	TRANSFORMER, POWER SUPPLY	0900-0411
T102	25/70VOLT AUTO TRANSFORMER	0900-0001
T103	25/70VOLT AUTO TRANSFORMER EXPORT MODELS MAY HAVE DIFFERENT AUTO TRANSFORMERS	0900-0001
T102	100 VOLT AUTO TRANSFORMER	0900-0002
T103	100 VOLT AUTO TRANSFORMER	0900-0002
T102	70/100 VOLT AUTO TRANSFORMER	0900-0003
T103	70/100 VOLT AUTO TRANSFORMER	0900-0003
*** BARRIER STRIPS ***		
T3101	5 POINT QUICK CONNECT STRIP	0720-9120
T3102	3 POINT SOLDER STRIP	1231-3003
T3103	BARRIER STRIP, 5 LUG	0720-1597
T3104	BARRIER STRIP, 5 LUG	0720-1597
T3105	BARRIER STRIP, 5 LUG	0720-1597
*** ELECTRICAL HARDWARE ***		
9	SLIP-ON LUG FOR 14-16 GA. WIRE	1322-9700
1	CRIMP LUG FOR 10-12 GA. WIRE	1313-3457
3	SLIP-ON LUG W BLUE INSULATION	1321-5305
2	CAPACITOR CLAMP SEE C102 / C103	
12	INSULATOR, MICA FOR T0-3	0723-0321
24	INSULATOR, SHOULDER	0723-3347

ENG NO	DESCRIPTION	PART NO
	*** CHASSIS AND PACKING ***	
1	CHASSIS, MODEL 620	9002-1620
1	TOP COVER, MODEL 620	9005-1600
4	COVER, TRANSISTORS MODEL 620	9008-1600
1	FRONT PANEL, MODEL 620	9000-1520
1	CARTON, INNER MOD 620	9850-1600
1	CARTON, OUTER MOD 620	9851-1600
1	MANUAL	
	*** MECHANICAL HARDWARE ***	
1	PRINTED CIRCUIT BOARD	9007-0751
2	KNOB, .88 IN. DIA. BLK	0700-1273
2	LJG, SLIP-ON	1322-9600
4	SPACER .140 X .250 X .156	8605-0156
1	HEATSINK EXTRUSION	1000-0751
	*** NUTS, BOLTS, AND WASHERS ***	
6	6-32 X 1/4 HEX NUT	8530-0250
6	6-32 X 1/4 HEX NUT	8530-0250
2	6-32 X 3/8 FLAT HEAD HEX SOC BLK	2331-3375
1	6-32 X 5/16 HEX NUT	8530-0312
1	8-32 X 5/16 HEX NUT	8540-0312
8	8-32 X 5/16 HEX KEP NUT	8543-0312
12	10-32 X 3/8 HEX NUT	8550-0375
2	3/8-32 HEX NUT NICKEL	8574-0500
5	4-40 X 3/8 PHILIPS PAN HEAD MS	2115-2375
7	6 X 3/8 PHILIPS PAN HEAD SMS BLK	3111-3312
2	6 X 5/8 PHILIPS PAN HEAD SMS BLK	3111-3625
20	6-32 X 5/8 SLOT ROUND HEAD MS	2225-3625
7	6-32 X 5/16 PHILIPS PAN HEAD MS BLK	2111-3312
4	6-32 X 3/4 PHILIPS PAN HEAD MS	2115-3750
4	8 X 1/2 PHILIPS HEAD SMS	3115-4500
12	8 X 5/8 PHILIPS PAN HEAD SMS BLK	3115-4625
12	8 X 5/8 PHILIPS PAN HEAD SMS BLK	3111-4625
6	8-32 X 1/2 PHILIPS PAN HEAD MS BLK	2111-4500
3	8-32 X 3/4 PHILIPS PAN HEAD MS BLK	2111-4750
4	10-32 X 1/2 PHILIPS PAN HEAD MS BLK	2111-5500
8	10-32 X 3/8 SLOT HEAD MS	2125-5375
8	10-32 X 3/8 ALLEN FLAT HEAD MS BLK	2331-5375
7	#5 INTERNAL TOOTH LOCKWASHER	8132-0000
3	#5 FLAT FIBER WASHER	8135-0000
3	#8 INTERNAL TOOTH LOCKWASHER	8142-0000
6	#8 EXTERNAL TOOTH LOCKWASHER	8143-0000
2	#8 FLAT WASHER	8141-0000
12	#10 SPLIT WASHER	8154-0000
3	.195 ID # 3/8 FLAT FIBER WASHER LEDS	8155-0000

POWER MAINS VOLTAGE CONVERSION
 SERIAL NUMBERS ABOVE 79A0000 EXCEPT THOSE WITH
 POWER TRANSFORMERS MARKED 0900-0251, 0900-0410E, or 0900-410F.
 FOR EARLIER UNITS SEE 04500

CAUTION: These servicing instructions are for use by qualified personnel only. To avoid electric shock do not perform any servicing other than that contained in the Operating Instructions, unless you are qualified to do so. Refer all servicing to qualified service personnel.

Voltage conversion should be done by a BGW Authorized Service Station only.

Terminal Strip Connections

The terminal strip (TB1) is located on the inside back wall of the chassis. To gain access, remove the eight screws holding the top cover. The chart below indicates the proper transformer connections for each voltage.

PRIMARY CONNECTIONS TO TB1					
AC VOLTS	100	120	200	220	240
XMFR - BRN	3	3	3	3	3
XMFR - RED	4	5	5	2	2
XMFR - ORN	5	4	2	5	5
XMFR - YEL	3	3	5	5	5
XMFR - GRN	4	2	4	4	6
XMFR - BLU	2	4	6	6	4

NOTE: Numbers shown are terminals on TB1 and are read from top to bottom as shown.

SERVICE AUTHORIZATION FORM

PLEASE COMPLETE THIS FORM AS COMPLETELY AS POSSIBLE AND RETURN TO BGW SYSTEMS BEFORE RETURNING UNIT.

NAME: _____ PHONE: _____

ADDRESS: _____
(CITY) (STATE) (ZIP)

UNIT: _____
MODEL SERIAL NUMBER

1. DESCRIBE SYMPTOMS:
2. WHICH CHANNELS (S) EXHIBITS THE PROBLEMS?
3. WHAT OTHER EQUIPMENT WAS INVOLVED?

	MANUFACTURER	MODEL NO.
PREAMP	_____	_____
SPEAKERS	_____	_____

4. UNDER WHAT CONDITIONS DOES THE PROBLEM OCCUR (CHECK THOSE THAT APPLY).
 - A. ALL THE TIME _____
 - B. AFTER AWHILE _____
 - C. AT HIGH VOLUME LEVELS _____
 - D. AT HIGH TEMPERATURES _____
 - E. OTHER (EXPLAIN) _____
5. HOW OFTEN DID THE PROBLEM OCCUR?
6. WHAT DID YOU DO TO ISOLATE THE PROBLEM TO THE POWER AMP?
7. FURTHER COMMENTS:

IT IS MORE EXPEDIENT TO CALL YOUR DEALER OR OUR FACTORY EXPLAINING THE NATURE OF YOUR PROBLEM. IN MANY INSTANCES THE PROBLEM CAN BE SOLVED WITHOUT RETURNING THE UNIT TO THE FACTORY. WARNING: THE UNIT MUST BE RETURNED IN AN ORIGINAL FACTORY CONTAINER. IF YOU DO NOT HAVE ONE, WE WILL PROVIDE A REPLACEMENT FOR \$14.00. FACTORY AUTHORIZED WARRANTY REPAIR STATIONS ARE LOCATED THROUGHOUT THE U.S. CALL YOUR DEALER OR THE FACTORY FOR THE LOCATION OF THE SERVICE STATION NEAREST YOU.

PLACE
STAMP
HERE

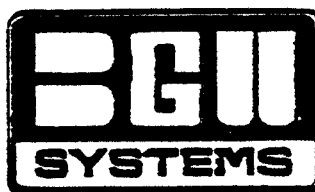

13130 SOUTH YUKON AVENUE
HAWTHORNE, CALIFORNIA 90250

FOLD HERE

WARRANTY REGISTRATION

PLEASE FILL OUT AND RETURN THIS CARD WITHIN 2 WEEKS FROM DATE OF PURCHASE.

NAME: _____ DATE PURCHASED: _____

ADDRESS: _____ PHONE: _____

CITY: _____ STATE: _____ ZIP: _____

PURCHASED FROM: _____

DEALER

ADDRESS

CITY

STATE

ZIP

MODEL NUMBER: _____

SERIAL NUMBER: _____

PURCHASE PRICE: _____

FOR WHAT PURPOSE IS THE UNIT INTENDED?

HOME _____

STUDIO _____

SOUND REINFORCEMENT _____

OTHER (EXPLAIN) _____

IS THIS AMPLIFIER A REPLACEMENT FOR AN EXISTING UNIT?

IF YES, WHAT KIND? _____

WHY DID YOU CHOOSE A BGW POWER AMPLIFIER?

_____ DEALER RECOMMENDATION

_____ MAGAZINE ADVERTISEMENT

_____ SOUND QUALITY

_____ TECHNICAL DESIGN

_____ FRIEND'S RECOMMENDATION

_____ OTHER _____

COMMENTS:

PLACE
STAMP
HERE



13130 SOUTH YUKON AVENUE
HAWTHORNE, CALIFORNIA 90250

FOLD HERE