



13130 SOUTH YUKON AVENUE
PHONE (213) 973-8090

HAWTHORNE, CALIFORNIA 90250
TELEX NO. 66-4494

OWNER'S MANUAL
MODELS 750D AND 750E
PROFESSIONAL POWER AMPLIFIERS

TABLE OF CONTENTS

<u>DESCRIPTION</u>	<u>FORM NUMBER</u>
Important	00601
Description	00890
Option Page	00891
Specifications	02320
Continuous Power vs. Frequency	27501
Pulse Power vs. Duty Cycle	27502
Distortion Vs. Power	27503
Crosstalk vs. Frequency	27504
Unpacking and Set-Up	02530
Rack Mounting Hints	02660
Input Configurations	02705
Input Connections	03008
Termination Formula	03051
Output Connections	03501
Damping Factor/Wire Size Graph	03510
Speaker Fusing Nomograph	03530
Mono Operation.	03652
Power Mains Connection	04000
Power Mains Conversion	04115
Turn-On and Operation	05204

Circuit Description	06340
750E Meter Description	06341
Amplifier Schematic	14220
Chassis Schematic	14230
750D Display Schematic	14240
750E Meter Schematic	14260
750E Chassis Schematic	14250
Parts List	14290
Product/Option Matrix.	16000
Warranty	17000
Service Authorization Form	17020
Warranty Registration Form	17030

- IMPORTANT -

PLEASE READ THIS PAGE BEFORE OPERATING

YOUR

BGW POWER AMPLIFIER

Your new BGW amplifier is designed to provide years of trouble free performance. Observing these few precautions will insure proper operation:

Read all Instructions before connecting any AC power to your power amplifier.

Retain this Manual for future reference.

Heed all warnings on the top or rear of the power amplifier.

The amplifier should not be used near water - for example, near a bathtub, washbowl, kitchen sink, laundry tub, in a wet basement, or near a swimming pool, etc.

The amplifier should be situated so that its location or position does not interfere with its proper ventilation. For example, it should not be situated on a bed, sofa, rug, or similar surface that may block the ventilation openings; or, placed in a built-in installation, such as a bookcase or cabinet that may impede the flow of air through the ventilation openings.

The amplifier should be situated away from heat sources such as radiators, heat registers, stoves, or other appliances that produce heat.

The amplifier should be connected to a power supply only of the type described in the operating instructions or as marked on the rear panel.

Precautions should be taken so that the grounding means of the amplifier is not defeated.

The power supply cord should be routed so that it is not likely to be walked on or pinched by items placed upon or against it, paying particular attention to cord at the plug, convenience receptacles, and the point where they exit from the amplifier.

Care should be taken so that objects do not fall into, and liquids are not spilled into the amplifier through openings.

The amplifier should be serviced by qualified service personnel when:

The power supply cord or the plug has been damaged; or objects have fallen into, or liquid has been spilled into the amplifier; or has been exposed to rain; or does not appear to operate normally or exhibits a marked change in performance; or has been dropped, or the enclosure has been damaged.

All connections should be made to the power amplifier with the power OFF.

Speaker fuses should be used to afford maximum speaker protection.

Never connect the output of one channel to that of another.

Connect the power cord to the proper voltage mains as indicated on the rear of the amplifier. Conversion to another voltage requires internal rewiring.

Do not remove the amplifier's cover. Amplifiers may not be covered under warranty if they are tampered with. There are NO adjustments within. Potentially lethal voltages exist within the amplifier. Refer all service work to an authorized BGW service station.

DESCRIPTION

The BGW Models 750D and 750E are members of a new family of Professional Power Amplifiers. The 750D & E employ the latest discrete circuitry and UltraCase™ semiconductor technology.

Features of the Models 750D & E include a magnetic circuit breaker, calibrated precision Stepped attenuators, looping XLR and 1/4" inputs, Electronic speaker protection, Toroidal power transformer and Modular construction.

The Model 750D front panel includes two stepped attenuators, a magnetic circuit breaker/power switch, a green "ON" LED, two yellow "modulation" LEDs, and two red "true clip" LEDs. The heavy front panel is made from 0.190" aluminum and selective anodized with gold lettering. Two heavy duty handles are also provided.

The Model 750E front panel includes two stepped attenuators, a magnetic circuit breaker/power switch, and a high performance dual 60dB level meter with eight (8) status indicator lights and "true clip" indicators.

The rear panel includes the AC power cord, input module, output binding posts, mono/stereo switch, ground lift switch, fan defeat switch, and the fan.

The input module has four connectors for each channel: One XLR male, one XLR female, and two 1/4" TRS jacks. All the connectors are in parallel for easy daisy-chain interconnections. Isolation transformers can be installed easily, and the phase can be reversed by changing two jumpers. Optional high performance balanced electronic input modules can be ordered (Option 02).

The Models 750D & E are built to take a lot of punishment. However, we recommend that rear support is provided to the chassis using the factory PEM nuts installed.

Each channel of the 750D & E has 12 ultracase transistors for a total of 2400 watts of safe operating area. Highly reactive loads are easily handled by the 750D & E. Two ohm loads on each channel in dual channel operation or a 4 ohm load in bridge connected single channel operation results in the maximum power transfer.

MODELS 750D AND 750E
OPTIONS

The Professional Power Amplifier Models 750D and 750E are available from the factory with custom options to fit your needs. Some of these options can be installed in the field by qualified service technicians.

Please contact the factory for details.

The initial Models 750D and 750E Options are listed below:

- Option 02 Stereo Active Balanced Input Module
- Option 06, 07 Single/Dual Transformer Balanced Input
- Option 15 Dual 18dB Crossover Module
- Option 70 Install Quiet 50CFM Fan
- Option 71 Install High Speed 90CFM Fan

MODEL 750D
SPECIFICATION TABLE

Hum and Noise:	113dB below 250 watts/8 ohms 20Hz-20kHz unweighted. 115dB minimum below 250 watts/8 ohms A weighted.
Input Sensitivity:	1.42 VRMS for rated 8 ohm output.
Voltage Gain:	X 31.6 or 30.0dB.
Input Impedance:	15 kohms.
Load Capability:	Drives any load of 2 ohms or greater in dual channel mode or 4 ohms or greater in single channel operation.
Damping Factor:	500:1 RE:8 ohms below 500Hz.
Power Requirements:	1500 watts for rated 4 ohm power. 100, 110, 120, 200, 220, or 240 VAC : 50-60Hz.
Dimensions:	7" X 19" Standard Rack Front Panel Chassis: 7" X 17" X 12" D.
Weight:	50 Lbs. Net 55 Lbs. Shipping.

MODEL 750D SPECIFICATIONS

FTC POWER OUTPUT

250 watts minimum sine wave continuous average power per channel with both channels driving 8 ohm loads. The maximum total harmonic distortion at any level from 1 watt to 250 watts and at any frequency from 20Hz to 20kHz is .03%.

400 watts minimum sine wave continuous average power per channel with both channels driving 4 ohm loads. The maximum total harmonic distortion at any level from 1 watt to 400 watts and at any frequency from 20Hz to 20kHz is .06%.

800 watts minimum sine wave continuous average power into an 8 ohm load driven in bridge connected monaural operation. The maximum total harmonic distortion at any level from 2 watts to 800 watts and at any frequency from 20Hz to 20kHz is .06%.

All measurements assume 120VAC or equivalent supplied to the power cord.

All specifications and features are subject to change without notice.

IHF DYNAMIC POWER OUTPUT

350 watts per channel with both channels driving 8 ohm loads.

600 watts per channel with both channels driving 4 ohm loads.

850 watts per channel with both channels driving 2 ohm loads.

1200 watts into an 8 ohm load driven in bridge connected monaural operation.

1700 watts into a 4 ohm load driven in bridge connected monaural operation.

EQUIVALENT
AVERAGE
POWER
WATTS

750D DYNAMIC POWER CURVE PULSE POWER vs. DUTY CYCLE

POWER INTO BRIDGED MONO LOAD
BELOW VISIBLE CLIP.
AMPLIFIER IS COOL
120VAC POWER SUPPLIED

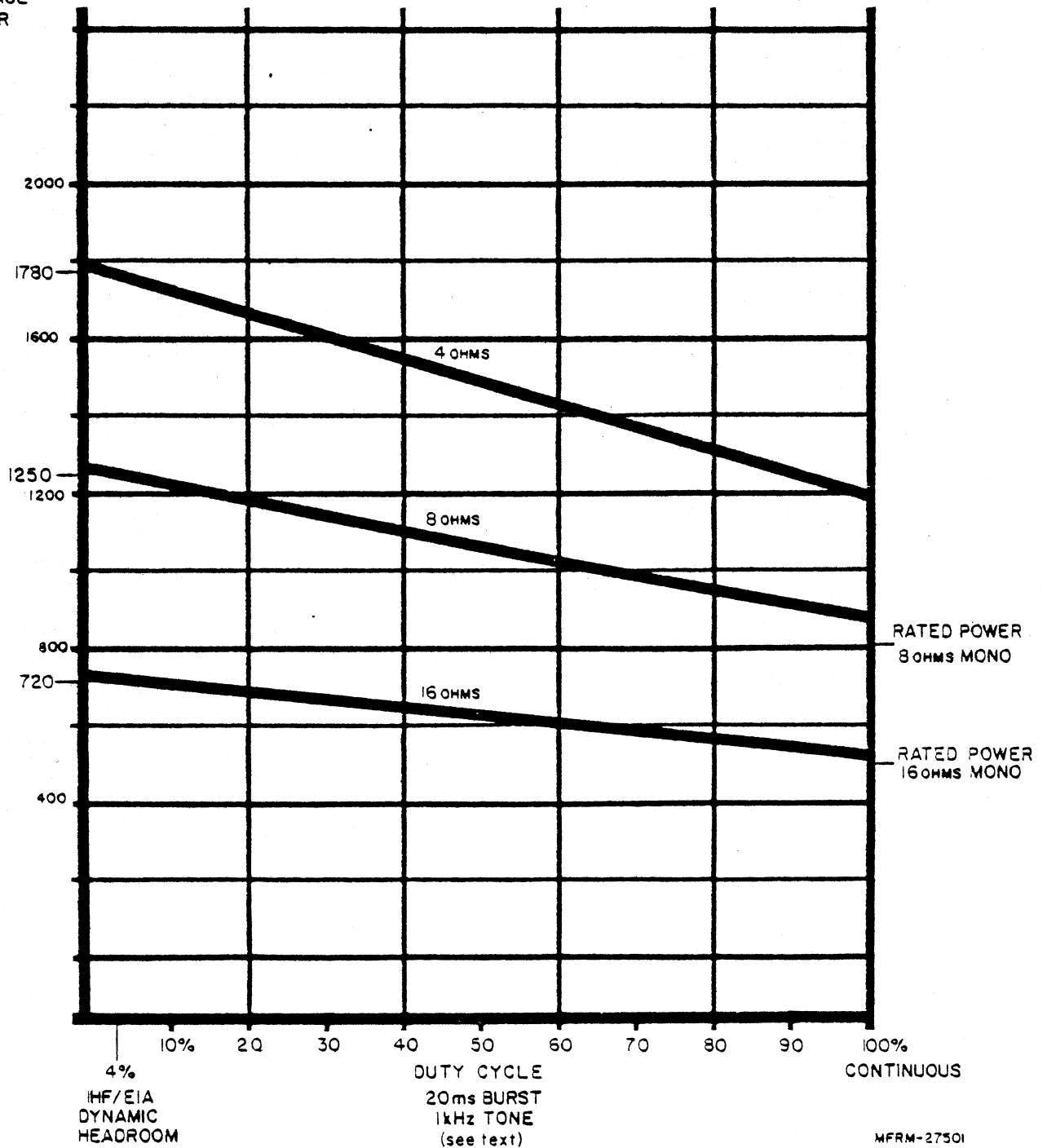

CONTINUOUS
POWER
OUTPUT
PER CHANNEL

MODEL 750D CONTINUOUS OUTPUT POWER vs. FREQUENCY TOTAL HARMONIC DISTORTION vs. FREQUENCY

TYPICAL CURVES
BOTH CHANNELS DRIVEN
120WAC POWER SUPPLIED

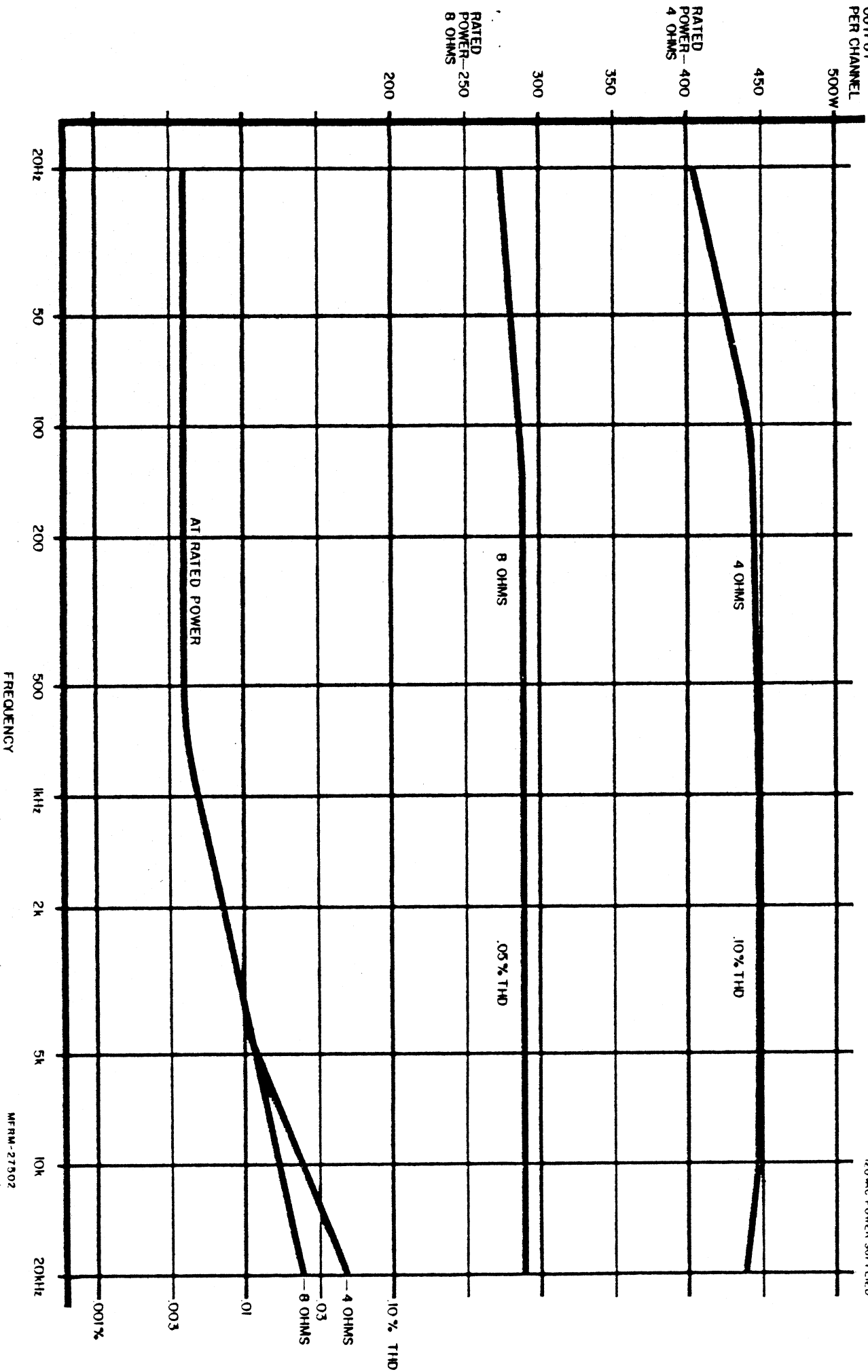

MODEL 750D DISTORTION vs. OUTPUT POWER

1KHz. BOTH CHANNELS DRIVEN.
TYPICAL CURVES

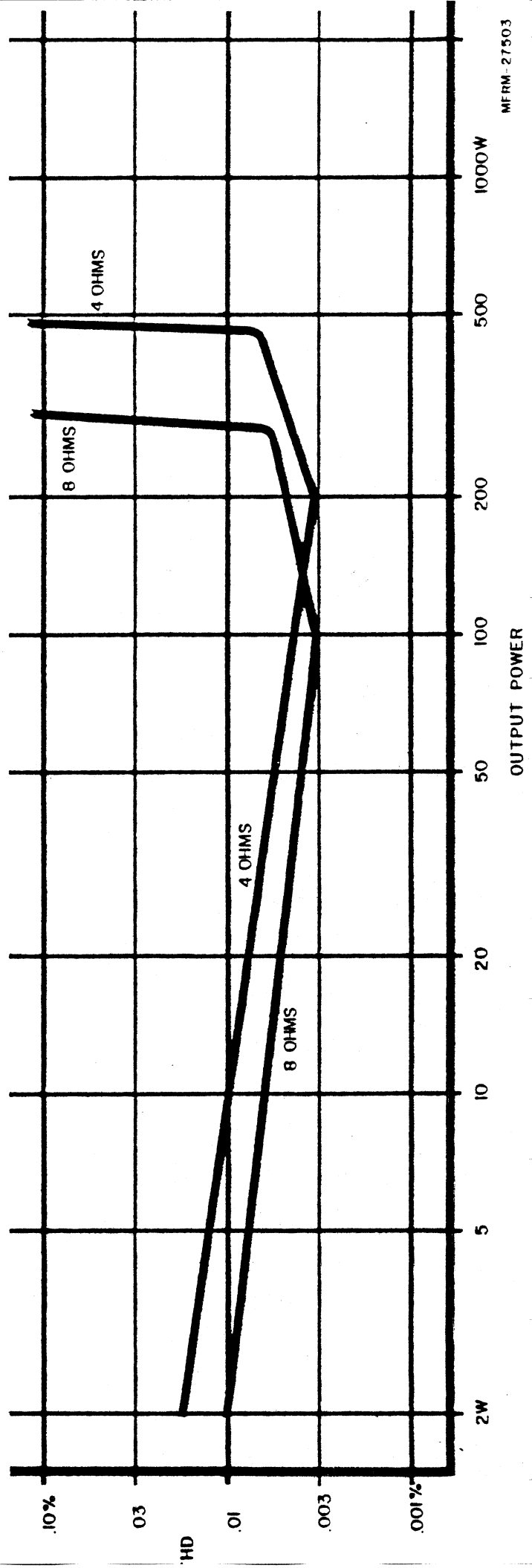

MODEL 750D CROSSSTALK VS. FREQUENCY

TYPICAL CURVE, WORST DIRECTION
DRIVEN CHANNEL: 400W/4 OHMS
IDLE CHANNEL: 600 OHM INPUT TERM.

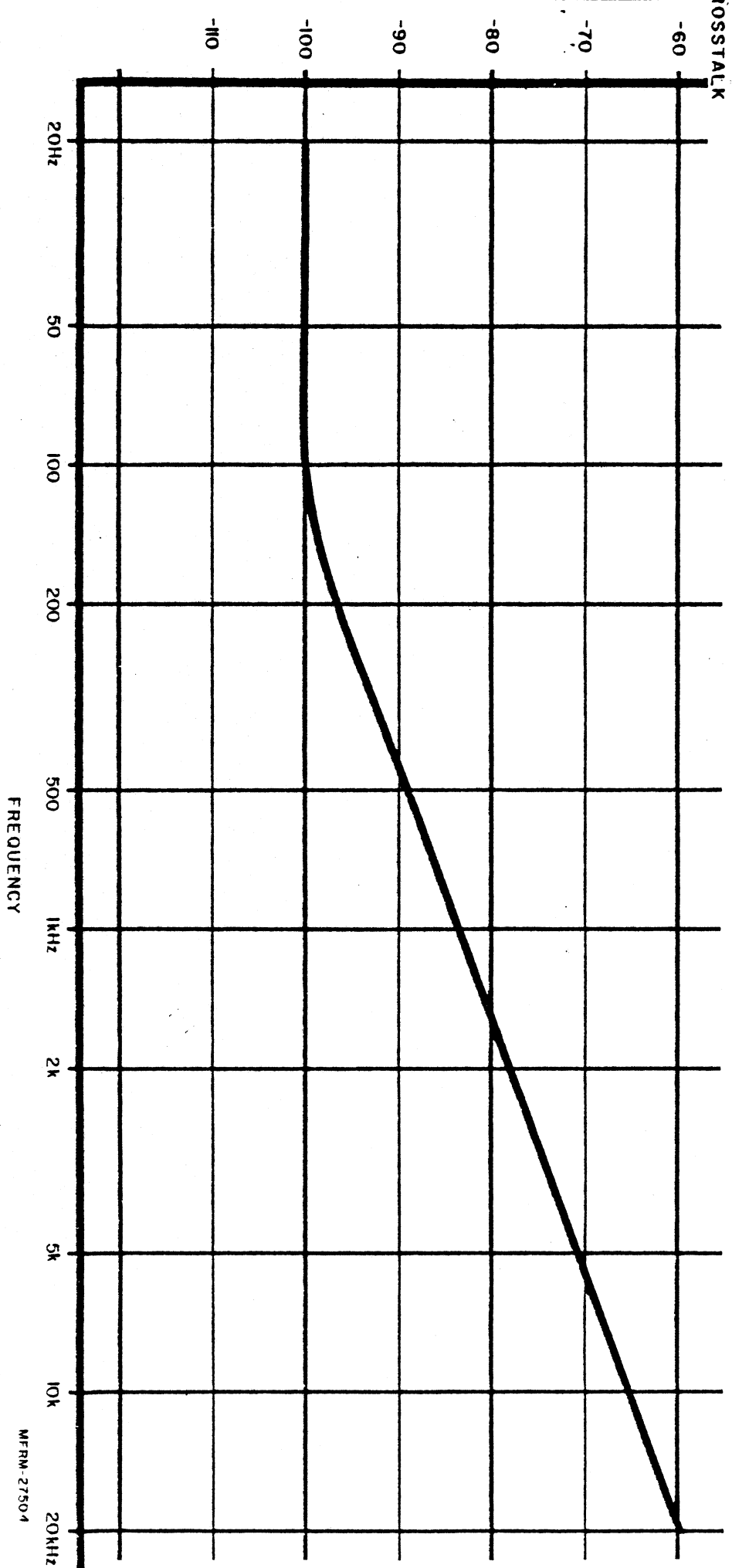

UNPACKING AND SET-UP

Your BGW Power Amplifier is shipped in an advanced packing container.

SAVE THE CONTAINER AND ALL PACKING MATERIAL!

The container should be saved in the event the unit is moved or shipped at some future date. Replacement containers are available from BGW Systems.

Inspect the unit for damage in transit immediately upon receipt. If damage is found, notify the transportation company immediately. Only the consignee may institute a claim with the carrier for shipping damage. BGW will cooperate fully in such an event. Be sure to save the container as evidence of damage for the shipper to inspect.

The amplifier's mounting position must be chosen carefully, so that the air flow to the rear of the unit or its sides is not restricted. Inadequate ventilation may cause failure of the amplifier. For rack mounting, the four rubber feet on the bottom of the unit may be removed and no hardware will be loosened inside the unit.

Do not, however, use the front panel as the sole support for the amplifier. Side rails or rack shelves should be employed.

DO NOT PLUG THE AMPLIFIER IN YET!

All connections should be made before power is applied.

RACK MOUNTING HINTS

KEEPING IT COOL

A power amplifier draws energy from a primary electrical service, usually a 120volts AC outlet, to drive loudspeaker systems with an audio signal. Typically, only half of the energy can be delivered to the loudspeakers; remaining energy is converted into heat, and must be dissipated (ventilated) into the air.

Air circulating past heat-producing components absorbs the heat and carries it away. To accomplish this, low and medium power amplifiers rely on natural convection currents, while most high power amplifiers use fans. If the air flow is impeded, the resulting rise in heat may cause an amplifier to stop working or fail.

Circulating air currents must not be cut off when installing power amplifiers in racks. Power amplifiers using convection cooling require spacing between amplifiers to permit air flow between them. Power amplifiers using forced-air cooling, on the other hand, can usually be stacked closer to each other and may not need any blank panel spacing between amplifiers.

To improve natural convection currents within a rack, a chimney can be created by closing the back of the rack and venting the rack at the bottom to let in fresh air, and at the top to exhaust hot air. Vents should be large rectangular slots approximately 19" wide by 4" high.

The rack cabinet will require some type of blower if a large air-flow is required. It is best to exhaust air from the top of the rack rather than to blow it in from the bottom. There will be less dust and dirt in the rack this way, if the bottom vent is sufficiently large.

INSTALLING THE UNITS

Use care when mounting equipment in a rack. Place the heaviest units near the bottom of the rack and fill in all unused rack spaces with blank panels. Equipment cannot always be supported by front panels alone. This is especially true of amplifiers whose depth is more than twice their height. Uniform support can be insured by installing bottom or side rails.

When racks are to be transported or used in mobile installations, some means of securing the rear of the equipment is required. Angle brackets attached either to the bottom, sides or rear panel are practical approaches.

1/4" INPUT CONNECTIONS

1/4 inch phone jacks are provided on the rear of the amplifier for input connections.

1/4 INCH PHONE JACKS

The 1/4" phone jacks can be used for balanced or unbalanced lines inputs.

BALANCED INPUTS

1. Connect the shield to the outer sleeve of the plug.
2. Connect the (HI) positive phase conductor to the tip.
3. Connect the (LO) negative phase conductor to the ring. See diagram below.

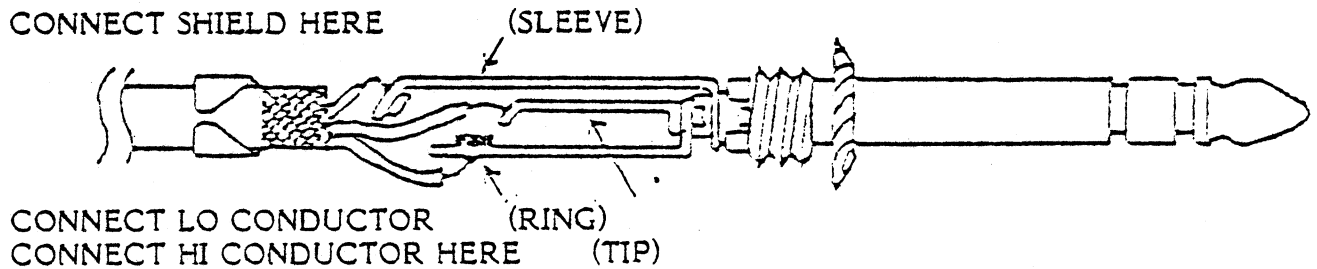

UNBALANCED INPUTS

1. Connect the shield and (the (LO) negative phase conductor) to the outer sleeve of the plug.
2. Connect the (HI) positive phase conductor to the tip. See diagram below.

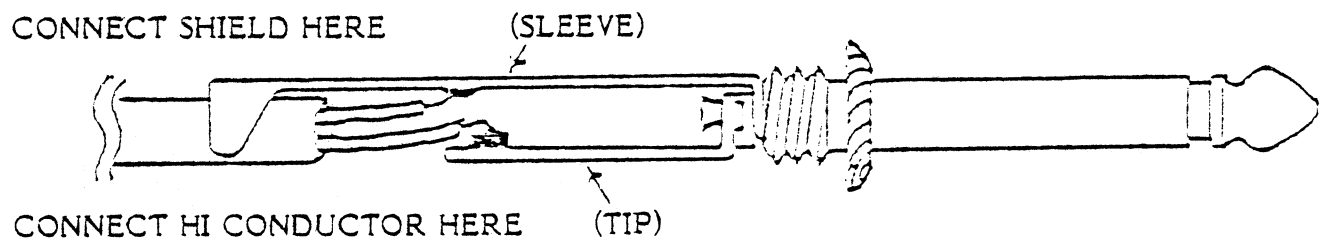

XLR INPUT CONNECTIONS

Three-pin XLR jacks are provided on the rear of the amplifier for input connections. Balanced or unbalanced lines may be used; however if input cables are longer than eight feet (8'), balanced lines may be necessary to maintain the signal-to-noise ratio and high frequency response.

3-PIN XLR CONNECTORS

The 3-pin XLR connectors may be used with balanced (2-conductor, shielded) or unbalanced lines. NOTE: That balanced or unbalanced line inputs can be wired to operate the amplifier in an non-inverting or inverting mode by switching pins 2 and 3.

UNBALANCED LINES INPUTS

To use the 3-pin XLR connectors with unbalanced lines,

When using single conductor shielded cable for unbalanced lines, connect the inner conductor to pin #3 and the shield to pins #1 & #2.

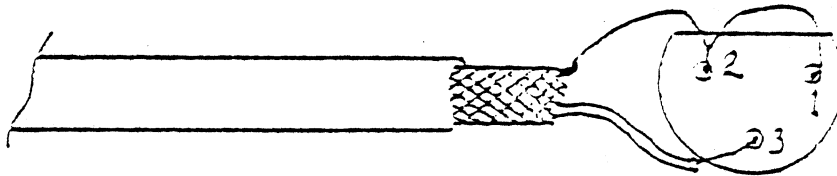

When using 2-conductor shielded cable for unbalanced lines, connect the high level signal wire to pin #3, the low level signal wire to pin #2, and the shield to pin #1.

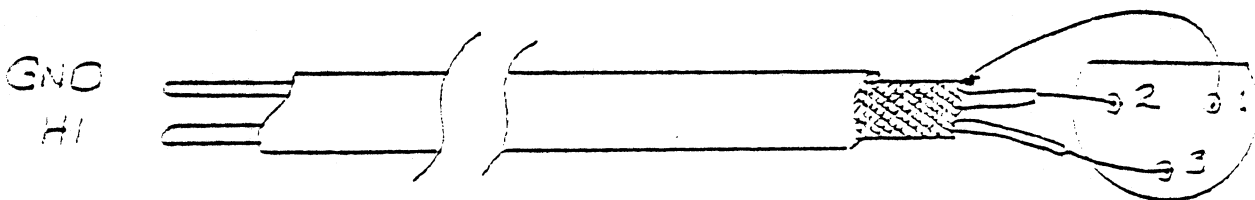

NOTE: The shield should not be connected to anything at signal source.

Balanced Line Inputs

Two conductor shielded cables should be used in a balanced line system. Connect input cables as shown below.

Pin #1 Shield (Ground)
Pin #2 Signal (Minus) LO
Pin #3 Signal (Plus) HI

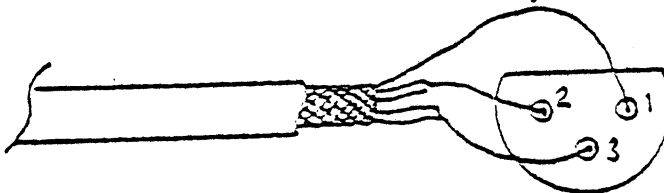

Note: By exchanging pins 2 and 3 the amplifier will be run in inverting mode.

On rare occasions, usually when the signal source is a transformer, a terminating resistor may be required. Determine the value of the termination resistor from Page 03051, connect it between signal HI and signal LO. Usually this resistor is connected using the spare XLR or $\frac{1}{8}$ " jacks provided.

TERMINATING RESISTANCE CHART

How to find terminating resistance for balanced or unbalanced lines, driving more than one amplifier. R_s = Source Impedance (usually 600 ohms).

STEP A
Impedance

$$\frac{\text{*Input Impedance of Amplifiers}}{\text{Number of Amplifiers}} = \frac{\text{Total Load}}{\text{of Amplifiers}}$$

STEP B

$$\frac{\text{Total Impedance of Amplifiers} - R_s}{R_s} = K \text{ (Impedance Factor)}$$

STEP C

$$\left(\frac{1}{K} + 1\right) \times R_s \text{ ohms} = \text{Load Resistor Required}$$

EXAMPLE:

Input Impedance of Amplifiers = 15,000 ohms

Number of Amplifiers = 4 R_s = 600 ohms

A

$$\frac{15,000}{4} = 3750 \text{ ohms}$$

B

$$\frac{3750 - 600}{600} = 5.25$$

C

$$\frac{1}{5.25} + 1 \times 600 = 1.19 \times 600 = 714.29 \text{ ohms}$$

Closest value is 715 ohms 1% metal film resistor.

* Note all amplifiers must have the same input impedance. If not, use formula below:

$$\frac{1}{\frac{1}{Z_1} + \frac{1}{Z_2} + \frac{1}{Z_3} + \frac{1}{Z_n}} = \text{Total Load Impedance}$$

EXAMPLE: Four (4) Amplifiers with input impedance of 15k, 30k, 30k and 7.5k

$$\frac{1}{\frac{1}{15K} + \frac{1}{30K} + \frac{1}{30K} + \frac{1}{7.5K}} = 3750 \text{ ohms}$$

*The impedance of a speaker system can be approximated by measuring the resistance across the speaker terminals, with the amplifier disconnected. Multiplying this result by 1.33, gives you the approximate impedance.

Note: This method cannot be used with electrostatic speakers.

This nomograph can be used in many ways to help plan your system. If three out of the five parameters are known, the other two can be determined.

Remember to add the resistance of the fuse to R_s if it is significant. Be careful using this chart for distributed systems (25V/70V).

STEREO OUTPUT CONNECTIONS

Two sets of five-way binding posts, on the rear panel, serve as output connectors, with one black and one red binding post for each channel. Left channel leads go to the binding posts marked LEFT; right channel, to those marked RIGHT.

Output leads are best connected, to the amplifier, with standard banana plugs; however, the five-way action of the binding posts permits the use of tinned wires or spade lugs.

Make certain that the speakers are properly phased. Connect the black or minus (-) terminal on the speaker cabinet to the appropriate black binding post on the amplifier. Connect the red or plus (+) terminal to the red binding post. Check to see that the Stereo-Mono switch on the rear of the amplifier is in the stereo position.

SPEAKER PROTECTION

All speakers can be damaged by having too much power applied to them. Fuse protection is an effective and inexpensive way of preventing this from occurring. If your speaker system does not contain a fuse or a circuit breaker, a fuse should be placed in series with each speaker and the wire going to the red terminal on the rear of the amplifier.

Maximum protection can be obtained with fast-acting fuses. Use the value recommended by the manufacturer. If no value is specified, use the chart provided to select the correct value (MFRM-03530).

To use the chart, take a straightedge, such as a ruler, and line up the speaker's impedance with its peak music power rating. The proper fuse value can then be read from the center column. Choose a fuse that is closest to, and below, the value indicated.

WIRE SIZE AND DAMPING FACTOR

The high damping factor of BGW amplifiers results in a very clean bass response. Excessively long, and small diameter speaker wires can lower the damping factor and distort the lower frequencies. A damping factor of at least 50 should be maintained to insure good audio quality.

The relationship between wire length and diameter, and damping factor can be calculated using the chart (MFRM-03510) on the following page. Proceed as follows:

1. Using a straight-edge, line up the gauge of the speaker wire with its length. Mark off the resulting source resistance where this line crosses the center column.
2. Line up the source resistance, determined in step #1, with the manufacturer's impedance* of the speaker system. The damping factor can now be read.

05501-1
maintained to insure good audio quality.

The relationship between wire length and diameter, and damping factor can be calculated using the chart (MFRM-03510) on the following page. Proceed as follows:

1. Using a straight-edge, line up the gauge of the speaker wire with its length. Mark off the resulting source resistance where this line crosses the center column.
2. Line up the source resistance, determined in step #1, with the manufacturer's impedance* of the speaker system. The damping factor can now be read.

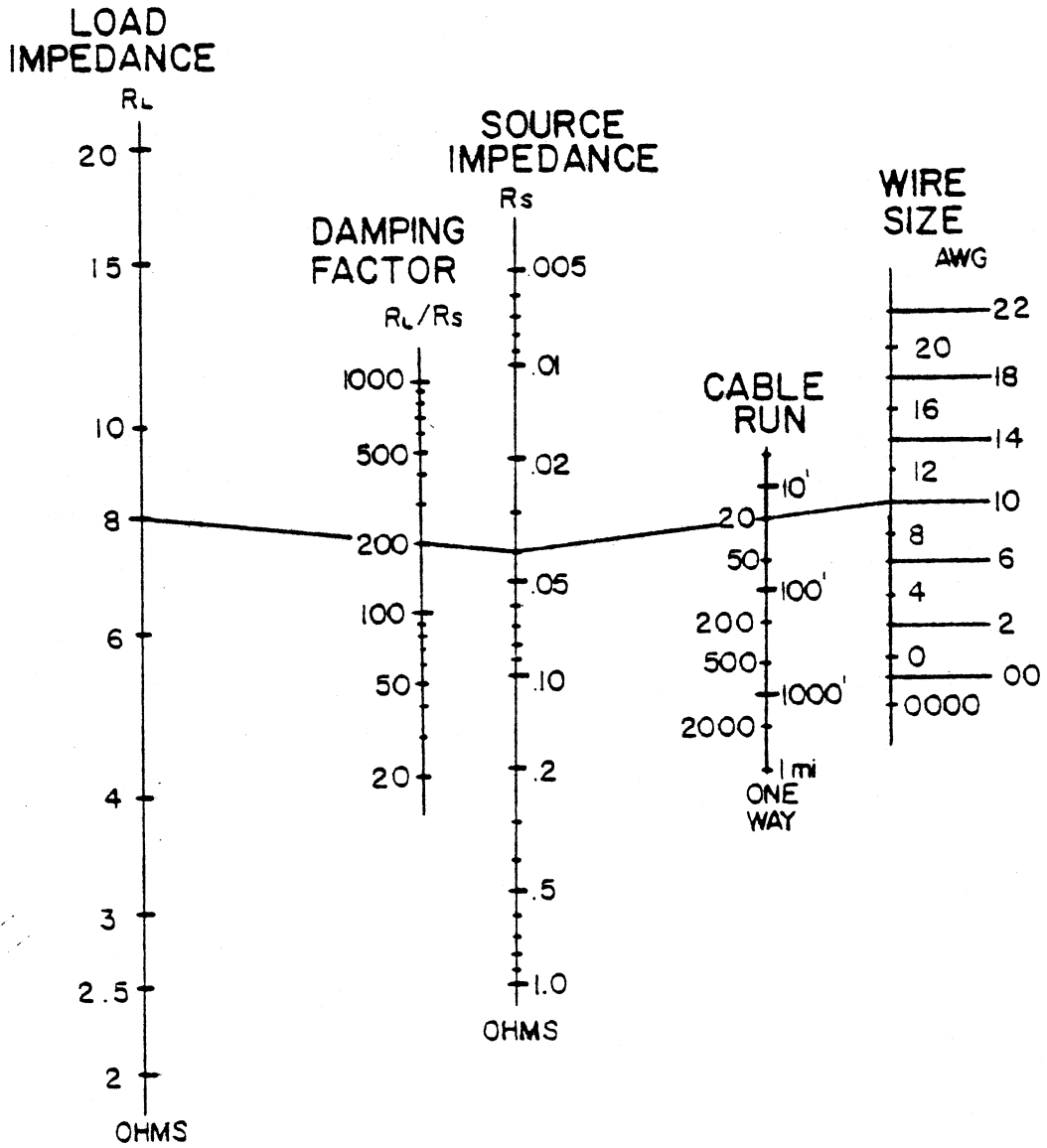

DAMPING FACTOR & WIRE SIZE NOMOGRAPH (see text)

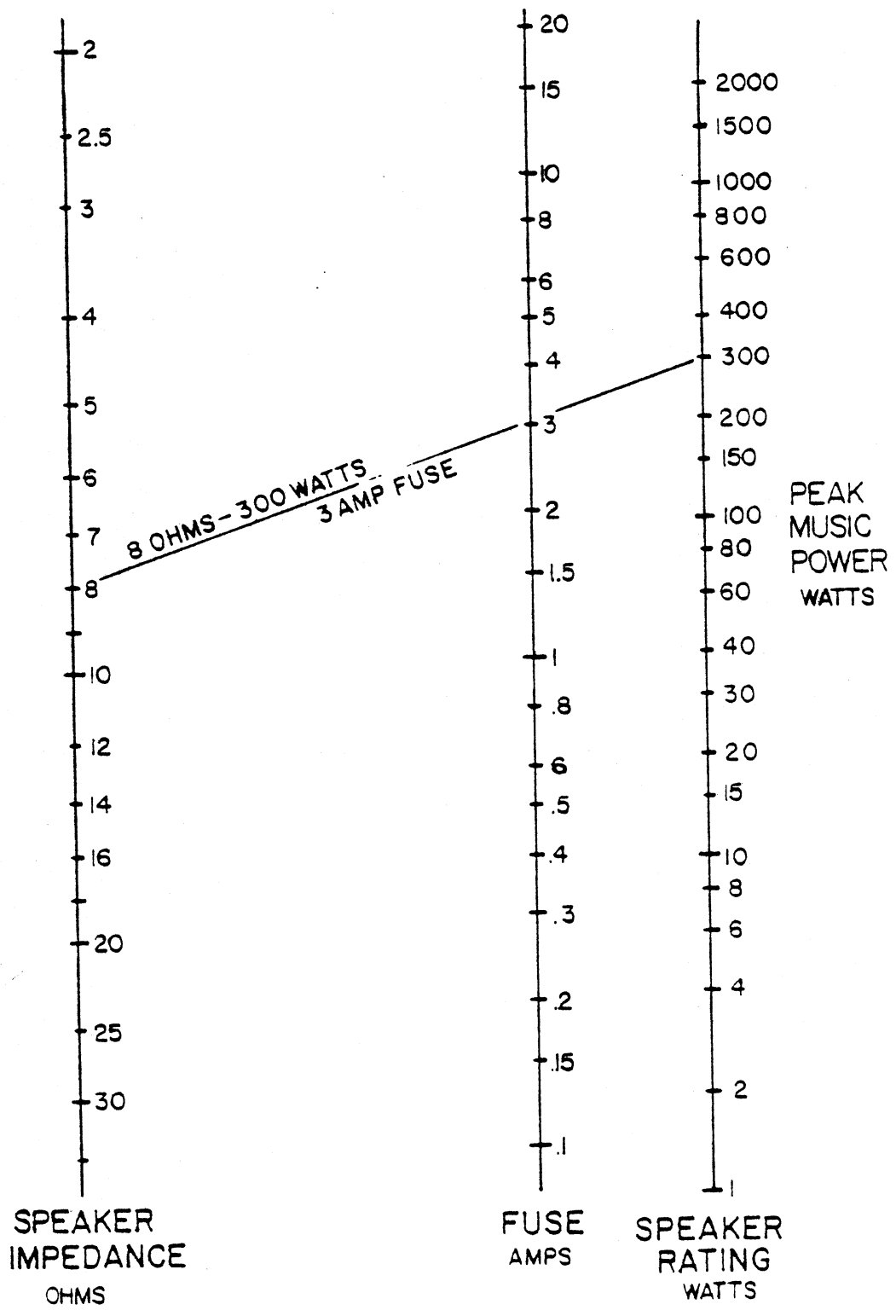

FUSE SELECTOR NOMOGRAPH FOR LOUDSPEAKER PROTECTION

MFRM-03530A

MONO OPERATION

The output power of the amplifier can be increased by operating it in the Mono (bridged) Mode. The correct procedure for Mono operation is as follows:

1. Set Stereo/Mono switch to Mono position.
2. Use left channel input only. DO NOT use the right channel input.
3. Connect the output across the two red binding posts. DO NOT use the black binding posts. DO NOT reference the load (speaker) to ground. Designate the left channel red binding post (+) and the right channel red binding post minus (-). Fuses, when necessary, should be placed in series with one red binding post.

NOTE: Minimum load impedance for Mono operation is 4 ohms.

CIRCUIT DESCRIPTION

In the Mono mode, the output of the left channel is fed into the inverting input of the right channel. The two channels work opposite each other; when one goes positive, the other goes negative, thus doubling the output voltage swing. The single output is referenced between the two red binding posts.

POWER MAINS CONNECTIONS

The unit should be plugged in only when it has been established that it is wired for the correct power mains voltage and after all other connections have been made.

The mains (AC line) voltage is indicated on the label on the rear of the unit. Products supplied for use in the United States and Canada are factory wired for 120 volts. Only the indicated mains voltage should be used. If the mains voltage must be changed, see POWER MAINS VOLTAGE CONVERSION.

A molded, parallel blade, U-ground plug is supplied. This connector is standard in the United States and Canada. For use elsewhere, the plug must be replaced with the correct connector. The color-code of the cord is as follows:

HI (switched Leg) - Brown (or Black)

LO (neutral Leg) - Blue (or White)

EARTH (chassis ground) - Green with Yellow tracer (or Green)

MONO OPERATION

The output power of the amplifier can be increased by operating it in the Mono (bridged) Mode. The correct procedure for Mono operation is as follows:

1. Set Stereo/Mono switch to Mono position.
2. Use left channel input only. DO NOT use the right channel input.
3. Connect the output across the two red binding posts. DO NOT use the black binding posts. DO NOT reference the load (speaker) to ground. Designate the left channel red binding post (+) and the right channel red binding post minus (-). Fuses, when necessary, should be placed in series with one red binding post.

NOTE: Minimum load impedance for Mono operation is 4 ohms.

CIRCUIT DESCRIPTION

In the Mono mode, the output of the left channel is fed into the inverting input of the right channel. The two channels work opposite each other; when one goes positive, the other goes negative, thus doubling the output voltage swing. The single output is referenced between the two red binding posts.

POWER MAINS CONNECTIONS

The unit should be plugged in only when it has been established that it is wired for the correct power mains voltage and after all other connections have been made.

The mains (AC line) voltage is indicated on the label on the rear of the unit. Products supplied for use in the United States and Canada are factory wired for 120 volts. Only the indicated mains voltage should be used. If the mains voltage must be changed, see POWER MAINS VOLTAGE CONVERSION.

A molded, parallel blade, U-ground plug is supplied. This connector is standard in the United States and Canada. For use elsewhere, the plug must be replaced with the correct connector. The color-code of the cord is as follows:

HI (switched Leg) - Brown (or Black)

LO (neutral Leg) - Blue (or White)

EARTH (chassis ground) - Green with Yellow tracer (or Green)

POWER MAINS VOLTAGE CONVERSION

CAUTION: These servicing instructions are for use by qualified personnel only. To avoid electric shock, do not perform any servicing other than that contained in the Operating Instructions, unless you are qualified to do so. Refer all servicing to qualified service personnel.

NOTICE: Voltage conversion should be done by a BGW Authorized service station only.

This unit is shipped from the factory wired for correct operation in the country in which it is to be sold.

CHASSIS AND CIRCUIT GROUNDS

Both chassis and circuit grounds are connected together internally. They can be separated by moving the amplifier ground switch to "floating". The circuit grounds of all active units (amplifiers, preamplifiers, mixers, etc.) can be tied to earth ground at a common point. This aids in eliminating ground loops.

OPERATION

PRECAUTIONS

1. Speaker destruction is often due to improper equipment operation. This often occurs when someone without the proper appreciation for the components of a high power, high quality music system, has the opportunity to change records or adjust levels. The best protection here is caution. Keep the equipment out of reach of untrained adults and children. Make sure the speaker is properly protected with fuses (Output Connections Section).
2. Never parallel the two amplifier outputs together.
3. If the amplifier continuously trips its circuit breaker, something is wrong - do not continue operation.
4. Do not connect an input ground lead to an output ground lead; to do so may cause a ground loop and oscillations.
5. Do not operate the amplifier from power mains which exceed the indicated mains voltage by more than 10%.
6. Never connect the output of the amplifier to another power source such as a battery or power main.
7. Do not expose the amplifier to corrosive chemicals such as lye, soft drinks, salt water, etc. Also, never immerse the amplifier in any liquid.
8. Do not remove the amplifier's cover during operations.
9. The amplifier is not intended for high frequency-high power use and should not be used for high power ultrasonic applications (above 20kHz).
10. Neither the amplifier nor any of its leads should be exposed to areas likely to be struck by lightning.

PROCEDURES

After all connections have been made to the power amplifier, turn the gain controls fully counter-clockwise. Turn on the preamplifier or mixer, then turn on the power amplifier. The green LED on the front panel should light. If they do not, check to see that the amplifier is plugged in to a live power outlet.

750D & 750E CIRCUIT DESCRIPTION

The Models 750D & E are all discrete, full complementary amplifiers.

The input signal is supplied from the wiper of the level control VR501 through the input network to the differential pair, Q101. The input network consists of C103 to minimize RF interference, C101 and 102 to prevent DC inputs, and R102-108 which with D104, D105, and C104, allow the small DC offsets to be corrected. R107 is selected at the factory to bring the DC output voltage to less than .010V.

Q101 is a high speed, low noise, matched differential pair. Q101 drives R113 and R114 through the cascode stage: Q121 and Q122. Cascoding improves the speed and linearity of Q101. C106 and R112 set the dominant open loop pole. R109, 110, 113, and 114 set the gain of this stage.

Q110 is the current source for the differential stage. R145 sets the current at 100 uA per device. Q109 is a cascode stage to improve power supply rejection. When +5VDC is supplied to D109 from the display board, Q111 turns on and charges C111 through R144. After this short delay, Q110 turns on and the amplifier operates normally. When Q110 is off, the amplifier will not pass signal: the output appears as a resistor to ground. Q106 and 107 are emitter followers which "unload" or isolate the differential stage from the pre-driver stage.

Q202 and 203 are the second voltage gain stage. The gain is set by R124, 125, 203, and 204. Q203 drives the inverted signal in this push-pull stage. This drive is reflected in the current mirror: Q117 and 205. The collectors of Q202 and 205 are connected through the bias transistor Q204. Q204 is set up as a Vbe multiplier which allows the bias to be set by selecting the proper value for R207. When the amplifier gets hot, the voltage across Q204 is reduced and thus, the bias current does not increase and thermal runaway is prevented. The bias is set at the factory for Class AB+B operation with 0.400 VDC across R211 and 223.

Q202 and 205 drive the output stage which is in a full-complementary, triple-Darlington configuration. Q201 and 209 are the NPN drivers and Q210-214 are the NPN Ultracase output devices. Q206 and 215 are the PNP drivers and Q216-220 are the PNP Ultracase output devices. R208, 209, C203, and 204 stabilize the output stage against current driven (Miller) oscillations. L201, R234, 235, C205, 206 form the output network that provides stable high frequency loading and allow any reactive load to be driven safely. Feedback is provided by returning the output signal to the differential pair through the feedback network. R139 and 140 set the AC gain at 31.6 (30dB). C112 sets the dominant closed loop pole at 100kHz. C113 and 114 ensure that the DC gain is unity.

Bridging (Mono Operation):

The output of the left channel is sent to the feedback point of the right channel through R138. This causes the right channel to be a unity-gain inverting amplifier. The normal right input is shorted to ground to prevent mixing or cancelling of signals.

Protection Circuits:

There are four different protection circuits in the Models 750D & E.

Q207 and 208 are combined to provide DC speaker protection. If there is a DC fault in the amplifier, C207 will charge through R236. At 10VDC, Q208 will conduct and turn on the triac Q207, thus, shorting the output to ground and protecting the speaker. If this circuit is false triggered, it will reset during any pause in the output signal.

Q115 and 116 are the VI (Short-Circuit) limiters. R217-221 sense the current in all of the NPN output transistors: The average value is seen at the base of Q115. When the current limit is exceeded, Q115 turns on and diverts the drive current from the output drivers. R128 "pre-biases" Q115 so that less than 1 amp per device flows into a short circuit. R130 and D111 "fold back" the bias so that as much as 10 amps per device can flow into speaker loads. C121 delays this circuit to allow transients to pass. Highly inductive 2 ohm loads can be driven without turning on the VI limiters. Q116 is the VI limiter for the PNP side in a similar circuit.

Q112 is an over-current protector for the pre-driver stage. If a DC fault occurs, the extra current will be sensed across R123 and Q112 will turn on, pulling up the collectors of Q106 and 107 and thus, turning off and protecting all the transistors in the pre-driver stages.

D101 and 102 prevent Q101 from latching due to very high input signals.

"True Clip" Circuit:

Whenever the two bases of Q101 are not exactly the same, the amplifier is "out of feedback". When this happens (clipping, short-circuit), either Q104 or 105 will conduct. This current will drive the Darlington Q108 which drives the clip LED directly.

750E METER and STATUS INDICATORS

OVERVIEW:

The 750E differs from the 750D only by the addition of an impressive meter and status indicator display. The display consists of, from left to right, two idle lights, 20 segments per channel of level meter, and the "true-clip" indicators. The amplifier overtemperature indicators, the DC offset indicators, the AC line level monitors, the power supply imbalance indicator, and the transformer overtemperature light. The following paragraphs describe the function of each feature on the display. The right and left channel circuits are identical, refer to the schematic for details.

PART NUMBERING:

All components used for the left channel, or used in common for both channels (power supply, etc.), are numbered in the 300 sequence. All components used for the right channel are in the 400 sequence with the second two digits the same as for the left. Check the schematic for complete part numbering and values.

POWER SUPPLY:

The power supply is derived from the auxiliary 12VAC winding off the power transformer. This is rectified and integrated to supply approximately 16VDC. Three reference voltages are generated by D337-339 providing the thresholds needed for the comparators. Ref. (B) is filtered and used as the signal ground for the metering circuitry: This is called the pseudo-ground.

DELAYED TURN-ON:

When the 750E is turned on (from the power switch or remotely), the amplifiers are held off for about 5 seconds. This allows preceding signal processors to settle before power is applied to the load. The 750E is free of turn-on transients. When power is applied to the unit, Q308 is turned on while C306 charges. This prevents the current source on the amplifier module from turning on (thru D332). During this time the 555 timer (IC307) causes the idle lights to blink. When C306 is fully charged, Q308 is turned off and the current source trigger current is allowed to flow. Q309, which had been held off, turns on and the idle lights stop blinking, indicating that the delay is over and the amp is passing signal. D346 insures that the delay sequence is not skipped due to rapid on-off activity. D347 prevents any power supply modulations from false triggering the delay during normal operations.

THE 60dB METER:

The output of each channel is connected to a precision rectifier (IC303) and integrated (R309, C304). This level is presented to the LM3915 display driver chip. The LM3915 is designed to drive 10 LEDs in 3dB steps. The chip is used in the dot mode to save on power dissipation. This means that 3915 only turns on the LED that represents the 3dB range corresponding to the input level. The other LEDs are connected in series and thus, the lower level LEDs are turned on by the higher ones. Due to voltage constraints, only 5 LEDs can be connected in series. Two transistors (Q301-2, etc.) are used to keep the lower string on when the higher string is lit, IC304 adds 30dB to the lower level driver so that IC301 covers the -57dB to -30dB range and IC302 covers the -27dB to 0dB range.

AMPLIFIER OVERTEMPERATURE INDICATOR:

There is a thermal switch in series with the turn-on trigger for the current source, this switch is mounted on the amplifier heatsink and will open if the heatsink ever exceeds 90 degrees C. If this happens, Q310, which has been forced on by the trigger current, will turn off and allow the LED to light (D330) to show that the amplifier module has turned off due to high temperatures. Since the fan should be running at full speed, it should not be more than a couple of minutes before the amplifier comes back on.

DC OFFSET:

The output of each amplifier is also connected thru an integrator to a pair of transistors. If there is a DC offset of more than $\pm 1.0V$, one of the pair will turn on and the LED will light. NOTE: If there is a DC offset of more than 8 volts, the DC speaker protection circuit will trigger and the output will be shorted to ground.

POWER LINE MONITOR:

The AC line voltage is monitored by measuring the voltage across one of the primaries, rectifying and integrating it, and comparing it with levels corresponding to 125VAC (A) and 105VAC (B). If the high line LED (RED) turns on, check that the voltage of the line matches what the amplifier is wired for, overvoltage can reduce the life of filter capacitors and other components in the amplifier. If the low line LED (YELLOW) turns on, again check for the correct line voltage at the wall. Also, check that the wire guage and length are sufficient for the total power being used. The lo-line LED is only a caution: The 750E can operate at very low line voltages (with a reduction of available power) without failure.

POWER SUPPLY IMBALANCE INDICATOR:

The B+ and B- supplies are compared across the string of R337-8 and D340-1. If there is a difference between the rails, then the sensing node will be outside the window defined by the reference voltage (A) and (C) and the LED will be turned on by the comparator (IC305).

TRANSFORMER OVERTEMPERATURE INDICATOR:

The Model 750E display features a transformer overtemperature indicator. Both metered and un-metered models of the 750 have a circuit breaker built into the power transformer. If the temperature of the transformer exceeds 110 degrees C the breaker opens, illuminates the TX110 LED and shuts off the transformer. The fan will continue to operate and cool the transformer. The circuit breaker will automatically reset when a safe temperature is reached.

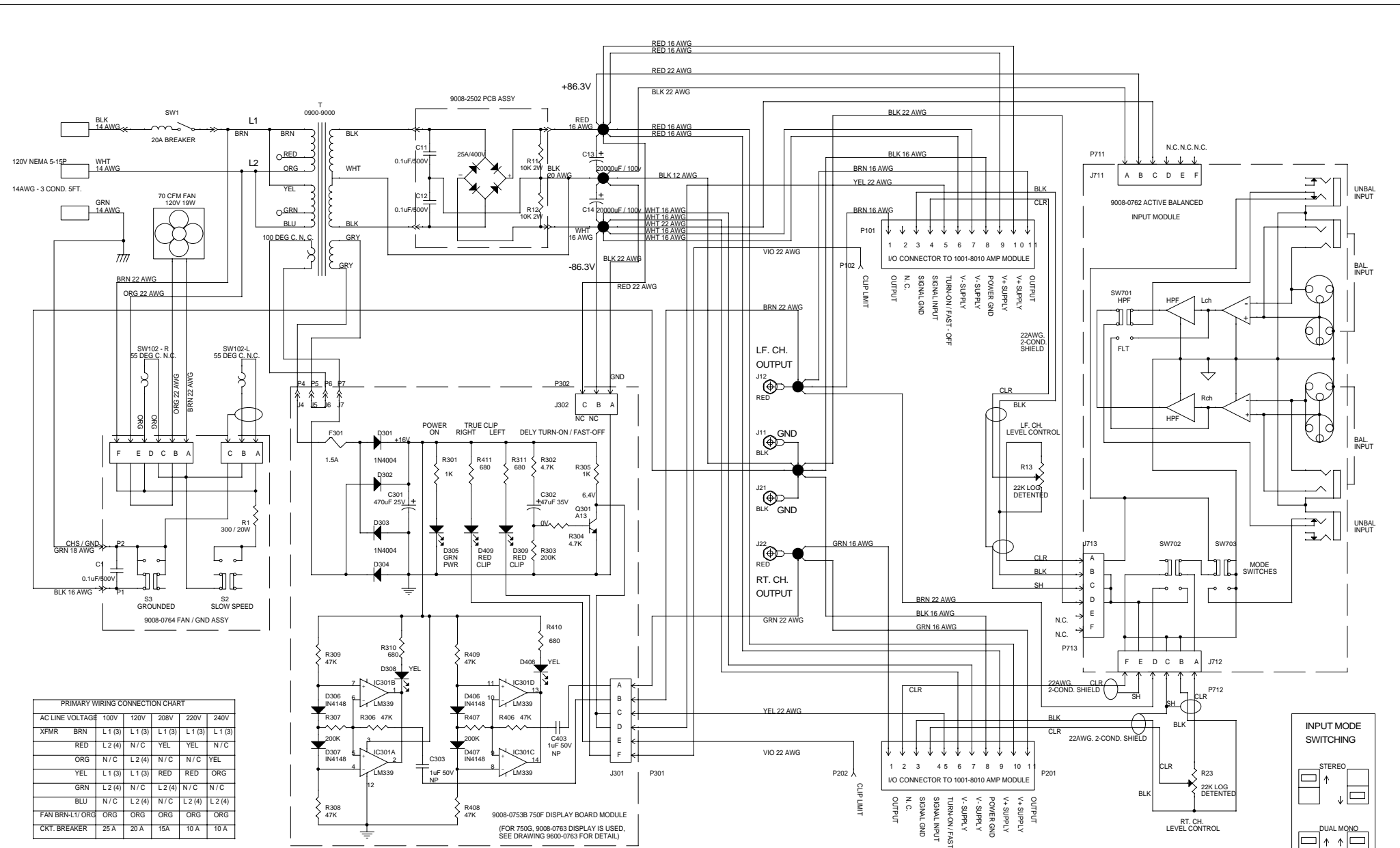

PRIMARY WIRING CONNECTION CHART

AC LINE VOLTAGE	100V	120V	208V	220V	240V
XFMR	BRN L 1 (3)	L 1 (3)	L 1 (3)	L 1 (3)	L 1 (3)
	RED L 2 (4)	N/C	YEL YEL	YEL N/C	N/C
	ORG N/C	L 2 (4)	N/C	N/C	YEL
	YEL L 1 (3)	L 1 (3)	RED RED	ORG	ORG
	GRN L 2 (4)	N/C	L 2 (4)	N/C	N/C
	BLU N/C	L 2 (4)	N/C	L 2 (4)	L 2 (4)
FAN BRN-L1/ORG	ORG	ORG	ORG	ORG	ORG
CKT. BREAKER	25 A	20 A	15A	10 A	10 A

- ON 9008-0753B PCB, ALL RESISTORS 1/4 W 5% CARBON FILM UNLESS NOTED OTHERWISE.
- ALL CAPACITORS IN μ F / WORKING VOLTS.
- SW1, R13, R23 ARE FRONT PANEL CONTROLS. SW701, SW702, SW703 ON REAR PANEL.
- J1 IS REAR PANEL BARRIER STRIP. J11, J12, J21, J22 ARE 5-WAY BINDING POSTS.
- TS1 IS INTERNAL THERMAL SWITCH IN POWER TRANSFORMER T1.
- REFER TO PARTS LIST.
- FOR ACTIVE BALANCED INPUT MODULE DETAILS, REFER TO SCHMATIC 9008-0762.

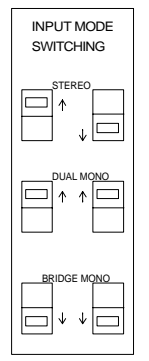

NOTES:

- 1- ALL RESISTORS 1/4 W, 5% UNLESS NOTED
- 2- R207 FACTORY SELECTED FOR 400mV ACROSS R210 OR R223
- 3- R107 FACTORY SELECTED FOR 0.00Vdc ACROSS OUTPUT TERMINALS

- 4- □ DC VOLTS FROM GROUND, NO SIGNAL
- 5- △ AC VOLTS RMS, 1KHZ SIGNAL AT RATED POWER
- 6- □ 100 SERIES PARTS ON DRIVER PCB
- 7- □ 200 SERIES PARTS ON OUTPUT PCB
- 8- □ DRIVER-OUTPUT INTERCONNECT
- 9- ○ 1 PIN SOCKET, CHASSIS HARNESS CONNECTION

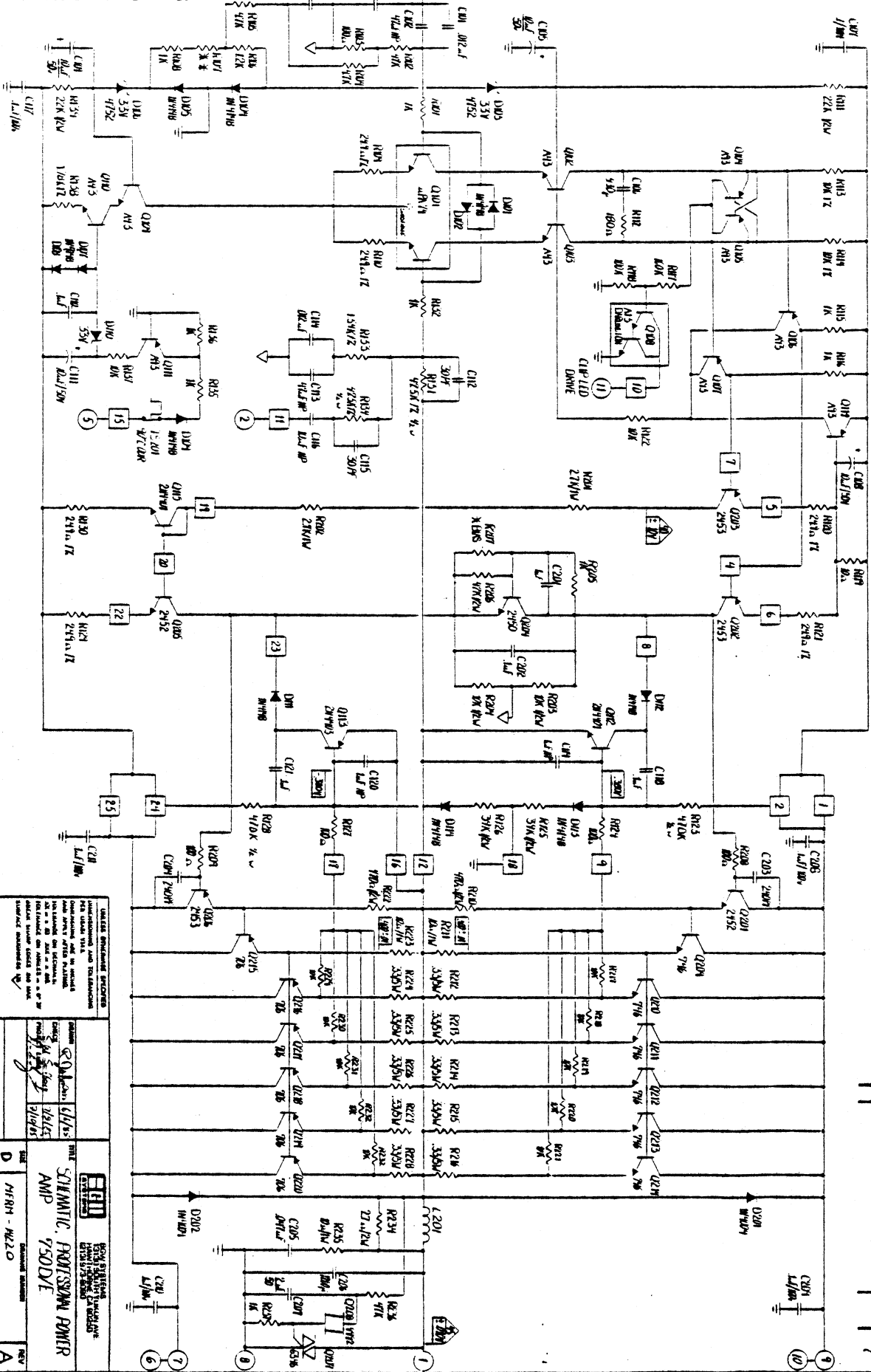

USE THE FOLLOWING PROCEDURE TO IDENTIFY THE PARTS LISTED IN THIS SCHEMATIC. THE PARTS LISTED IN THIS SCHEMATIC ARE THE PARTS LISTED IN THE PARTS LIST. THE PARTS LIST IS THE PARTS LIST FOR THE PARTS LISTED IN THIS SCHEMATIC. THE PARTS LIST IS THE PARTS LIST FOR THE PARTS LISTED IN THIS SCHEMATIC.

<p>7500W 7500W POWER AMPLIFIER 7500W POWER AMPLIFIER 7500W POWER AMPLIFIER</p>	
<p>DATE: 1/1/70</p>	<p>BY: [Signature]</p>
<p>REV: A</p>	<p>APP: [Signature]</p>

<p>DATE: 1/1/70</p>	<p>BY: [Signature]</p>
<p>REV: A</p>	<p>APP: [Signature]</p>

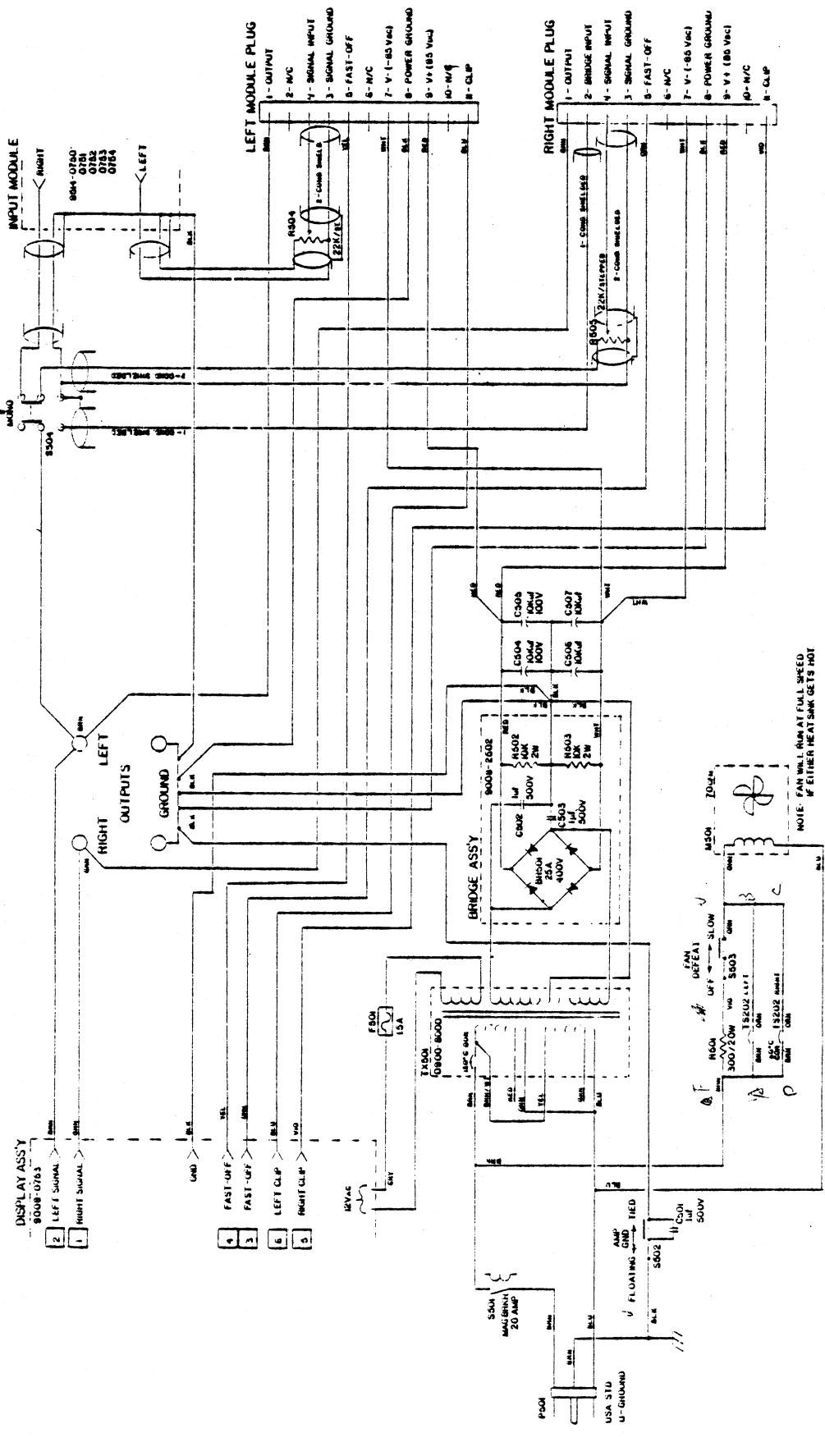

PLEASE CONSULT THE SERVICE MANUAL FOR THE FOLLOWING INFORMATION:

- 1- RESISTANCE IN OHMS
- 2- POWER TRANSFORMER CAN BE REWOUND AT 1:1
- 3- SEE PARTS LIST FOR REPLACEMENT PART NUMBERS
- 4- 0 PIN CONNECTOR

NOTES: UNLESS OTHERWISE SPECIFIED.

DATE	BY	REV
7/8/85	G. L. ASLEY	D
7/7/85		
7/7/84		

CHASSIS WIRING SCHEMATIC	SCALE	SHEET
MODEL 7500	1:1	1 OF 1
PROFESSIONAL SERIES		
DATE	REV	
9/12/80	A	

USA STD U-GROUND

AMP FLD 500V

FAN DEFECT UFF → SLOW

NOTE: FAN WILL RUN AT FULL SPEED IF EITHER HEATSINK GETS HOT

REV	DESCRIPTION	DATE	APPROVED
A	REVISED PART OFF-CIRCUIT, CHANGED R301 TO 100K, ADDED 6 PIN HEADER - DELETED 8 WOLFE PIN	10-22-85	DJY

RIGHT

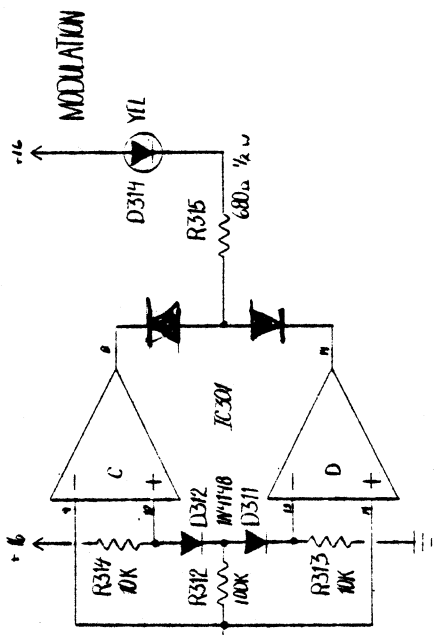
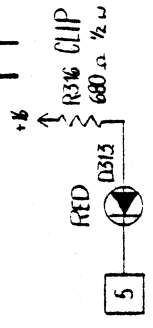

LEFT

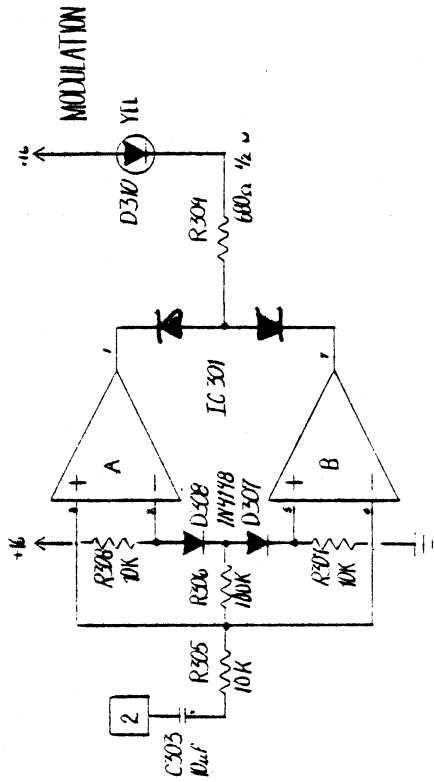
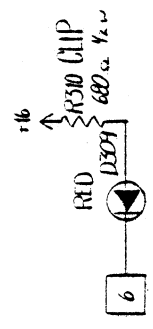

I.C. COMPANOR

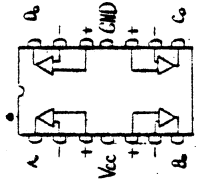

PN 1895-0324

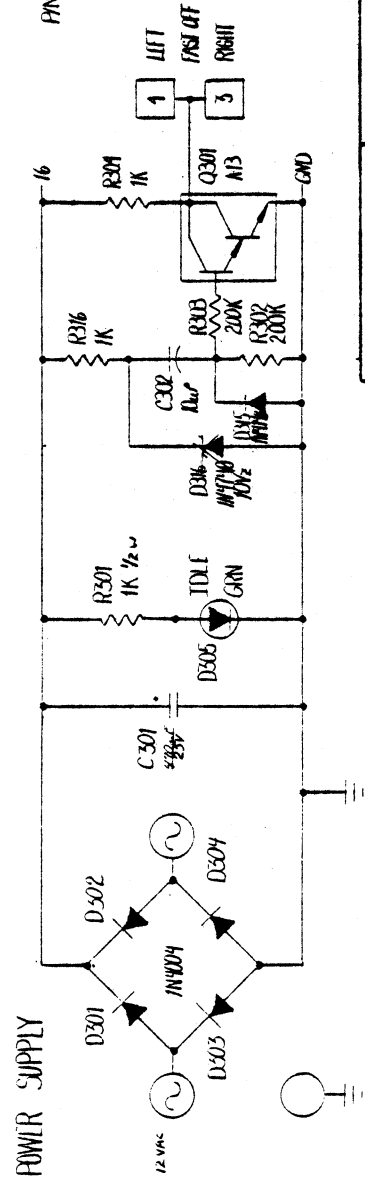

POWER SUPPLY

		R&G SYSTEMS 13130 SOUTH YUKON AVE. VAN NUYS, CALIF. 91411 (818) 775-8850	
DRAWN <i>R. Schron</i>	2/1/85	CHECKED D. J. RELEY	2/1/85
PROJECT ENGINEER <i>[Signature]</i>	2/1/85	TITLE SCHEMATIC 7500 DISPLAY	DRAWING NUMBER MFRM-14240
UNLESS OTHERWISE SPECIFIED DIMENSIONING AND TOLERANCING PER UNAS VIAL DIMENSIONS ARE IN INCHES AND APPLY AFTER PLATING TOLERANCE ON DECIMALS: .XX ± .03 .XXX ± .01 TOLERANCE ON ANGLES ± .8° BREAK SHARP EDGES AND MAX. SURFACE ROUGHNESS 12.5	SIZE C	SCALE	REV A

- 1- 6 PIN HEADER CONNECTION
- 2- 1000µF 25V ELECTROLYTIC CAPACITOR
- 3- ALL RESISTORS 1/4 WATT 5% UNLESS NOTED

NOTES: UNLESS OTHERWISE SPECIFIED. DO NOT SCALE DRAWING.

750D DISPLAY CIRCUIT DESCRIPTION

12VAC from the power transformer is rectified (D310-304) and integrated by C301 to supply approximately 16VAC. C302 and R302 set up the time constant for Q301 which operates the delay turn-on for both amplifier modules. D316 prevents fals triggering.

MODULATION LIGHTS

The left amplifier output is connected to a blocking capacitor C303 thru R305 into a dual state window comparator which will detect signals as low as $\pm .7$ VAC. When either a positive or negative signal that is larger than .7V peak is applied, this will cause either one of the comparators outputs to go to ground, thus turning on D310. Right channel is similar.

TRUE CLIP INDICATORS

Q104 and Q105 located in the differential stage on the amplifier module, set up the true clip sense circuit. If there is a difference in the input stage (out-of-feedback) one of the two will immediately turn-on, driving Q108 into saturation which will turn on the clip LED, D309. The right channel is similar.

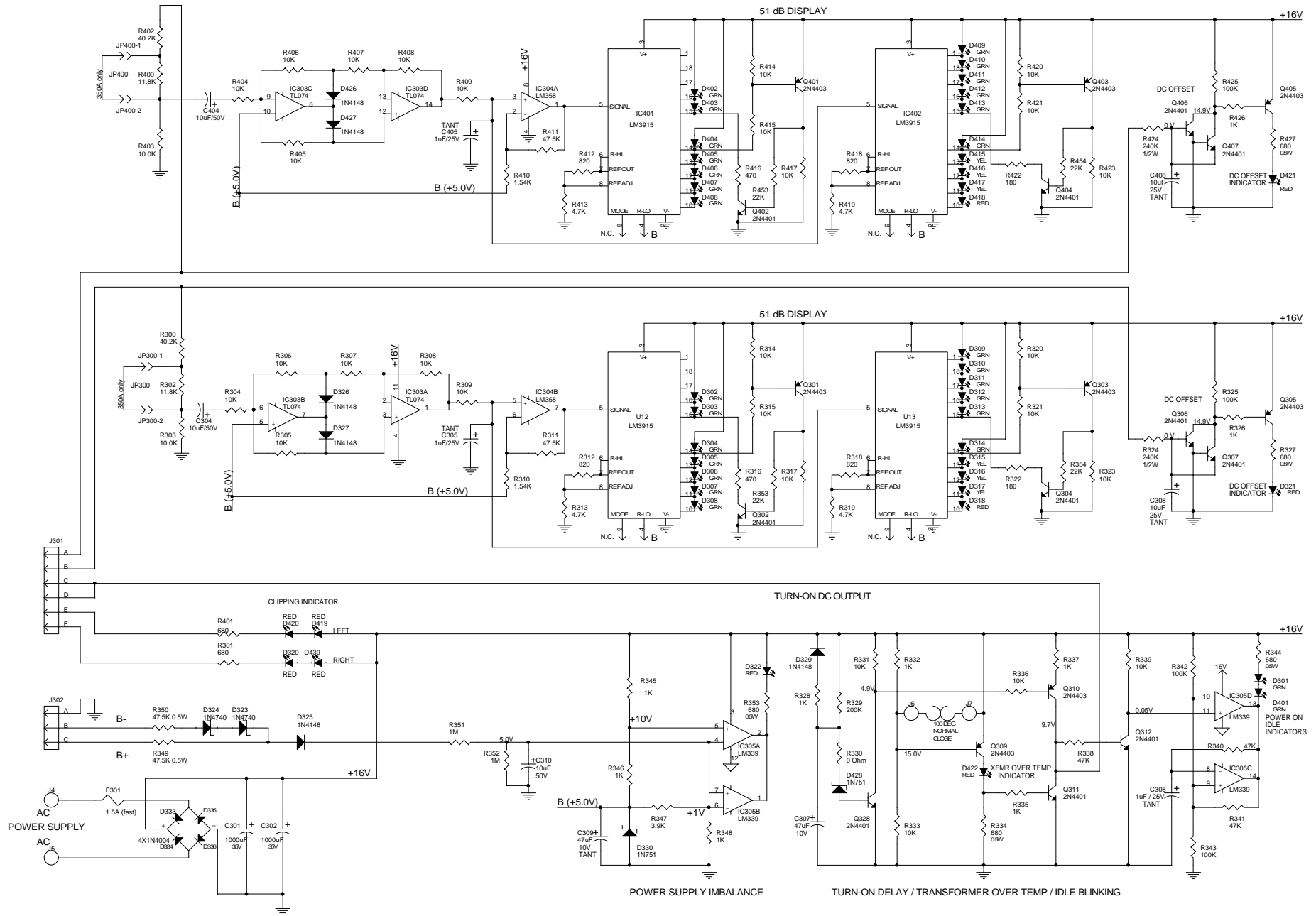

BGW Systems, Inc.
 13130 Yukon Ave.
 Hawthorne, CA 90250

Title		48dB-Display	
Size	Document Number		
C	48dB-Display		
Date:	Monday, September 22, 2003	Sheet	1 of 1
Rev	A		

MODEL 7500 PARTS LIST

100 SERIES PARTS ON DRIVER BOARD.
 200 SERIES PARTS ON HEATSINK ASSY.
 300 SERIES PARTS ON DISPLAY BOARD.
 500 SERIES PARTS ON CHASSIS ASSY.

CHASSIS ASSY..

MANL7500	MANUAL MODEL 7500	
0566-0010	CAP 10KUF 100V COMP GR ELEC	CS04-507
0650-2000	CIRCUIT BREAKER 20 AMP #64 BLK	SS01
0700-1114	KNOS, STANDARD, PUSH ON	
0900-8000	XFMR PWR MOD 8000 TORROID	TX501
1001-0754	HEAT SINK ASSY MODEL 7500/E	
1100-0753	FAN/SWITCH HARNESS 7500 & 850	
1100-0754	WIRE HARNESS MODEL 7500	
1231-0008	CONNECTOR BINDING POST RED	
1231-0009	CONNECTOR BINDING POST BLK	
1235-0754	CAP CLAMP 7500/E	
1235-8000	TORROID TX BRACKET 8000	
9609-0005	SPACER, #6, NYLON, .500 IN.	
8709-0143	14/3 6' PWR CABLE USA STD	PS01
8800-3000	70 CFM FAN 120V	MS01
9000-0754	FRONT PANEL MODEL 7500	
9002-0754	CHASSIS MODEL 7500 & 850	
9005-0754	TOP COVER MODEL 7500 & 850	
9008-2502	BRIDGE ASSY	BR501, ETC

HARNESS ASSY'S:

0620-5206	SWITCH, SLIDE, RECESSED HANDLE	SS02, SS03, SS04
1231-1101	MOLEX CHAIN LUG, 02-08-1101	
1231-3007	CONNECTOR TERM STRIP 7 LUG	
1350-0011	PLUG 11 PIN	
4200-3002	RES 300R 20W 10%	RS01
7006-0015	22X 22POS STEPPED ATTENUATOR	RS04, SS05
9007-0005	STEP ATTEN P.C.B.	
9514-0750	INPUT ASSY STER. ACTIVE INPUT	OPTION 02
9514-0751	STER. DISCRETE ACTIVE INPUT	OPTION 04
9514-0752	STER. 1308 CROSSOVER INPUT	OPTION 15
9514-0753	STER. 2408 L/R CROSSOVER INPUT	OPTION 18
9514-0754	INPUT ASSY STER. XLR UNBALANCED	STANDARD

HEATSINK MODULE: 1001-0754

0060-1200	CAP 1200PF 100V MICA	C206
0090-0240	CAP 240PF 500V MICA	C203,204
0129-0100	CAP .1UF 25V DISC	C201,202
0369-0047	CAP .047UF 100V MYLAR	C205
0369-0100	CAP .1UF 100V MYLAR	C208-213
0564-0000	2UF,50V, NONPOLAR ELECTRO CAP	C207
0630-0001	SWITCH, THERMAL, 90'C, DOR	TS201
0630-3441	SW THERM COR 131F 2450-344-001	TS202
1850-0001	PRE-GREASED INS. 4-ULTRACASE	
1850-0002	PRE-GREASED INS. 7- TO-126	
1853-0706	2SB706A TRANSISTOR PNP	Q215-220
1853-2453	TO-126 200V TRANSISTOR PNP	Q202,203,206
1854-0746	2SO746A TRANSISTOR NPN	Q209-214
1854-2450	SJE 2450 NPN 40V TO-126	Q204
1854-2452	TO-126 200V TRANSISTOR NPN	Q201,205
1884-4992	MBS4992, SWITCH, BIDIREC, SILICON	Q208
1884-6346	2N6346A THYRISTOR, TRICIDE BIDIR	Q208
1900-4004	1N4004 DIODE 1A 400V	Q201,202
4025-1001	WIRE WOUND RES 10R 2W 5% BWH	R211,223,235
4025-2070	WIRE WOUND RES 2.7K 2W 5% BWH	R234
4050-0330	RES .33R 5W 10% ROCKWOOD	R212-216
		R224-228
5005-1004	RES 10 KR 1/2W 5%	R203,204
5005-4701	RES 470R 1/2W 5%	R210,222
5005-4703	RES 47 KR 1/2W 5%	R206,236
5065-1002	RES, 100R, 1/4W, 5%	R208,209
5065-1003	RES 1KR 1/4W 5%	R205,237
5065-1004	RES 10KR 1/4W 5%	R217-221
		R229-232
6010-2702	RES 2.7KR 1W 10%	R201,202
9007-0754	PCB HEAT SINK 7500/850	
9008-0752	PCB ASSY INPUT/DRIVER 7500	

DRIVER BOARD: 9008-0752

0060-0030	CAP 30 PF 100V MICA	C112,115
0060-0430	CAP 430PF 100V MICA	C106
0090-0240	CAP 240PF 500V MICA	C103
0129-0100	CAP .1UF 25V DISC	C110,119,122
0369-0012	.012UF 5% 100V METAL MYLAR	C101,114
0369-0100	CAP .1UF 100V MYLAR	C107,123
0421-0047	47UF 50V NP RADIAL	C102,113

0476-0011	10UF 50V RAD ELEC	C105,108,109 C111
0564-0001	1 UF 50V NONPOLAR RAD ELECTRO	C104,120,121 Q112
1853-0093	MPSA93/92 TRANSISTOR PNP	Q104-107,111
1853-4403	2N4403 TRANSISTOR PNP	Q116
1854-0013	MPS A-13 TRANSISTOR NPN	Q108
1854-0043	MPSA43/42 TRANSISTOR NPN	Q109,110,121 Q122
1854-0074	DUAL NPN LOW NOISE UPA74	Q101
1854-4401	2N4401 TRANSISTOR NPN	Q115,117
1900-4148	1N4148/1N914 DIODE	D101,102,104 D105,107,108 D110-113 D103,106,114
1900-4752	1N4752 33V ZENER DIODE	
5001-4752	RES 47.5KR RN600 1X	R138,139
5005-2203	RES 22 KR 1/2W 5X	R111,146
5005-4704	RES 470 KR 1/2W 5X	R128,132
5005-3903	RES 39 KR 1/2W 5X	R130,131
5011-1002	RES 10K RN55 1X	R113,114
5011-1541	RES 1.54K RN55 1X	R140
5011-1781	RES 1.78K RN55 1X	R145
5011-2429	RES 24.9R RN55 1X	R109,110,124 R125,134,135 R123
5065-1001	RES 10R 1/4W 5X	
5065-1002	RES .100R 1/4W 5X	R103,129,133
5065-1003	RES 1KR 1/4W 5X	R101,107,115 R116,141-143
5065-1004	RES 10KR 1/4W 5X	R127,128
5065-1005	RES 100KR 1/4W 5X	R119,120
5065-1301	RES 130R 5X	R112
5065-4702	RES 4.7KR 1/4W 5X	R104,105
5065-4703	RES 47KR 1/4W 5X	R102
9007-0752	PCB DRIVER 7500/350/250F/350	