



13130 SOUTH YUKON AVENUE
PHONE (213) 973-8090

HAWTHORNE, CALIFORNIA 90250
TELEX NO. 66-4494

MODEL 8000 TOROID
Proline II
OWNER'S MANUAL

<u>DESCRIPTION</u>	<u>FORM NUMBER</u>
Important	00601
Description	00843
Product Option	00845
Specifications	02303
Unpacking & Set-Up	02530
Rack Mounting Hints	02660
Input Connections	02711
Output Connections	03431
Damping Factor Nomograph	03510
Speaker Fuse Nomograph	03530
Mono Operation	03691
Power Mains Connection	04000
Power Mains Voltage Conversion	04132
Operation	05202
Circuit Description	06283
Service Instructions	13600

Schematic Amplifier Module.	13620
Chassis Schematic.	13611
Transformer Schematics Toroids	13615
Block Diagram	13630
Display Schematic	13640
Heatsink Assembly Component Layout	13650
Parts List	13690
Warranty	17000
Service Authorization Form	17020
Warranty Registration Form	17030

- IMPORTANT -

**PLEASE READ THIS PAGE BEFORE OPERATING
YOUR
BGW POWER AMPLIFIER**

Your new BGW amplifier is designed to provide years of trouble free performance. Observing these few precautions will insure proper operation:

Read all Instructions before connecting any AC power to your power amplifier.

Retain this Manual for future reference.

Heed all warnings on the top or rear of the power amplifier.

The amplifier should not be used near water - for example, near a bathtub, washbowl, kitchen sink, laundry tub, in a wet basement, or near a swimming pool, etc.

The amplifier should be situated so that its location or position does not interfere with its proper ventilation. For example, it should not be situated on a bed, sofa, rug, or similar surface that may block the ventilation openings; or, placed in a built-in installation, such as a bookcase or cabinet that may impede the flow of air through the ventilation openings.

The amplifier should be situated away from heat sources such as radiators, heat registers, stoves, or other appliances that produce heat.

The amplifier should be connected to a power supply only of the type described in the operating instructions or as marked on the rear panel.

Precautions should be taken so that the grounding means of the amplifier is not defeated.

The power supply cord should be routed so that it is not likely to be walked on or pinched by items placed upon or against it, paying particular attention to cord at the plug, convenience receptacles, and the point where they exit from the amplifier.

Care should be taken so that objects do not fall into, and liquids are not spilled into the amplifier through openings.

The amplifier should be serviced by qualified service personnel when:

The power supply cord or the plug has been damaged; or objects have fallen into, or liquid has been spilled into the amplifier; or has been exposed to rain; or does not appear to operate normally or exhibits a marked change in performance; or has been dropped, or the enclosure has been damaged.

All connections should be made to the power amplifier with the power OFF.

Speaker fuses should be used to afford maximum speaker protection.

Never connect the output of one channel to that of another.

Connect the power cord to the proper voltage mains as indicated on the rear of the amplifier. Conversion to another voltage requires internal rewiring.

Do not remove the amplifier's cover. Amplifiers may not be covered under warranty if they are tampered with. There are NO adjustments within. Potentially lethal voltages exist within the amplifier. Refer all service work to an authorized BGW service station.

DESCRIPTION

The BGW Model 8000 is one of the most advanced solid state, quasi-complementary, bridgeable, stereo power amplifiers available.

Features of the Model 8000 include Toroid Power Transformer, Forced Air Cooling, Power Switch, Circuit Breaker, Input Level Controls, Modular Construction, Display Meter Assembly, Dual Looping $\frac{1}{4}$ phone jacks, and electronic DC speaker protection.

The Front Panel includes two Input Level Controls, Rocker AC Power Switch and Dual Tri Color LED Display. Green LED's indicate power ON, yellow LED's indicate signal presence and are labeled modulation, and red LED's serve as overload indicators.

The Rear Panel includes AC Input Cord, Circuit Breaker, two sets of looping $\frac{1}{4}$ " Phone Jack Input Connectors, Red and Black 5-way Binding Posts for the output of each amplifier, and a Mono/Stereo Switch to convert amplifier to a fully bridged Mono amplifier.

Provisions are also available for an input accessory module. This circuit board provides balanced electronic inputs, subsonic filter and electronic crossover. The input module can be added at any time by a qualified electronic technician.

Both the circuit and chassis grounds are connected together internally. Refer to MFRM 04132 for information regarding ground separation.

The Model 8000 can be used for a wide variety of applications. However, please note the following precaution.

- 1) Do not use the front panel as the sole support for the amplifier. Side rails or rack shelves should be employed.

The output stages of your Model 8000 use 24 Ultracase[™] devices, the most advanced type of transistors available. These large geometry, 200 watt power devices (total 4800 watts) have large safe operating areas and extended power bandwidth. Electrostatic and other highly reactive speaker systems present no difficulties for the Model 8000.

The Proline II audio power amplifier model 8000 is available from the factory with custom options to fit your needs.

Some of these options may require a minimum quantity of products to be purchased at one time. Please contact the factory with your requirements.

Some of the options for the 8000 are listed below:

8000-01	Active Electronic Balanced Line Inputs
8000-02	Electronic Crossover
8000-03	Transformer Balanced Line Inputs With Looping XLR's
8000-04	Unbalanced Line Inputs With Looping XLR's

THE BGW 8000 TOROID
PROFESSIONAL POWER AMPLIFIER

Exacting design standards and unique features establish the BGW amplifier as the industry leader in power amplifier technology. Features such as all steel welded chassis and covers, exclusive Ultracase™ output transistors, totally modular construction, massive aluminum heatsinks, state of the art toroidal power transformer and low feedback discrete circuit design have set the industry standard in audio power amplifiers.

Delivering a full 225 watts per channel into 8 ohm loads and capable of driving loads as low as 2 ohms. The Model 8000 offers reliability and performance unparalleled in the industry.

SPECIFICATIONS: BGW MODEL 8000 TOROID

OUTPUT POWER

225 watts minimum sine wave continuous average power output per channel with both channels driving 8-ohm loads over a power band from 20Hz to 20kHz. The maximum Total Harmonic Distortion at any power level from 250-milliwatts to 200 watts shall be no more than .05% from 20Hz to 10kHz and rising to no more than .10% at 20kHz.

350 watts minimum sine wave continuous average power output per channel with both channels driving 4-ohm loads over a power band from 40Hz to 20kHz. The maximum Total Harmonic Distortion at any power level from 250-milliwatts to 350 watts shall be no more than .15% from 40Hz to 20kHz.

700 watts minimum sine wave continuous average power output monaural driving an 8-ohm load over a power band from 40Hz to 20kHz. The maximum Total Harmonic Distortion at any power level from 250-milliwatts to 700 watts shall be no more than .15% from 40 to 20kHz.

*All specifications and features are subject to change without notice.

SPECIFICATIONS

Intermodulation Distortion:	Less than 0.05% from 250 milliwatts to rated output power.
Small Signal Frequency Response:	+0, -3dB, 1Hz to 100kHz, +0, -0.25dB, 20Hz, to 20kHz.
Hum and Noise Level:	Better than 110dB below 225 watts into 8 ohms. (A weighted).
Input Sensitivity:	1.23 volts for rated power output.
Voltage Gain:	34.5 times.
Input Impedance:	15k ohms.
Damping Factor:	Greater than 200 to 1 at 8 ohms.
Output Impedance:	Designed for any load impedance equal to or greater than 2 ohms.
Power Requirements:	120 volts A.C., 60Hz at 14 amps Also available for 100, 220 or 240 volts A.C., 50Hz.
Semiconductor Complement:	2 Ultra-low noise matched differential pairs, 64 transistors, 32 diodes, 6 LED's, 2 Triacs, and 5 Zener diodes.
Dimensions:	5 1/4" by 19" standard rack front panel. Depth behind front panel: 5 1/2" x 17 x 13. (13.35 cm x 48.26 cm x 33.02 cm)
Weight:	49 1/2 Lbs., 22.50 kg shipping 43 1/2 Lbs., 19.77 kg net

UNPACKING AND SET-UP

Your BGW Power Amplifier is shipped in an advanced packing container.

SAVE THE CONTAINER AND ALL PACKING MATERIAL!

The container should be saved in the event the unit is moved or shipped at some future date. Replacement containers are available from BGW Systems.

Inspect the unit for damage in transit immediately upon receipt. If damage is found, notify the transportation company immediately. Only the consignee may institute a claim with the carrier for shipping damage. BGW will cooperate fully in such an event. Be sure to save the container as evidence of damage for the shipper to inspect.

The amplifier's mounting position must be chosen carefully, so that the air flow to the front and rear of the unit is not restricted. Inadequate ventilation may cause failure of the amplifier. For rack mounting, the four rubber feet on the bottom of the unit may be removed and no hardware will be loosened inside the unit.

Do not, however, use the front panel as the sole support for the amplifier. Side rails or rack shelves should be employed.

DO NOT PLUG THE AMPLIFIER IN YET!

All connections should be made before power is applied.

RACK MOUNTING HINTS

KEEPING IT COOL

A power amplifier draws energy from a primary electrical service, usually a 120volts AC outlet, to drive loudspeaker systems with an audio signal. Typically, only half of the energy can be delivered to the loudspeakers; remaining energy is converted into heat, and must be dissipated (ventilated) into the air.

Air circulating past heat-producing components absorbs the heat and carries it away. To accomplish this, low and medium power amplifiers rely on natural convection currents, while most high power amplifiers use fans. If the air flow is impeded, the resulting rise in heat may cause an amplifier to stop working or fail.

Circulating air currents must not be cut off when installing power amplifiers in racks. Power amplifiers using convection cooling require spacing between amplifiers to permit air flow between them. Power amplifiers using forced-air cooling, on the other hand, can usually be stacked closer to each other and may not need any blank panel spacing between amplifiers.

To improve natural convection currents within a rack, a chimney can be created by closing the back of the rack and venting the rack at the bottom to let in fresh air, and at the top to exhaust hot air. Vents should be large rectangular slots approximately 19" wide by 4" high.

The rack cabinet will require some type of blower if a large air-flow is required. It is best to exhaust air from the top of the rack rather than to blow it in from the bottom. There will be less dust and dirt in the rack this way, if the bottom vent is sufficiently large.

INSTALLING THE UNITS

Use care when mounting equipment in a rack. Place the heaviest units near the bottom of the rack and fill in all unused rack spaces with blank panels. Equipment cannot always be supported by front panels alone. This is especially true of amplifiers whose depth is more than twice their height. Uniform support can be insured by installing bottom or side rails.

When racks are to be transported or used in mobile installations, some means of securing the rear of the equipment is required. Angle brackets attached either to the bottom, sides or rear panel are practical approaches.

STEREO INPUT CONNECTIONS

Dual looping $\frac{1}{4}$ " in. phone jacks are provided on the rear of the amplifier for input connections.

1/4 INCH PHONE JACKS

The $\frac{1}{4}$ " phone jacks are for unbalanced lines only (single conductor, shielded). Simply connect the shield to the outer sleeve of the plug and the inner conductor to the tip, or buy ready-made cables. See diagram below.

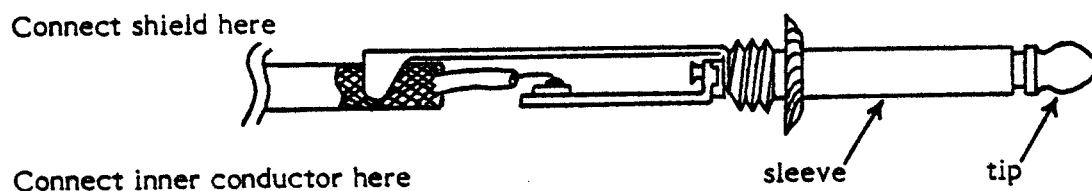

FOR MONO (BRIDGED) OPERATION

To operate the unit as a Mono amplifier, use the Channel "A" input only. DO NOT use the Channel "B" input. Remember to place the Stereo/Mono switch in the Mono position. Refer to Page 03691 for Mono Operation.

STEREO OUTPUT CONNECTIONS Model 8000

Two sets of five-way binding posts, on the rear panel, serve as output connectors, with one black and one red binding post for each channel. Channel "A" leads go to the binding posts marked Channel "A"; Channel "B", to those marked Channel "B".

Output leads are best connected, to the amplifier, with standard banana plugs; however, the five-way action of the binding posts permits the use of tinned wires or spade lugs.

Make certain that the speakers are properly phased. Connect the black or minus (-) terminal on the speaker cabinet to the appropriate black binding post on the amplifier. Connect the red or plus (+) terminal to the red binding post. Check to see that the Stereo-Mono switch on the rear of the amplifier is in the Stereo position.

SPEAKER PROTECTION

The Model 8000 has DC load (speaker) protection built into the heat sink module, however, all speakers can be damaged by having too much power applied to them. Fuse protection is an effective and inexpensive way of preventing this from occurring. If your speaker system does not contain a fuse or a circuit breaker, a fuse should be placed in series with each speaker and the wire going to the red terminal on the rear of the amplifier.

Maximum protection can be obtained with fast-acting fuses. Use the value recommended by the manufacturer. If no value is specified, use the chart provided to select the correct value. See page 03530.

To use the chart, take a straightedge, such as a ruler, and line up the speaker's impedance with its peak music power rating. The proper fuse value can then be read from the center column. Choose a fuse that is closest to, and below, the value indicated.

WIRE SIZE AND DAMPING FACTOR

The high damping factor of BGW amplifiers results in very clean bass response. Excessively long, or small diameter speaker wires can lower the damping factor and distort low frequencies. A damping factor of at least 50 should be maintained to insure good audio quality.

The relationship between wire length and diameter, and damping factor can be calculated using the chart (MFRM-03510) on the following page. Proceed as follows:

1. Using a straight-edge, line up the gauge of the speaker wire with its length. Mark off the resulting source resistance where this line crosses the center column.
2. Line up the source resistance, determined in step #1, with the manufacturer's impedance of the speaker system. The damping factor can now be read.

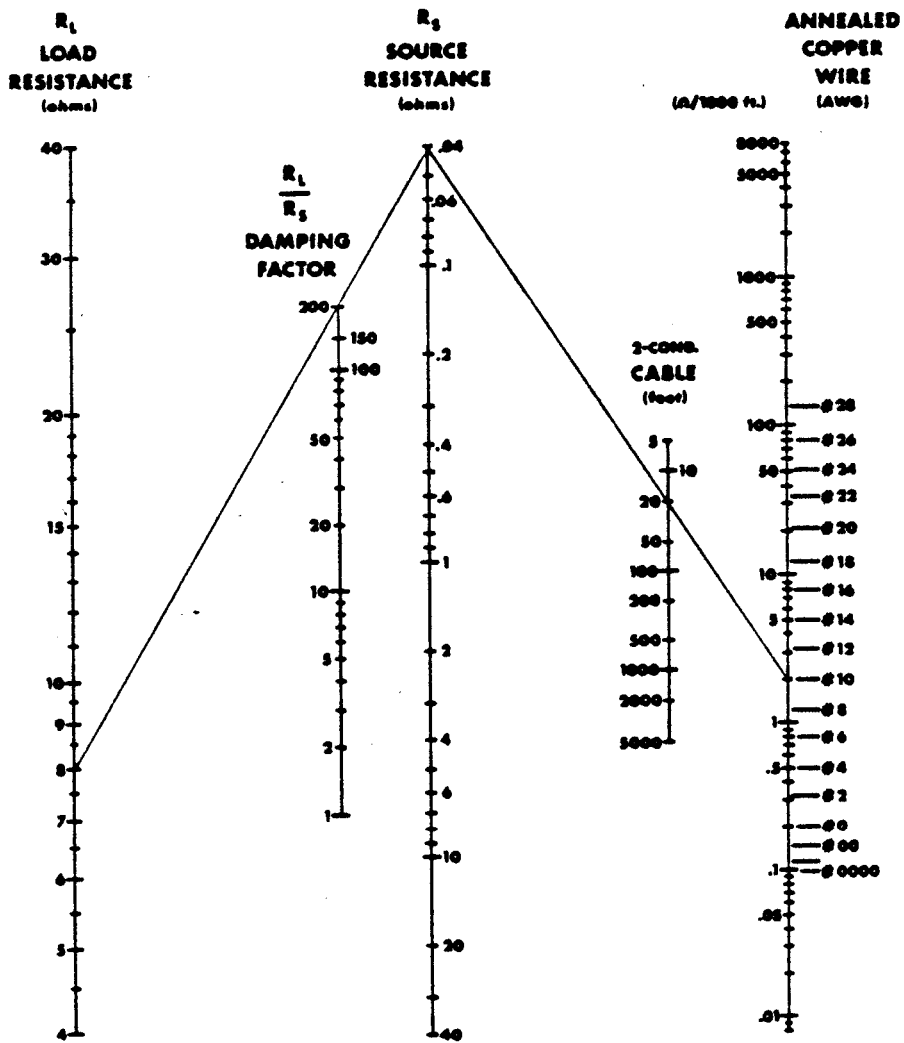

EXAMPLE: $R_L = 8\Omega$, $R_S = .04\Omega$ OR D.F. = 200
 CABLE LENGTH OF 20 FT. ANSWER: #10 WIRE

SOURCE RESISTANCE AND DAMPING FACTOR VS. LENGTH AND SIZE OF OUTPUT LEADS

MFRM-03510

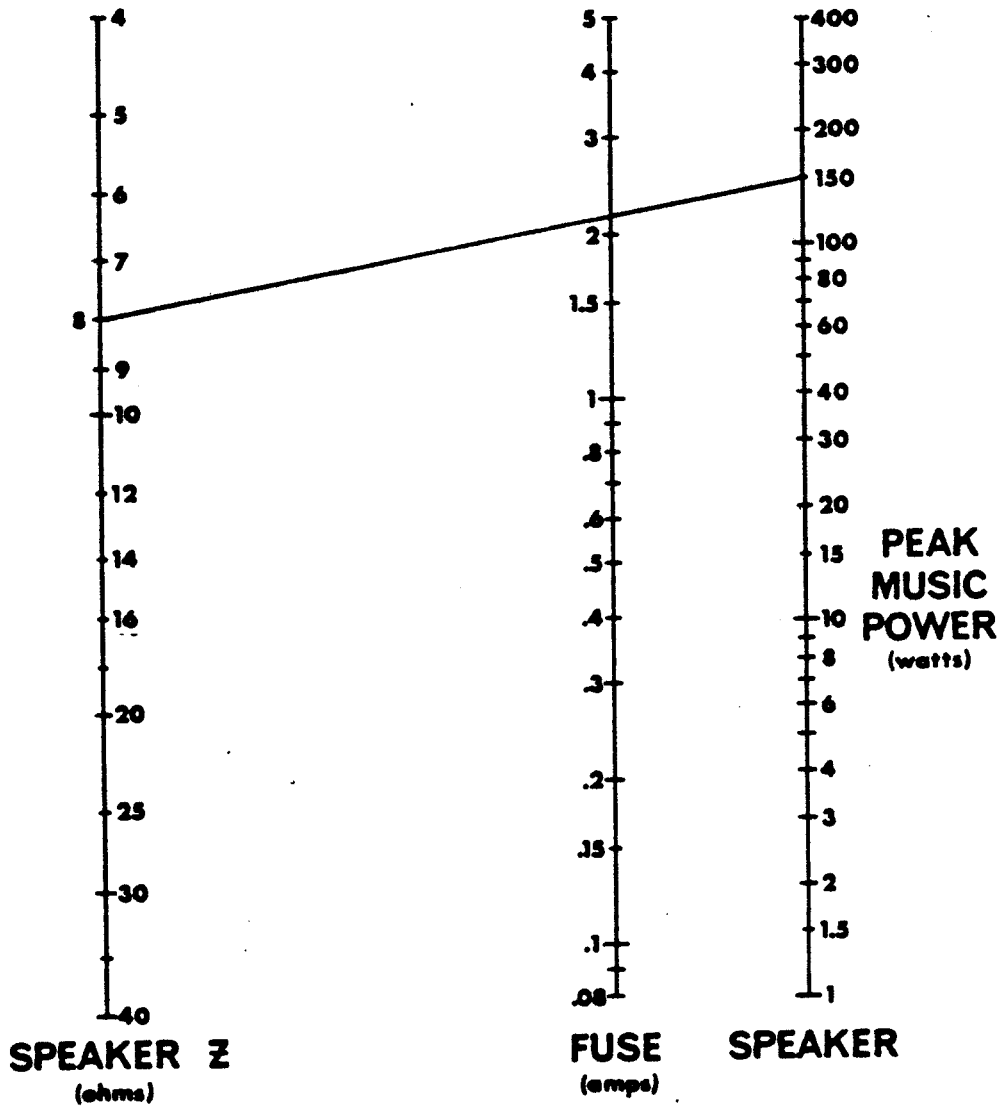

EXAMPLE: $Z = 8\Omega$, PEAK POWER = 150W. ANSWER: FUSE = 2 AMPS

FUSE SELECTOR NOMOGRAPH FOR LOUDSPEAKER PROTECTION

MFRM - 03530

MONO OPERATION

The output power of the amplifier can be increased by operating it in the Mono (bridged) mode. The correct procedure for Mono operation is as follows:

1. Set Stereo/Mono switch to Mono position.
2. Use channel "A" input only. DO NOT use the channel "B" input.
3. Connect the output across the two Plus (+) Terminals. DO NOT use the Minus (-) Terminals. DO NOT reference the load (speaker) to ground. Designate channel "A" as Plus (+) and channel "B" as minus (-). Fuses, when necessary, should be placed in series with one of the Plus (+) Terminals.

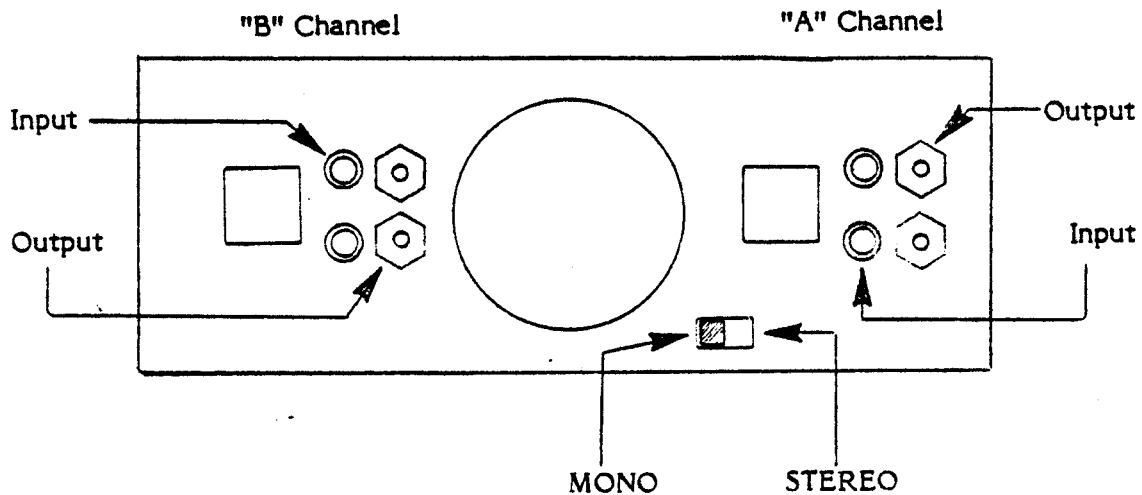

NOTE: Minimum load impedance for Mono operation should be 8 ohms.

CIRCUIT DESCRIPTION

In the Mono mode, the output of channel "A" is fed into the inverting input of channel "B". The two channels work opposite each other; when one goes positive, the other goes negative, thus doubling the output voltage swing. The single output is referenced between the two red binding posts.

POWER MAINS CONNECTIONS

The unit should be plugged in only when it has been established that it is wired for the correct power mains voltage and after all other connections have been made.

The mains (AC line) voltage is indicated on the serial number label on the rear of the unit. Products supplied for use in the United States and Canada are factory wired for 120 volts. Only the indicated mains voltage should be used. If the mains voltage must be changed, see POWER MAINS VOLTAGE CONVERSION.

A molded, parallel blade, U-ground plug is supplied. This connector is standard in the United States and Canada. For use elsewhere, the plug must be replaced with the correct connector. The color-code of the cord is as follows:

HI (switched Leg) - Brown (or Black)

LO (neutral Leg) - Blue (or White)

EARTH (Chassis ground) - Green with Yellow tracer (or Green)

POWER MAINS VOLTAGE CONVERSION

CAUTION: These servicing instructions are for use by qualified personnel only. To avoid electric shock, do not perform any servicing other than that contained in the Operating Instructions, unless you are qualified to do so. Refer all servicing to qualified service personnel.

NOTICE: Voltage conversion should be done by a BGW Authorized service station only.

The Model 8000 is shipped from the factory wired for correct operation in the country in which it is to be sold. The schematic diagram, MFRM 13610 and 13611 indicates the connections for other voltages.

CHASSIS AND CIRCUIT GROUNDS

Both chassis and circuit grounds are connected together internally. They can be separated by removing the Black wire connected to grounding lug under the "B" module near the AC power cord. The circuit grounds of all active units (amplifiers, preamplifiers, mixers, etc.) can be tied to earth ground at a common point. This aids in eliminating ground loops.

OPERATION

PRECAUTIONS

1. Speaker destruction is often due to improper equipment operation. This often occurs when someone without the proper appreciation for the components of a high power, high quality music system, has the opportunity to change records or adjust levels. The best protection here is caution. Keep the equipment out of reach of untrained adults and children. Make sure the speaker is properly protected with fuses (Output Connections Section).
2. Never parallel the two amplifier outputs together.
3. If the amplifier continuously trips its circuit breaker, something is wrong - do not continue operation.
4. Do not connect an input ground lead to an output ground lead; to do so may cause a ground loop and oscillations.
5. Do not operate the amplifier from power mains which exceed the indicated mains voltage by more than 10%.
6. Never connect the output of the amplifier to another power source such as a battery or power main.
7. Do not expose the amplifier to corrosive chemicals such as lye, soft drinks, salt water, etc. Also, never immerse the amplifier in any liquid.
8. Do not remove the amplifier's cover during operations.
9. The amplifier is not intended for high frequency-high power use and should not be used for high power ultrasonic applications.
10. Neither the amplifier nor any of its leads should be exposed to areas likely to be struck by lightning.

PROCEDURES

After all connections have been made to the power amplifier, turn the gain controls fully counter-clockwise. Turn on the preamplifier or mixer, then turn on the power amplifier. The two green LED's on the front panel should light. If they do not, check to see that the amplifier is plugged in to a live power outlet.

With the preamplifier or mixer gain controls fully off, advance the power amplifier gain controls about half way clock-wise (slit in knob facing upwards). There should be no audible hum; if a hum is heard, check the connections between the power amplifier and preamplifier. Now advance the preamplifier gain controls until the desired maximum volume is achieved. Should the preamplifier gain control be in excess of the $3/4$ setting, decrease it to half volume and increase the gain controls of the power amplifier to the desired level.

Often, turn-on transients originate in the pre-amp or mixer. This is especially true of tube-type units. If this situation arises, turn the amplifier on after the other units have had adequate time to stabilize.

8000 CIRCUIT DESCRIPTION

POWER SUPPLY

The AC input power goes through the circuit breaker CB501, to the AC power switch S501 then to the power transformer T501. The fan M501 runs off 120 volts from one winding of the power transformer on 100 or 120V models. Export models use 240V fan.

The 12 volt AC secondary passes through F501 to the display board assembly.

The high voltage center tapped secondary 63 volts AC is connected to a full wave bridge rectifier BR501 and a capacitor input filter C503 and C504 to give a ± 88 volt DC output.

Capacitors C501 and C502 across the Bridge Rectifier suppresses any high frequency noise that might be coupled through the transformer or generated by the Bridge Rectifier.

The primary windings of the power transformer has a built-in Thermal Switch to protect from overloading of the high voltage secondary (Drawing too much power out of the transformer) and a fusible link to protect the low voltage 12V secondary.

AMPLIFIER

The input signal from J104/J105 is applied via the interconnect J101-P502 to the input level control R501. The output of R501 is applied to the base of Q101 through a coupling network consisting of C101, C102, C103, R101, R102, R103 and R106. This network provides a high input impedance to the amplifier and filters out DC and radio frequency interference. The network C103, R103, R104 and R105 provides AC signal bypass and passes DC voltage to null the amplifier offset.

Q101 is a low noise matched dual transistor in a common package connected as a differential input stage. R116 and D106 form a regulated negative voltage source. R114 and C106 form a RC filter to control turn on current to Q101. R113 acts as a constant current source for Q101. R106, D101 and D102 form an input protection limiter which prevents damage from very high input voltages that might appear at J104/J105.

The output of Q101 is Push-Pull. This signal drives the emitters of Q102 and Q103. Q102 and Q103 are connected as common base amplifiers. These stages act as a voltage translator and removes Vce distortion from Q101. The collectors of Q102 and Q103 drive Q106 and Q107. Q106 and Q107 are connected as common emitter voltage amplifier stages. The output from Q107 (positive phase) drives the two driver stages Q114, Q115, Vbe multiplier Q108 and the current mirror Q110/Q111.

Q104 and Q105 are current limiters for the voltage driver stages of Q106 and Q107. As the signal level increases turning on Q107 harder, a voltage drop appears across R125 and R126. When the drop across R125 reaches approximately 0.6 volts this turns on Q105, thus removing the drive to Q107. The action of Q104 and Q106 is the same.

Q108 is a V_{be} multiplier it provides bias voltage for the output stage and keeps idle current at a constant level as the temperature changes.

Q110 and Q111 form a current mirror stage that acts as loads for Q106 and Q107. The current mirror stage uses the base emitter diode only of Q110 to match base emitter diode of Q111. As Q107 is turned on harder, an equal and opposite amount of current is removed from Q110. Hence, the current of Q106 plus the current of Q107 remains constant.

The output circuit consisting of Q114 through Q127 is a quasi-complementary output circuit.

Q114 and Q116 are connected common collector (Darlington) to provide the current gain necessary to drive the output transistors Q118, Q120, Q122, Q123 and Q126 completing the positive output circuit.

Q115 is connected as a common emitter and drives Q117. Q117 is connected as a common collector to provide the current gain necessary to drive the output transistors Q119, Q121, Q123, Q125 and Q127, this output has 100% feedback to the emitter of Q115. The stages Q115, Q117, Q119, Q121, Q123, Q125 and Q127 act like one large PNP power transistor.

Q112 and Q113 are positive and negative VI limiter. The VI limiter action allows small amounts of current to flow when the voltage across the output transistors is great (large voltage) and allows larger amounts of current to flow when the voltage of the output transistor is lower (small voltages).

Q112 is connected in a common emitter configuration and is biased OFF. With an output signal there is current flow in Q116 and Q118, this produces a voltage drop across R148, and this will forward bias Q112. As Q112 turns on it robs the drive current from Q114 and limits the maximum output current through Q116 and Q118. The turn on threshold of Q112 is small if the output voltage swing is low or if driving a short circuit. R135 provides some pre bias signal so that the short circuit current will be lower. As the output voltage swing increases, D111 is forward biased and forms a voltage divider consisting of R136, D111 and R137 reducing the turn on signal to Q112, this allows a larger amount of output current to flow before Q112 turns on and limits the drive signal. R136, C112 and C113 form a delay circuit around Q112. This delay allows transients to be handled accurately and prevents false triggering of the limiter circuitry. The negative limiter works in the same manner.

The output appears across flyback clipping diodes D114 and D115, then passes through compensation networks L101/R160 and R161/C120 and appears at the output terminals J103 and J104.

To maintain overall amplifier stability, linearity, and low distortion, degenerative feedback is used throughout the amplifier. Voltage divider consisting of R121, R122 and C109 applies the correct amount of feedback to the inverting input of Q101. Except for the input, and feedback loop, the amplifier uses direct coupling throughout.

FAST OFF CIRCUIT (Mutes the channel)

The circuit consisting of Q109, R115, R117, R118, D107, D108 and D109 turn the current off at the input stage, (Q101) when the AC power is turned off. Under normal operating conditions Q109 is biased off and the -33V power supply is up and approximately 7V DC is on pin 10 of J101. This 7V DC forward biases D109 and allows current to flow through R118 to the negative power supply. This reverse biases D108 removing any forward bias to Q109 and when AC power is turned off the DC voltage on pin 10 of J101 goes to zero. This allows current to flow through R117, D108 and R118. This turns on Q109, which turns off the current source (-33V power supply) for Q101 and muting the amplifier.

SPEAKER PROTECTION DC circuit

This circuit shunts the loudspeaker load at frequencies of 10Hz or lower at the amplifiers full output swing, or if the amplifier fails. (Either of the above conditions looks like DC at the loudspeaker terminals). A signal appearing at the output terminal passes through R163 and is intergrated by C122, if this signal level exceeds approximately 8 volts, the bidirectional switch Q129 conducts and triggers the triac Q128 shunting the amplifier output. If this signal is transient in nature, the amplifier output voltage reverses thus, communtating the triac. If the signal is DC in nature, the triac Q128 stays turned on until power supply or the amplifier is turned off.

The "B" Channel works in the same manner as the "A" Channel described, but, reference numbers used are 200 series.

BRIDGED MODE

When the Mono/Stereo switch S502 is set to Mono, it converts the "B" Channel amplifier to a unity gain inverting power amplifier.

S502 Mono/Stereo switch grounds the normal input to "B" channel and connects the output of the channel "A" amplifier to drive the "B" channel summing point R219.

DISPLAY METER

The 12V AC input to J404 & J405 is full wave rectified by D408-D411 and integrated by C401 to give approximately 17V DC. D407 provides 7 Volts DC to J403 the fast off circuits on both modules.

POWER ON LED's

D403, D406, R419 and R420 are connected in series across the 17V DC to light both green "power on" LED's D403 and D406.

MODULATION - LED's (Signal Indicators)

The amplifier output is connected to J402 through R406 to Q404 and Q405. Q404 is connected as a common emitter stage and Q405 is connected as a common base stage. When the output signal exceeds approximately +0.6 volts (positive output), Q404 conducts. When the output signal exceeds -0.6 volts (negative output) Q405 conducts. When Q404 or Q405 conduct the collector current flowing through R408 forward biases and turns on Q406 thus lighting the yellow modulation LED D402.

OVERLOAD - LED's

The red overload LED D401 works in the same manner as modulation LED's except that the input signal from J402 is attenuated by R405 and R403. This means that the input signal is approximately 36 volts will cause Q401 and Q402 to conduct.

SERVICE INSTRUCTIONS

Model 8000

1. Disconnect AC power input
2. Remove the twelve (12) screws that secure top cover, and remove the cover.

POWER AMPLIFIER MODULE SERVICE

- A. Remove four (4) screws on rear panel, and the two (2) Two screws on front edge of the heatsink.
- B. Lift the front edge of heatsink and slide it forward to clear 5-way binding post, then turn sideways and disconnect the 11 pin plug.
- C. To reinstall reverse procedure. Be careful not to pinch any wires when reinstalling the right hand module.

DISPLAY METER SERVICE

- A. Remove the left hand module.
- B. Remove the wires. To reinstall see display schematic MFRM 13640 for pin location and wire colors.
- C. Remove the four each 6-32 hex nuts and slide PC board assembly backwards.
- D. To reinstall reverse procedure, and take caution to align LED's before inserting into the front panel. An x-acto knife may help in installing the LED's.

REV	DESCRIPTION	DATE	APPROVED
A	CONNECTED C102 ADDED C123 CHANGED Q109	6-21-64	[Signature]

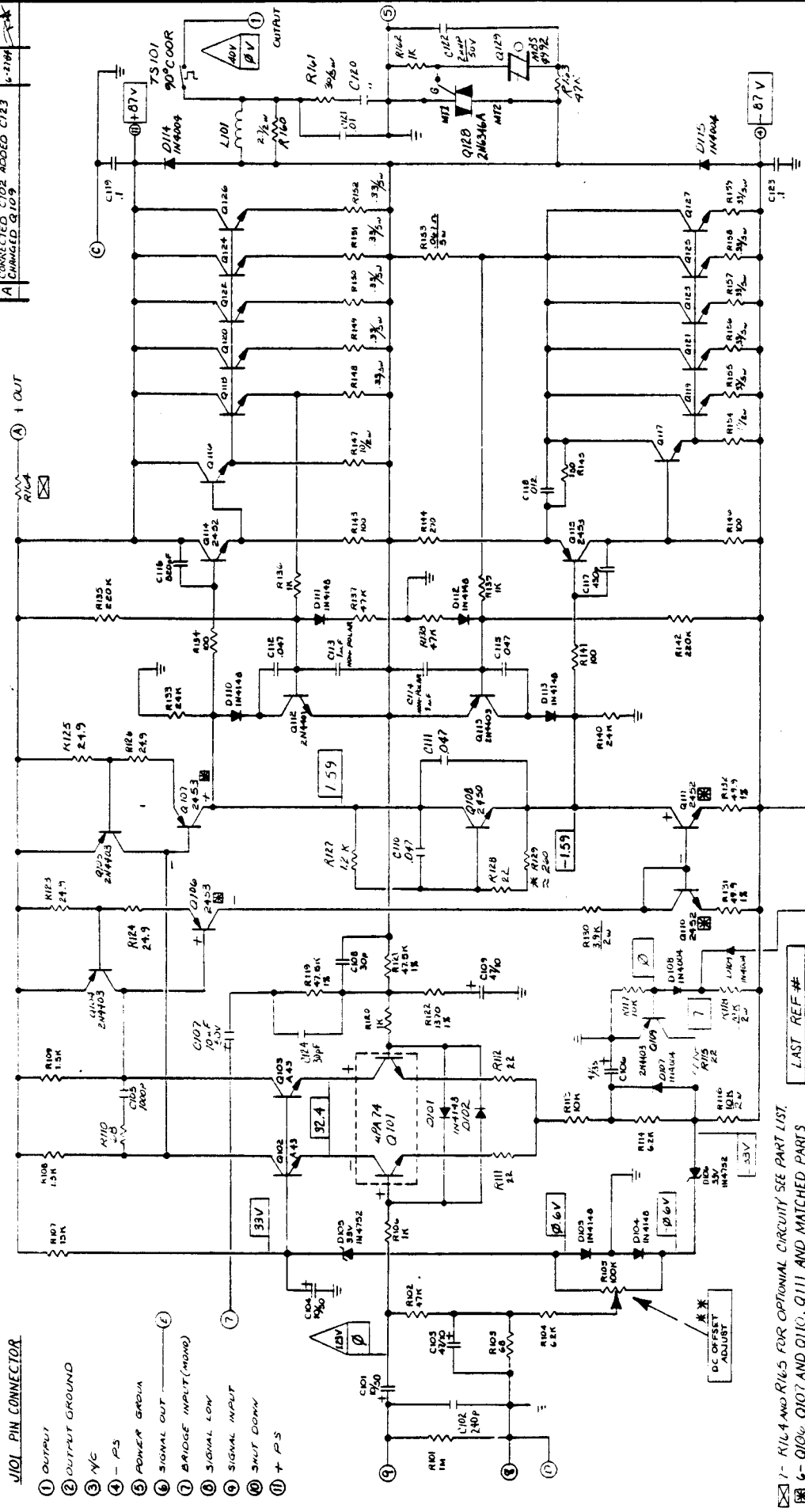

J101 PIN CONNECTOR

- ① OUTPUT
- ② OUTPUT GROUND
- ③ NC
- ④ - P5
- ⑤ POWER GROUND
- ⑥ SIGNAL OUT (HOLD)
- ⑦ BRIDGE INPUT (HOLD)
- ⑧ SIGNAL LOW
- ⑨ SIGNAL INPUT
- ⑩ SHUT DOWN
- ⑪ + P5

LAST REF. #	
R125	1/121
C124	1/121
D117	1/121
Q125	1/121
L101	1/121
T101	1/121

- ① - R104 AND R105 FOR OPTIONAL CIRCUITRY SEE PART LIST.
- ② - Q104, Q107 AND Q110, Q111 AND MATCHED PARTS SEE PART LIST.
- ③ - 5-AC VOLTS FROM GROUND 1K Ω SIGNAL USING AC DVM.
- ④ - 4-DC VOLTS FROM GROUND NO SIGNAL USING DVM.
- * * * 3-SET R104 DC OFFSET ADJUST FOR 0.000 VOLTS ACROSS SPEAKER TERMINALS.
- * 2-R105 IS A FACTORY SELECTED COMPONENT SET FOR 410 μ V/15-V ACROSS R147 OR R154.
- * ALL RESISTORS 1/2 \pm 5% UNLESS OTHERWISE NOTED.
- NOTES: 1. LINE SIZE UNLESS OTHERWISE SPECIFIED.

UNLESS OTHERWISE SPECIFIED
RESISTORS ARE IN OHMS
AND APPLY AFTER PULLING
OFF ZERO ADJUSTMENT
TOLERANCE ON VALUES IN PARENTHESIS
SURFACE MOUNTED UNLESS NOTED

RAY
RAYSON ELECTRONICS
1000 SOUTH MAIN
MOUNTAIN VIEW, CALIFORNIA 92654

TITLE: **Q101-107**
ANALOGUE MODULE
REV: **1/10/64**
DATE: **1/10/64**
DRAWN BY: **W.C.**
CHECKED BY: **[Signature]**

SCALE: **1:1**
PAGE: **1** OF **1**

REV: **A**

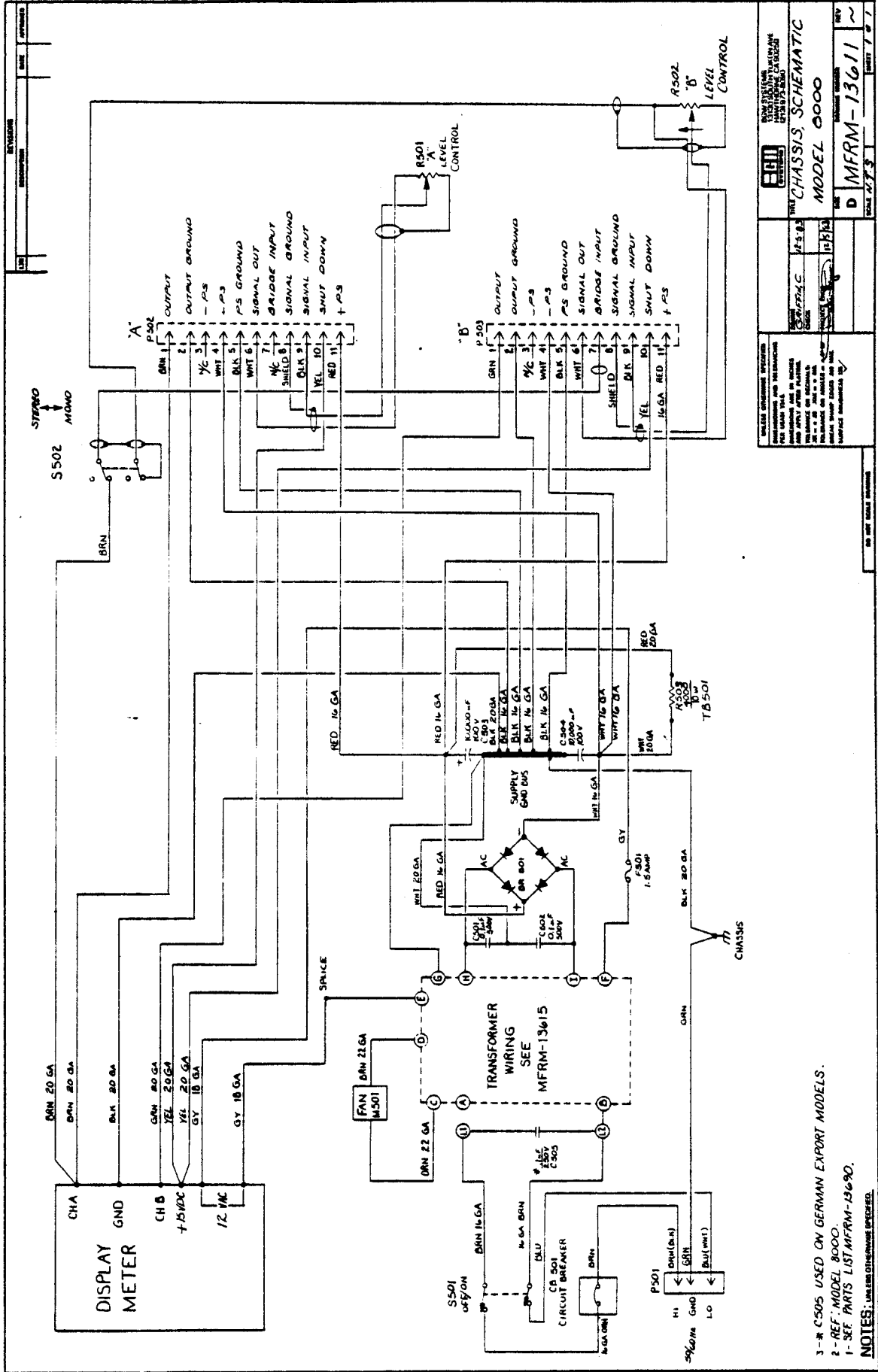

		GERMANY GHI ELECTRONIC HANNOVER 10 TELEFON 21000	
CHASSIS SCHEMATIC MODEL 8000		REV. 10/63	
SCALE 1:1		SHEET 1 OF 1	

3 - C505 USED ON GERMAN EXPORT MODELS.
 2 - REF. MODEL 8000.
 1 - SEE PARTS LIST MFRM-13690.
 NOTES: UNLESS OTHERWISE SPECIFIED.

REV	DESCRIPTION	DATE	APPROVED

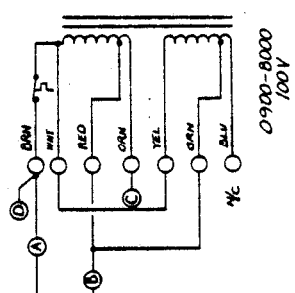
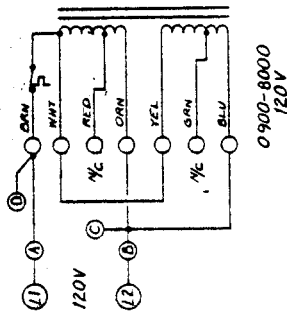
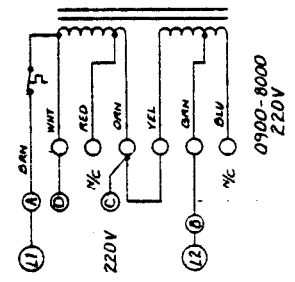

FROM CHASSIS SCHEMATIC...
MFRM-13611

- (A) — L1 SWITCHED AC
- (B) — L2 NEUTRAL AC
- (C) — ORN TO FAN 120V FAN
- (D) — BRN TO FAN 120V FAN
- (E) — 12 V AC TO FUSE F501
- (F) — 12 V AC TO DISPLAY METER
- (G) — CENTER TAP TO CAPS
- (H) — HI VOLTAGE TO BRIDGE
- (I) — HI VOLTAGE TO BRIDGE

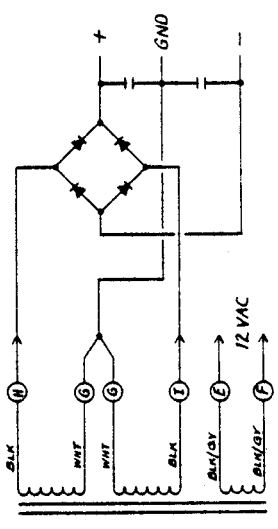

SECONDARY WIRING OF ALL POWER TRANSFORMERS

1. 0900-8000 — 100, 120, 200, 220 OR 240 VOLTS 50/60 Hz
2. 0900-8001 — 100 VOLTS 50 Hz ONLY
3. 0900-8002 — 120 VOLTS 60 Hz ONLY
4. 0900-8003 — 220/240 VOLTS 50 Hz ONLY

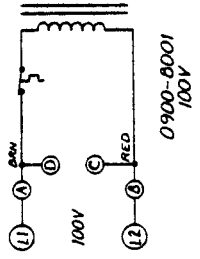
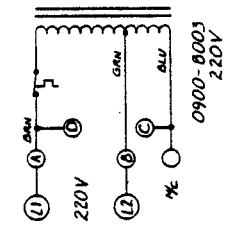
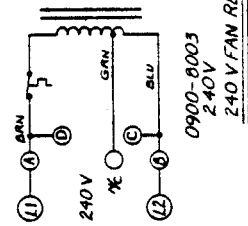
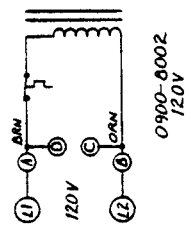

0900-8003
240V
240 V FAN REQUIRED

		GENERAL ELECTRIC TOROID TRANSFORMER WIRING MODEL 8000	
DATE: 12-2-03 DRAWN: [Signature] CHECKED: [Signature]	PART NO.: MFRM-13615 REV: 1	SHEET: 1 OF: 1	SCALE: N.T.S.

NOTES: UNLESS OTHERWISE SPECIFIED...

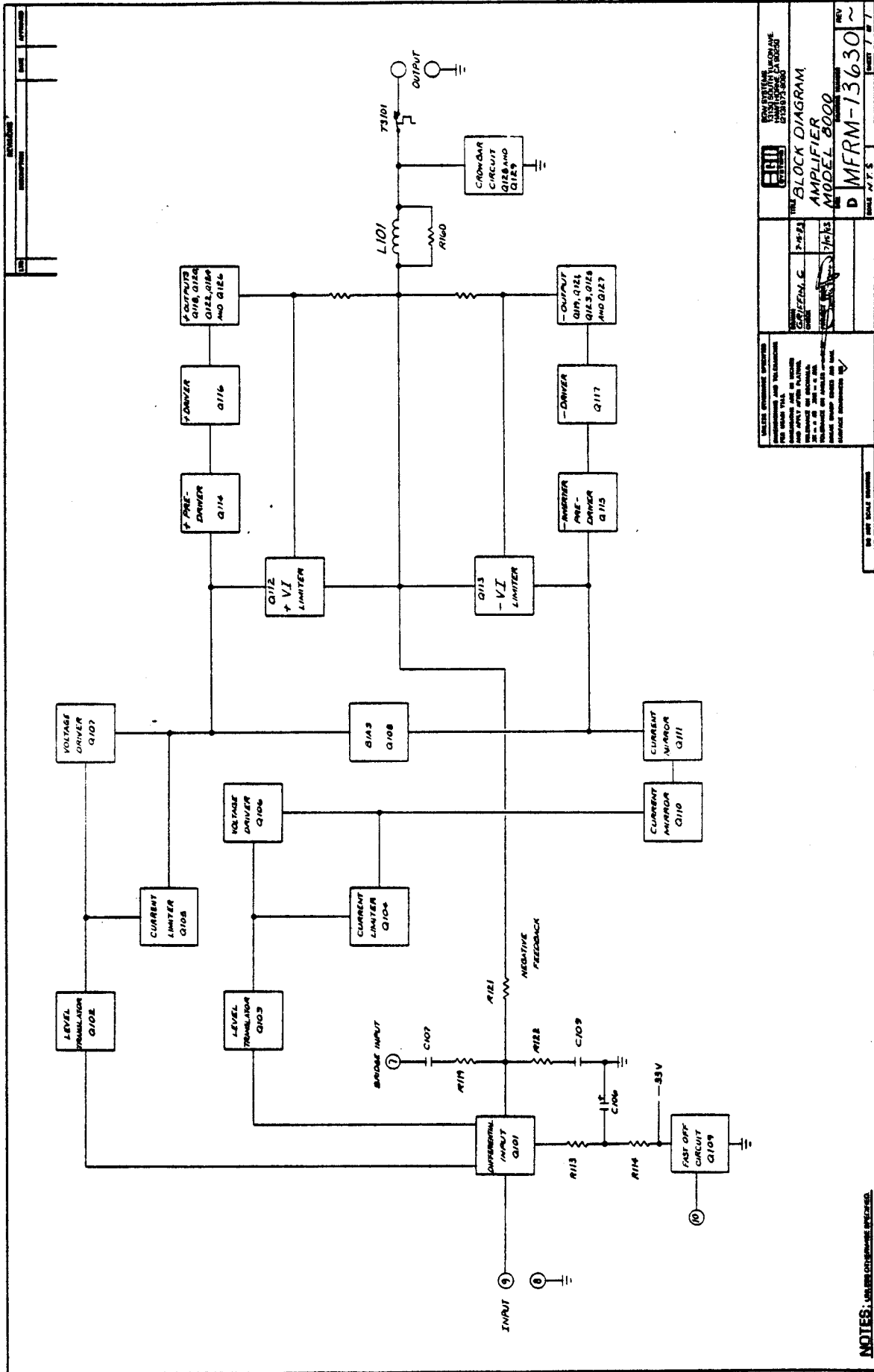

FM
 FEDERAL MILITARY STANDARD
 108-11-1
 7-52
 7/63
 BLOCK DIAGRAM
 AMPLIFIER
 MODEL 8000
 D MFRM-13630

NOTES: 1. SEE CONNECTION SHEET FOR
 2. SEE SHEET 13630-1

REV	DESCRIPTION	DATE	APPROVED
1			

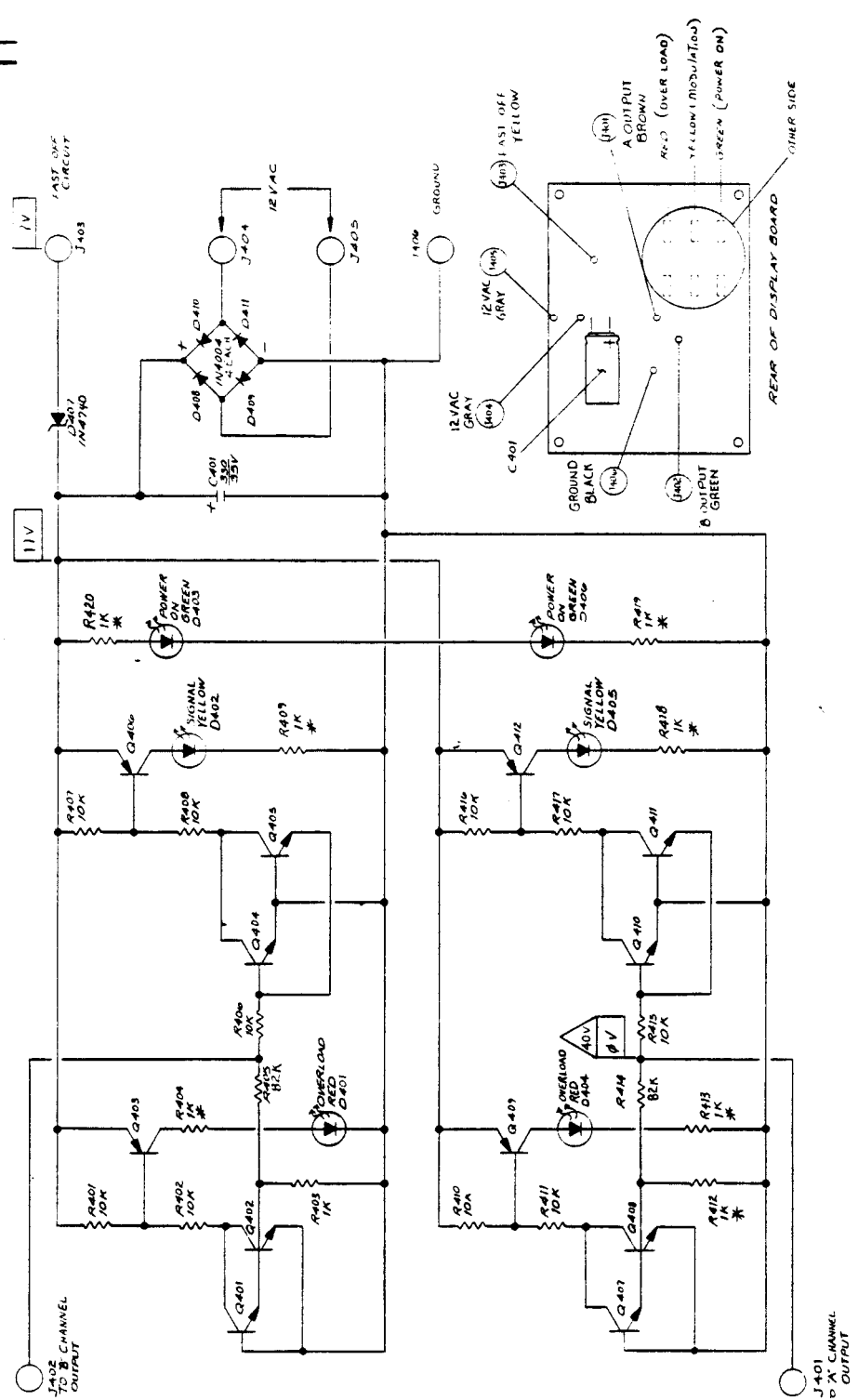

LAST COMP	
C401	Q412
D411	J410
R420	

UNLESS OTHERWISE SPECIFIED DIMENSIONS AND TOLERANCES PER MILS USE 10% TOLERANCE ON DIMENSIONS AND APPLY AFTER PLATING

BOEING SYSTEMS ELECTRONICS DIVISION
 3825 15TH AVENUE N.E.
 SEASIDE, OREGON 97138-5000

THIS DISPLAY BOARD
 PROLINE II POWER AMP
 MODEL 8000

DATE: 1/24/81
 DRAWN BY: J. J. [unclear]
 CHECKED BY: [unclear]
 APPROVED BY: [unclear]

REV: 1
 SHEET: NTS
 OF: 1

- 1 - * - 1/2 WATT RESISTOR OTHERWISE 1/4 WATT.
 - 2 - Δ - AC VOLTS FROM GROUND IN THE SIGNAL APPLIED USING AC DVM.
 - 3 - □ - DC VOLTS FROM GROUND NO SIGNAL APPLIED USING DVM.
 - 1 - TRANSISTORS N/P/N'S = 2N4401, P/N/P'S = 2N4403
- NOTES: UNLESS OTHERWISE SPECIFIED.

REV	DESCRIPTION	DATE
A	CHANGED UNICASE TO ULTRACASE ADDED Q11, Q12, Q13, Q14, Q15	1/10/63

PINS A,B,C ARE FOR OPTIONAL ACCY
 A: +PS
 B: -PS
 C: GROUND

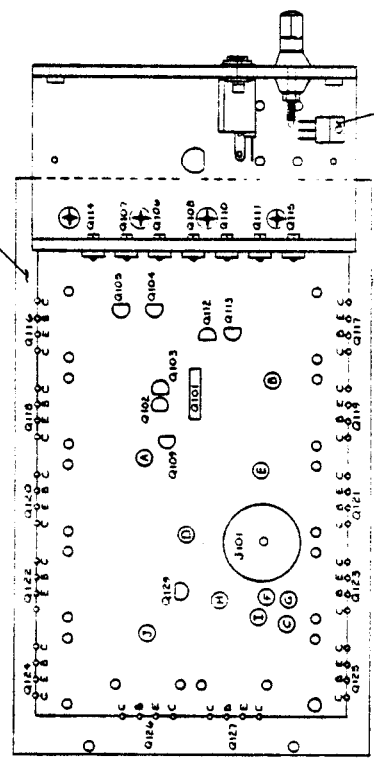
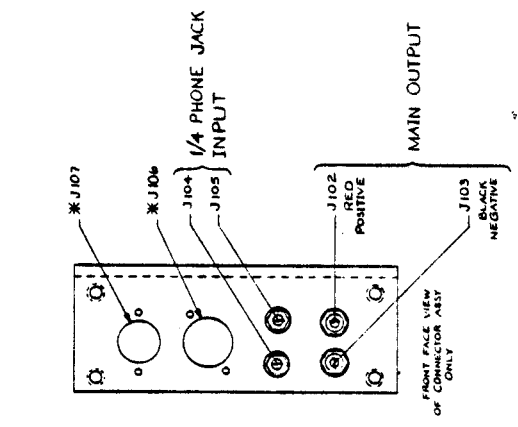
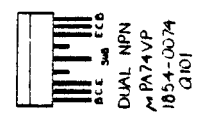
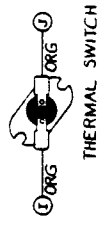
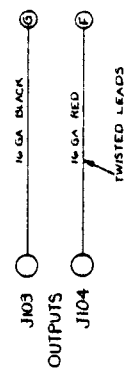
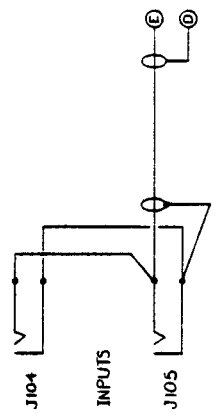

VIEW OF PRINTED CIRCUIT BOARD ON HEATSINK ASSY MODEL 8000

SILICON BILATERAL SWITCH M85-4922 R004-4972

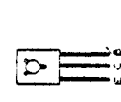
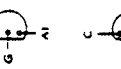

PNP 1853-2453 Q106, Q107, Q115

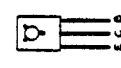

NPN 1854-2452 Q108, Q110, Q111

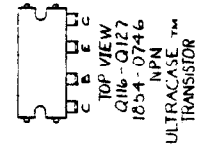

ULTRACASE™ TRANSISTOR Q116-Q127 1854-0746 NPN

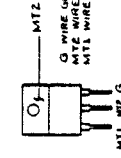

BIDIRECTIONAL TRIODE THYRISTOR 1854-6346 Q128

WIRING AND HEATSINK ASSY LAYOUT MODEL 8000	
DATE: 7-6-63	DRAWN BY: [Signature]
CHECKED BY: [Signature]	SCALE: N73
PART NO: D MFRM-13650	REV: A

1-* FOR OPTIONAL CIRCUITY.
 NOTES: UNLESS OTHERWISE SPECIFIED.

BGW SYSTEMS, INC.

ENG NO	DESCRIPTION	PART NO
*****	PARTS LIST MODEL 8000 ***** FA	13690
	SCHEMATIC CHASSIS	13610
	SCHEMATIC AMPLIFIER MODULE	13620
	SCHEMATIC BLOCK	13630
	SCHEMATIC DISPLAY	13640
	COMPONENT LAYOUT AMP MODULE	13650
	PARTS LIST MODEL 8000	13690
*****	MAJOR ASSEMBLYS *****	
	HEATSINK ASSEMBLY, COMPLETE	1001-8000
	DISPLAY ASSEMBLY, COMPLETE	9009-8001
NOTE	ALL COMPONENTS IN THE 100 SERIES ARE AMPLIFIER MODULE COMPONENTS. ALL COMPONENTS WITH DESIGNATIONS IN THE 400 SERIES ARE DISPLAY BOARD COMPONENTS ALL COMPONENTS WITH DESIGNATIONS IN THE 500 SERIES ARE CHASSIS COMPONENTS	
*****	CAPACITORS *****	
C101	10UF 50V ELECTROLYTIC	0476-0011
C102	240PF 500V MICA	0090-0240
C103	47UF 10V RADIAL ELECTROLYTIC	0456-0047
C104	10UF 50V ELECTROLYTIC	0476-0011
C105	1000PF 100V DISC	0100-1000
C106	47UF 35V RADIAL ELECTROLYTIC	0450-4700
C107	10UF 50V ELECTROLYTIC	0476-0011
C108	30PF 100V MICA	0060-0030
C109	47UF 10V RADIAL ELECTROLYTIC	0456-0047
C110	.047UF 100V DISC	0129-0047
C111	.047UF 100V DISC	0129-0047
C112	.047UF 100V DISC	0129-0047
C113	1UF 50V NONPOLAR ELECTROLYTIC	0564-0001
C114	1UF 50V NONPOLAR ELECTROLYTIC	0564-0001
C115	.047UF 100V DISC	0129-0047
C116	820PF 100V MICA	0080-0820
C117	430PF 100V MICA	0060-0430
C118	.012UF 100V MYLAR	0369-0012
C119	.1UF 100V MYLAR	0369-0100

BGW SYSTEMS, INC.

ENG NO	DESCRIPTION	PART NO
C120	.1UF 100V MYLAR	0369-0100
C121	.01UF 1.4KV DISC	0119-0010
C122	2UF 100V AXIAL NONPOLAR ELECTROLYTIC	0564-0000
C123	.1UF 100V MYLAR	0369-0100
C213	NOT USED	
C401	330UF 16V ELECTROLYTIC	0476-0330
C501	.1UF 500V DISC	0199-0100
C502	.1UF 500V DISC	0199-0100
C503	10KJF 100V ELECTROLYTIC COMPUTER GRADE	0566-0010
C504	10KUF 100V ELECTROLYTIC COMPUTER GRADE	0566-0010
C505	.1UF 250V RIFA GERMAN EXPORT ONLY	0159-0100

***** CIRCUIT BREAKER *****

CB401	CIRCUIT BREAKER, THERMAL	120V	10A	0652-1000
		100V	12A	0652-1200
		220V/240V	7A	0652-0700
	FLAT WASHER, CIRCUIT BREAKER			8101-4370
	FLAT HEX NUT, CIRCUIT BREAKER			8504-4370

***** DIODES *****

D101	SI DIODE 1N4148	1900-4148
D102	SI DIODE 1N4148	1900-4148
D103	SI DIODE 1N4148	1900-4148
D104	SI DIODE 1N4148	1900-4148
D105	33V ZENER 1N4752	1900-4752
D106	33V ZENER 1N4752	1900-4752
D107	SI DIODE 1N4004	1900-4004
D108	SI DIODE 1N4004	1900-4004
D109	SI DIODE 1N4004	1900-4004
D110	SI DIODE 1N4148	1900-4148
D111	SI DIODE 1N4148	1900-4148
D112	SI DIODE 1N4148	1900-4148
D113	SI DIODE 1N4148	1900-4148
D114	SI DIODE 1N4004	1900-4004
D115	SI DIODE 1N4004	1900-4004
D401	RED RECTANGULAR LED	1900-2000
D402	YELLOW RECTANGULAR LED	1900-4000
D403	GREEN RECTANGULAR LED	1900-5000
D404	RED RECTANGULAR LED	1900-2000
D405	YELLOW RECTANGULAR LED	1900-4000
D406	GREEN RECTANGULAR LED	1900-5000
D407	10V ZENER DIODE 1N4740	1900-4740
D408	SI DIODE 1N4004	1900-4004
D409	SI DIODE 1N4004	1900-4004
D410	SI DIODE 1N4004	1900-4004
D411	SI DIODE 1N4004	1900-4004

BGW SYSTEMS, INC.

ENG NO	DESCRIPTION	PART NO
D501	25 AMP BRIDGE RECTIFIER	1886-2502
***** FUSE *****		
F501	FUSE HOLDER FUZE. 1.5 AMP, FAST BLOW	9999-4406 0600-1501
***** JACKS AND PLUGS *****		
J101	11 PIN SOCKET	1202-0011
J102	BINDING PJST. RED	1231-0008
J103	BINDING PJST. BLACK	1231-0009
J104	1/4 IN PHONE JACK. INSULATED	1205-0005
J105	1/4 IN PHONE JACK. INSULATED	1205-0005
J401- J406	MOLEX MALE PC MOUNT PINS	1349-9312
P501	POWER CORDS	
	USA, U-GROUND	8709-0163
	STRAIN RELIEF, USA CORD	1235-6034
	GERMAN CORD	8702-0183
	STRAIN RELIEF, GERMAN CORD	1235-6004
	AUSTRALIAN CORD	8709-0383
	STRAIN RELIEF, AUST. CORD	1235-6004
P502	11 PIN PLUG	1350-0011
P503	11 PIN PLUG	1350-0011
***** INDUCTOR *****		
L101	INDUCTOR .5UH	9999-2405
***** FAN *****		
M501	70 CFM BOX FAN 120V	8800-3000
***** TRANSISTORS *****		
NOTE *	TRANSISTORS 106 AND 107 ARE A MATCHED PAIR. TRANSISTORS 110 AND 111 ARE A MATCHED PAIR IF EITHER TRANSISTOR OF A PAIR MUST BE REPLACED, BOTH SHOULD BE REPLACED WITH ANOTHER MATCHED PAIR OR SAME BETA GROUP MARKING. BOTH A . B . C . OR D TYPES	
Q101	NPN DUAL MATCHED TRANSISTOR	1854-0074
Q102	NPN SI SMALL SIG T0-92 MPS A43	1854-0043
Q103	NPN SI SMALL SIG T0-92 MPS A43	1854-0043
Q104	PNP SI SMALL SIG T0-92 2N4403	1853-4403

BGW SYSTEMS, INC.

ENG NO	DESCRIPTION	PART NO
Q105	PNP SI SMALL SIG TO-92 2N4403	1853-4403
Q106*	PNP MED PWR PLASTIC TO-126	1853-2453
Q107*	PNP MED PWR PLASTIC TO-126	1853-2453
Q108	NPN MED PWR PLASTIC TO-126	1854-2450
Q109	PNP SI SMALL SIG TO-92 MPS-A43	1853-0043
Q110*	NPN MED PWR PLASTIC TO-126	1854-2452
Q111*	NPN MED PWR PLASTIC TO-126	1854-2452
Q112	NPN SI SMALL SIG TO-92 2N4401	1854-4401
Q113	PNP SI SMALL SIG TO-92 2N4403	1853-4403
Q114	NPN MED PWR PLASTIC TO-126	1854-2452
Q115	PNP MED PWR PLASTIC TO-126	1853-2453
Q115	NPN SI ULTRACASE PWR	1854-0746
Q117	NPN SI ULTRACASE PWR	1854-0746
Q118	NPN SI ULTRACASE PWR	1854-0746
Q119	NPN SI ULTRACASE PWR	1854-0746
Q120	NPN SI ULTRACASE PWR	1854-0746
Q121	NPN SI ULTRACASE PWR	1854-0746
Q122	NPN SI ULTRACASE PWR	1854-0746
Q123	NPN SI ULTRACASE PWR	1854-0746
Q124	NPN SI ULTRACASE PWR	1854-0746
Q125	NPN SI ULTRACASE PWR	1854-0746
Q126	NPN SI ULTRACASE PWR	1854-0746
Q127	NPN SI ULTRACASE PWR	1854-0746
Q128	THYRISTOR, TRIAC, BIDIRECTIONAL 2N6346A	1884-6346
Q129	SI BIDIRECTIONAL SWITCH M8S 4992	1884-4992
Q401	NPN SI SMALL SIG TO-92 2N4401	1854-4401
Q402	NPN SI SMALL SIG TO-92 2N4401	1854-4401
Q403	PNP SI SMALL SIG TO-92 2N4403	1853-4403
Q404	NPN SI SMALL SIG TO-92 2N4401	1854-4401
Q405	NPN SI SMALL SIG TO-92 2N4401	1854-4401
Q406	PNP SI SMALL SIG TO-92 2N4403	1853-4403
Q407	NPN SI SMALL SIG TO-92 2N4401	1854-4401
Q408	NPN SI SMALL SIG TO-92 2N4401	1854-4401
Q409	PNP SI SMALL SIG TO-92 2N4403	1853-4403
Q410	NPN SI SMALL SIG TO-92 2N4401	1854-4401
Q411	NPN SI SMALL SIG TO-92 2N4401	1854-4401
Q412	PNP SI SMALL SIG TO-92 2N4403	1853-4403

***** RESISTORS *****

R101	1 MEG 1/4W 5% DEPOSITED CARBON	5065-1006
R102	47K 1/4W 5% DEPOSITED CARBON	5065-4703
R103	68 JHM 1/4W 5% DEPOSITED CARBON	5065-6800
R104	6.2K 1/4W 5% DEPOSITED CARBON	5065-6202
R105	100K TRIM POT PC MOUNT	7100-1005
R106	1K 1/4W 5% DEPOSITED CARBON	5065-1003
R107	15K 1/2W 5% DEPOSITED CARBON	5005-1503
R108	1.5K 1/4W 5% DEPOSITED CARBON	5065-1502
R109	1.5K 1/4W 5% DEPOSITED CARBON	5065-1502
R110	68 JHM 1/4W 5% DEPOSITED CARBON	5065-6800
R111	22 JHM 1/4W 5% DEPOSITED CARBON	5065-2200

BGW SYSTEMS, INC.

ENG NO	DESCRIPTION	PART NO
R112	22 OHM 1/4W 5% DEPOSITED CARBON	5065-2200
R113	10K 1/4W 5% DEPOSITED CARBON	5065-1004
R114	6.2K 1/4W 5% DEPOSITED CARBON	5065-6202
R115	22 OHM 1/4W 5% DEPOSITED CARBON	5065-2200
R116	10K 2W 5% CARBON COMPOSITION	6025-1004
R117	10K 1/4W 5% DEPOSITED CARBON	5065-1004
R118	10K 2W 5% CARBON COMPOSITION	6025-1004
R119	47.5K 1% RN60D	5001-4752
R120	1K 1/4W 5% DEPOSITED CARBON	5065-1003
R121	47.5K 1% RN60D	5001-4752
R122	1370 OHMS 1% RN50D	5001-1371
R123	24.9 OHM 1% RN60D	5001-2490
R124	24.9 OHM 1% RN60D	5001-2490
R125	24.9 OHM 1% RN60D	5001-2490
R126	24.9 OHM 1% RN60D	5001-2490
R127	1.2K 1/4W 5% DEPOSITED CARBON	5065-1202
R128	22 OHM 1/4W 5% DEPOSITED CARBON	5065-2200
R129	FACTORY SELECTED	
R130	3.9K 2W 5% CARBON COMPOSITION	6020-3902
R131	49.9 OHM 1% RN60D	5001-4990
R132	49.9 OHM 1% RN60D	5001-4990
R133	24K 1/2W 5% DEPOSITED CARBON	5005-2403
R134	100 OHM 1/4W 5% DEPOSITED CARBON	5065-1002
R135	220K 1/4W 5% DEPOSITED CARBON	5065-2204
R136	1K 1/4W 5% DEPOSITED CARBON	5065-1003
R137	47K 1/4W 5% DEPOSITED CARBON	5065-4703
R138	47K 1/4W 5% DEPOSITED CARBON	5065-4703
R139	1K 1/4W 5% DEPOSITED CARBON	5065-1003
R140	24K 1/2W 5% DEPOSITED CARBON	5005-2403
R141	100 OHM 1/4W 5% DEPOSITED CARBON	5065-1002
R142	220K 1/4W 5% DEPOSITED CARBON	5065-2204
R143	100 OHM 1/4W 5% DEPOSITED CARBON	5065-1002
R144	270 OHM 1/4W 5% DEPOSITED CARBON	5065-2701
R145	150 OHM 1/4W 5% DEPOSITED CARBON	5065-1501
R146	100 OHM 1/4W 5% DEPOSITED CARBON	5065-1002
R147	10 OHM 2W 5% BWH WIREWOUND	4025-1001
R148	.33 OHM 5W 5% WIREWOUND	4050-0330
R149	.33 OHM 5W 5% WIREWOUND	4050-0330
R150	.33 OHM 5W 5% WIREWOUND	4050-0330
R151	.33 OHM 5W 5% WIREWOUND	4050-0330
R152	.33 OHM 5W 5% WIREWOUND	4050-0330
R153	.067 OHM 5W 5% WIREWOUND	4050-0067
R154	10 OHM 2W 5% BWH WIREWOUND	4025-1001
R155	.33 OHM 5W 5% WIREWOUND	4050-0330
R156	.33 OHM 5W 5% WIREWOUND	4050-0330
R157	.33 OHM 5W 5% WIREWOUND	4050-0330
R158	.33 OHM 5W 5% WIREWOUND	4050-0330
R159	.33 OHM 5W 5% WIREWOUND	4050-0330
R160	2.7 OHM 2W 5% BWH WIREWOUND	4025-2070
R161	30 OHM 5W 5% WIREWOUND	4050-3001
R162	1K 1/4W 5% DEPOSITED CARBON	5065-1003

BGW SYSTEMS, INC.

ENG NO	DESCRIPTION	PART NO
R153	47K 1/4W 5% DEPOSITED CARBON	5065-4703
R154	OPTIONAL FOR INPUT ASSY	
R155	OPTIONAL FOR INPUT ASSY	
R401	10K 1/4W 5% DEPOSITED CARBON	5065-1004
R402	10K 1/4W 5% DEPOSITED CARBON	5065-1004
R403	1K 1/4W 5% DEPOSITED CARBON	5065-1003
R404	1K 1/2W 5% DEPOSITED CARBON	5005-1003
R405	82K 1/2W 5% DEPOSITED CARBON	5005-8203
R406	10K 1/4W 5% DEPOSITED CARBON	5065-1004
R407	10K 1/4W 5% DEPOSITED CARBON	5065-1004
R408	10K 1/4W 5% DEPOSITED CARBON	5065-1004
R409	1K 1/2W 5% DEPOSITED CARBON	5005-1003
R410	10K 1/4W 5% DEPOSITED CARBON	5065-1004
R411	10K 1/4W 5% DEPOSITED CARBON	5065-1004
R412	1K 1/4W 5% DEPOSITED CARBON	5065-1003
R413	1K 1/2W 5% DEPOSITED CARBON	5005-1003
R414	82K 1/2W 5% DEPOSITED CARBON	5005-8203
R415	10K 1/4W 5% DEPOSITED CARBON	5065-1004
R416	10K 1/4W 5% DEPOSITED CARBON	5005-1004
R417	10K 1/4W 5% DEPOSITED CARBON	5065-1004
R418	1K 1/2W 5% DEPOSITED CARBON	5005-1003
R419	1K 1/2W 5% DEPOSITED CARBON	5005-1003
R420	1K 1/2W 5% DEPOSITED CARBON	5005-1003
R501	22K DETENTED POT SOLDER LUGS	7006-0020
R502	22K DETENTED POT SOLDER LUGS	7006-0020
R503	4K 10# WIREWOUND 20%	4100-4003
***** SWITCHES *****		
TS101	THERMAL SWITCH, 90C DCR	0630-0001
S501	AC ON/OFF SWITCH 15A DPDT ROCKER	0620-1601
	ON/OFF SWITCH MOUNTING SCREWS, FLAT HEAD	2331-0500
S502	MONO/STEREO SLIDE SWITCH DPDT	0520-6206
***** TRANSFORMER *****		
T501	POWER TX, 100, 120, 200, 220V, 240V TAPS	0900-0007
	TRANSFORMER BRACKET	1235-0029
	BRACKET MOUNTING SCREWS	2111-4750
***** MISC *****		
2	KNOB, PUSH-ON	0700-1114
2	HANDLE, EXTRUDED	0701-0004
8	HANDLE SCREWS, 10-32X.5 SOCKET HEAD	2431-5500
1	FRONT PANEL, 8000	9000-8000
1	TOP COVER, MODEL 8000	9005-8000
4	SPACER, DISPLAY BOARD MOUNT	8605-0001
12	MICA INSULATOR FOR ULTRACASE TRANSISTOR	0723-0200
24	SCREW, ULTRACASE TRANSISTOR, 6-32X.5 SOCKET HEAD	2431-3500
8	MICA INSULATOR TU-126/TO-220 TRANSISTOR	0723-5677

13690-7

BGW SYSTEMS, INC.

ENG NO	DESCRIPTION	PART NO
7	COMPRESSION WASHER FOR TO-126	8130-0000
1	NYLON WASHER TO-220	8130-0001
3	MALE/FEMALE STANDOFF, 1/2IN	0772-4501
1	CAPACITOR CLAMP	1235-0004
4	RUBBER FEET	9999-2085
1	FAN GRILL	9999-5039
4	FAN SCREW CLIP	1235-0407
4	FAN SCREWS 6-32X.625	2111-3625

NOTE ALL PRICES ARE SUBJECT TO CHANGE
WITHOUT PRIOR NOTICE

*** REVISED 8/29/83 ***

LIMITED ONE YEAR WARRANTY

BGW SYSTEMS, INC., (BGW), 13130 South Yukon Avenue, Hawthorne, California, 90250, warrants to the original owner all parts, except front panels, knobs, cases and cabinets, of every new BGW product to be free from defects in materials or workmanship, as hereinafter provided, for one (1) year from the original date of purchase.

BGW will at its option, repair or replace any equipment covered by this warranty which becomes defective, malfunctions or otherwise fails to conform with this warranty under normal use and service during the term of this warranty, at no charge for parts or labor.

In order to obtain warranty service, the equipment, together with the original or a machine reproduction of the Bill of Sale or other dates, proof-of-purchase document describing the equipment, must be delivered to an Authorized BGW Dealer/Service Center in the continental United States, or to BGW at the above address, at the owners expense. Any evidence of alteration, erasing or forgery of proof-of-purchase documents will be cause to void the warranty. Collect shipments to BGW will be refused unless previously authorized. The names and addresses of Authorized BGW Service Stations may be obtained by writing to BGW Warranty Department at the above address.

This warranty does not cover defects, malfunctions or failures resulting from shipping or transit accidents, abuse, misuse, operation contrary to furnished instructions, operation on incorrect power supplies, operation with faulty associated equipment, modification, alteration, improper servicing, tampering or normal wear and tear. Equipment on which the serial number has been defaced or removed shall not be eligible for warranty service. Should any equipment submitted for warranty service be found ineligible therefore, an estimate of repair cost will be furnished and the repair will be accomplished if requested by the owner upon receipt of payment or acceptable arrangements for payment.

ANY IMPLIED WARRANTIES INCLUDING WARRANTIES OF MERCHANTABILITY AND FITNESS FOR A PARTICULAR PURPOSE, SHALL BE LIMITED IN DURATION TO THE PERIOD OF TIME SET FORTH ABOVE. BGW SHALL NOT BE RESPONSIBLE FOR INCIDENTAL OR CONSEQUENTIAL DAMAGES. SOME STATES DO NOT ALLOW LIMITATION ON HOW LONG AN IMPLIED WARRANTY LASTS OR THE EXCLUSION OR LIMITATION OF INCIDENTAL OR CONSEQUENTIAL DAMAGES, SO THE ABOVE LIMITATIONS OR EXCLUSION MAY NOT APPLY TO YOU. This warranty gives you specific legal rights and you may also have other rights which vary from state to state. This is the only expressed warranty applicable to BGW products. BGW neither assumes nor authorizes anyone to assume for it any other expressed warranty.

Completion and return of the owner registration card enclosed with the equipment is requested, but is not a condition for obtaining warranty service.

BGW reserves the right to make changes or improvements in design or manufacturing without incurring any obligation to change or improve products manufactured prior thereto.