

CONFIDENTIAL

82 Series

Schematic

B I A M P[®]
S Y S T E M S

10074 SW Arctic Drive Beaverton, OR 97005 503-641-7287

RECEIVED FEB - 2 2006

IC DESCRIPTION OUTLINE

6-12 CHAN MIXERS

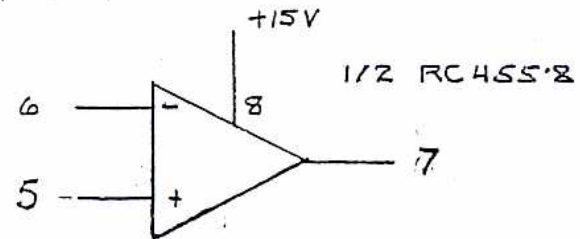
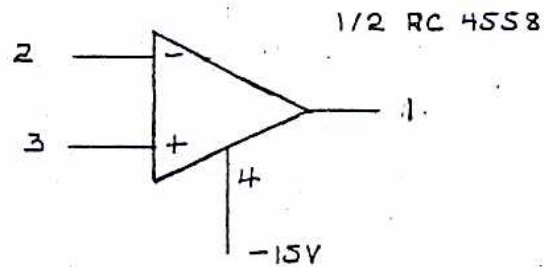
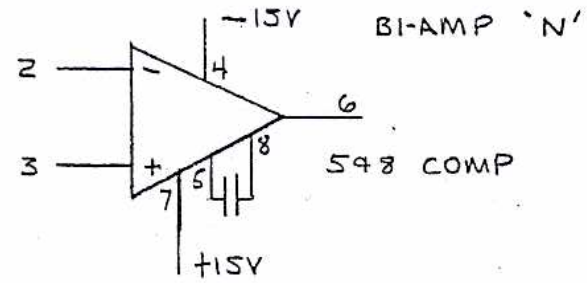
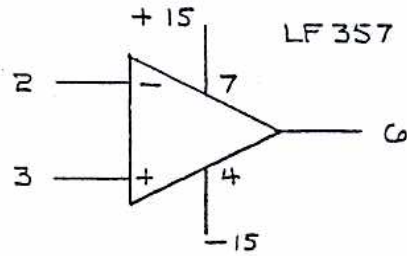

LOCATION CHART
8-12 CHANNEL BOARD
COMPONENT SIDE

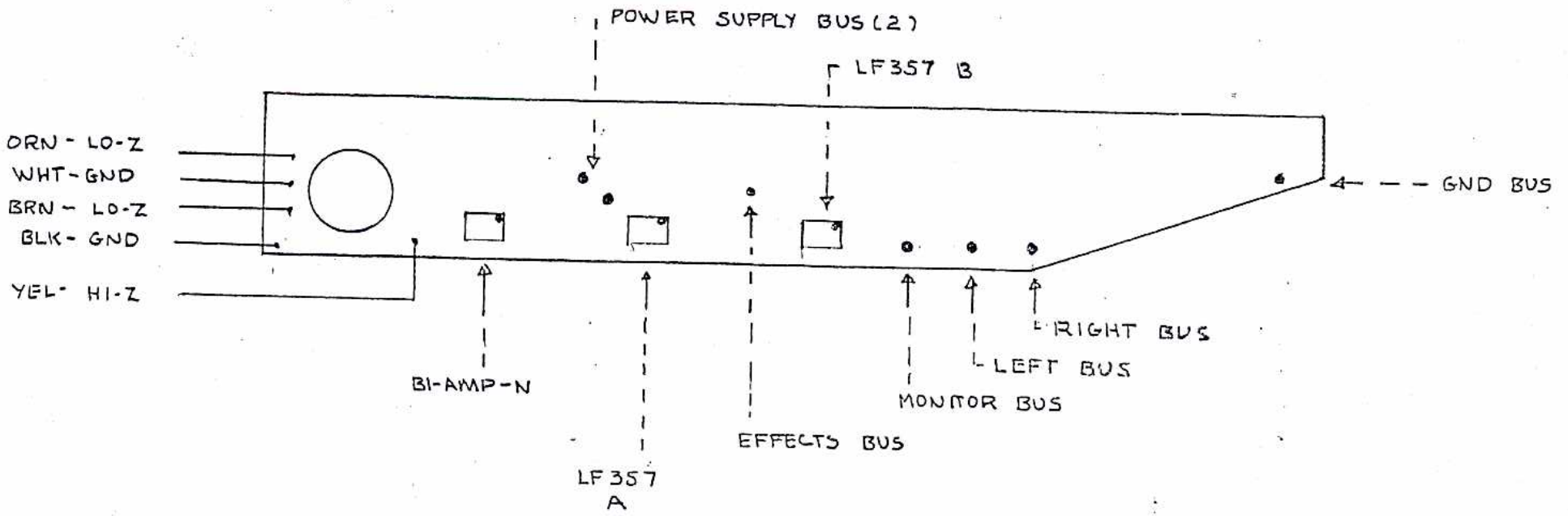

3802-1282 MIXER
CHANNEL DIAGRAM
REV-A

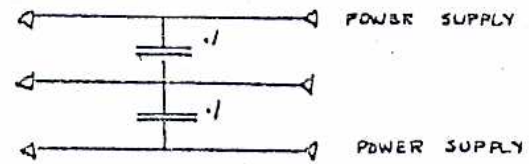
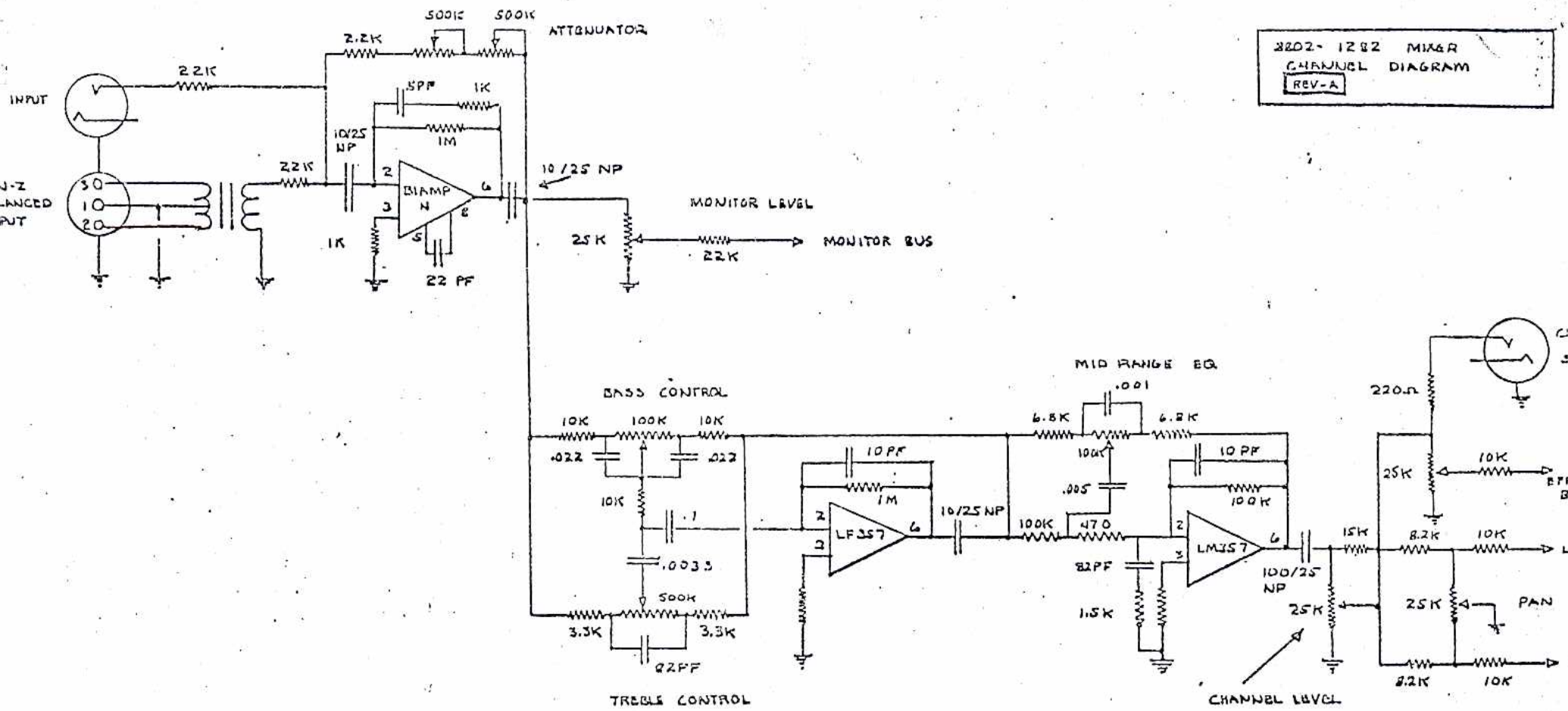

8802-12R2 MIXER
CHANNEL DIAGRAM
REV-B 6-5-78

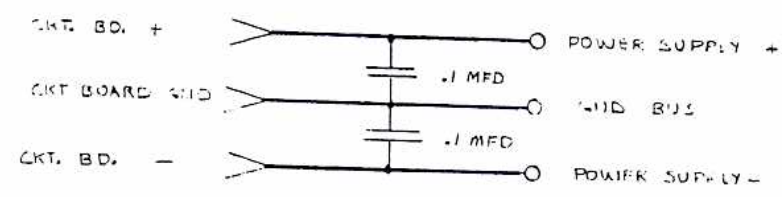
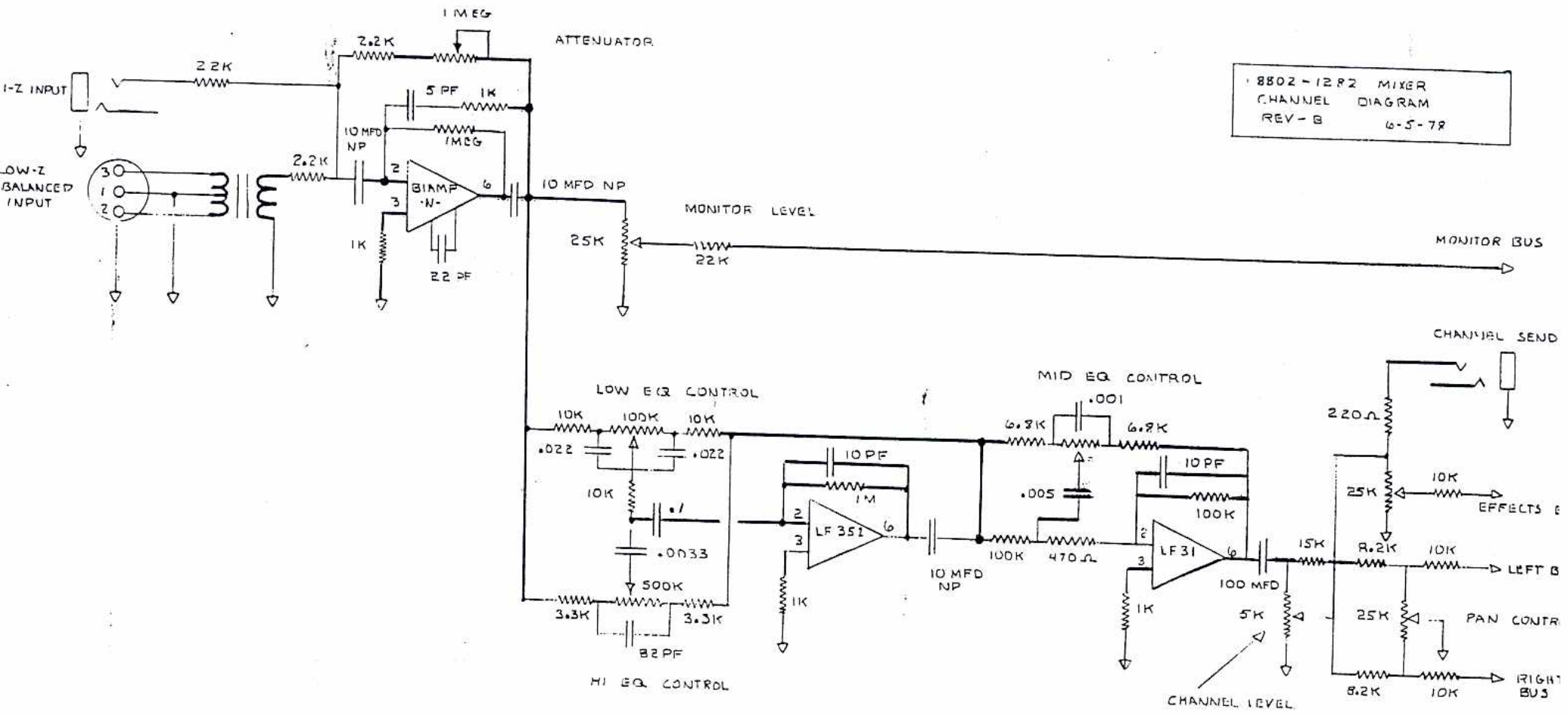

8802 - 1282 MIXER
 CHANNEL DIAGRAM
 REV - E 6-5-78

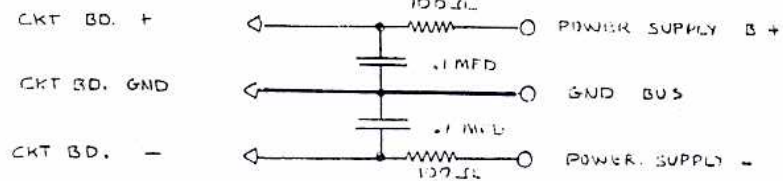
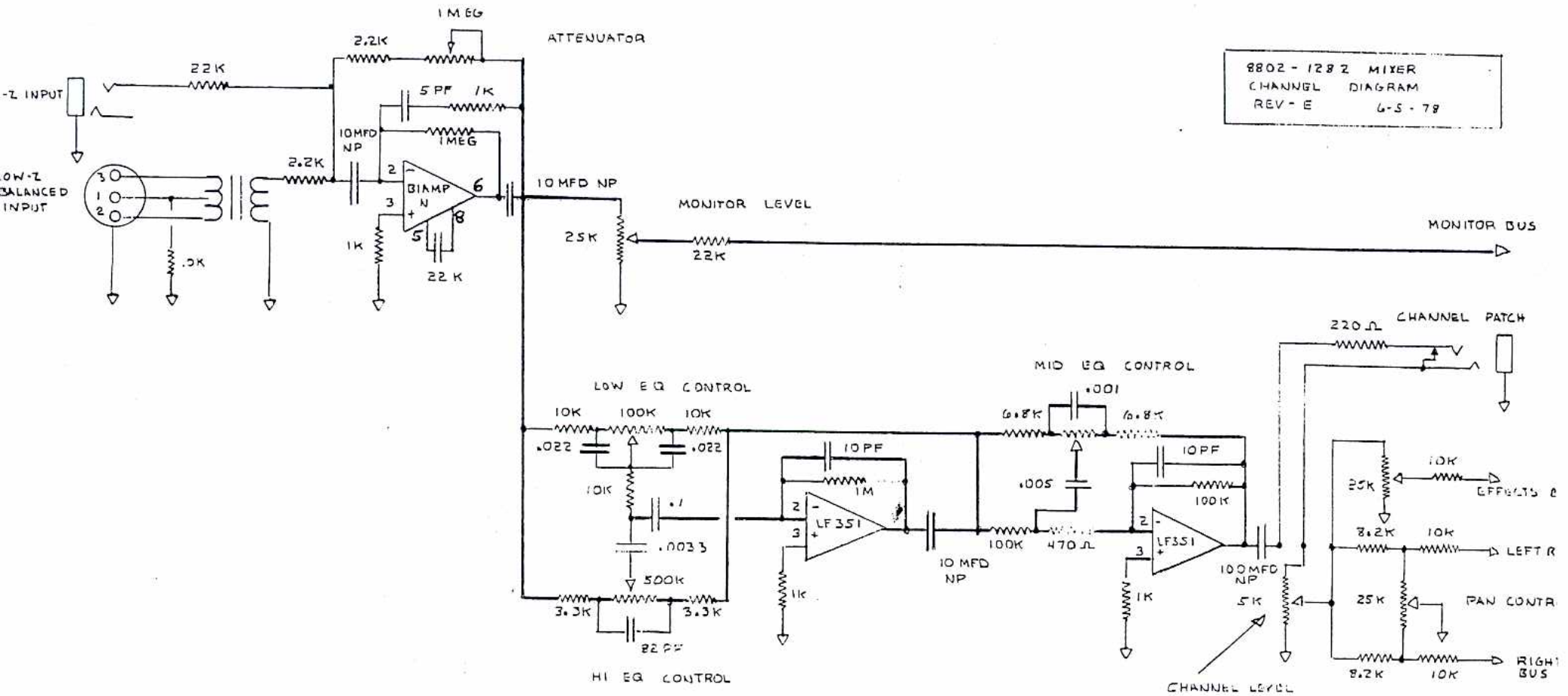

NOTE 1
 CKT. BD. FOR NORMAL
 CHANNEL SEND OR
 CHANNEL PATCH MODIFICATION

LEFT. MIXER + EFFECTS
BOARD 8-12 MIXER

CONFIDENTIAL

COMPONENT SIDE

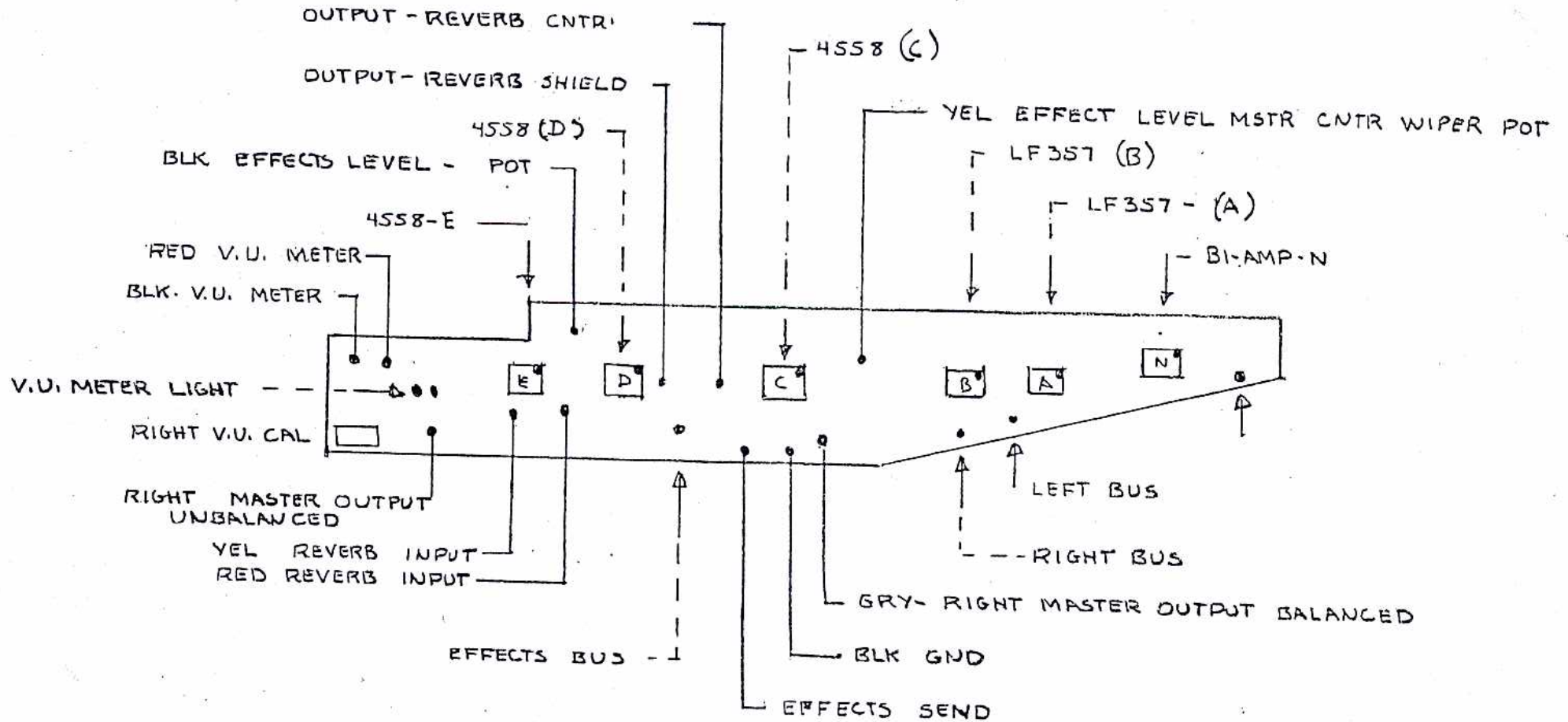

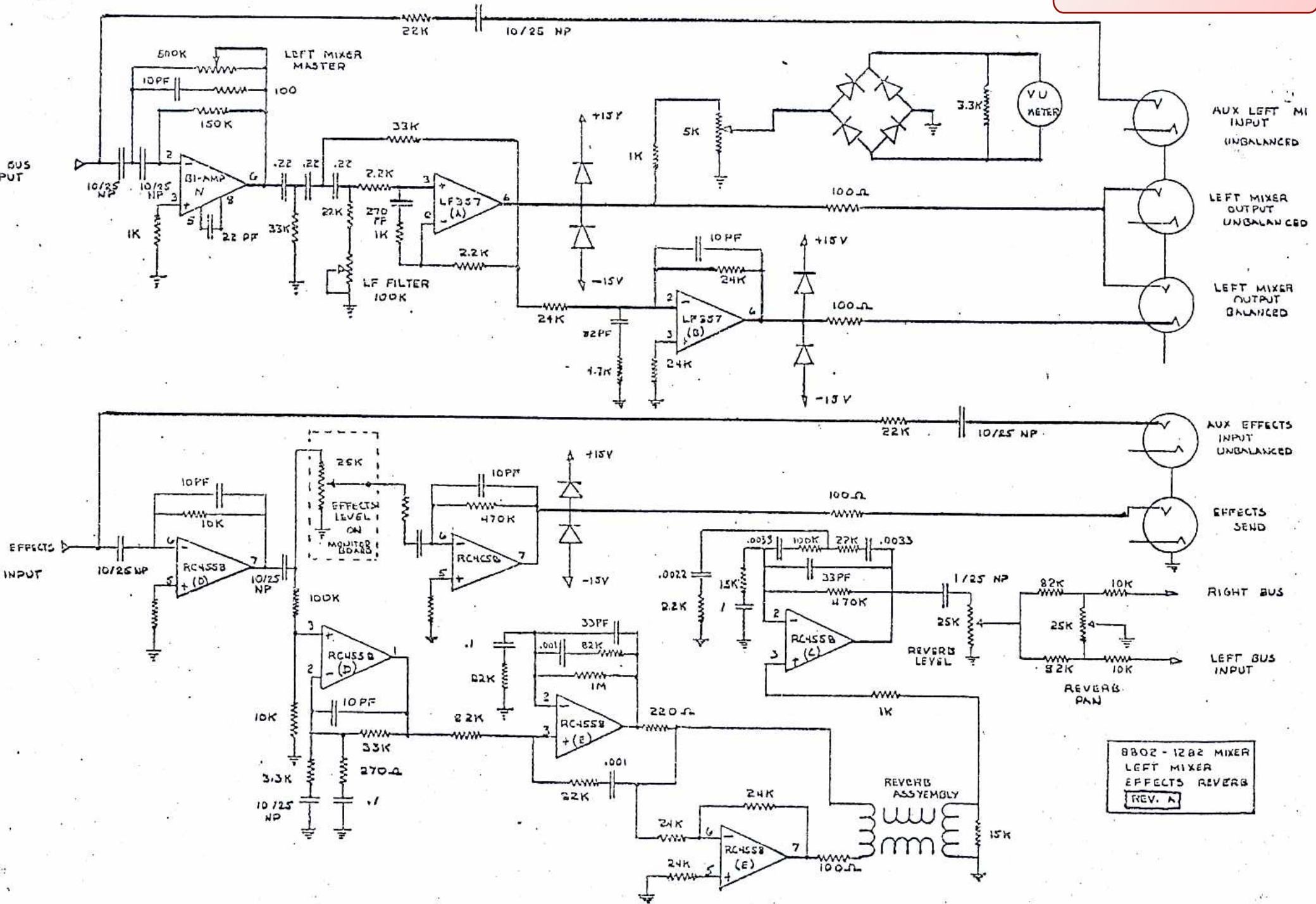

8802-1282 MIXER
LEFT MIXER
EFFECTS REVERB
REV. A

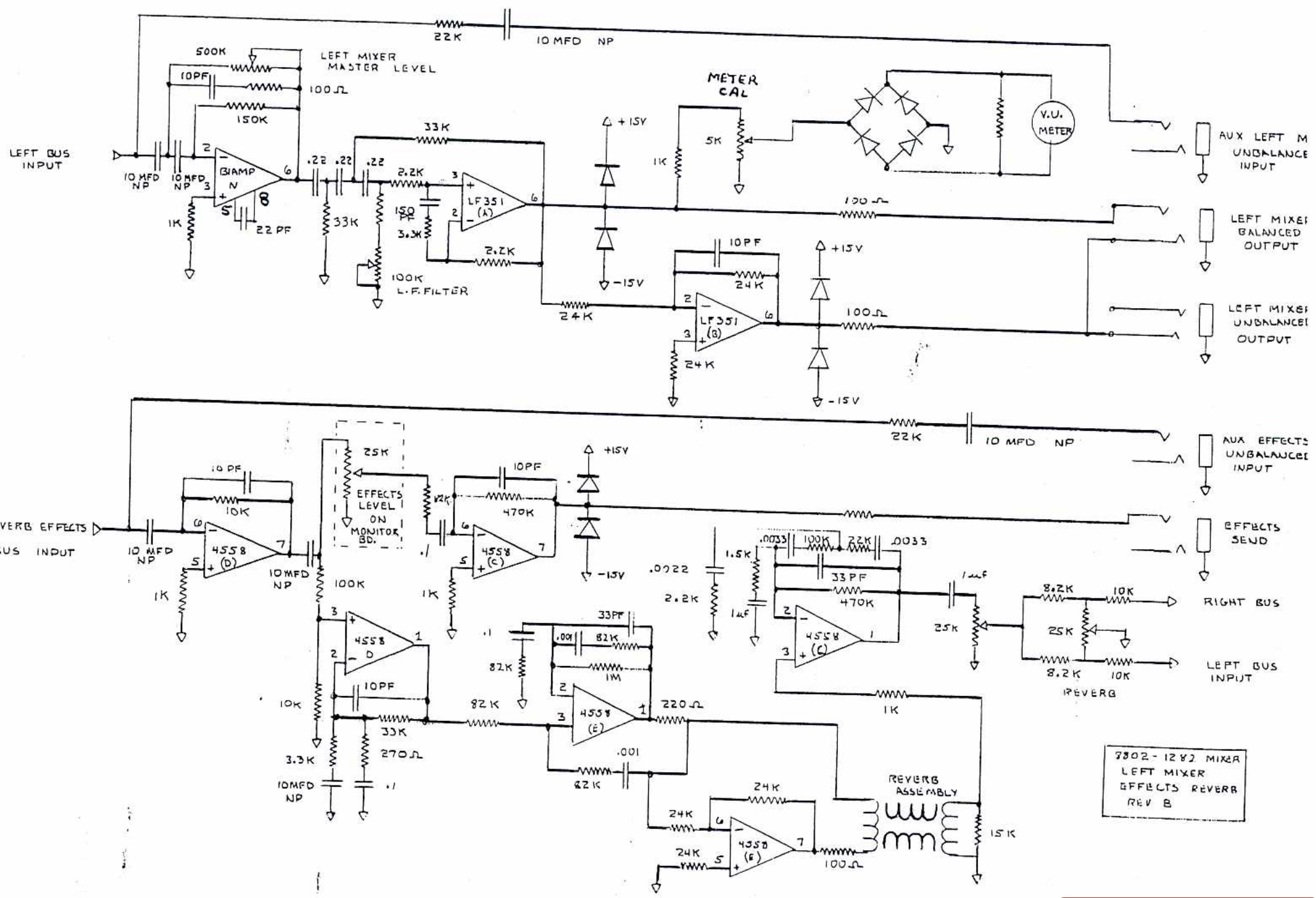

RIGHT MIXER 8-12 MIXER
BOARD
COMPONENT SIDE

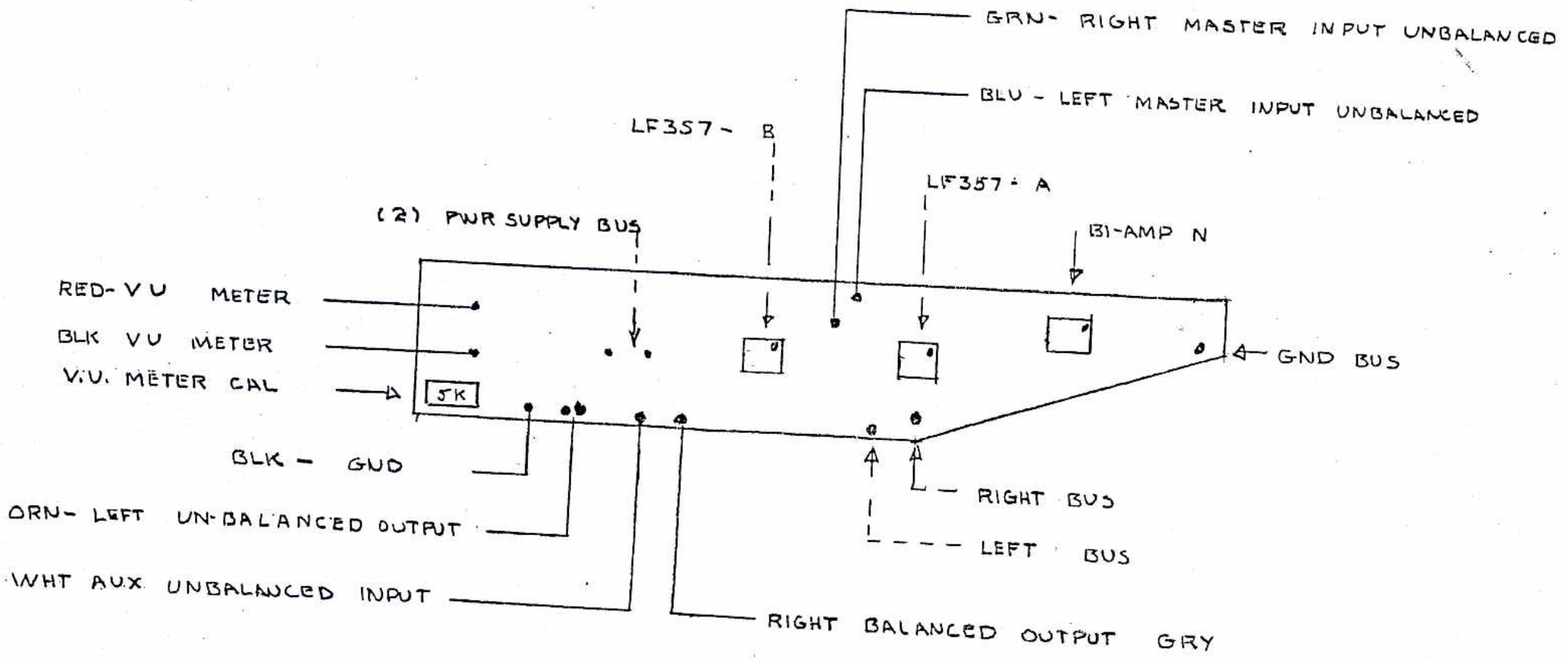

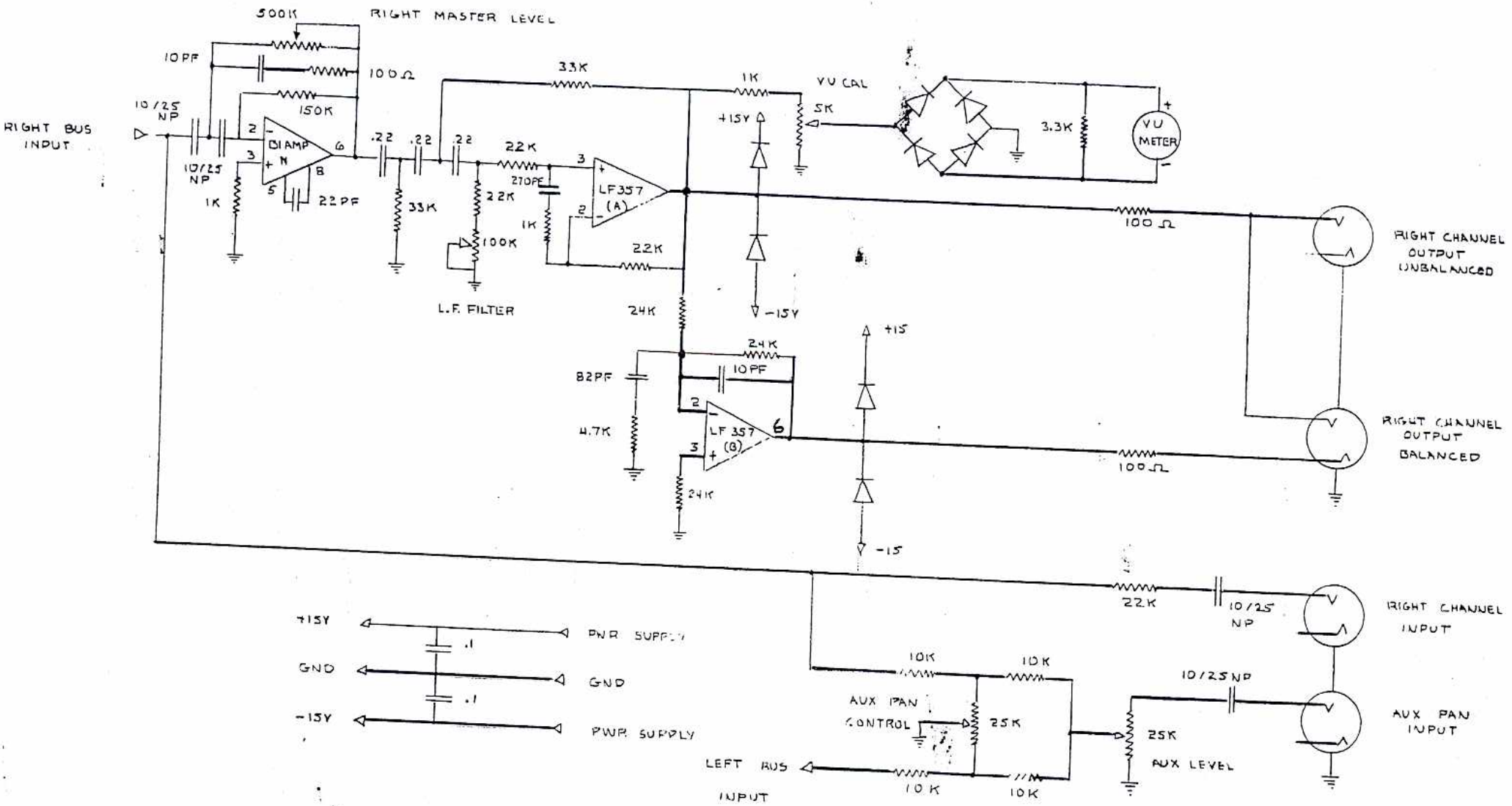

8402-1292 MIXER
RIGHT MIXER
REV. A

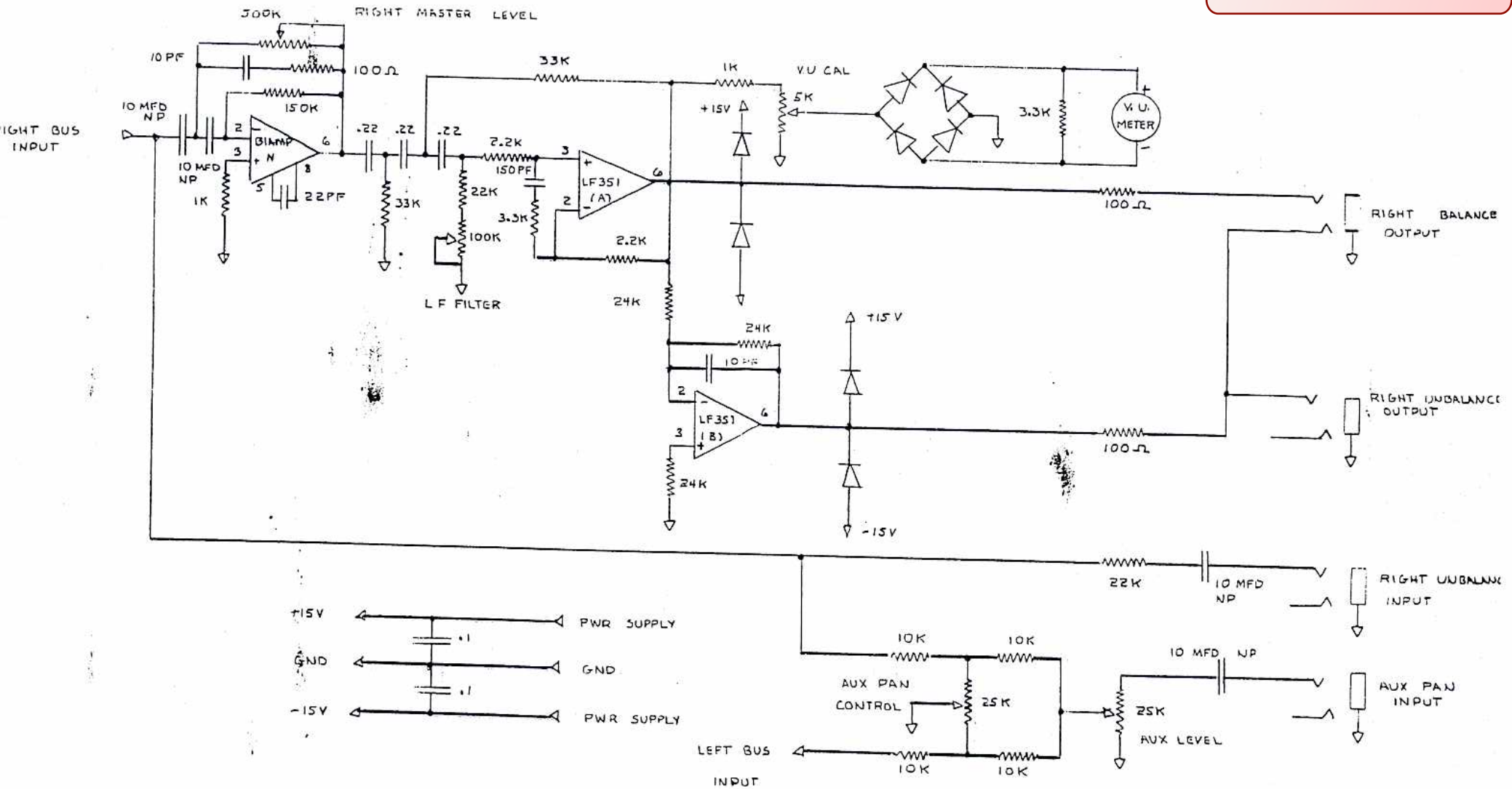

9802-1282 MIXER
RIGHT MIXER
REV B

CONFIDENTIAL

LOCATION CHART MONITOR POWER SUPPLY BOARD 8-12-CHAN MIXER

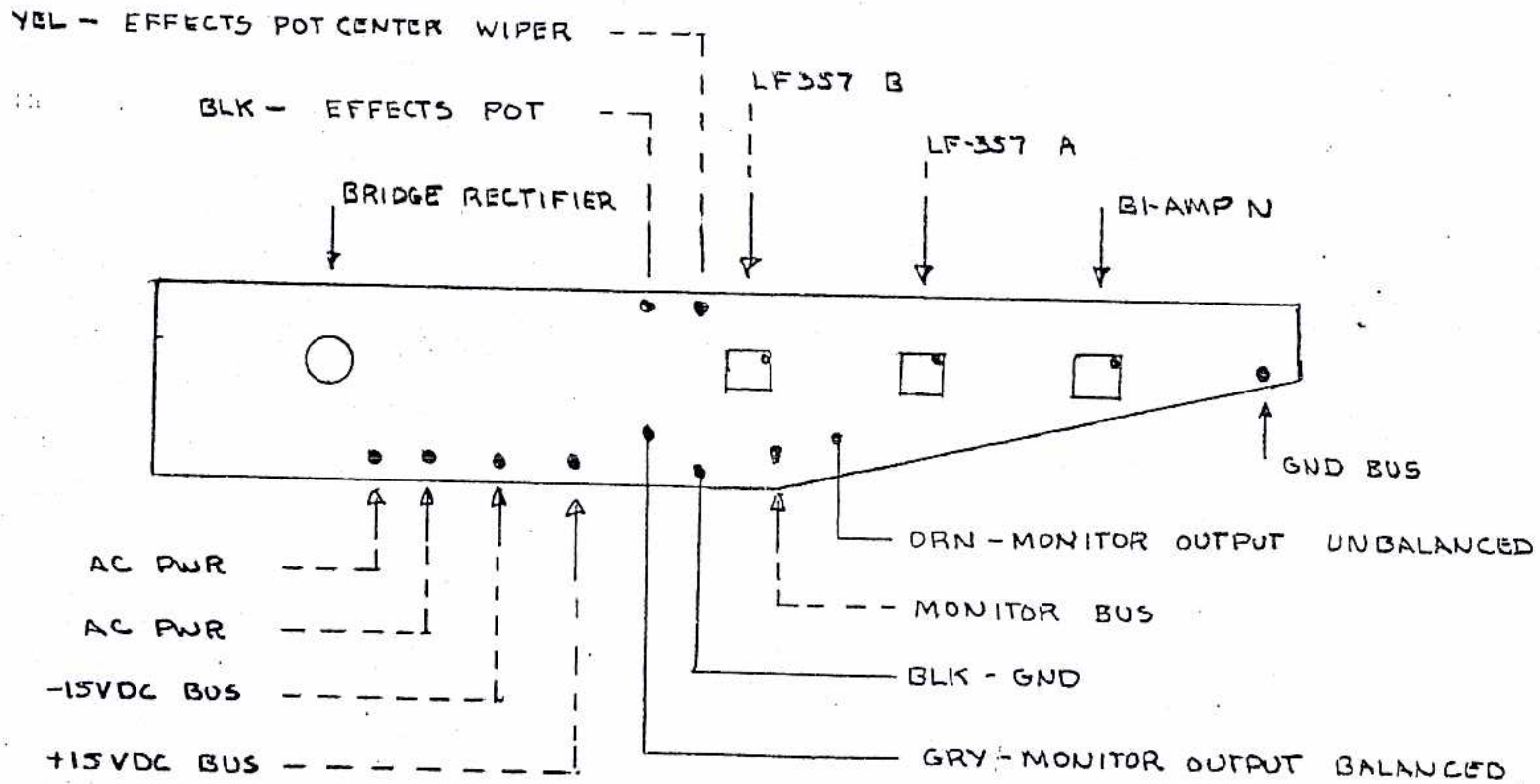

CONFIDENTIAL

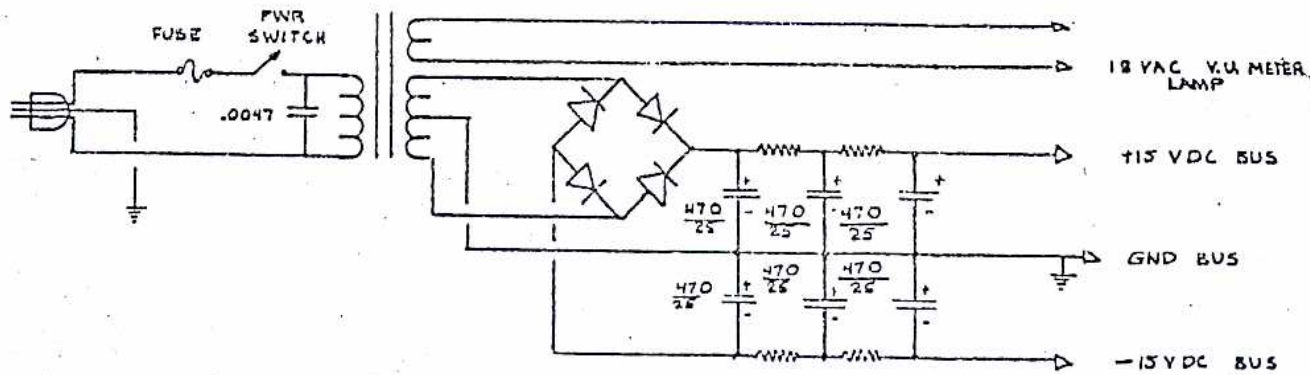
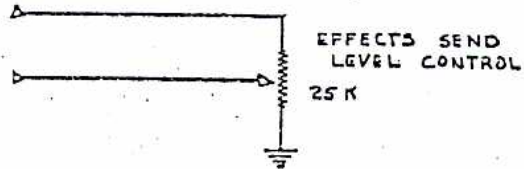
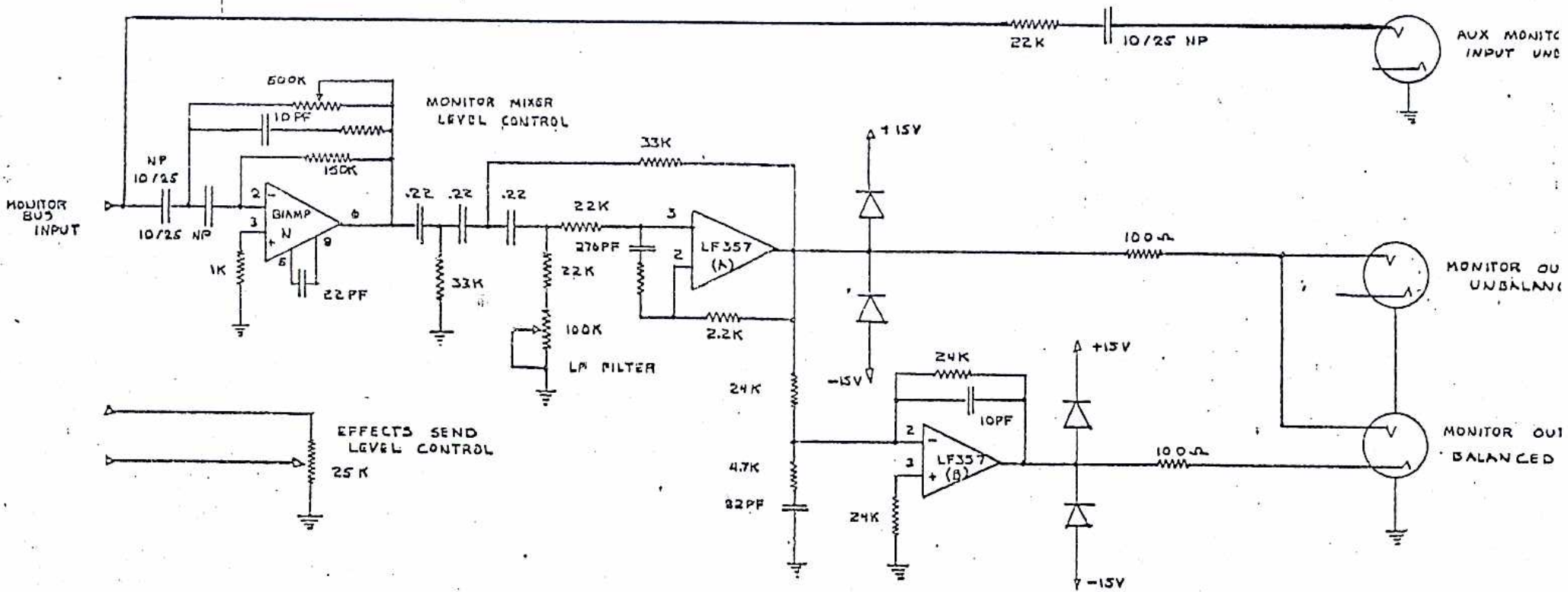

BROZ-1282 MIXER
MONITOR - PWR SUPPLY
REV A

CONFIDENTIAL

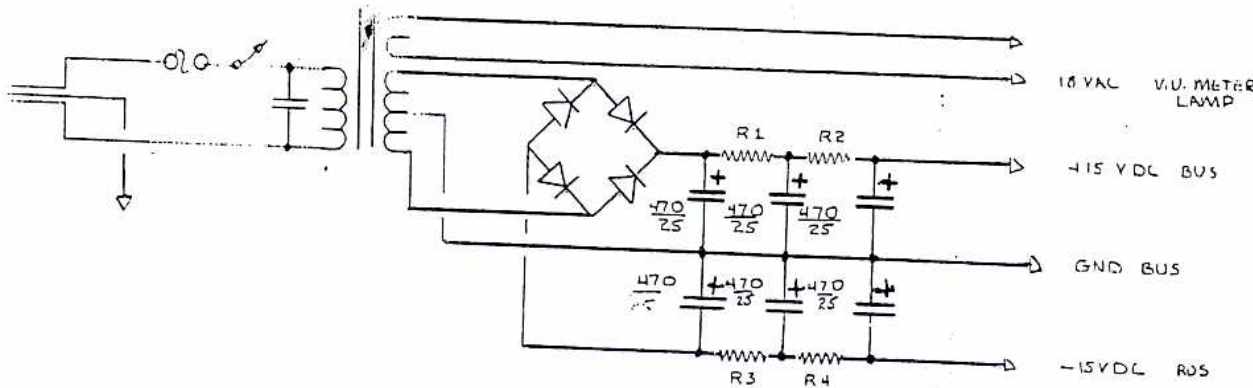
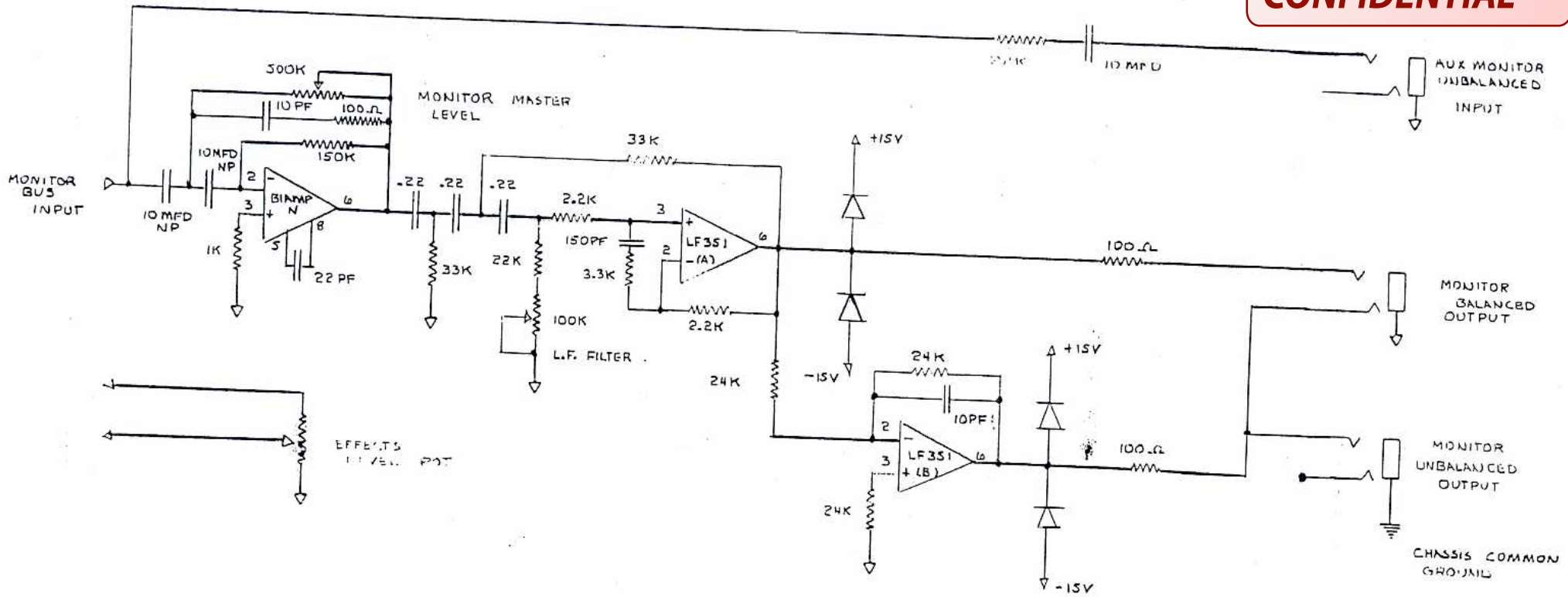

8802-1282 MIXER
MONITOR - PWR SUPPLY
REV-B

NOTE 1
1282 PWR SUPPLY
RESISTORS
R1 - R3 22Ω SW
R2 - R4 27Ω SW

NOTE 2
8802 PWR SUPPLY
RESISTORS
R1 - R3 33Ω SW
R2 - R4 31Ω SW