

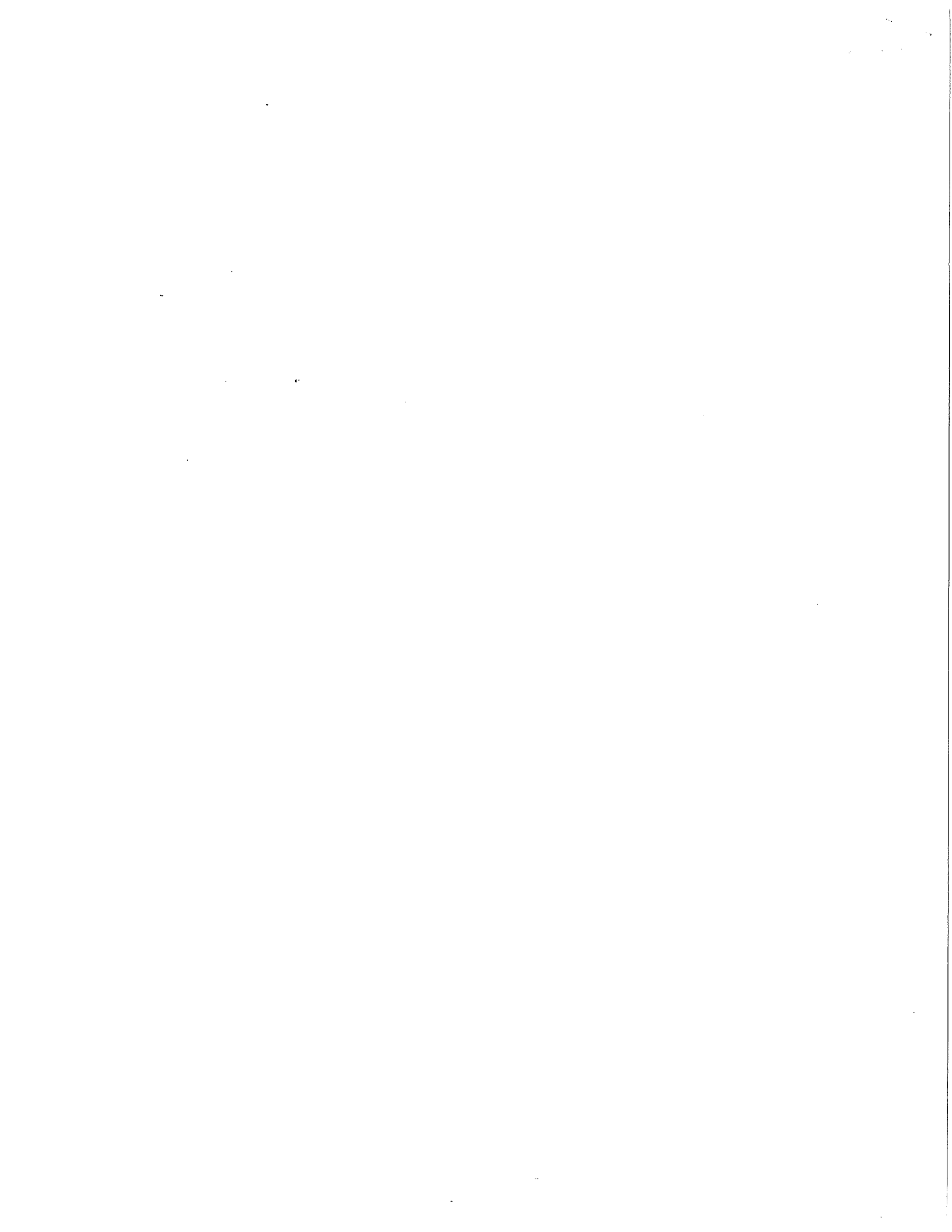

ADVANTAGE DDL11
SCHEMATICS





CLOCK OSCILLATOR

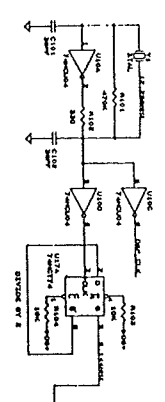

A/D CONVERTER

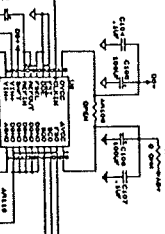

D/A CONVERTER

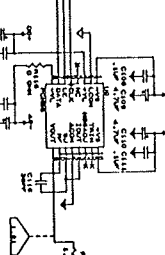

RECONSTRUCTION FILTER

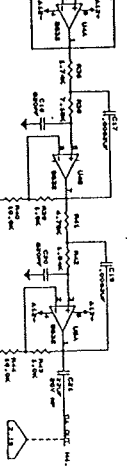

NOTE: DO NOT EXCEED 5V ON ANY INPUTS TO THE A/D CONVERTER.

NOTE: DO NOT EXCEED 5V ON ANY INPUTS TO THE D/A CONVERTER.

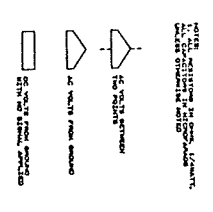
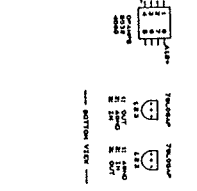
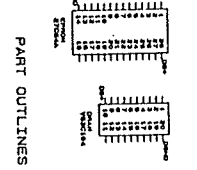
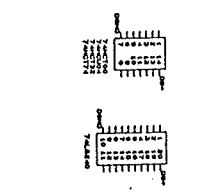
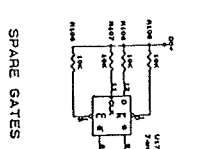
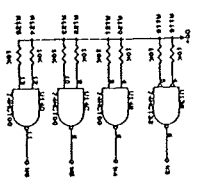
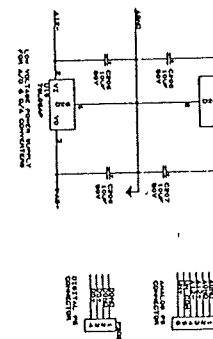
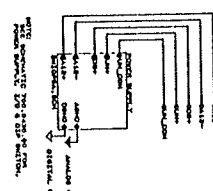
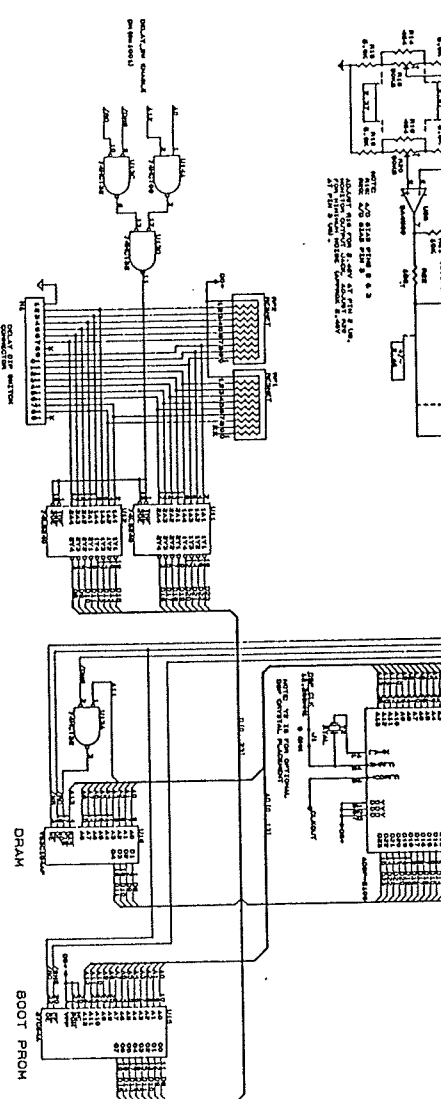
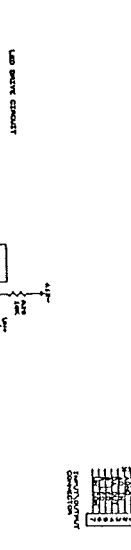
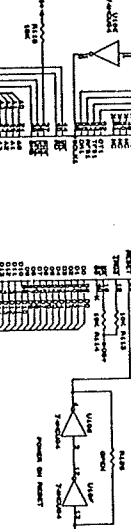
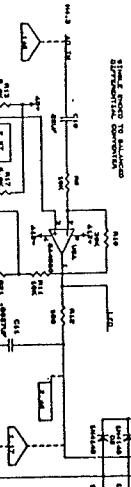

DESIGNED BY: J. L. COOPER	DATE: 1/15/84
CHECKED BY: J. L. COOPER	DATE: 1/15/84
DDL11 DSP PCB	
MULTI PROCESSOR & CONVERTER	
QUANTITY: 100	PRICE: \$700.0434.00

INPUT/OUTPUT

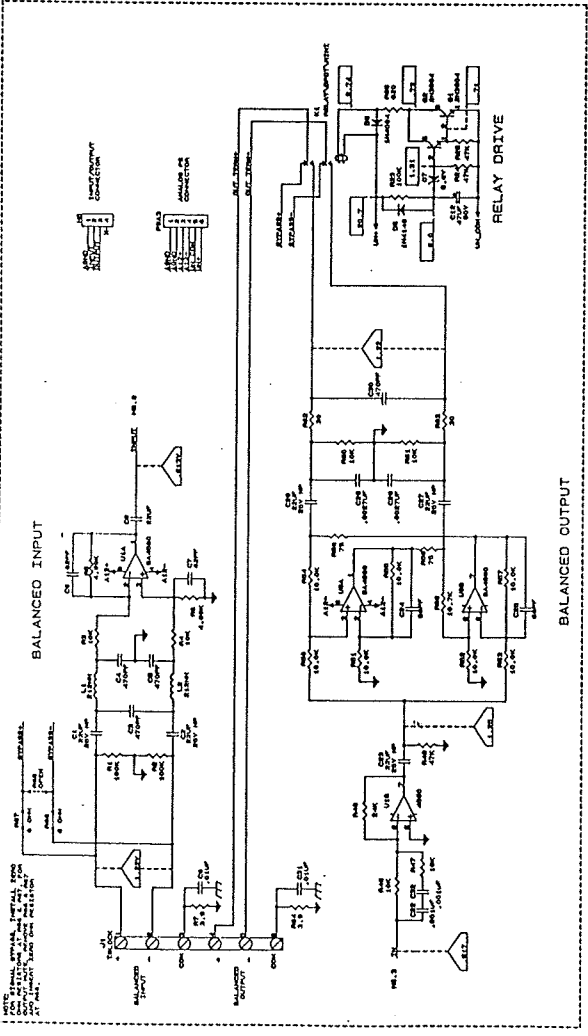

SWITCH - LEDS - VOLUME CONTROLS

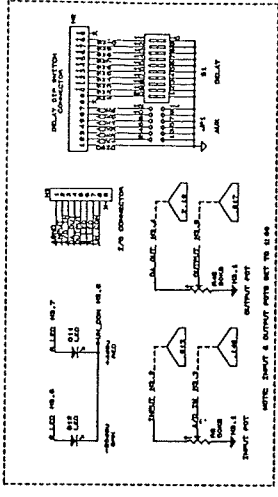

POWER SUPPLY

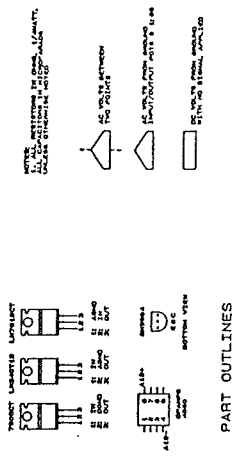
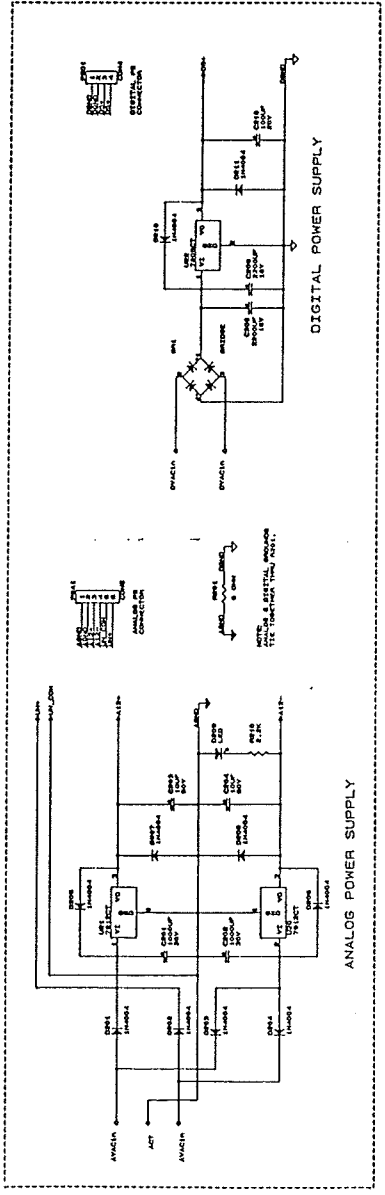

PART OUTLINES

DESIGNED BY:	DATE:	REV:	NO.
APPROVED BY:	DATE:	REV:	NO.
<p>DDLL11 SW/IO/PS PCB</p> <p>REVISED - SWITCH/OUTPUT CONTROLS - POWER SUPPLY</p>			
PRICE PER UNIT:	700.0435.00	REV:	A
DATE:	10/1983	SHEET:	1 OF 1

THIS DRAWING IS THE PROPERTY OF BIAAMP SYSTEMS, INC. IT IS TO BE USED ONLY FOR THE PROJECT AND QUANTITY SPECIFIED HEREON. IT IS NOT TO BE REPRODUCED, COPIED, OR TRANSMITTED IN ANY FORM OR BY ANY MEANS, ELECTRONIC OR MECHANICAL, INCLUDING PHOTOCOPYING, RECORDING, OR BY ANY INFORMATION STORAGE AND RETRIEVAL SYSTEM. WITHOUT THE WRITTEN PERMISSION OF BIAAMP SYSTEMS, INC.

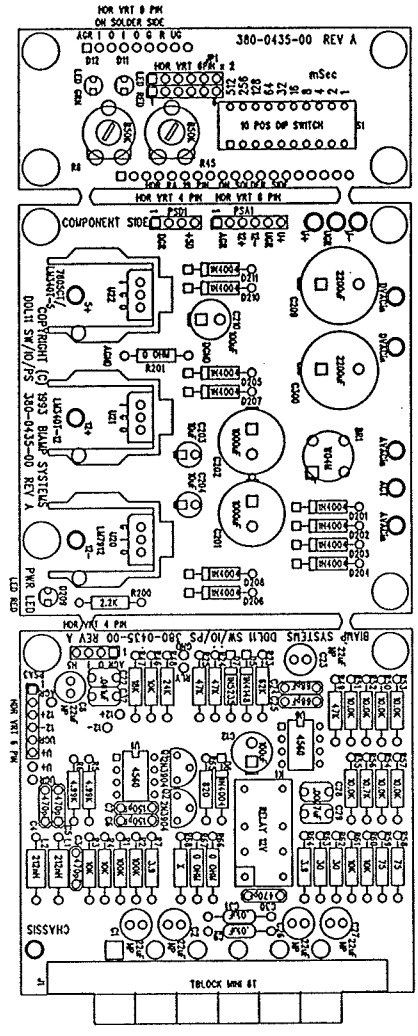

BIAAMP SYSTEMS
 14270 N.W. Science Park Drive
 Portland, Oregon 97229
 (503) 641-7287

DATE	REV	DESCRIPTION	BY	CHKD
07/23	01	INITIAL RELEASE	RC	RC
07/23	02	REVISION	RC	RC
07/23	03	REVISION	RC	RC
07/23	04	REVISION	RC	RC
07/23	05	REVISION	RC	RC
07/23	06	REVISION	RC	RC
07/23	07	REVISION	RC	RC
07/23	08	REVISION	RC	RC
07/23	09	REVISION	RC	RC
07/23	10	REVISION	RC	RC
07/23	11	REVISION	RC	RC
07/23	12	REVISION	RC	RC
07/23	13	REVISION	RC	RC
07/23	14	REVISION	RC	RC
07/23	15	REVISION	RC	RC
07/23	16	REVISION	RC	RC
07/23	17	REVISION	RC	RC
07/23	18	REVISION	RC	RC
07/23	19	REVISION	RC	RC
07/23	20	REVISION	RC	RC
07/23	21	REVISION	RC	RC
07/23	22	REVISION	RC	RC
07/23	23	REVISION	RC	RC
07/23	24	REVISION	RC	RC
07/23	25	REVISION	RC	RC
07/23	26	REVISION	RC	RC
07/23	27	REVISION	RC	RC
07/23	28	REVISION	RC	RC
07/23	29	REVISION	RC	RC
07/23	30	REVISION	RC	RC
07/23	31	REVISION	RC	RC
07/23	32	REVISION	RC	RC
07/23	33	REVISION	RC	RC
07/23	34	REVISION	RC	RC
07/23	35	REVISION	RC	RC
07/23	36	REVISION	RC	RC
07/23	37	REVISION	RC	RC
07/23	38	REVISION	RC	RC
07/23	39	REVISION	RC	RC
07/23	40	REVISION	RC	RC
07/23	41	REVISION	RC	RC
07/23	42	REVISION	RC	RC
07/23	43	REVISION	RC	RC
07/23	44	REVISION	RC	RC
07/23	45	REVISION	RC	RC
07/23	46	REVISION	RC	RC
07/23	47	REVISION	RC	RC
07/23	48	REVISION	RC	RC
07/23	49	REVISION	RC	RC
07/23	50	REVISION	RC	RC
07/23	51	REVISION	RC	RC
07/23	52	REVISION	RC	RC
07/23	53	REVISION	RC	RC
07/23	54	REVISION	RC	RC
07/23	55	REVISION	RC	RC
07/23	56	REVISION	RC	RC
07/23	57	REVISION	RC	RC
07/23	58	REVISION	RC	RC
07/23	59	REVISION	RC	RC
07/23	60	REVISION	RC	RC
07/23	61	REVISION	RC	RC
07/23	62	REVISION	RC	RC
07/23	63	REVISION	RC	RC
07/23	64	REVISION	RC	RC
07/23	65	REVISION	RC	RC
07/23	66	REVISION	RC	RC
07/23	67	REVISION	RC	RC
07/23	68	REVISION	RC	RC
07/23	69	REVISION	RC	RC
07/23	70	REVISION	RC	RC
07/23	71	REVISION	RC	RC
07/23	72	REVISION	RC	RC
07/23	73	REVISION	RC	RC
07/23	74	REVISION	RC	RC
07/23	75	REVISION	RC	RC
07/23	76	REVISION	RC	RC
07/23	77	REVISION	RC	RC
07/23	78	REVISION	RC	RC
07/23	79	REVISION	RC	RC
07/23	80	REVISION	RC	RC
07/23	81	REVISION	RC	RC
07/23	82	REVISION	RC	RC
07/23	83	REVISION	RC	RC
07/23	84	REVISION	RC	RC
07/23	85	REVISION	RC	RC
07/23	86	REVISION	RC	RC
07/23	87	REVISION	RC	RC
07/23	88	REVISION	RC	RC
07/23	89	REVISION	RC	RC
07/23	90	REVISION	RC	RC
07/23	91	REVISION	RC	RC
07/23	92	REVISION	RC	RC
07/23	93	REVISION	RC	RC
07/23	94	REVISION	RC	RC
07/23	95	REVISION	RC	RC
07/23	96	REVISION	RC	RC
07/23	97	REVISION	RC	RC
07/23	98	REVISION	RC	RC
07/23	99	REVISION	RC	RC
07/23	100	REVISION	RC	RC

REV	DATE	DESCRIPTION	BY	CHKD
A	13-11	RC	RC	RC

A R C N E C

