

## MÅLEBETINGELSER

Alle DC spændinger er målt i forhold til stel, med voltmeter med en indgangsmodstand på 11 Mohm.

Oscillogrammer og AC spændinger er målt i forhold til stel med oscilloskop eller voltmeter med en indgangsmodstand på 1 Mohm.

Spændinger uden parentes: Stilling gengive (333 Hz 25 mm/mm).

Spændinger i parentes: Stilling stop.

AC spændinger opgivet i millivolt (mV). Eks. 733 mV.

DC spændinger opgivet i volt (V). Eks. 0,7 V.

Signalvejen i optage position er vist i højre kanal, og gengive position er vist i venstre kanal.

## MEASURING CONDITIONS

All DC voltages have been measured in relation to ground with voltmeter with an input resistance of 11 Mohms.

Oscillograms and AC voltages have been measured in relation to ground with oscilloscope or voltmeter with an input resistance of 1 Mohm.

Unbracketed voltages: Position play back (333 Hz 25 mm/mm).

Bracketed voltages: Position stop.

AC voltages stated in millivolts (mV). Ex.: 733 mV.

DC voltages stated in volts (V). Ex.: 0.7 V.

The signal path in recording pos. is shown in right channel, and replay position is shown in left channel.

## MESSBEDINGUNGEN

Alle DC Spannungen sind im Verhältnis zu Masse gemessen worden, mit Voltmeter mit einem Eingangswiderstand von 11 Mohm.

Oszillogramme und AC Spannungen sind im Verhältnis zu Masse gemessen worden, mit Oszilloskop oder Voltmeter mit einem Eingangswiderstand von 1 Mohm.

Spannungen ohne Klammern: Position Wiedergabe (333 Hz 25 mm/mm).

Spannungen in Klammern: Position Stop.

AC Spannungen in Millivolt (mV) aufgegeben, z. B.: 733 mV.

DC Spannungen in Volt (V) aufgegeben, z. B.: 0,7 V.

Der Signalweg in Aufnahme position ist in rechten Kanal gezeigt, und die Wiedergabeposition ist in linkem Kanal gezeigt.

## SYMBOLER

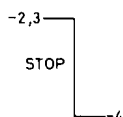

Dette symbol betyder at spændingen springer fra  $-2,3$  V til  $-4$  V når STOP aktiveres.

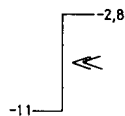

Dette symbol betyder at spændingen springer fra  $-11$  V til  $-2,8$  V når  $\ll$  aktiveres.

## SYMBOLS

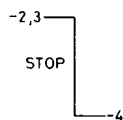

This symbol indicates that the voltage goes from  $-2,3$  V to  $-4$  V when activating panel switch STOP.

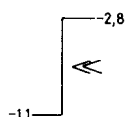

This symbol indicates that the voltage goes from  $-11$  V to  $-2,8$  V when activating panel switch  $\ll$ .

## SYMBOLE

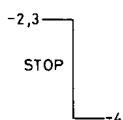

Dieses Symbol bedeutet, dass die Spannung von  $-2,3$  Volt auf  $-4$  Volt springt, wenn den Panelkontakt STOP aktiviert wird.

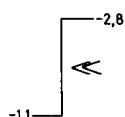

Dieses Symbol bedeutet, dass die Spannung von  $-11$  Volt auf  $-2,8$  Volt springt, wenn den Panelkontakt  $\ll$  aktiviert wird.

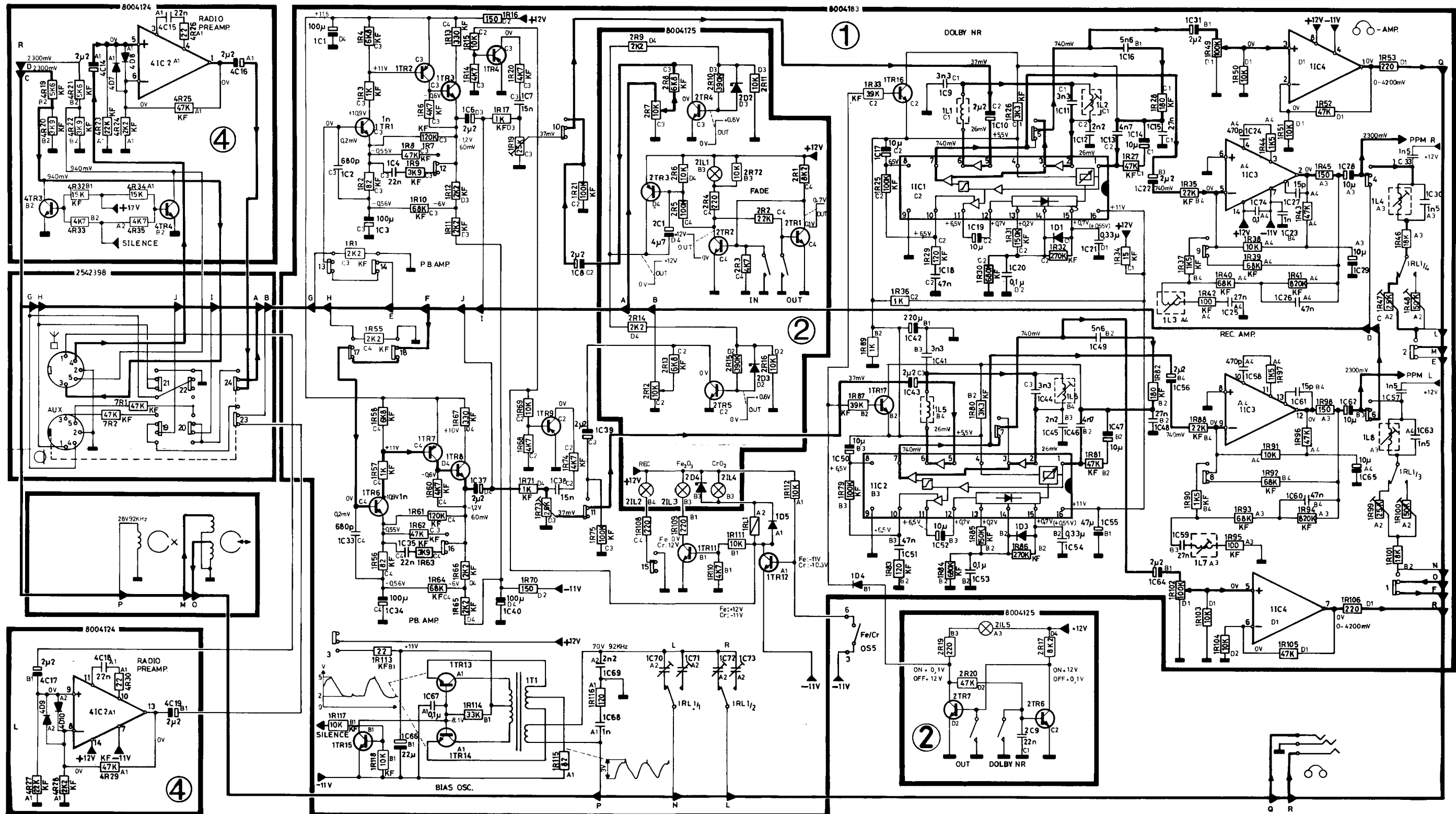

NOISE REDUCTION CIRCUIT  
MADE UNDER LICENSE FROM  
DOLBY LABORATORIES INC.

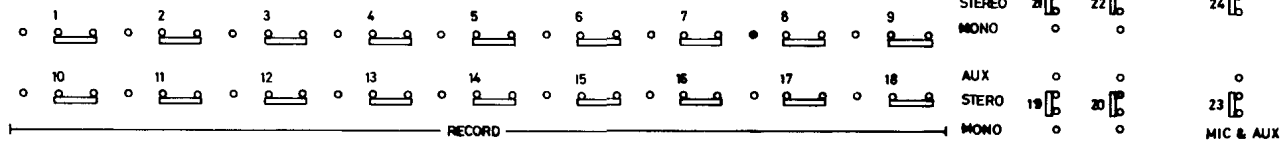

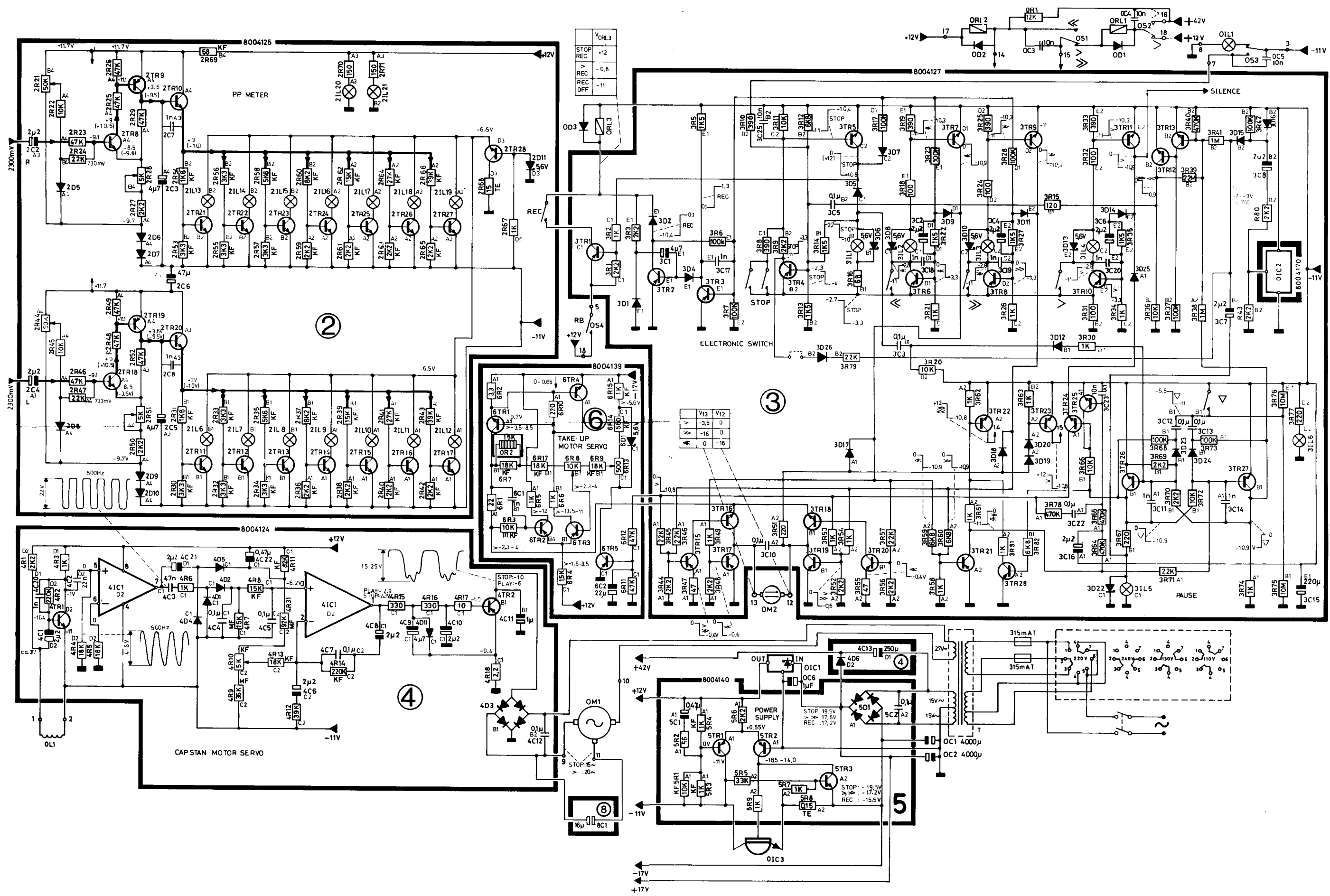

# Bang & Olufsen

## TRANSISTOR AND IC LIST

01C1 8340049 **108** LM 340T-12  
**108** 7812 CU  
PA 7812/C

01C2 8340111 **112** ULN 3020T

01C3 8340137 **43** BD 897

1TR1 8320344 **20** BC 550 B  
**20** BC 384 B-N

1TR2 8320069 **18** BC 559 B  
**18** BC 214 B

1TR3 8320097 **18** BC 547 B  
**18** BC 182 B  
**18** BC 237 B

1TR4 8320104 **18** BC 558 B  
**18** BC 213 B  
**18** BC 308 B  
**18** BC 252 B

1TR6 8320344 **20** BC 550 B  
**20** BC 384 B-N

1TR7 8320069 **18** BC 559 B  
**18** BC 214 B

1TR8 8320097 **18** BC 547 B  
**18** BC 182 B  
**18** BC 237 B

1TR9 8320104 **18** BC 558 B  
**18** BC 213 B  
**18** BC 308 B  
**18** BC 252 B

1TR11 8320108 **18** BC 548 B  
1TR12 **18** BC 183 B  
**18** BC 238 B  
**18** BC 172 B

1TR13 8320097 **18** BC 547 B  
1TR14 **18** BC 182 B  
**18** BC 237 B

1TR15 8320108 **18** BC 548 B  
**18** BC 183 B  
**18** BC 238 B  
**18** BC 172 B

1TR16 8320329 **20** BC 338  
1TR17

11C1 8340046 **101** NE 545

11C2

11C3 8340072 **102** MC 1437 P

11C4 8340048 **103** MC 1458 CP  
**103** SN 72558 P

2TR1 8320108 **18** BC 548 B

2TR2 **18** BC 183 B

**18** BC 238 B

**18** BC 172 B

2TR3 8320104 **18** BC 558 B

**18** BC 213 B

**18** BC 308 B

**18** BC 252 B

2TR4 8320108 **18** BC 548 B

2TR5 **18** BC 183 B

2TR6 **18** BC 238 B

2TR7 **18** BC 172 B

2TR8 8320097 **18** BC 547 B

**18** BC 182 B

**18** BC 237 B

2TR9 8320202 **18** BC 557 A

**18** BC 212 A

**18** BC 307 A

**18** BC 251 A

2TR10 8320097 **18** BC 547 B

**18** BC 182 B

**18** BC 238 B

**18** BC 172 B

2TR11 8320108 **18** BC 548 B

2TR12 **18** BC 183 B

2TR13 **18** BC 238 B

2TR14 **18** BC 172 B

2TR15

2TR16

2TR17

2TR18 8320097 **18** BC 547 B

**18** BC 182 B

**18** BC 238 B

**18** BC 172 B

2TR19 8320202 **18** BC 557 A

**18** BC 212 A

**18** BC 307 A

**18** BC 251 A

2TR20 8320097 **18** BC 547 B

**18** BC 182 B

**18** BC 238 B

**18** BC 172 B

2TR21 8320108 **18** BC 548 B

2TR22 **18** BC 183 B

2TR23 **18** BC 238 B

2TR24 **18** BC 172 B

2TR25

2TR26

2TR27

2TR28 8320225 **10** BC 140

Group 10

3TR1 8320331 **20** BC 328-25

3TR2

3TR3 8320104 **18** BC 558 B

3TR4 **18** BC 213 B

**18** BC 308 B

**18** BC 252 B

3TR5 8320108 **18** BC 548 B

**18** BC 183 B

**18** BC 238 B

**18** BC 172 B

3TR6 8320104 **18** BC 558 B

**18** BC 213 B

**18** BC 308 B

**18** BC 252 B

3TR7 8320108 **18** BC 548 B

**18** BC 183 B

**18** BC 238 B

**18** BC 172 B

3TR8 8320104 **18** BC 558 B

**18** BC 213 B

**18** BC 308 B

**18** BC 172 B

3TR9 8320108 **18** BC 548 B

**18** BC 183 B

**18** BC 238 B

**18** BC 172 B

3TR10 8320104 **18** BC 558 B

**18** BC 213 B

**18** BC 308 B

**18** BC 252 B

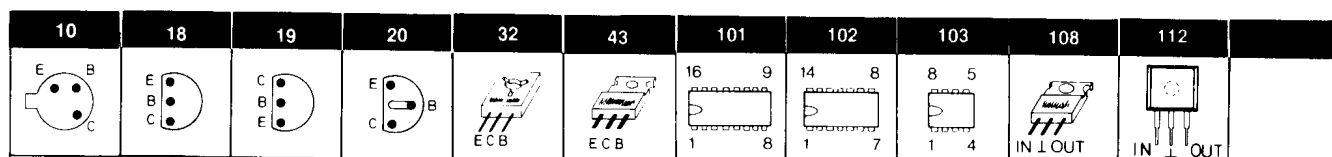

3TR11	8320108	18	BC 548 B
3TR12		18	BC 183 B
3TR13		18	BC 238 B
		18	BC 172 B
3TR15	8320202	18	BC 557 A
		18	BC 212 A
		18	BC 307 A
		18	BC 251 A
3TR16	8320329	20	BC 338-25
3TR17	8320331	20	BC 328-25
3TR18	8320329	20	BC 338-25
3TR19	8320331	20	BC 328-25
3TR20	8320202	18	BC 557 B
3TR21		18	BC 212 B
		18	BC 307 B
		18	BC 251 B
3TR22	8320329	20	BC 338-25
3TR23	8320374	32	BD 230
3TR24	8320108	18	BC 548 B
3TR25		18	BC 183 B
3TR26		18	BC 238 B
3TR27		18	BC 172 B
3TR28	8320202	18	BC 557 A
		18	BC 212 A
		18	BC 307 A
		18	BC 251 A
4TR1	8320097	18	BC 547 B
		18	BC 182 B
		18	BC 237 B

4TR2	8320269	32	BD 236 B
		32	BD 178
4TR3	8320108	18	BC 548 B
4TR4		18	BC 183 B
		18	BC 238 B
		18	BC 172 B
4IC1	8340048	103	SN 72558P
		103	MC 1458CP
4IC2	8340047	102	SN 7613IN
		102	TBA 231
5TR1	8320104	18	BC 558 B
5TR2		18	BC 213 B
		18	BC 308 B
		18	BC 172 B
5TR3	8320108	18	BC 548 B
		18	BC 183 B
		18	BC 238 B
		18	BC 172 B
6TR1	8320239	32	BD 135
		32	BD 135/W
6TR2	8320398	19	BC 558 C
6TR3		19	BC 252 C
6TR4	8320108	18	BC 548 B
		18	BC 183 B
		18	BC 238 B
		18	BC 172 B
6TR5	8320398	19	BC 558 C
		19	BC 252 C

## DIODE LIST

0D1 - 0D3	8300023	1N 4002
1D1	8300042	OA 91
1D3		
1D4 - 1D5	8300058	1N 4148
		SFD 184
2D2 - 2D3	8300036	ZPD 4,7 V
		BZX 79 4,7 V
		BZX 83 4,7 V
2D4	8300128	ZPD 5,6 V
2D11		BZX 79 5,6 V
		BZX 83 5,6 V
2D5 - 2D10	8300058	1N 4148
		SFD 184
3D1	8300058	1N 4148
3D4 - 3D5		SFD 184
3D7		
3D9		
3D11 - 3D12		
3D14 - 3D20		
3D23 - 3D26		
3D2	8300023	1N 4002
3D6	8300128	ZPD 5,6 V
3D8		BZX 79 5,6 V
3D10		BZX 83 5,6 V
3D13		
3D22		
4D1 - 4D2	8300058	1N 4148
4D4 - 4D5		SFD 184
4D3	8300155	B40C800
4D6	8300023	1N 4002
4D7 - 4D11	8300058	1N 4148
		SFD 184
5D1	8310020	B80C2200
6D1	8300128	ZPD 5,6 V
		BZX 79 5,6 V
		BZX 83 5,6 V

## CORRECTION

A	CORR. MADE IN DIAG.	BEFORE CORRECTION	AFTER CORRECTION
2R20	1	4K7	47K
2R17	1	1 K	8K2
2R18	1	470Ω	2C9 - 22 N
4R32	1	10 K	15 K
4R34	1	10 K	15 K
1R1/			
1R55	1		Moved
4R19	1	56 K	5K6
4R20	1	39 K	3K9
4R21	1	56 K	5K6
4R22	1	39 K	3K9
1C33	1		Added
1C57	1		Added
4D11	2		Added