

Bang & Olufsen



BEOCORD 6000

Type 4831-4832-4833
4834-4835-4836-4837

BEOCORD 8002

Type 4841-4842-4843
4844-4845-4846-4847

BEOCORD 6002

Type 4851-4852-4853-
4854-4855-4856-4857

BEOCORD 8004

Type 4861-4862-4863
4864-4865-4866-4867

MANUEL d'ENTRETIEN



Bang & Olufsen

DIAGRAM 1 FOR BECORD 6000

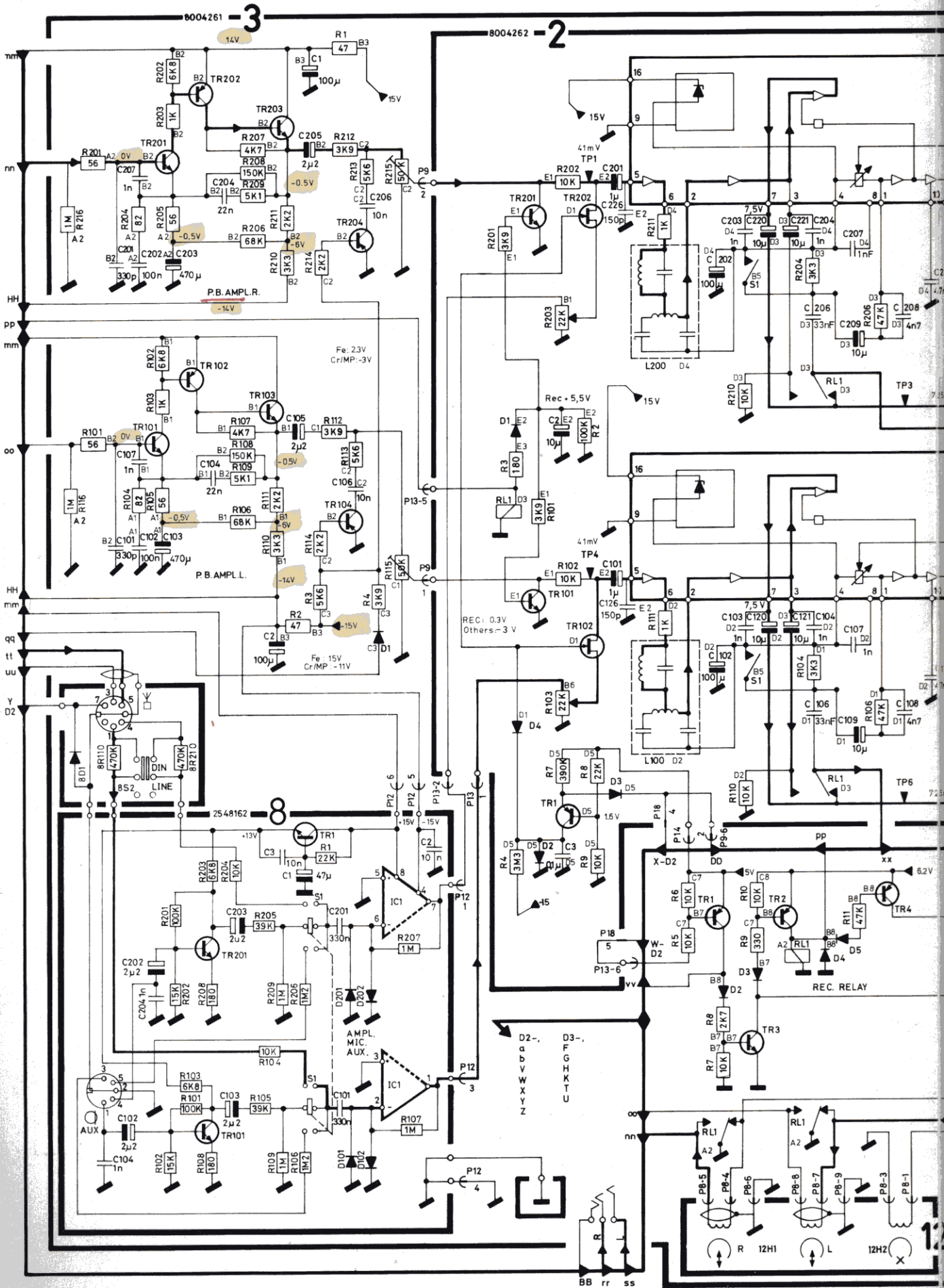

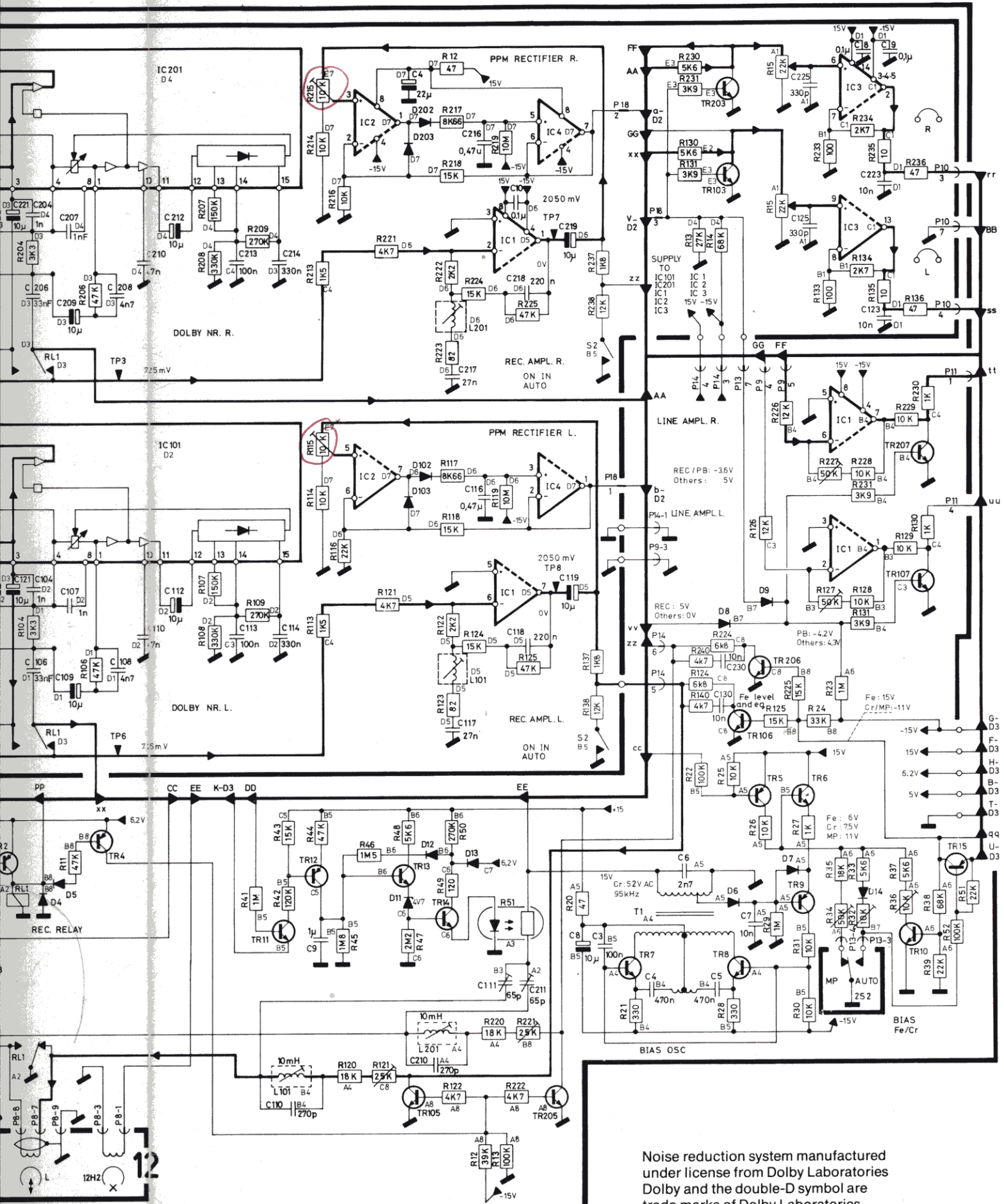

Noise reduction system manufactured under license from Dolby Laboratories. Dolby and the double-D symbol are trade marks of Dolby Laboratories.

DIAGRAM 2 FOR BEOCORD 6000

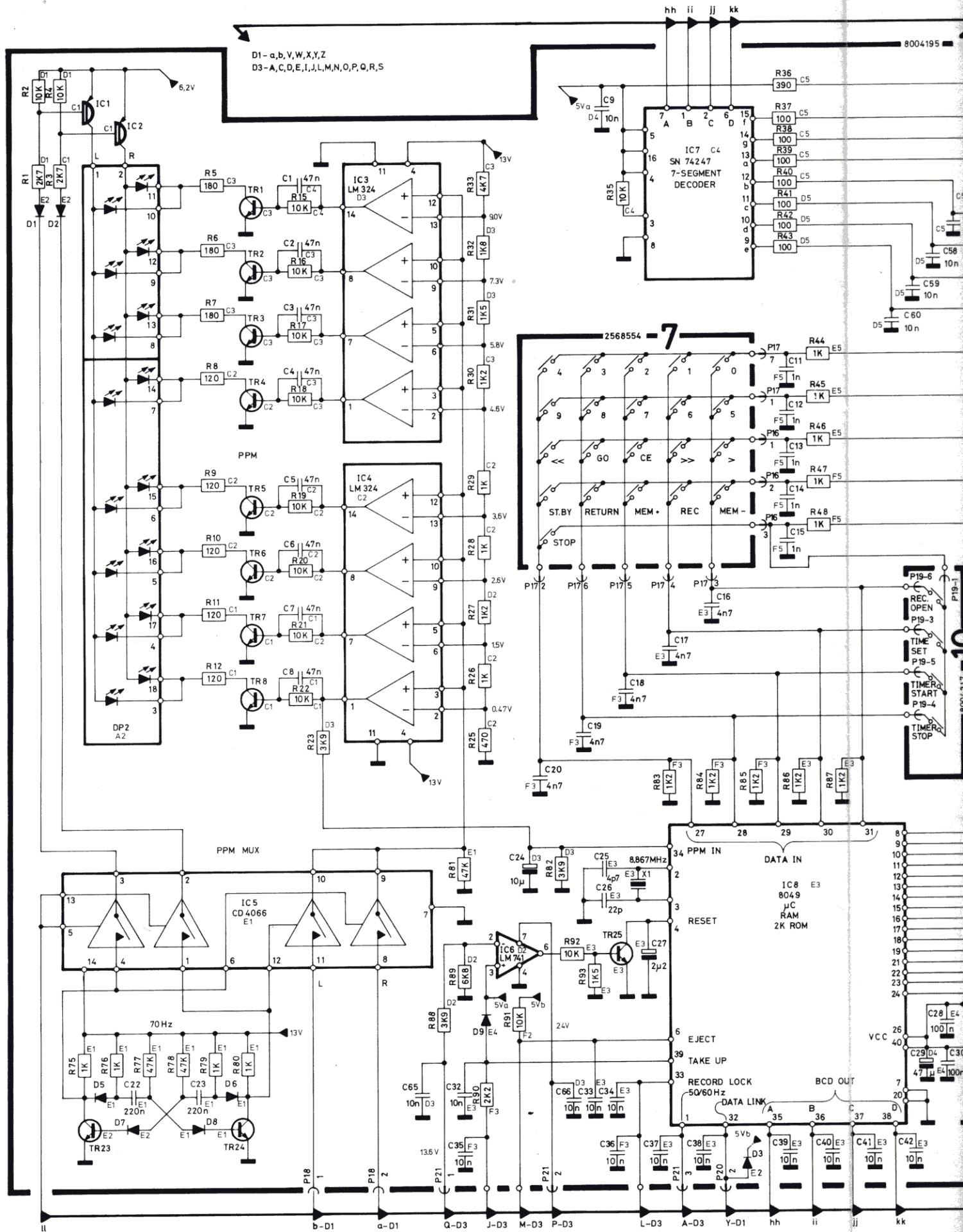

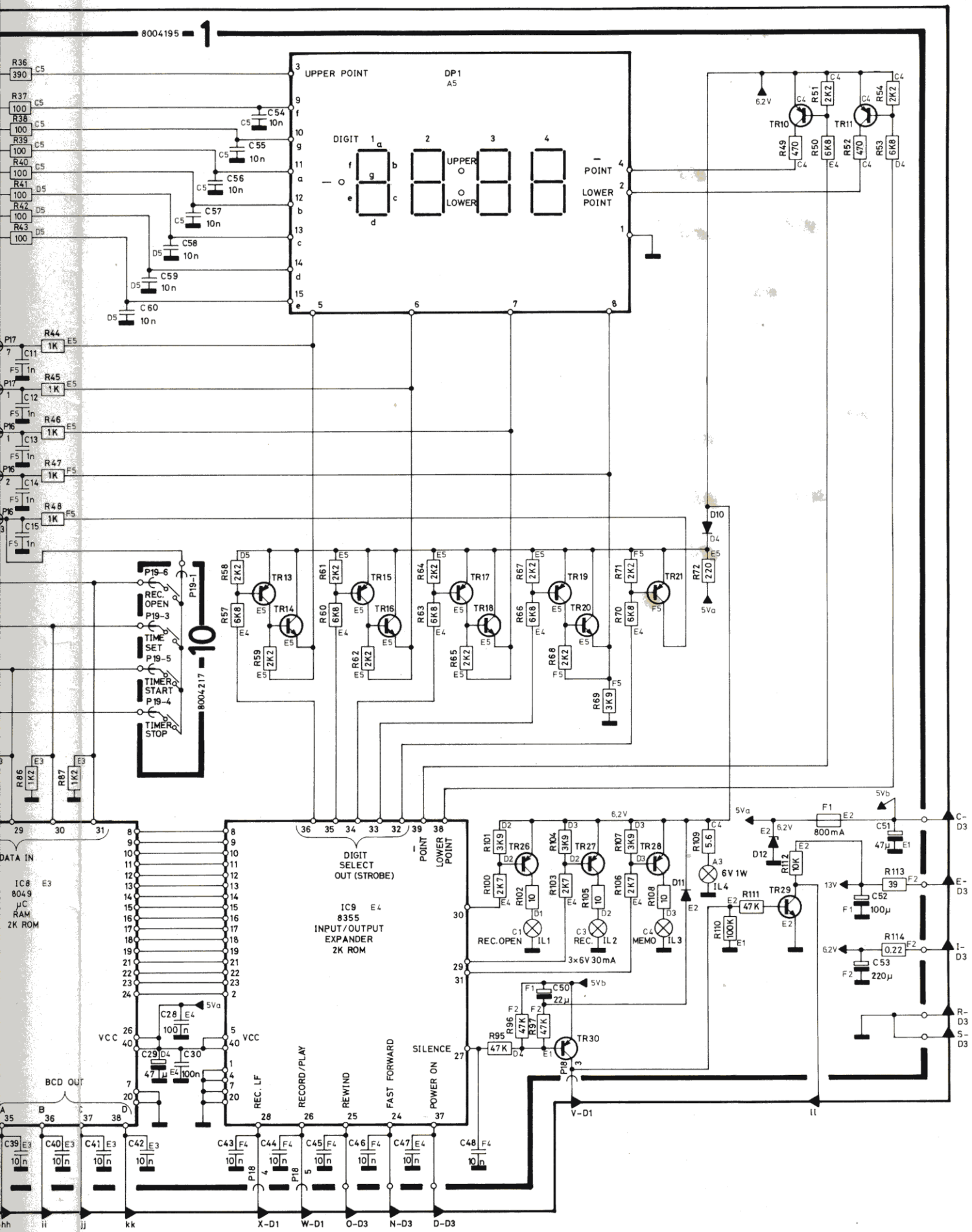
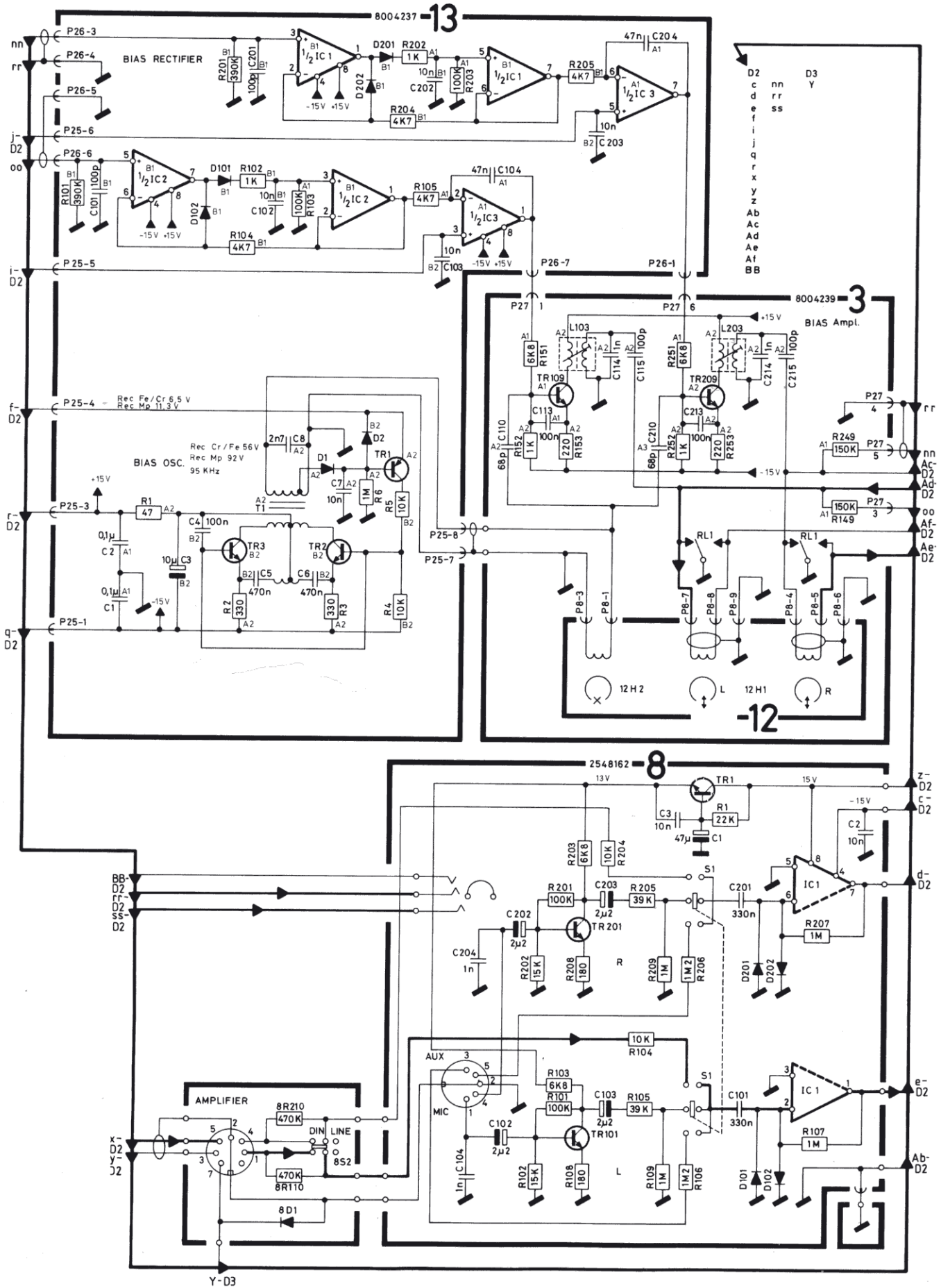
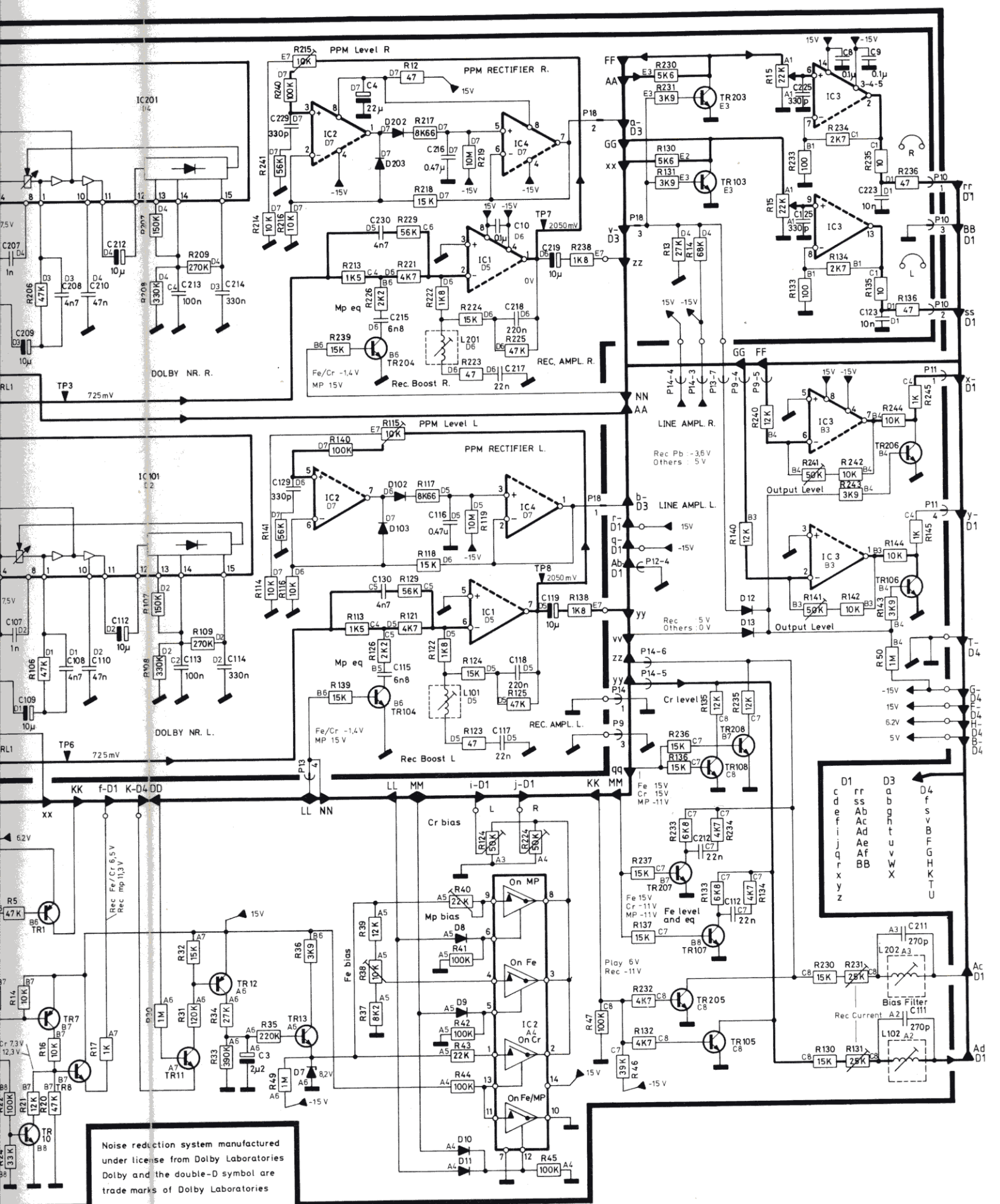

DIAGRAM 1 FOR BECORD 8002





Noise reduction system manufactured under license from Dolby Laboratories. Dolby and the double-D symbol are trade marks of Dolby Laboratories.

D1	rr	D3	d4
c	ss	a	o
d	bb	b	g
e	ac	c	h
f	ad	d	t
i	ae	e	v
j	af	f	h
q	bb	g	t
r		h	u
x		i	v
y		j	w
z		k	x
		l	y
		m	z
		n	
		o	
		p	
		q	
		r	
		s	
		t	
		u	
		v	
		w	
		x	
		y	
		z	

DIAGRAM 3 FOR BEOCORD 8002

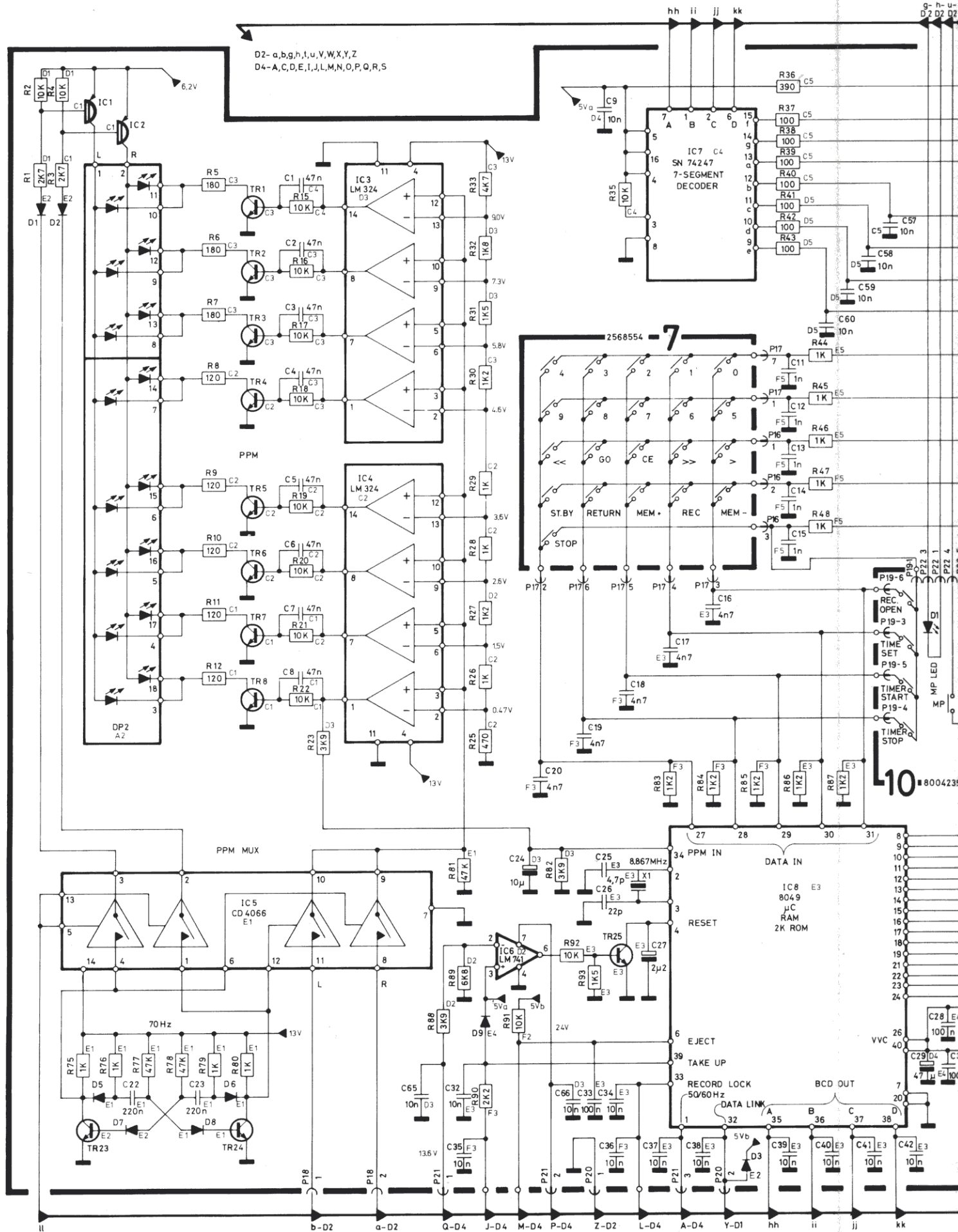

10-8004235

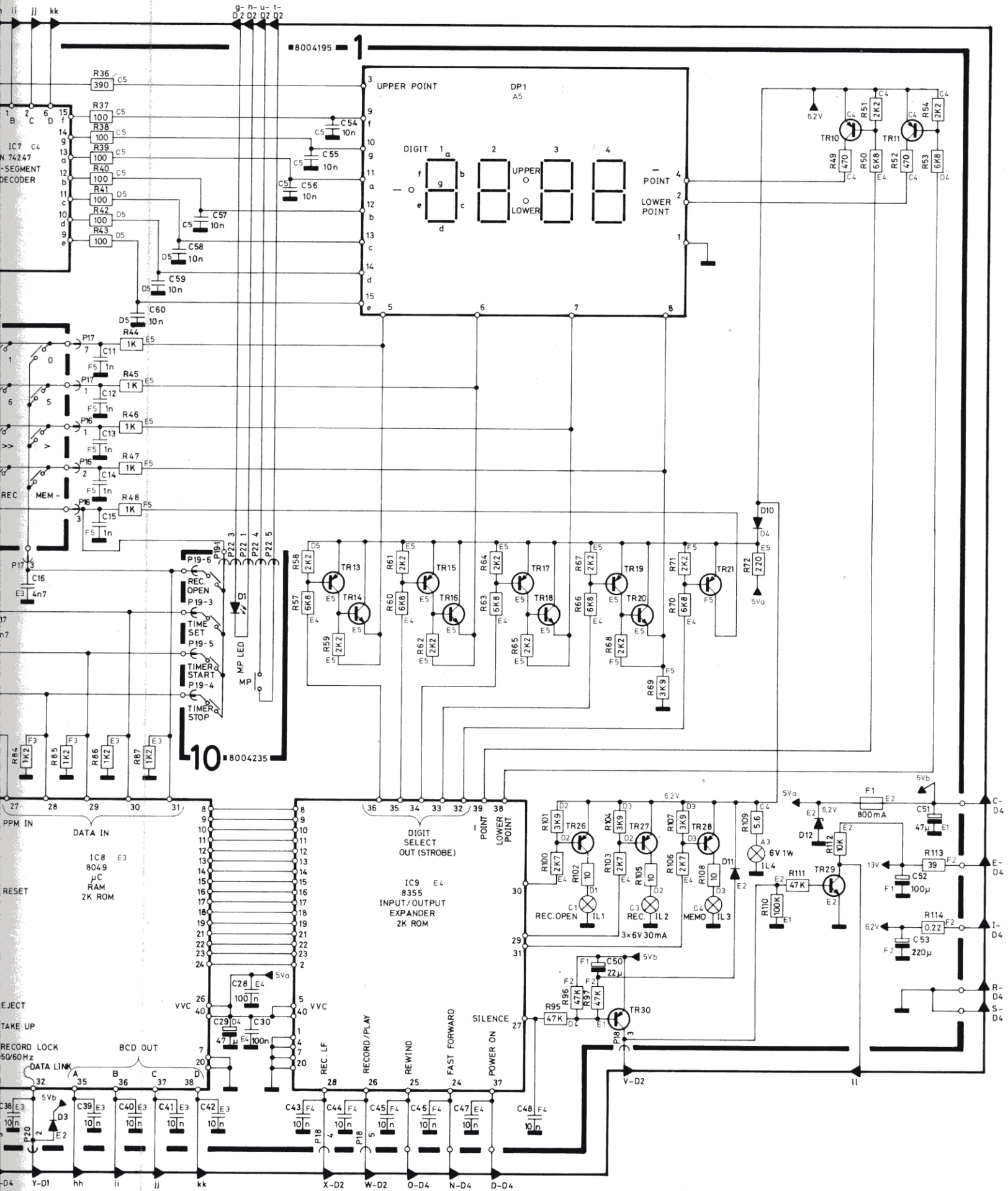
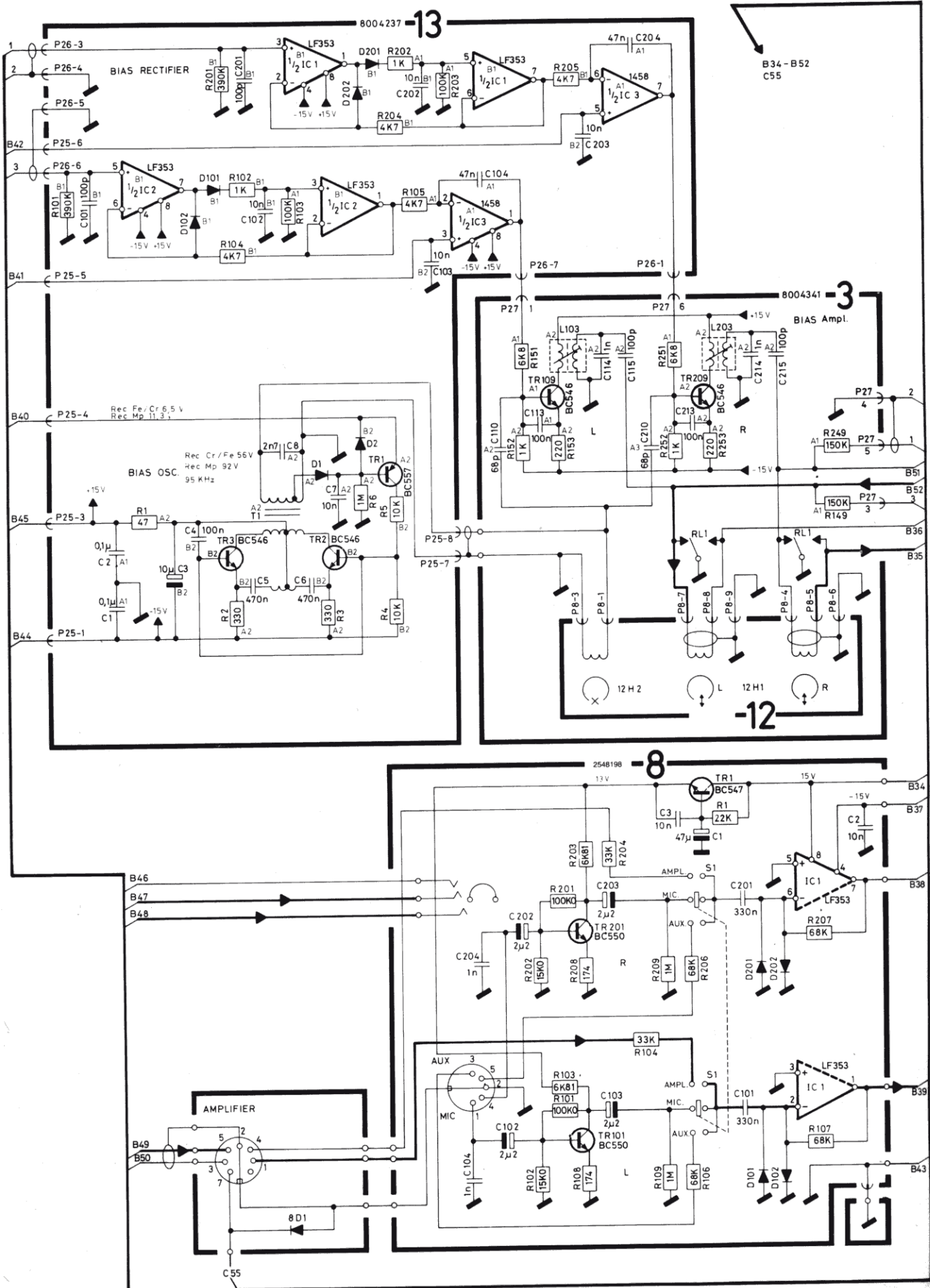
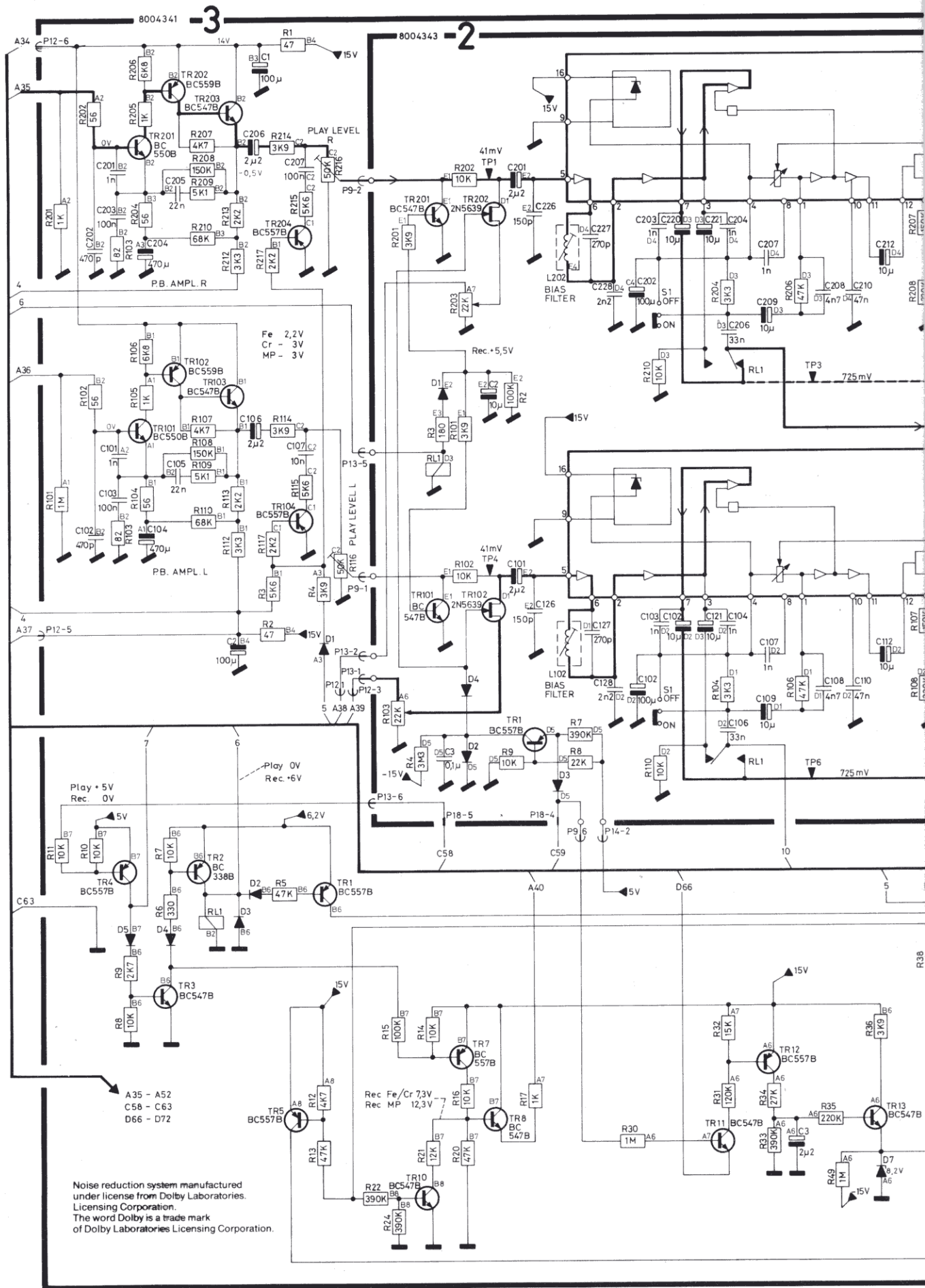

DIAGRAM A FOR BECORD 6002



Bang & Olufsen

DIAGRAM B FOR BEOCORD 6002



Noise reduction system manufactured under license from Dolby Laboratories Licensing Corporation. The word Dolby is a trademark of Dolby Laboratories Licensing Corporation.

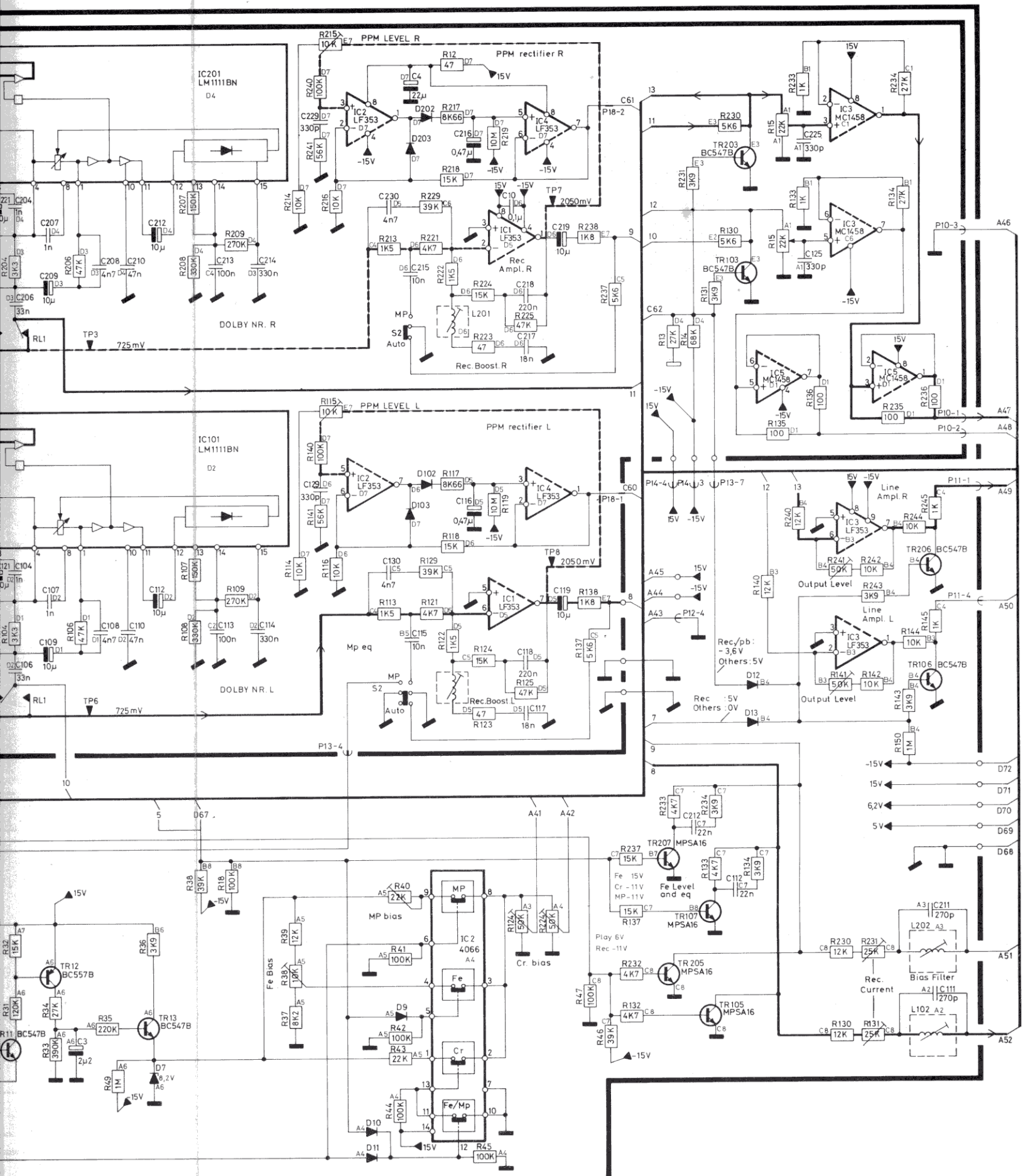
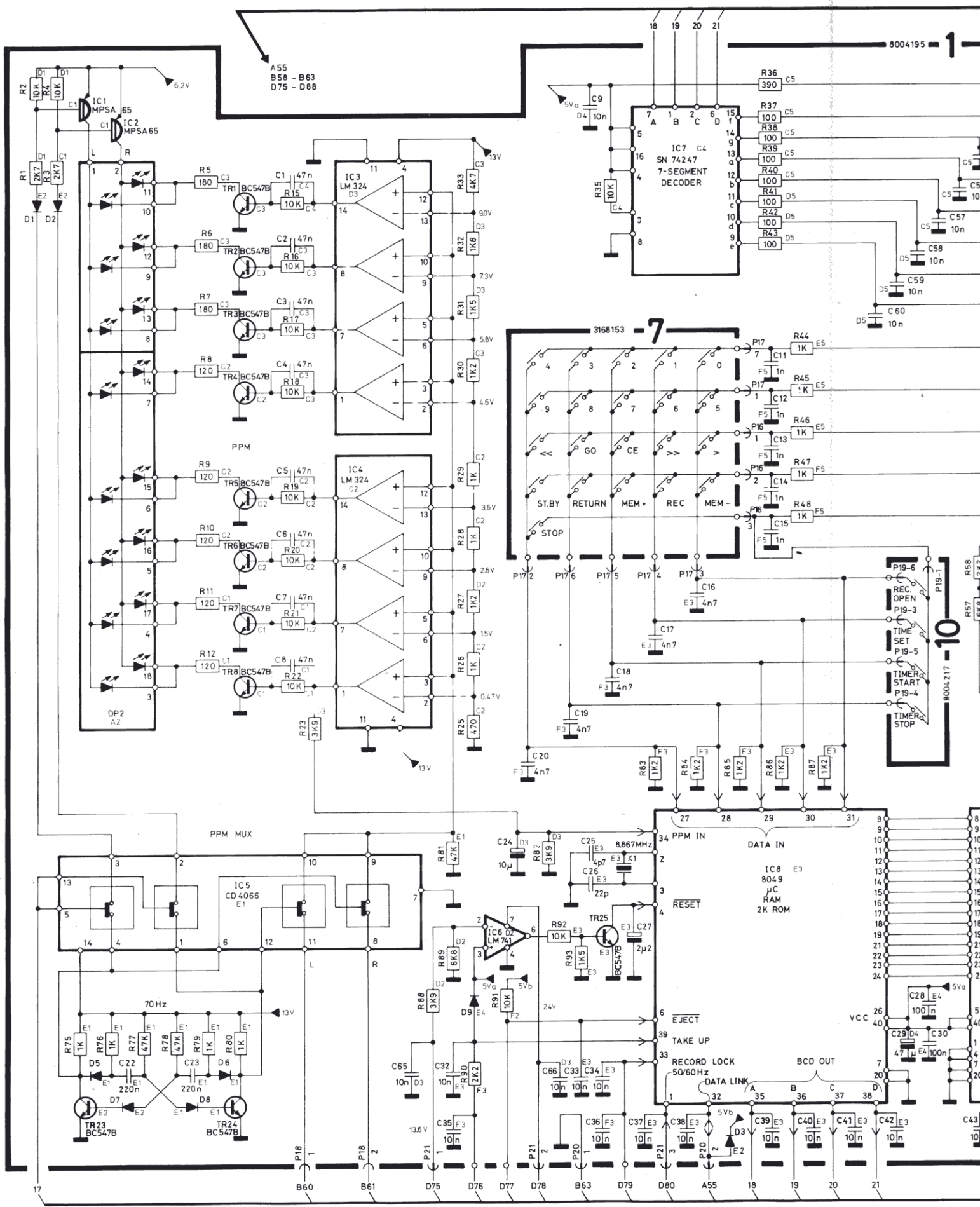
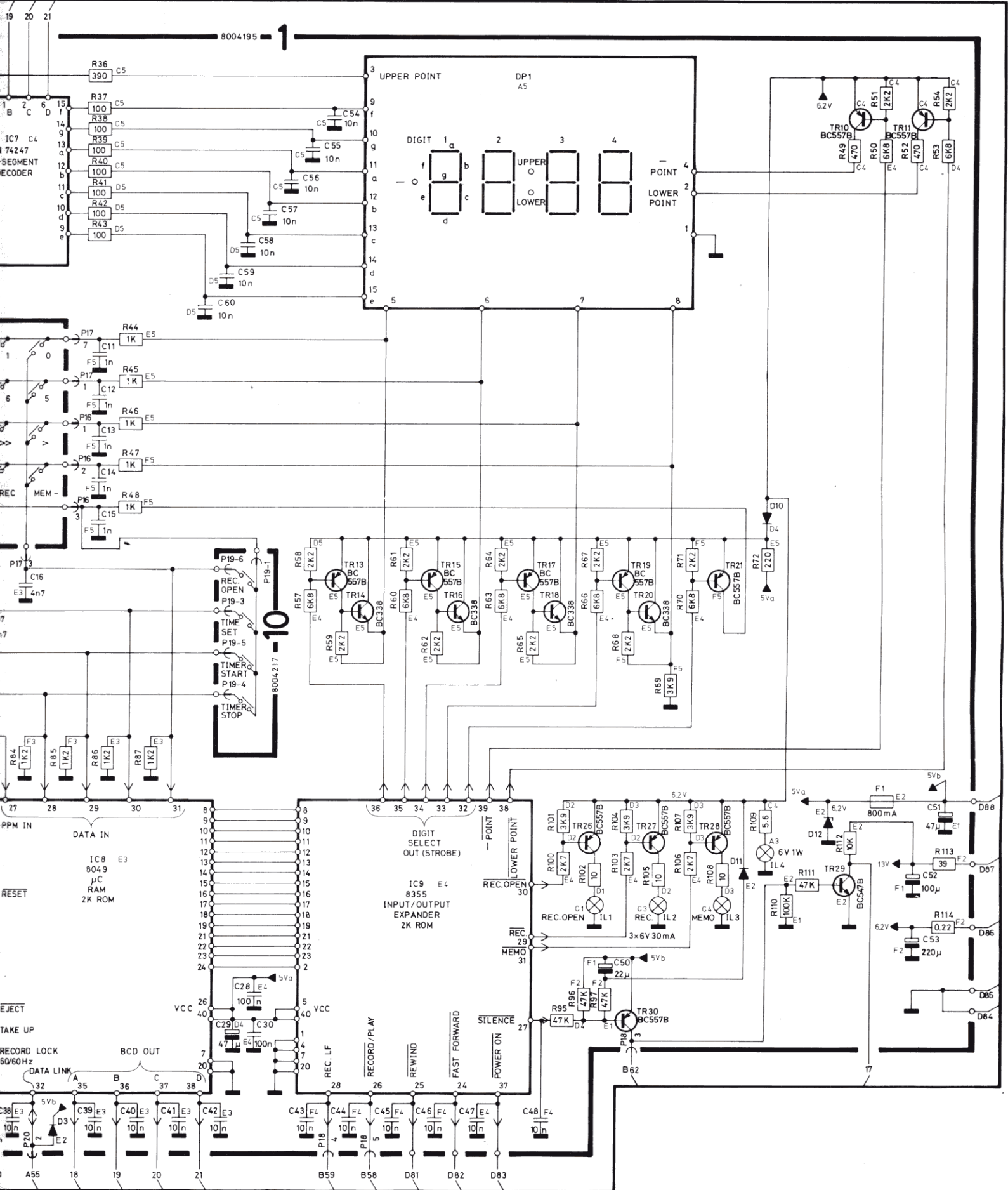

DIAGRAM C FOR BEOCORD 6002





Bang & Olufsen

DIAGRAM D FOR BEOCORD 6002

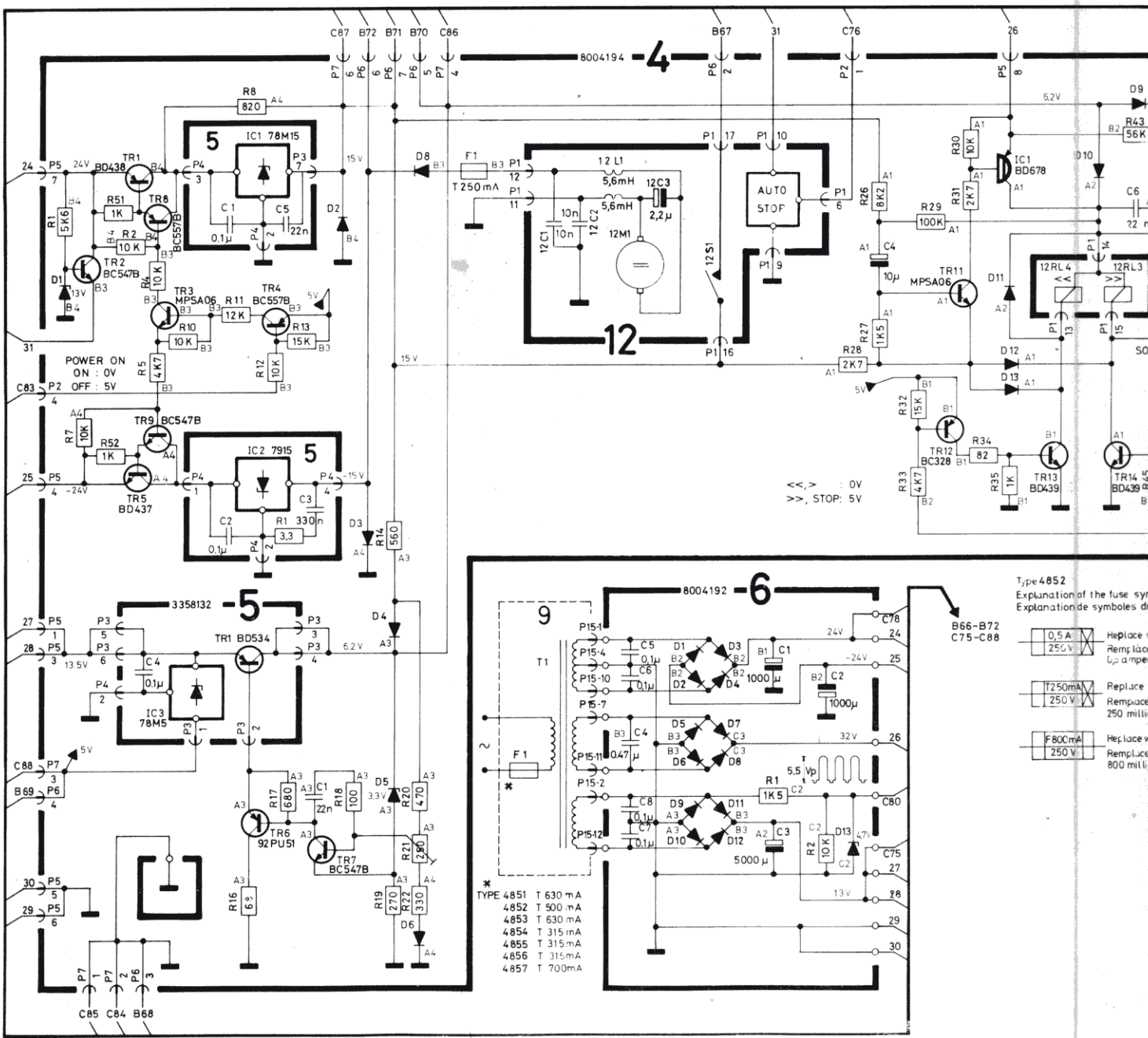

<< >> : 0V
 >> >> : STOP: 5V

Type 4852
 Explanation of the fuse symbols
 Explication des symboles de fusibles

- 0.5 A HePlace with Remplacez avec 0,5 ampere
- T250mA Replacé with Remplacez par 250 milliamperes
- F 800mA HePlace with Remplacez par 800 milliamperes

- * TYPE 4851 T 630 mA
 4852 T 500 mA
 4853 T 630 mA
 4854 T 315 mA
 4855 T 315 mA
 4856 T 315 mA
 4857 T 700 mA

FUNCTION	CONDITIONS		
	1IC8	1IC8	1
PIN	4	33	
	1		
	1	1	
	1	1	
	1		
	1		
	1		
	1	1	

DIAGRAM A FOR BECORD 8004

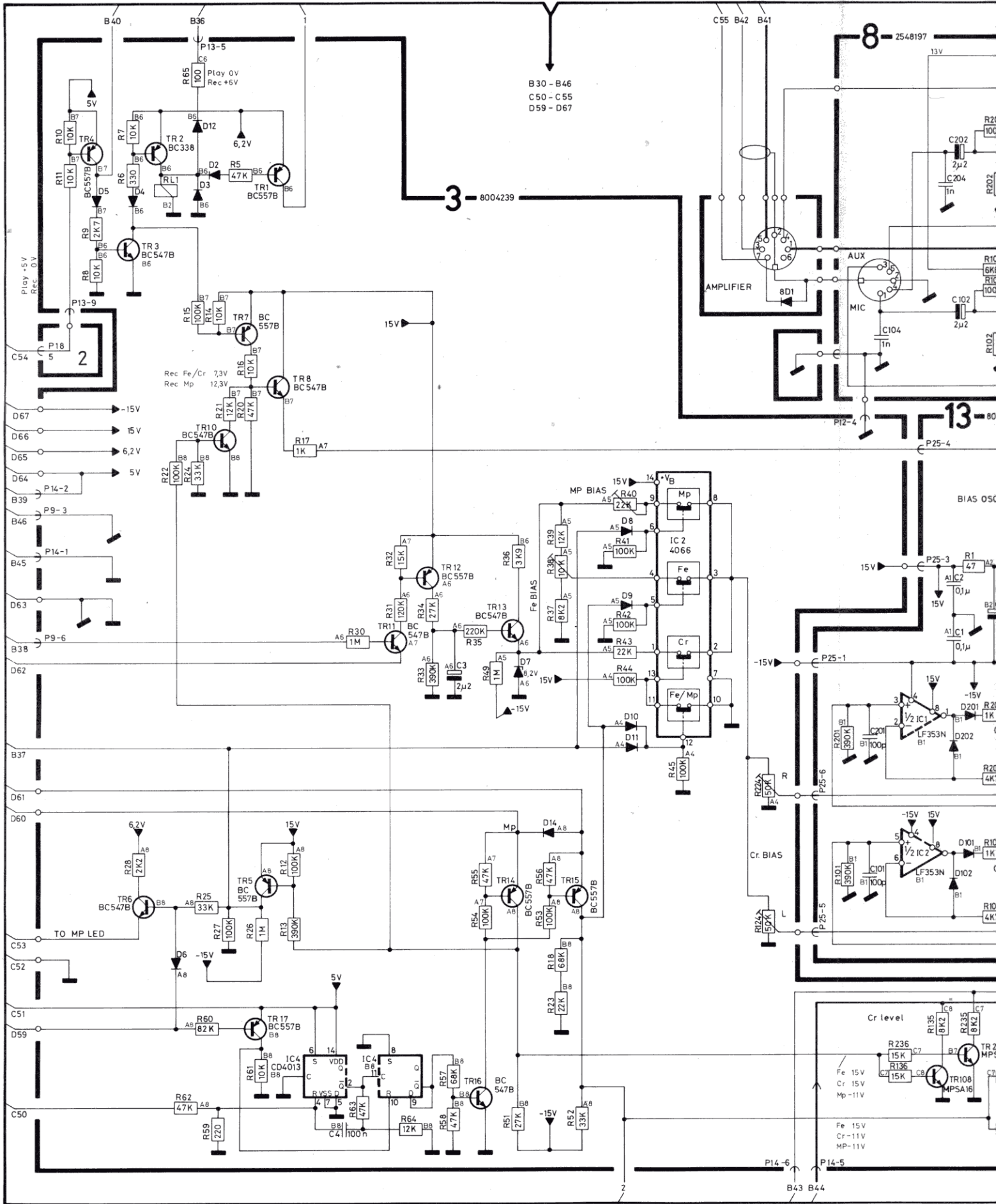

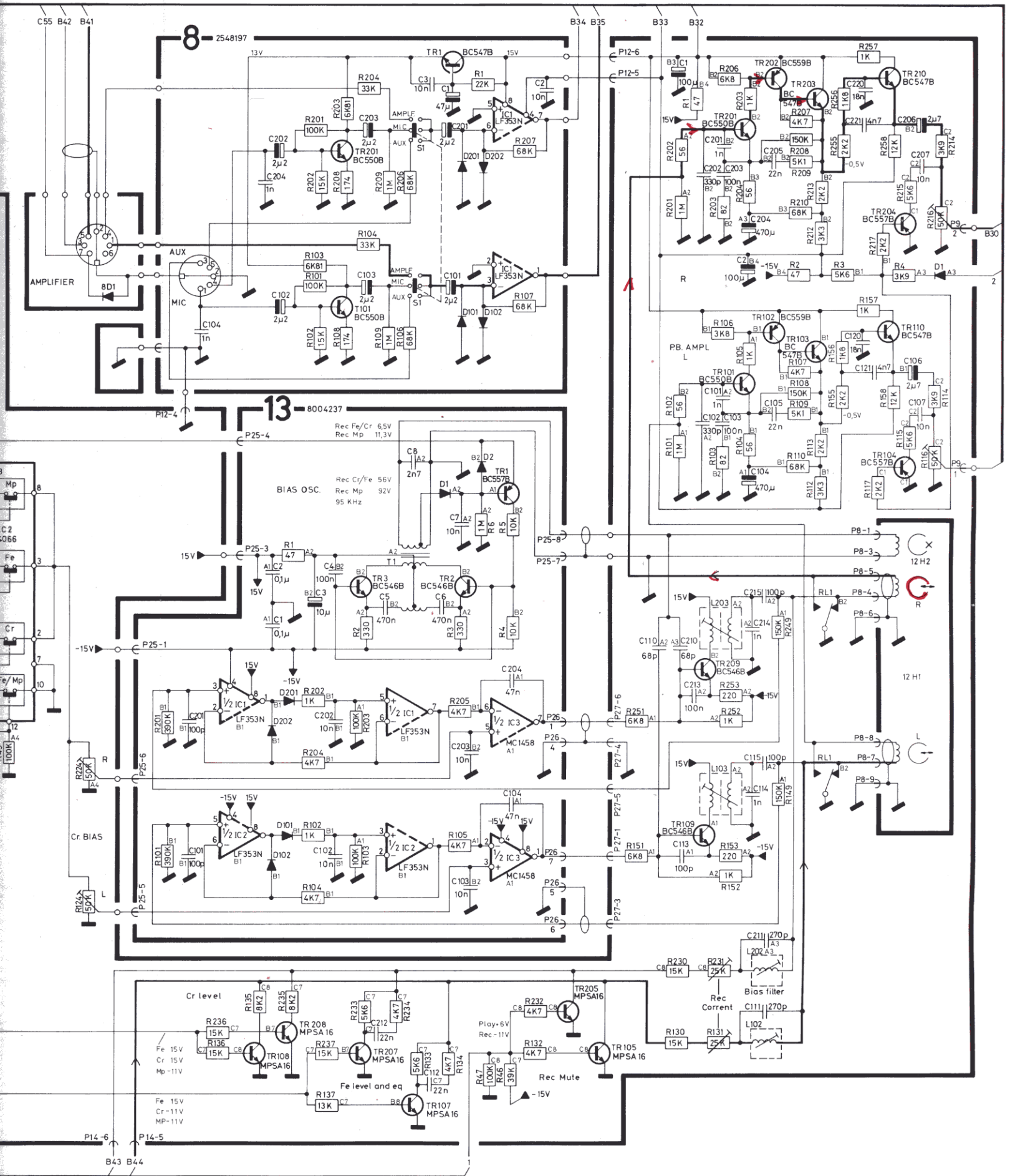

Bang & Olufsen

DIAGRAM B FOR BEOCORD 8004

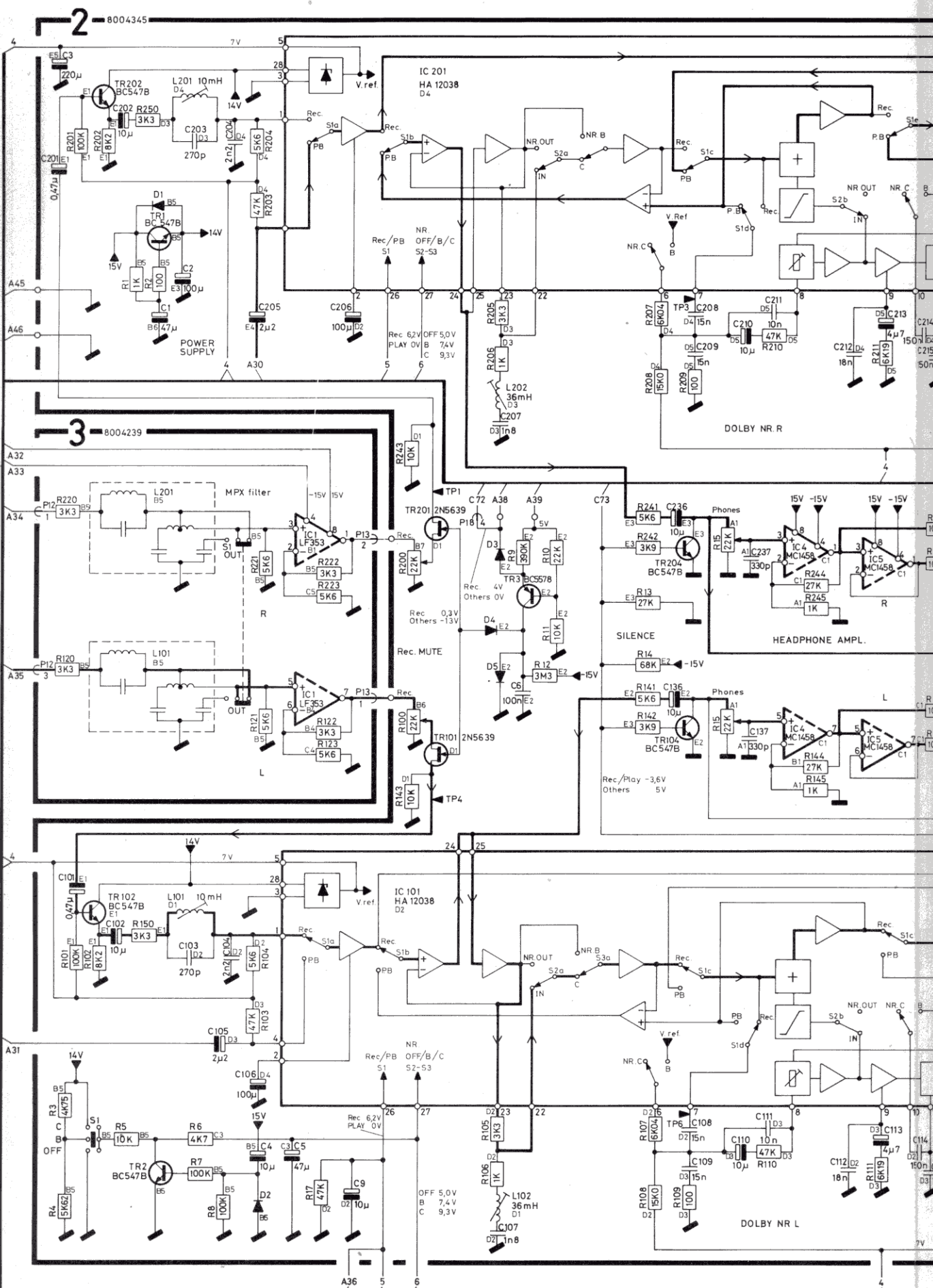

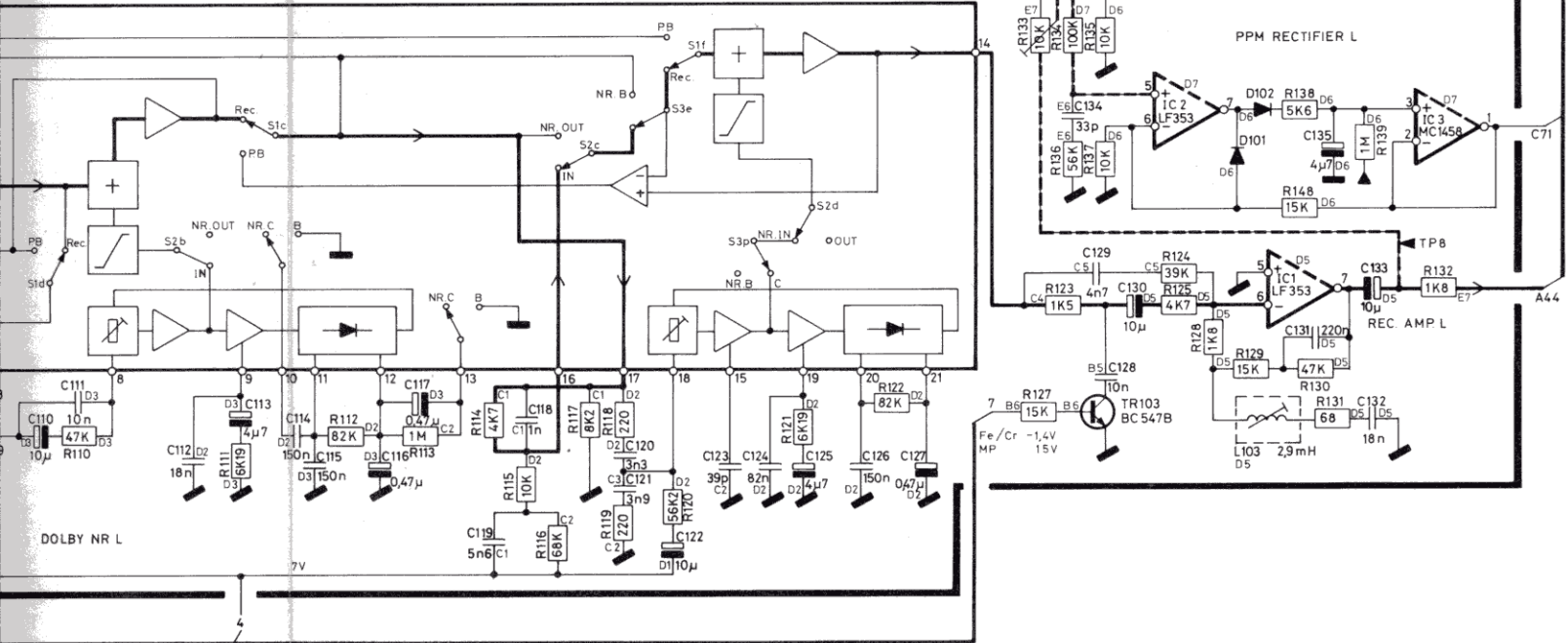
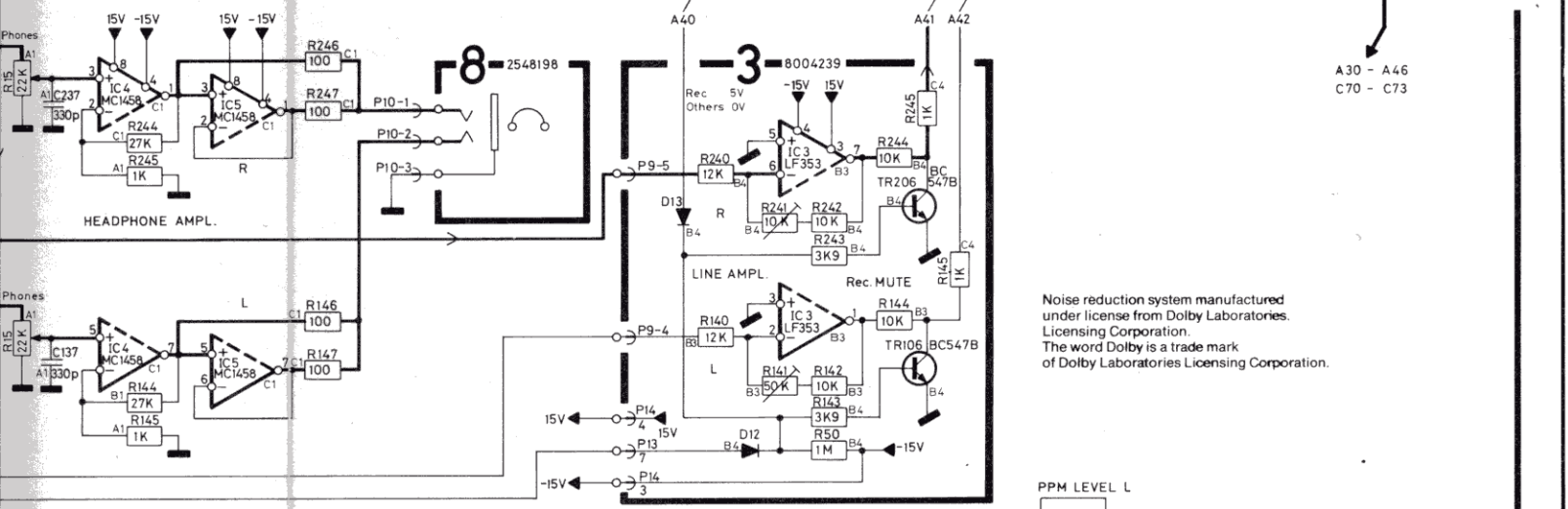
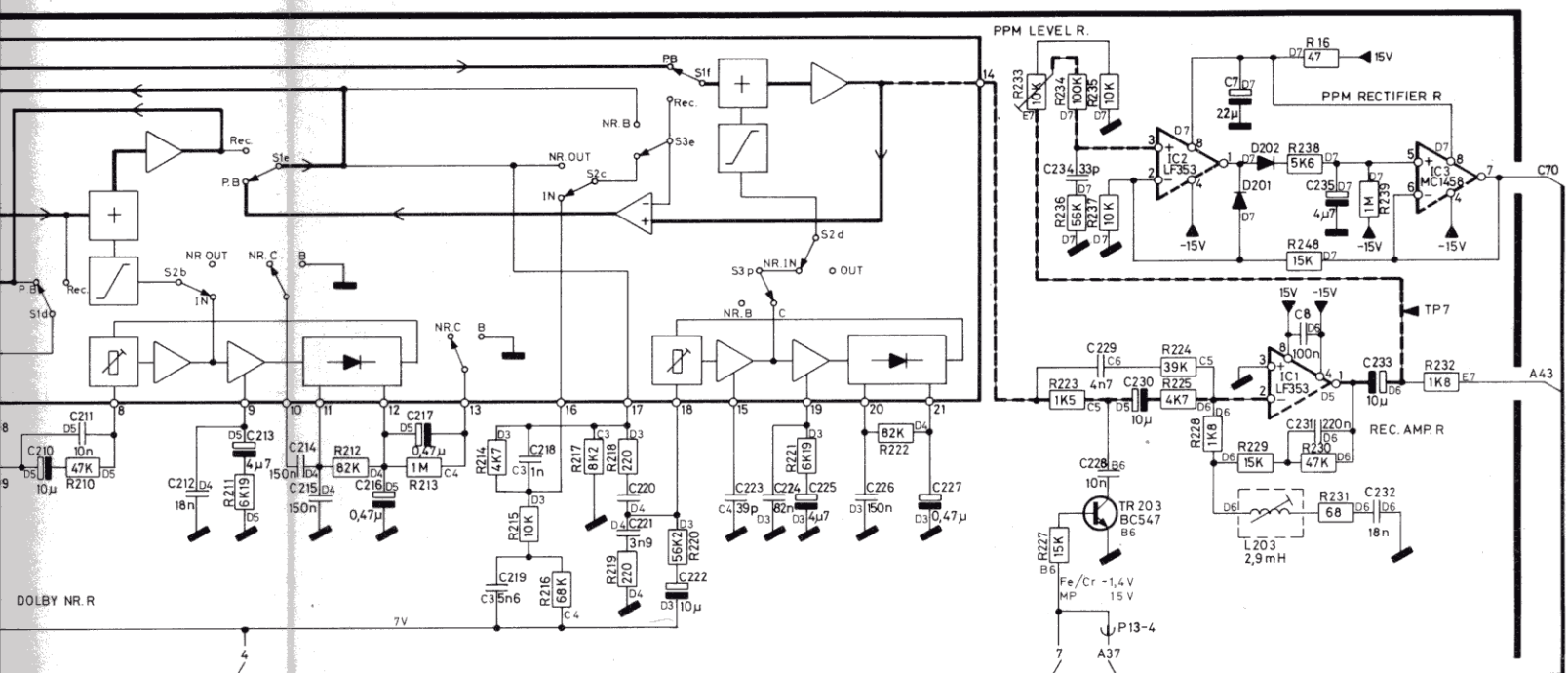

A30 - A46
C70 - C73

Noise reduction system manufactured under license from Dolby Laboratories Licensing Corporation. The word Dolby is a trade mark of Dolby Laboratories Licensing Corporation.

DIAGRAM C FOR BEOCORD 8004

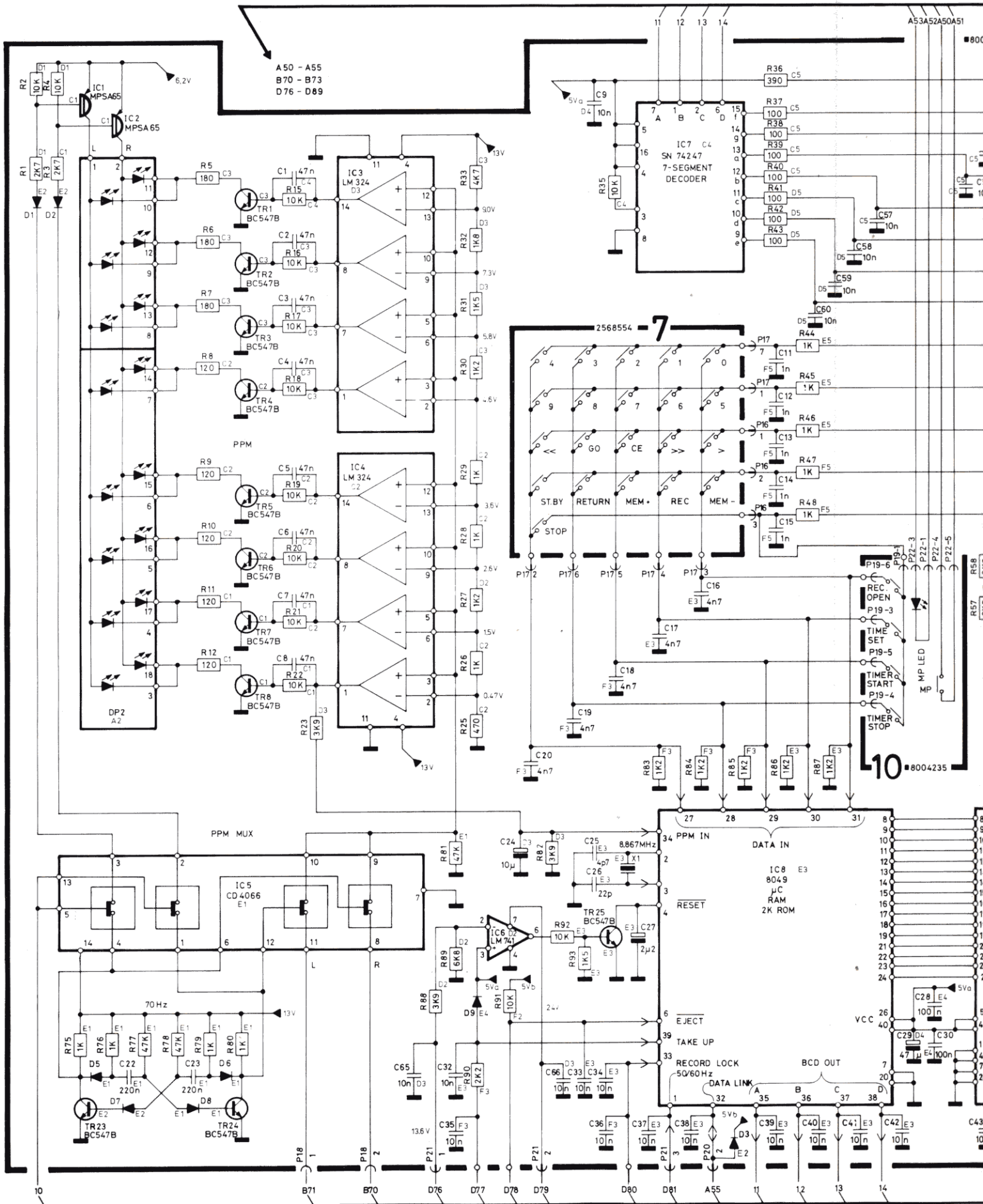

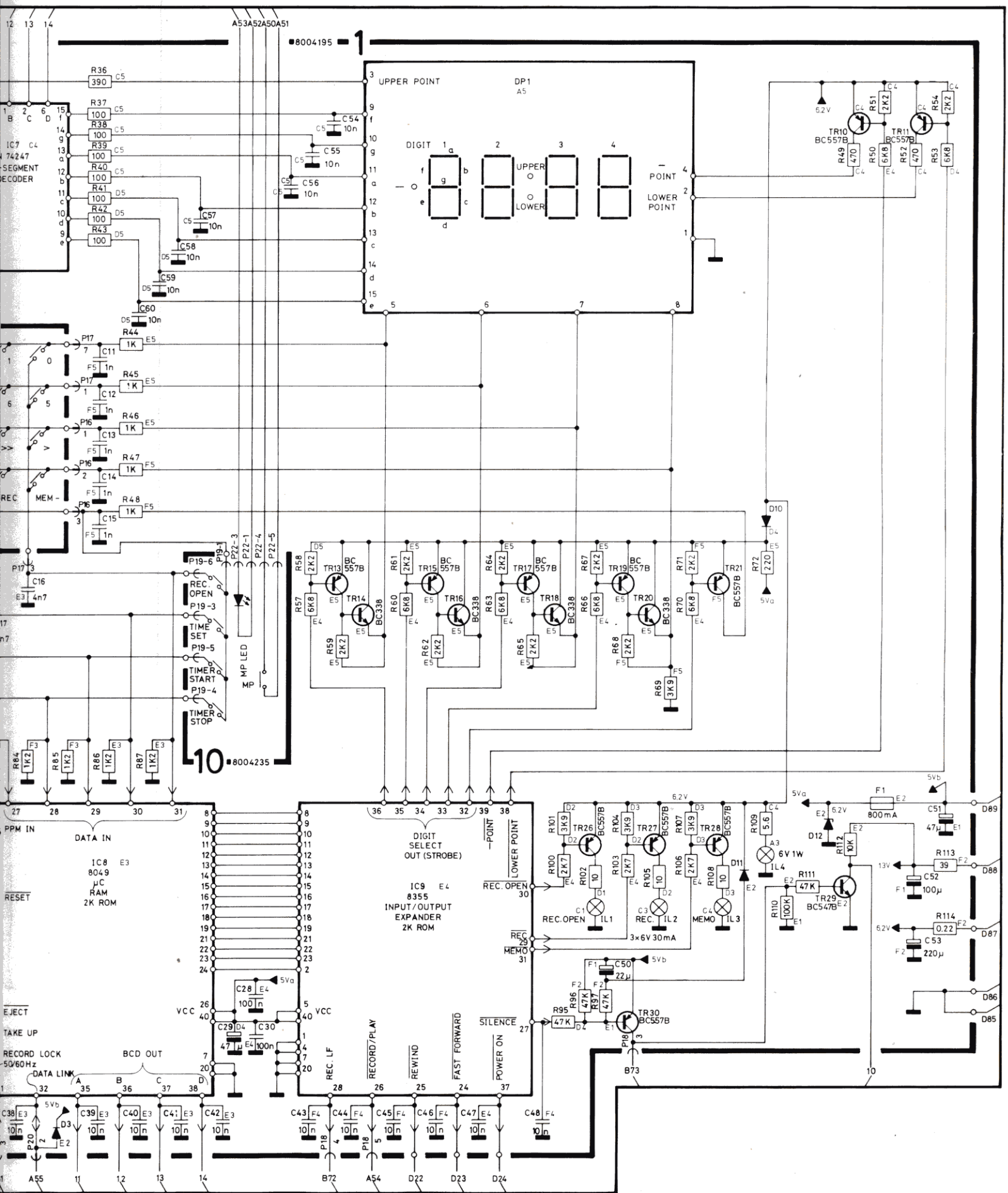

Bang & Olufsen

DIAGRAM D FOR BEOCORD 8004

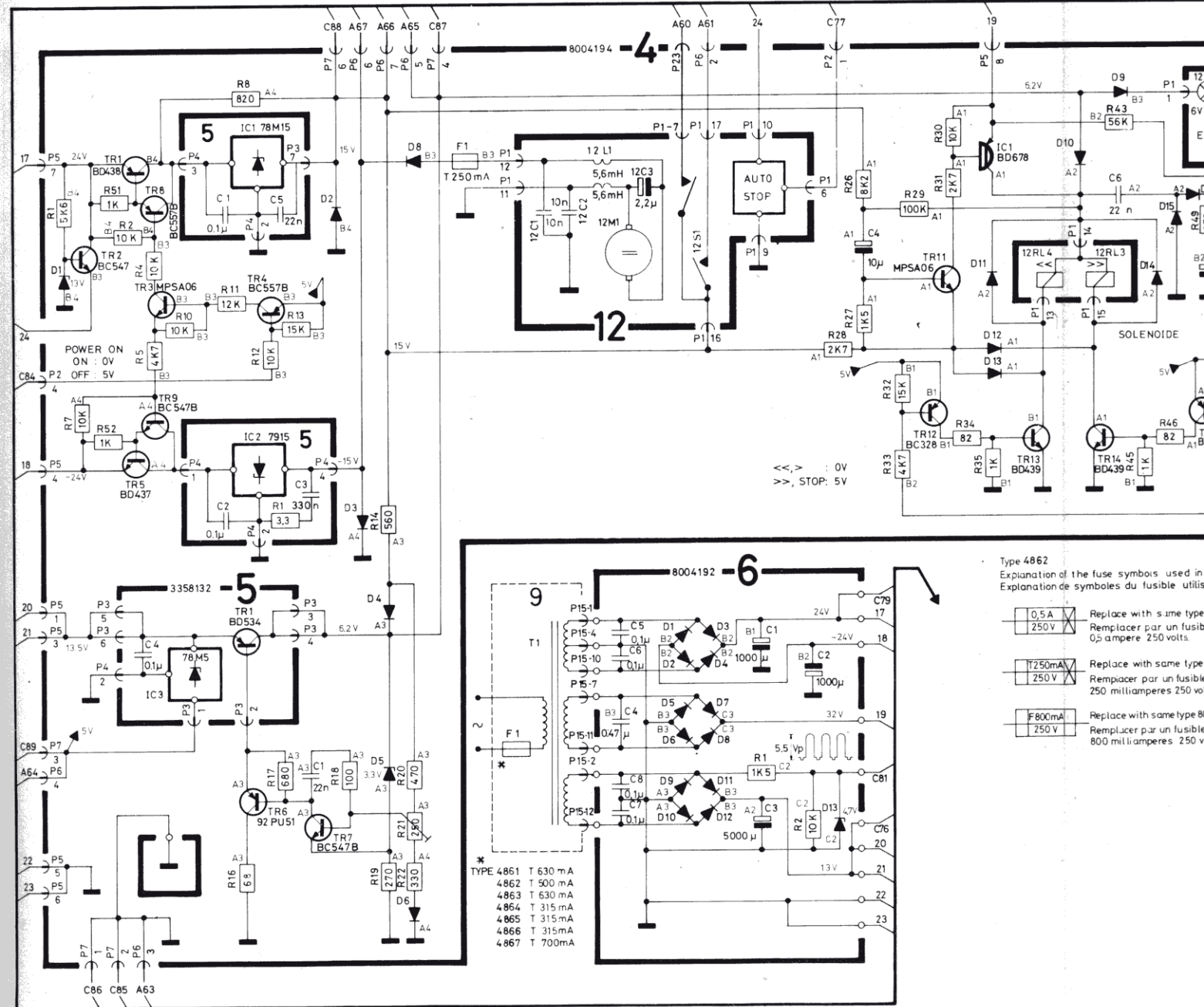

FUNCTION TABLE

PIN	CONDITIONS		
	11C8	11C8	11C8
	4	33	6
	1		
	1	1	1
	1	1	1
	1		
	1		1
	1		1
	1	1	1

