

# Beolab Penta

Type 6631, 6632, 6633, 6634, 6635

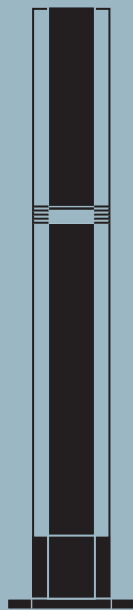

## Ledningsmontering på nettransformatorer

### Wiring of Mains Transformers

Type 6631

Type 6632

Type 6635

6T1 8013494  
6T2 8013370  
3F1 6600009  
3F2 6600070

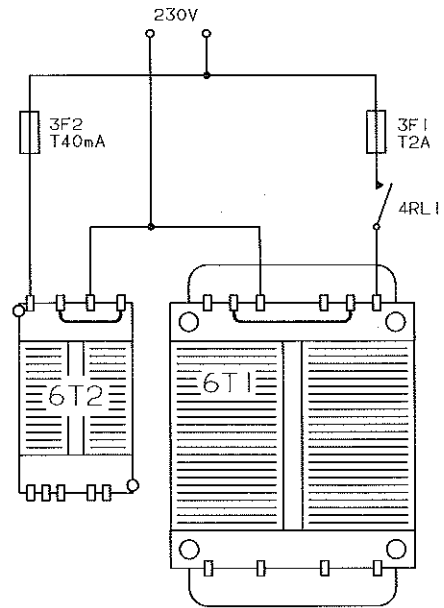

6T1 8013494  
6T2 8013370  
3F1 6600009  
3F2 6600070

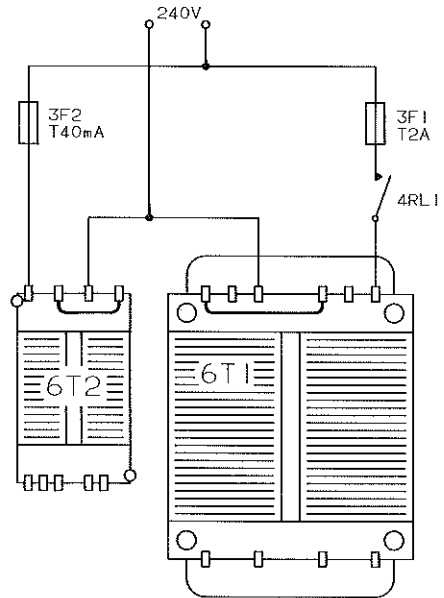

6T1 8013494  
6T2 8013370  
3F1 6600009  
3F2 6600070

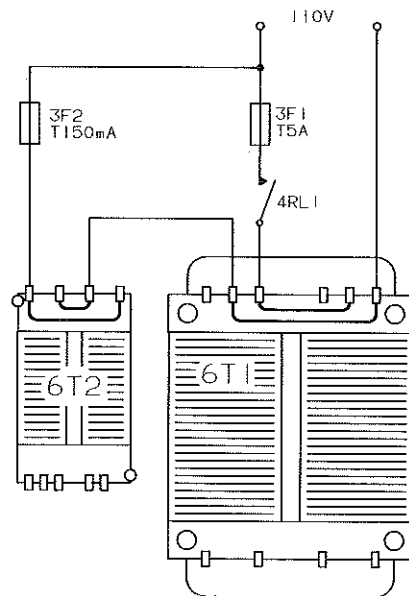

Type 6633

6T1 8013375  
6T2 8013370  
3F1 6600019  
3F2 6600069

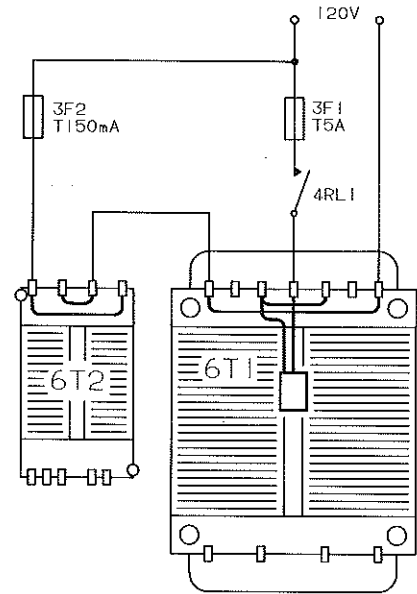

6T1 8013375  
6T2 8013370  
3F1 6600009  
3F2 6600070

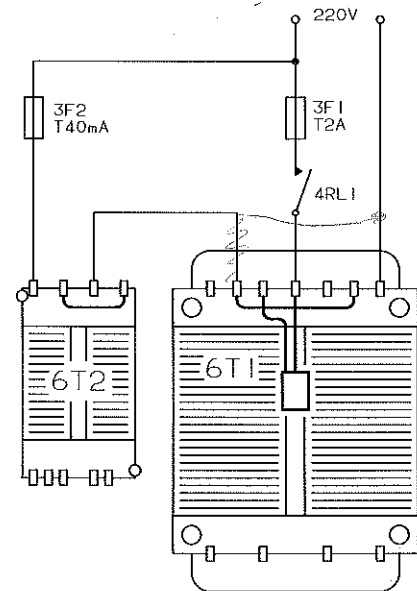

6T1 8013375  
6T2 8013370  
3F1 6600009  
3F2 6600070

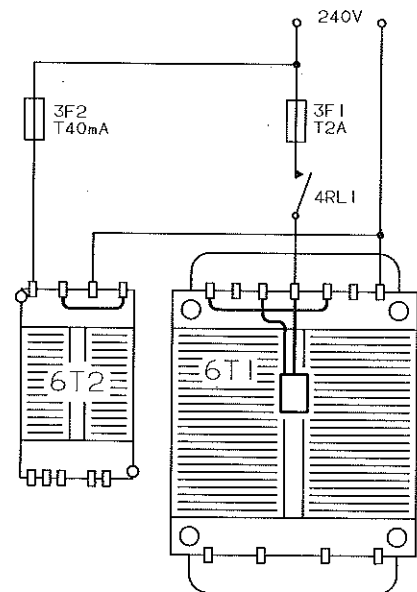
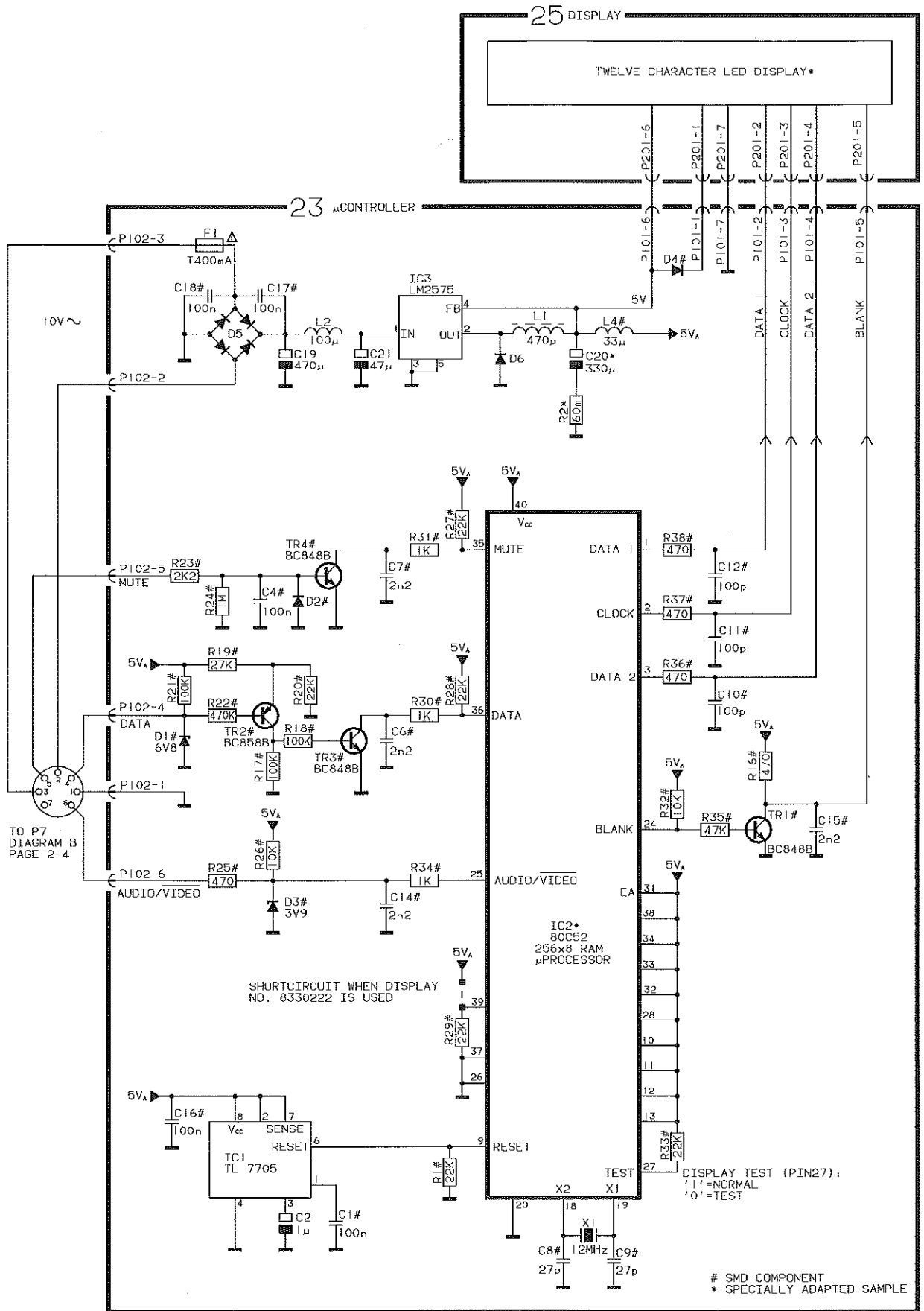



DIAGRAM A, Display 663X



## LIST OF ELECTRICAL PARTS

51	124	143	156	209	250		

Resistors not referred to are standard, see page 3-4  
 Δ Indicates that static electricity may destroy the component  
 \* Specially selected or adapted sample

### PCB23, 8001443 Microprocessor

IC1	8341612	<b>156</b>	TL 7705	IC3	8341770	<b>143</b>	LM 2575
IC2Δ*	8341771	<b>124</b>	μP 80C52				
TR1	8320615	<b>051</b>	BC 848B	TR3- TR4	8320615	<b>051</b>	BC 848B
TR2	8320616	<b>051</b>	BC 858B				
D1	8300520	<b>250</b>	Z 6.8V 5%	D4	8300557	<b>250</b>	BYM10
D2	8300482	<b>250</b>	LL 4148	D5	8300466		125V 1.5A
D3	8300577	<b>250</b>	Z 3.9V 2%	D6	8300795	<b>209</b>	1N 5822
R2*	5012142		60 mΩ				
C1	4010166	100nF -20+80% 50V		C14-	4010170	2.2nF 10% 50V	
C2	4200512	1μF 20% 50V		C15			
C4	4010166	100nF -20+80% 50V		C16-	4010166	100nF -20+80% 50V	
C6-	4010170	2.2nF 10% 50V		C18			
C7				C19	4200993	470μF 20% 50V	
C8-	4000278	27pF 5% 50V		C20*	4201116	330μF 20% 25V	
C9				C21	4200952	47μF -20+50% 25V	
C10-	4000241	100pF 5% 50V					
C12							
L1	8020914	Coil 470μH		L4	8020817	Coil 33μH	
L2	8020912	Coil 100μH					
X1	8090075	Crystal 12MHz					
F1	6600080	Fuse 400mAT					
P101	7220714	Plug 7 pole		P102	7220318	Plug 6 pole	

*All other electrical parts are identical with chapter 3 for 662x (3538730)*

## LIST OF MECHANICAL PARTS

Ex. view, see page 4-2

9115	3320103	Cover glass f. display
9151	3183673	Masking f. display
23Modul	8001443	PCB23, Microcomputer
25Modul	8001485	PCB25, Display (3x4 character)
	2576275	Holder
	8330222	PCB25, Display (2x6 character)

---

Ex. view, see page 4-3

9017	3164800	Coverplate w. print, type 6631
	3164865	Coverplate w. print, type 6632
	3164890	Coverplate w. print, type 6633
	3164891	Coverplate w. print, type 6634
	3164892	Coverplate w. print, type 6635
06T1	8013494	Transformer, type 6631 (230 EU)
	8013494	Transformer, type 6632, 6635 (240 GB/AUS)
	8013375	Transformer, type 6633 (120 USA)
	8013376	Transformer, type 6634 (110 JAP)

---

## Owners Manuals

3506179	Danish
3506180	Swedish
3506181	Finnish
3506182	English
3506183	German
3506184	Dutch
3506185	French
3506186	Italian
3506187	Spanish

---

*All other mechanical parts are identical with chapter 4 for 662x (3538730)*

Bang & Olufsen  
DK-7600 Struer  
Denmark

Phone +45 96 84 11 22\*  
Fax +45 97 85 39 11

3538008 03-04