

# Bang & Olufsen

## ML/MCL Converter

Type 1650, 1651, 1652, 1653

## BeoLink Passive

Type 1655, 1656, 1657, 1658

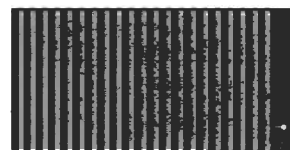

Indicator  
OFF

3538851 10-95 Paste into Service Manual BeoLink Converter, BeoLink Video etc. (3538839)



## CONTENTS

Specification guidelines for service use .....	13-1
Brief operation guide .....	7-2
<b>Diagrams etc. ....</b>	<b>14</b>
Explanation of diagram .....	14-1
Diagrams .....	14-3 - 14-6
<b>List of electrical parts .....</b>	<b>15</b>
<b>List of mechanical parts .....</b>	<b>16</b>
<b>Repair tips .....</b>	<b>17</b>
	English    German    French
ML/MCL Converter .....	17-1      17-3      17-5
BeoLink Passive .....	17-1      17-3      17-5
Testing the ML signal path .....	17-1      17-3      17-5
Testing the data signal path .....	17-1      17-3      17-5
<b>Insulation test .....</b>	<b>18</b>

**For IR Receiver see page 8-4 and 10-1**

WIRING OF TRANSFORMER

Type 1651, 1652, 1656, 1657  
EU, GB 230 V~

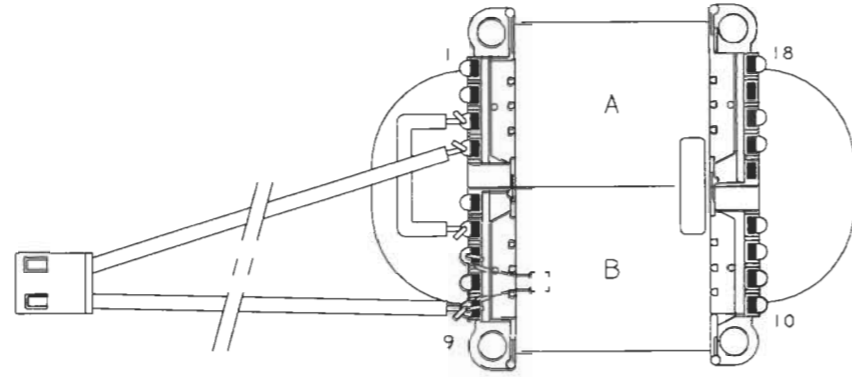

Type 1650, 1655  
AUS 240 V~

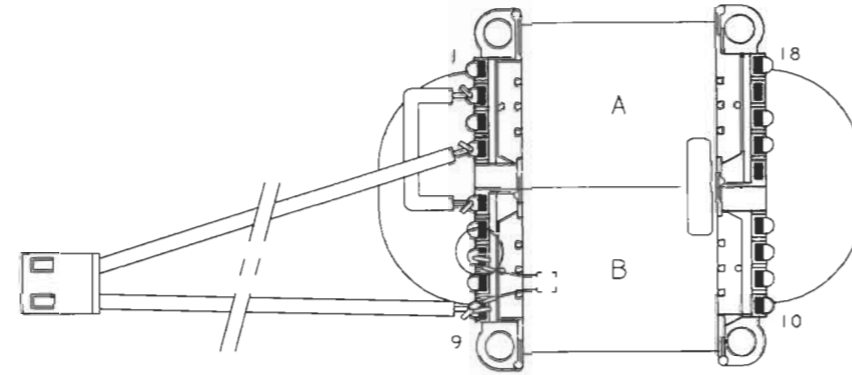

Type 1653, 1658  
USA, CDN 120 V~

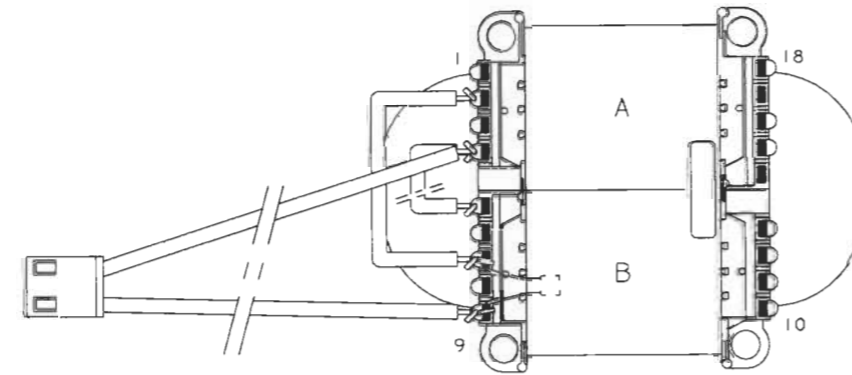

**EXPLANATION OF DIAGRAM**

Type numbers of transistors and ICs are indicated on the diagrams. If the position is followed by an asterisk the spare part number must always be used because the component in question has been specially selected, e.g. IC4\*.

**Component print and coordinate system**

The largest PCBs have component prints and a coordinate system on both the primary and the secondary side.

On the diagrams every component has a coordinate number. This indicates in which coordinate on the PCB the component is situated. The coordinate numbers are written in smaller print types than the position numbers.

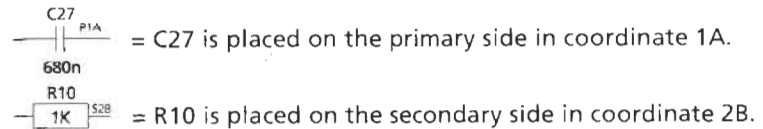

**Control circuit**

In certain control circuits the active mode is indicated by a **function** term or by an abbreviation. This may be e.g. ST.BY. = low in the stand-by mode or ST.BY. = high in the stand-by mode.

**Signal paths and IC markings**

The signal paths are shown in the diagrams by means of semibold lines and arrow heads.

The arrow heads shown in the IC pins tell whether the pin indicated is an input or an output.

**Wiring connections**

The wiring connections on the diagrams are assembled in 'bundles'. The individual wires are provided with one of the following codes:

**INTERNAL CONNECTION ON ONE DIAGRAM PAGE**



Internal connections on a diagram page are indicated by a number. The bend of the wire indicates in which direction the other end of the wire is found.

**CONNECTION TO ANOTHER DIAGRAM PAGE**



A connection to another diagram page is indicated by a number as well as by a letter of the diagram to which the connection leads.

**Ground symbols**

Four different ground symbols are used in the set.

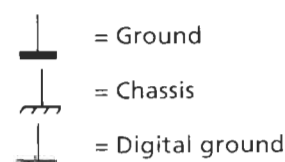

### Symbol of safety components



When replacing components with this symbol, components with identical part numbers must be used. The new component must be mounted in the same way as the one replaced.

### Explanation of the fuse symbols used in the set

Replace with the same type 1.6 ampere 125 volts slow acting fuse.

Replace with the same type 100 m ampere 125 volts slow acting fuse.

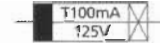
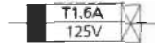

### Explanation des symboles de fusible utilisés dans l'appareil

Remplacer par un fusible retardé de même type et de 1.6 ampères 125 volts.

Remplacer par un fusible retardé de même type et de 100 m ampères 125 volts.

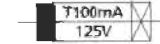
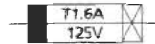

DIAGRAM B OUTPUT AMPLIFIER

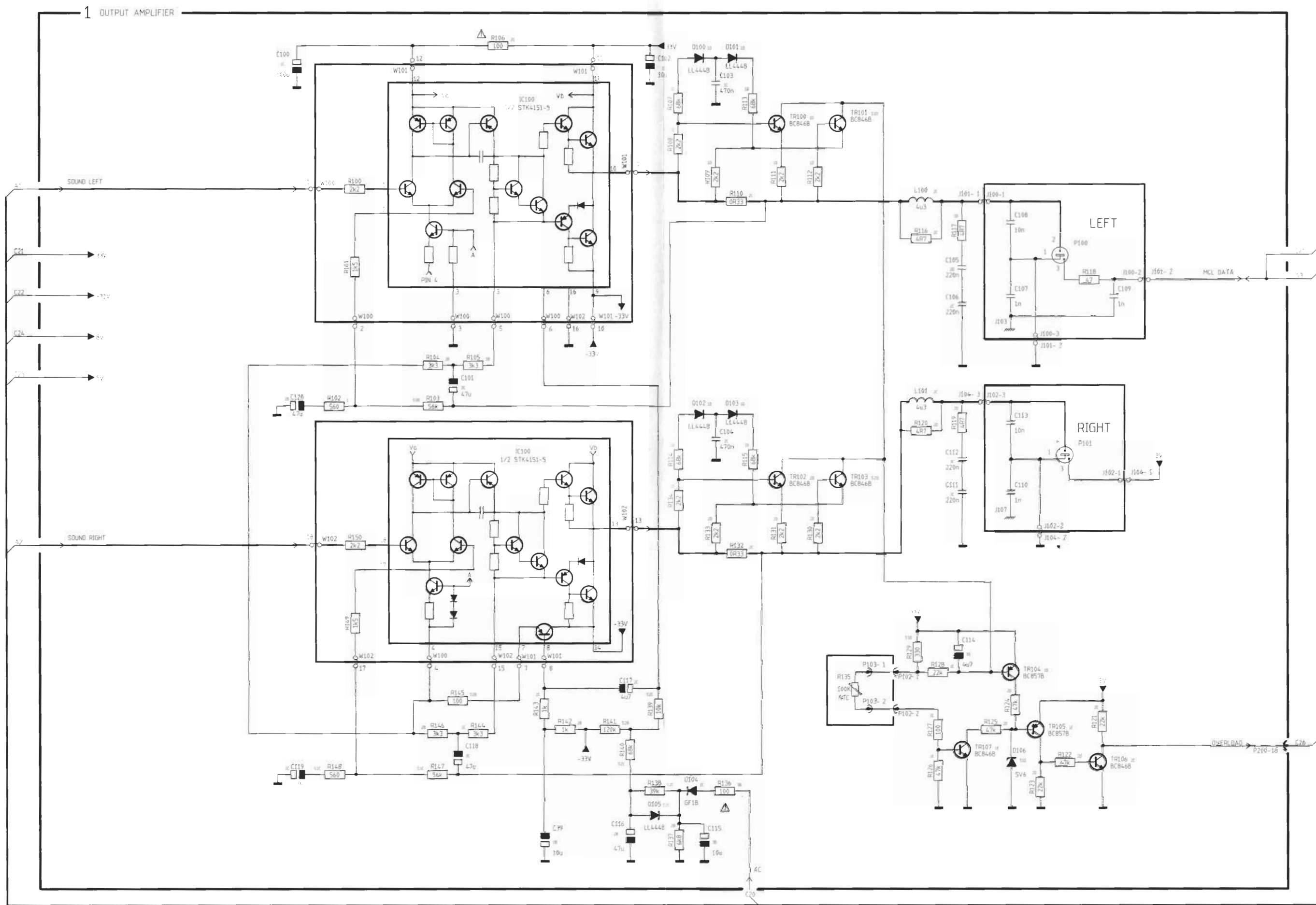
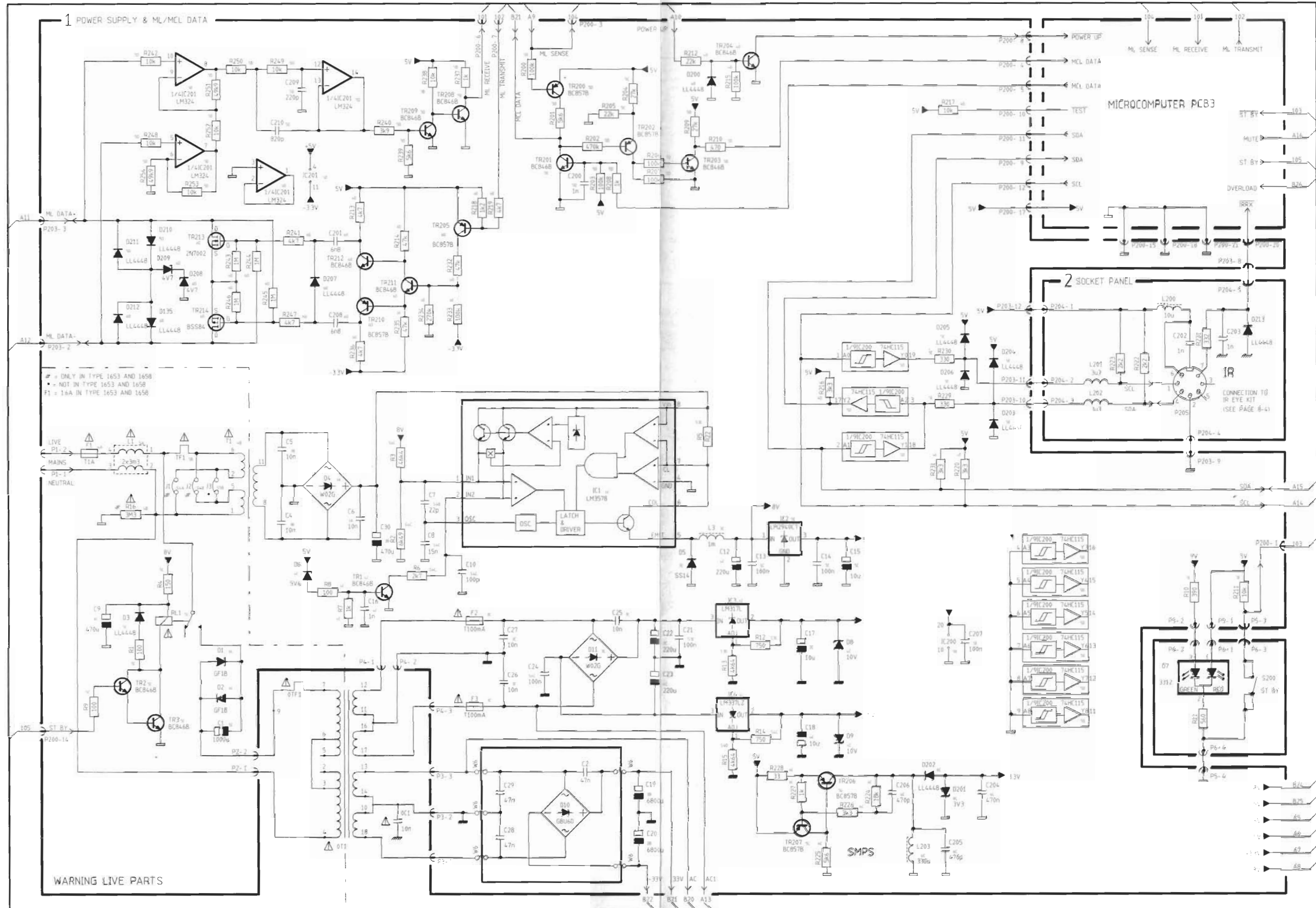
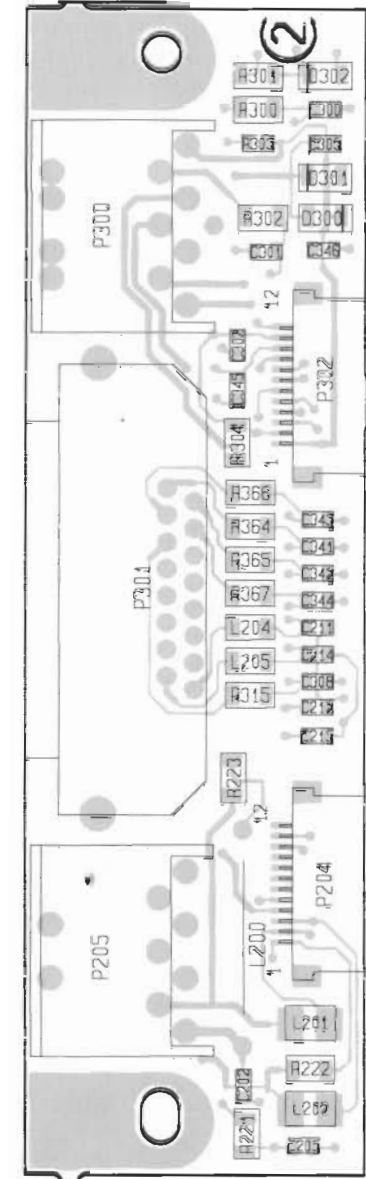
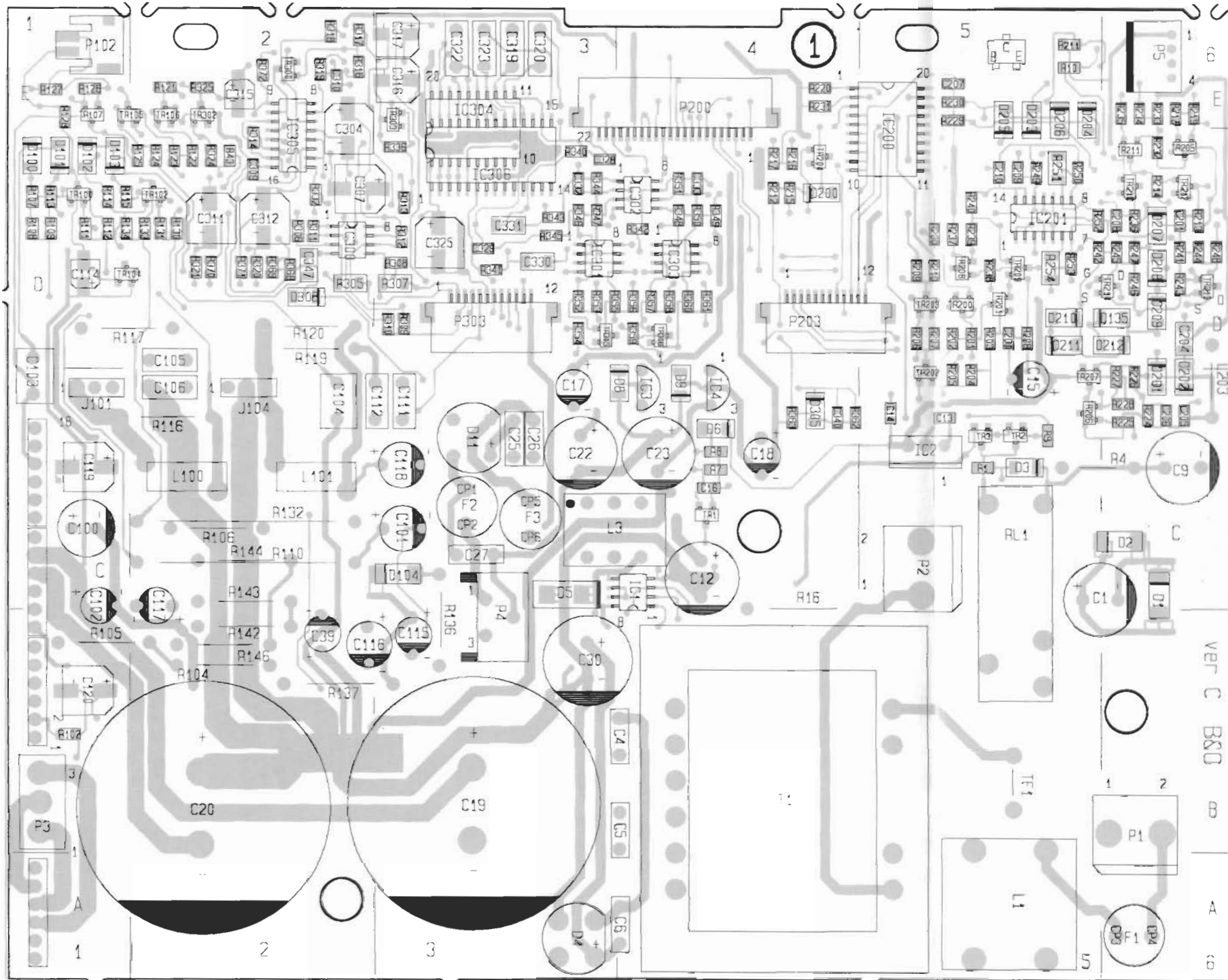
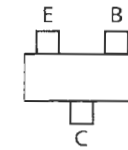

DIAGRAM C POWER SUPPLY, ML DATA & MICROCOMPUTER



PCB 1, MAIN

PCB 2, SOCKET PANEL



VER C B&O B A



PCB 1, MAIN

PCB 2, SOCKET PANEL

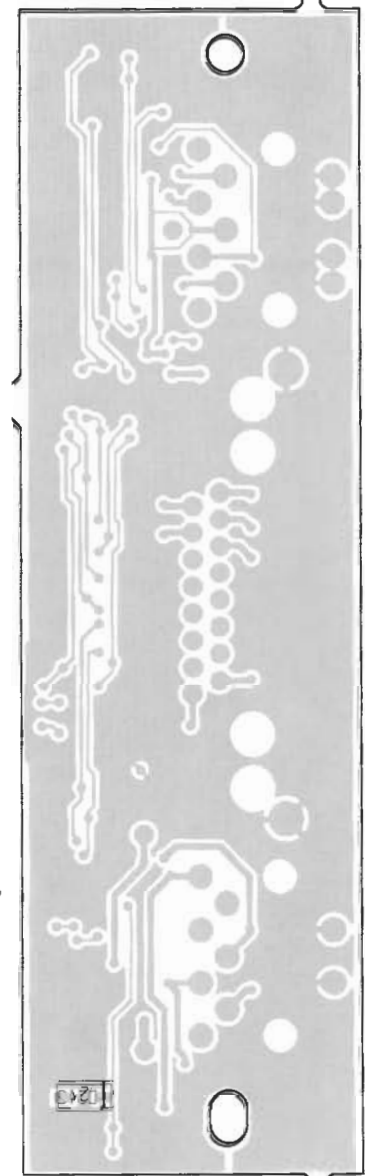
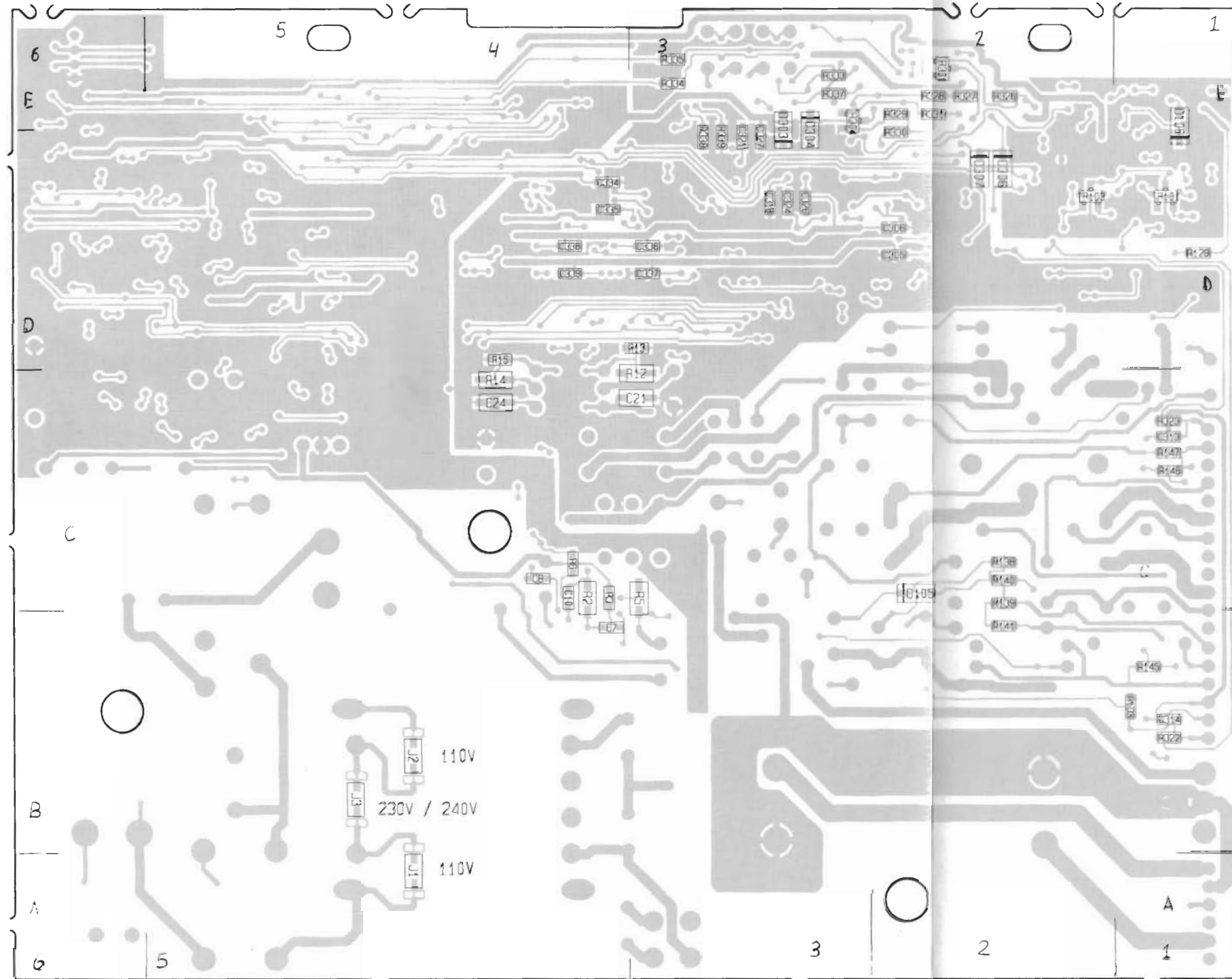
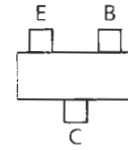

LIST OF ELECTRICAL PARTS

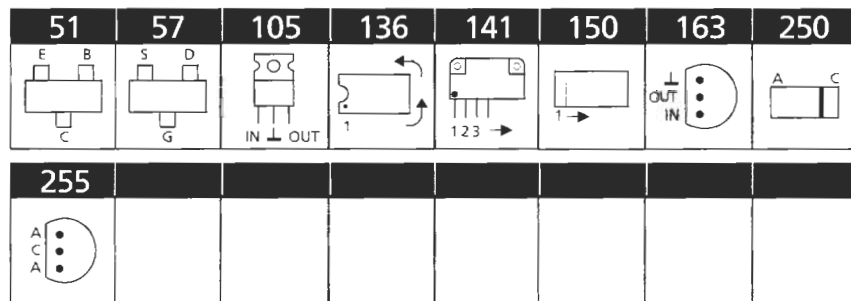

Resistors not referred to are standard, see page 3-2.  
 Δ Indicates that electricity may destroy the component.  
 \* Specially selected or adapted sample.

PCB 1, 8001930, Main  
 8001937, Main f. type  
 1653, 1658

IC1	8342673	<b>150</b>	LM3578	IC201	8341041	<b>150</b>	LM324
IC2	8341163	<b>105</b>	LM2940CT	IC300-	8341022	<b>150</b>	4558
IC3	8341221	<b>163</b>	LM317L	IC303			
IC4	8341800	<b>163</b>	LM337LZ	IC304	8342533	<b>150</b>	TDA7315D
IC100	8350045	<b>141</b>	STK4151-V	IC305Δ	8341059	<b>150</b>	4052
IC200Δ	8342491	<b>136</b>	74HC9115				
TR1-	8320816	<b>051</b>	BC846B	TR208-	8320816	<b>051</b>	BC846B
TR3				TR209			
TR100-	8320816	<b>051</b>	BC846B	TR210	8320811	<b>051</b>	BC857B
TR103				TR211-	8320816	<b>051</b>	BC846B
TR104-	8320811	<b>051</b>	BC857B	TR212			
TR105				TR213	8320856	<b>068</b>	2N7002
TR106-	8320816	<b>051</b>	BC846B	TR214	8320899	<b>068</b>	BSS84
TR107				TR215	8320816	<b>051</b>	BC846B
TR200	8320811	<b>051</b>	BC857B	TR300	8320752	<b>051</b>	BC817-40
TR201	8320816	<b>051</b>	BC846B	TR301	8320811	<b>051</b>	BC857B
TR202	8320811	<b>051</b>	BC857B	TR302	8320816	<b>051</b>	BC846B
TR203-	8320816	<b>051</b>	BC846B	TR303-	8321080	<b>057</b>	FMMT491A
TR204				TR304			
TR205-	8320811	<b>051</b>	BC857B	TR305-	8320758	<b>057</b>	PMBF4392
TR207				TR306			
D1-	8300907	<b>250</b>	GF1B	D106	8300562	<b>250</b>	Z5.6V 2%
D2				D135	8300606	<b>250</b>	LL4448
D3	8300606	<b>250</b>	LL4448	D200	8300606	<b>250</b>	LL4448
D4	8300466		B125C1500	D201	8300607	<b>250</b>	Z3.3V 5%
D5	8300914	<b>250</b>	SS14	D202-	8300606	<b>250</b>	LL4448
D6	8300562	<b>250</b>	Z5.6V 2%	D207			
D8-	8300605	<b>250</b>	Z10V 5%	D208-	8300677	<b>250</b>	Z4.7V 5%
D9				D209			
D11	8300466		B125C1500	D210-	8300606	<b>250</b>	LL4448
D100-	8300606	<b>250</b>	LL4448	D212			
D103				D303-	8300606	<b>250</b>	LL4448
D104	8300907	<b>250</b>	GF1B	D308			
D105	8300606	<b>250</b>	LL4448				
R2	5012110	6.49kΩ	1% 1/8W	R121	5012298	22kΩ	1% 1/10W
R3	5012317	46.4kΩ	1% 1/10W	R123	5012298	22kΩ	1% 1/10W
R5	5021542	0.22Ω	5% 1/4W	R128	5012298	22kΩ	1% 1/10W
R12	5011619	750Ω	1% 1/8W	R132	5100175	0.33Ω	10% 2W
R13	5012320	4.64kΩ	1% 1/10W	R136	5020159	100Ω	10% 0.3W
R14	5011619	750Ω	1% 1/8W	R251	5011599	49.9kΩ	1% 1/8W
R15	5012320	4.64kΩ	1% 1/10W	R254	5011599	49.9kΩ	1% 1/8W
R16	5000194	3.3MΩ	10% 1/2W, only in type 1653, 1658	R305	5013011	20.5kΩ	1% 1/8W
R106	5020159	100Ω	10% 0.3W	R306	5012320	4.64kΩ	1% 1/10W
R110	5100175	0.33Ω	10% 2W	R307	5013011	20.5kΩ	1% 1/8W
				R308	5012320	4.64kΩ	1% 1/10W

R309-	5012298	22kΩ	1% 1/10W	R346-	5012218	11.8kΩ	1% 1/10W
R310				R348			
R311-	5012320	4.64kΩ	1% 1/10W	R349	5012216	5.9kΩ	1% 1/10W
R312				R350	5012218	11.8kΩ	1% 1/10W
R315	5011631	1kΩ	1% 1/4W	R351	5012216	5.9kΩ	1% 1/10W
R344-	5012216	5.9kΩ	1% 1/10W				
R345							
C1	<b>4200821</b>	1000μF	-20+50% 6.3V	C204	4010282	470nF	-20+80% 25V
C4-	<b>4010403</b>	10nF	-20+80% 50V	C205-	4000420	470pF	5% 50V
C6				C206			
C7	<b>4000404</b>	22pF	5% 50V	C207	4010316	100nF	10% 25V
C8	<b>4000457</b>	1.5nF	10% 50V	C208	4010269	6.8nF	10% 50V
C9	<b>4200600</b>	470μF	20% 16V	C209	4000416	220pF	5% 50V
C10	<b>4000412</b>	100pF	5% 50V	C210	4000423	820pF	5% 50V
C12	<b>4201330</b>	220μF	20% 50V	C304	4201164	47μF	20% 10V
C13-	<b>4010274</b>	100nF	-20+80% 25V	C305-	4010272	22nF	-20+80% 50V
C14				C306			
C15	<b>4200510</b>	10μF	20% 16V	C307	4201164	47μF	20% 10V
C16	<b>4010237</b>	1nF	10% 50V	C309-	4010272	22nF	-20+80% 50V
C17-	<b>4200510</b>	10μF	20% 16V	C310			
C18				C311-	4201164	47μF	20% 10V
C19-	<b>4201363</b>	6800μF	20% 50V	C312			
C20				C313-	4000420	470pF	5% 50V
C21	4010166	100nF	-20+80% 50V	C314			
C22-	<b>4200311</b>	220μF	-20+50% 40V	<b>C315</b>	4201257	1μF	20% 50V
C23				<b>C316-</b>	4201163	10μF	20% 35V
C24	<b>4010166</b>	100nF	-20+80% 50V	<b>C317</b>			
C25-	<b>4010403</b>	10nF	-20+80% 50V	<b>C318</b>	4000457	1.5nF	10% 50V
C27				<b>C319-</b>	4130307	150nF	10% 63V
C30	<b>4200993</b>	470μF	20% 50V	<b>C320</b>			
C39	<b>4201173</b>	10μF	20% 50V	C321	4000457	1.5nF	10% 50V
C100	<b>4201264</b>	100μF	20% 50V	C322-	4130307	150nF	10% 63V
C101	<b>4200688</b>	47μF	20% 50V	C323			
C102	4201173	10μF	20% 50V	C324	4010274	100nF	-20+80% 25V
C103-	4130313	470nF	20% 63V	C325	4201268	22μF	20% 35V
<b>C104</b>				C326	4010274	100nF	-20+80% 25V
<b>C105-</b>	4130308	220nF	10% 63V	C327	4010272	22nF	-20+80% 50V
<b>C106</b>				C328-	4000412	100pF	5% 50V
C111-	4130308	220nF	10% 63V	C329			
C112				C330-	4010322	4.7μF	-20+80% 16V
C114	4200916	4.7μF	20% 25V	C331			
C115	4201173	10μF	20% 50V	C332-	4000404	22pF	5% 50V
C116	<b>4200688</b>	47μF	20% 50V	C333			
C117	4200875	4.7μF	20% 100V	C334-	4010272	22nF	-20+80% 50V
C118	<b>4200688</b>	47μF	20% 50V	C339			
C119-	4201164	47μF	20% 10V	C340	4010237	1nF	10% 50V
C120				C345	4010272	22nF	-20+80% 50V
C200	4010237	1nF	10% 50V	C347	4010282	470nF	-20+80% 25V
C201	4010269	6.8nF	10% 50V				
L1	8022340	Coil	2x3.3mH	L100-	6850165	Coil	4.3μH
L3	8021146	Coil	1mH	L101			
				L203	8020867	Coil	330μH 10%
RL1	7600120	Relay	5V				
T1	8013562	Trafo,	ST.BY				
TF1	6609031	Fuse,	thermal				

F1	6600072 Fuse, T1A 250V	F2-	6600084 Fuse, T100mA 250V
	6600116 Fuse, T1.6A 125V f. type 1653, 1658	F3	
		F2-	6600148 Fuse, T100mA 125V f. type 1653, 1658
		F3	

CP1-CP6	7200064 Connection pin, 1 pole
---------	--------------------------------

P1-	7220406 Plug 2 pole	P102	7221082 Plug 2 pole
P2		P200	7210897 Socket 22 pole
P3	7220185 Plug 3 pole	P203	7210893 Socket 12 pole
P4	7220425 Plug 3 pole	P303	7210893 Socket 12 pole
P5	7220726 Plug 4 pole		

**PCB 2, 8001931, Socket panel**

D213	8300606 <b>250</b> LL4448	D302	8300520 <b>250</b> Z6.8V 5%
D300-D301	8300606 <b>250</b> LL4448		

R221	5011852 332Ω 1% 1/4W	R302	5011632 1.5kΩ 1% 1/4W
R222-	5012200 2.2kΩ 1% 1/4W	R304	5011632 1.5kΩ 1% 1/4W
R223		R364-	5011632 1.5kΩ 1% 1/4W
R300	5011631 1kΩ 1% 1/4W	R367	
R301	5021524 47Ω 1% 1/4W		

C202-	4010237 1nF 20% 50V	C303	4010272 22nF -20+80% 50V
C203		C308	4010237 1nF 20% 50V
C211-	4000416 220pF 5% 50V	C341-	4000408 47pF 5% 50V
C214		C344	
C300	4010237 1nF 20% 50V	C346	4010272 22nF -20+80% 50V
C301-	4000416 220pF 5% 50V		
C302			

L200	8020934 Coil 10μH 10%	L204-	8020821 Coil 2.2μH 5%
L201-	8020609 Coil 3.3μH 20%	L205	
L202			

P204	7210893 Socket 12 pole	P301	7210904 Socket, Master Link
P205	7211098 Socket, IR	P302	7210893 Socket 12 pole
P300	7211099 Socket, Power Link		

**PCB 3, 8006111, Microcomputer**

**8001932, Rectifier**

D10	8300938 GBU6D
-----	---------------

C2	4130517 47nF 10% 100V
C28-	4130517 47nF 10% 100V
C29	

**8001933, Speaker, left**

C107	4010237 1nF 20% 50V	C109	4010237 1nF 20% 50V
C108	4010271 10nF 10% 50V		

R118	5021524 47Ω 1% 1/4W
------	---------------------

**8001934, Speaker, right**

C110	4010237 1nF 10% 50V
C113	4010271 10nF 10% 50V

**8001935, St. by**

D7	8330236 <b>255</b> LED, red/green
----	-----------------------------------

S200	7400268 Switch
------	----------------

P6	7220726 Plug 4 pole
----	---------------------

**8001936, NTC**

**Transformer**

OT1	8013556 All types
-----	-------------------

OTF1	6609033 Fuse, thermal
------	-----------------------

OC1	4010113 22nF 30% 25V
-----	----------------------

**8089096, IR Eye complete**

For other electrical parts see section 9

In the first sets produced, the PCB's are version B. In the below table the difference between PCB version B and version C are shown.

The electrical parts list is for version C.

Version B	Version C
<del>ST BY transformer position no. L2</del>	Position no. T1
C2, C28 and C29 22nF	47nF
C3	Removed
C101, C116 and C118 47uF 4201164	47uF 4200688
C117 10nF	4.7uF
C215 and C216	Removed
C304, C307, C311 and C312 4.7uF	47uF
C316 and C317 4.7uF	10uF
C330 and C331 4.7uF 4200916	4.7uF 4010322
	D106 and D308 added
F2 and F3 T63mA	T100mA
R124 220kohms	47kohms
R129 470ohms	330ohms
R221 1kohm	332ohms
R225 15kohms	5.6kohms
R368 15kohms	27kohms
	R370, R371 and R372 added

## EXPL. VIEW

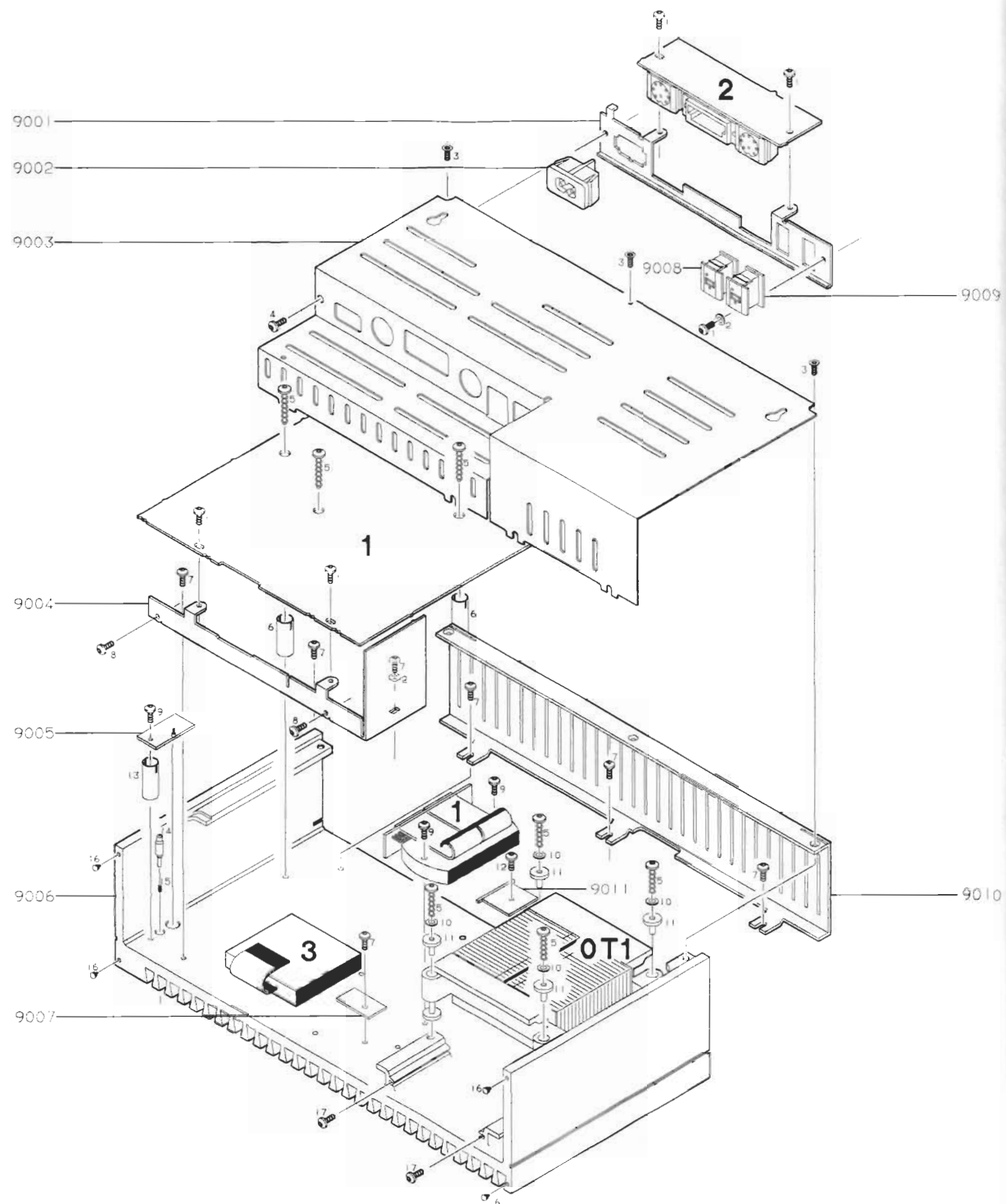

01 modul 8001930 Main  
8001937 Main for type 1653, 1658

02 modul 8001931 Socket panel

03 modul 8006111 Microcomputer

OT1 8013556 Transformer  
OTF1 6609033 Fuse, thermal  
OC1 4010113 22nF 30% 25V

9001 3169189 Holder for socket panel  
9002 6276720 Mains plug  
9003 3452687 Rear plate  
9004 2548262 Holder for Main panel  
9005 8001935 ST.BY  
6150005 Linse f. D7  
9006 3430761 Heat sink  
9007 8001936 NTC  
9008 8001934 Speaker, right  
7210520 Speaker socket  
9009 8001933 Speaker, left  
7210520 Speaker socket  
9010 3458945 Top plate  
9011 8001932 Rectifier

## Survey of screws etc.

1 2038145 Screw, 3 X 5  
2 2625002 Washer  
3 2054005 Screw, 3 X 8  
4 2038094 Screw, 3 X 10  
5 2054007 Screw, 3.5 X 27  
6 2938315 Bushing  
7 2013176 Screw, 3 X 6  
8 2038097 Screw, 3 X 6  
9 2013177 Screw, 3 X 13  
10 2622024 Washer  
11 2938154 Bushing  
12 2013188 Screw, 3 X 8  
13 2576324 Bushing  
14 2776109 Botton  
15 2812100 Spring  
16 3103274 Foot  
17 2013192 Screw, 3 X 6

## Parts not shown

6100245 Mains lead, EU  
6100328 Mains lead, GB  
6100306 Mains lead, USA/CDN  
6100248 Mains lead, AUS  
2039033 Screw, 3 X 6  
2515070 Clamp f. screw  
3392025 Outer carton  
3397642 Foam  
3947038 Foil  
6277123 Wire bundle, transformer  
6277124 Main wire bundle  
3500584 Setting-up guide for ML/MCL Converter  
3501707 Users guide, Danish, for BeoLink Passive  
3501708 Users guide, Swedish, for BeoLink Passive  
3501709 Users guide, Finnish, for BeoLink Passive  
3501710 Users guide, English, for BeoLink Passive  
3501711 Users guide, German, for BeoLink Passive  
3501712 Users guide, Dutch, for BeoLink Passive

**REPAIR TIPS**

**ML/MCL Converter** ML/MCL Converter converts ML to MCL. For connection between Master Link (ML) products and Master Control Link (MCL) systems. Also replaces MCL2P.

**BeoLink Passive** BeoLink Passive is for driving passive loud speakers in Link rooms. Operation is possible via the IR eye installed.

**Testing the ML signal path** BeoLink Passive can be brought into TEST MODE from stand-by with a one-way terminal (Beo 4 or Beolink 1000).

**TEST MODE 03** Opens the Master Link signal path without the unit having to be connected to an ML driver. It is switched on by means of preset analog values (from EEPROM).

- Press MENU 0 3 PLAY  
The unit switches on and opens the ML signal path.
- Press STOP  
The unit closes the ML signal path and goes into stand-by.

**Testing the data signal path** The Master Link socket (2P301) must receive the following supply of voltages/signals:

- Connect to pin 12 a voltage of between 7V and 15V.
- Connect the metal jacket on the Master Link socket to ground (0V).
- The voltages at pin 2 (Data+) and pin 1 (Data-) are most easily generated by means of the following external components:

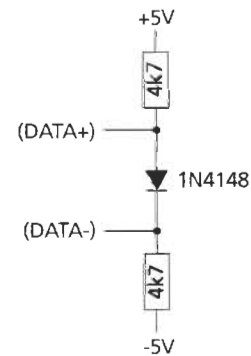

- Connect the box to mains.

It is now possible to measure balanced data signals at Data+ and Data- (see figure), and the circuits microprocessor PCB, data transmitter and data receiver can be tested.

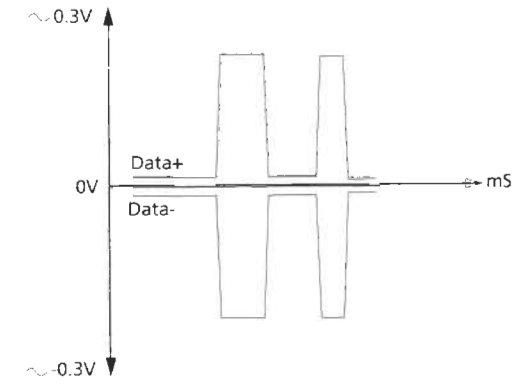

The ML data transceiver is tested by measuring at P200-6 ML RECEIVE; the signal must be identical with that measured at P200-7 ML TRANSMIT, only shifted 10-15µS in time.

The ML data transmit/receive circuit has been designed so that individual components may be defective without hampering the functioning of the circuit in general. For example, the diodes D135, D208, D209, D210, D211 and D212 are protection diodes which protect against static electricity.

During a repair the following components may therefore have to be checked/replaced:

- If one of the transistors TR213 or TR214 is defective, replace both of them; and the diodes D135, D208, D209, D210, D211 and D212 must be checked/replaced.