

Bang & Olufsen

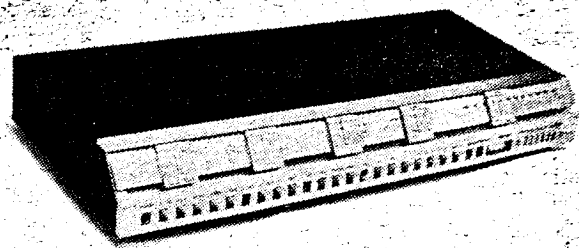

BEOMASTER 4400

TYPE 2417

BEOMASTER 4401

TYPE 2416

For Service Manuals Contact
MAURITRON TECHNICAL SERVICES
8 Cherry Tree Rd, Chinnor
Oxon OX9 4QY
Tel: 01844 351694 Fax: 01844 352554
Email: enquiries@mauritron.co.uk

SERVICE MANUAL



ABO-CENTER V/HENRIKSENS ELEKTRONIK

CONTENTS

	SECTION
Technical data	1
Adjustments	2
Electrical parts list	3
Mechanical parts list	4
Diagrams, PC-boards, transistor and diode lists	5

INTRODUCTION

This service manual comprises both Beomaster 4400 and Beomaster 4401, types 2417 and 2416.

Electrically these two apparatuses are identical. Mechanically they differ as Beomaster 4401 type 2416 has black front.

In the electrical parts lists only the left channel components are stated for the AF unit. This has been taken into account at the numbering on the diagramme. The last two digits are identical.

Left channel begins with 100, right channel with 200.

Besides a number each component is provided with a co-ordinate designation, e.g. B3. This designation refers to the placing of the component on the PC board which is divided into square sections.

The drawings of the component placing in this service manual are all shown from the copperfoil side.

TECHNICAL DATA DIN 45 500 AMPLIFIER

Power output	2 x 75 watts / 4 ohms
	2 x 50 watts / 8 ohms
Music power	2 x 110 watts / 4 ohms
	2 x 60 watts / 8 ohms
Speaker impedance	4 ohms
Harmonic distortion	< 0.05%
Intermodulation	< 0.1%
Frequency range	20 - 35,000 Hz
Damping factor	> 65
Input pickup low impedance	2.2 mV / 47 kohms
Input high impedance	200 mV / 470 kohms
Overload margin	> 31 dB
Signal-to-noise ration pickup low impedance	> 60 dB
High impedance	> 60 dB
Channel separation 1000 Hz	> 45 dB
250 - 10,000 Hz	> 35 dB
Output tape recorder	100 mV / 100 kohms
Headphones	Max. 17V / 200 ohms
Bass control at 40 Hz	± 10 dB
Treble control at 12,500 Hz	± 10 dB
HI filter	7000 Hz 12 dB / octave
Lo filter	60 Hz 12 dB / octave

FM TUNER

FM tuner range	87.5 - 108 MHz
Sensitivity stereo 46 dB	< 20 µV / 75 ohms
Frequency range	20 - 15,000 Hz
Harmonic distortion	< 0.3%
Stereo channel separation	> 35 dB
Pilot suppression 19 kHz	> 65 dB
38 kHz	> 100 dB

OTHER DATA

Power supply	110 - 130 - 220 - 240 volts
Power consumption	30 - 310 watts
Dimensions W x H x D	57,5 x 9,5 x 28 cm
Weight	10 kg

Subject to change without notice

For Service Manuals Contact
MAURITRON TECHNICAL SERVICES
 8 Cherry Tree Rd, Chinnor
 Oxon OX9 4QY
 Tel: 01844-351694 Fax: 01844-352554
 Email: enquiries@mauritron.co.uk

ADJUSTMENTS

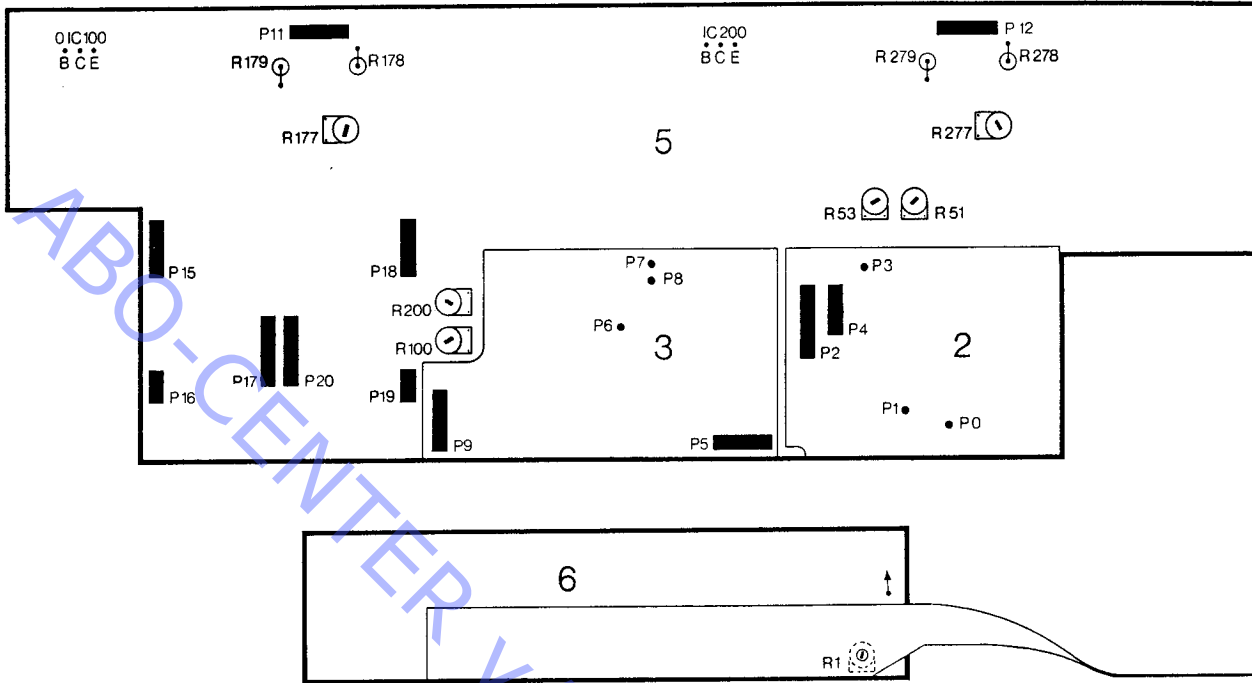

ADJUSTMENT OF NO-SIGNAL-CURRENT

Adjust no-signal-current with receiver cold and volume control turned down.

Speakers must not be connected.

With 5R177 (5R277) adjust within the area 25-40 mA in collector of 0IC100 (0IC200), or adjust to 10-15 mV measured across both emitter resistors 5R178 and 5R179 (5R278 and 5R279).

Note: If, in case of failure in the apparatus, there has been DC on the output, 5C138/238 must be replaced.

TUNING VOLTAGE

Depress FM and turn FM dial toward mechanical stop in the right side.

Adjust 2R10 to 25.5 V, measured on pin 12 on 2IC2.

Turn FM dial toward mechanical stop in the left side.

Adjust 6R1 to 4.6 V, measured on grey/white cable on pushbutton switch PC.

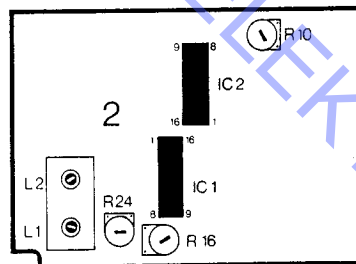
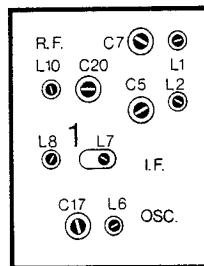

TUNER

Set dial to 89 MHz.

Set sweep generator to 89 MHz.

With 1L10, 1L1, 1L2 and 1L6 adjust to max. IF curve, measured on pin 10 of 2IC1.

Set dial to 106 MHz.

Set sweep generator to 106 MHz.

With 1C20, 1C7, 1C5 and 1C17 adjust to max. IF curve.

Check dial alignment - repeat adjustment procedure if necessary.

Set dial to 97 MHz.

Set sweep generator to 97 MHz.

With 1L7 and 1L8 adjust to max. IF curve.

IF AND DETECTOR

Set receiver to weak signal, $< 10 \mu\text{V}$. AFC off, and measure DC voltage on pin 10 of 2IC1.

Set receiver to min. DC voltage, ($< 1 \text{ V}$) on pin 10, which corresponds to correct setting on signal.

Set receiver to a strong signal, 0.5 mV .

With detector coils, 2L1 and 2L2, adjust to max. output measured on pin 5 of 2IC1.

With 2L2 may be adjusted to min. distortion, measured on pin 5 of 2IC1.

Adjust then 2R24 to 0 V between pin 5 and pin 6 of 2IC1.

For Service Manuals Contact
MAURITRON TECHNICAL SERVICES
 8 Cherry Tree Rd, Chinnor
 Oxon OX9 4QY
 Tel: 01844-351694 Fax: 01844-352554
 Email: enquiries@mauritron.co.uk

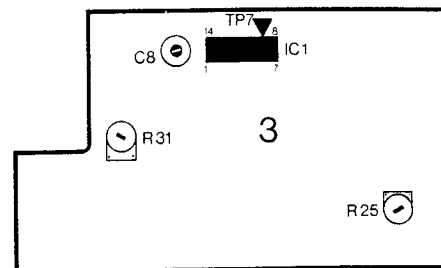
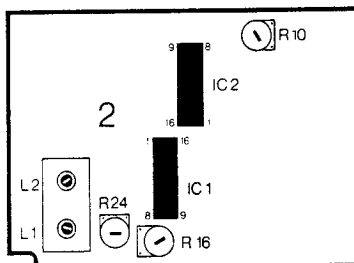

ZERO ADJUSTMENT OF RADICATOR

Depress FM button and set dial out of station. With 5R51 adjust radicator to zero.

MAX. ADJUSTMENT OF RADICATOR

Supply a signal of 0.5 mV to aerial input and set dial to receive this signal. With 5R53 adjust radicator to a deflection of 4.5.

TUNING INDICATOR

Tune in a FM station correctly. (0 V between pin 5 and pin 6 on 2IC1). Adjust with 3R25 till both lamps show identical brilliance.

LEVEL

Apply a signal of $5 \mu\text{V}$ to aerial input.

Set treble control to mid-position, AFC not to be activated.

Set receiver correctly to signal generator frequency, e.g. 97 MHz.

Adjust 2R16 so that indicator lamps just go out.

This adjustment is accessible from outside in case of special reception conditions.

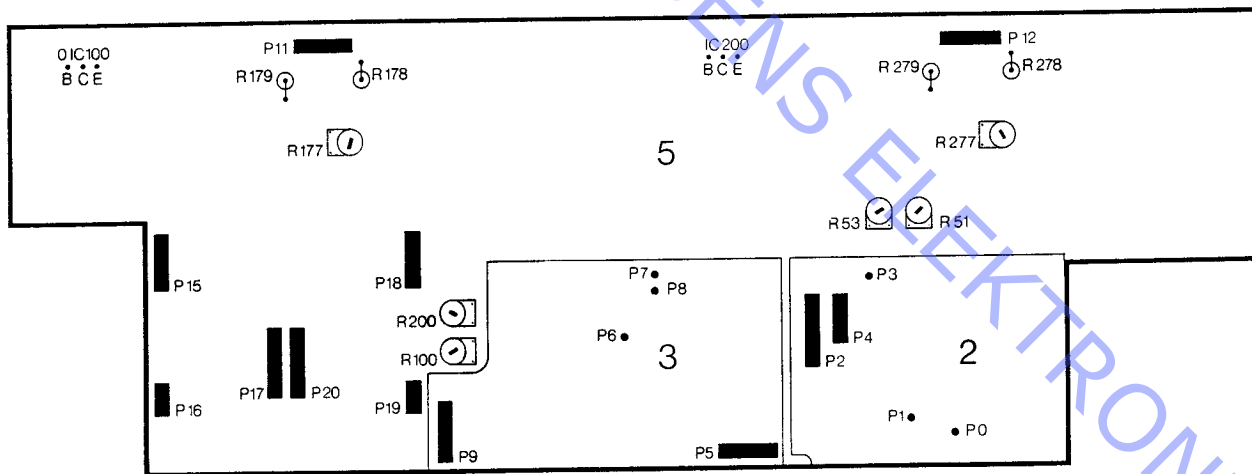

DECODER

Tune in a mono station.

With 3C8 adjust internal oscillator exactly to 19 kHz, measured on 3TP7.

The accuracy can be checked in two ways:

1. Connect frequency counter to 3TP7.
2. Connect 19 kHz from 3TP7 to Y-input on oscilloscope and 19 kHz from a stereocoder to the X-input. When the Lissajous figure is stationary, the adjustment is correct.

A third way to adjust the internal oscillator is as follows:

3. Tune in a stereo station.
 Turn 3C8 to one side until the stereo lamp turns off. Turn then 3C8 to the other side until the stereo lamp turns off. The setting midway between these two settings represents the correct adjustment.

CHANNEL SEPARATION

Connect stereo decoder to aerial input f.mod. 1 kHz, Δf 40 kHz, pilot 8-10%, AFC on.

Connect wattmeter to amplifier output.

Set treble control to min.

With 3R31 adjust to min. output in unmodulated channel.

Adjustment should be made both with unmodulated left channel and unmodulated right channel.

The coils 3L3, 3L4, 3L5, and 3L6 are factory pre-adjusted and should not be touched.

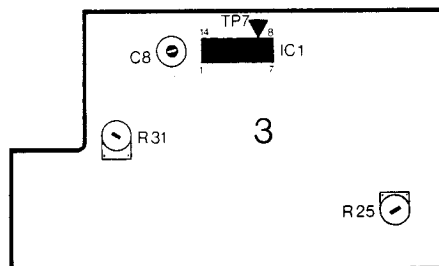

AF LEVEL ADJUSTMENT

Phono (4R112/212) may be adjusted within the area: 2 mV - 20 mV.

Tape 1 and 2 (4R126/226 and 4R119/219) may be adjusted within the area 180 mV - 2 V).

FM LEVEL ADJUSTMENT

Adjust FM (5R100/200) to rated output (75 W, volume in max., and linear button activated) at Δf 15 kHz.

ABO-CENTER HENRIKSENS ELEKTRONIK

ELECTRICAL PARTS LIST

OR100	5310067	2 x 20 KOhms LOG. VOLUME	OR102	5310065	2 x 20 KOhms LIN. TREBLE
OR101	5310066	2 x 20 KOhms SPEC. BALANCE	OR103	5310065	2 x 20 KOhms LIN. BASS

OC1	4010018	1 nF 250V	OC7	4130075	0,1 µF 20% 250V
OC2	4010018	1 nF 250V	OC8	4200351	10000 µF 50V
OC3	4010018	1 nF 250V	OC9	4200351	10000 µF 50V
OC6	4130075	0,1 µF 20% 250V			

OIL1	8230039	6V/30 mA	OF1	6600020	2,5A 250V S IEC 127
OIL2	8230064	6V/80 mA	OF2	6600020	2,5A 250V S IEC 127
OIL3	8230064	6V/80 mA			
OIL4	8230064	6V/80 mA			
OIL5	8230064	6V/80 mA			

FRONT END PC1, 8050063

R1	5001050	47 KOhms 10% 1/2W	R8	5010067	560 Ohms 5% 1/8W
R2	5010141	27 KOhms 5% 1/8W	R9	5010411	47 Ohms 5% 1/8W
R3	5010041	5,6 KOhms 5% 1/8W	R10	5001038	4,7 KOhms 10% 1/2W
R4	5001062	330 KOhms 10% 1/2W	R11	5001062	330 KOhms 10% 1/2W
R5	5001050	47 KOhms 10% 1/2W	R12	5001013	100 Ohms 10% 1/2W
R6	5001013	100 Ohms 10% 1/2W	R13	5001013	100 Ohms 10% 1/2W
R7	5010076	3,3 KOhms 5% 1/8W	R14	5001040	6,8 KOhms 10% 1/2W

C1	4010008	1 nF -20 +50% 400V	C13	4010008	1 nF -20 +50% 400V
C2	4010008	1nF -20 +50% 400V	C14	4003059	22 pF 5% 250V
C3	4010008	1 nF -20 +50% 400V	C15	4010008	1 nF -20 +50% 400V
C4	4003012	3,3 pF ± 0.25 pF 400V	C16	4130081	10 nF 20% 250V
C5	4330001	9 pF Cer.	C17	4330001	9 pF Cer.
C6	4010008	1 nF -20 +50% 400V	C18	4000089	8,2 pF ± 0.5 pF 250V
C7	4330001	9 pF Cer.	C19	4010011	8,2 pF ± 0.5 pF 400V
C8	4200107	10 µF 10V	C20	4330001	9 pF Cer.
C9	4010015	8,2 pF ± 0,25 pF 63V	C21	4101031	270 pF 5% 63V
C10	4003130	47 pF 2% 63V	C22	4010008	1 nF -20 +50% 400V
C11	4010008	1 nF -20 +50% 400V	C23	4101007	220 pF 5% 63V
C12	4010008	1 nF -20 +50% 400V			

L1	8020121	RF (prim.)	L6	8020183	OSC.
L2	8020122	RF (sec.)	L7	8020124	10.7 MHz
L3	6830052	3,8 µH 5%	L8	8020137	10.7 MHz
L4	6830052	3,8 µH 5%	L9	6830052	3,8 µH 5%
L5	6710001	Ferrit tube 3 x 1.2 x 3.5 mm	L10	8020120	Aerial coil

6702001	Ferrit-core F100 (white)
6702008	Ferrit-core F10 (red)
6479001	Glassbushing

PRE-AMPLIFIER PC4, 8052101

R1	5010079	22 KOhms 5% 1/8W	R21	5010049	100 KOhms 5% 1/8W
R2	5010046	12 KOhms 5% 1/8W	R22	5010046	12 KOhms 5% 1/8W
R3	5010048	4,7 KOhms 5% 1/8W	R23	5010065	100 Ohms 5% 1/8W
R4	5010070	390 Ohms 5% 1/8W	R24	5370128	100 KOhms 20% LIN.
R5	5010044	330 Ohms 5% 1/8W	R25	5010049	100 KOhms 5% 1/8W
R6	5010044	330 Ohms 5% 1/8W	R27	5010040	1 KOhms 5% 1/8W
R7	5010077	470 KOhms 5% 1/8W	R28	5010040	1 KOhms 5% 1/8W
R8	5010059	10 KOhms 5% 1/8W	R29	5010381	3,3 MOhms 10% 1/4W
R9	5010041	5,6 KOhms 5% 1/8W	R30	5010381	3,3 MOhms 10% 1/4W
R10	5370002	500 Ohms 20% LIN.			
R11	5010066	1,8 KOhms 5% 1/8W			
R12	5010070	390 Ohms 5% 1/8W			
R13	5010048	4,7 KOhms 5% 1/8W			
R14	5010066	1,8 KOhms 5% 1/8W			
R15	5010343	1,5 MOhms 10% 1/3W			
R16	5370058	5 KOhms 20% LIN.			
R17	5010059	10 KOhms 5% 1/+W			
R18	5010069	3,9 KOhms 5% 1/8W			
R19	5010069	3,9 KOhms 5% 1/8W			
R20	5010046	12 KOhms 5% 1/8W			

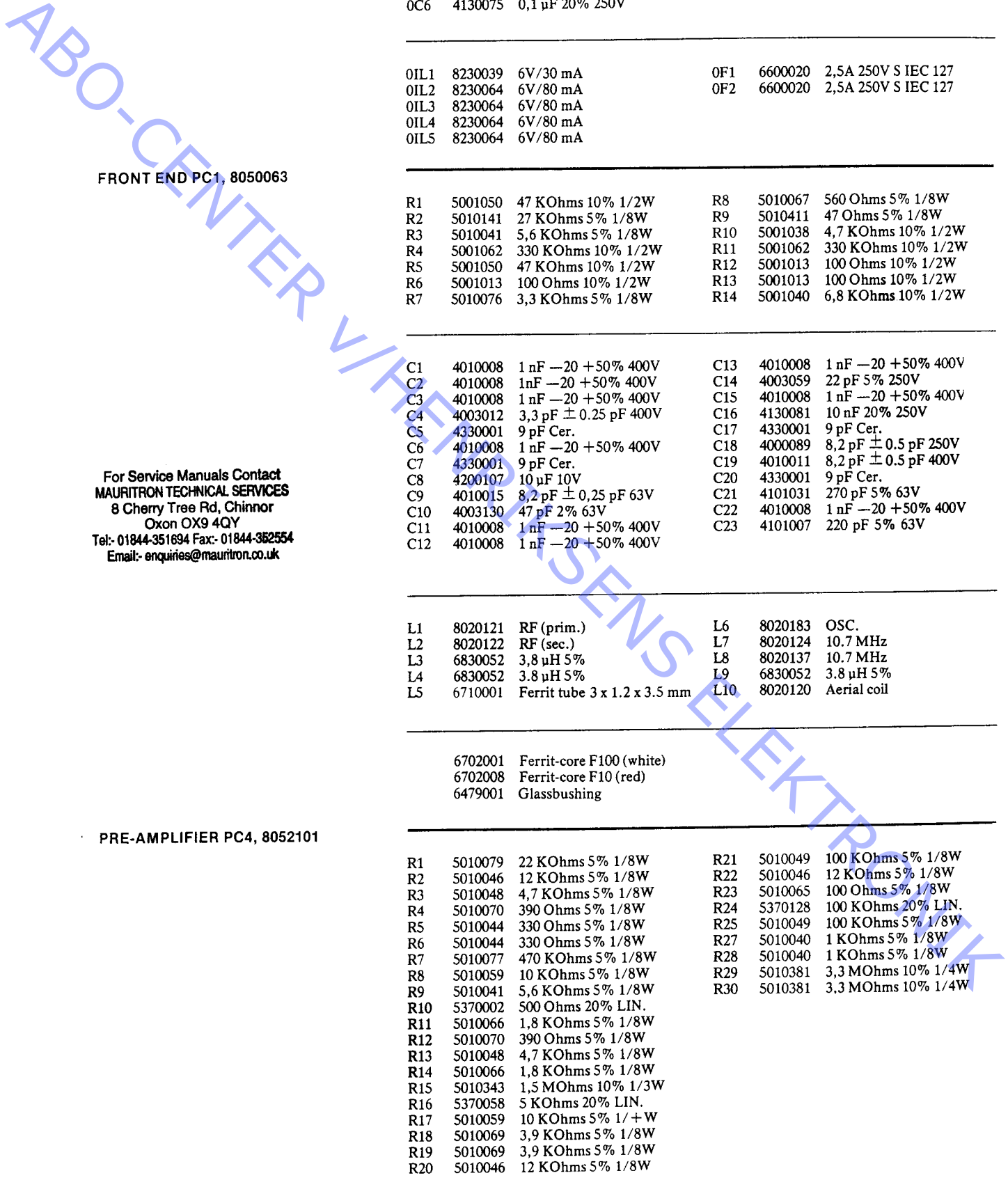

For Service Manuals Contact
MAURITRON TECHNICAL SERVICES
 8 Cherry Tree Rd, Chinnor
 Oxon OX9 4QY
 Tel:- 01844-351694 Fax:- 01844-352554
 Email:- enquiries@mauritron.co.uk

IF-SECTION PC2,
CONTD.

C1	4200298	1 μ F 63V	C9	4010060	22 nF -20 +100% 40V
C2	4011025	3,3 nF 10% 100V	C10	4201061	4,7 μ F 63V
C3	4010027	1 nF 10% 100V	C11	4000094	150 pF 5% 63V
C4	4010041	10 nF -20 +100% 40V	C12	4000094	150 pF 5% 63V
C5	4010027	1 nF 10% 100V	C13	4010060	22 nF -20 +100% 40V
C6	4010060	22 nF -20 +100% 40V	C14	4000029	220 pF 5% 63V
C7	4010041	10 nF -20 +100% 40V	C15	4130136	1 μ F 20% 100V
C8	4010041	10 nF -20 +100% 40V			

BP1	8030001	10.7 MHz	L1-		
BP2	8030001	10.7 MHz	L2	8010141	FM-Detector
BP3	8030001	10.7 MHz	L3	8020065	130 μ H

P2	7210135	Socket 6 pol.
P4	7210137	Socket 4 pol.
	7500080	Contact pin

STEREO DECODER AND INDICATOR
CIRCUIT PC3, 8002299

R1	5010045	47 KOhms 5% 1/8W	R18	5010076	3,3 KOhms 5% 1/8W
R2	5010040	1 KOhms 5% 1/8W	R19	5010091	82 KOhms 5% 1/8W
R3	5010362	180 Ohms 5% 1/8W	R20	5010144	680 Ohms 5% 1/8W
R4	5020034	18,7 KOhms 1% 1/8W	R21	5010077	470 KOhms 5% 1/8W
R5	5010053	15 KOhms 5% 1/8W	R22	5010076	3,3 KOhms 5% 1/8W
R6	5010065	100 Ohms 5% 1/8W	R23	5010091	82 KOhms 5% 1/8W
R7	5010040	1 KOhms 5% 1/8W	R24	5010144	680 Ohms 5% 1/8W
R8	5010049	100 KOhms 5% 1/8W	R25	5370049	1 MOhms 20% LIN.
R9	5010052	6,8 KOhms 5% 1/8W	R26	5001008	47 Ohms 10% 1/2W
R10	5010048	4,7 KOhms 5% 1/8W	R27	5010077	470 KOhms 5% 1/8W
R11	5010048	4,7 KOhms 5% 1/8W	R28	5010049	100 KOhms 5% 1/8W
R12	5010053	15 KOhms 5% 1/8W	R29	5010059	10 KOhms 5% 1/8W
R13	5010049	100 KOhms 5% 1/8W	R30	5010059	10 KOhms 5% 1/8W
R14	5010049	100 KOhms 5% 1/8W	R31	5370074	10 KOhms 20% LIN.
R15	5010077	470 KOhms 5% 1/8W	R32	5010069	3,9 KOhms 5% 1/8W
R16	5001008	47 Ohms 10% 1/2W	R33	5010092	220 Ohms 5% 1/8W
R17	5010077	470 KOhms 5% 1/8W			

C2	4003130	47 pF 2% 63V	C18	4130150	0,1 μ F 20% 100V
C3	4200322	4,7 μ F 63V	C19	4100077	196 pF 2,5% 63V
C4	4200099	100 μ F 16V	C20	4100077	196 pF 2,5% 63V
C5	4200322	4,7 μ F 63V	C21	4100078	4,02 nF 2,5% 63V
C6	4130087	47 nF 10% 250V	C22	4100078	4,02 nF 2,5% 63V
C7	4010031	680 pF 10% 100V	C23	4100080	866 pF 2,5% 63V
C8	4340003	5,5 - 65 pF foil	C24	4100080	866 pF 2,5% 63V
C9	4100044	440 pF 1% 63V	C25	4100079	590 pF 2,5% 63V
C10	4201057	1 μ F 35V	C26	4100079	590 pF 2,5% 63V
C11	4201058	0,47 μ F 35V	C27	4130089	22 nF 10% 10% 250V
C12	4130104	0,22 μ F 20% 100V	C28	4130089	22 nF 10% 250V
C13	4130114	0,47 μ F 10% 100V	C29	4200296	2,2 μ F 63V
C14	4200333	1 μ F 63V	C30	4200296	2,2 μ F 63V
C15	4100081	2,15 nF 2,5% 63V	C31	4130150	0,1 μ F 20% 100V
C16	4200333	1 μ F 63V	C32	4200097	220 μ F 16V
C17	4100081	2,15 nF 2,5% 63V			

L2	8022066	114 kHz	P5	7210135	Socket 6 pol.
L3	8022079	78 mH	P9	7210134	Socket 5 pol.
L4	8022079	78 mH			
L5	8022079	78 mH		7500080	Contact pin
L6	8022079	78 mH			

PRE-AMPLIFIER PC4, 8052101

R1	5010045	47 KOhms 5% 1/8W	R118	5010048	4,7 KOhms 5% 1/8W
R100	5010077	470 KOhms 5% 1/8W	R119	5370061	50 KOhms 20% LIN.
R101	5010092	220 Ohms 5% 1/8W	R120	5010064	2,2 KOhms 5% 1/8W
R102	5010045	47 KOhms 5% 1/8W	R121	5010054	1 MOhms 5% 1/8W
R103	5010044	330 Ohms 5% 1/8W	R122	5011074	2,2 MOhms 10% 1/4W
R104	5010083	270 KOhms 5% 1/8W	R123	5011071	1,5 MOhms 10% 1/4W
R105	5010047	120 KOhms 5% 1/8W	R124	5010059	10 KOhms 5% 1/8W
R106	5010066	1,8 KOhms 5% 1/8W	R125	5010048	4,7 KOhms 5% 1/8W
R107	5010092	220 Ohms 5% 1/8W	R126	5370061	50 KOhms 20% LIN.
R108	5010048	4,7 KOhms 5% 1/8W	R127	5011071	1,5 MOhms 10% 1/4W
R109	5010058	470 Ohms 5% 1/8W	R128	5011071	1,5 MOhms 10% 1/4W
R110	5010705	220 KOhms 2% 1/4W	R129	5010079	22 KOhms 5% 1/8W
R111	5020075	36,5 KOhms 1% 1/8W	R130	5010059	10 KOhms 5% 1/8W
R112	5370061	50 KOhms 20% LIN.	R131	5010047	120 KOhms 5% 1/8W
R113	5010064	2,2 KOhms 5% 1/8W	R132	5010077	470 KOhms 5% 1/8W
R114	5010054	1 MOhms 5% 1/8W	R134	5010298	2,7 KOhms 5% 1/8W
R115	5011074	2,2 MOhms 10% 1/4W	R135	5010298	2,7 KOhms 5% 1/8W
R116	5010071	1,5 MOhms 10% 1/4W	R136	5010298	2,7 KOhms 5% 1/8W
R117	5010059	10 KOhms 5% 1/8W			

For Service Manuals Contact
MAURITRON TECHNICAL SERVICES
 8 Cherry Tree Rd, Chinnor
 Oxon OX9 4QY
 Tel: 01844-351694 Fax: 01844-352554
 Email: enquiries@mauritron.co.uk

C1	4201074	47 µF 40V	C109	4010008	1 nF -20 +50% 400V
C2	4010008	1 nF -20 +50% 400V	C110	4000021	6,8 pF ± 0.25 pF 63V
C3	4010060	22 nF -20 +100% 40V	C111	4201035	2,2 µF 63V
C100	4130152	2,2 µF 10% 100V	C113	4200333	1 µF 63V
C101	4130100	68 nF 10% 250V	C114	4010008	1 nF -20 +50% 400V
C102	4000029	220 pF 5% 63V	C115	4000021	6,8 pF ± 0.25 pF 63V
C103	4000091	68 pF 2% 63V	C116	4201035	2,2 µF 63V
C104	4100076	2,7 nF 2,5% 63V	C117	4200333	1 µF 63V
C105	4100075	10 nF 2% 63V	C118	4010008	1 nF -20 +50% 400V
C106	4201035	2,2 µF 63V	C119	4000021	6,8 pF ± 0.25 pF 63V
C108	4200333	1 µF 63V	C120	4200333	1 µF 63V

P14	7210138	Socket/housing	7212013	Socket 5 pol. DIN
	7500114	Contact pin	6140115	PC for DIN-socket

**AF AMPLIFIER, POWER SUPPLY,
 MUTING AND SILENT TUNING PC5,
 8002307**

R1	5001039	5,6 KOhms 10% 1/2W	R46	5010074	680 KOhms 5% 1/8W
R2	5010069	3,9 KOhms 5% 1/8W	R47	5010074	680 KOhms 5% 1/8W
R3	5010053	15 KOhms 5% 1/8W	R50	5010076	3,3 KOhms 5% 1/8W
R4	5010059	10 KOhms 5% 1/8W	R51	5370050	1 KOhms 20% LIN.
R5	5010053	15 KOhms 5% 1/8W	R52	5010067	560 Ohms 5% 1/8W
R6	5011028	1 KOhms 5% 1/4W	R53	5370058	5 KOhms 20% LIN.
R7	5010000	270 Ohms 5% 1/8W	R101	5010076	3,3 KOhms 5% 1/8W
R8	5001001	10 Ohms 10% 1/2W	R102	5010054	1 MOhms 5% 1/8W
R10	5010506	10 Ohms 5% 1/8W	R103	5010074	680 KOhms 5% 1/8W
R11	5010075	33 KOhms 5% 1/8W	R104	5010048	4,7 KOhms 5% 1/8W
R12	5010049	100 KOhms 5% 1/8W	R105	5010048	4,7 KOhms 5% 1/8W
R13	5010638	10 MOhms 10% 1/8W	R106	5010047	120 KOhms 5% 1/8W
R14	5010047	120 KOhms 5% 1/8W	R107	5010077	470 KOhms 5% 1/8W
R15	5010154	8,2 KOhms 5% 1/8W	R110	5010047	120 KOhms 5% 1/8W
R16	5001036	3,3 KOhms 10% 1/2W	R111	5010073	390 KOhms 5% 1/8W
R17	5010045	47 KOhms 5% 1/8W	R112	5020106	1,5 KOhms 5% 1/8W
R18	5010045	47 KOhms 5% 1/8W	R113	5010048	4,7 KOhms 5% 1/8W
R19	5010045	47 KOhms 5% 1/8W	R114	5020108	3,9 KOhms 5% 1/8W
R20	5010045	47 KOhms 5% 1/8W	R115	5010615	100 KOhms 5% 1/8W
R21	5010059	10 KOhms 5% 1/8W	R116	5010067	560 Ohms 5% 1/8W
R22	5010045	47 KOhms 5% 1/8W	R117	5010141	27 KOhms 5% 1/8W
R23	5010041	5,6 KOhms 5% 1/8W	R118	5010054	1 MOhms 5% 1/8W
R24	5010708	22 Ohms 5% 1/8W	R119	5010048	4,7 KOhms 5% 1/8W
R25	5010411	47 Ohms 5% 1/8W	R120	5010048	4,7 KOhms 5% 1/8W
R26	5010045	47 KOhms 5% 1/8W	R122	5010047	120 KOhms 5% 1/8W
R27	5010063	150 KOhms 5% 1/8W	R123	5010047	120 KOhms 5% 1/8W
R28	5010048	4,7 KOhms 5% 1/8W	R124	5010048	4,7 KOhms 5% 1/8W
R29	5010135	18 KOhms 5% 1/8W	R125	5010048	4,7 KOhms 5% 1/8W
R30	5010059	10 KOhms 1/8W	R126	5010075	33 KOhms 5% 1/8W
R31	5010064	2,2 KOhms 5% 1/8W	R127	5010059	10 KOhms 5% 1/8W
R32	5010120	220 KOhms 5% 1/8W	R128	5010059	10 KOhms 5% 1/8W
R33	5011075	2,7 MOhms 5% 1/4W	R129	5010047	120 KOhms 5% 1/8W
R35	5001008	47 Ohms 10% 1/2W	R130	5010048	4,7 KOhms 5% 1/8W
R36	5010615	100 KOhms 5% 1/8W	R131	5010041	5,6 KOhms 5% 1/8W
R37	5010045	47 KOhms 5% 1/8W	R132	5010066	1,8 KOhms 5% 1/8W
R38	5010048	4,7 KOhms 5% 1/8W	R133	5010076	3,3 KOhms 5% 1/8W
R39	5010059	10 KOhms 5% 1/8W	R136	5010041	5,6 KOhms 5% 1/8W
R40	5230008	50 Ohms 30% PTC	R137	5010066	1,8 KOhms 5% 1/8W
R41	5010074	680 KOhms 5% 1/8W	R138	5010120	220 KOhms 5% 1/8W
R42	5010074	680 KOhms 5% 1/8W	R139	5010048	4,7 KOhms 5% 1/8W
R43	5010074	680 KOhms 5% 1/8W	R140	5010615	100 KOhms 5% 1/8W
R44	5010053	15 KOhms 5% 1/8W	R141	5010063	150 KOhms 5% 1/8W
R45	5010074	680 KOhms 5% 1/8W	R142	5010615	100 KOhms 5% 1/8W

AF AMPLIFIER PC5, 8002307
COND.T.

R143	5010059	10 KOhms 5% 1/8W	R167	5010059	10 KOhms 5% 1/8W
R144	5010054	1 MOhms 5% 1/8W	R168	5020089	220 Ohms 10% 0,7W
R145	5010054	1 MOhms 5% 1/8W	R169	5010135	18 KOhms 5% 1/8W
R146	5010615	100 KOhms 5% 1/8W	R170	5010135	18 KOhms 5% 1/8W
R147	5010048	4,7 KOhms 5% 1/8W	R171	5010044	330 Ohms 5% 1/8W
R148	5010046	12 KOhms 5% 1/8W	R172	5010044	330 Ohms 5% 1/8W
R149	5010048	4,7 KOhms 5% 1/8W	R173	5010039	68 Ohms 5% 1/8W
R152	5010076	3,3 KOhms 5% 1/8W	R174	5010039	68 Ohms 5% 1/8W
R153	5010144	680 Ohms 5% 1/8W	R176	5010362	180 Ohms 5% 1/8W
R154	5010079	22 KOhms 5% 1/8W	R177	5370208	100 Ohms 20% LIN.
R155	5010247	1,5 KOhms 5% 1/8W	R178	5100224	0,18 Ohms 10% 2W
R156	5010253	33 Ohms 5% 1/8W	R179	5100224	0,18 Ohms 10% 2W
R157	5010144	680 Ohms 5% 1/8W	R180	5011028	1 KOhms 5% 1/4W
R158	5010040	1 KOhms 5% 1/8W	R181	5011026	820 Ohms 5% 1/4W
R159	5010066	1,8 KOhms 5% 1/8W	R182	5011024	680 Ohms 5% 1/4W
R160	5010067	560 Ohms 5% 1/8W	R183	5011024	680 Ohms 5% 1/4W
R162	5010064	2,2 KOhms 5% 1/8W	R184	5011026	820 Ohms 5% 1/4W
R163	5010079	22 KOhms 5% 1/8W	R185	5011028	1 KOhms 5% 1/4W
R164	5001167	2,2 KOhms 10% 1/2W	R186	5020087	4,7 Ohms 10% 0.7W
R165	5010151	56 Ohms 5% 1/8W	R187	5010064	2,2 KOhms 5% 1/8W
R166	5010411	47 Ohms 5% 1/8W	R188	5010059	10 KOhms 5% 1/8W

C1	4133015	0,1 µF 10% 250V	C117	4000013	270 pF 10% 100V
C2	4200299	220 µF 40V	C118	4130109	10 nF 10% 250V
C3	4200332	2200 µF 25V	C119	4010024	470 pF 10% 100V
C4	4133015	0,1 µF 10% 250V	C120	4130100	68 µF 10% 250V
C5	4010008	1 nF -20 +50% 400V	C121	4130100	68 nF 10% 250V
C6	4200358	220 µF 63V	C122	4130109	10 nF 10% 250V
C7	4200300	1000 µF 16V	C123	4201035	2,2 µF 63V
C13	4200322	4,7 µF 63V	C124	4201035	2,2 µF 63V
C14	4200296	2,2 µF 63V	C126	4200333	1 µF 63V
C15	4200108	4,7 µF 35V	C127	4010027	1 nF 10% 100V
C16	4133015	0,1 µF 10% 250V	C128	4010021	220 pF 10% 100V
C17	4010027	1 nF 10% 100V	C129	4010024	470 pF 10% 100V
C18	4010060	22 nF -20 +100% 40V	C130	4000021	6,8 ± 0.25 pF 63V
C19	4010060	22 nF -20 +100% 40V	C131	4000013	270 pF 10% 100V
C20	4130136	1 µF 20% 100V	C132	4200333	1 µF 63V
C21	4130136	1 µF 20% 100V	C133	4011025	3,3 nF 10% 100V
C100	4201035	2,2 µF 63V	C134	4201060	100 µF 40V
C101	4000013	270 pF 10% 100V	C135	4130109	10 nF 10% 250V
C102	4000021	6,8 pF ± 0,25 pF 63V	C136	4010060	22 nF -20 +100% 40V
C103	4200322	4,7 µF 63V	C137	4010060	22 nF -20 +100% 40V
C104	4200333	1 µF 63V	C138	4200364	47 µF 10V
C105	4000013	270 pF 10% 100V	C139	4010041	10 nF -20 +100% 40V
C106	4000021	6,8 pF ± 0,25 pF 63V	C140	4000086	5,6pF ± 0,25pF 100V
C107	4130136	1 µF 20% 100V	C141	4000063	47 pF 2% 63V
C108	4201035	2,2 pF 63V	C143	4010041	10 nF -20 +100% 63V
C109	4130100	68 nF 10% 250V	C144	4010060	22 nF -20 +100% 40V
C110	4130100	68 nF 10% 250V	C145	4010027	1 nF 10% 100V
C111	4130141	8,2 nF 10% 250V	C146	4201060	100 µF 40V
C112	4011025	3,3 nF 10% 100V	C147	4201060	100 µF 40V
C113	4000021	6,8 pF ± 0,25 pF 63V	C148	4010027	1 nF 10% 100V
C114	4200322	4,7 µF 63V	C149	4133015	0,1 µF 10% 250V
C115	4200322	4,7 µF 63V	C150	4133015	0,1 µF 10% 250V
C116	4201035	2,2 µF 63V	C151	4133015	0,1 µF 10% 250V
			C153	4010063	4,7 nF 10% 63V

RL1	7600032	Relay 14,5V	L100	6850114	0,5 µH
-----	---------	-------------	------	---------	--------

P2	7220126	6 pins	P16	7220122	3 pins
P4	7220125	4 pins	P17	7220124	8 pins
P5	7220127	5 pins	P18	7220115	6 pin
P9	7220127	5 pins	P19	7220122	3 pins
P11	7500080	Contact pin	P20	7220124	8 pins
P12	7500080	Contact pin		7500127	Crimp contact for transistors
P15	7220115	6 pins			

AERIAL INPUT PC7, 8002326

C1 4010008 1 nF -20 +50% 400V
 C2 4010008 1 nF -20 +50% 400V

L1 8010142 240 - 75 Ohms

LOUDNESS PC8, 8002304

R10 5010154 8,2 KOhms 5% 1/8W
 R11 5010092 220 Ohms 5% 1/8W
 R12 5010064 2,2 KOhms 5% 1/8W

C10 4201069 2,2 uF 35V
 C11 4010061 2,2 nF 10% 63V

P13 7210157 Socket
 0593070 Solder lug

PUSHBUTTON SWITCH PC 6 AND 9,
7400144

6R1 5370173 2,5 KOhms 20% LIN.
 6R2 5010298 2,7 KOhms 5% 1/8W
 6R4 5011015 150 Ohms 5% 1/4W
 6R5 5011013 100 Ohms 5% 1/4W
 6R6 5010061 56 KOhms 5% 1/8W
 6R7 5010043 1 KOhms 5% 1/8W
 9R1 5010061 56 KOhms 5% 1/8W
 9R100 5002016 180 Ohms 10% 1W
 9R200 5002016 180 Ohms 10% 1W

P13 7220120 12 pins
 6140116 Flexible PC-board

For Service Manuals Contact
MAURITRON TECHNICAL SERVICES
 8 Cherry Tree Rd, Chinnor
 Oxon OX9 4QY
 Tel: 01844-351694 Fax: 01844-352554
 Email: enquiries@mauriton.co.uk

MECHANICAL PARTS LIST

1	2043007	Screw AM 4 x 6 DIN 965, black	47	8450016	Indicator	92	2641061	Bushing
2	2042203	Screw AM 4 x 5 DIN 84	48	8450021	Indicator, black	93	2641062	Locking plate
3	3470071	Bracket	49	3151042	Bronze spring	94	2034029	Screw AM 2 x 4 DIN 963, black
4	2390036	Locking ring		2568321	End piece			
5	2775070	Pushbutton		2568347	End piece, black	95	2622014	Fibre washer
	2775198	Pushbutton, black	50	2568431	Front moulding	96	2038926	Screw AM 3 x 6 DIN 84, black
6	2819017	Spring		2568432	Front moulding, black			
7	2830029	Shaft	51	3015046	Slide	97	2620028	Rubber washer
8	3164061	Cover plate		3015075	Slide, black	98	2622015	Washer
	3164137	Cover plate, black	52	3302119	Screen TUNING	99	2038208	Screw AM 3 x 5 DIN 84
9	7212018	Jack-socket		3302098	Screen TUNING, black	100	3152063	Holder
10	2622157	Washer	53	3190066	Pointer	101	2938034	Insulation bushing
11	2530132	Bracket	54	3015011	Slide	102	2542430	Bracket
12	2380078	Nut		3015037	Slide, black	103	3152025	Holder
13	3341002	Cover plate	55	3191081	Front moulding	104	2042936	Screw AM 4 x 6 DIN 84, black
	3341007	Cover plate, black		3191079	Front moulding, black			
14	2042945	Screw AM 4 x 6 DIN 963	56	2794023	Wheel	105	0585027	Rubber foot
15	2568322	End piece		2794031	Wheel, black	106	2620028	Rubber washer
	2568348	End piece, black	57	2039007	Screw, AM 3 x 3 DIN 7985	107	5300098	Potentiometer
16	2038248	Screw AM 3 x 4 DIN 84, black	58	2038201	Screw AM 3 x 3 DIN 84	108	3454210	Bottom plate
			59	7400144	Pushbutton switch, complete	109	3470070	Bracket
17	2038248	Screw AM 3 x 4 DIN 84, black	60	2542141	Bracket	110	2038068	Screw AM 3 x 35 DIN 84, black
			61	2816034	Holder	111	3152006	Holder
18	3302263	Screen, VOLUME	62	2042201	Screw AM 4 x 4 DIN 84		2576001	Spacer
	3302094	Screen, VOLUME, black	63	2038248	Screw AM 3 x 4 DIN 84, black	112	2043007	Screw AM 4 x 6 DIN 965, black
19	3302262	Screen BASS	64	2622041	Washer	113	7211042	Socket
	3302095	Screen BASS, black	65	3031022	Bracket	114	7210128	Socket/housing
20	3302264	Screen	66	5320010	Potentiometer		7500114	Contact pin
	3302265	Screen, black		5320018	Potentiometer, black	115	7210113	Socket/housing
21	3302110	Screen	67	2038051	Screw AM 3 x 4 DIN 84, black		7500114	Contact pin
	3302092	Screen, black				116	7210155	Socket/housing
22	8013164	Mains transformer	68	2810017	Spring		7500114	Contact pin
23	2514030	Clamp	69	2039007	Screw AM 3 x 3 DIN 7985	117	2568382	Heat sink
24	2938095	Rubber bushing	70	2542444	Bracket	118	2038067	Screw AM 3 x 22 DIN 84, black
25	2038248	Screw AM 3 x 4 DIN 84, black	71	2380047	Nut M7 x 0.75			
			72	2542140	Bracket	119	2568381	Heat sink, milled
26	2932075	Bushing	73	2013200	Screw 2.9 x 6.5 DIN 7981	120	2043005	Screw AM 4 x 6 DIN 7985, black
27	7530077	Solder tag	74	2038241	Screw AM 3 x 40 DIN 84			
28	2576050	Spacer	75	2389032	Nut	121	2625003	Tooth-lock washer
29	2038248	Screw AM 3 x 4 DIN 84, black	76	2624032	Spring washer	122	2042240	Screw AM 4 x 10 DIN 84, black
			77	2622117	Washer			
30	2530147	Bracket	78	2938109	Bushing	123	2530190	Bracket
31	3370077	Window, red	79	2622250	Mica sheet	124	7500084	Contact pin
32	3302112	Holder	80	2038267	Screw AM 3 x 16 DIN 84, black	125	3412503	Cabinet, rosewood
33	3370078	Window, red					3412504	Cabinet, oak
34	3164052	Cover	81	7400102	Switch		3412491	Cabinet, teak, black front
35	3302260	Screen BALANCE	82	2013024	Screw 2.9 x 6.5 DIN 7981, black		3412493	Cabinet, rosewood, black front
	3302097	Screen BALANCE, black				126	7210058	Socket/housing
36	2013203	Screw 2.9 x 13 DIN 7981	83	3452283	Back plate		7500084	Contact pin
37	8022044	Ambio filter	84	2039113	Screw AM 3 x 12 DIN 9788	127	2576050	Spacer
38	8300274	Bracket, mounted	85	3164249	Cover (4400)	128	3358027	Heat sink
39	2510081	Clamp		3164238	Cover (4401)	129	2013063	Screw 2.9 x 6.5, black
40	2380011	Nut M3	86	3131016	Housing	130	2622014	Fibre washer
41	2622022	Washer	87	2390020	Locking plate	131	2380011	Nut M3
42	7210138	Socket/housing	88	2038258	Screw AM 3 x 5 DIN 84, black	132	2038951	Screw AM 3 x 6 DIN 963
	7500114	Contact pin				133	2013008	Screw 2.9 x 6.5 DIN 7982, black
43	3302125	Screen	89	3120192	Mounting plate			
44	3300018	Housing		7500033	Fuse holder	134	2039010	Screw AM 3 x 6 DIN 7985, black
45	7450010	Mains switch		6600020	Fuse 2,5A/250V slow			
46	2038051	Screw AM 3 x 3 DIN 84, black	90	7401001	Mains-voltage switch	135	2938091	Bushing
			91	2013213	Screw 2.9 x 9.5 DIN 7981, black	136	2622015	Washer
						137	2013200	Screw 2.9 x 6.5 DIN 7981

PARTS NOT SHOWN

3391486	Outer carton
3391487	Top/bottom insert
3397069	Foam packing
3629006	Screwdriver
3532116	Diagram
3955001	Dial cord
6271101	Mains lead with euro-plug
7211019	DIN-socket (loudspeaker)
7211041	DIN-socket (Aerial 75 Ohms)

For Service Manuals Contact
MAURITRON TECHNICAL SERVICES
8 Cherry Tree Rd, Chinnor,
Oxon OX9 4QY
Tel: 01844-351694 Fax: 01844-352554
Email: enquiries@mauritron.co.uk

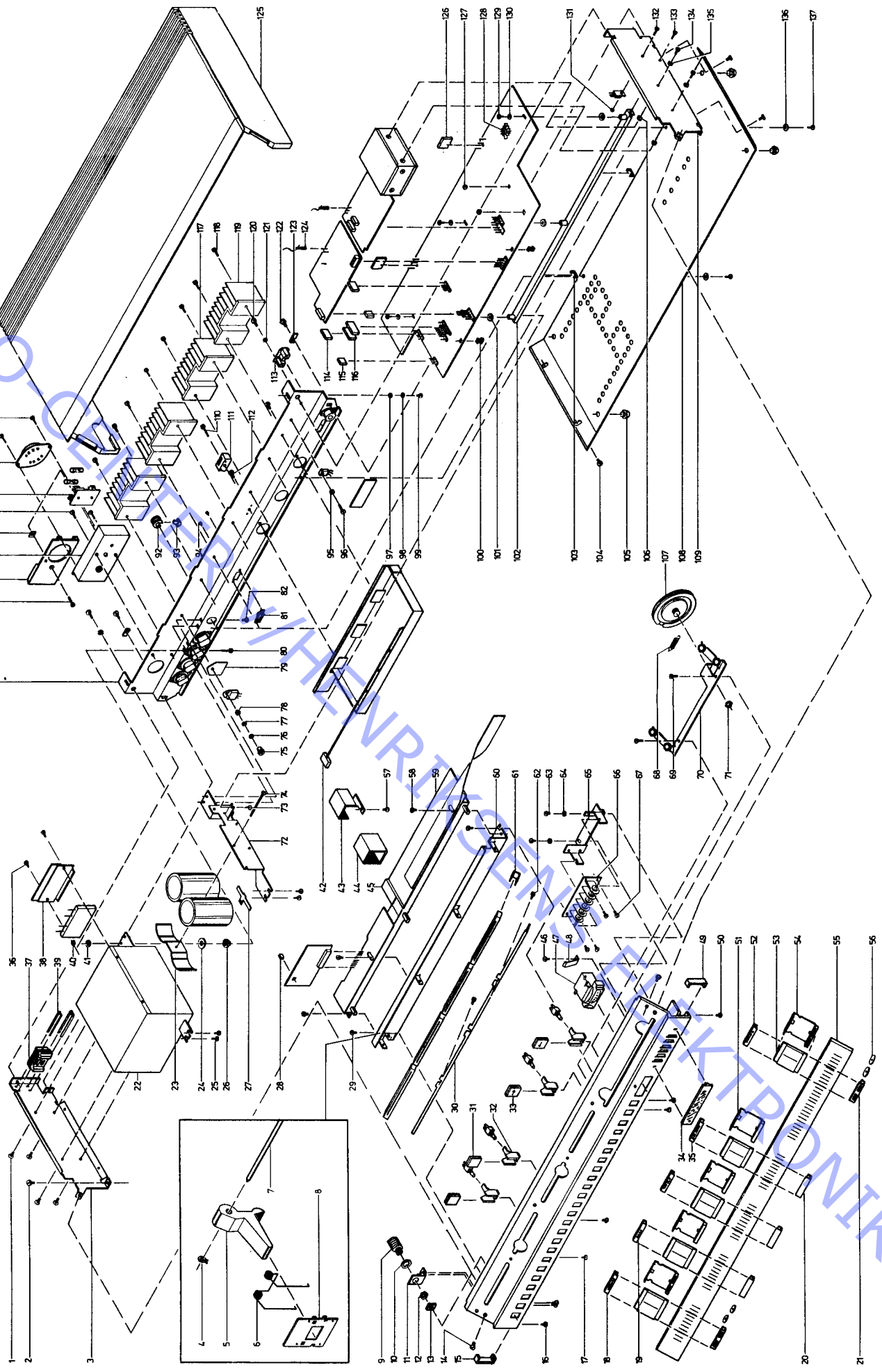

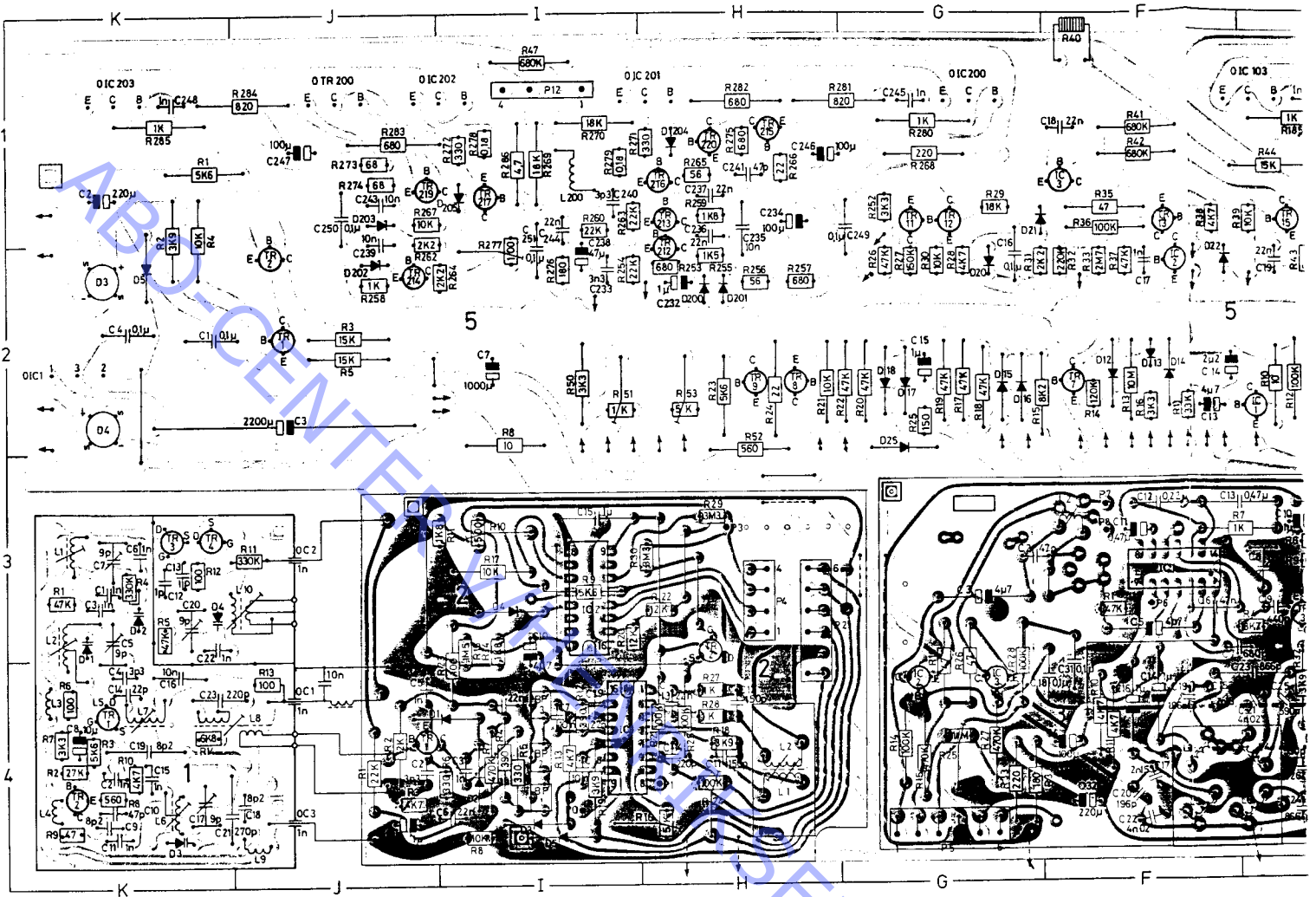

For Service Manuals Contact
MAURITRON TECHNICAL SERVICES
 8 Cherry Tree Rd, Chinnor
 Oxon OX9 4QY
 Tel:- 01844-351694 Fax:- 01844-352554
 Email:- enquiries@mauritron.co.uk

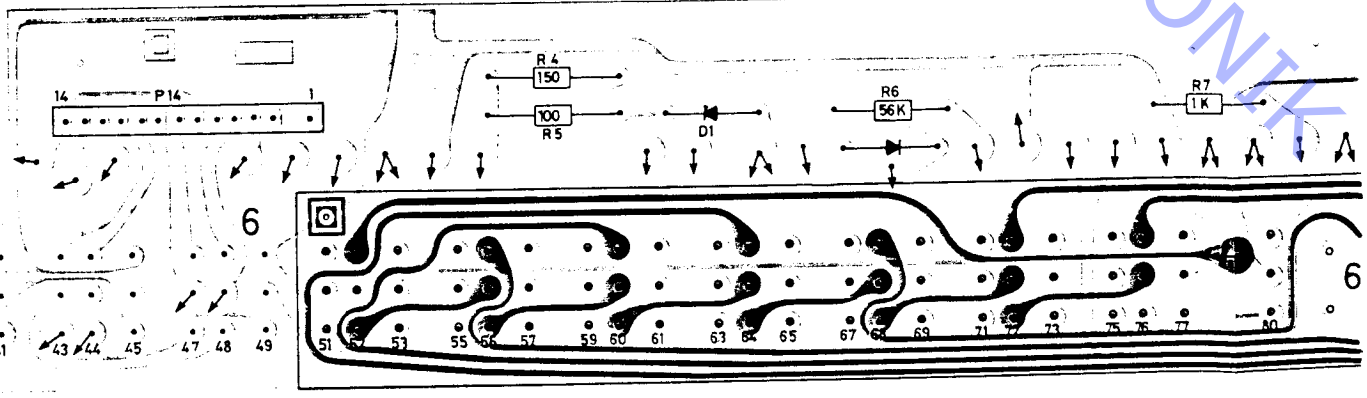
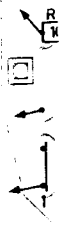

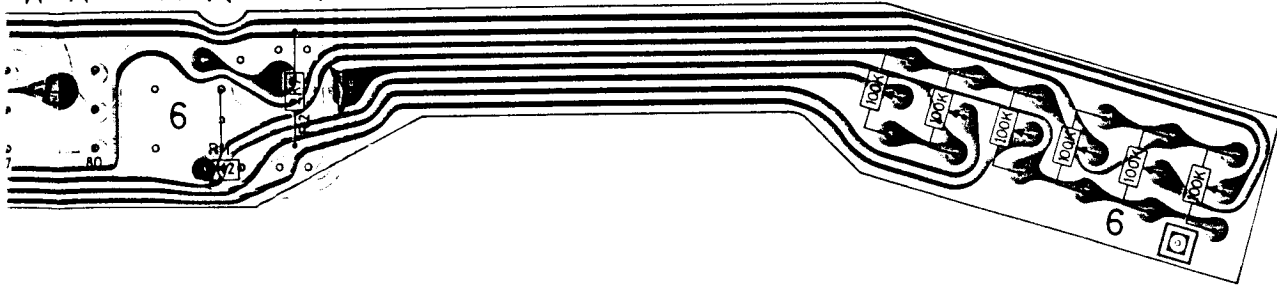
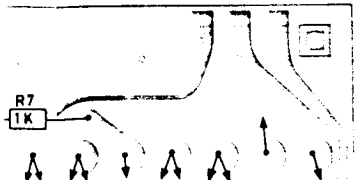
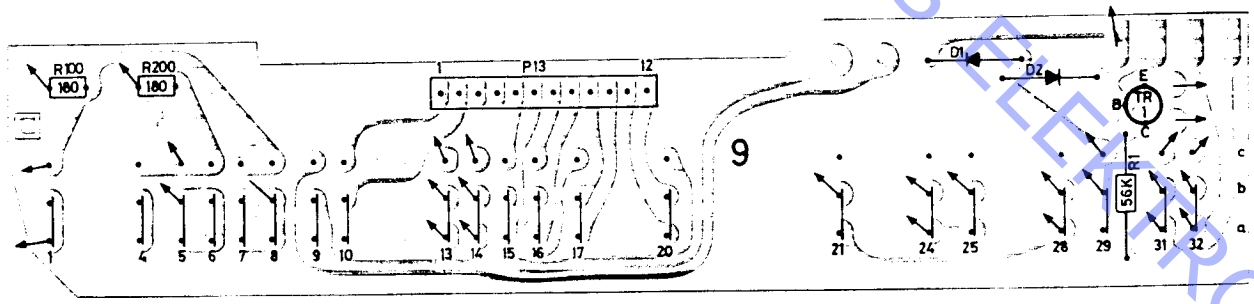
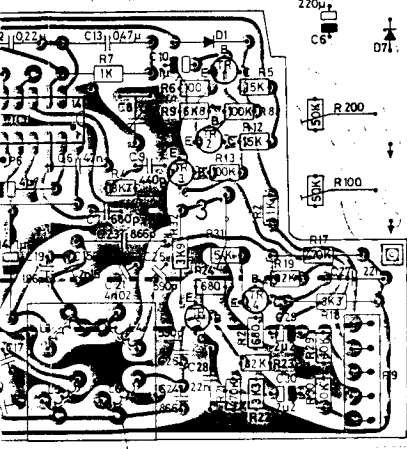
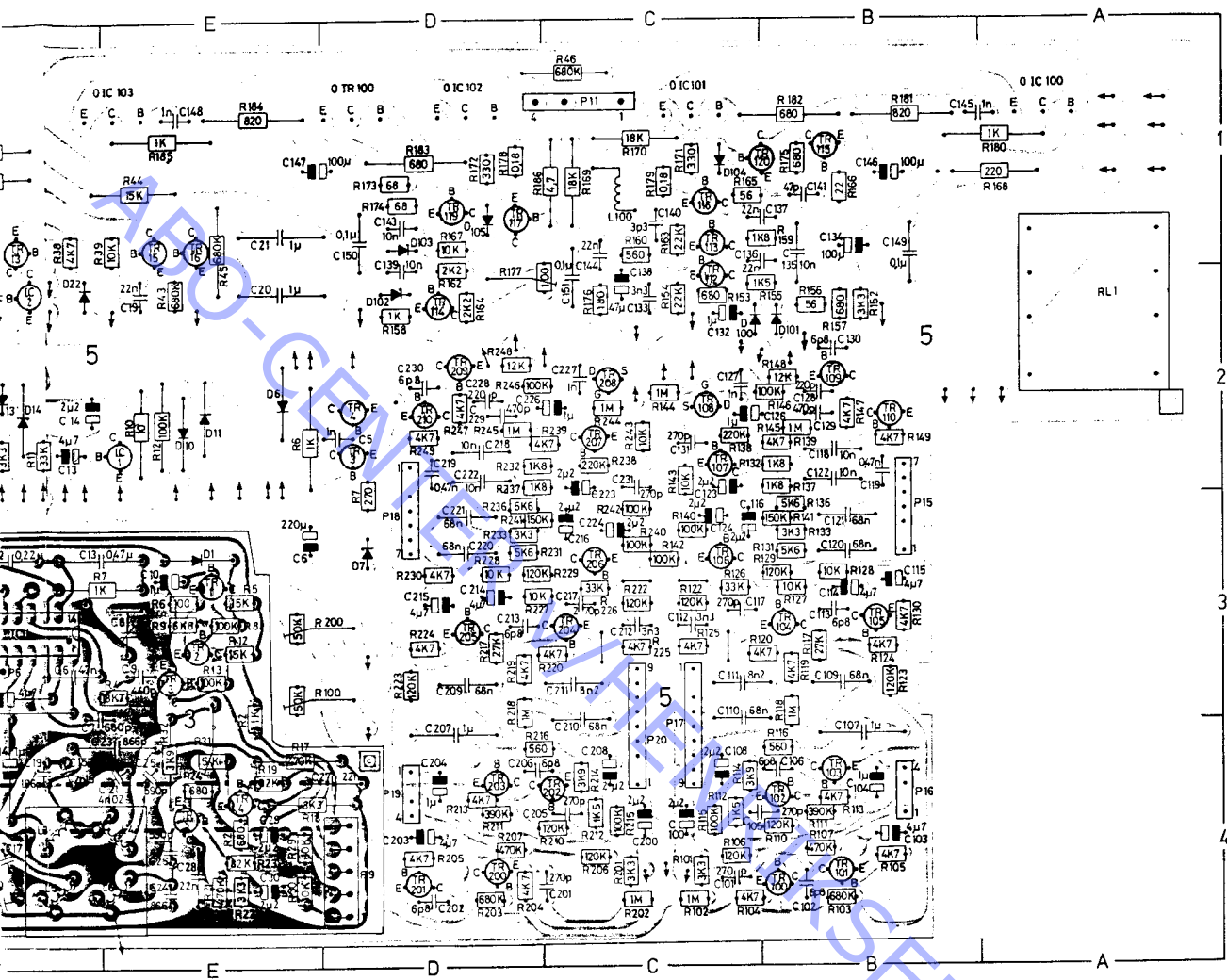

For Service Manuals Contact
MAURITRON TECHNICAL SERVICES
 8 Cherry Tree Rd, Chinnor
 Oxon OX9 4QY
 Tel: 01844-351694 Fax: 01844-352554
 Email: enquiries@maurtron.co.uk

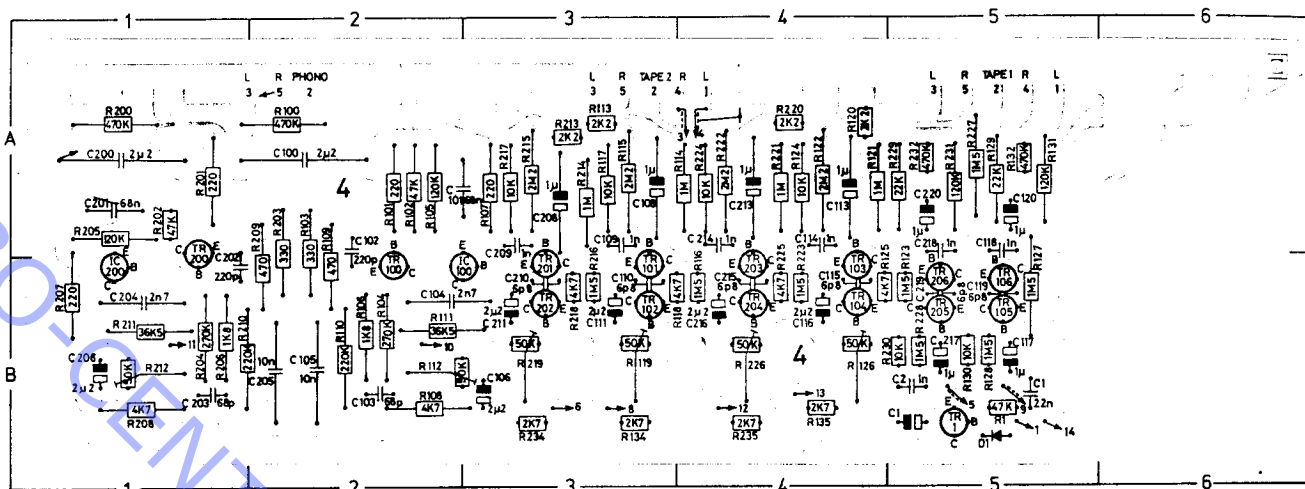

For Service Manuals Contact
MAURITRON TECHNICAL SERVICES
 8 Cherry Tree Rd, Chinnor
 Oxon OX9 4QY
 Tel: 01844-351694 Fax: 01844-352554
 Email: enquiries@mauritron.co.uk

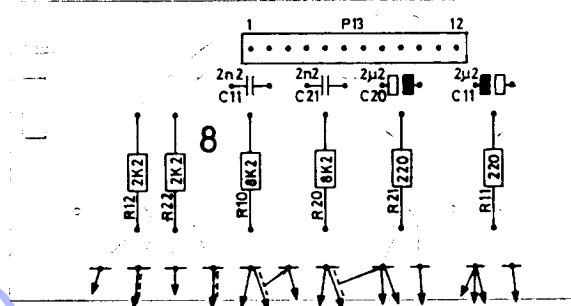

MÅLEBETINGELSER FOR DIAGRAM

DC spændinger er målt i forhold til stel med voltmeter (indre modstand 11 Mohm).
 Spændingerne er målt med FM knappen nedtrykket og et antennesignal på 0,5 mV (1 mV EMK), med pilot, uden modulation...
 FM signalniveauer er målt ved Δf 40 kHz, f mod. 1 kHz og antennesignal på 0,5 mV (1 mV EMK).
 LF følsomheder er målt ved 75 W output.
 Balance, bas, diskant på 0, volume på max.
 Udgang belastet med 4 Ohm, input 1 kHz.

MEASURING CONDITIONS FOR DIAGRAM

DC voltages are measured in relation to chassis with voltmeter (inner resistance 11 MOhms).
 Voltages are measured with FM button depressed and an aerial signal of 0,5 mV (1 mV EMK), with pilot, without modulation.
 FM signal levels are measured at Δf 40 kHz, f mod. 1 kHz, and aerial signal of 0,5 mV (1 mV EMK).
 AF sensitivities are measured at 75 W output.
 Output loaded with 4 Ohms, input 1 kHz.

MESSBEDINGUNGEN FÜR SCHALTBILD

DC Spannungen sind im Verhältnis zu Chassis mit Voltmeter (innerer Widerstand 11 MOhm) gemessen.
 Die Spannungen sind mit den FM Knopf eingedrückt und ein Antennensignal von 0,5 mV (1 mV EMK), mit Pilotton, ohne Modulation, gemessen.
 FM Signalniveaus sind bei Δf 40 kHz, f mod. 1 kHz und Antennensignal von 0,5 mV (1 mV EMK) gemessen.
 NF Empfindlichkeiten sind bei 75 W Output gemessen.
 Balance, Tiefton, Diskant auf 0, Volume auf max.
 Ausgang mit 4 Ohm belastet, Ausgang 1 kHz.

TRANSISTOR AND IC LIST

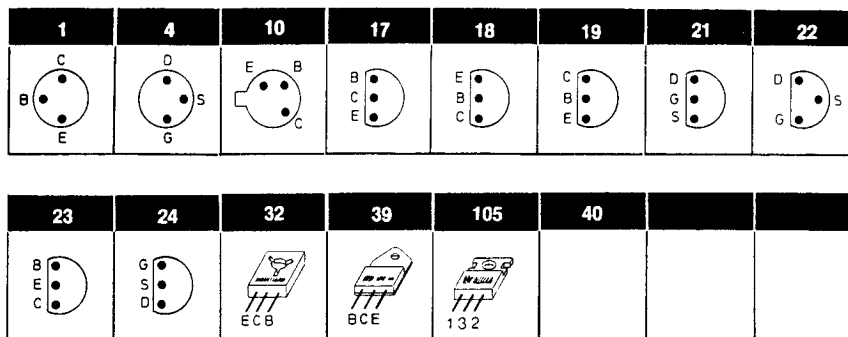

OTR100/200	8320383	32	ON 595
		32	BO 135
		32	BD 165 S
OIC1	8340064	105	LM 340-15V
		105	7815 CU
		105	PA 7815C
OIC100/200	8340042	39	TIP 141
OIC101/201			
OIC102/202	8340041	39	TIP 146
OIC103/203			
1TR1	8320136	21	TIS 88A
		21	3C2
		4	U1981E
		22	3C2P
		21	2N5245
1TR2	8320112	23	BF 495
		23	BF 255
1TR3	8320119	21	TIS 88A
1TR4		21	2N 5245
		4	U 1981 E
2TR1	8320311	23	BF 240
2TR2	8320289	24	2N 5458
2IC1	8340033		TCA 420 A
2IC2	8340090		TCA 750
3TR1	8320097	18	BC 547 B
3TR2		18	BC 237 B
3TR3		18	BC 171 B
		19	BC 317 B
		18	BC 182 B
		17	BC 182 BL
		1	BC 207 B
3TR4	8320285	18	BC 183 C
3TR5		17	BC 183 CL

3IC1	8340103		MC 1310
			MC 1310 N
			VA 1310
3IC2	8340043	19	MPSA 13
3IC3			
4TR1	8320092	1	BC 207 B
		18	BC 237 B
		18	BC547 B
		18	BC 182 B
		17	BC 182 BL
4TR100/200*	8320344	18	BC 550 B
		18	BC 384 BN
4TR101/201*	8320095	18	BC 549 B
		18	BC 184 BN
4TR102/202	8320069	18	BC 559 B
		18	BC 214 B
		17	BC 214 BL
		18	BC 309 B
		18	BC 253 B
4TR103/203*	8320095	18	BC 549 B
		18	BC 184 BN
4TR104/204*	8320069	18	BC 559 B
		18	BC 214 B
		17	BC 214 BL
		18	BC 309 B
		18	BC 253 B
4TR105/205	8320095	18	BC 549 B
		18	BC 184 BN
4TR106/206	8320069	18	BC 559 B
		18	BC 214 B
		17	BC 214 BL
		18	BC 309 B
		18	BC 253 B
4IC100/200	8340054	19	MPSA 13

5TR1	8320242	18	BC 256 B
5TR2	8320148	10	BC 142
5TR3	8320092	1	BC 207 B
5TR4		18	BC 237 B
		18	BC 547 B
		18	BC 182 B
		17	BC 182 BL
5TR7	8320152	18	BC 212 B
		17	BC 212 BL
		10	BC 261 B
		18	BC 251 B
		18	BC 307 B
5TR8	8320108	10	BC 108 B
		18	BC 172 B
		1	BC 113
		18	BC 238 B
		18	BC 548 B
		18	BC 183 B
		17	BC 183 BL
		19	MPS 6515
		1	BC 114
5TR9	8320316	18	BC 327
5TR11	8320152	18	BC 212 B
		17	BC 212 BL
		10	BC 261 B
		18	BC 251 B
		18	BC 307 B
5TR12	8320097	18	BC 547 B
		18	BC 237 B
		18	BC 171 B
		19	BC 317 B
		18	BC 182 B
		17	BC 182 BL
		1	BC 207 B
5TR13	8320104	18	BC 558 B
		18	BC 308 B
		18	BC 212 B
		17	BC 212 BL
		18	BC 252 B

5TR15	8320108	10	BC 108 B
5TR16		18	BC 172 B
		1	BC 113
		18	BC 238 B
		18	BC 548 B
		18	BC 183 B
		17	BC 183 BL
		19	MPS 6515
		1	BC 114
5TR100/200*8320095		18	BC 549 B
		18	BC 184 BN
5TR101/201 8320069		18	BC 559 B
		18	BC 214 B
		17	BC 214 BL
		18	BC 309 B
		18	BC 253 B
5TR102/202*8320095		18	BC 549 B
		18	BC 184 BN
5TR103/203 8320069		18	BC 559 B
		18	BC 214 B
		17	BC 214 BL
		18	BC 309 B
		18	BC 253 B
5TR104/204*8320095		18	BC 549 B
		18	BC 184 BN
*Specially selected specimen.			

5TR105/205 8320069	18	BC 559 B
	18	BC 214 B
	17	BC 214 BL
	18	BC 309 B
	18	BC 253 B
5TR106/206*8320344	18	BC 550 B
5TR107/207	18	BC 384 BN
5TR108/208 8320289	24	2N 5458
5TR109/209*8320095	18	BC5493
	18	BC 184 BN
5TR110/210 8320069	18	BC 559 B
	18	BC 214 B
	17	BC 214 BL
	18	BC 309 B
	18	BC 253 B
5TR112/212*8320382	18	BC 547 C
5TR113/213	18	BC 182 B
	17	BC 182 BL
	18	BC 237
5TR114/214 8320097	18	BC 547 B
	18	BC 237 B
	18	BC 171 B
	19	BC 317 B
	18	BC 182 B
	17	BC 182 BL
	1	BC 207 B

5TR115/215 8320365	19	MPSH 54
5TR116/216 8320108	10	BC 108 B
	18	BC 172 B
	1	BC 113
	18	BC 238 B
	18	BC 548 B
	18	BC 183 B
	17	BC 183 BL
	19	MPS 6515
	1	BC 114
5TR117/217 8320104	18	BC 558 B
	18	BC 308 B
	18	BC 212 B
	17	BC 212 BL
	18	BC 252 B
5TR119/219 8320321	19	MPSA 06
5TR120/220		
5IC1	8340025	18 BC 516
5IC2		19 MPSA 65
5IC3		19 SPS 5431
9TR1	8320152	18 BC 212 B
		17 BC 212 BL
		10 BC 261 B
		18 BC 251 B
		18 BC 307 B

DIODE LIST

For Service Manuals Contact
MAURITRON TECHNICAL SERVICES
 8 Cherry Tree Rd, Chinnor
 Oxon OX9 4QY
 Tel: 01844-351694 Fax: 01844-352554
 Email: enquiries@maurtron.co.uk

0D5	8310023	B80C5000/3000
0D6	8300195	TIL 209 A
		LED-5075 B
1D1-1D2	8300041	BB 103 green
1D3 - 1D4	8300050	BB 103 blue
2D1 - 2D3	8300058	IN 4148
		SFD 184
2D4	8300283	6,4V 5%
2D5	8300058	IN 4148
		SFD 184
3D1	8300058	IN 4148
		SFD 184
4D1	8300058	IN 4148
		SFD 184
5D3-5D4	8300155	B40C800
		B80C800
5D5-5D6	8300058	IN 4148
		SFD 184
5D7	8300033	ZPD 22V -5%
		BZX 79 -22V

5D10 - 5D13	8300058	IN 4148
		SFD 184
5D14	8300029	ZPD 12V -5%
		BZX 79 -12V
5D15 - 525	8300058	IN 4148
		SF 184
5D100/200	8300212	IN 4448
5D101/201		IN 916 B
5D102/202	8300222	ZPD 2,7V -5%
		BZX 83 -2,7V
5D103/203	8300029	ZPD 12V -5%
		BZX 79 -12V
5D104/204	8300058	IN 4148
5D105/205		SFD 184
6D1	8300128	ZPD 5,6V -5%
		BZX 79 -5,6V
6D2	8300058	IN 4148
		SFD 184
9D1-9D2	8300058	IN 4148
		SFD 184

FM SIGNALNIVEAUER/
FM SIGNAL LEVELS/
UKW SIGNALNIVEAUS

2TP1 20 mV
2TP2 500 mV
2TP3 50 mV

FØLSOMHEDER/SENSITIVITIES/
EMPFINDLICHKEITEN

4TP100/200	2,2 mV	5TP102/202	538 mV
4TP101/201	200 mV		492 mV pos. linear
4TP102/202	200 mV	5TP103/203	538 mV
5TP100/200	166 mV	5TP104/204	492 mV
	152 mV pos. linear	5TP105/205	492 mV
5TP119/219	149 mV	5TP120/220	492 mV
	136 mV pos. linear	5TP107/207	443 mV

TESTPUNKTER/TESTPOINTS/
TESTPUNKTE

3TP7 19 kHz
5TP109/209 2,0 V DC measured in rel. to -35V
5TP110/210 -2,0 V DC measured in rel. to 5TP113/213
5TP111/211 0 V ± 50 mV
5TP112/212 -2,0 V DC measured in rel. to 5TP113/213
5TP113/213 -0,7 V DC measured in rel. to 5TP114/214
5TP115/215 0,65 V DC measured in rel. to -35V
5TP117/217 10 - 15 mV DC measured across both emitter resistors 5R178 and 5R179 (5R278 and 5R279)

PC 5 TESTPUNKTER/TESTPOINTS/
TESTPUNKTE

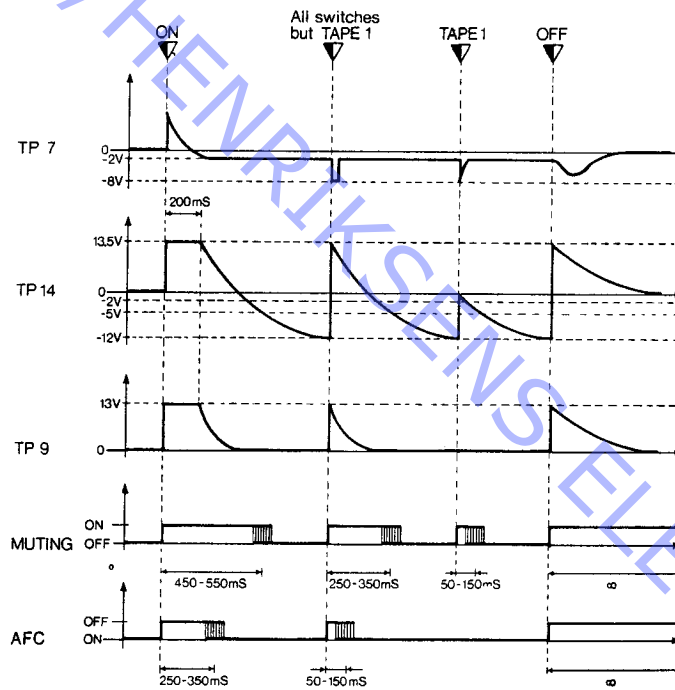

Conditions	FM or P1 - P6 ON, TAPE1 OFF						TAPE 1	FM & P1-P6
	V _{ant} > 10µV				V _{ant} < 2.5µV			
	AFC-ST. ON		AFC-ST. OFF		AFC-ST.	AFC-ST.		
	Indicator balance	Indicator max.off bal.	Indicator balance	Indicator max.off bal.	ON	OFF		
INDICATOR	Balance	OFF Bal.	Balance	OFF Bal.	OFF	OFF	OFF	OFF
MUTING	OFF	ON	OFF	OFF	ON	OFF	OFF	ON
TP6	4.6V	4.6V	4.6V	4.6V	4.6V	4.6V	OFF	0V
TP9	0V	0V	15V	15V	0V	15V	OFF	0V
TP10	11V	11V	15V	15V	0V	0V	15V	15V
TP20	2.75V	2.75V	2.75V	2.75V	0V	0V	OFF	0V
TP14	-12V	> 0V	-12V	-12V	> 0V	-12V	-12V	-12V
TP11	4.5V	4.5V	4.5V	4.5V	8V	8V	OFF	8V
TP12	11V	9V/13V	11V	9V/13V	15V	15V	OFF	15V
TP13	11V	13V/9V	11V	13V/9V	15V	15V	OFF	15V

