

Antriebsschema

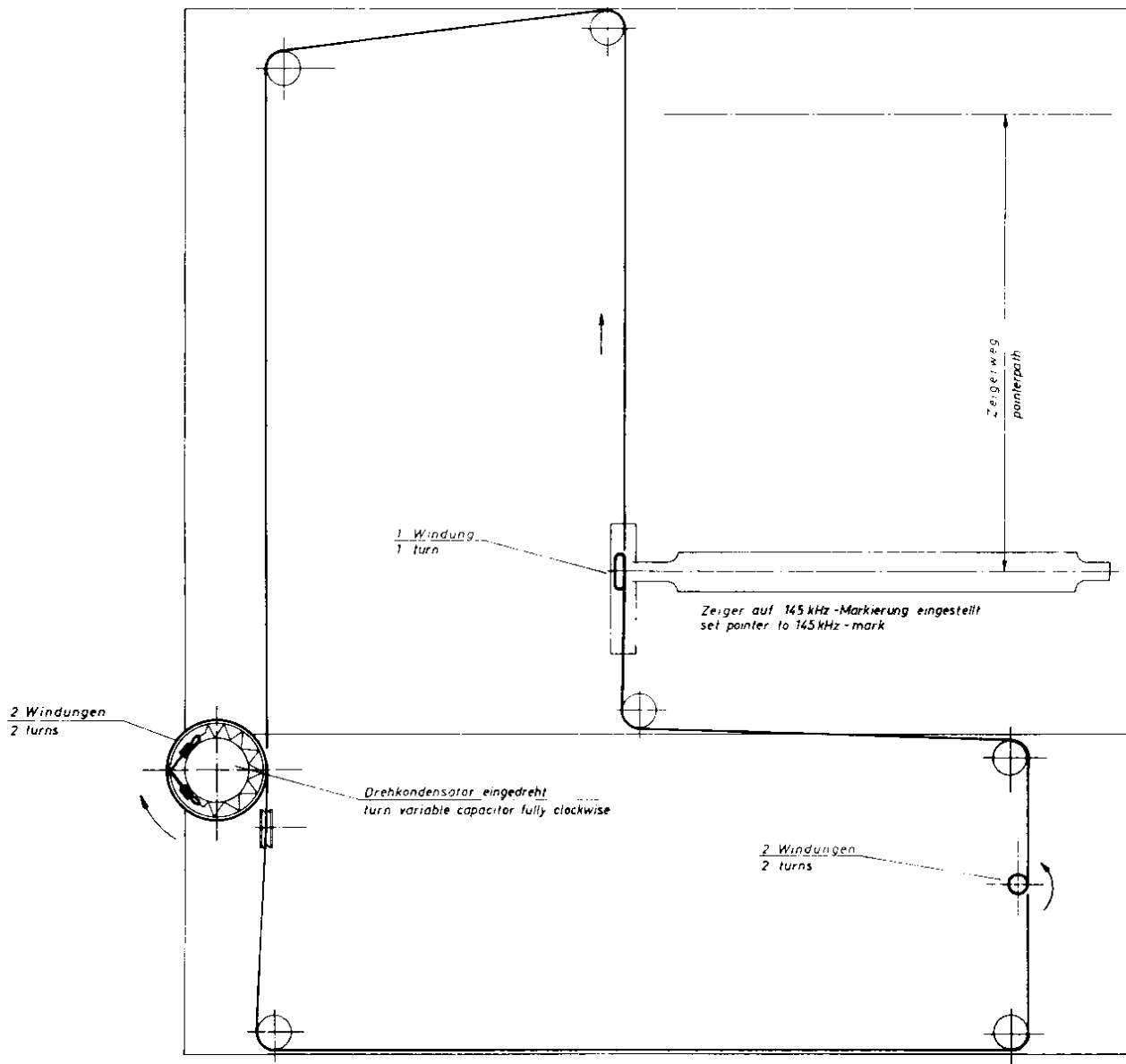

Anschlußcode

Tastatur keys

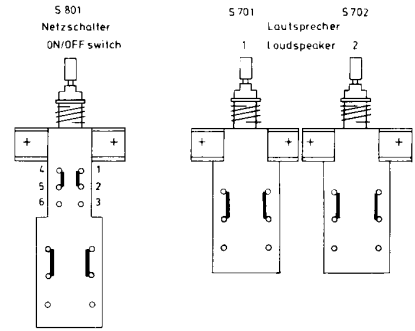
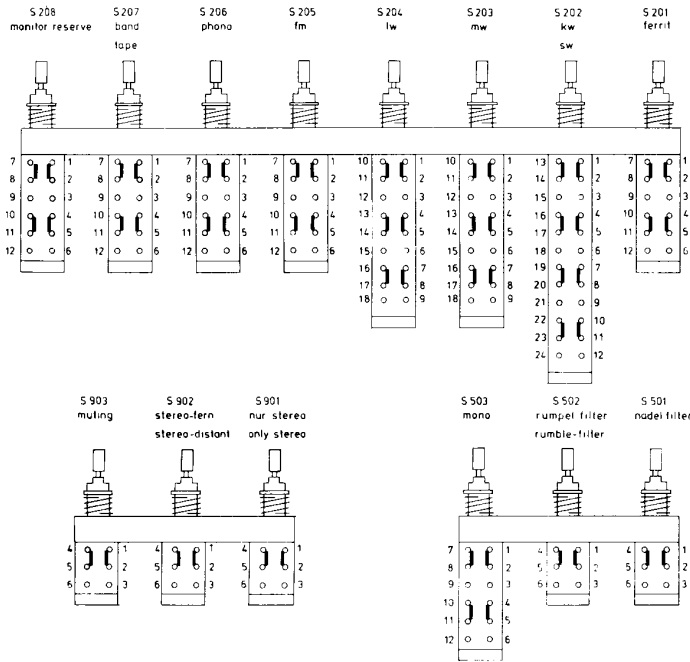

Steckverbindungen pluggable connections

(auf die Lötanschlüsse gesehen)
(looking at the soldering connections)

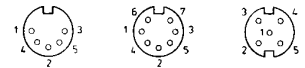

Transistoren transistors

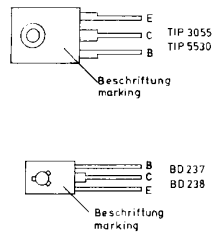

(auf die Anschlüsse gesehen)
(looking at the connections)

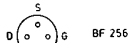
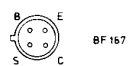
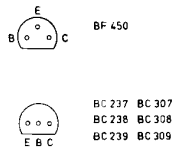

Integrierte Schaltungen integrated circuits

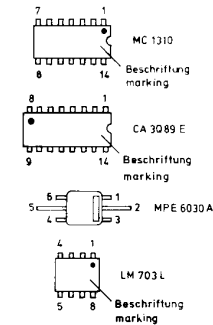

Dioden diodes

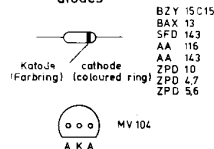

Gleichrichter rectifier

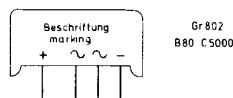

(auf die Anschlüsse gesehen)
(looking at the connections)

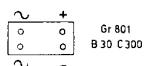

Relais relais

(auf die Anschlüsse gesehen)
(looking at the connections)

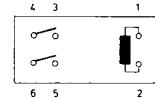

Kondensatoren capacitors



Widerstände resistors

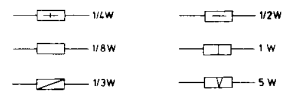

Schiebepotentiometer slide potentiometer

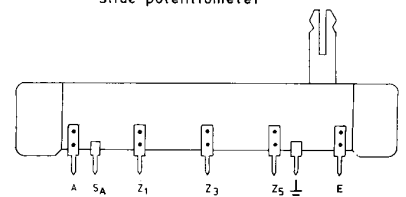

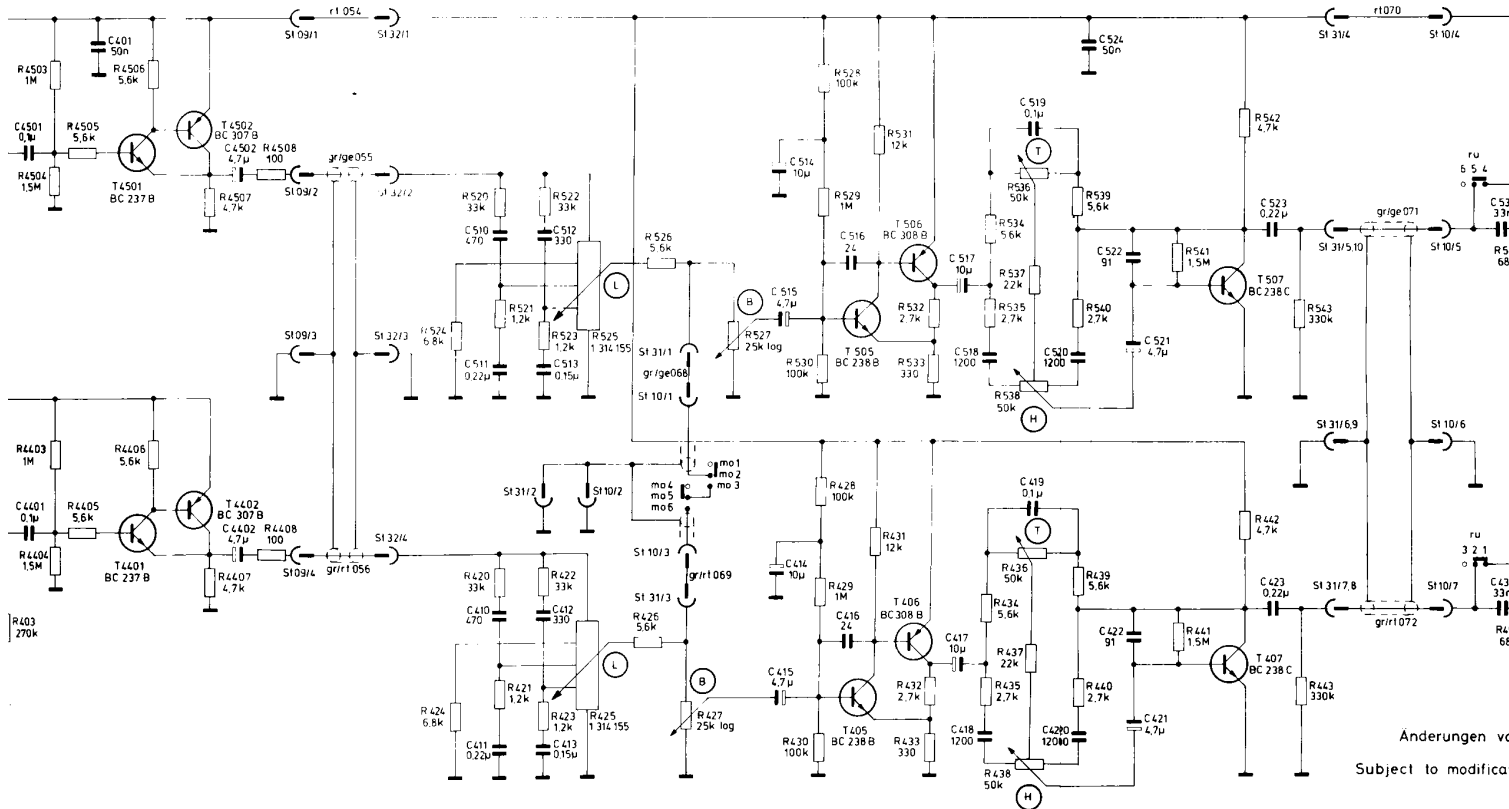
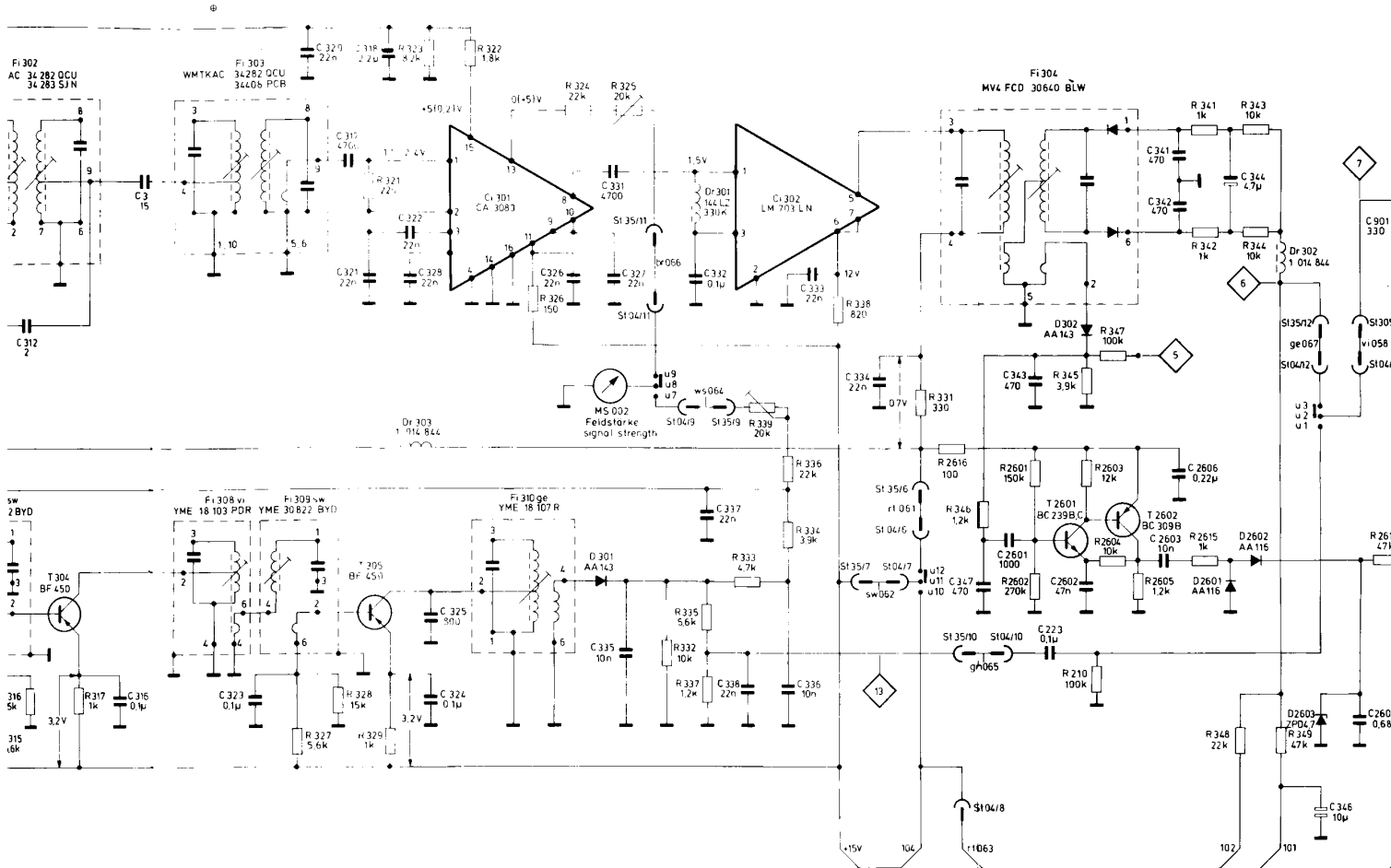

Änderungen vc
Subject to modifica

