

NOTE:subject to change without notice for improvement!

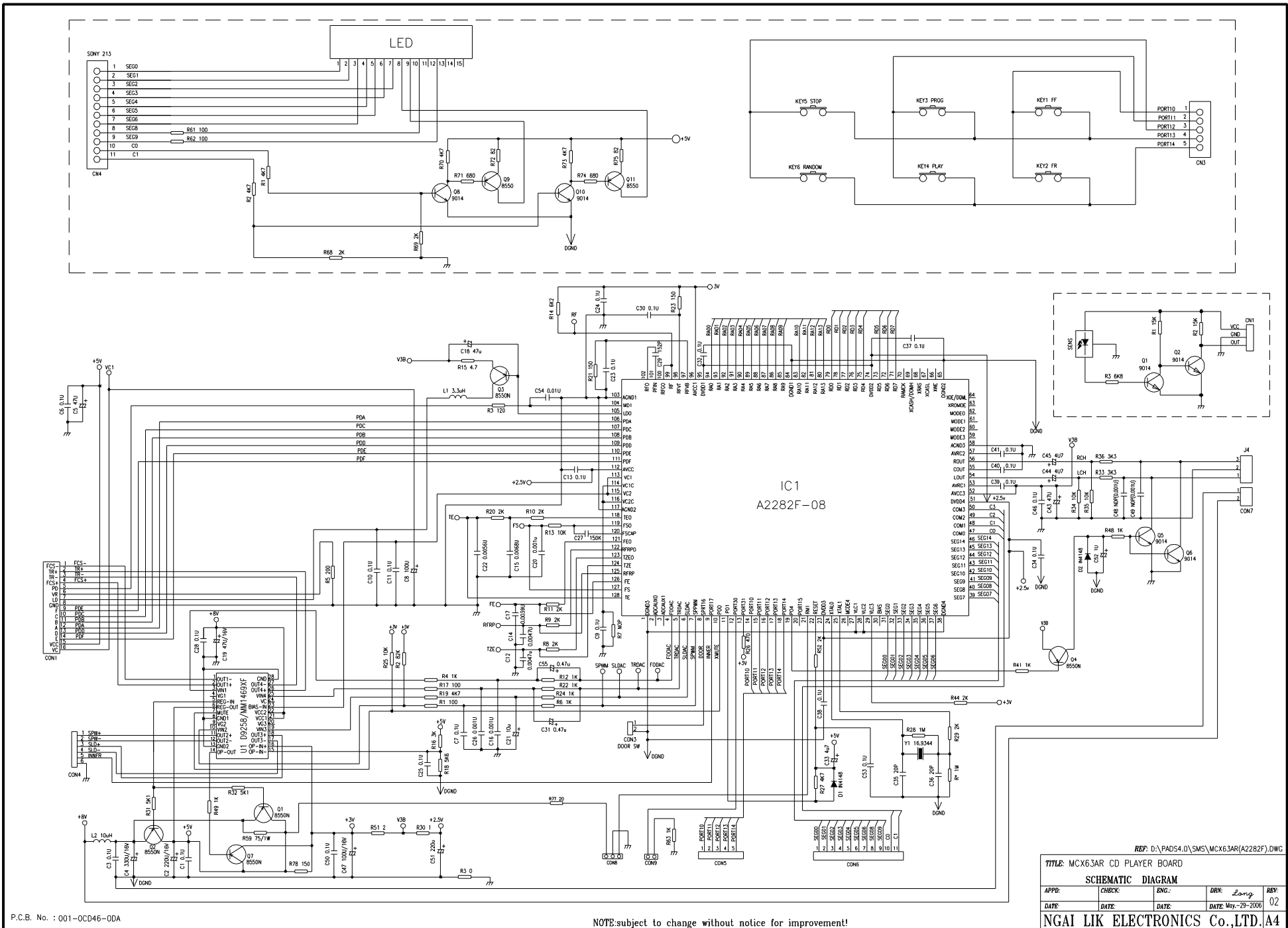

P.C.B. No. : 001-0CD46-0DA

NOTE:subject to change without notice for improvement!

REF: D:\PADS4.0\SMS\MCX63AR(A2282F).DWG

TITLE: MCX63AR CD PLAYER BOARD			
SCHEMATIC DIAGRAM			
APPD:	CHECK:	ENG.:	DRN: Long
DATE:	DATE:	DATE: May-29-2006	REV: 02
<b>NGAI LIK ELECTRONICS Co.,LTD.A4</b>			

NL-DES-F09/REV.0/Aug.01.2002

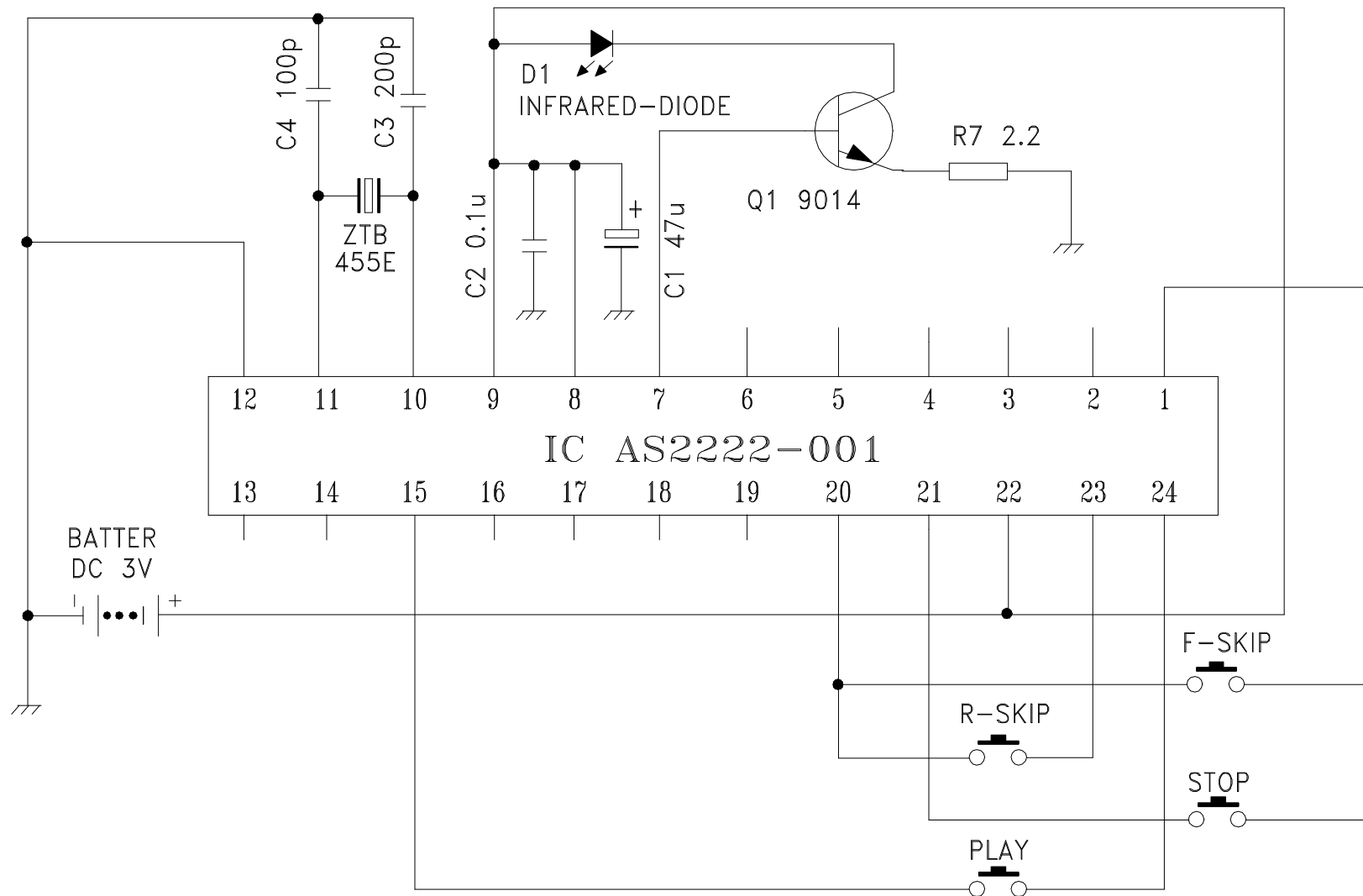

P.C.B. NO.: 001-CD155-0U6

NOTE:subject to change without notice for improvement!

REF: D:\PADS4.0\SMS\MCX63A(4K)REMOTE.DWG				
TITLE: MCX63A (CD-AVID)4KEY REMOTE CONTROL				
SCHEMATIC DIAGRAM				
APPD:	CHECK:	ENG.:	DRN: Long	REV:
DATE:	DATE:	DATE:	DATE: Oct.-01-2002	01
NGAI LIK ELECTRONICS Co.,LTD.				A2





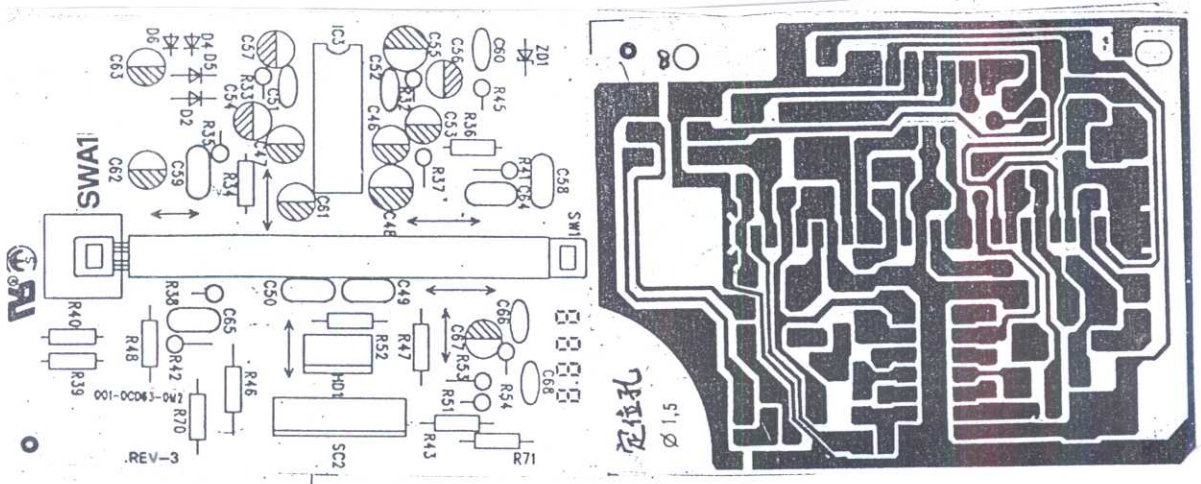
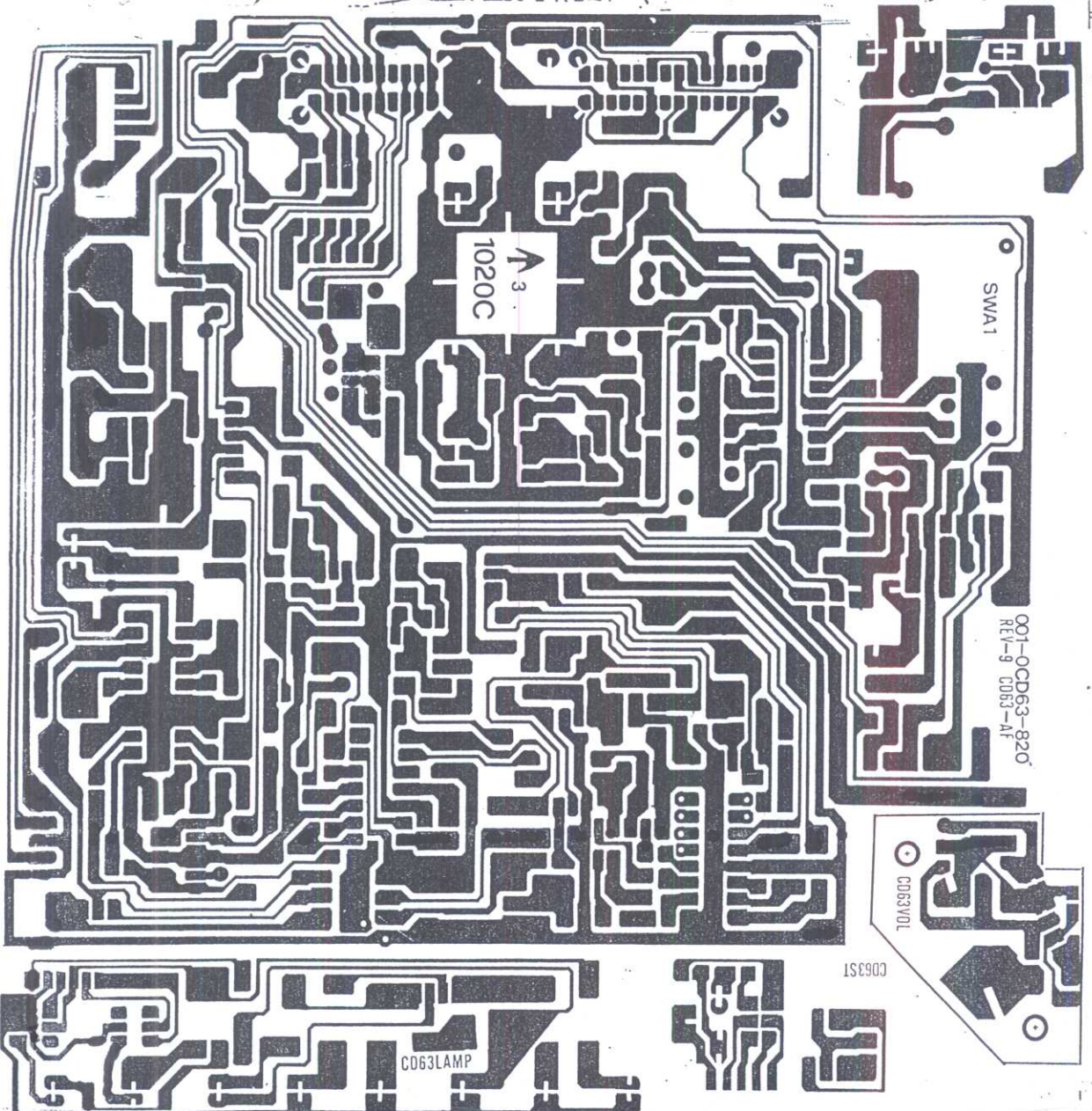



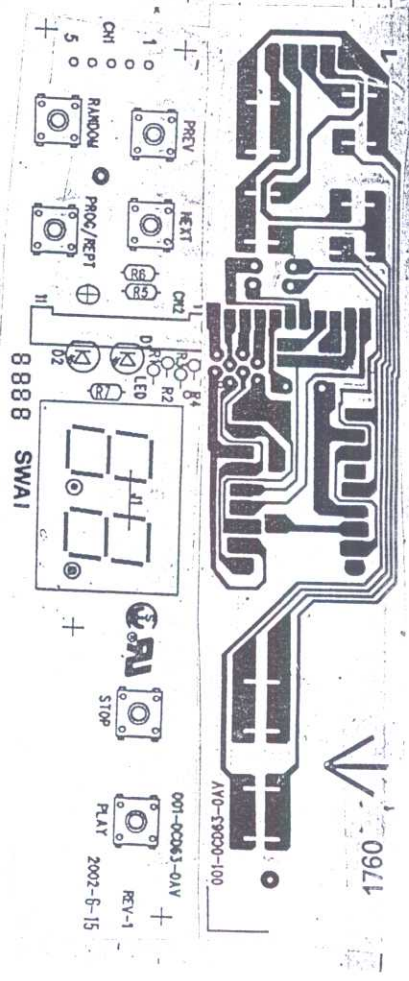
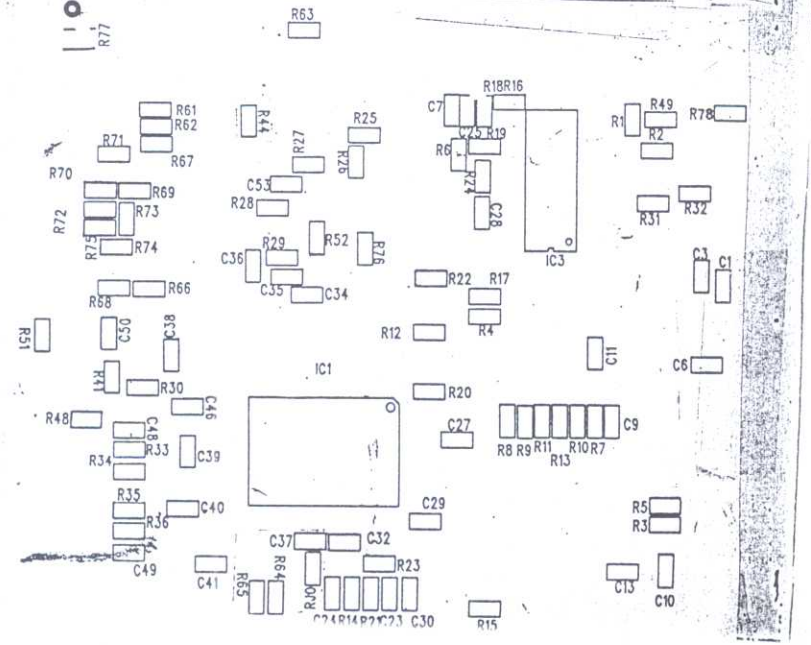
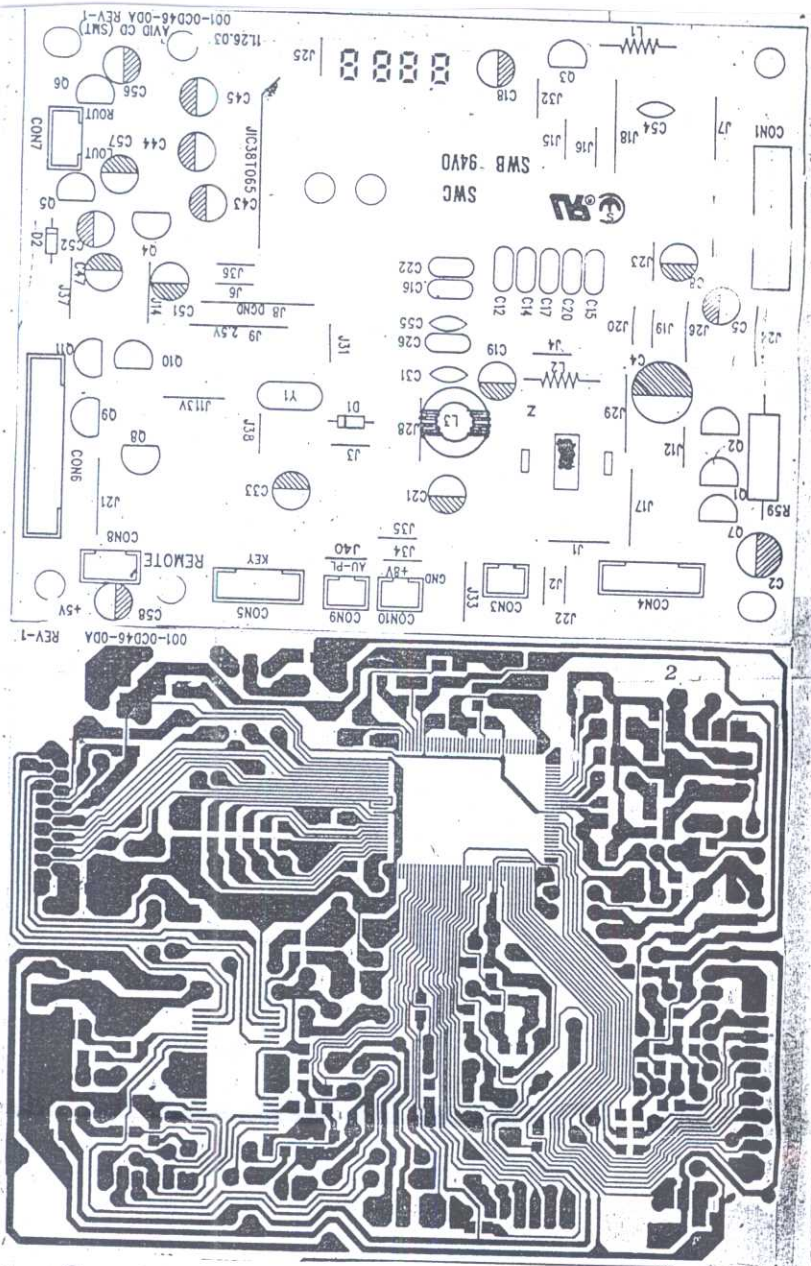

MEX634

1760

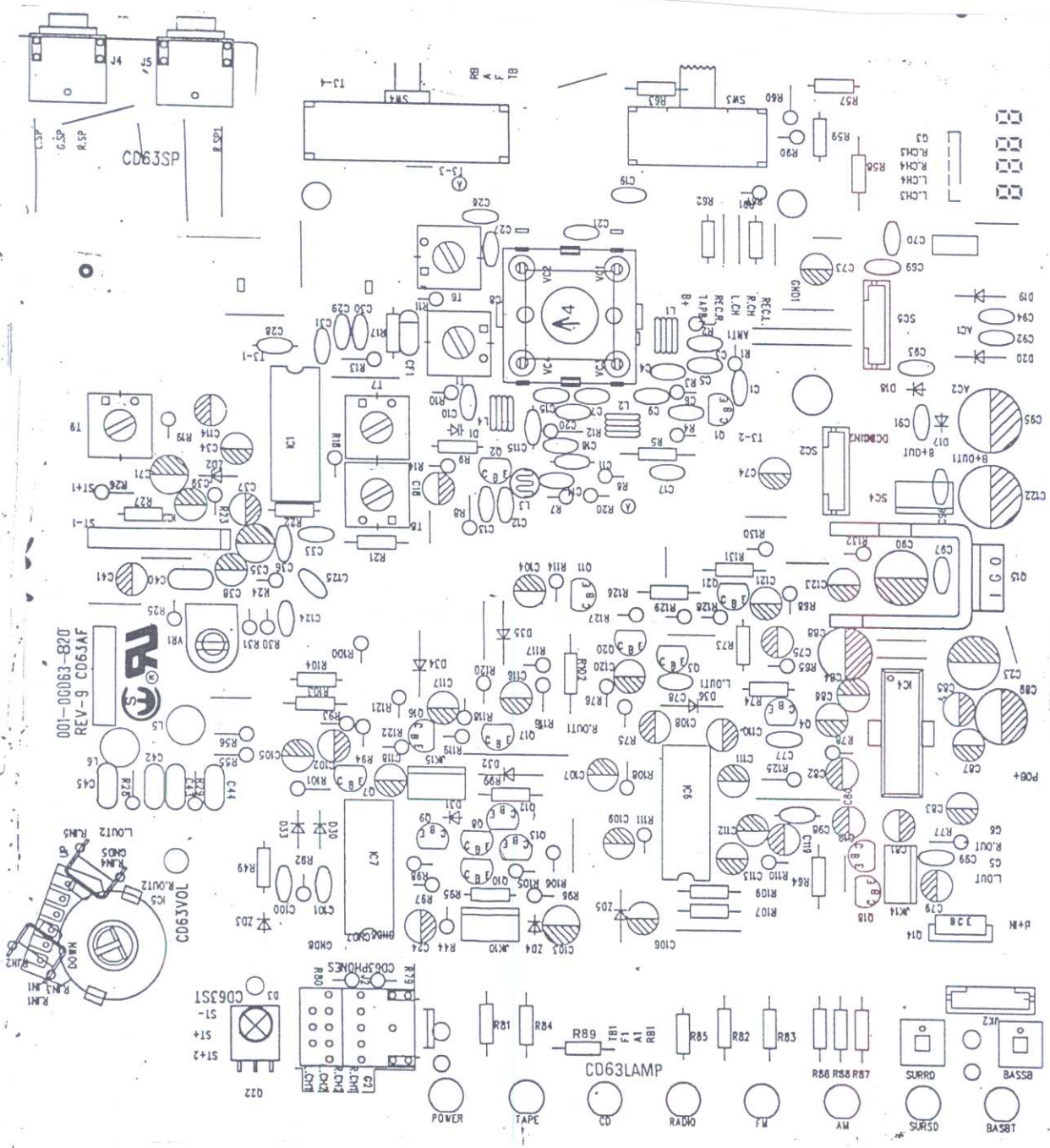

001-00063-820  
REV-9 CD63AF



70A6903

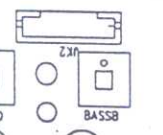
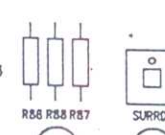
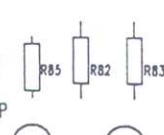
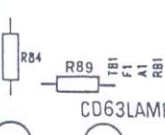
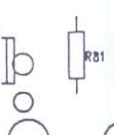
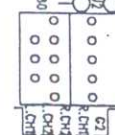
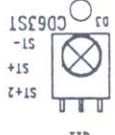

POWER TAPES CD RAD M MV SURS SURS BASBT JXZ



