

C	INCLUSAO DA SERIE E			ANDRE	0/09/99
B	INCLUSAO DAS SERIES B/C/D			ANDRE	01/09/99
A	R.760.761 ERA 22K			ANDRE	31/08/99
ALT. P.A.	DISCRIMINACAO			VISTO	DATA
	TITULO: ESQUEMA ELETRICO CD MD-3000A/B/C/D/E			PROJECÃO	dimensões em mm
DES.	ROBERTO	DATA	23/08/99	MAT.	ACAB.
PROJ.		ESC.		TOL.Ø	TOL.
APRO.	ANDRE	10/09/99	MOD. MD-3000A/B/C/D/E	COD.	1.00.52158.09

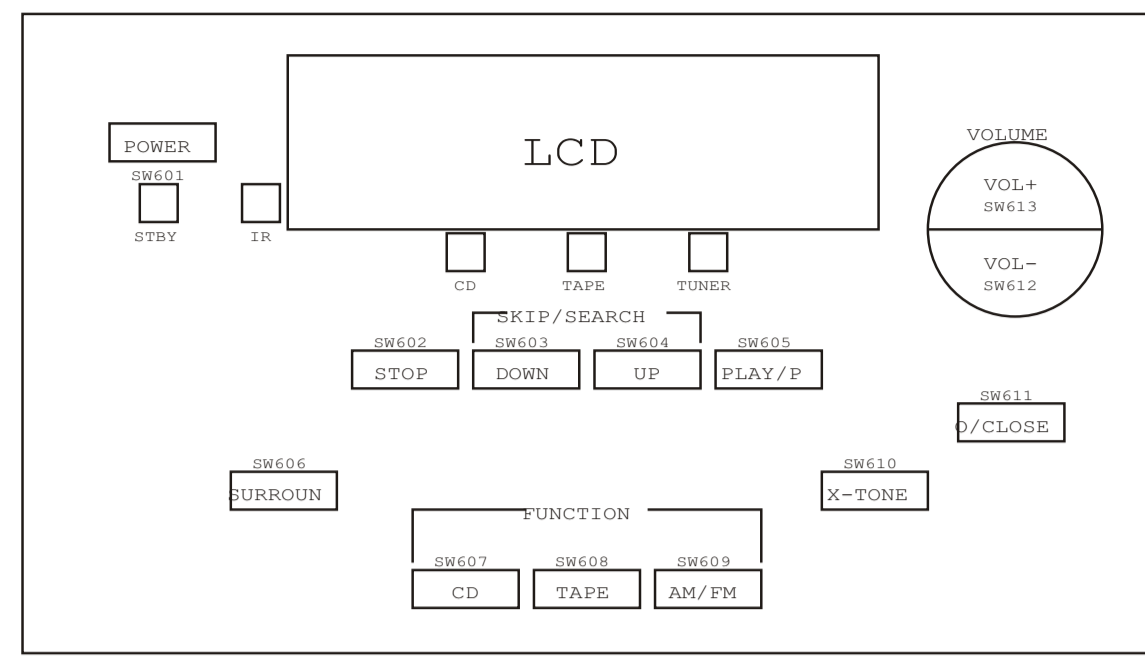

SEQUENCIA NO PAINEL

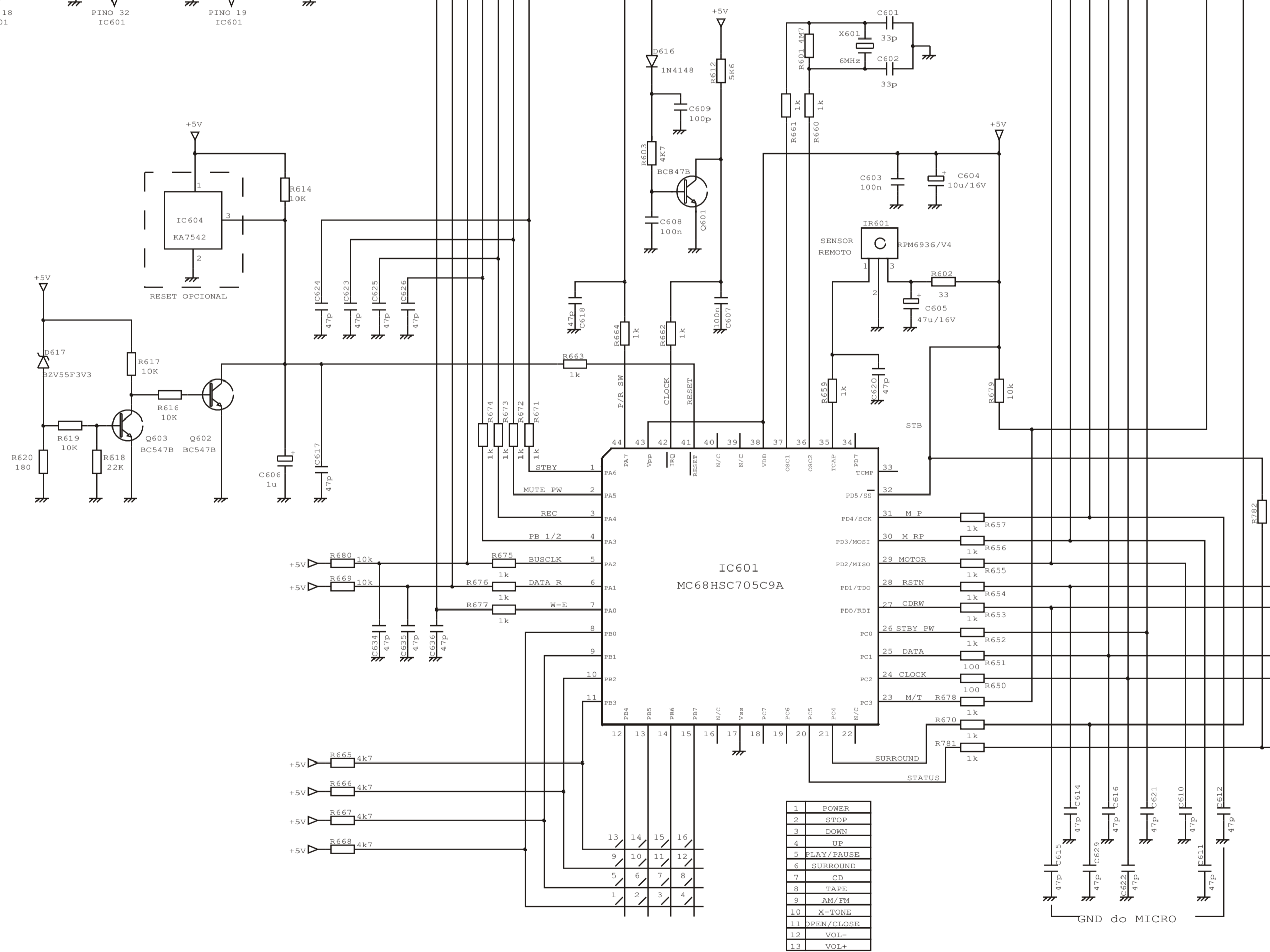
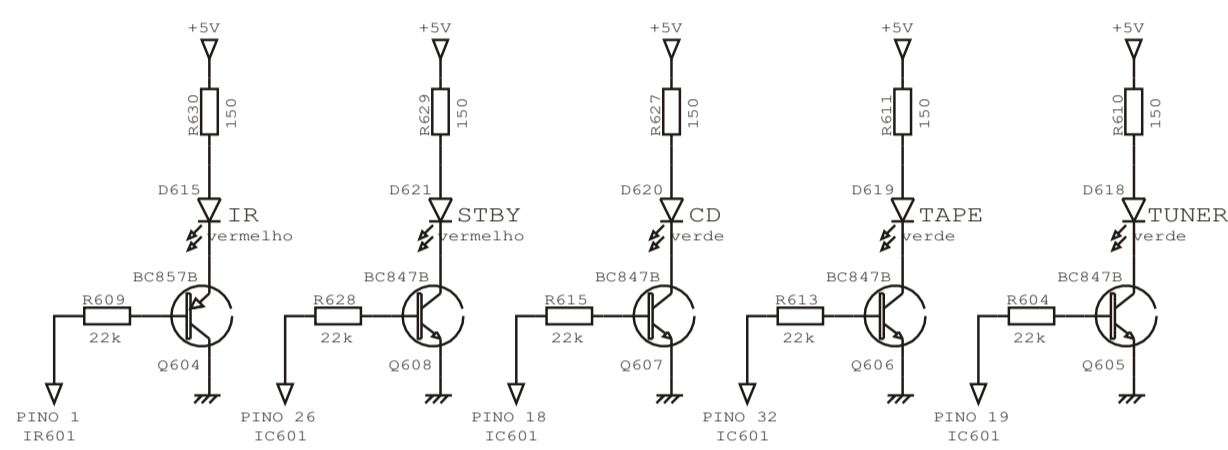

1	POWER
2	STOP
3	DOWN
4	UP
5	PLAY/PAUSE
6	SUBROUN
7	TAPE
8	AM/FM
9	X-TONE
10	VOL+
11	VOL-
12	VOL

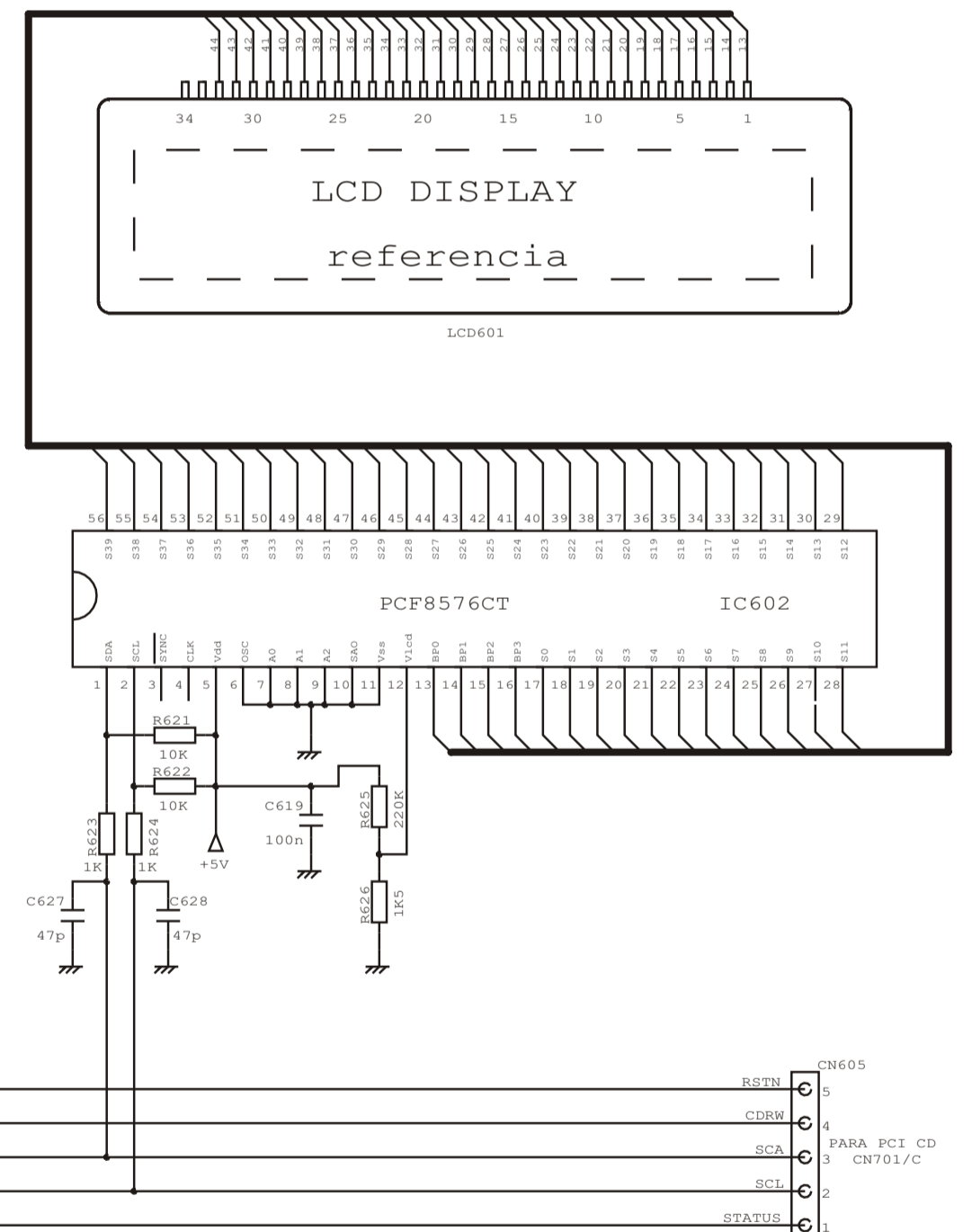
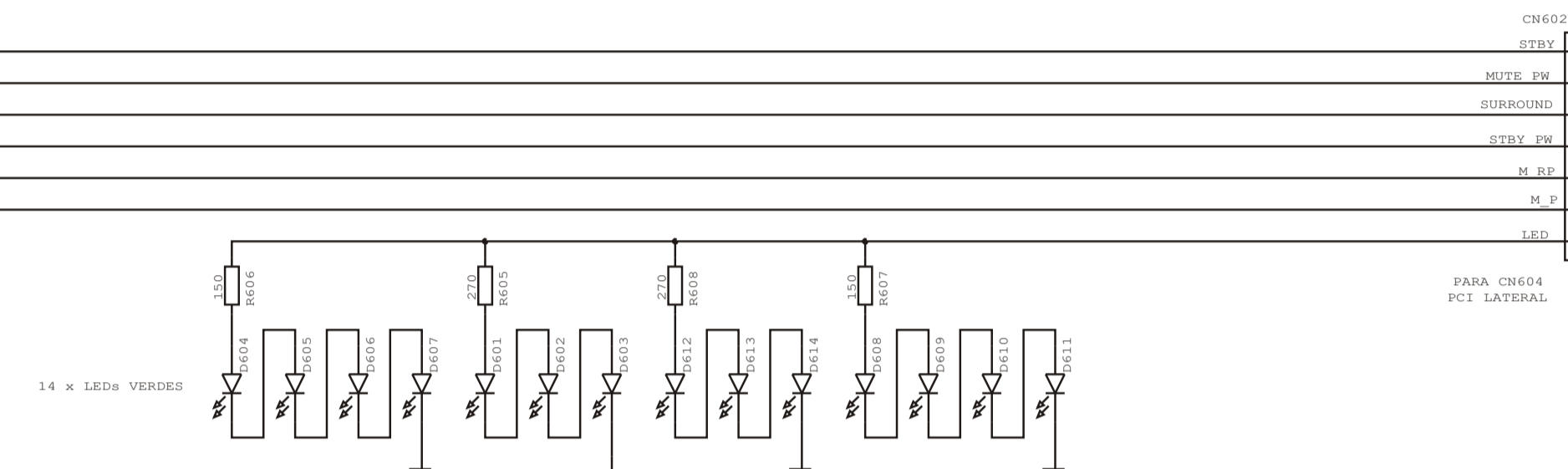
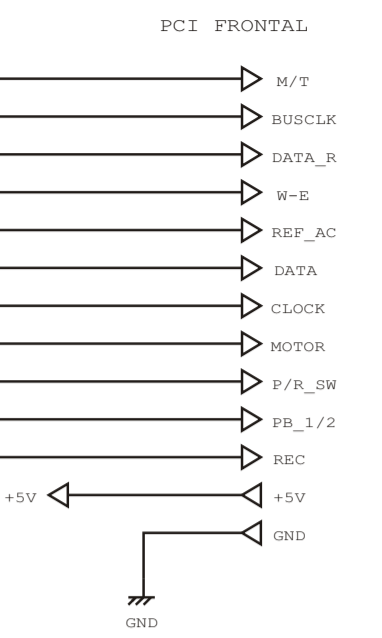

PCI FRONTAL

B	CONFORME AMV-274/99 / INCLUSAO DA SERIE E	ANDRE	09/09/99
A	INCLUSAO DAS SERIES B/C/D	ANDRE	01/09/99
ALT. P.A.	DISCRIMINACAO	VISTO	DATA
	TITULO: ESQUEMA ELETRICO PCI FRONTAL MD-3000A/B/C/D/E	PROJECAO	dimensoes em mm
DES.	ROBERTO	DATA	MAT.
PROJ.	ESC.	TOL. Ø	TOL. N°
APRO.	ANDRE	09/09/99	MOD. MD-3000A/B/C/D/E
			COD. 1.00.52158.07

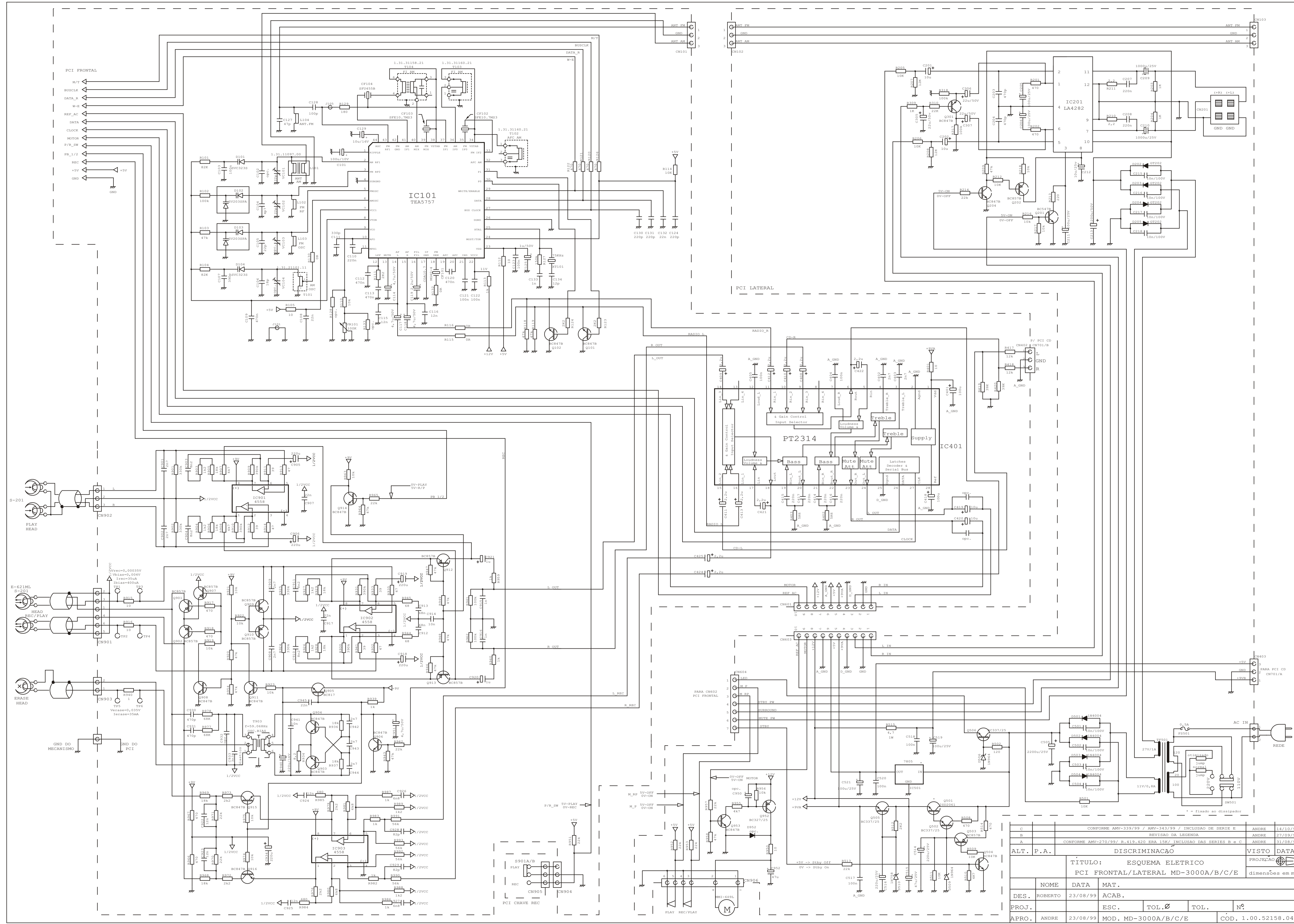

C		CONFORME AMV-339/99 / AMV-343/99 / INCLUSAO DE SERIE E		ANDRE	14/10/99
B		REVISAO DA LEGENDA		ANDRE	27/09/99
A		CONFORME AMV-270/99/ R.419.420 ERA 15K/ INCLUSAO DAS SERIES B e C		ANDRE	31/08/99
ALT. P.A.		DISCRIMINACAO			VISTO DATA
		TITULO: ESQUEMA ELETRICO			PROJECAO
		PCI FRONTAL/LATERAL MD-3000A/B/C/E			dimensoes em mm
DES.	ROBERTO	DATA	23/08/99	MAT.	ACAB.
PROJ.	ANDRE	ESC.		TOL.Ø	TOL.
APRO.	ANDRE	23/08/99	MOD. MD-3000A/B/C/E		Nº
					COD. 1.00.52158.04