

PCI LATERAL

PCI FRONTAL

1	2	3	4	5	6	7	8	9	10	11	12	13	14	15	16	17	18	19	20	21	22	23	24	25	26	27	28	29	30	31	32	33	34	35	36	37	38	39	40
1	2	3	4	5	6	7	8	9	10	11	12	13	14	15	16	17	18	19	20	21	22	23	24	25	26	27	28	29	30	31	32	33	34	35	36	37	38	39	40

E	MV-186/00	R657 ERA 1K / INCLUSAO DA SERIE MD3280G	ANDRE	29/05/00
D		INCLUSAO DA SERIE MD3280F	ANDRE	04/01/00
C		INCLUSAO DA SERIE MD3280E	ANDRE	01/10/99
B		INCLUSAO DA SERIE MD3280D	ANDRE	02/09/99
A		INCLUSAO DAS SERIES B/D/F - MD3280B/C	ANDRE	03/08/99
ALT.	P. A.	DISCRIMINACAO	VISTO	DATA
		TITULO: ESQUEMA ELETRICO	PROJECAO	
		PCI FRONTAL/LATERAL MD3260/MD3280	dimensoes em mm	
DES.	ROBERTO	11/06/99	ACAB.	
PROJ.		ESC.	TOL.Ø	TOL.
APRO.	ANDRE	02/09/99	MOB	260A/B/D/F-MD3280B/C/D/E/F/G
		COD	1.00.52150.06	

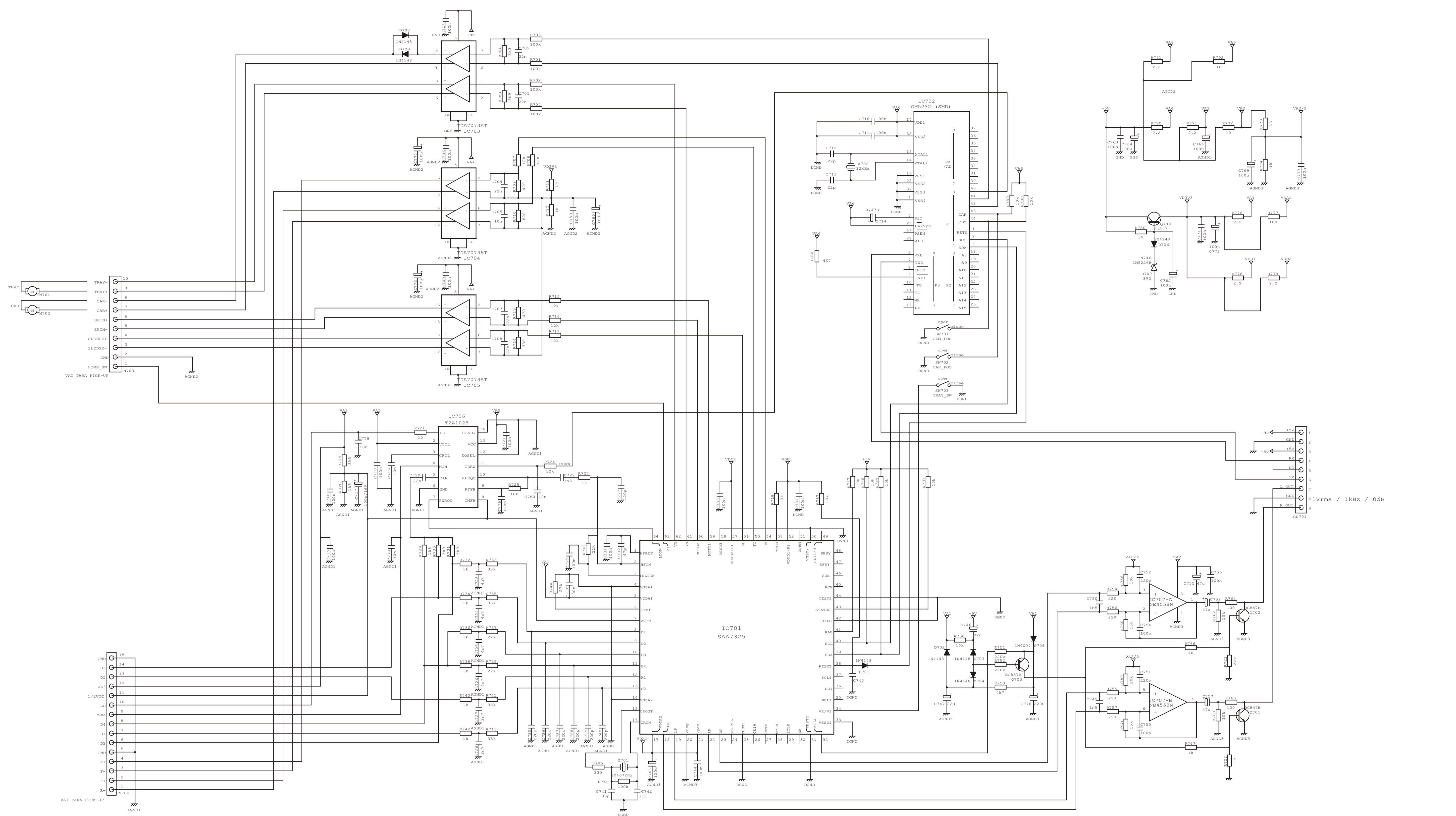

B	INCLUSAO DA SERIE MD3300F	ANDRE	20/10/99
D	INCLUSAO DAS SERIES MD3500C/D	ANDRE	15/10/99
C	INCLUSAO DAS SERIES MD3280E / MD3300E	ANDRE	04/10/99
B	CONFORME AMV-302/99	ANDRE	24/09/99
A	INCLUSAO DA SERIE MD3300D / R.703 ERA 4K7 / R.714 ERA 470R	ANDRE	10/09/99
ALT. P. A.		DISCRIMINACAO	VISTO DATA
		TITULO: ESQUEMA ELETRICO PCI CD	PROJECAO
		MD3280B/D/E-MD3300B/D/E/F-MD3500B/C/D	dimensoes em mm
DES.	ROBERTO	DATA	MAT.
PROJ.	ESC.	TOL.Ø	TOL. N°
APRO.	ANDRE	01/09/99	MOD. MD3280/MD3300/MD3500
		COD.	1.00.52159.02

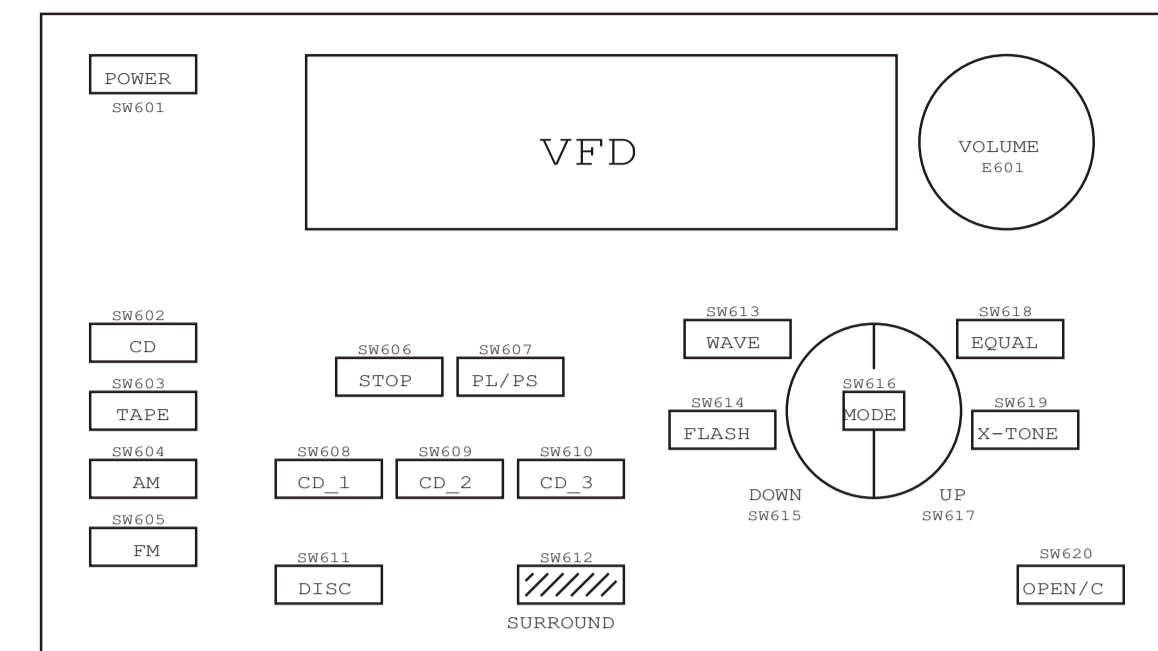

SEQUENCIA NO PAINEL

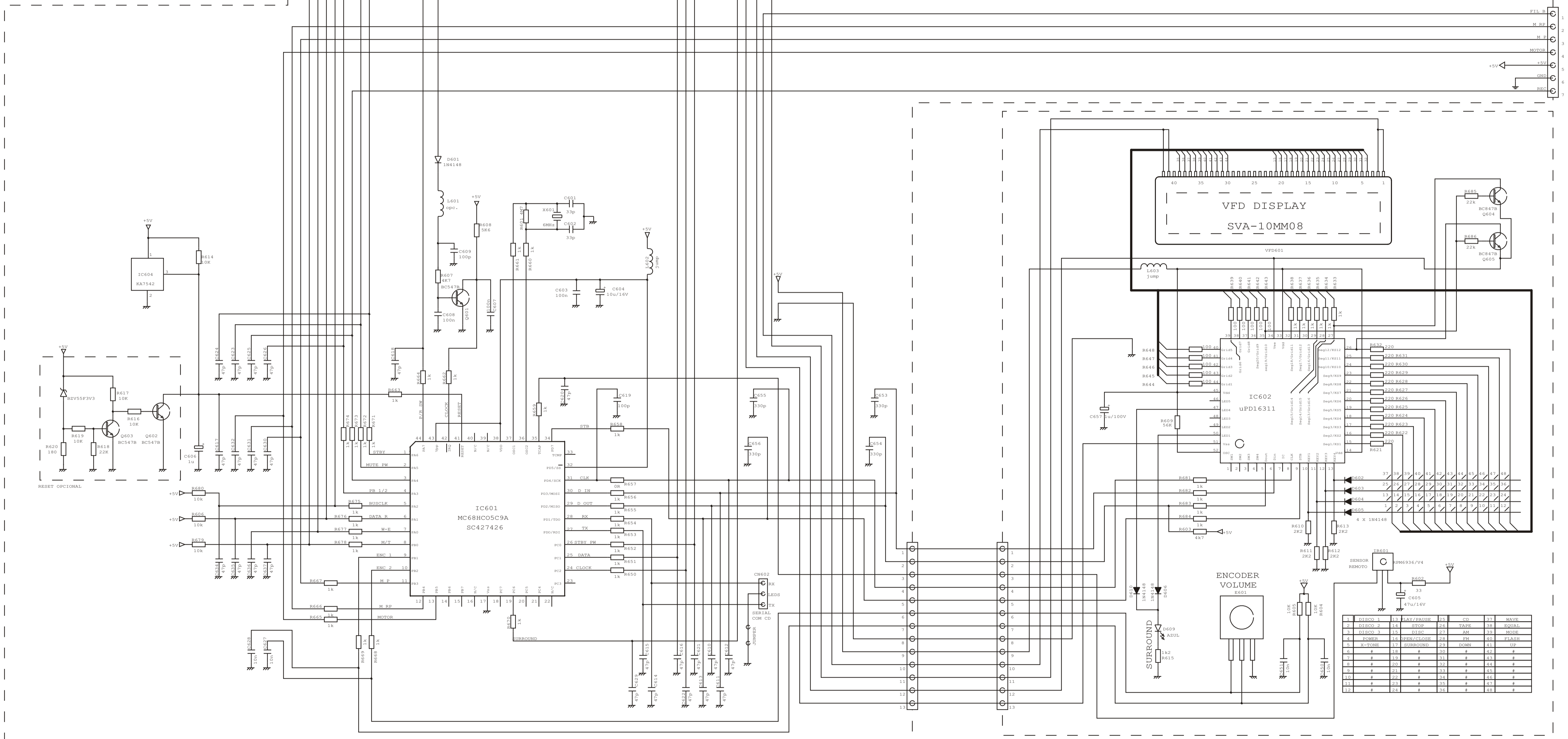

PCI LATERAL

PCI FRONTAL

1	2	3	4	5	6	7	8	9	10	11	12	13	14	15	16	17	18	19	20	21	22	23	24	25	26	27	28	29	30	31	32	33	34	35	36	37	38	39	40	41	42	43	44	45	46	47	48	49	50	51	52	53	54	55	56	57	58	59	60	61	62	63	64	65	66	67	68	69	70	71	72	73	74	75	76	77	78	79	80	81	82	83	84	85	86	87	88	89	90	91	92	93	94	95	96	97	98	99	100
1	2	3	4	5	6	7	8	9	10	11	12	13	14	15	16	17	18	19	20	21	22	23	24	25	26	27	28	29	30	31	32	33	34	35	36	37	38	39	40	41	42	43	44	45	46	47	48	49	50	51	52	53	54	55	56	57	58	59	60	61	62	63	64	65	66	67	68	69	70	71	72	73	74	75	76	77	78	79	80	81	82	83	84	85	86	87	88	89	90	91	92	93	94	95	96	97	98	99	100

E	MV-186/00	R657 ERA 1K / INCLUSAO DA SERIE MD3280G	ANDRE	29/05/00
D		INCLUSAO DA SERIE MD3280F	ANDRE	04/01/00
C		INCLUSAO DA SERIE MD3280E	ANDRE	01/10/99
B		INCLUSAO DA SERIE MD3280D	ANDRE	02/09/99
A		INCLUSAO DAS SERIES B/D/F - MD3280B/C	ANDRE	03/08/99
ALT.	P. A.	DISCRIMINACAO	VISTO	DATA
		TITULO: ESQUEMA ELETRICO	PROJECAO	
		PCI FRONTAL/LATERAL MD3260/MD3280	dimensoes em mm	
DES.	ROBERTO	11/06/99	ACAB.	
PROJ.			ESC.	
APRO.	ANDRE	02/09/99	TOL.Ø	TOL. N°
		MD3260A/B/D/F-MD3280B/C/D/E/F/G	COD1.00.52150.06	

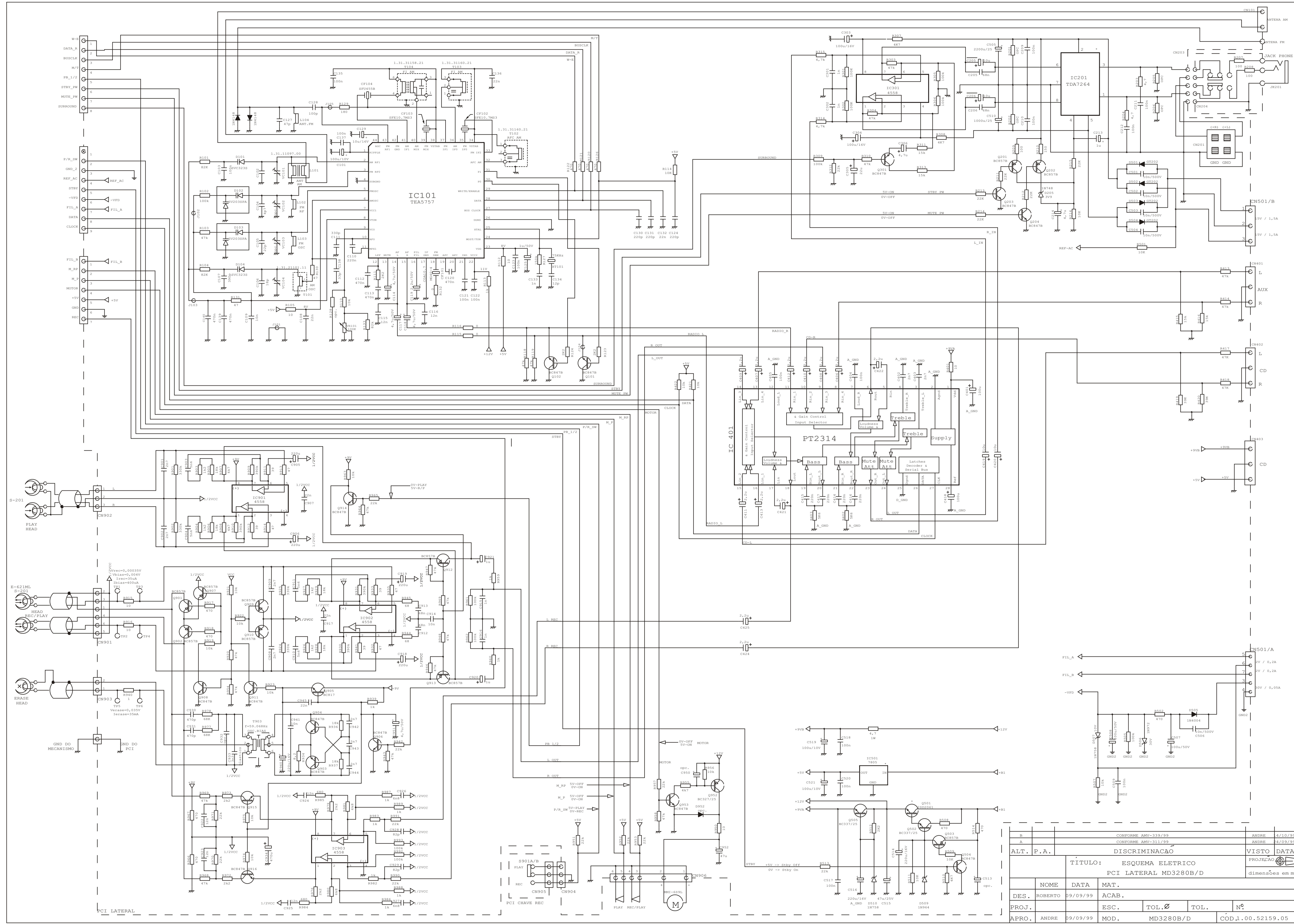

B		CONFORME AMV-339/99		ANDRE	4/10/99
A		CONFORME AMV-311/99		ANDRE	4/09/99
ALT. P. A.		DISCRIMINACAO		VISTO DATA	
		TITULO: ESQUEMA ELETRICO		PROJECCAO	
		PCI LATERAL MD3280B/D		dimensoes em mm	
DES.	ROBERTO	DATA	09/09/99	MAT.	ACAB.
PROJ.		ESC.		TOL.Ø	TOL.
APRO.	ANDRE	MOD.	MD3280B/D	COD.1.00.52159.05	

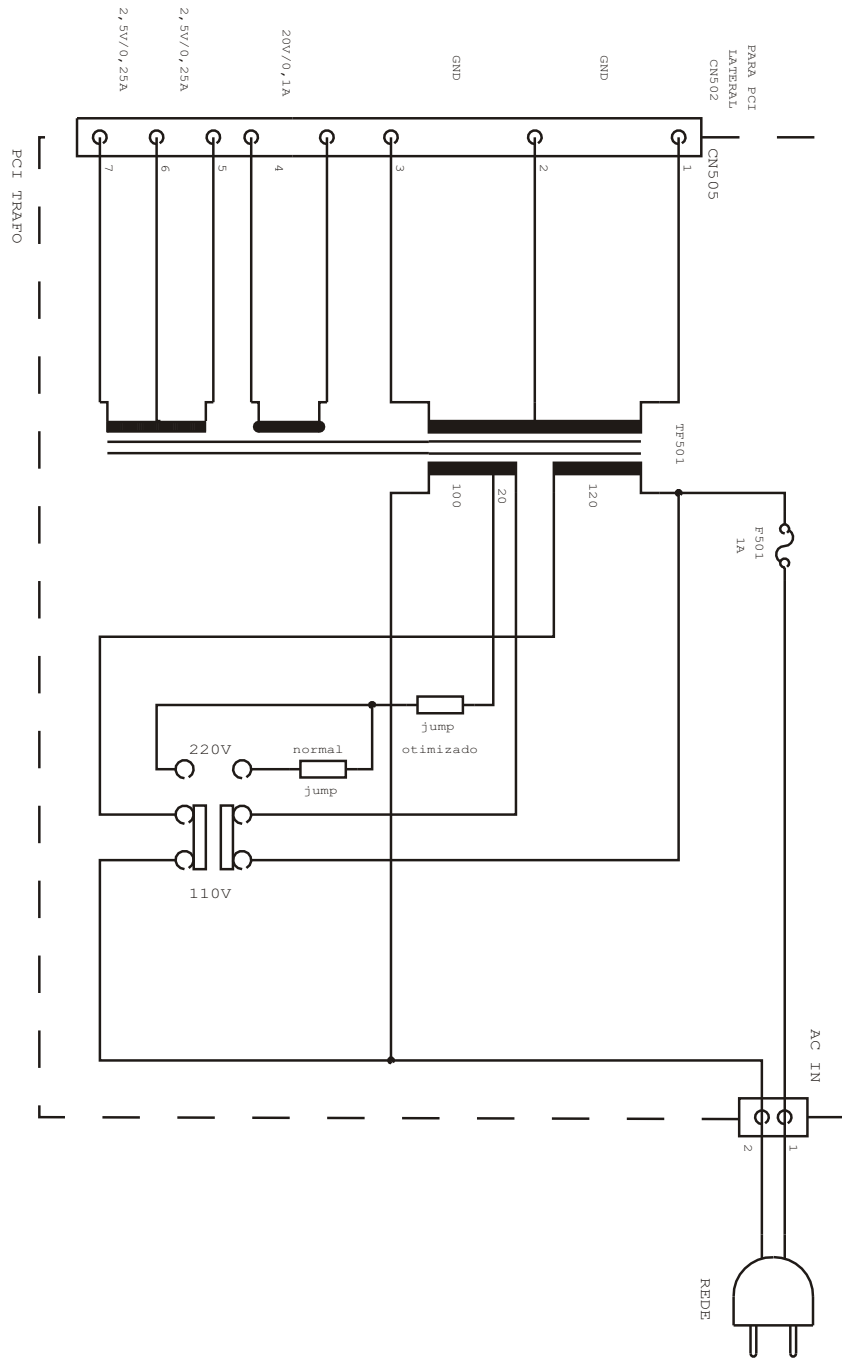

C			INCLUSAO DA SERIE MD3280E				ANDRE	01/10/99
B			INCLUSAO DA SERIE MD3280D				ANDRE	02/09/99
A			INCLUSAO DAS SERIES MD3260B/D/F-MD3280B/C				ANDRE	03/08/99
ALT.	P.A.		DISCRIMINACAQ				VISTO	DATA
		TITULO: ESQUEMA ELETRICO					PROJECAO	
		PCI TRAF MD3260A/B/D/F-MD3280B/C/D/E					dimensoes em mm	
	NOME	DATA	MAT.					
DES.	ROBERTO	11/06/99	ACAB.					
PROJ.			ESC.	TOL. Ø	TOL.	N.º		
APRO.	ANDRE	02/09/99	MOD. MD3260/MD3280			CÓD. 1.00.52150.04		

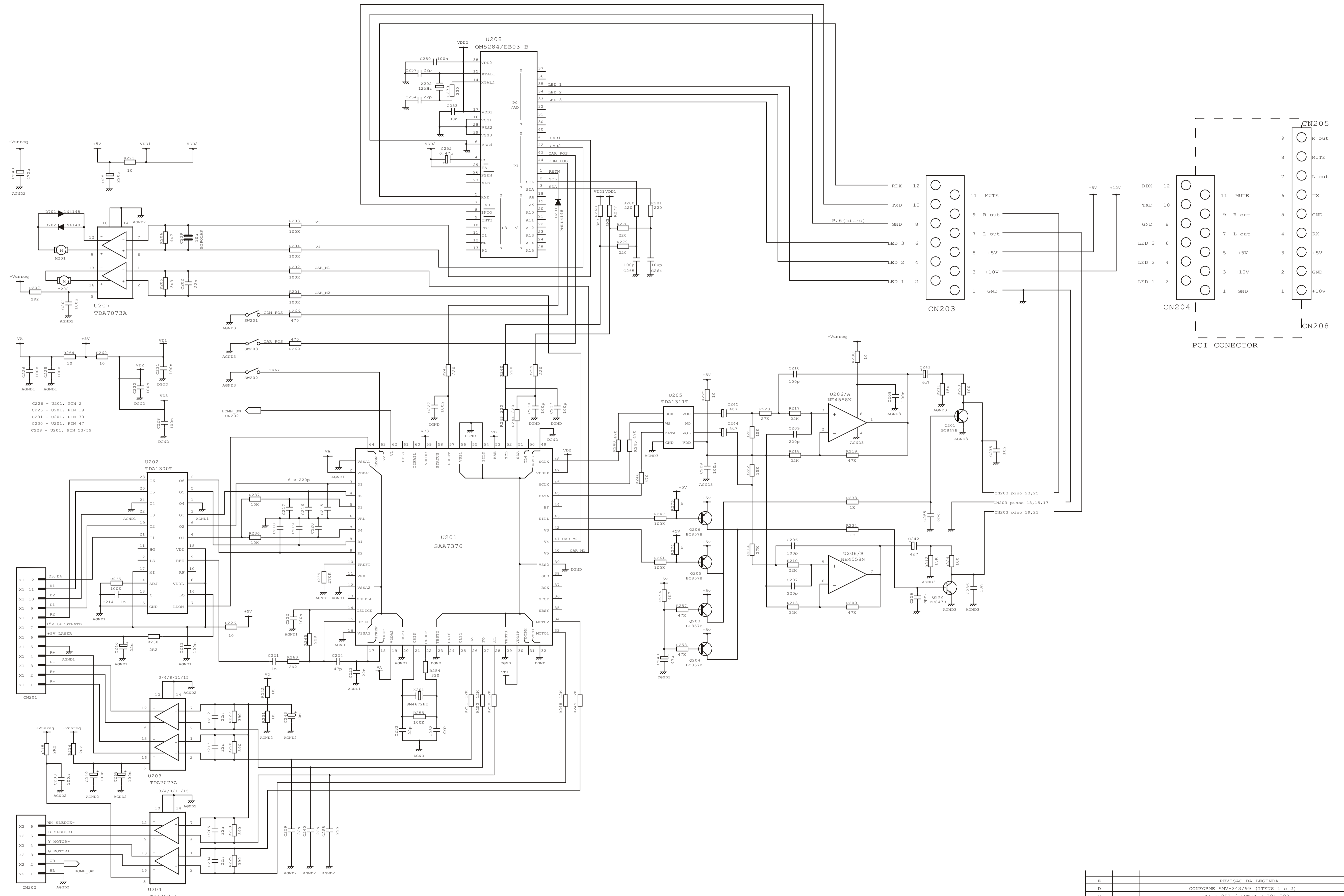

- C226 - U201, PIN 2
- C225 - U201, PIN 19
- C235 - U201, PIN 38
- C230 - U201, PIN 47
- C228 - U201, PIN 53/59

B		REVISAO DA LEGENDA	ANDRE	27/09/99	
D		CONFORME AMV-243/99 (ITENS 1 e 2)	ANDRE	24/08/99	
C		SAI R.253 / ENTRA D.701.702	ANDRE	23/08/99	
B		INCLUSAO MD-3260B/F / MD3280C / MD3300C / MD3500A	ANDRE	03/08/99	
A		CONFORME AMV-204/99 / INCLUSAO MD-3300	ANDRE	14/07/99	
ALT. P.A.		DISCRIMINACAO	VISTO	DATA	
		TITULO: ESQUEMA ELETRICO 3 CD's	PROJETO		
		MD3260A/B/F-MD3280C-MD3300A/C-MD3500A	dimensões em mm		
DES.	ROBERTO	DATA	MAT.		
PROJ.		ESC.	TOL.Ø	TOL.	Nº
APRO.	ANDRE	02/03/99	MOD. MD3260/MD3280/MD3300/MD3500		COD. 1.00.52150.07

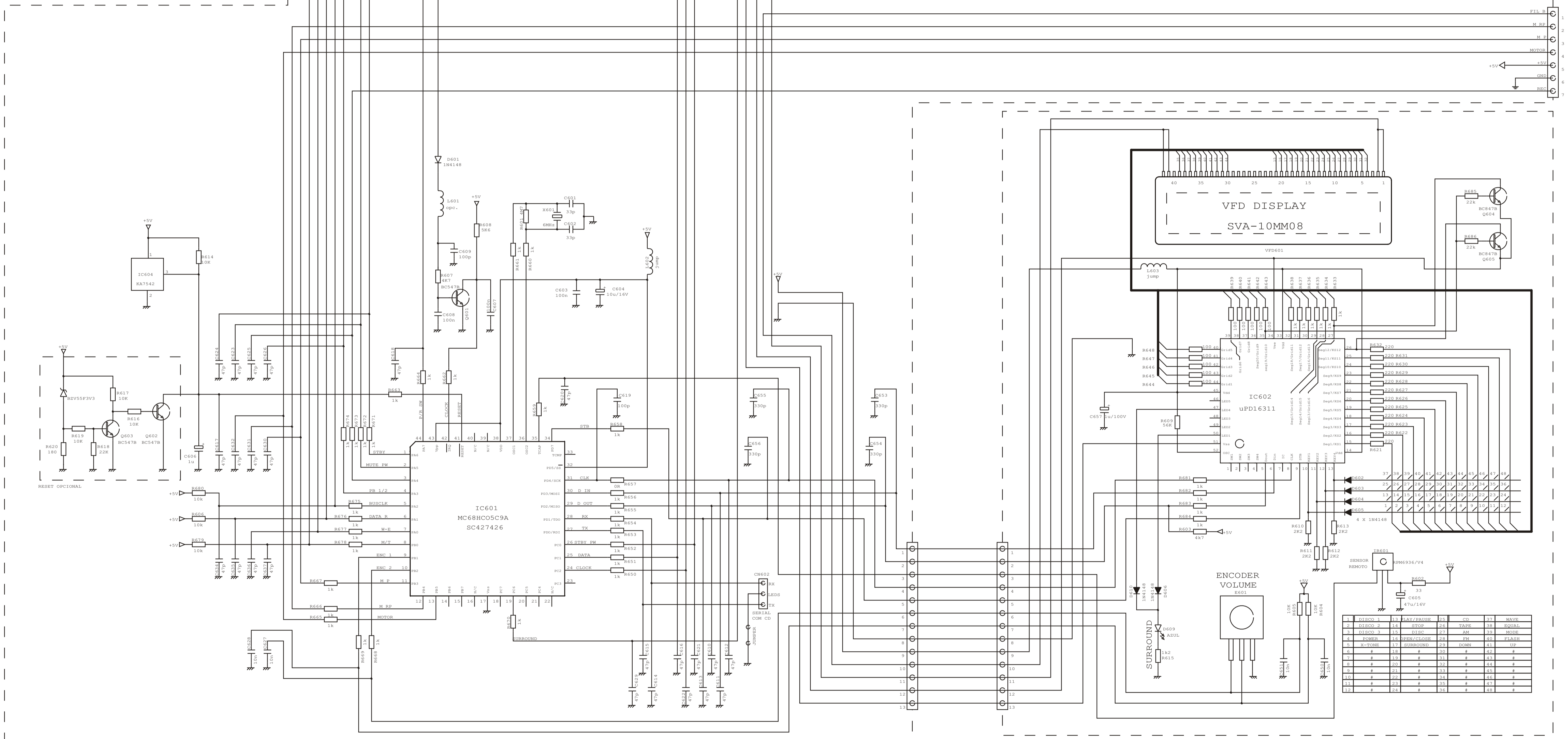
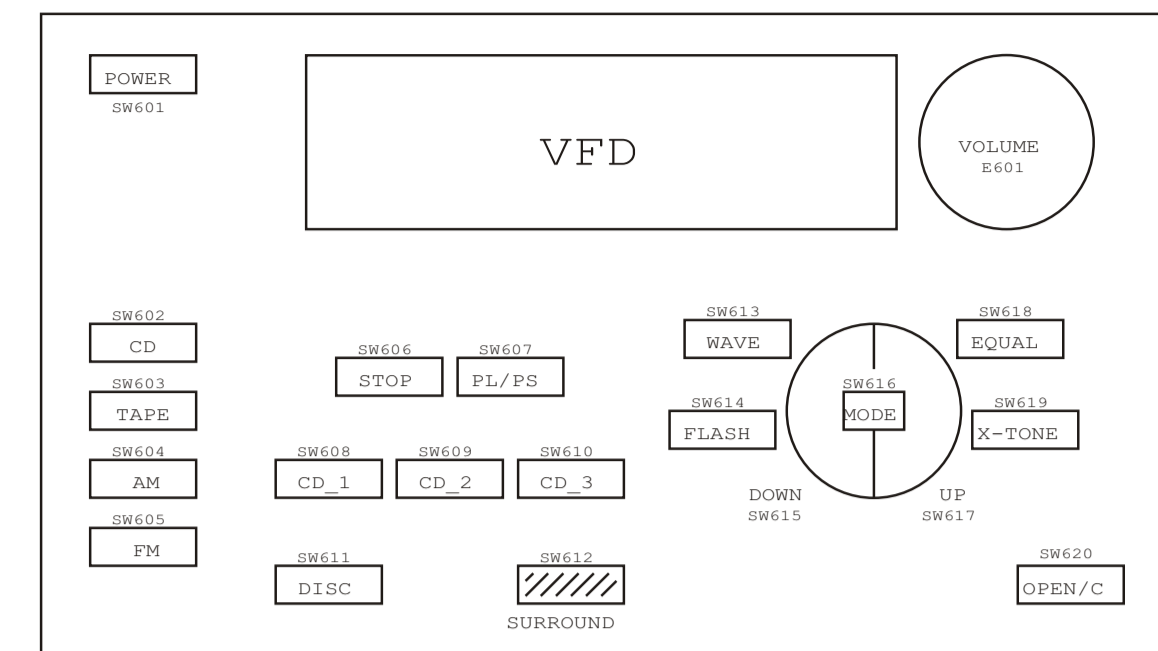

PCI LATERAL

PCI FRONTAL

1	RECORD 1	13	WAVE/Pause	25	CD	37	WAVE
2	RECORD 2	14	STOP	26	TAPE	38	EQUAL
3	RECORD 3	15	DISC	27	AM	39	POWER
4	POWER	16	OPEN/CLOSE	28	FM	40	FLASH
5	X-TONE	17	SURROUND	29	DOWN	41	UP
6	#	18	#	30	#	42	#
7	#	19	#	31	#	43	#
8	#	20	#	32	#	44	#
9	#	21	#	33	#	45	#
10	#	22	#	34	#	46	#
11	#	23	#	35	#	47	#
12	#	24	#	36	#	48	#

E	MV-186/00	R657 ERA 1K / INCLUSAO DA SERIE MD3280G	ANDRE	29/05/00
D		INCLUSAO DA SERIE MD3280F	ANDRE	04/01/00
C		INCLUSAO DA SERIE MD3280E	ANDRE	01/10/99
B		INCLUSAO DA SERIE MD3280D	ANDRE	02/09/99
A		INCLUSAO DAS SERIES B/D/F - MD3280B/C	ANDRE	03/08/99
ALT. P. A.		DISCRIMINACAO	VISTO DATA	
		TITULO: ESQUEMA ELETRICO	PROJECAO	
		PCI FRONTAL/LATERAL MD3260/MD3280	dimensoes em mm	
DES.	ROBERTO	DATA	MAT.	
PROJ.		ESC.	TOL.Ø	TOL. N°
APRO.	ANDRE	02/09/99	COD1.00.52150.06	

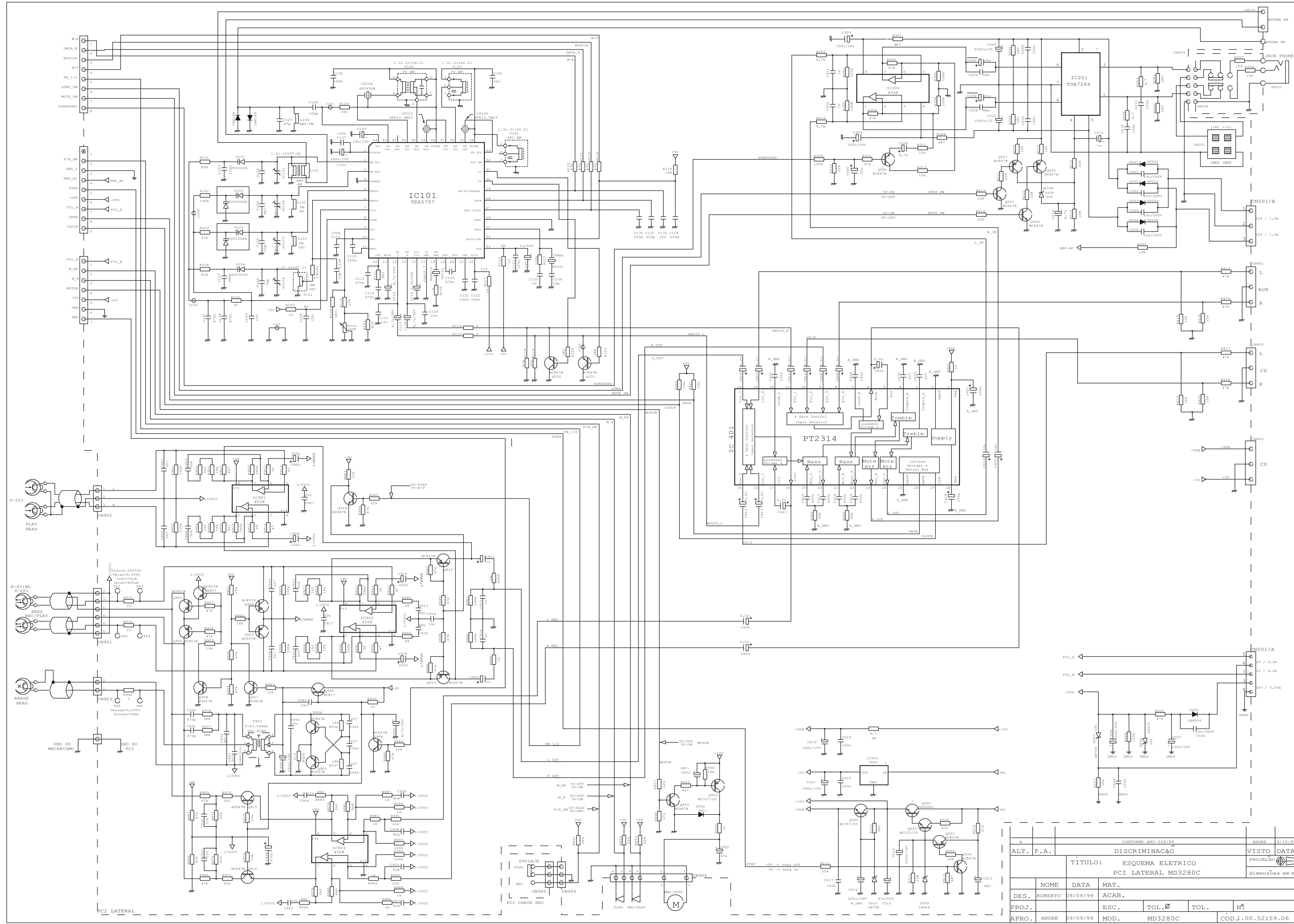

A		CONFORME AMV-339/99		ANDRÉ	4/10/99
ALT. P.A.		DISCRIMINACÃO		VISTO DATA	
		TITULO: ESQUEMA ELETRICO		PROJELDO	
		PCI LATERAL MD3280C		dimensões em mm	
DES.	ROBERTO	DATA	09/09/99	MAT.	ACAB.
PROJ.		ESC.		TOL.Ø	TOL.
APRO.	ANDRÉ	09/09/99	MOD.	MD3280C	COD.1.00.52159.06

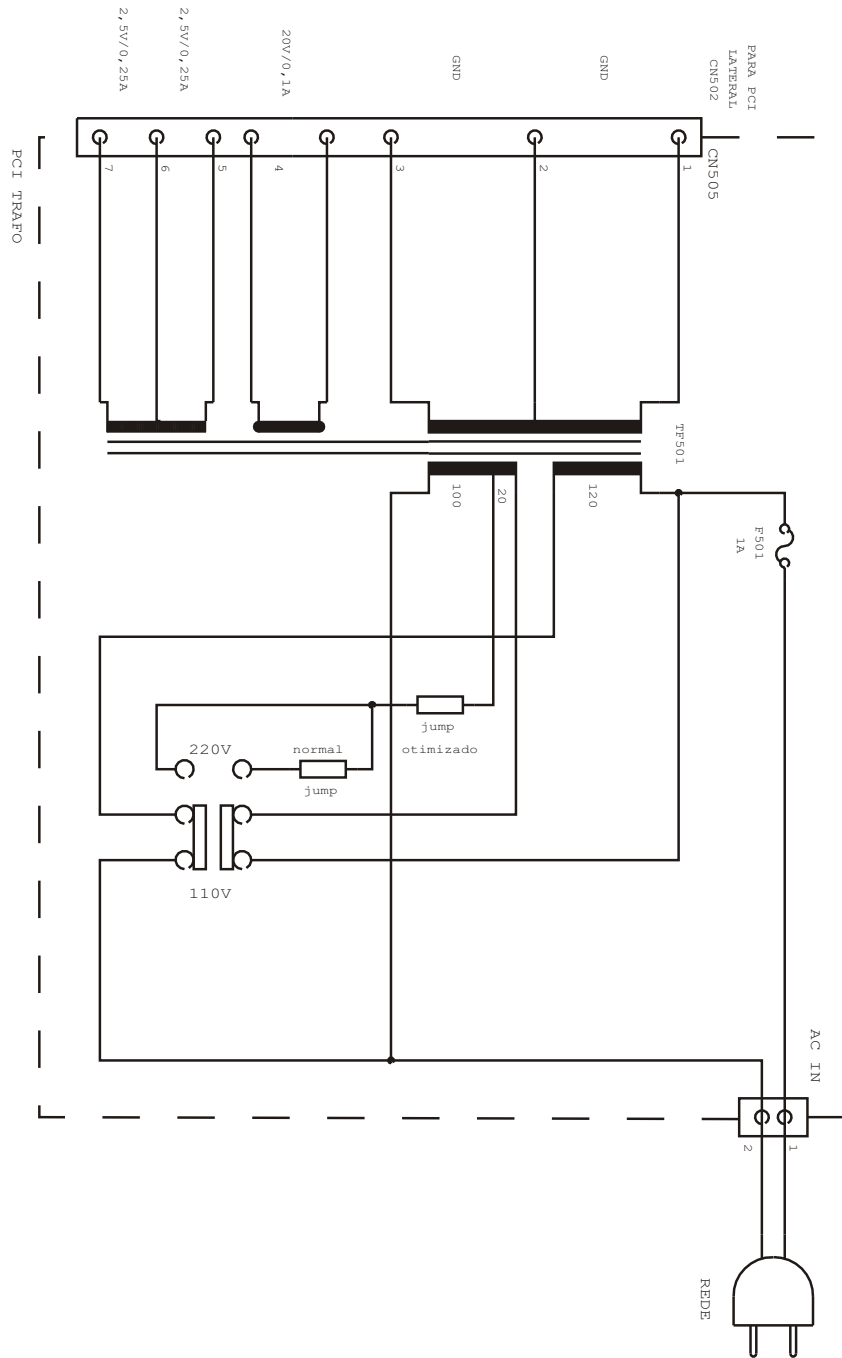

C			INCLUSAO DA SERIE MD3280E				ANDRE	01/10/99
B			INCLUSAO DA SERIE MD3280D				ANDRE	02/09/99
A			INCLUSAO DAS SERIES MD3260B/D/F-MD3280B/C				ANDRE	03/08/99
ALT.	P.A.	DISCRIMINACAQ					VISTO	DATA
		TITULO: ESQUEMA ELETRICO					PROJECAO	
		PCI TRAF MD3260A/B/D/F-MD3280B/C/D/E					dimensoes em mm	
	NOME	DATA	MAT.					
DES.	ROBERTO	11/06/99	ACAB.					
PROJ.			ESC.	TOL. Ø	TOL.	N.º		
APRO.	ANDRE	02/09/99	MOD. MD3260/MD3280			CÓD. 1.00.52150.04		

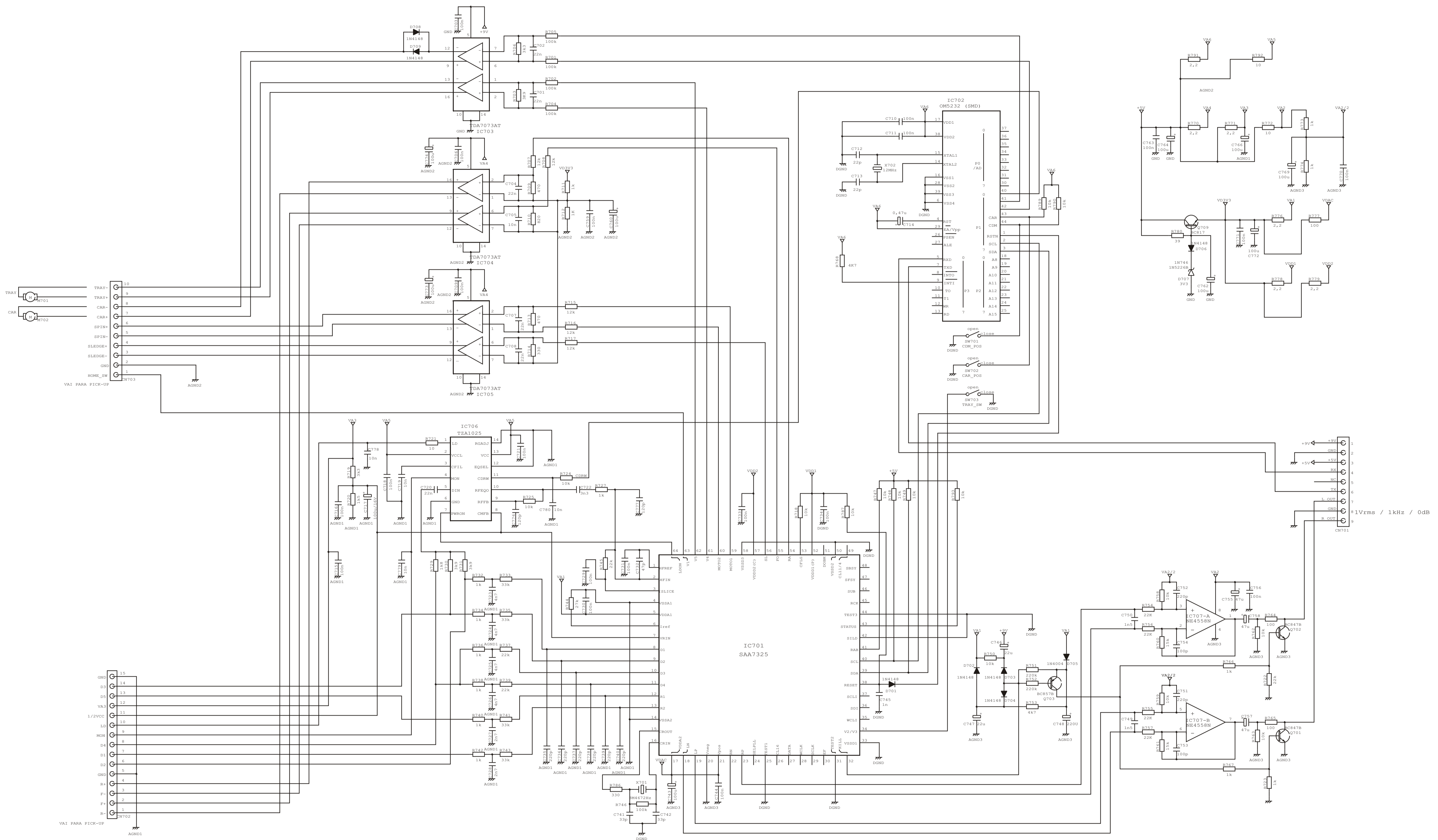

B		INCLUSAO DA SERIE MD3300F	ANDRE	20/10/99
D		INCLUSAO DAS SERIES MD3500C/D	ANDRE	15/10/99
C		INCLUSAO DAS SERIES MD3280E / MD3300E	ANDRE	04/10/99
B		CONFORME AMV-302/99	ANDRE	24/09/99
A		INCLUSAO DA SERIE MD3300D / R.703 ERA 4K7 / R.714 ERA 470R	ANDRE	10/09/99
ALT. P.A.		DISCRIMINACAO	VISTO	DATA
		TITULO: ESQUEMA ELETRICO PCI CD MD3280B/D/E-MD3300B/D/E/F-MD3500B/C/D	PROJECAO	
			dimensoes em mm	
DES.	ROBERTO	DATA 27/08/99	MAT.	ACAB.
PROJ.		ESC.	TOL.Ø	TOL. N°
APRO.	ANDRE	01/09/99	MOD. MD3280/MD3300/MD3500	COD. 1.00.52159.02

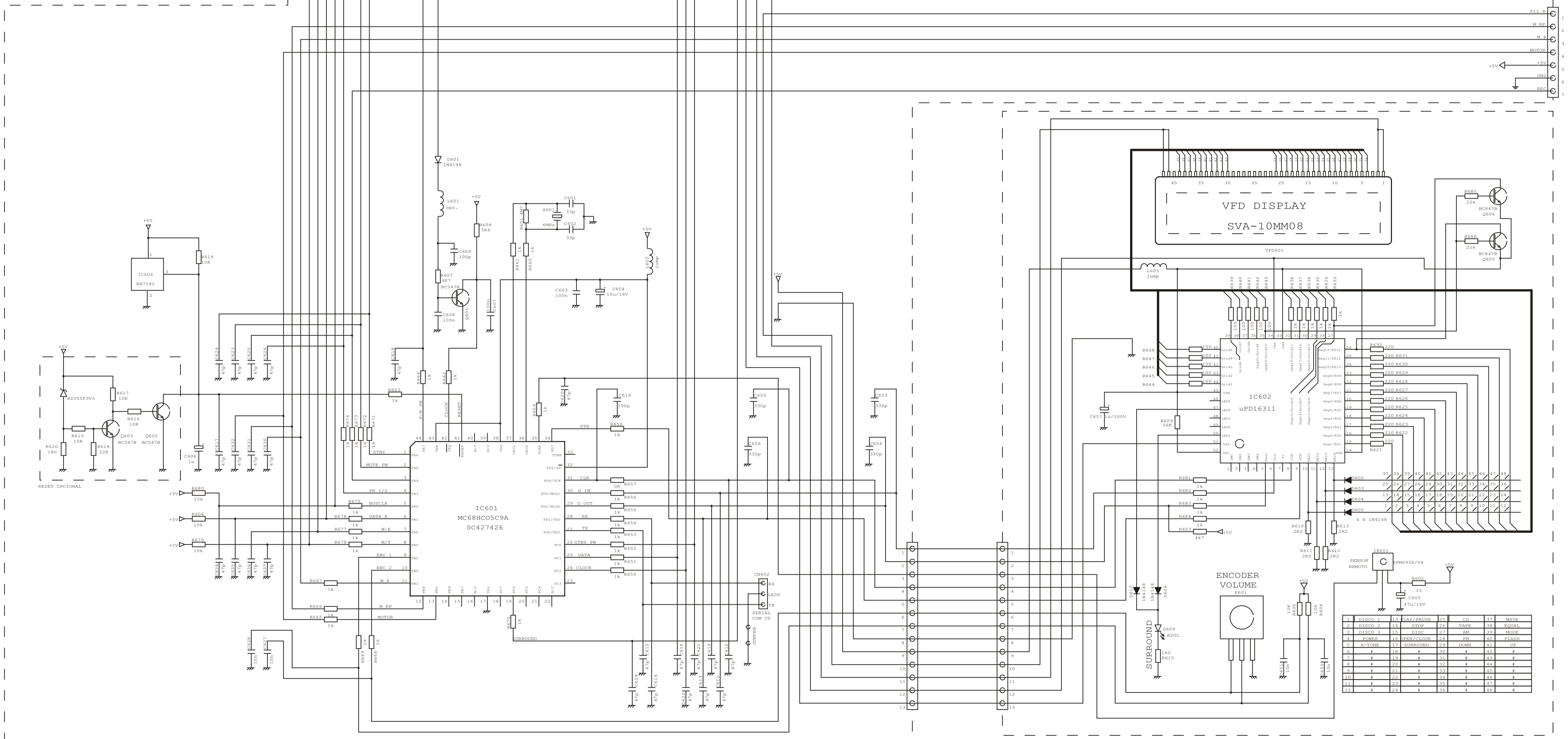
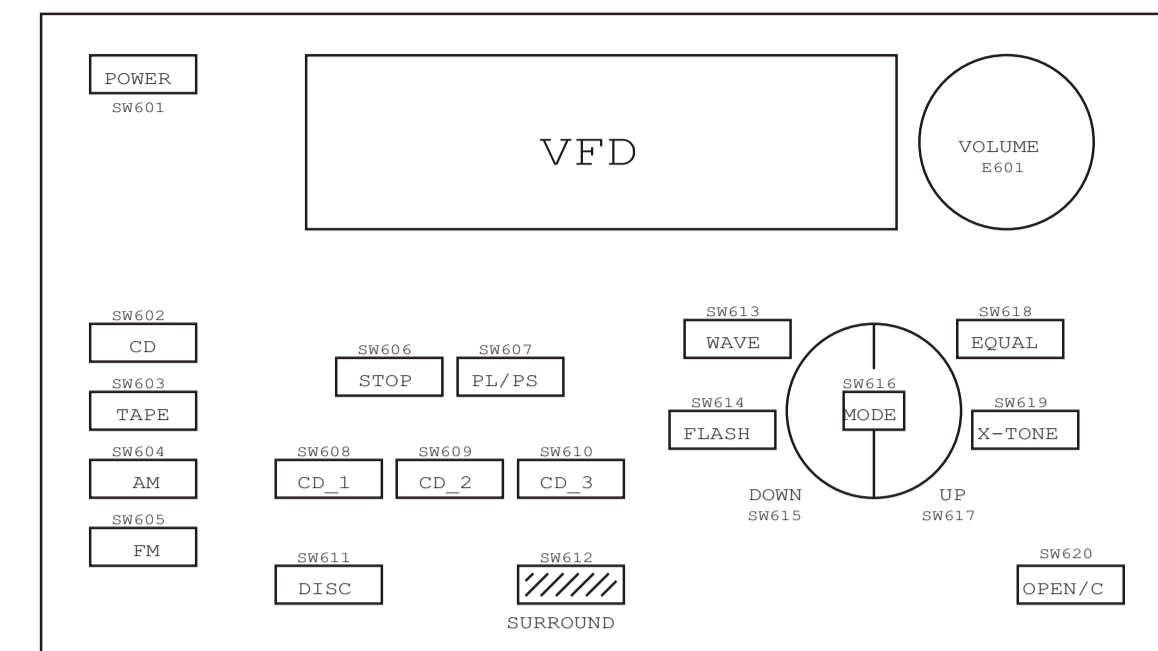

PCI LATERAL

PCI FRONTAL

1	2	3	4	5	6	7	8	9	10	11	12	13	14	15	16	17	18	19	20	21	22	23	24	25	26	27	28	29	30	31	32
1	2	3	4	5	6	7	8	9	10	11	12	13	14	15	16	17	18	19	20	21	22	23	24	25	26	27	28	29	30	31	32

E	MV-186/00	R657 ERA 1K / INCLUSAO DA SERIE MD3280G	ANDRE	29/05/00
D		INCLUSAO DA SERIE MD3280F	ANDRE	04/01/00
C		INCLUSAO DA SERIE MD3280E	ANDRE	01/10/99
B		INCLUSAO DA SERIE MD3280D	ANDRE	02/09/99
A		INCLUSAO DAS SERIES B/D/F - MD3280B/C	ANDRE	03/08/99
ALT.	P. A.	DISCRIMINACAO	VISTO DATA	
		TITULO: ESQUEMA ELETRICO	PROJECAO	
		PCI FRONTAL/LATERAL MD3260/MD3280	dimensoes em mm	
DES.	ROBERTO	11/06/99	ACAB.	
PROJ.		ESC.	TOL.Ø	TOL. N°
APRO.	ANDRE	02/09/99	COD1.00.52150.06	

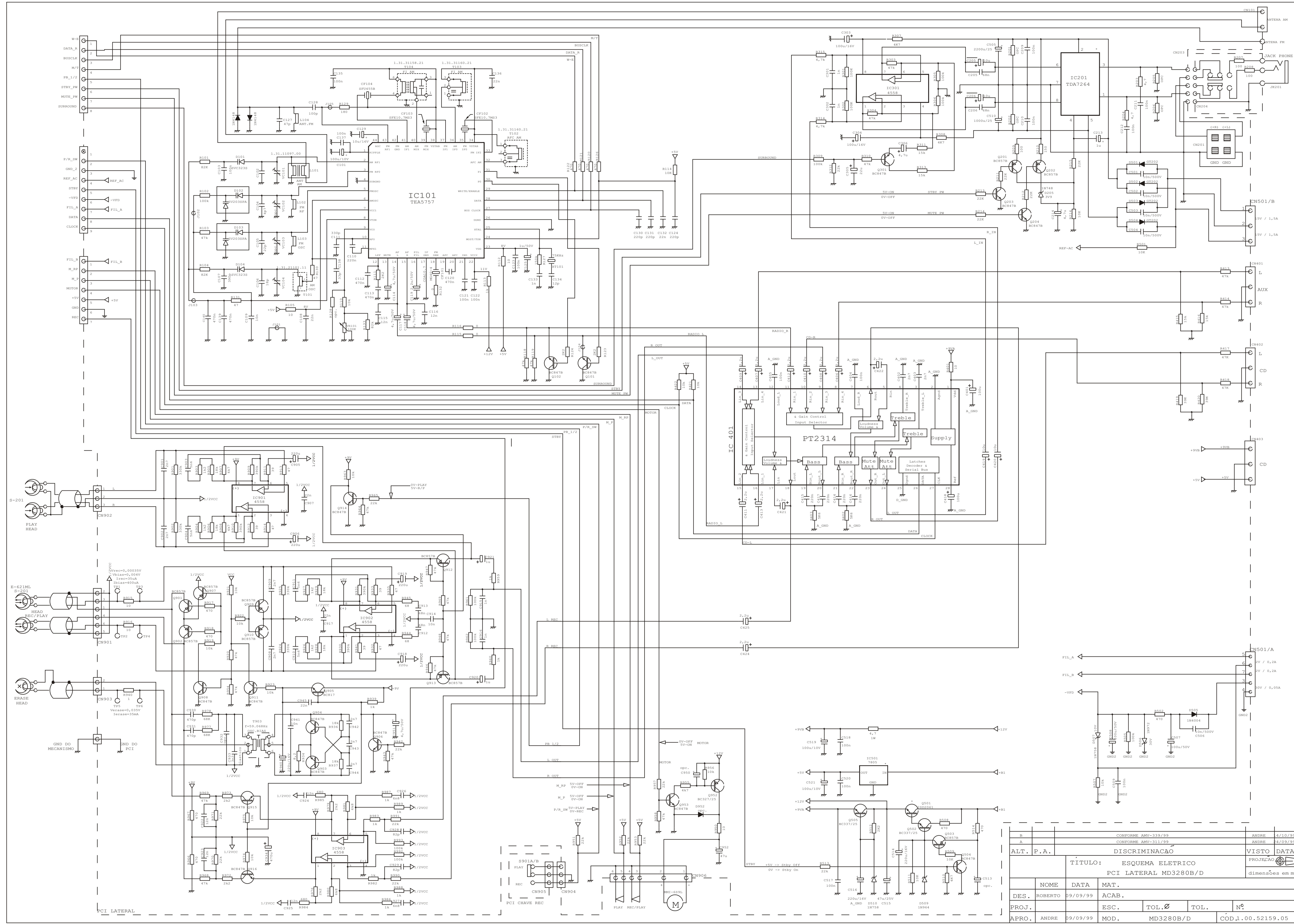

B		CONFORME AMV-339/99		ANDRE	4/10/99
A		CONFORME AMV-311/99		ANDRE	4/09/99
ALT. P. A.		DISCRIMINACAO		VISTO DATA	
		TITULO: ESQUEMA ELETRICO		PROJECAO	
		PCI LATERAL MD3280B/D		dimensoes em mm	
DES.	ROBERTO	DATA	09/09/99	MAT.	ACAB.
PROJ.		ESC.		TOL.Ø	TOL.
APRO.	ANDRE	MOD.	MD3280B/D	COD.1.00.52159.05	

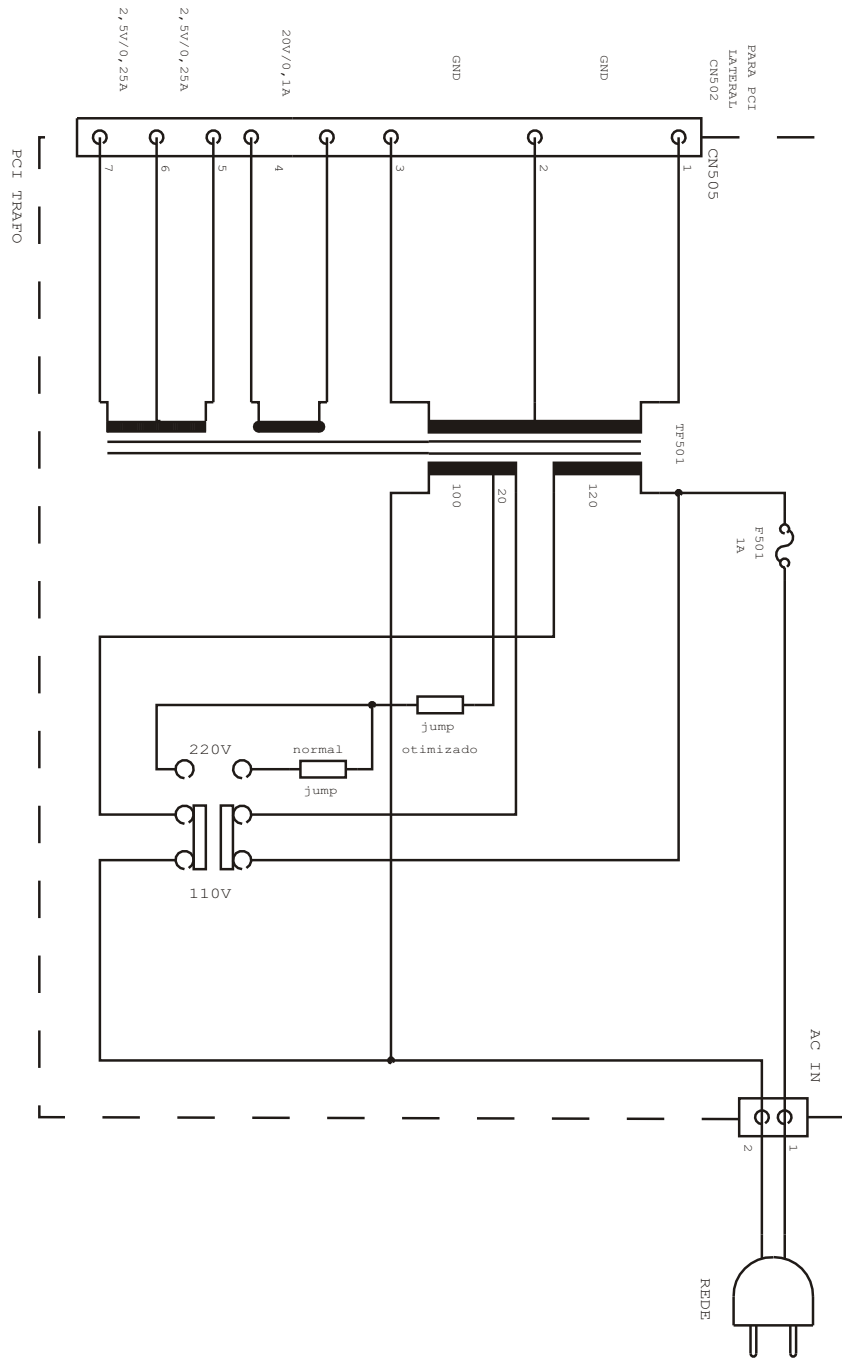

C			INCLUSAO DA SERIE MD3280E				ANDRE	01/10/99
B			INCLUSAO DA SERIE MD3280D				ANDRE	02/09/99
A			INCLUSAO DAS SERIES MD3260B/D/F-MD3280B/C				ANDRE	03/08/99
ALT.	P.A.	DISCRIMINACAQ					VISTO	DATA
		TITULO: ESQUEMA ELETRICO					PROJECAO	
		PCI TRAF0 MD3260A/B/D/F-MD3280B/C/D/E					dimensoes em mm	
	NOME	DATA	MAT.					
DES.	ROBERTO	11/06/99	ACAB.					
PROJ.			ESC.	TOL. Ø	TOL.	N.º		
APRO.	ANDRE	02/09/99	MOD. MD3260/MD3280			CÓD. 1.00.52150.04		

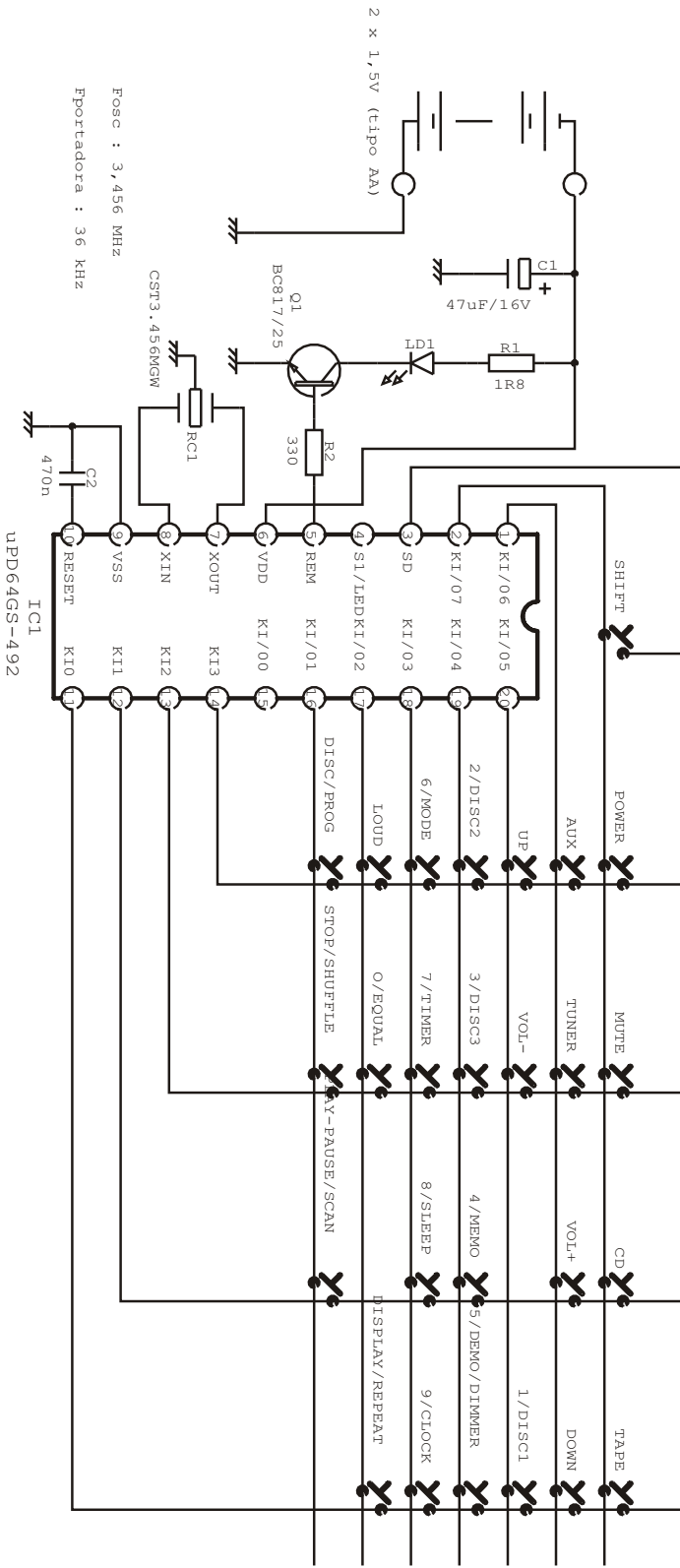

A		INCLUIDOS R2 E C2		ANDRE	02/02/00	
ALT.	P.A.	DISCRIMINAÇÃO			VISTO	DATA
TÍTULO: ESQUEMA ELETRICO PCI CONTROLE REMOTO RC16				PROJEÇÃO		
				dimensões em mm		
DES.	NOME	DATA	MAT.			
	ROBERTO	10/01/00	ACAB.			
PROJ.			ESC.	TOL. Ø	TOL.	Nº
APRO.	ANDRE	10/01/00	MOD.	MD3280F	CÓD1.00.52159.10	

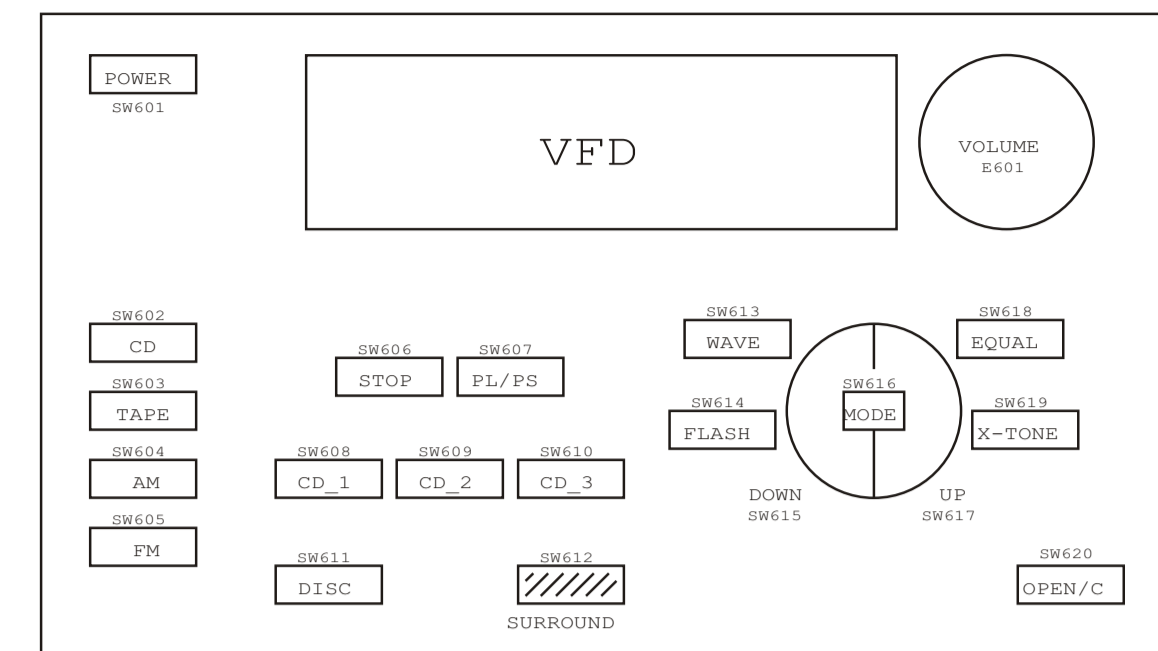

SEQUENCIA NO PAINEL

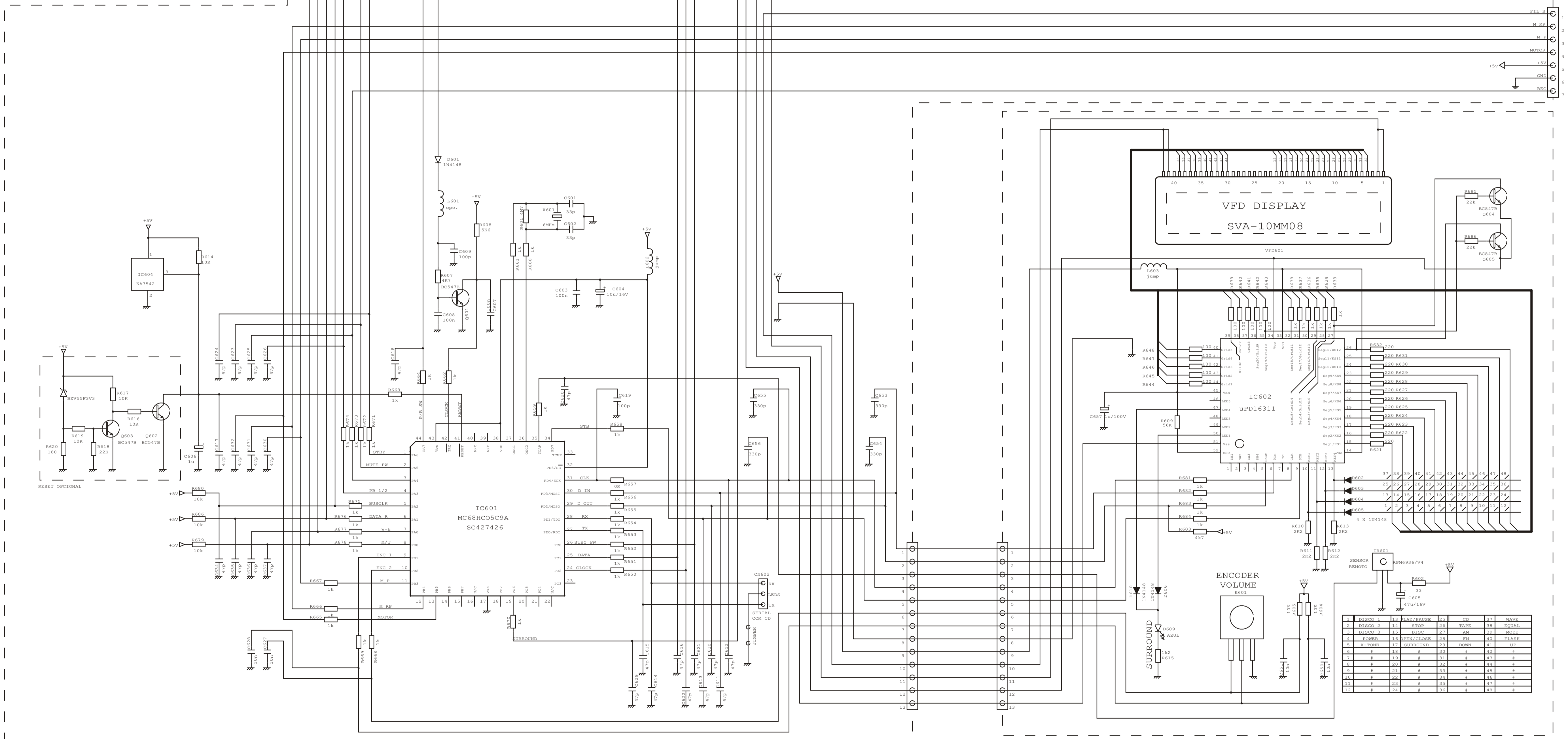

PCI LATERAL

PCI FRONTAL

1	2	3	4	5	6	7	8	9	10	11	12	13	14	15	16	17	18	19	20	21	22	23	24	25	26	27	28	29	30	31	32
1	2	3	4	5	6	7	8	9	10	11	12	13	14	15	16	17	18	19	20	21	22	23	24	25	26	27	28	29	30	31	32

E	MV-186/00	R657 ERA 1K / INCLUSAO DA SERIE MD3280G	ANDRE	29/05/00
D		INCLUSAO DA SERIE MD3280F	ANDRE	04/01/00
C		INCLUSAO DA SERIE MD3280E	ANDRE	01/10/99
B		INCLUSAO DA SERIE MD3280D	ANDRE	02/09/99
A		INCLUSAO DAS SERIES B/D/F - MD3280B/C	ANDRE	03/08/99
ALT.	P. A.	DISCRIMINACAO	VISTO DATA	
		TITULO: ESQUEMA ELETRICO	PROJECAO	
		PCI FRONTAL/LATERAL MD3260/MD3280	dimensoes em mm	
DES.	ROBERTO	11/06/99	ACAB.	
PROJ.			ESC.	
APRO.	ANDRE	02/09/99	TOL.Ø	TOL. N°
		MD3260A/B/D/F-MD3280B/C/D/E/F/G	COD1.00.52150.06	