

CONCORD

STEREO TAPE RECORDER MODEL 107S and 107S/A SERVICE DATA

Supplied by: CONCORD ELECTRONICS CORP.
809 North Cahuenga Boulevard
Los Angeles 38, California

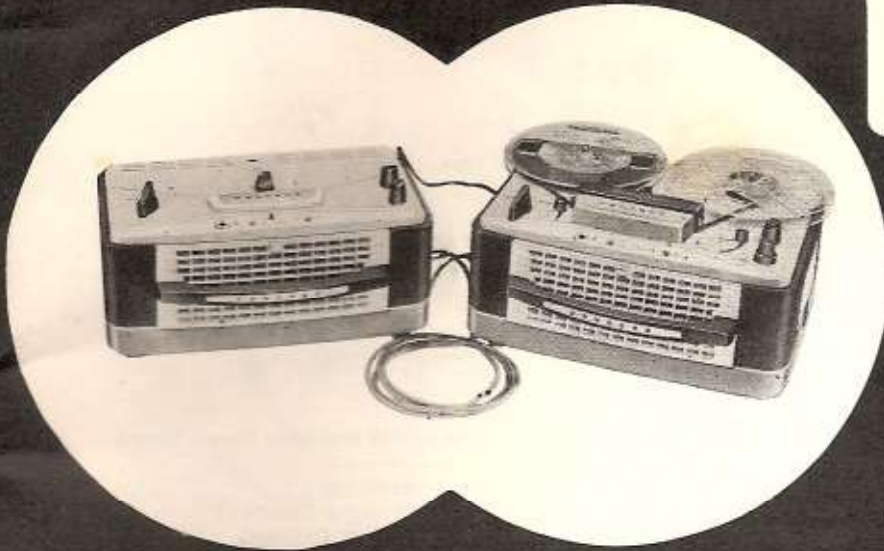

INDEX

	Page
SPECIFICATIONS	2
CONTROLS	3
DISASSEMBLY INSTRUCTIONS	5
TAPE TRANSPORT CONTROL FUNCTIONS	6
ADJUSTMENTS	7
LUBRICATION AND CLEANING	9
TROUBLE SHOOTERS' GUIDE	9
REPLACEMENT PARTS	20
VIEW OF ASSEMBLY	24
EXPLODED VIEW OF TAPE TRANSPORT MECHANISM	25
SCHEMATIC DIAGRAM	38

SPECIFICATIONS

Tape Speed	:	7.5 and 3.75 ips, dual track
Heads	:	2-heads, Mu-metal shielded laminated professional type. 1/4 track stereo erase head 1/4 track stereo record/play head For 4-track individual monaural recording and 4-track stereophonic recording and reproduction, as well as 2-track stereophonic reproduction.
Wow and Flutter	:	7.5 ips—less than 0.20% RMS 3.75 " " " 0.30% "
Frequency Response	:	7.5 ips 40–15,000 cps. 3.75 " 40–10,000 "
Signal to Noise Ratio	:	Better than 50 db per each channel.
Crosstalk Rejection	:	Better than 50 db.
Inputs	:	A) High Impedance: 1.2M Ω for recording from AM/FM or FM Multiplex Tuner, Stereo Disc and Tape. B) Low Impedance: 20K Ω for recording from Dynamic Microphone.
Outputs	:	A) 5W, 3.7 Ω for external earphone/speaker. (1 each for Left/Right Channels) B) High Impedance (100K Ω) for external main amplifier (for Left Channel). C) Tape Head direct output for connection with 107S/A preamplifier.
Recording Level Indicator	:	Magic-eye.
Monitoring	:	By Crystal earphone.
Tube Complement	:	Model 107S: One-6267 (EF86), One-6AU6 One-6DT8, One-6AV6, One-6AR5, One-6ME10 and Selenium Rectifier. Model 107S/A: One-6267 (EF86), One-6DT8, One-6AR5, One-6X4 and One-6ME10.
Switches and Controls	:	Model 107S: a. Selector Control for FORWARD-STOP-REWIND. b. Record Safety Lever to prevent accidental erasure. c. Speed Selector for 7.5 and 3.75 ips. d. Fast Forward Lever. e. Socket for Remote Control Switch. f. Volume Control-A and B. g. Tone Control. h. Microphone Input Jack (for Right channel). i. Radio/Phono Input Jack (for Right channel). j. Earphone Jack (for Right channel). k. Output Jack for External Speaker (for Right channel). l. Left channel preamplifier output jack for external main amplifier. m. Switch for Sound-On-Sound recording. n. Stereo and monaural track selector switch. o. Stereo and monaural modes selector switch. p. Socket for connection with 107S/A Model 107S/A: a. Play and record modes selector switch. b. Equalization circuit selector for 7.5 and 3.75 ips speeds. c. Volume Control. d. Tone control. e. Microphone Input Jack (for Left channel). f. Radio/Phono Input Jack (for Left channel). g. Earphone Jack (for Left channel). h. Output Jack for External Speaker (for Left channel). i. Socket for connection with 107S.
Remote Control	:	Electrimatic control for recording and playback.
Power Rating	:	100W total, 110–120V, 60 cycles, AC.
Dimensions and Weight	:	Model 107S: 13-1/2" \times 10-1/4" \times 6-3/4", 22 lbs. Model 107S/A: 13" \times 8-3/8" \times 6-5/8", 12 lbs.
ACCESSORIES:	:	Model 107S: a) 1-Electrimatic Remote Control with cord and plug. b) 1-High fidelity Dynamic Microphone. c) 1-Crystal Earphone. d) 1-7" Empty Reel. e) 1-Splicing Tape. f) 1-Radio/Phono recording Patch cord. g) 1-Preamplifier output cord. h) 1-3.7 Ω Dummy Load Resistor. Model 107S/A: a) 1-High fidelity Dynamic Microphone. b) 1-Crystal Earphone. c) 1-Radio/Phono recording patch cord. d) 1-Patch cord for connection with 107S.

CONTROLS

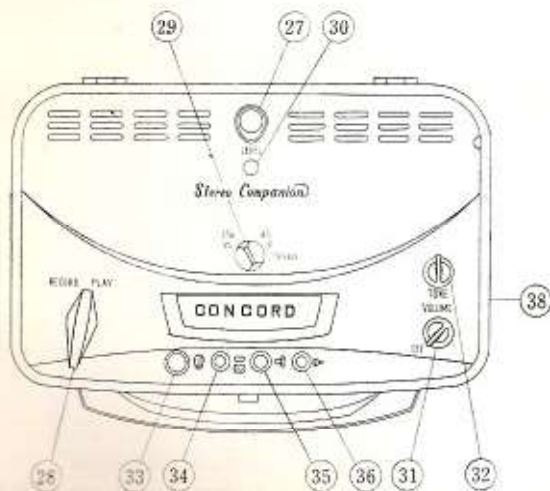
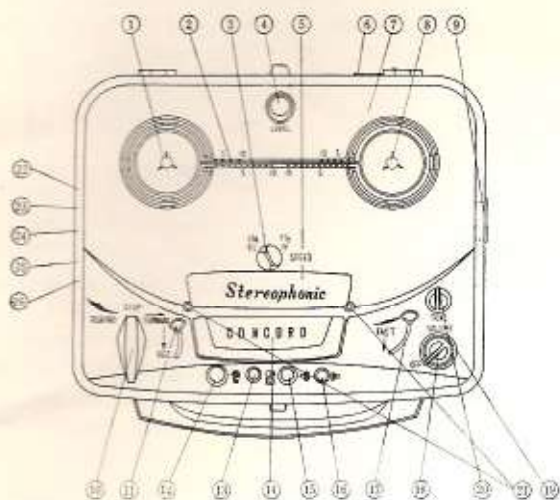

SELECTOR CONTROL (10)

1. In the REWIND position, the tape just recorded or played back is rewound rapidly.
2. In the STOP position, the tape motion stops.
NOTE: Always return to this position before turning off the recorder, or threading a new tape.
3. In the FORWARD position, the tape advances and the sound recorded on the tape is played back.
4. In the FORWARD position after pulling the "REC" Lever (11) towards you, recording can be made, or the previous recording on the tape can be automatically erased.

107S

1. Rewind Reel Spindle
2. Tape Scale.
3. Speed Selector Knob.
4. Magic-eye Level Indicator-A.
5. Head Cover-B
6. Pocket-A
7. Panel
8. Takeup Reel Spindle
9. Remote Control Socket
10. Selector Control
11. "REC" (Record Safety) Lever
12. "MIC" Input Jack-A
13. "RADIO/PHONO" Input Jack-A
14. Head Cover-A
15. Earphone Jack-A
16. Output Jack for External Speaker-A
17. Fast Forward Lever
18. Volume Control-A with ON/OFF Switch
19. Volume Control-B
20. Tone Control-A
21. Tape Guide
22. Output Jack for External Main Amplifier
23. Sound-on-sound Recording Switch
24. Channel Selector
25. Mode Selector-A
26. Jack for connection with 107S/A

107S/A

27. Magic-eye Level Indicator-B
28. Mode Selector-B
29. Equalization Circuit Selector
30. Pilot Lamp
31. Volume Control-C with ON/OFF Switch
32. Tone Control-B
33. "MIC" Input Jack-B
34. "RADIO/PHONO" Input Jack-B
35. Earphone Jack-B
36. Output Jack for External Speaker-B
37. Jack for connection with 107S

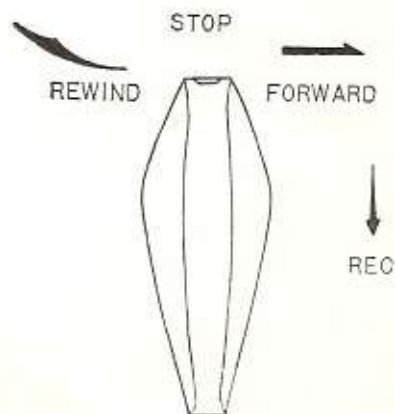

VOLUME CONTROL-A WITH ON/OFF SWITCH (18)

This control turns the 107S recorder "ON" by turning it to the right (clockwise direction) until it clicks. For monaural record and playback, it controls the recording level and playback level respectively. For stereo playback, it controls the right channel playback level, and for stereo record, it controls the right channel recording level. For sound-on-sound recording, it controls the recording level of the latest sound source being mixed with the old recording.

VOLUME CONTROL-B (19)

For 4-track stereo playback with 107S only, it controls the left channel preamplifier output level fed into an external amplifier/speaker.

During sound-on-sound recording, it controls the recording level of the previously recorded sounds being mixed with the new recording.

FAST FORWARD LEVER (17)

With the Selector Control turned to "FORWARD" position pulling this lever towards you advances the tape rapidly. To stop fast forward motion, turn the Selector Control to the STOP position.

"REC" (RECORD SAFETY) LEVER (11)

To record, pull this "REC" lever towards you, and turn the Selector Control to the FORWARD position. Presetting optimum recording level can be made by turning the Selector Control to STOP position and by pulling the "REC" lever towards you. The shadow of the Magic-eye Level Indicator (4&27) should close at the loudest peak of sound at the optimum level.

MICROPHONE INPUT JACK (12 & 33)

The plug at the end of the microphone cord fits into this receptacle.

RADIO/PHONO INPUT JACK (13 & 34)

For recording from a radio, phonograph, or T.V. The plug at the end of the patch cord fits into this receptacle.

SPEED SELECTOR KNOB (3)

The tape speed can be selected by turning this knob. For 7.5 ips press this knob down and turn it clockwise. For 3.75 ips turn this knob counter-clockwise until the knob is automatically lifted. This knob automatically determines the proper equalization circuit.

EARPHONE JACK (15 & 35)

The earphone may be plugged into this jack for the purpose of monitoring while recording, or for private listening to reproduced sound.

REMOTE CONTROL SOCKET (9)

The plug at the end of the Remote Control Switch fits into this receptacle.

OUTPUT JACK FOR EXTERNAL MAIN AMPLIFIER (22)

For connecting the left channel preamplifier output signals to an external main amplifier. Using the external main amplifier and speaker, or units such as Radio, Phonograph, or T.V., a full stereophonic playback is made.

SOUND-ON-SOUND RECORDING SWITCH (23)

For monaural record and playback, set this switch at the NORMAL position. When set at the SOUND-ON-SOUND RECORDING position, monaural sound-on-sound recording is made. In this instance, the 107S/A or other external main amplifier need not be connected to the Model 107S.

CHANNEL SELECTOR SWITCH (24)

When set at "MONO 1&4", monaural record or playback is made on channel 1 or 4.

If set at "MONO 3&2", monaural record or playback is made on channel 3 or 2.

If set at "STEREO" (which is the same position as "MONO 3&2") in conjunction with the 107S/A, full stereophonic recording or reproduction is made.

Stereophonic sound recording cannot be made without the 107S/A, however, stereo reproduction can be achieved by using any external main amplifier and speaker system.

MODE SELECTOR-A (25)

If turned to NORMAL, 4-track monaural record or playback is made without using an external main amplifier or the 107S/A.

For 4-track stereo playback, set the selector at NORMAL position.

If turned to STEREO OPERATION in conjunction with the 107S/A, full stereophonic recording can be made.

JACK FOR CONNECTION WITH 107S/A (26)

For connection to the 107S/A Speaker Amplifier. The plug at the end of connector cord fits into this receptacle.

JACK FOR CONNECTION WITH 107S (37)

For connecting the 107S recorder to the 107S/A. The plug at the end of the connector cord fits into this receptacle.

MODE SELECTOR-B (28)

For selecting record or playback modes of the 107S/A. When recording stereophonically with the 107S, turn this switch to RECORD. And when reproducing stereophonically, turn this switch to PLAY.

EQUALIZATION CIRCUIT SELECTOR (29)

For selecting equalization circuitry in conjunction with the speed selected. Always set this selector to the speed selected by the 107S, in order to match the equalization circuitry of both amplifiers.

VOLUME CONTROL-C WITH ON/OFF SWITCH (31)

For turning "ON" the 107S/A recorder amplifier/speaker. During playback, this control determines the left channel sound level and when recording stereophonically, it controls the left channel recording level.

DISASSEMBLY INSTRUCTIONS

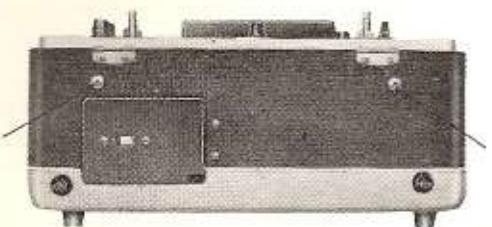

TO REMOVE PANEL FROM CABINET :

Model #1075 :

1. Remove all detachable accessories such as microphone or tape reels from the recorder.
2. Remove other accessories from the storage pocket.
3. Remove Control Knobs.
4. Remove Head Cover-B and unscrew and remove the two screws (Tape Guide) at both sides of Head Cover-B.
5. Remove the two screws retaining the panel at the left and right reel pan base.
6. Lift the panel with care.

Model #1075/A :

1. Remove all detachable accessories.
2. Remove Control Knobs.
3. Remove three screws retaining the panel.
4. Lift the panel with care.

TO REMOVE ASSEMBLY FROM CABINET :

Model #1075 :

1. Remove panel from cabinet as described above.
2. Remove two screws at the rear of the cabinet.
3. Remove three screws at the bottom of the cabinet.
4. Pull the speaker plug off from the amplifier chassis.
5. Lift the assembly out of the cabinet with care.

Model #1075/A :

1. Remove panel from cabinet as described above.
2. Remove three screws at the bottom of the cabinet.
3. Pull the speaker plug off from the amplifier chassis.
4. Lift the assembly out of the cabinet with care.



TAPE TRANSPORT CONTROL FUNCTIONS

AC POWER SWITCH :

AC power is supplied to motor and amplifier by turning Volume Control knob-A (18) or C (31) slightly (clockwise) until it clicks.

TAPE SPEED SELECTION :

The tape speed can be adjusted by turning the Speed Selector Knob (3). For 7.5 ips press the knob down and turn it clockwise. For 3.75 ips turn the knob counter-clockwise until the knob is automatically lifted. Turning the knob automatically selects the proper equalization circuit.

BRAKE ACTION :

1. If the Selector Control (10) is turned to the "STOP" position from "REWIND" position, the brake (17) stops the takeup hub (19), but the brake (29) does not contact rewind hub (19).
2. If the Selector Control (10) is turned to the "STOP" position from "FORWARD" position, both brakes (17 and 29) stop the takeup hub (19) and rewind hub (19).

TAKEUP DRIVE :

Flywheel (54) is driven by the idler wheel (13) from motor pulley at constant speed. Tape speeds are determined by the upper or lower position of the idler wheel-A (13). Takeup hub (19) is driven by idler wheel (13) from the larger diameter motor pulley. Takeup hub (19) couples with the takeup drum (81) by friction, and the friction between them provides a constant forward tension to the tape.

PINCH ROLLER AND PRESSURE PAD :

With the Selector Control (10) in "REWIND" or "STOP" positions, selector cam (37) indirectly forces pinch roller arm (3) to the front by the stop lever (41). The pinch roller (1) is then held away from the capstan (2). At the same time, pinch roller arm (3) directly forces pressure pad assembly (48) to the front. The tape is held away from both heads by the tape holdout lever on the tape pad assembly (48). When the pinch roller arm (3) and pressure pad assembly (48) are freed from the selector cam (37), the pressure pad (46) will press the tape lightly against both heads; and the pinch roller (1) will press the tape against the capstan (2).

PLAYBACK AND RECORD :

When the Selector Control (10) is set at "FORWARD" position:

1. It moves the brake (17) away from takeup hub (19) by means of the Selector Lever-A (34).
2. It forces the pinch roller (1) to contact against the capstan (2)
3. It forces the pressure pads against respective heads.
4. Drive idler-A (13) contacts with pulley and flywheel (54), and idler wheel-C (13) contacts friction roller (81) and motor pulley simultaneously.

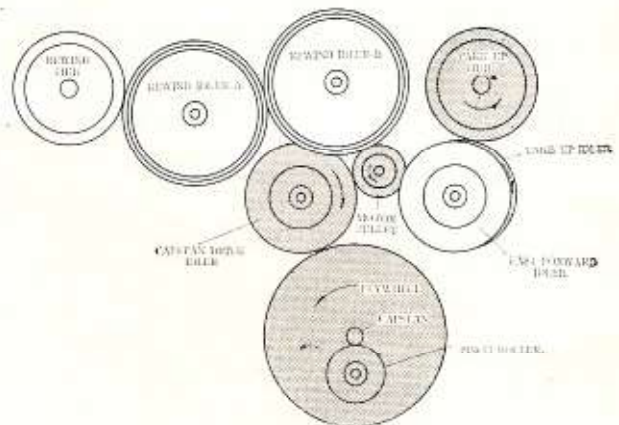

FAST FORWARD :

When the Selector Control (10) is set at the "FORWARD" position, pulling the Forward Lever (17) toward you closes the coupling between takeup drive hub and the idler wheel-B (13), thus driving the takeup hub at a fast rate. At the same time, the pinch roller (1) and pressure pad assembly (48) are held away from the capstan (2) and both heads (154 and 155) respectively.

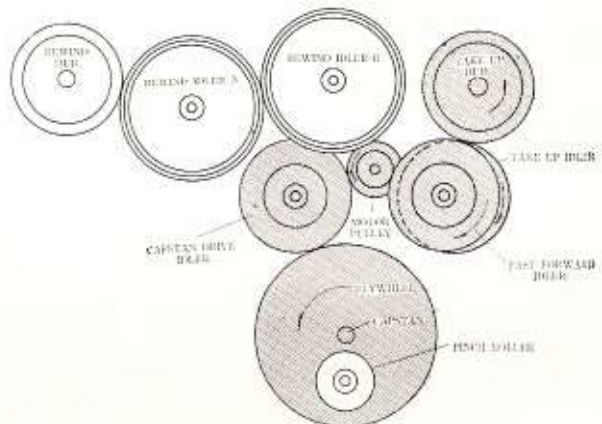

REWIND :

When the Selector Control (10) is set at "REWIND" position:

1. It moves the brakes away from both reel hubs (19).
2. Selector Cam (37) moves the pinch roller (1) and pressure pad assembly (48) away from capstan (2) and both heads respectively.
3. Rewind drive pulley arm (62) is freed from the Selector Slide (30) and the rewind drive pulley (28) contacts with motor pulley. The rewind hub (19) is then driven at a fast speed.

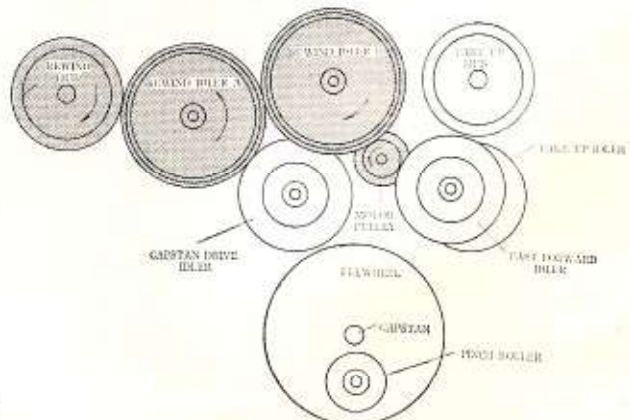

5. TAKEUP TORQUE ADJUSTMENT :

The takeup hub (19) is driven by the takeup drum (81). The proper takeup torque should be 8.75 to 13.9 oz. per inch and, if that is not available, replace the friction felt (82).

6. ADJUSTMENT OF SELECTOR LEVER-A (34) PIVOT POST :

Adjust the pivot post (7) of selector lever-A (34), so as the roller of the brake lever (62) drops in the recessed portion of the selector slide (30) when the selector control is turned to the "REWIND" position.

7. ADJUSTMENT OF SELECTOR LEVER-B (32):

The idler wheel (13) is placed $5/32$ " apart from the larger diameter motor pulley, when the selector control is in the "STOP" position.

8. ADJUSTMENT OF FAST FORWARD LEVER :

After completion of the "Idler Wheel-B Adjustment", set the Fast Forward Lever $3/16$ " apart from the roller of Fast Forward Lever-B (4).

9. ADJUSTMENT OF PINCH ROLLER LEVER :

After completion of the "Adjustment of Fast Forward Lever", adjust the stop lever (41) adjustment screw so that there will be a distance of $1/32$ " between the roller

of the Fast Forward Lever-B (4) and the cam portion at the center of the pinch roller lever (3) with the selector control set at "STOP" position.

10. TAPE PRESSURE PAD ADJUSTMENT :

After completion of the "Adjustment of Pinch Roller Lever", turn the selector control to the "FORWARD" position and pull the fast forward lever toward you. Adjust the screws of the pinch roller arm (3) so that the tape will be $3/16$ " apart from the erasing head. The tape pressure pad holder must be parallel to the surface of the heads, and can be adjusted by the lug plate of the pressure pad spring.

11. ADJUSTMENT OF RECORD LEVER (210):

When the record safety lever is pulled toward you before the Selector Control is set at the "FORWARD" position, the record switch lever (210) must be locked by the stop lever (41).

The allowance of contact of the record switch lever (210) and the stop lever (41) is about $1/64$ " to $1/32$ ". The height of the record switch lever is set at $2-5/32$ " from the baseplate (207).

To perform noise and distortion free recording, the following points should be properly adjusted.

AMPLIFIER ADJUSTMENTS

1. OSCILLATION FREQUENCY :

The record bias and erase frequency are determined by the inductance of the oscillator coil and C17 (molded mica capacitor, $1.500 \text{ PF} \pm 5\%$). Frequency is adjusted at $50\text{KC} \pm 3\text{KC}$. However, if the oscillation frequency is not within the above range, adjust the frequency by turning the adjust screw of the dust-core of the oscillator coil. If the frequency is not within the above range, check the oscillator coil, C17 (molded mica capacitor, $1.500\text{PF} \pm 5\%$) and erase head (155).

2. RECORD BIAS :

To check record bias, connect V.T.V.M. across the terminals of the record head (154). If the reading is between 40-55V, the bias is proper, if not, adjust the padding capacitor (C40 and C41) to obtain the above voltage. If the recording bias is lower than the above voltage, distortion will appear in the recording sound, and if the bias is excessive, the treble tone will decrease.

3. ERASE VOLTAGE AND CURRENT :

Poor erasing may occur if the proper current is not supplied to the erase head(155).

Voltage is measured at the terminal of the head and the voltage should be between 60-90V, on V.T.V.M.

4. RECORDING LEVEL :

Proper recording level is adjusted as follows:
Set the volume control at the maximum position.
Feed 1,000 cycle signal at $-65\text{db} \pm 2\text{db}$ (0.35mV to 0.55mV) from "MIC" input jack, and adjust until the magic-eye level indicator (6ME10) closes.

If the indicator does not close at that voltage, or will close with lower voltage, adjust the variable resistor VR4 ($1\text{M}\Omega\text{-B}$).

Further, if the magic-eye level indicator is replaced, the above adjustment will be required, since the sensitivity of each tube varies in each instance.

5. SOUND-ON-SOUND BIAS LEAKAGE BALANCER :

Set the recorder in RECORD mode and set S2 and S3 at NORMAL position then connect oscilloscope to the Preamplifier Output Jack (Output Jack for External Main Amplifier-22) with Volume Control-B (19) turned to maximum position. In this instance, no connection should be made to the Jack for connection with 107S/A (26). Adjust the trimmer capacitor (C42) so that the minimum hum level can be obtained when switched to "CH 1 & 4" and CH 3 & 2".

6. RECORDING EQUALIZATION: (On 107S/A)

When the recorders are set at RECORD mode, set the Equalization Circuit Selector (29) at 7.5 ips position and feed 12KC-65db signal to the "MIC" input jack (33) with volume control (31) turned to maximum position, and adjust the peaking coil in the cathode circuit (L1) so that the maximum output is obtained at the plates of V2B or terminals of the earphone.

LUBRICATION & CLEANING

LUBRICATION:

All rotating parts are provided with suitable bearings. These are all factory lubricated and normally require no further attention. However, should lubrication be required, use sewing machine oil sparingly.

CAUTION: All surfaces which come in contact with tape and rubber parts must be kept clean and free from oil. Too much oil is undesirable.

LUBRICATION OF FLYWHEEL:

Inject 5 drops of sewing machine oil through the lubrication hole located at the bottom of the capstan, for every 300 hours. It is desirable to use an injector for this purpose.

After lubrication, remove excessive overflow surface oil with alcohol.

CLEANING:

The record head (154), erase head (155), tape guide (43), capstan (2) and pinch roller (1) are subject to an accumulation of tape coating residue. Use a soft cloth and carbon tetrachloride to clean the above-mentioned parts. Rubber tired idler wheels (13), rewind rollers (28) and pinch roller (1) must be kept free from oil or grease. Use a soft cloth dampened with carbon

tetrachloride to clean oil and grease from rubber parts. When you clean these parts, do not forget to clean other rollers which are in contact with these parts.

LUBRICATION POINTS

1. Idler Wheel (13).....2 drops to the shaft
1 drop to the bearing
2. Pinch Roller (1).....2 drops to the shaft
1 drop to the bearing
3. Flywheel (54)2 drops to the shaft
1 drop to the bearing
4. Rewind Pulley (28)2 drops to the shaft
1 drop to the bearing
5. Reel Hub (19).....2 drops to the shaft
2 drops to the bearing
6. Friction Roller (81)1 drop to the bearing
7. Selector Cam (37).....1 drop to the bearing

GREASING POINTS

1. Selector Slide (30)Inside of the oval shape hole
2. Selector Lever-A, B (32 & 34)ditto-
3. Selector Cam (37).....Cam part
4. Flywheel Bearing (54)

TROUBLE SHOOTERS' GUIDE

Symptom	Cause	Checking Point	Remedy
Capstan fails to start	I. Defective Motor	Coil Motor Shaft	Replace Overhaul Overhaul and Clean
	1. Disconnection of motor coil		
	2. Sticking of metallic parts		
	3. Foreign matter between rotor and stator		
	II. Defective mechanical transmission, but motor rotates		
	1. Oily idler, motor pulley and flywheel		Clean
	2. Faulty adjustment of idler lever	Change lever(B) retaining screw	Adjust retaining screw
	3. Defective idler spring	Idler spring	Replace Lubricate
Slow Speed	4. Insufficient lubrication of idler wheel and flywheel.		Tighten screw Tighten screw
	5. Loose capstan holding screw		
	6. Loose motor pulley holding screw		
	7. Faulty adjustment of stop lever screw	Pinch roller, stop-lever and pinch roller lever	Adjust screw
	8. Fast Forward lever fails to return to the original position when the Selector Control is turned to "STOP" position	Stop-lever retaining screw, head retaining screws	Adjust
	I. Defective Motor		
	1. Defective Motor Shaft	Motor shaft	Overhaul
	II. Due to voltage and frequency of the power source		
1. Insufficient frequency or voltage	Frequency, voltage	Adjust	
III. Faulty Mechanical Transmission			
1. Slippage on friction couplings	Motor pulley, idler wheels and flywheel.	Clean	
IV. Excessive Pressure on pinch roller or idlers	Pinch roller spring and idler spring	Lengthen or adjust spring tension	

Symptom	Cause	Checking point	Remedy
Wow and Flutter or faulty tape motion in "FORWARD" mode.	I. Detective Motor		
	1. Insufficient torque		Overhaul or Replace
	II. Loose contact (slipping transmission)		Clean
	III. Contacts of Idler Wheels	parallel contacts to the motor pulley	Adjust
	IV. Eccentric motion of rotating parts		
	1. Defective motor shaft	Motor shaft	Replace
	2. Defective idler wheel	Idler wheel	Replace
	3. Defective flywheel shaft	Flywheel shaft	Replace
	V. Defective parts		
	1. Defective flywheel support	Flywheel support	Replace
	2. Defective rubber portion of idler wheel	Idler wheel	Replace
VI. Faulty Rotation of Flywheel			
1. Deformity	Idler wheel	Replace	
VII. Deformity or hardening of rotating rubber parts			
1. Deformity of idler wheel or pinch roller		Replace	
VIII. Defective flywheel bearing			
1. Defacing, cracking, or faulty lubrication	Flywheel bearing	Replace	
IX. Faulty lubrication of rotating parts	Flywheel, idler wheel, rewind roller, reel hub, friction roller and pinch roller	Lubricate	
X. Loose capstan holding screw			
1. Faulty tightening of screw	Holding screw	Re-tighten	
XI. Faulty Alignment of Capstan and pinch Roller Shafts			
1. Faulty adjustment	Pinch roller lever	Adjust	
Defective Brake	I. Loose Spring		
	1. Faulty adjustment	Brake spring	Replace or shorten
	II. Improper spring tension		
	1. Faulty adjustment	All springs	Adjust
III. Oily friction parts	Rubber parts and reel hub	Clean	
IV. Faulty adjustment of Brake and Reel hub clearance	Brake	Adjust rewind and forward brake levers	
Faulty Takeup	I. No rotation with reel		
	1. Worn-out felt	Bottom of reel hub	Replace felt
	2. Oily friction roller, motor pulley and idler wheel	All rotating parts	Clean
	3. Insufficient torque in takeup motion		Replace or shorten the spring.
II. Reel Hub fails to rotate			
1. Dusty friction surface	Reel hub rewind roller and idler wheel	Clean	
2. Insufficient lubrication of rotating parts		Lubricate	
III. Brake doesn't release at FORWARD mode		Adjust	
IV. Reel Hub fails to rotate without reel			
1. Defective transmission		Adjust	
Faulty Rewind	I. Reel Hub fails to rotate without reel.		
	1. Faulty coupling of rewind rollers	Rewind rollers (A) and (B)	Adjust rewind arm
	2. Worn-out rewind rollers	Rewind rollers (A) and (B)	Replace
3. Defective transmission		Replace or readjust spring tension	

Symptom	Cause	Checking point	Remedy
	II. Reel Hub fails to rotate with reel	Spring	Replace or shorten Spring
	1. Insufficient rewind spring tension		
	2. Worn-out rewind rollers		Replace
	III. Oily "friction" surfaces		Clean
	IV. Insufficient lubrication of rotating parts	Rewind hub, rewind roller A & B	Lubricate
1. Insufficient lubrication of reel-hub shaft bearings and rewind roller			
	V. Brake doesn't release		Adjust
Tape Speed too fast	I. Loose coupling between pinch roller and capstan	Pinch roller spring	Replace or shorten the spring
	1. Insufficient tension of pinch roller spring		
Faulty Fast Forward	I. Fast Forward Idler Wheel fails to contact the Motor Pulley	Fast Forward adjustment screw(s)	Adjust the screw
	1. Faulty adjustment		
	II. Insufficient lubrication of the rotating parts	Idler wheel and reel hub	Lubricate
	1. Insufficient lubrication of idler wheel and reel hub		
	III. Slippage of rotating parts	All rotating parts	Clean
	1. Dust and foreign matters		
	IV. Fast Forward Lever fails to return, when turned to "STOP" position	Adjustment of screw	Adjust
	1. Insufficient adjustment of stop lever holding screw		
	Retaining screw (s)	Re-tighten screw (s)	
	2. Loose screw(s) of pressure pad		
Weak Output	I. Record/play Head is not aligned properly.	Adjustment of screws	Re-adjust
	II. Improper adjustment of Pressure Pad-B	Retaining screw	Adjust
	1. Loose retaining screw		
	III. Pressure Pad doesn't contact the head properly	Felt-pad	Adjust or Replace
	IV. Defective Record/Play Head		Replace
V. Record/Play Head magnetized	Head	Replace or demagnetize	
Noise	I. Rumbling Noise	Check the rhythm of the noise resulting from the rotating parts —ditto—	Replace
	1. Deformed idler wheel		
	2. Faulty flywheel shaft		
	3. Faulty reel-hub shaft		Replace
	II. Mechanical Noises	rubber parts	Replace
	1. Friction noise of rewind rollers or idler wheels		
	2. Insufficient lubrication of rotating parts		Lubricate
	III. Vibrating Noise	Irregular angle of fin of motor fan Check all parts near the motor	Adjust
	1. Vibration of motor		
	2. Contact of other parts with the motor body		Adjust
	IV. Skewing tape noise	Surface of head	Clean
	1. Dirty surface of head		
	2. Electrostatically charged tape		
3. Over-heated head		Replace with new tape	
			Cool

Symptom	Cause	Checking point	Remedy
	4. Worn-out tape	Magnetic coating peeling off from the tape	Replace with new tape
	5. Defective tape	Tape	Replace with new tape
Remote Switch does not work	I. No Motor rotation when switch is "ON" 1. Defective remote switch	Remote switch	Repair or replace
	II. Motor fails to stop when remote switch is turned OFF from "FORWARD" position 1. Defective remote switch or remote switch receptacle	Remote switch and remote switch receptacle	Repair or replace
No sound from Speaker and Earphone (not even hum noise)	I. Tubes do not light 1. Defective power supply circuit	Check fuse, AC line cord, power source, plug, power on-off switch Soldering of selector pin	Repair
	2. Opened winding of power transformer.	Check continuity of primary winding of power transformer	Replace
	II. Tubes Light 1. Defective circuitry	1. Check continuity of secondary winding of power transformer 2. Check input and output voltages of selenium rectifier 3. Check filter circuit, R39, R40, C37-a, C37-b and C38	Replace Replace Replace
Hum, but no sound from Speaker or Earphone	I. Defective tubes or circuitry 1. Defective V1 or loose contact	1. Check voltage of all pins of V1	Replace
	II. Voltages of tubes and circuitry are normal 1. First stage input circuit 2. Record/play head (defective head or circuitry)	1. Check C2, C3, C4, C5, R3 and R6. 1. Check continuity of the head (Demagnetize the head after the above test)	Replace Replace
Earphone works but Speaker does not	I. Defective tubes or loose contacts 1. Defective or loose contacts of V2 and V3	1. Check voltage of all pins of V2 and V4 2. Check R6, R7, R10, R12, R16, C6, C7, C12, C15 and C19 3. Check continuity of primary and secondary windings of output transformer	Replace Replace Replace
	II. Voltages of tubes and circuitry are normal	1. Check extension speaker jack 2. Possible short circuit of S6 3. Defective speaker or loose contact of speaker plug	Adjust Adjust Replace or adjust
Weak Output	I. Weak speaker and earphone outputs A. Tubes light 1. Defective capacitors 2. Defective power supply a. Defective selenium rectifier b. Short circuit or high-voltage windings of power transformer	Check C4, C5, C6, C7, C9 and C12 Check B+ voltage Check input voltage to selenium rectifier	Replace Replace Replace
	B. Tubes do not light 1. Defective V1 socket 2. Defective V1	Check V1 socket Check voltages of V1	Replace Replace

Symptom	Cause	Checking point	Remedy	
	C. Defective record/play head			
	1. Short circuit of head coils		Replace	
	2. Short circuit of lead wires connected to the head		Replace	
	3. Dirty record/play head (Weak high-freq. output)	Check surface of the head	Clean head with carbon tetrachloride	
	II. Weak-output from speaker but normal output from earphone			
	A. Tubes light			
	Defective capacitor	Check C19	Replace	
	B. Tubes do not light			
	1. Defective sockets of V2 and V3	Check sockets of V2 and V3	Replace	
	2. Defective V2 and V3	Check voltages of V2 and V3	Replace	
	C. Defective output circuit			
	1. Short circuit of primary winding of output transformer	Check resistance of primary winding	Replace	
	III. Weak or no output from earphone, but normal output from Speaker			
	A. Defective resistor	Check R13	Replace	
	B. Defective earphone socket	Check contact of earphone socket	Replace	
Excessive Hum	I. Hum mixed with reproducing sound			
	Hum noise recorded on tape	Check with other tape	Replace tape	
	II. Excessive hum when the unit is turned to FORWARD without tape			
	A. When the various positions of the volume control will not affect hum level			
	1. Defective filter circuit	Check R39, C37-a, C37-b, C38	Replace	
	2. Improper insulation between heater and cathode of V2	Check V2 and V2 socket	Replace	
	3. Defective Grid Leak Resistor		Replace	
	B. When the various positions of the volume Control will affect hum level			
	1. Induction hum from record/play head	Check whether other electrical units are placed near the recorder	Remove from vicinity	
	2. Poor grounding of wires from R/P head to grid of V1	Check continuity between grounding points, after removing R/P head and grounding of V1	Replace	
	3. Defective V1 and V1 socket		Replace	
	4. Defective C-3, C-26, C-37a, C37-B, C38 capacitors		Replace	
	Non-periodical Noises	I. When the various positions of Volume Control will not affect noise level		
		A. Loose contact or defective V2 and V3	V2 and V3	Replace
		B. Defective R-7, R-12	R-7, R12	Replace
C. Defective primary winding of output transformer		Output transformer	Replace	
II. When the various positions of Volume Control will affect noise level				
A. The head is magnetized			Demagnetize	
B. Short circuit of V1			Replace	
C. Defective R4			Replace	
D. Faulty contact of volume control brush		VRT	Replace	

Symptom	Cause	Checking point	Remedy
Periodical Noises	I. Presence of noise when tape is played back	Compare the noise with other tape	Adjust
	1. Distortion of erase current wave during recording		
Poor Bass Response	2. Defective tape	Defective R14 and C15 VR2, C13, C14	Replace
	3. Magnetized record/play head		Demagnetize
Poor Bass Response	II. Presence of noise when the unit is turned to "FORWARD" without tape	Defective R14 and C15 VR2, C13, C14	Replace
	1. Defective V1		Replace
Poor Bass Response	2. Defective R4, R5 or R6	Check playback equalization circuit	Replace
	3. No negative-feedback		Adjust
Poor Bass Response	4. Defective VR2, C14	Defective R20	Replace
	I. When pre-recorded tape is played back with Model 107S (Poor playback response)		1. Defective C5, C7, C9, C8, C12, C19
Poor Bass Response	II. When the Recording and Playback is made with Model 107S	1. Defective C5, C7, C9, C8, C12, C19	Replace
	1. Poor recording response		Replace
Poor Bass Response	2. Poor playback response	2. Short circuit of C13 and C15	Replace
		3. Defective R14	Replace
Poor Treble Response	I. When the pre-recorded tape is played back with Model 107S	1. Dusty record/play head	Clean
	1. Poor playback response		Re-adjust
Poor Treble Response	II. When the Recording and playback are made with Model 107S	2. Faulty azimuth adjustment of record/play head	Re-adjust
		3. Defective C2, C14	Replace
Poor Treble Response	1. Poor Playback response	4. Worn-out record/play head	Replace
		5. Worn-out tape	Replace
Poor Treble Response	2. Poor Recording response	6. Defective or worn-out pressure pad	Adjust or replace
		Same as above 1 thru 6	Replace
Distortion in Playback	I. When good pre-recorded tape is played back	Defective C8, C10, C11 and C20	Replace
		1. If distortion is found	
Distortion in Playback	a. Loose contact or defective V1, V2 or V4	Check voltages of V1, V2 or V4	Adjust or replace
	b. Insufficient B- voltage	Check voltages of C26, C37 a, C37 b, C38, R21, R39 and R40	Replace
Distortion in Playback	c. Faulty adjustment or defective VR4		Replace
	d. Irregular bias voltages of V1, V2 and V3	Check R3, R6, R10, R16, R41, R9	Replace
Distortion in Playback	2. If not distorted		
	The playback amplifier of Model 107S is normal therefore, check the recording circuit as per the following:		
Distortion in Playback	a. Magic-eye doesn't work (but monitoring possible)	1. Check S1 switch	Replace
	* No B- voltage fed to magic-eye and oscillator coil simultaneously	2. Check action of S1 switch	Adjust
Distortion in Playback	b. Magic-eye works but no oscillation and no signal to record/play head but monitoring possible	3. Check screws of recording switch arm	Re-tighten

Symptom	Cause	Checking point	Remedy
	* Defective oscillator coil and V3, or short circuit of shielded-wire to record/play head	1. Check continuity of oscillator coil	Replace
		2. Check C11, C17, R17 and R18	Replace
		3. Check voltages of V3	Replace
		4. Check continuity of shielded wire connected to head	Replace
		5. Check R19	Replace
	c. Monitoring is possible and magic-eye works		
	* Defective R19	Check R19	Replace
	* Grounded terminals of R19 and R20	Check R19 and R20	Insulate
	* Record/play head shielded wire shorted to R20	Check continuity of shielded wire connected to the record/play head	Replace
	d. Monitor and magic-eye do not work		
* Defective input jack	Check input jack	Replace	
* Defective R1 or R2	Check R1 and R2	Replace	
e. Monitoring possible, but defective magic-eye or circuit			
* Loose contact or defective V6	Check voltages of V6	Replace	
* Defective R35, R36, R37, R38, C35, C36, C21, VR4		Replace	
Slightly Distorted Speaker Sounds	I. Monitoring by earphone normal		
	1. Defective high frequency bias oscillation		
	a. Defective V3	Check voltages of V3	Replace
	b. Defective oscillator coil	Check continuity of oscillator coil	Replace or adjust
	c. Defective C16, C17, R17 and R18.	Check C16, C17, R17 and R18	Re-adjust
	d. Faulty adjustment of padding capacitor	Re-adjust to obtain 45V at head terminals	Replace
	2. Defective circuitry of record/play head (grounded R20, C20)	Check bias voltage at head terminals	Insulate
	II. Monitoring by earphone distorted		
	1. Defective microphone	Check recording with other microphones	Replace
	2. Defective MIC. jack or AUX. jack	Check jacks	Adjust or replace
3. Defective V1	Check voltages of V1	Replace	
Poor Recording Sensitivity	I. Poor Sensitivity due to the worn-out tape	Check recording with other tapes	Replace
	II. Low recording level, due to poor adjustment of VR4 or faulty reading of Magic-eye	Try recording at a higher volume level	Adjust
	III. Faulty Record/Play Head		
	1. Dirty heads	Clean surface of heads	Clean
	2. Defective Record/Play Head		Replace
	IV. Defective Circuit:		
	1. Defective V1, V2 and V3	Check voltages of V1, V2 and V3	Replace
2. Low B ⁺ voltage	Check the voltage	Adjust	
V. Defective microphone	Compare with others	Replace	
Hissing Noise	I. Defective Tape	Compare with new tape	Replace
	II. Due to faulty adjustment of erase or record bias (Distorted oscillation wave)	Check erase current wave with oscilloscope, also check R17 and R18	Adjust
	III. Magnetized Record/Play Head		Demagnetize

Symptom	Cause	Checking point	Remedy
Spotting Noise	I. Defective or worn-out tape II. Magnetized Record/Play Head	Check bias current wave with oscilloscope	Replace Demagnetize
Poor Tonal Quality	I. Poor recording of high frequency sounds 1. Defective microphone 2. Faulty equalization of high frequency sounds 3. Faulty adjustment of VR4 4. Defective S5 5. Excessive bias voltage 6. Defective record/play head 7. Dirty record/play head surface II. No Recording of low frequency sound 1. Defective microphone 2. Faulty equalization of low frequency sounds	Check with others Defective C2, C8, C10, C11 and C20 Check S5 connection with C11 and C10 Adjust bias voltage of head at 40~70V AC Check with others 1. Short circuited C13 2. Defective R20	Replace Replace Adjust Adjust Adjust Replace Clean Replace Replace Replace
Sound Distorted	I. Recording from Microphone 1. Defective microphone 2. Faulty adjustment of VR3 3. Excessive recording level II. Insufficient Bias Voltage: 1. Oscillation circuit defective 2. Faulty adjustment of padding capacitor	1. V6 magic-eye defective 2. Defective VR4 1. Defective V3 2. Oscillator coil defective 3. R17 and R18 defective	Replace Adjust Replace Adjust Replace Replace Replace Adjust or replace
Faulty Erase	I. Erasing of old recordings II. Erasing of recording made with excessive bias III. Erasing of recording made under excessive recording level condition IV. Erasing Head Defective V. Poor alignment of erasing head VI. Faulty alignment of Record/Play Head and Erasing Head 1. Holding screws of erase head defective 2. Faulty adjustment of stack height of recording head VII. Insufficient erasing current 1. Power supply voltage too low 2. B+ voltage too low 3. Poor oscillation 4. Oscillation frequency too high VIII. Dirty Erasing Head	Repeat erasing Repeat erasing Repeat erasing Check alignment Check stack height Check selenium rectifier input and output voltages V3, defective Check frequency	Replace Replace Replace Replace Adjust Adjust Replace Re-adjust Clean
Hum Noise being recorded	I. Recording from Microphone 1. Defective microphone 2. Position of microphone too close to the Recorder 3. When recording from humming speaker	Try recording with microphone away from recorder	Replace Correct

MALFUNCTIONS IN STEREO PREAMPLIFIER STAGE OF CONCORD 107-S

Prior to trouble shooting, Connect the 107 S preamplifier stage to an external amplifier having connection to speaker(s).

Symptom	Cause	Checking Point	Remedy
*No sound, tubes do not light.	1. Defective tube 2. Faulty contact of tube pin	V4 and/or V5 Tube sockets of V4 and V5.	Replace Replace
*No sound, tubes light.	1. Defective tube. 2. Defective resistor or capacitor.	Make voltage checks on V4 and V5 R23, R24, R25, R29, R30, C24.	Replace Replace
*No sound tubes light and all voltages checked OK.	1. Defective 1st stage input circuit 2. Defective resistor 3. Defective wiring to switch S3.	C22, R22, 107S/A input jack contact, R31. UNSOLDER LEADS TO R/P HEAD and make continuity check of the wiring.	Replace Replace
*Low output	1. Defective tube or tube pin contact. 2. Defective capacitor	V4, V5 and the sockets. C21, C23, C24, C25 C30, C29, C33, C34.	Replace Replace
*Hum, varies by volume control positions.	1. Poor H-K insulation of tube V5 2. Defective capacitor or resistor.	Check V5 and the socket for leakage C30, R26, R27.	Replace Replace
*Hum, does not vary by volume control positions.	1. Leads from R/P head grounded at more than one point. 2. Defective capacitor 3. Poor H-K insulation of tube V4	Disconnect wiring from R/P head and grounding point at tube V4 socket before making checks. C23 Check V4 and the socket for leakage	Repair or Replace Replace
*Irregular noise, varies by volume control positions.	1. Defective tube pin contact. 2. Defective resistor 3. Defective volume 4. Defective capacitor	V4 and the socket. R24 VR2 C25	Replace Replace Replace Replace
*Irregular noise, does not vary by volume control positions.	1. Defective tube pin contact. 2. Defective resistor	V5 and the socket R30	Replace Replace
*Poor bass response	Defective Capacitor or resistor.	C23, C24, C25, C30 C31, C34, C29, C33, C34, R26, R27	Replace
*Poor treble response	Defective capacitor	C22	Replace
*Distorted sound.	Defective tube or tube pin contact.	V4, V5 and the sockets. Make voltage checks at tube pin.	Replace

MALFUNCTIONS IN "SOUND ON SOUND" RECORDING

*No recording	Defective switch	Contacts of S4	Replace
*Distorted recording	Defective Capacitor or resistor.	C27 C28 C29 R26 R27 R28	Replace
*Hummy new recording	1. Misaligned capacitor 2. Defective capacitor	C42 C22	Realign Replace
*No sound, tubes do not light.	Defective primary circuit of power supply section.	Cord, plug, ON-OFF switch, transformer winding	Replace
*No sound, tubes light.	1. Defective Secondary circuit of power supply section. 2. Defective capacitor or resistor	a. Secondary windings of power transformer. b. Make checks of Input & output voltages of 6×4 C21 C22 R24 R25	Replace Replace
*Hummy sound output	1. Defective tube or tube socket. 2. Defective input circuit component.	Make voltage checks on V1 & V2 C3, C4, R4, R5, J3, S1, connecting cable.	Replace Replace
*Speaker does not operate, earphone operates	1. Defective tube or tube socket. 2. Defective circuit component	V3 and the socket R14, R15, C12 Output transformer	Replace Replace

Symptom	Cause	Checking point	Remedy
	3. Defective EXT. SP jack contact	J4 contact	Repair
	4. Defective speaker or the speaker circuit component	Speaker, Connector plug	Repair
*Low output for both Speaker and Earphone	1. Defective tube or tube pin contact	V1 and its pin voltages	Repair
	2. Defective power supply	Make voltage checks on 6×4 and B+ supply circuit.	Repair
	3. Defective capacitor	C4, C6, C11	Repair
*Low output of speaker, output of earphone normal	1. Defective tube pin contact	Tube socket of V3	Replace
	2. Defective tube	V3	Replace
	3. Defective output transformer	Make impedance check on output transformer primary winding	Replace
*Low output of earphone, Speaker output normal	1. Defective resistor	R13	Replace
	2. Defective contact in earphone jack	earphone jack	Repair or Replace
*Excessive hum when tape runs	Hum noise recorded on the tape.	Compare with other recorded tape.	
*Excessive hum without tape running, varies by the positions of volume control.	1. External AC magnetic field being picked up by R/P head.	Check whether electrical units are placed near the R/P head.	Remove them
	2. Defective tube or tube socket	V1 & its socket	Replace
	3. Defective capacitor	C2, C19	Replace
*Excessive hum without tape running, does not vary by volume control positions	1. Defective filter circuit component	R23, R24, R25, C20, C21, C22	Replace
	2. Poor H-K insulation of tube	Make insulation check of V2.	Replace
*Irregular noise, varies by volume control positions.	1. Magnetized R/P head	Use head demagnetizer	Demagnetize
	2. Defective tube pin contact	V1 and its socket	Replace
	3. Defective resistor	R4, R5,	Replace
	4. Noisy volume control	VR1	Replace
	5. Noise recorded on the tape	Compare with other recorded tape.	
*Irregular noise, does not vary by volume control positions	1. Defective tube pin contact	V2, V3, and sockets	Replace
	2. Defective resistor	R7, R12	Replace
	3. Defective output transformer	Output transformer	Replace
*Continuous noise when tape runs	1. Distorted waveform of erase current when recording.	Make checks with oscilloscope for distortion and asymmetry in waveform.	Repair or Replace
	2. Defective tape	Compare with new tape.	
	3. Magnetized R/P head		Demagnetize
Continuous noise without tape running	1. Defective tube	V1	Replace
	2. Defective resistor	R4, R5	Replace
	3. Defective component in negative feed back circuit.	R16, C14	Replace
*Poor bass response	1. Defective recording characteristics of the recorder	Compare with tape recordings made with other recorders.	
	2. Defective component in recording amplifier circuit	R18, C9, C10 peaking coil	Replace
	3. Defective component in play back amplifier circuit	C4, C6, C11, C14, R56 & tone control.	Replace
*Poor treble response, when reproducing recording made by other machine.	1. Defective pre-emphasis circuit of the recorder.	Compare with tape recordings made with other recorders.	
	2. Defective head azimuth alignment	Realign with the use of alignment tape.	Realign
*Poor treble response when reproducing the previous recording	1. Defective component in recording circuit.	C9, C10, C15	Replace
	2. Defective component in play back circuit.	C7, C8, C14	Replace
	3. Dirty R/P head surface		Clean
	4. Worn R/P head		Replace
	5. Defective recording tape	Compare with new tape	Replace
*Distorted sound when reproducing a good tape.	1. Defective component in play back circuit	R3, R6, R10, R15	Replace
	2. Defective tube	V1, V2, V3	Replace
	3. Defective component in power supply circuit	Make voltage checks on B+ power supply.	Replace
	4. Over boosted low range by tone control.		Adjust

Symptom	Cause	Checking Point	Remedy
*Speaker sound slightly distorted, earphone sound normal	Improper bias voltage.	Adjust bias voltage at head terminals to 37V RMS.	Readjust
*Slightly distorted sound	1. Defective microphone 2. Defective jacks for mic. input and AUX input. 3. Defective tube	Compare with other microphone. Jack contacts V1	Repair Repair or Replace Replace
*Recording level too low	1. Defective recording tape 2. Recording level too low due to faulty level indicator 3. Dirty R/P head surface 4. Defective R/P head 5. Defective tube 6. Defective power supply voltage 7. Defective microphone	Compare with other tape Level indicator and the circuit. V1, V2, V3. Make voltage checks on B+ Power supply circuit. Compare with one of known good	Replace Replace Replace Clean Replace Replace Replace Replace Replace
*Continuous hissing noise	1. Defective tape 2. Distorted erase-bias current waveform. 3. Magnetized R/P head	Compare with others Make checks with oscilloscope for distortion and assymetry in the wave-form.	Replace Replace Replace Demagnetize
*Poor recording over high range response	1. Defective microphone 2. Defective component in high range emphasis circuit 3. Mis-adjusted tone control 4. Defective equalizer switch contacts 5. Bias voltage too high 6. Defective R/P head 7. Dirty head surface	Compare with one of known good C9, C10, C15 VR3 S2 contacts	Replace Replace Adjust Replace Readjust Readjust Clean
*Poor recording over low range response	1. Defective microphone 2. Defective component in the low range emphasis circuit 3. Bias voltage too low	Compare with one of known good C8, C14 C16, tone control	Replace Replace Readjust
*Distorted recording when made from microphone	1. Defective microphone 2. Misadjusted tone control 3. Recording level too high	Compare with one of known good VR3 Magic-eye tube and the circuit.	Replace Adjust Adjust
*Distorted recording when made from AUX input.	1. Distorted input source. 2. Over equalized input source.		Adjust Adjust
*Distorted recording, due to insufficient bias voltage	1. Defective component in oscillator circuit. 2. Mis-adjusted capacitor	V3, Oscillator coil	Replace Readjust
*Faulty erasure	1. Erasing of old recording 2. Erasing of recording made with excessive bias voltage 3. Erasing of recording made at excessively high level. 4. Defective erase head 5. Inadequate mounting of erase head 6. Insufficient erase current 7. Dirty surface of erase head	Check height aligning of all heads. Make voltage checks on 6X4 and V3, frequency check on oscillator circuit.	Repeat erasing Repeat erasing Repeat erasing Replace Readjust Replace Clean
*Hummy recording when made from microphone	1. Defective microphone 2. Accoustical noise or magnetic leakage flux of the set being picked up by the microphone 3. Sound source level too low.	Keep microphone away from the recorder as much as possible.	Replace
*Hummy recording when made from AUX. input	1. Hum exists in the input source. 2. Level of the input source too low. 3. Impedance of the input source too high.		

107S and 107S/A REPLACEMENT PARTS:

1	A-48103	Pinch Roller	75	A-70144	Pinch Roller Spring-A
2	A-48124	Capstan for 60 cycle	76	A-70057	Fast Forward Lever Spring
3	A-67656	Pinch Roller Lever	77	A-65346	Idler Arm
4	A-65318	Fast Forward Lever-B	78	A-65327	Rewind Arm
5	A-70125	Spring-A	79	A-85534	Leather Brake
6	A-65327	Fast Forward Lever-A	80	A-83068	Rubber Brake
7	A-67677	Lever Shaft	81	A-48100	Takeup Drum
8	A-65326-A	Fast Forward Adjusting Cam	82	A-85473	Felt for Takeup Drum
9	A-65344	Fast Forward Arm-A	83	A-65329	Friction Plate for Takeup Drum
10	A-42203	Switch	84	A-85492	Felt Washer
11	A-65328	Fast Forward Arm-B	85	R-43002	Pilot Lamp Bushing
12	A-65322	Takeup Arm	86	R-65180	Lamp Cover
13	A-48104	Idler Wheel	87	A-85472	Flywheel Bearing
14	A-65317	Takeup Lever	88	A-65368	Metal Hook-B for Spring
15	A-70126-C	Takeup Brake Spring-M	89	A-67664	Fast Forward Lever Shaft
16	A-67653	Lever-B Shaft	90	A-67659	Spacer for Slide
17	A-65445	Brake Lever with Leaf Spring	91	A-67666	Rewind Reel Hub Shaft
18	A-67658	Takeup Reel Shaft	92	A-67663	Reel Hub Spacer
19	A-48099	Reel Hub	93	A-70130	Speed Selector Spring
20	A-67660	Retaining Stud for top panel	94		
21	A-70077-A	Switch Lever Spring	95	A-67681	Rewind Arm Spacer
22	A-65369-C	Metal Hook C-M for Spring	96	A-67661	Reel Hub Retaining Screw
23	A-48114	Motor	97	A-67662	Capstan Holding Screw
24	A-65454-B	Slide Supporter-L	98	A-67334	Spacer-B
25	A-67671	Speed Selector Shaft	99	A-67517	Shock Absorbing Rubber Cushion
26	A-65323	Speed Selector Guide	100	A-67522	Spacer
27	A-67682	Stopper Screw	101	A-63315	Magic-eye Holder
28	A-48098	Rewind Idler	102	A-65427-B	Rewind Arm Guide-L
29	A-65350	Rewind Brake Lever			
30	A-65354	Selector Slide	151	A-65482	Head Shielding Plate
31	A-70127-C	Rewind Brake Spring-M	152		
32	A-65353	Selector Lever-B	153	A-67718	Tape Guide Spacer-A
33	A-65353	Idler Lever	154	A-46036	Record/Playback Head
34	A-65330	Selector Lever-A	155	A-46037	Erase Head
36	A-70122	Pinch Roller Spring	156	A-70150	Head Adjusting Spring
37	A-78755-B	Selector Cam-L	157	A-65470	Head Shielding Plate-C
39	A-85476	Felt for Panel Mounting	158		
40	A-65367	Metal Hook-A for Spring			
41	A-65347	Stop Lever	181	A-65406	Oil Case
42	A-67680	Tape Guide-C	188	G-43013	Lug Board, 2PGA
43	A-64950	Tape Guide	189		MP Capacitor, MLM 0.22 μ F
46	A-64953	Pressure Pad-B			
47	A-70071-B	Pad Spring A-K	205	A-65429	Spring Adjusting Screw
48	A-64952-A	Pressure PadA-K	206	A-65523	Head Mounting Plate-S
49	R-41001	Pilot Lamp	207	A-65522	Baseplate
50			208	A-65587	Interlocking Arm-S
51			209	A-70149	Fast Forward Spring
52	A-42528	Micro Switch	210	A-65525	Record Switch Arm-S
53			211	A-67724	Selector Shaft-S
54	A-48097	Flywheel			
55			TC-6	T-43043	Lug Board, 3P
56			TC-8	T-43045	Lug Board, 6P
57	A-85489	Felt Pad-A for Erase Head	TC-10	R-43304	Fuse Holder
58	A-65352	Panel Retainer	TC-11	G-43504	2P Flat-type Socket
59	A-65328	Selector Shaft Holder	TC-12	T-43104	Insulated Pin-plug
60	A-70129-A	Fast Forward Lever Spring B-K	TC-14	T-63024	Wire Guide
61			TC-19	A-70132	Bulb Clamper-D
62	A-65319-A	Rewind Lever-K	TC-22	A-65432	Shielding Case
63	A-67674	Pinch Roller Shaft	TC-26	G-43902	Earphone Socket
64	A-64965	Head Shielding Plate-B	TC-27	A-81137	Jack Sheet
65	A-67451	Pressure Pad Retainer Shaft	TC-28	A-43424	Microphone Jack
66	A-85153	Felt Pad for R/P Head	TC-29	R-43143	Jack
67			TC-31	A-65362	Socket Cushion
68	A-67676	Pressure Pad Arm Shaft-C	TC-32	R-65112	Shielding Case Socket
69			TC-33	R-44001	Cord
70			TC-35	R-43401	AC Plug
71	A-67657-A	Flywheel Bearing-K	TC-36	T-43026	9P Socket
72	A-65325	Oil Cap	TC-37	A-65433	Shielding Case Base
73	A-67675-A	Pinch Roller Lever Shaft-K	TC-38	R-43111	Socket, M-501
74	A-67464	Spacer-C	TC-39	A-65565	Volume Control Holder

TB37	A-84139	Cabinet
TB38	A-65355	Hinge-B
TB39	A-65341	Hinge-B
TB40	A-65355	Hinge-A
TB41	A-65340	Hinge-A
TB42	A-85477	Speaker Grill Cloth
TB43	A-85494	Speaker Grill Cloth Holder
TB44	A-65570	Switch Board Frame
TB45	A-43111	Molded AC Socket
TB46	A-81202	Front Panel
TB47	A-87087	Knob-A
TB48	A-87088	Knob-B

ACCESSORIES :

ACC1		Remote Control Switch Assembly
ACC2		Patch Cord Assembly
ACC3	A-81111	7" Empty Reel
ACC4		Dynamic Microphone
ACC5	A-45220	Crystal Earphone
ACC6	A-81084	Splicing Tape
ACC7		Output Cord Assembly
110	A-85181	Oil Fabric Washer, 6×10×0.3
111	A-85460	Felt Washer, 5×10×2
112	A-85182	◇ ◇ 5×12×1
113	A-85490	◇ ◇ 7×12×2
113-1		Fiber Washer, 3×7×0.8
113-2		◇ ◇ 3×8×0.8
114		◇ ◇ 5×10×0.8
115		◇ ◇ 6×12×0.8
116		◇ ◇ 8.2×15×0.8
117		Phenolic Washer, 3.5×8×0.2
118		◇ ◇ 5×10×0.3
119		◇ ◇ 6×10×0.3
120		Small Screw, SC-2608
120-1		◇ ◇ SC-4040
120-2		◇ ◇ SC+3005
120-3		◇ ◇ SC+3006
121		◇ ◇ SC+3010
122		◇ ◇ SC+3012
122-1		◇ ◇ SC+3014
122-2		◇ ◇ SC+3015
122-3		◇ ◇ SC+4008
123		◇ ◇ SC+5008
124		◇ ◇ SS+3008
125		◇ ◇ BC-2004
125-1		◇ ◇ BC-2606
125-2		◇ ◇ BC+3016
125-3		◇ ◇ BC+4010
125-4		◇ ◇ BB+2006
125-5		◇ ◇ BB+2630
127		◇ ◇ BB+3010
127-1		◇ ◇ BB+3012
127-2		◇ ◇ BB+4012
127-3		◇ ◇ BS+2606
127-4		◇ ◇ BS+2608
127-5		◇ ◇ BS+3012
127-6		◇ ◇ BN+2606
127-7		◇ ◇ BN+2612
127-8		◇ ◇ BN+3014
127-9		◇ ◇ SB+3010
127-10		◇ ◇ BR+4015
128		Hexagonal Nut, NMB 261
129		◇ ◇ ◇ 301
130		◇ ◇ ◇ 401
130-1		◇ ◇ ◇ 403
130-2		◇ ◇ ◇ 1/8 Brass
131		Hexagonal Bolt, MSO 406
132		◇ ◇ ◇ 408
133		Spring Washer, VB 201
133-1		◇ ◇ ◇ 261
134		◇ ◇ ◇ 301
135		Lock Washer, A2.6S
136		◇ ◇ A3S

137		Lock Washer, A4S
138		◇ ◇ A5S
140		Washer, 3×12×1
140-1		◇ ◇ 4×22×1
140-2		◇ ◇ ZB 301
140-3		◇ ◇ 304
140-4		◇ ◇ 401
140-5		◇ ◇ 404
142		◇ ◇ 503
143		E-type Retaining Washer, E2.3
144		◇ ◇ ◇ E4
145		Lock Screw, 3×12
146		Tapping Screw, 3P×8
147		Grounding Lug, 3φ
148		Large Head Nail, 1φ×6
148-1		Wood Screw, KBC-1807
148-2		◇ ◇ KBC-2707
149		Tubular Rivet, N.02
149-1		◇ ◇ N.04
149-2	A-92604	◇ ◇ for pocket Lid
149-3	A-92607	◇ ◇ ◇ ◇ ◇ -B

MODEL 107-S/A

TB-1		Handle Assembly
TB-2	A-81191	Front Panel
TB-3	A-81132	Speaker Panel
TB-4	R-81179	Pilot Lamp Jewel
TB-5	A-87071	Selector Knob
TB-6	A-87072	Speed Selector Knob
TB-7	A-87073	Knob
TB-8	A-81147	Microphone Holder
TB-9	A-81148	Cord Holder
TB-10	A-84136	Cabinet
TB-11	A-65333	Ventilation Metal-A
TB-12	A-65356	Hinge-B
TB-13	A-65341	Hinge-B
TB-14	A-84138	Cabinet Lid
TB-15	A-65355	Hinge-A
TB-16	A-65340	Hinge-A
TB-17	A-65414	Lock Hinge-A
TB-18	A-67678	Lock Hinge-B
TB-19	A-81037	Vinyl Foot
TB-20	A-83069	Rubber Foot
TB-21	A-85477	Speaker Grill Cloth
TB-22	A-85494	Speaker Grill Cloth Holder
TB-23	A-85285	Net
TB-24	A-65332-A	Baffle Board-K
TB-25	A-65338	Corner Reinforcement-B
TB-26	A-64908	Washer for Vinyl Foot
TB-27	R-62604	Magic-eye Holder
TB-28	T-63024	Wire Guide
TB-29	A-65564	Jack Frame
TB-30	T-43011	Plug, Speaker
TB-31	A-45221	Speaker
TB-32	A-85703	Decal
TB-33	A-65455	Head Cover Decal
TB-34	A-85705	Tube Location Diagram
TB-35	A-65672	Volume Control Bracket

ACCESSORIES :

ACC1		Patch Cord Assembly
ACC2		Connector Cord Assembly
ACC3		Dynamic Microphone
ACC4	A-81106	Earphone Bag
ACC5	A-45220	Crystal Earphone
TC-1	A-61030	Amplifier Chassis
TC-2	A-63355	Amplifier Chassis Holder
TC-3	A-63360	MT Socket Holder
TC-4	A-65571	MT Shielding Case
TC-5	A-65419	Shielding Cap
TC-6	A-65562	Jack Panel

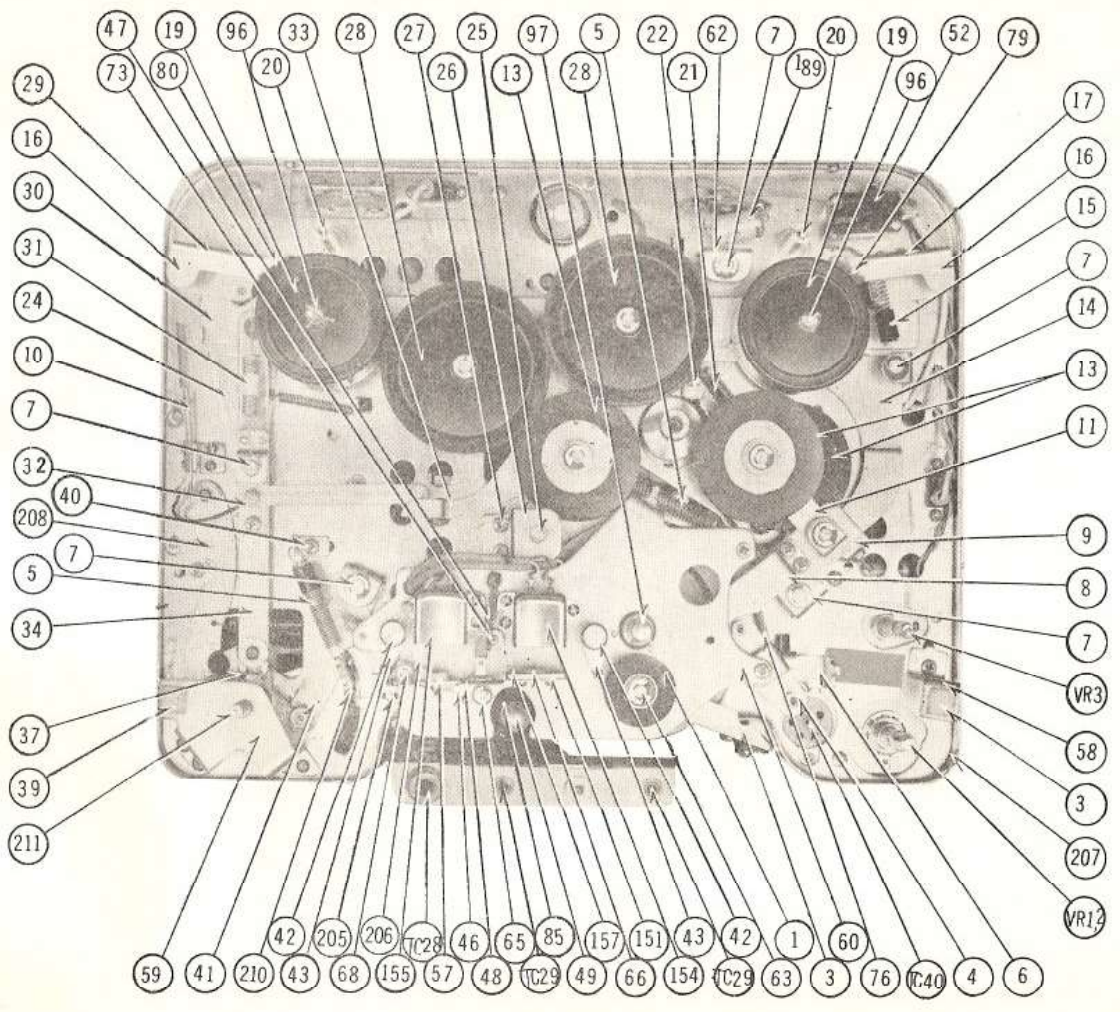

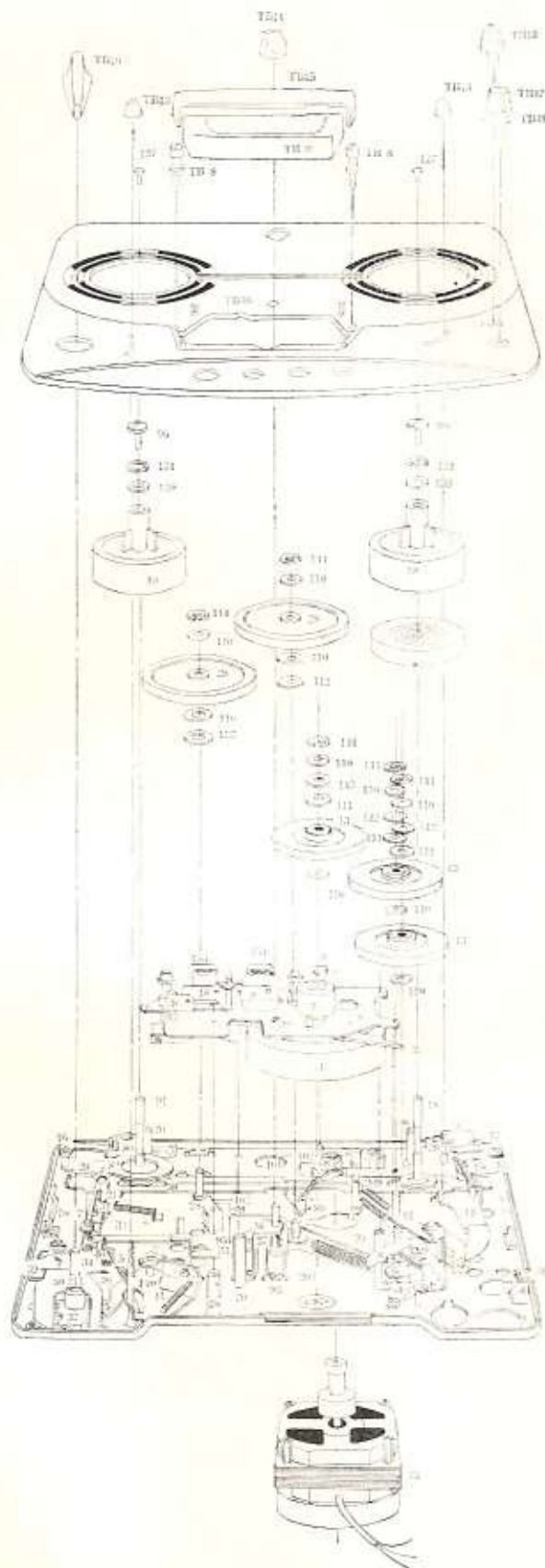

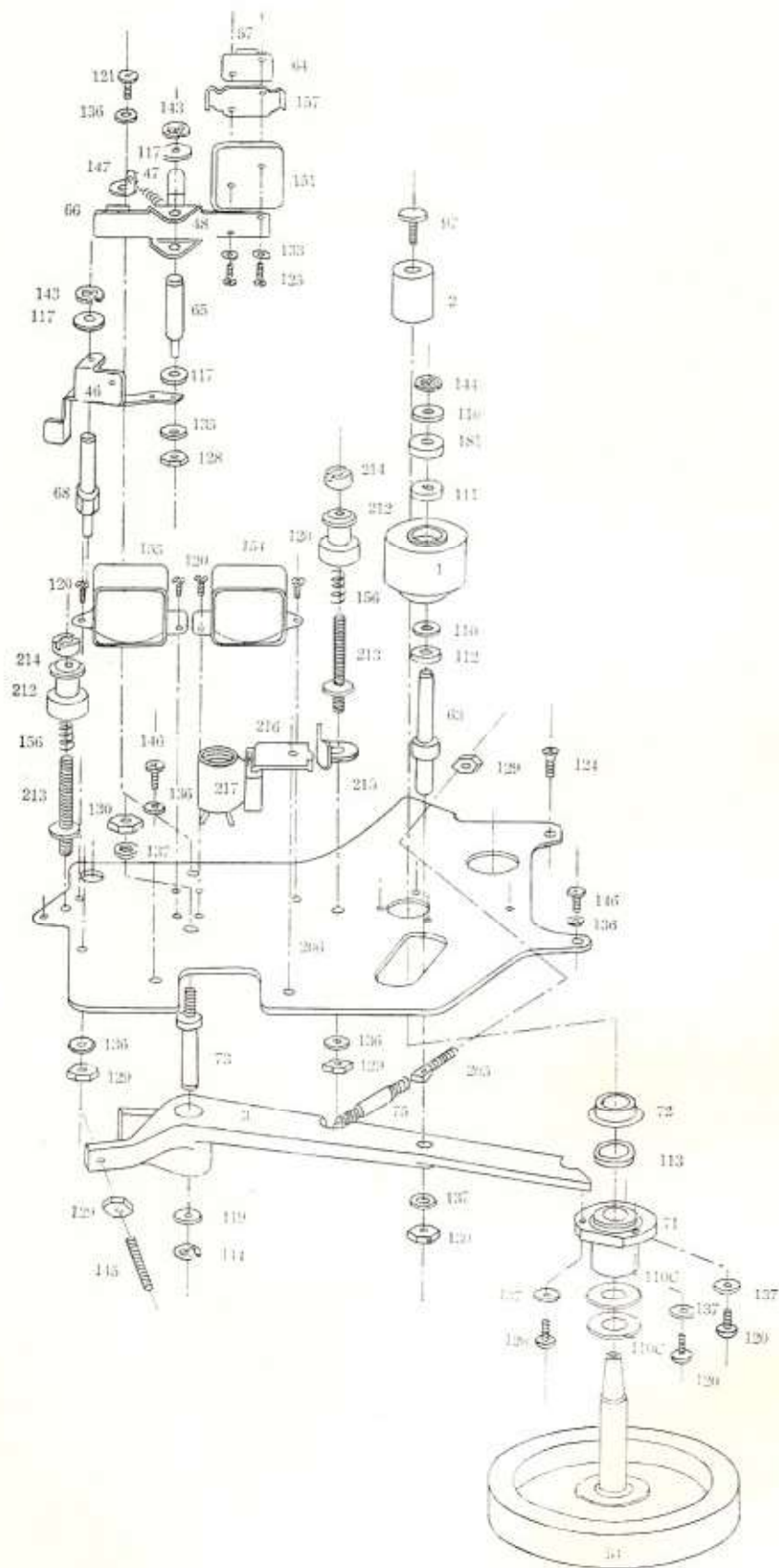

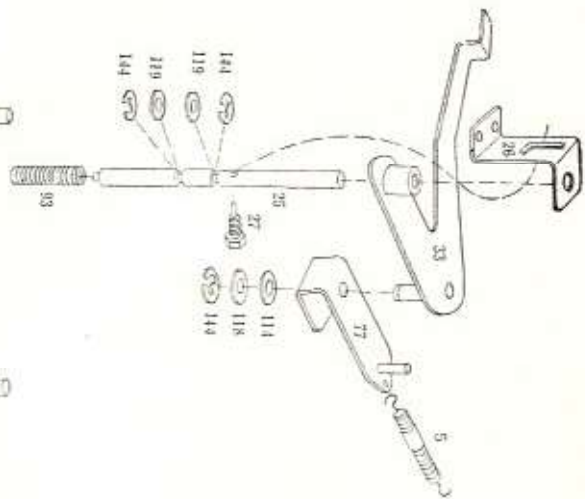
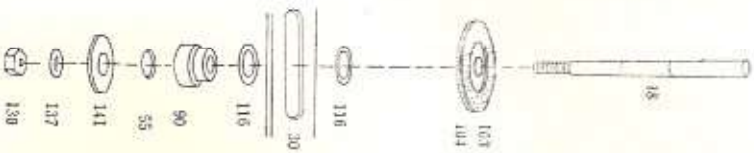
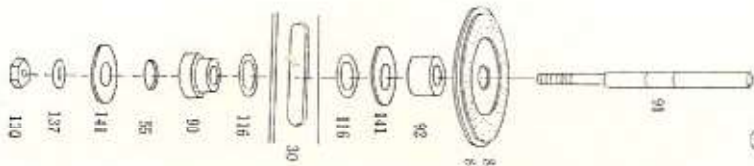
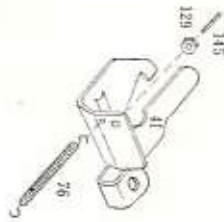
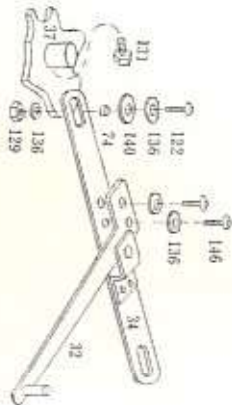
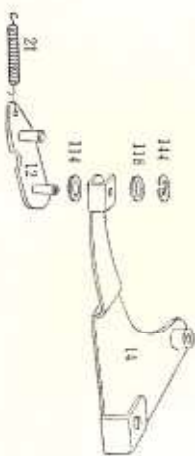
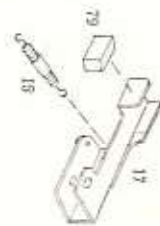
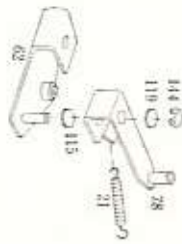
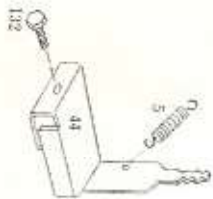
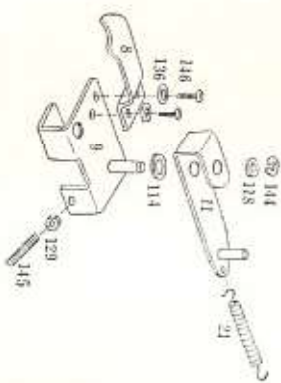

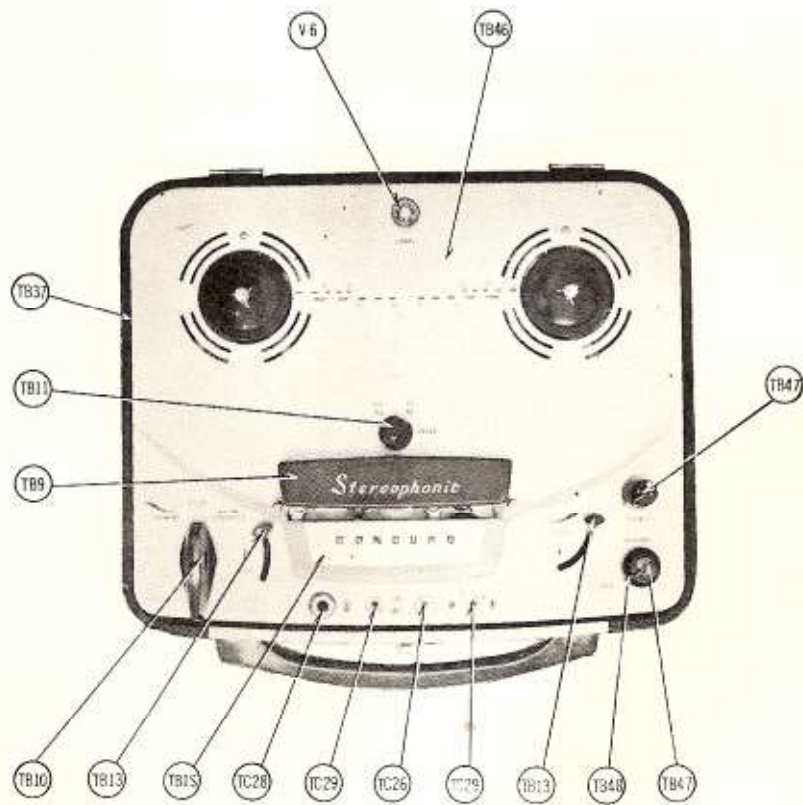
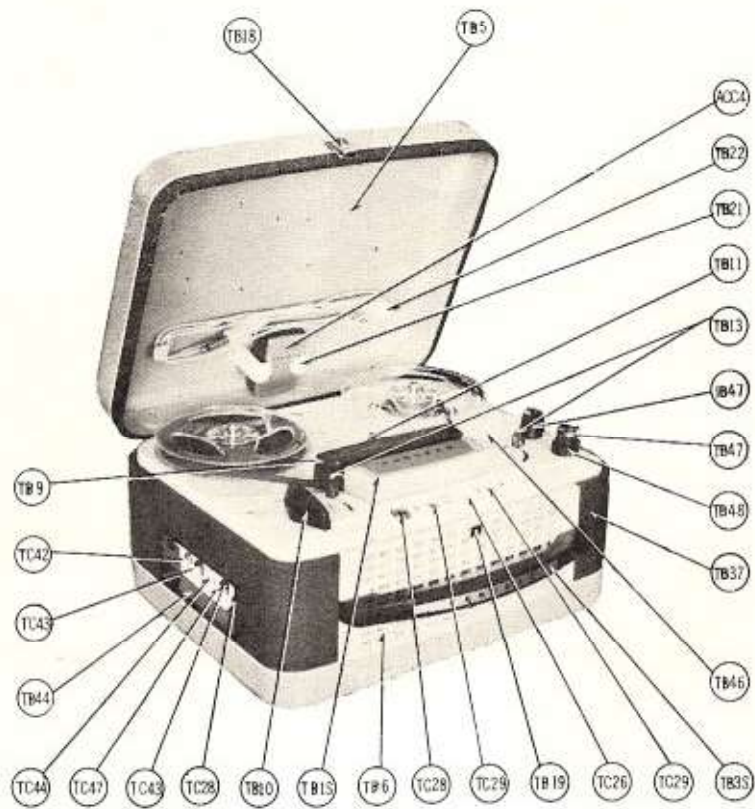

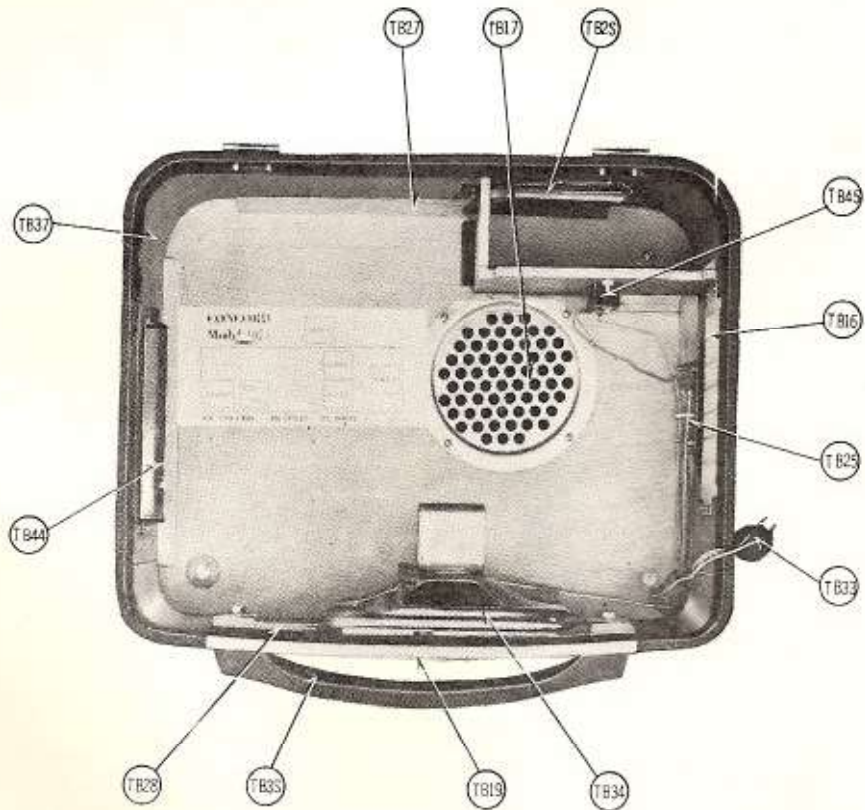
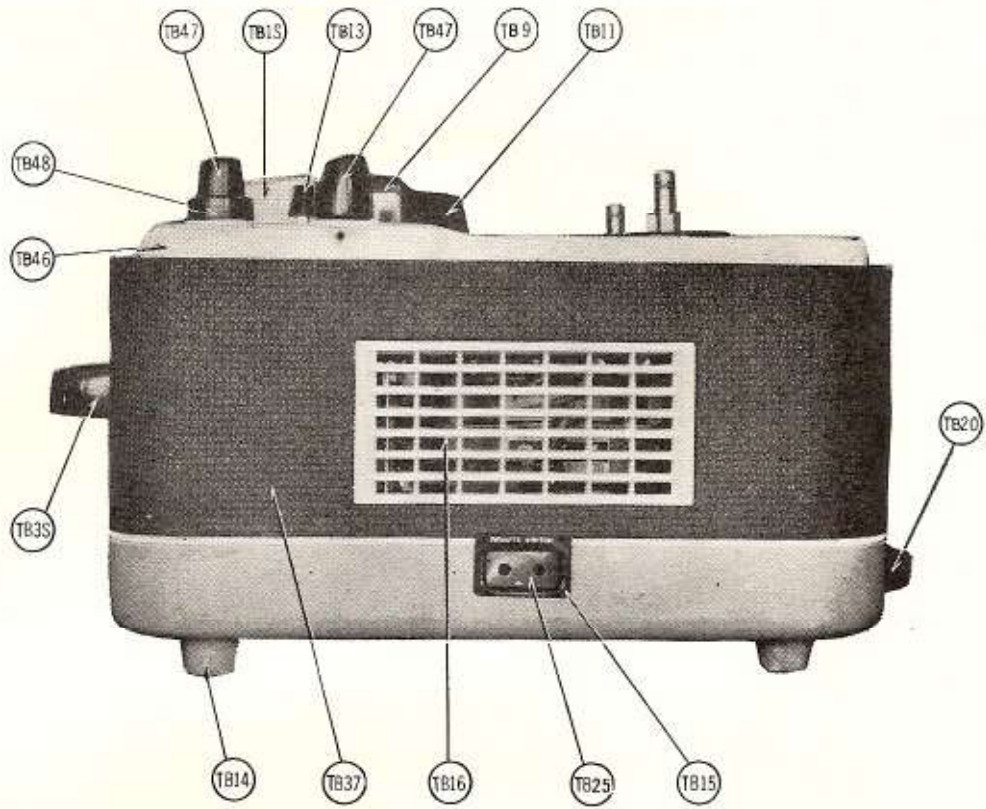

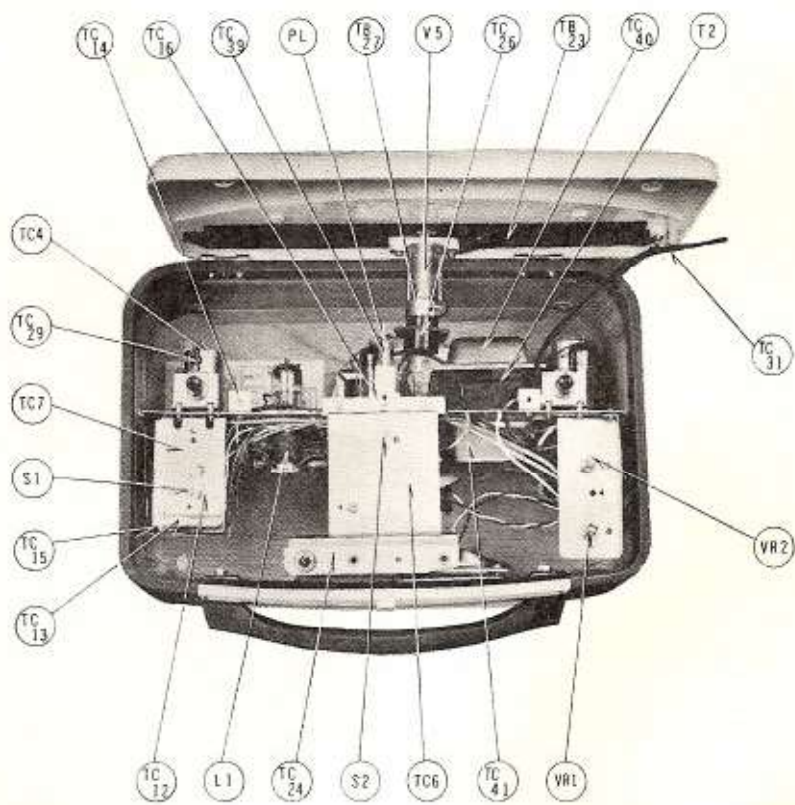
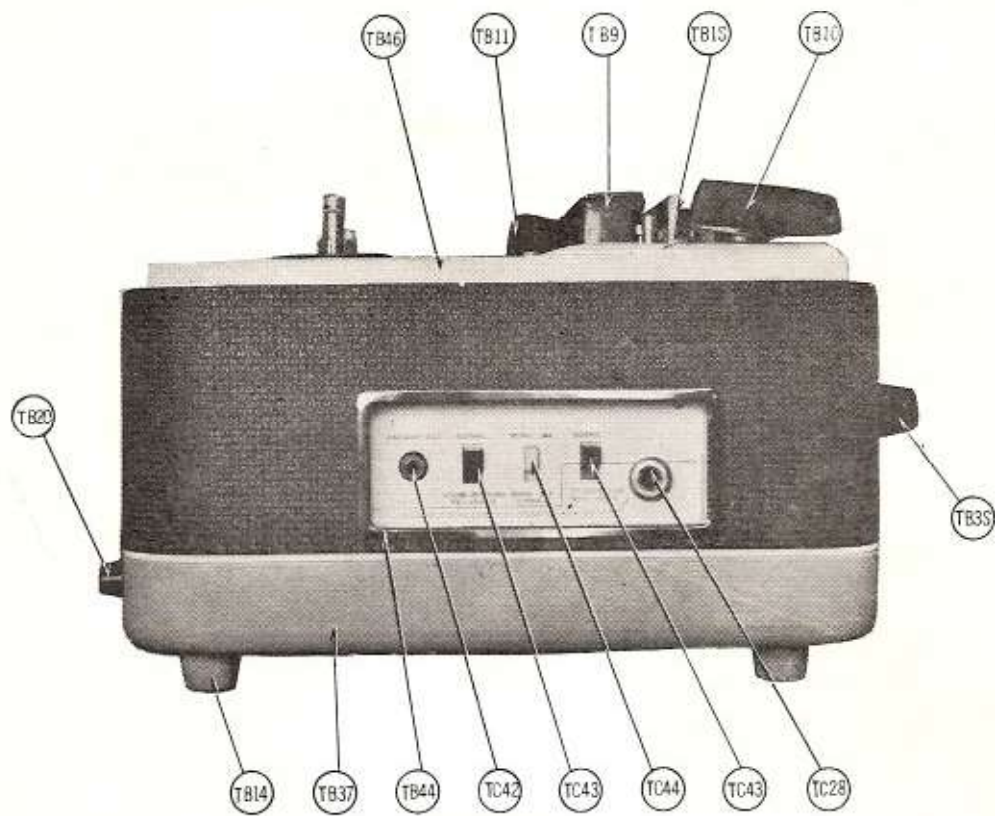

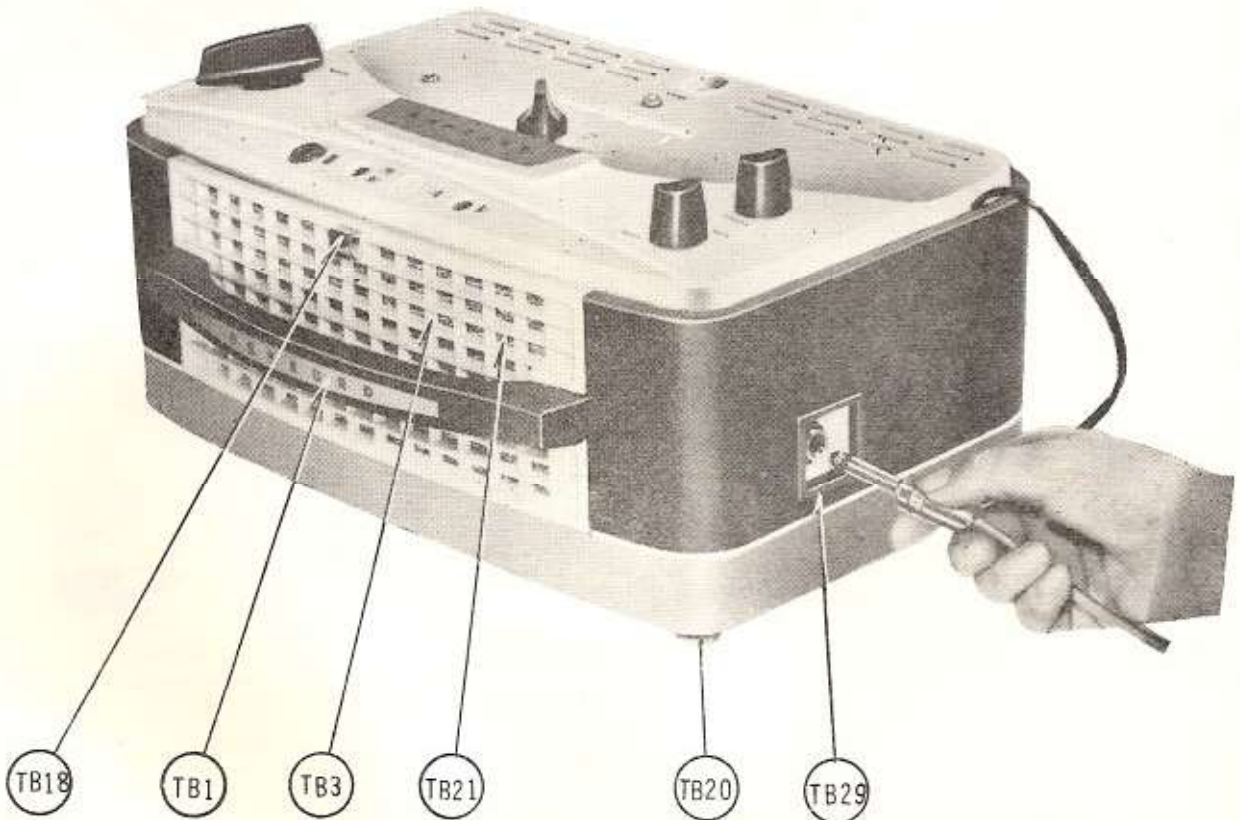
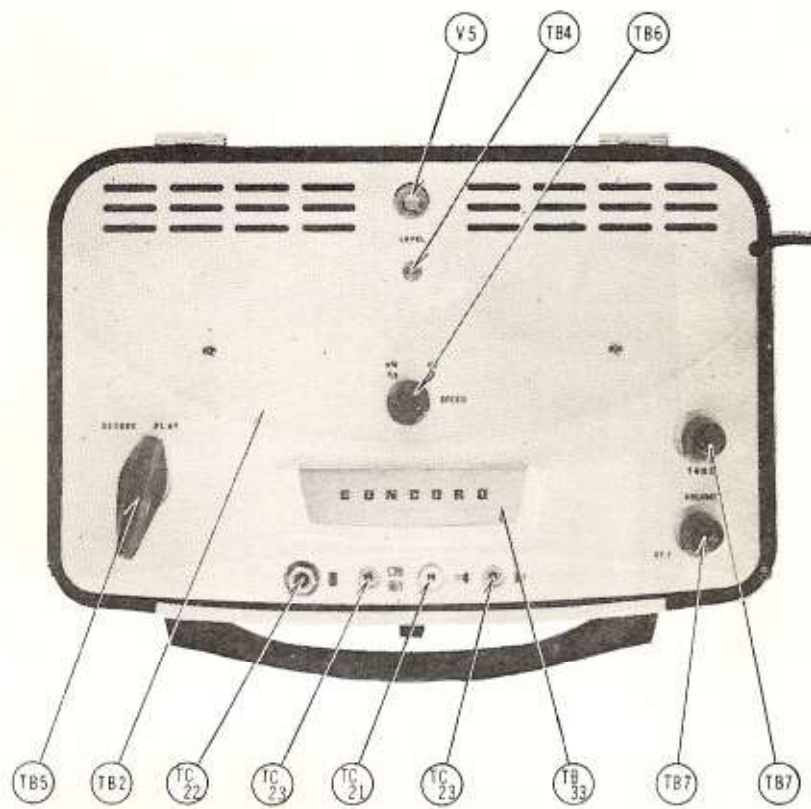

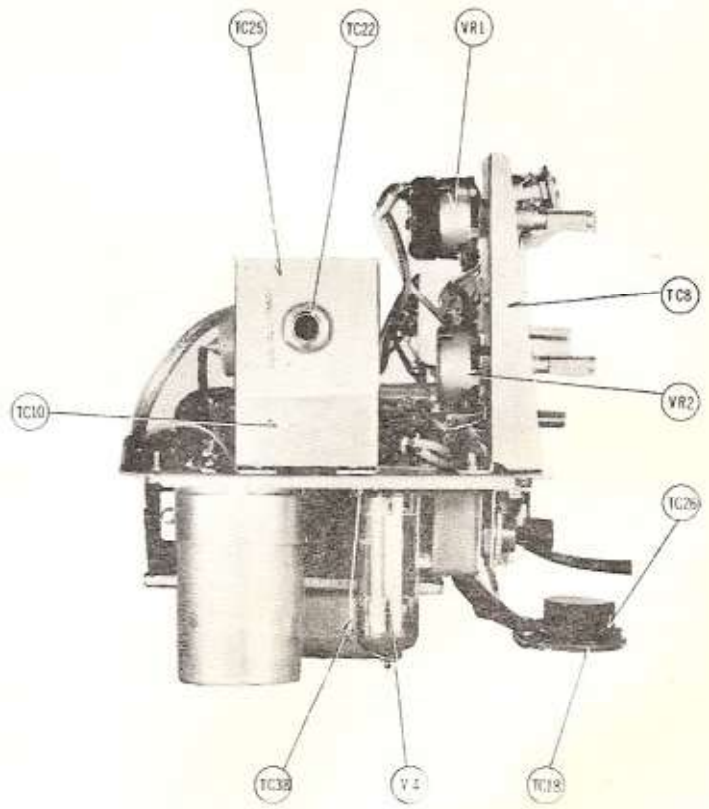
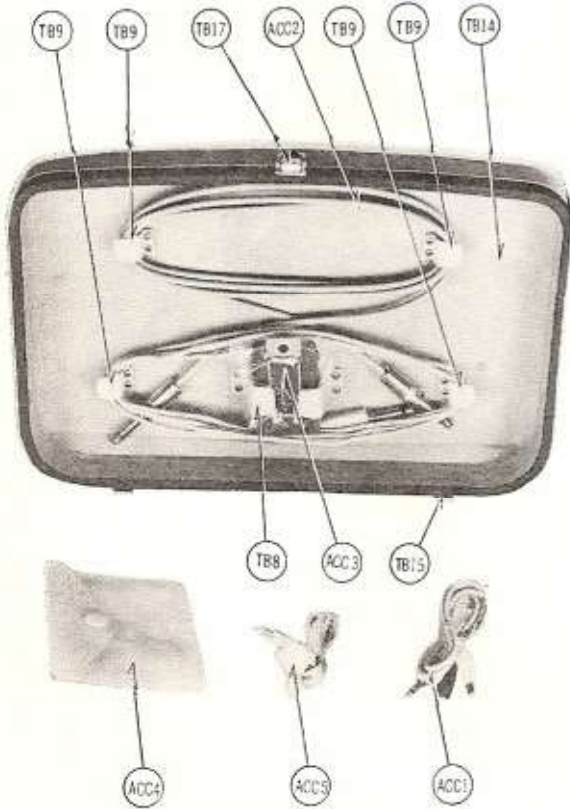
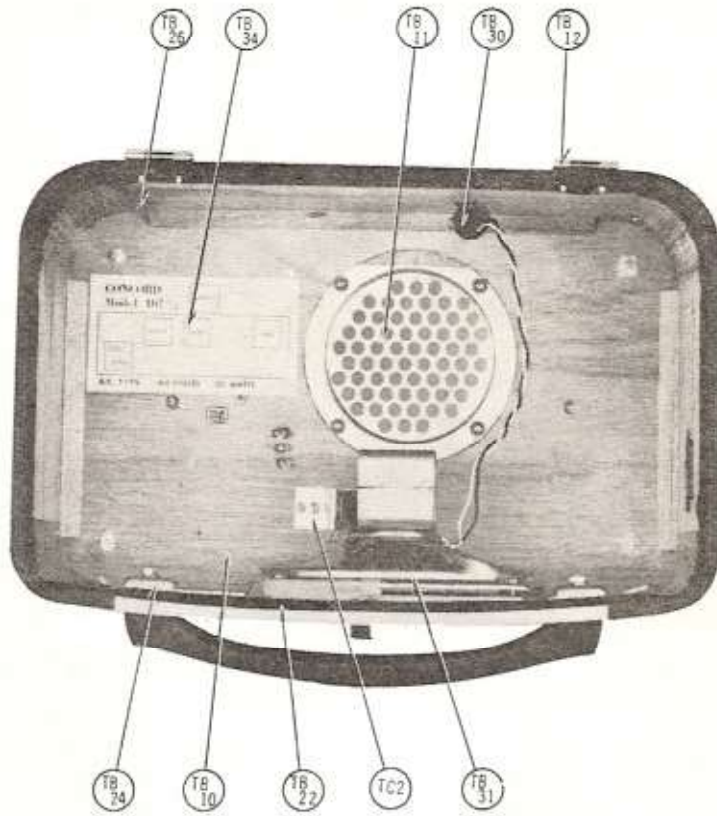

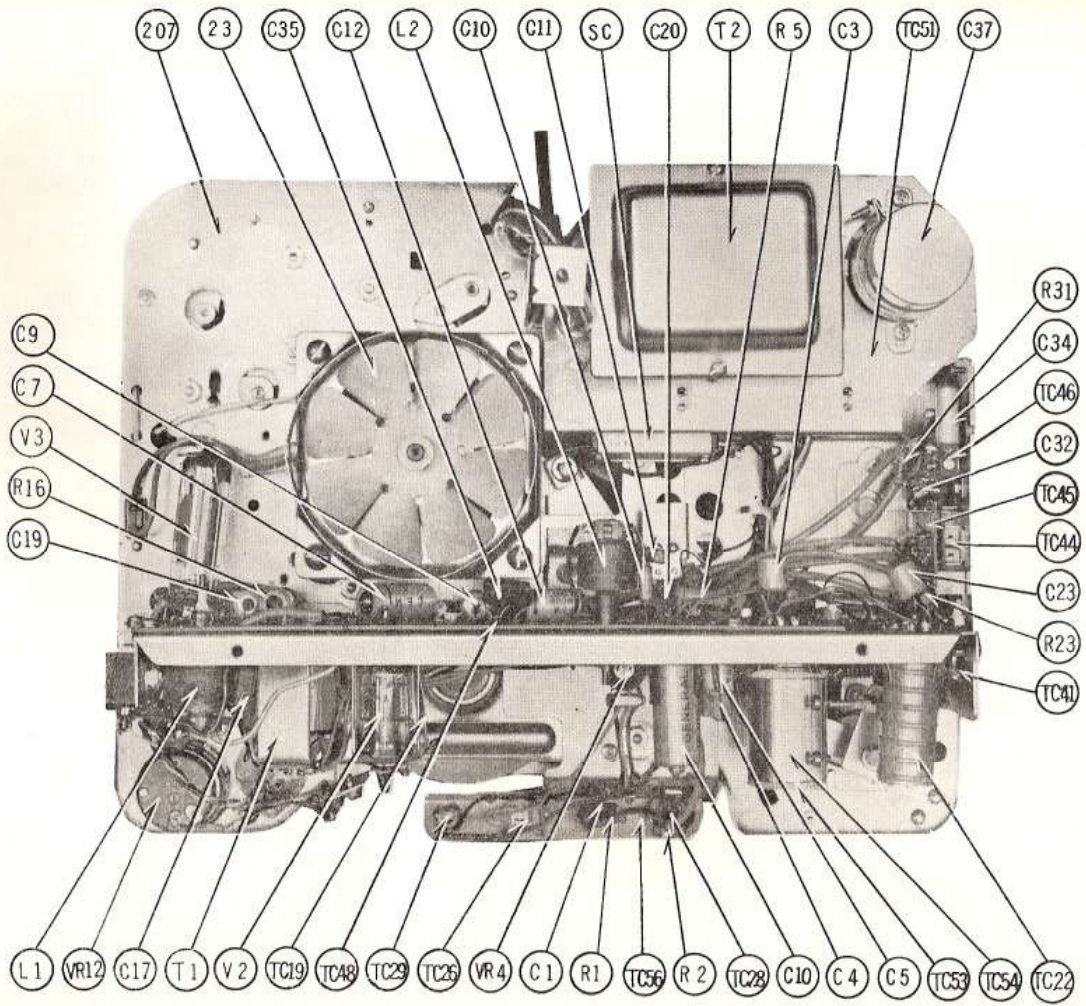

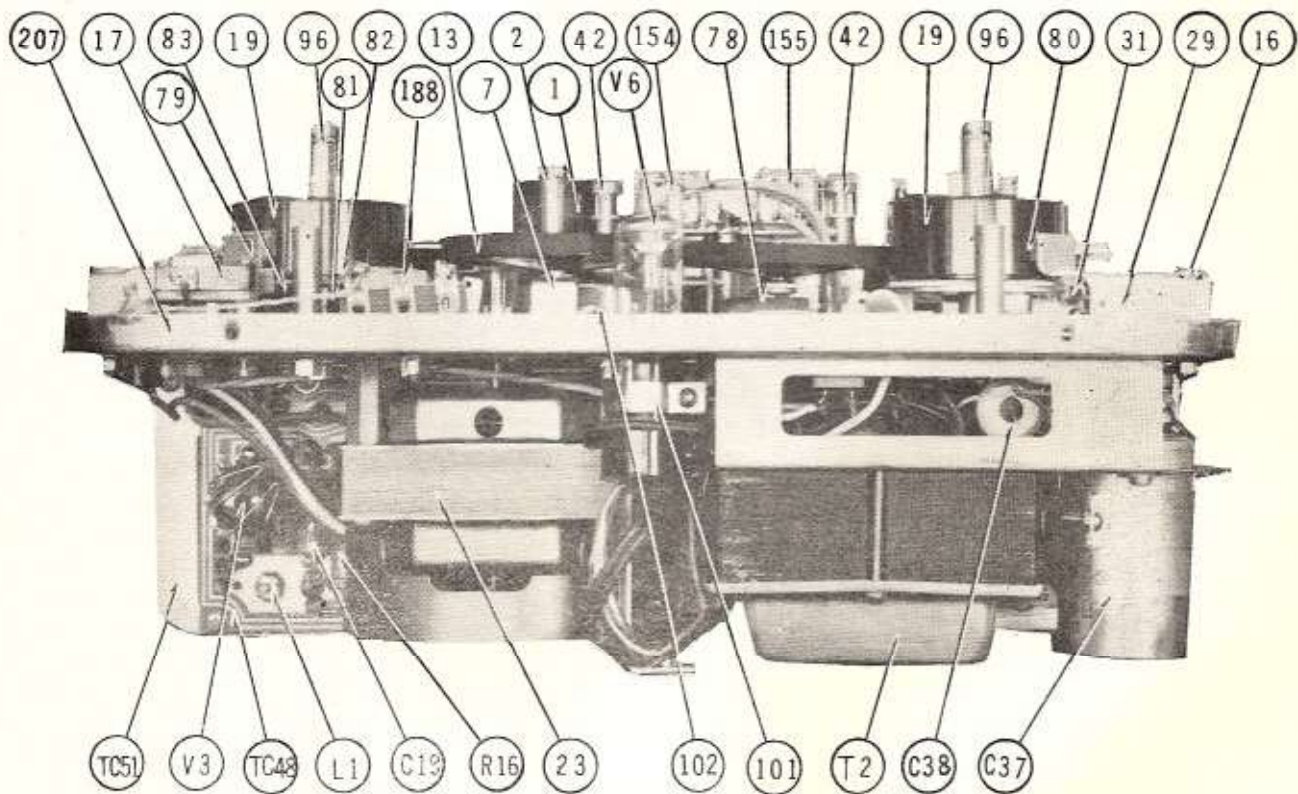
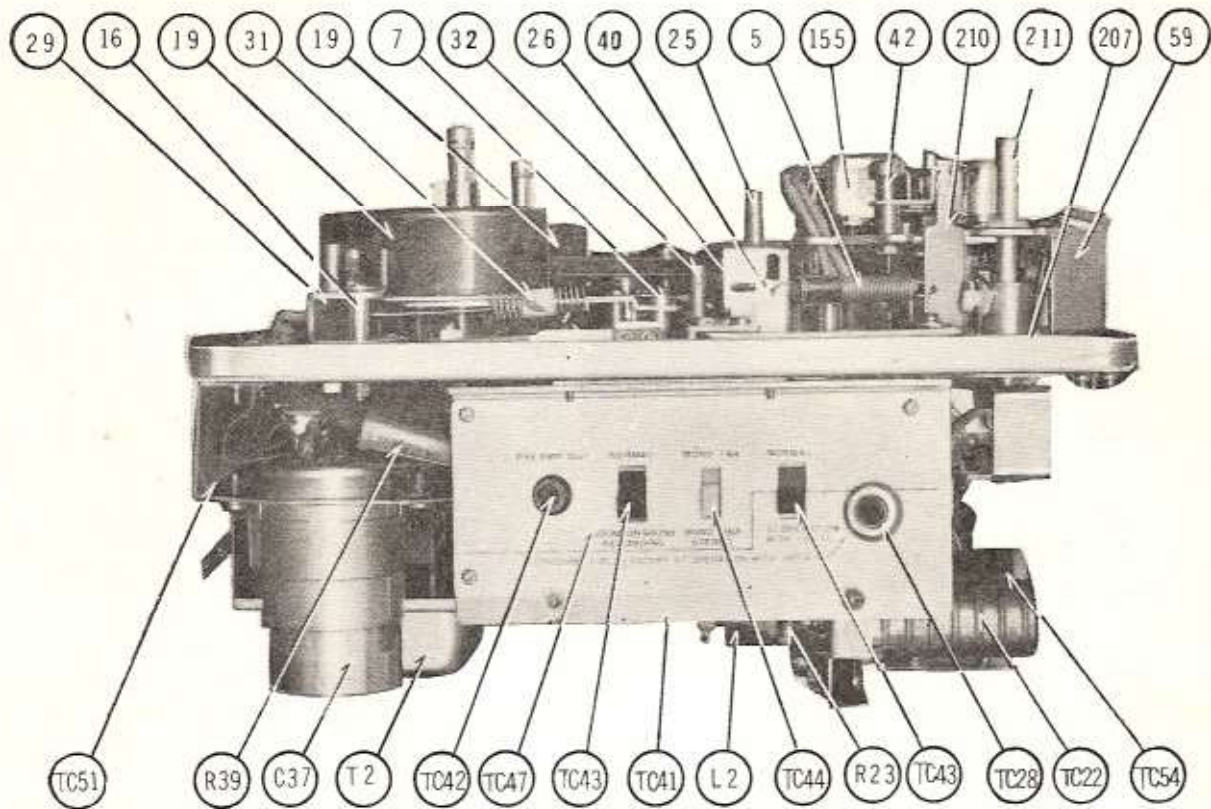

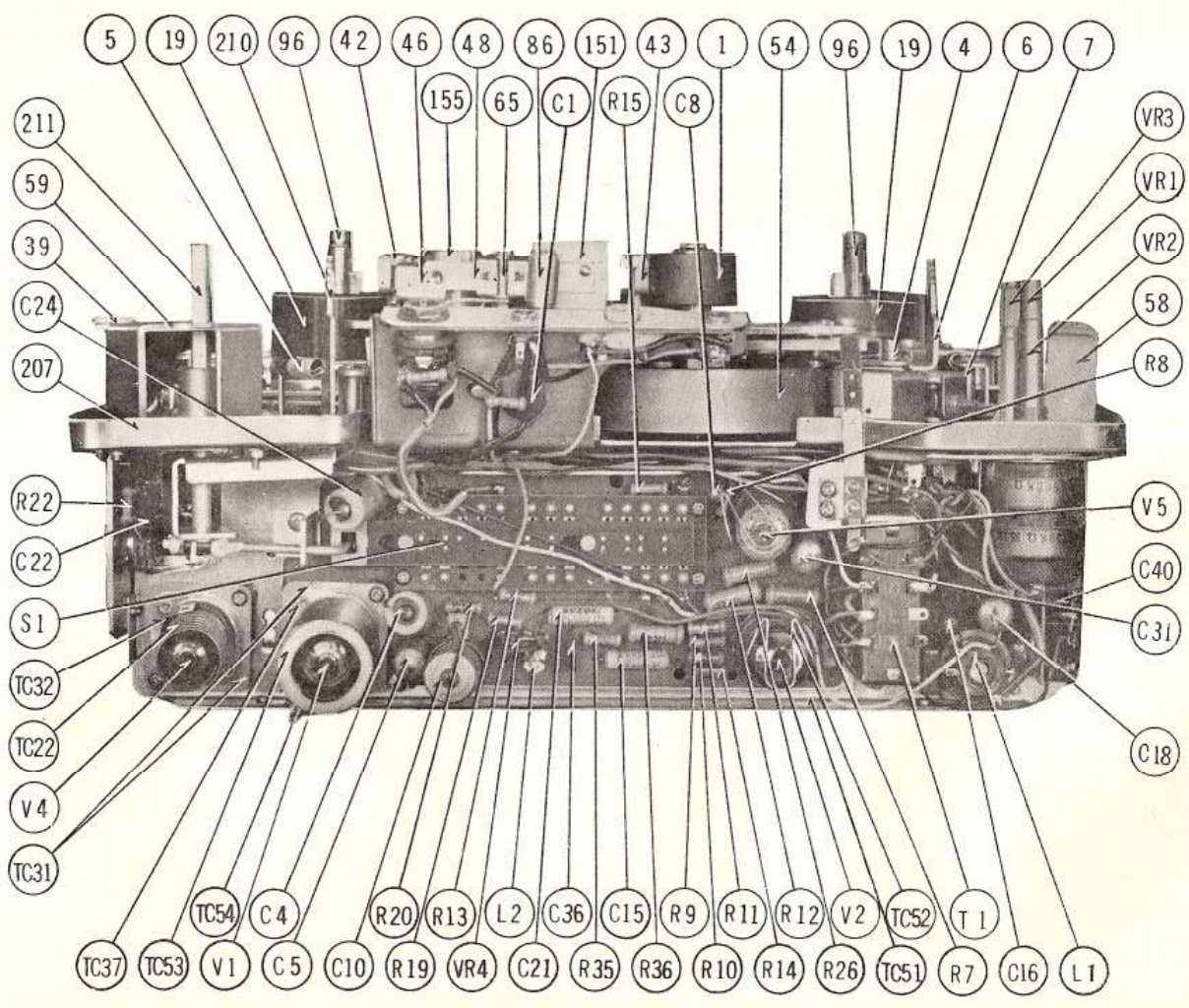

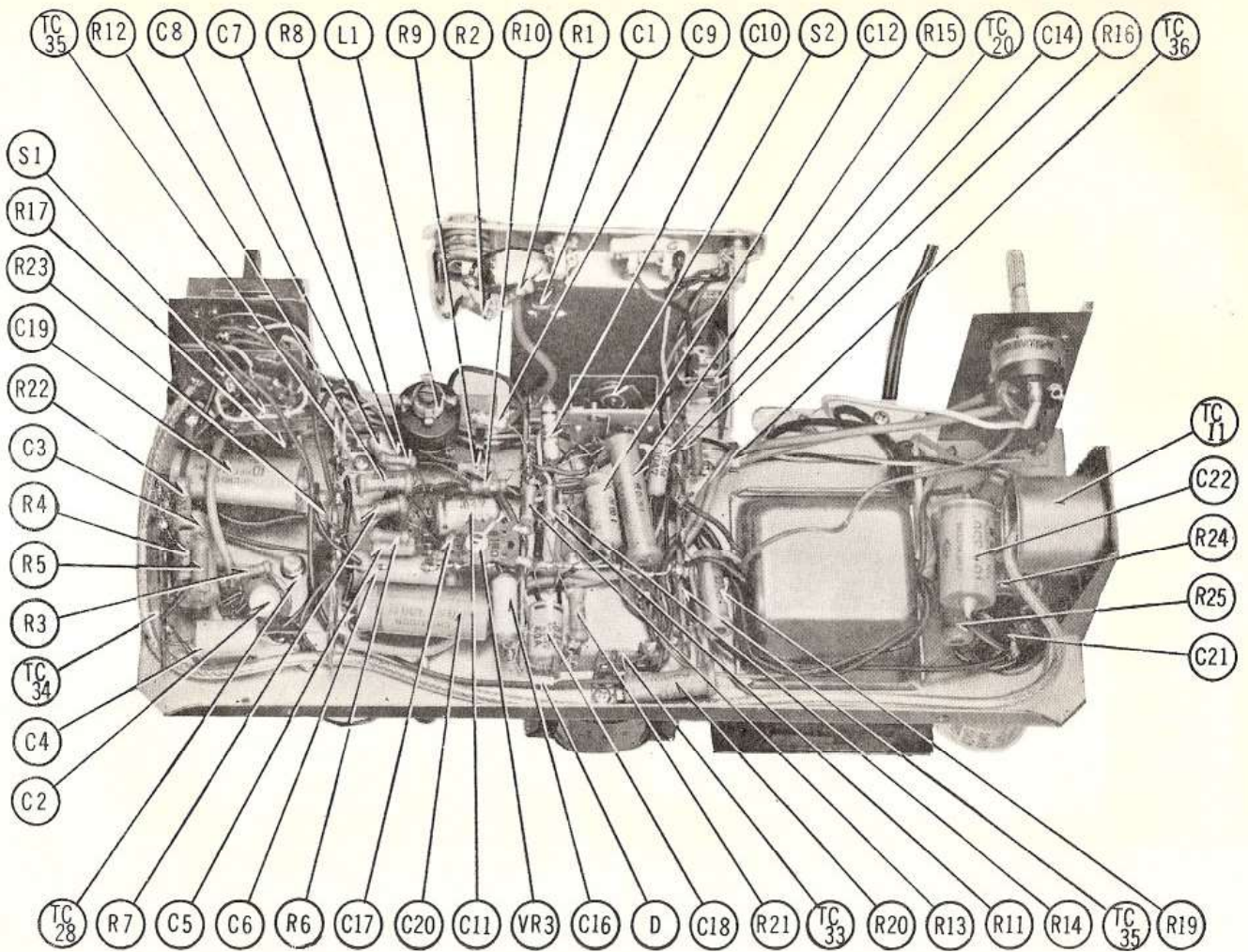

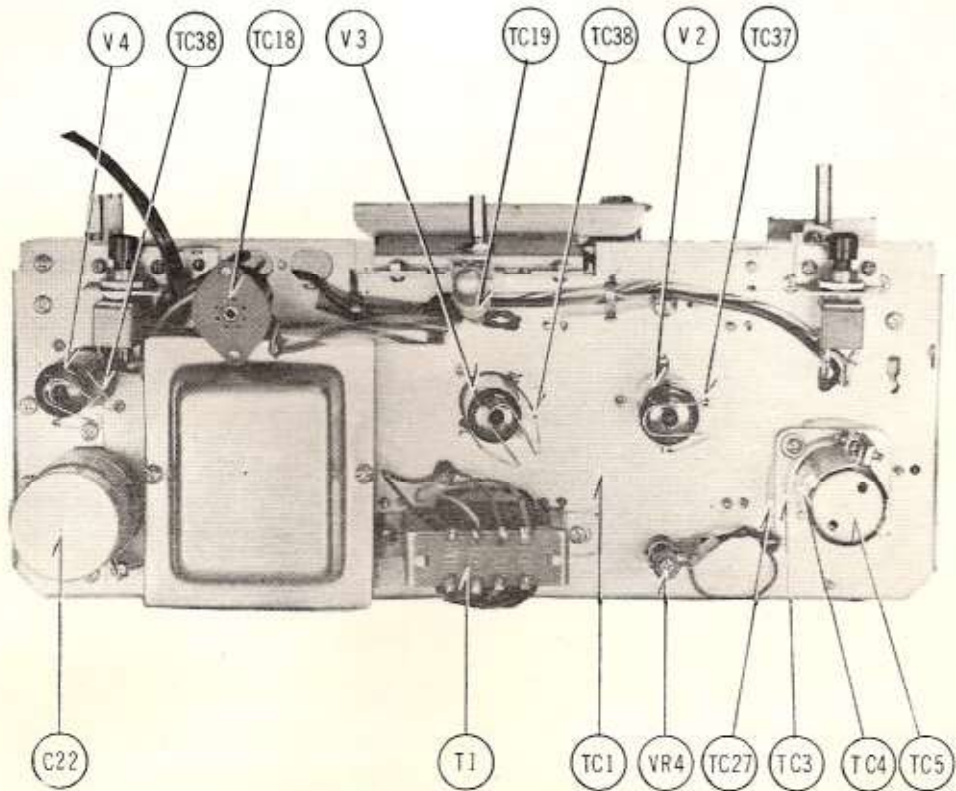
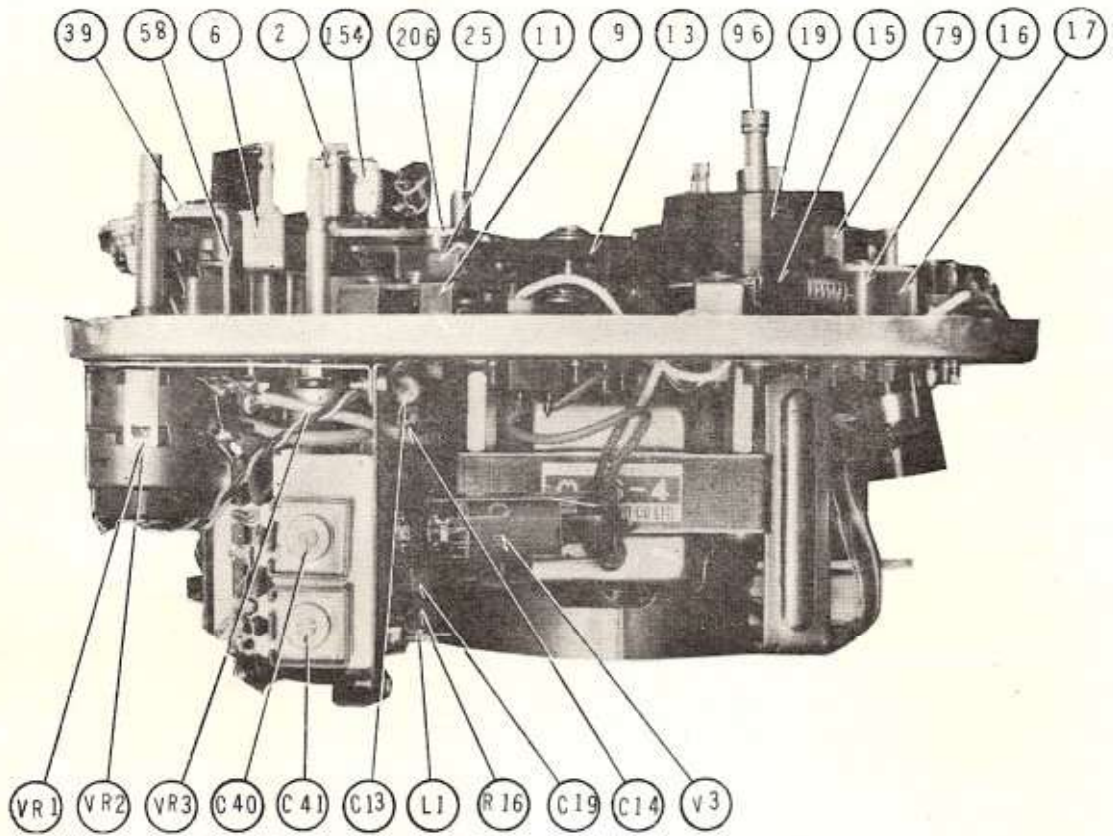

CIRCUIT DIAGRAM—1075

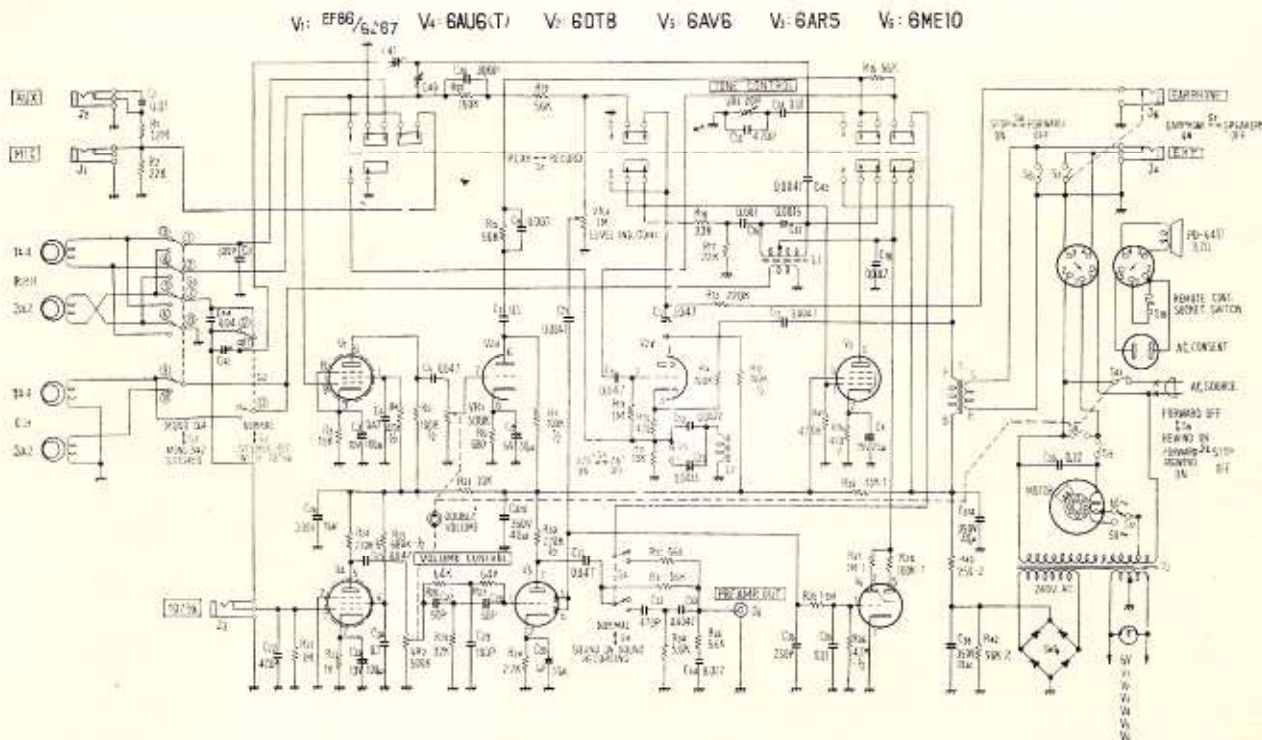

CIRCUIT DIAGRAM—1075/A

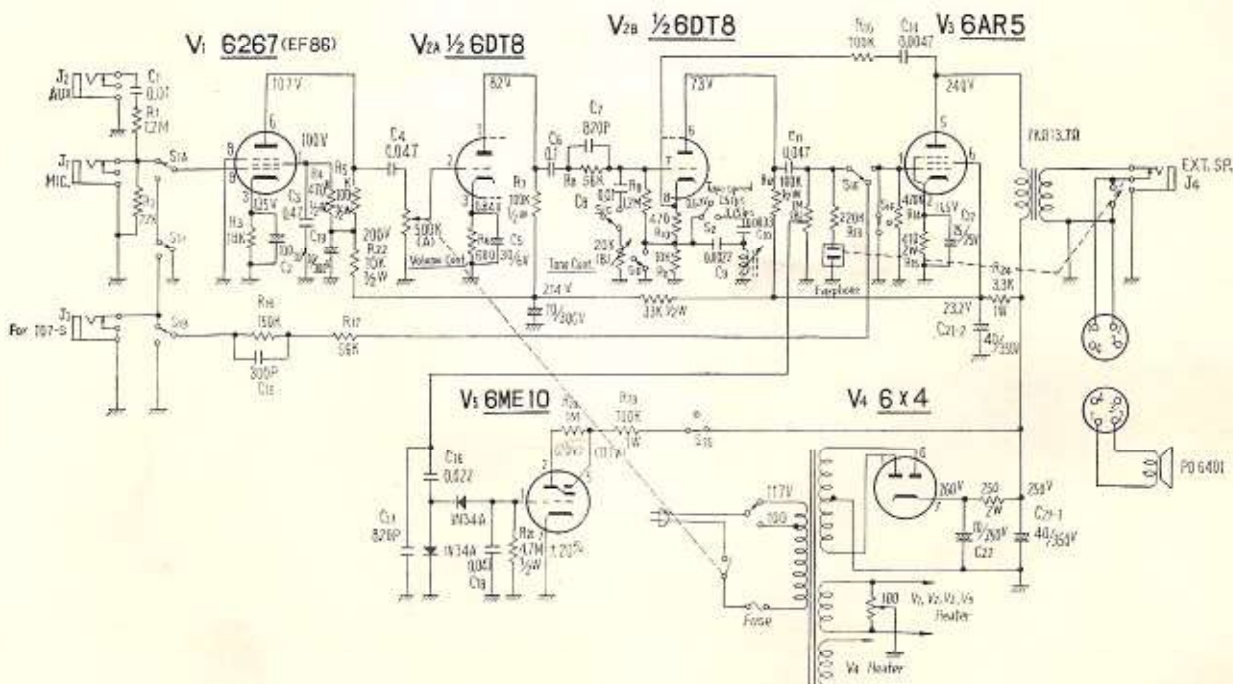

NOTE:

1. Resistance values in ohms
K=1,000 MEG=1,000,000
2. All resistors are 1/4 watt $\pm 10\%$ unless otherwise indicated
3. Capacitance values in μF
PF = $\mu\mu\text{F}$
4. S1 shown in RECORD position