

Service Manual

MODEL: DC-B83D1D
DC-B84D1S
DC-B84D1D
DC-B85D1D
DC-B86D1D
DC-B86D1P
DC-B87D1D
DC-B88D1D
DC-B89D1D
DC-B8CD1D
HV-DX3E
HV-DX3EV
HV-DX3SP
DVH-100A



✓ **Caution :**

In this Manual, some parts can be changed for improving, their performance without notice in the parts list. So, if you need the latest parts information, please refer to PPL(Parts Price List) in Service Information Center (<http://svc.dwe.co.kr>).

DAEWOO ELECTRONICS Corp.

[http : //svc.dwe.co.kr](http://svc.dwe.co.kr)

MAY. 2004

DAEWOO

CONTENTS

SPECIFICATIONS.....	2
ADVANTAGES OF THIS PRODUCT.....	3
TROUBLE SHOOTING.....	5
WAVEFORMS.....	23
CIRCUIT DIAGRAM.....	26
PCB CIRCUIT BOARD.....	36
INSTRUMENT DISASSEMBLY.....	39
ELECTRICAL PARTSLIST.....	45

SPECIFICATIONS

Power	200-240V~, 50/60Hz
Consumed electricity	22W
Weight	4.6kg
Dimension (W x H x D)	435mmx93mmx255mm
Operative temperature	+5°C~40°C
Installation condition	Horizontal / Relative humidity under 80%
Laser output	5mW (continuous wave max.)
Wave length	635nm (DVD), 730nm (CD)
Signal type	PAL COLOR
Antenna Input/output	U/V-mixed: 75Ω unbalanced
VIDEO input	1.0Vp-p (unbalanced, RCA JACK)
AUDIO input	-8.8dBm, RCA JACK
VIDEO output (common use of DVD and VCR)	VIDEO output terminal, 1.0 Vp-p unbalanced, RCA JACK, SCART JACK
VIDEO output (DVD only)	RGB output (75Ω In load R: 0.7Vp-p, G:0.7Vp-p, B:0.7Vp-p)
AUDIO output (common use of DVD and VCR)	Audio output terminal (2 kinds): -5.8dBm(VCR), 2Vrms(DVD), RCA JACK
AUDIO output (DVD only)	Analogue AUDIO output : 2.0Vrms Digital audio output (OPTICAL, COAXIAL)
Playable tape	Very high dense tapes with VHS marks
Playable disc	DVD, VIDEO-CD, CD (12cm), CD (8cm), MP3, CD-R, CD-RW
Tape speed	SP: 23.39mm/s, LP: 11.70mm/s
Playtime	SP: 3hrs, LP: 6hrs (use of E180tape)
Clock display	24 hrs
Time Recording	8 programs a month
Persistence in power failure	1min
VIDEO S/N (VCR)	Over 43dB(Standard recording)
Resolution	VCR
	DVD
	Over 240 lines (Standard recording)
	Over 400 lines (Playback DVD)
AUDIO (VCR)	Over 65dB
AUDIO (DVD)	90dB
AUDIO dynamic range	90dB

DVD Audio output standards

Output	Disc type		
	DVD	VIDEO-CD	CD
Analogue Audio output	48/96KHz sampling	44.1KHz sampling	44.1KHz sampling
Digital Audio output	48KHz sampling	44.1KHz sampling	44.1KHz sampling
Optical digital audio output	48KHz sampling	44.1KHz sampling	44.1KHz sampling

ADVANTAGES OF THIS PRODUCT

- DVD, VCD, CD, CD-R(MP3), CD-RW, VHS
- Watching DVD for recording broadcast
- Integrated remote control (VCR, DVD)
- VISS function
- Multiplex sound playback/record
- High Sound Quality of 6 head Hi-Fi
- Simple record function
- MP3 file playback function (CD-R disc having records of MP3 files)
- GUI (Graphical User Interface) through OSD (On Screen Display)

By using the [DISPLAY] button on the remote control, information on the DVD/VCD/CD player and disc, can be displayed on the TV screen.

- Screensaver function (DVD)
- 3D sound (3D sound effect using 2 speakers)
- High bit / High sampling with 27MHz / 10bit video encoder
- High bit / High sampling with 96MHz / 24bit Audio D/A Converter
- Coaxial, Optical digital Audio output (PCM, Dolby Digital, dts)

You can enjoy high-level digital audio by connecting with amp embedded with Dolby Digital / dts decoder.

- Built-in Dolby Digital decoder (DVD)
- Analog audio 2-channels output for DOWNMIX (x1)
- Composite video output (x1)
- Slow Forward / Reverse playback (DVD)
- Fast Forward / Reverse playback
- Search of title, chapter, and time in DVD disc, and search of time and track time in VCD.
- Various TV aspect (DVD)

4:3 for Pan and Scan, 4:3 for Letter Box, and 16:9 for Wide

- Repeat playback (title, chapter, and part for DVD/ track, disc, and part for VCD/CD)
- Selective Play (DVD/VCD/CD)

You can select and play the desired title / chapter of DVD and track of Video CD/CD in STOP mode.

- Parental Lock function (DVD)

This function can prevent playback of software that may be unsuitable for children.

- Multi Audio function (DVD)

The audio soundtrack can be heard in up to 8 languages. In the case of SVCD or VCD, it depends on the disc. (The number of audio languages depends on the software.)

- Multi Subtitle function (DVD)
The subtitle can be seen in up to 32 languages. In the case of SVCD or VCD, it depends on the disc. (The number of subtitle languages depends on the software.)
- Multi Angle function (DVD)
This function allows you to choose the viewing angle of scenes which were shot from a number of different angles. (The number of angles depends on the software.)
- Screen zoom function (DVD/VCD)

TROUBLESHOOTING

1. POWER CIRCUIT

✓ CAUTION

You must use insulated transformer during the first part test of POWER circuit.

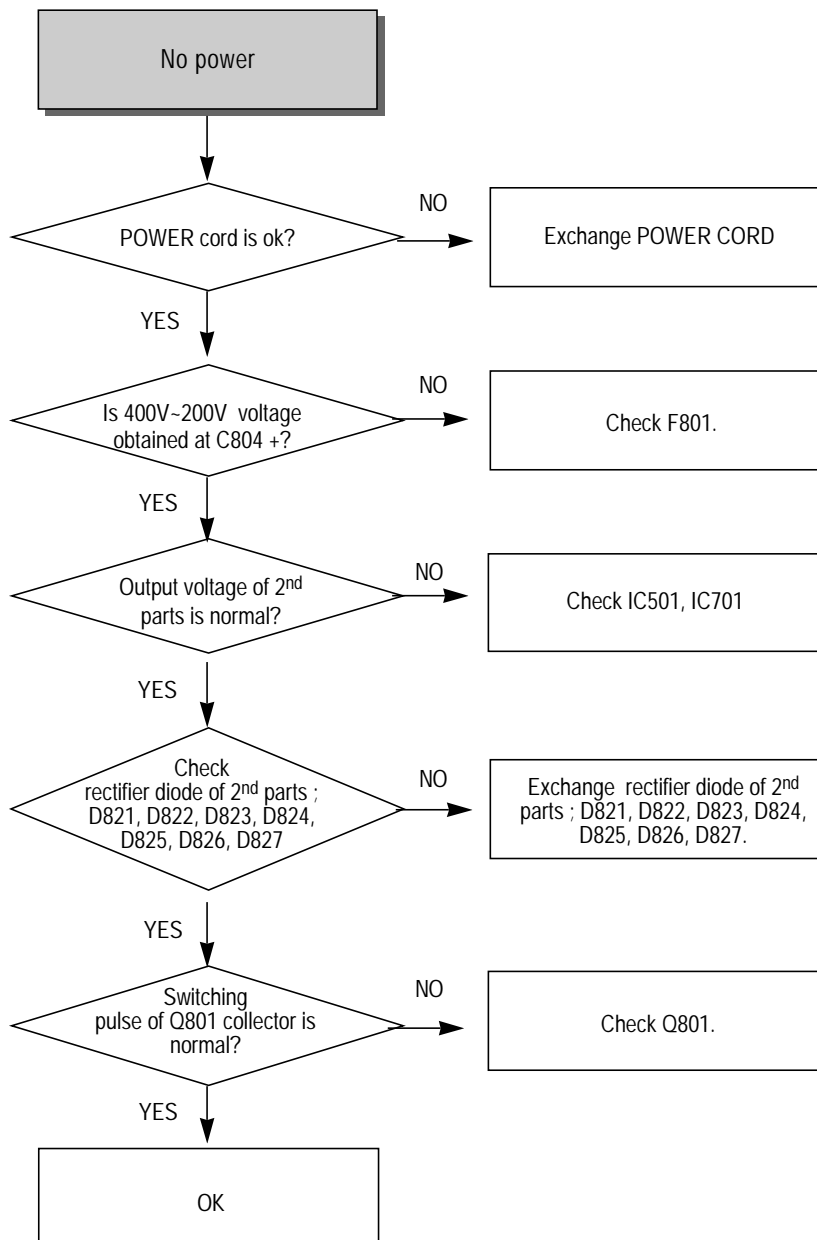

2. SYSTEM CIRCUIT

A. LED DISPLAY

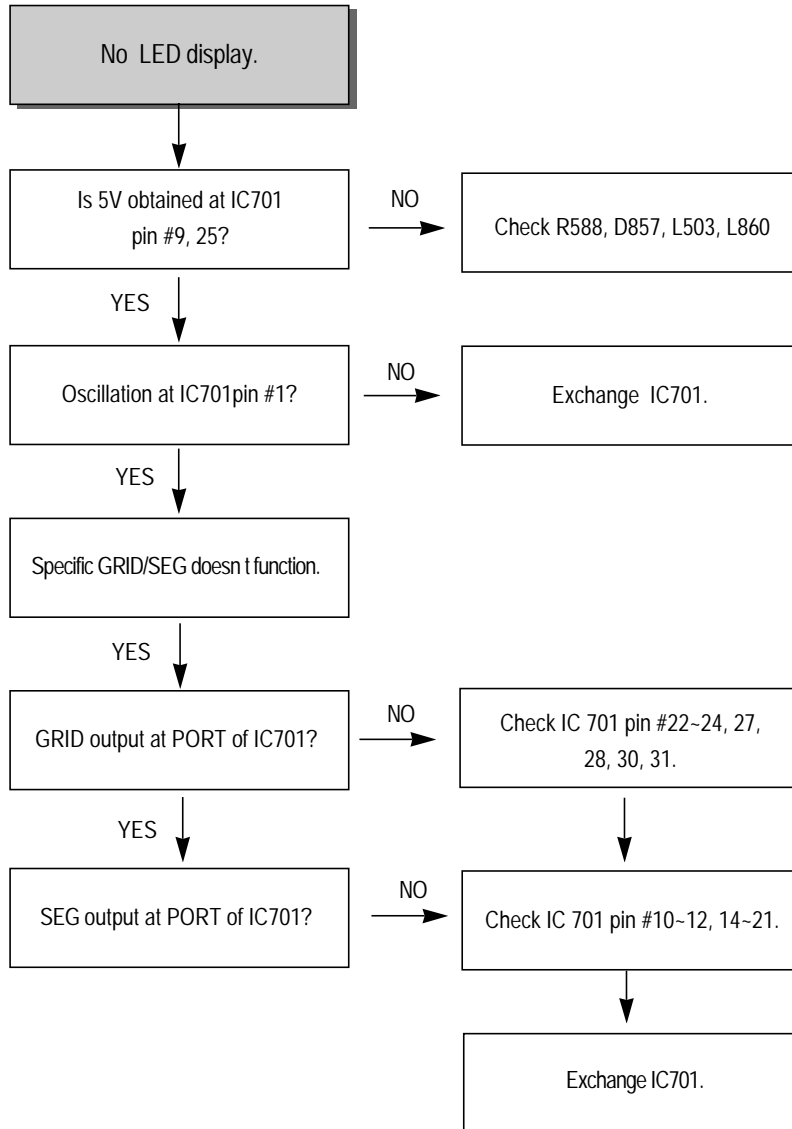

B-1. Bad playback quality (1)

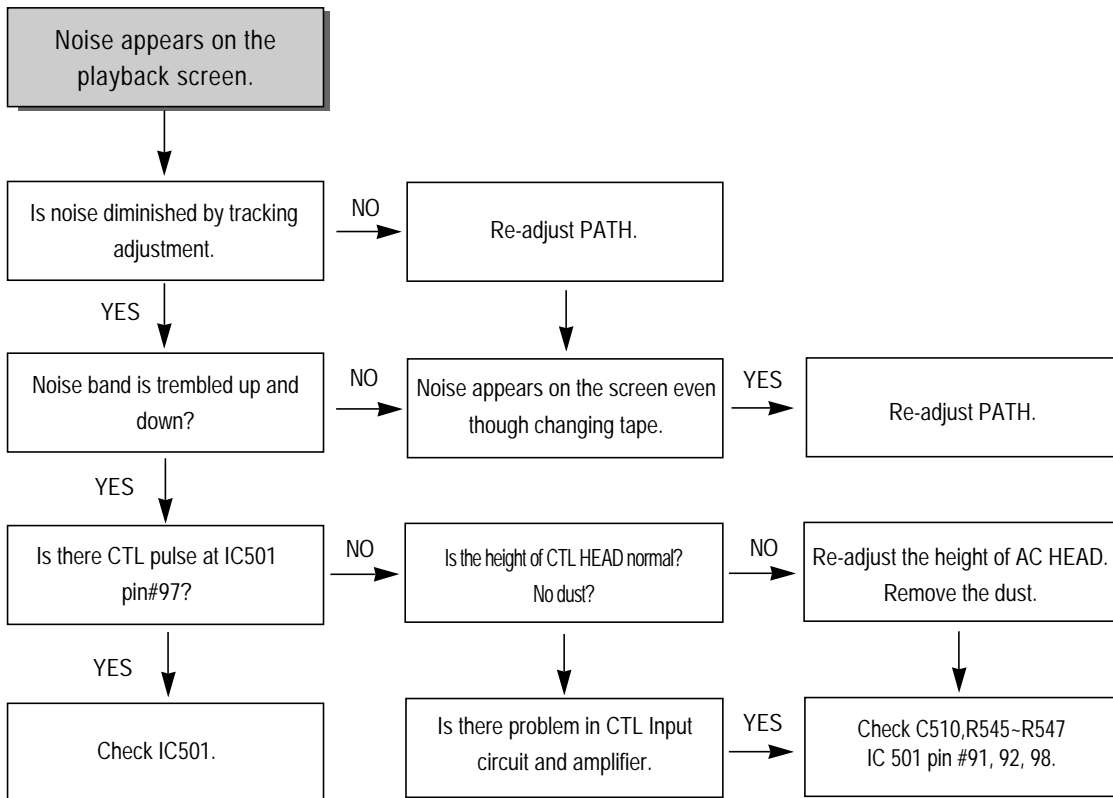

B-2. Bad playback quality (2)

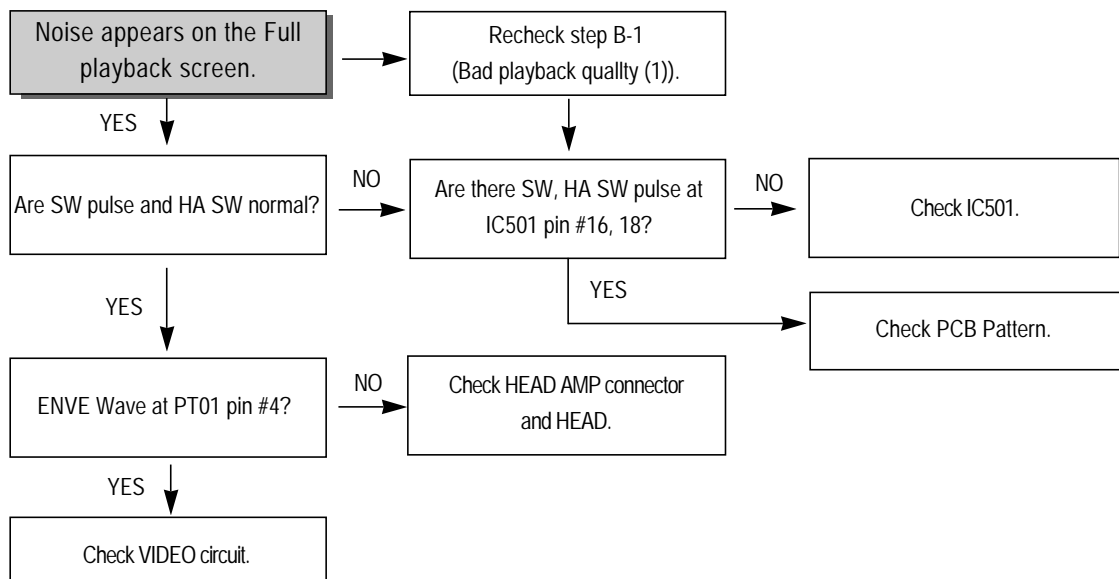

C. No broadcasting signal received

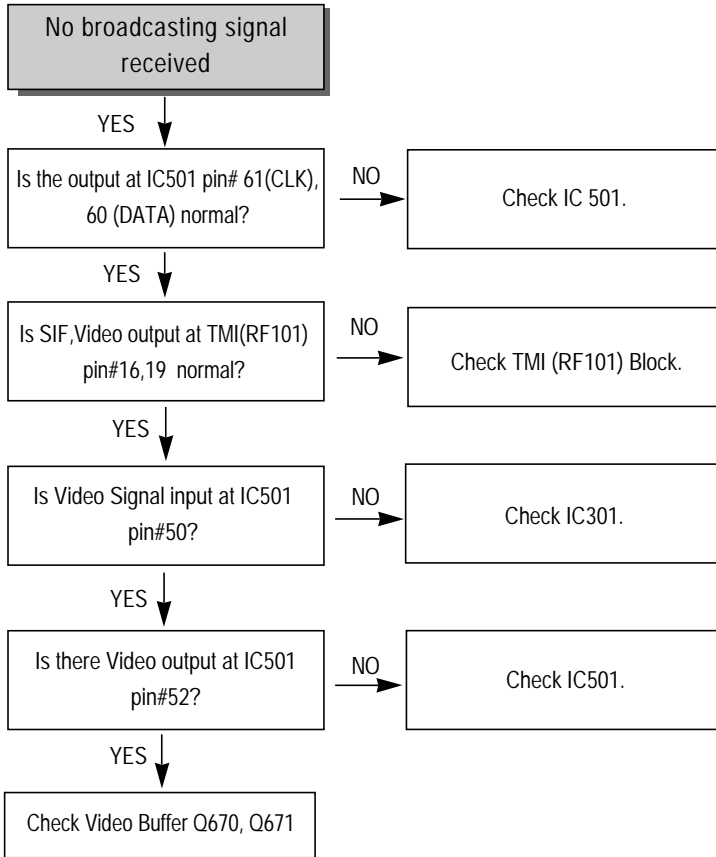

D. No CASSETTE Loading

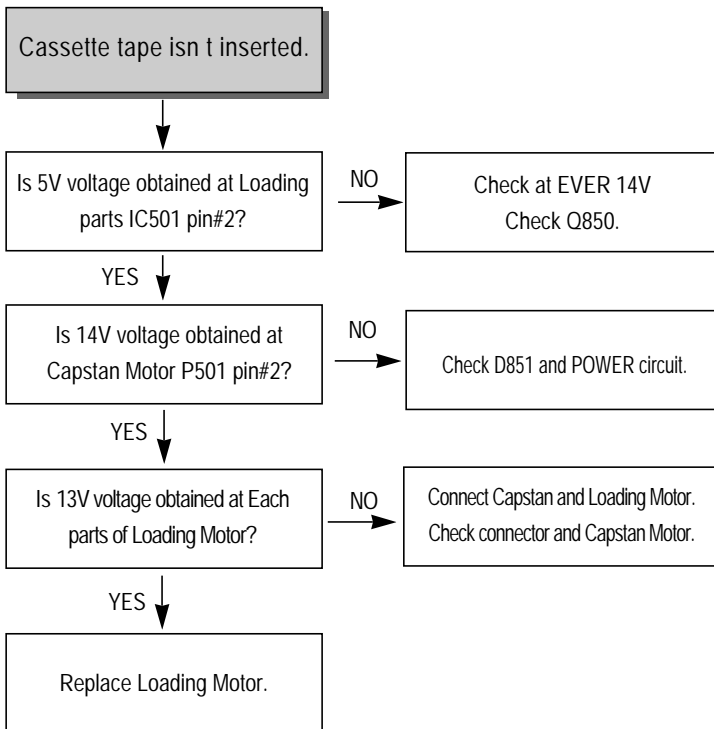

E. AUTO STOP in Playback mode

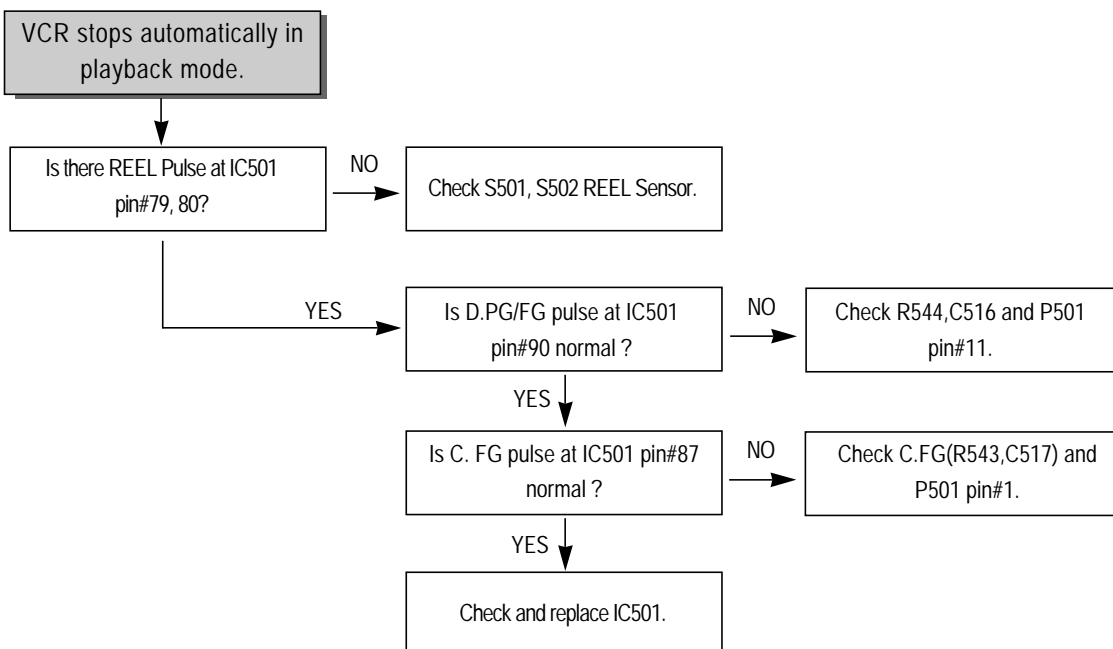

F. DRUM Motor stops

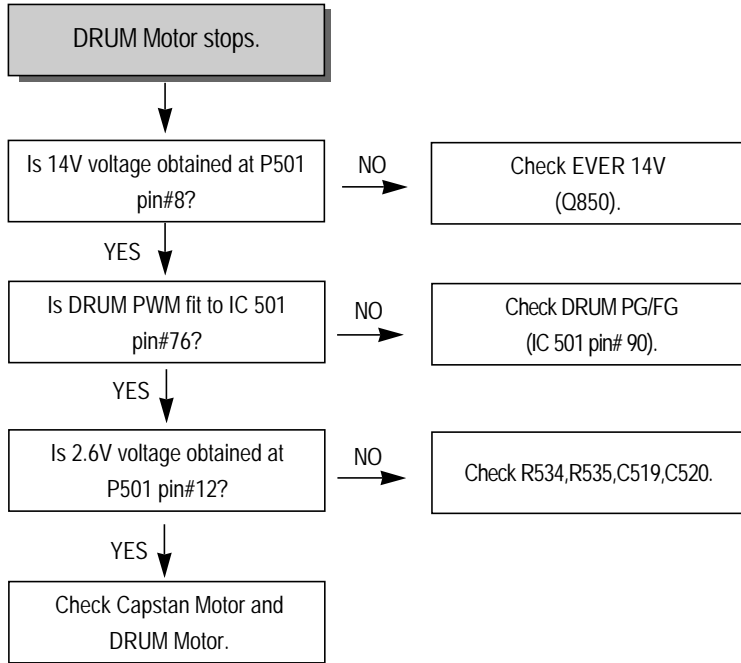

G. CAPSTAN doesn't rotate

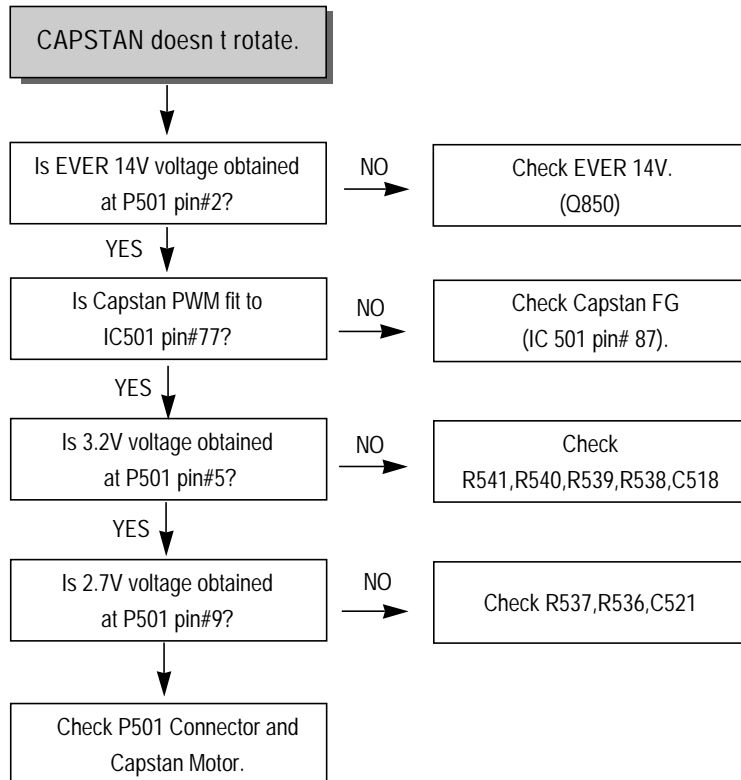

3. VIDEO circuit

A. EE screen doesn't appear

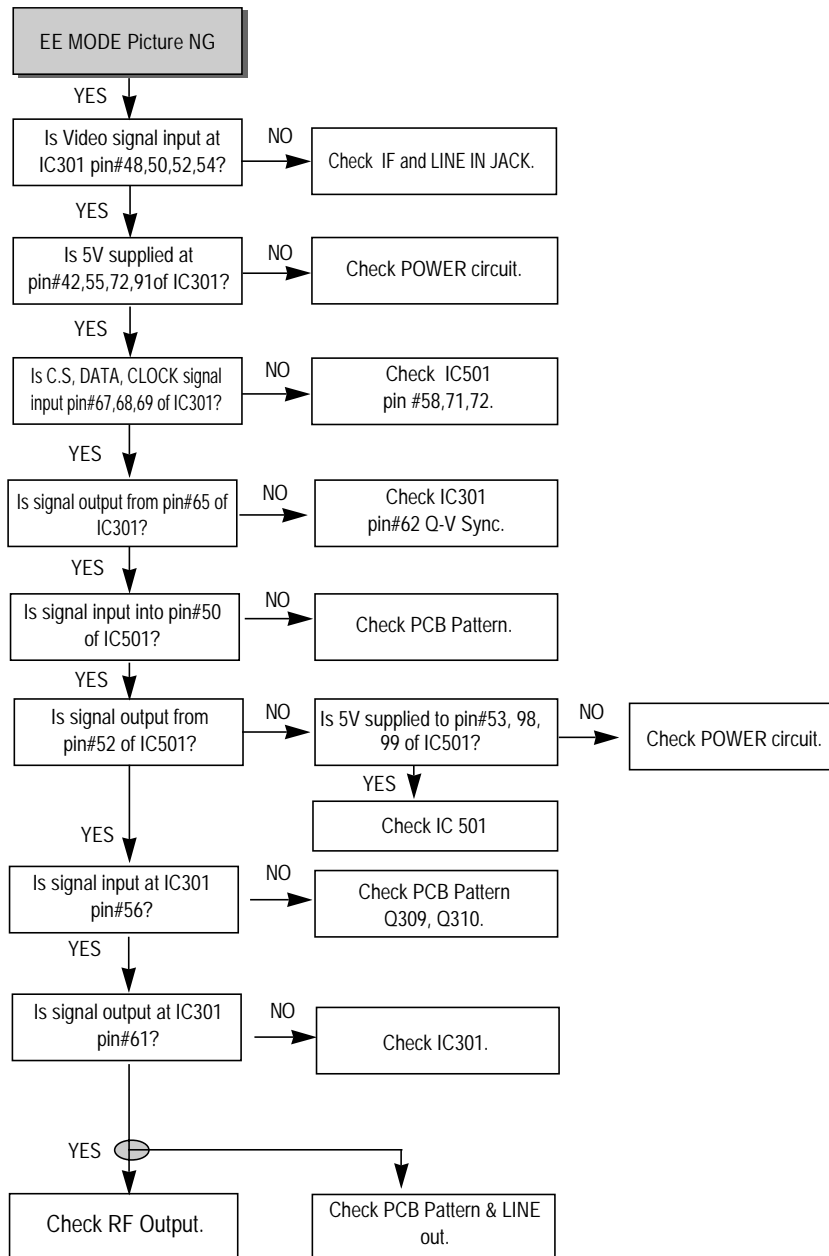

B. Playback picture doesn't appear

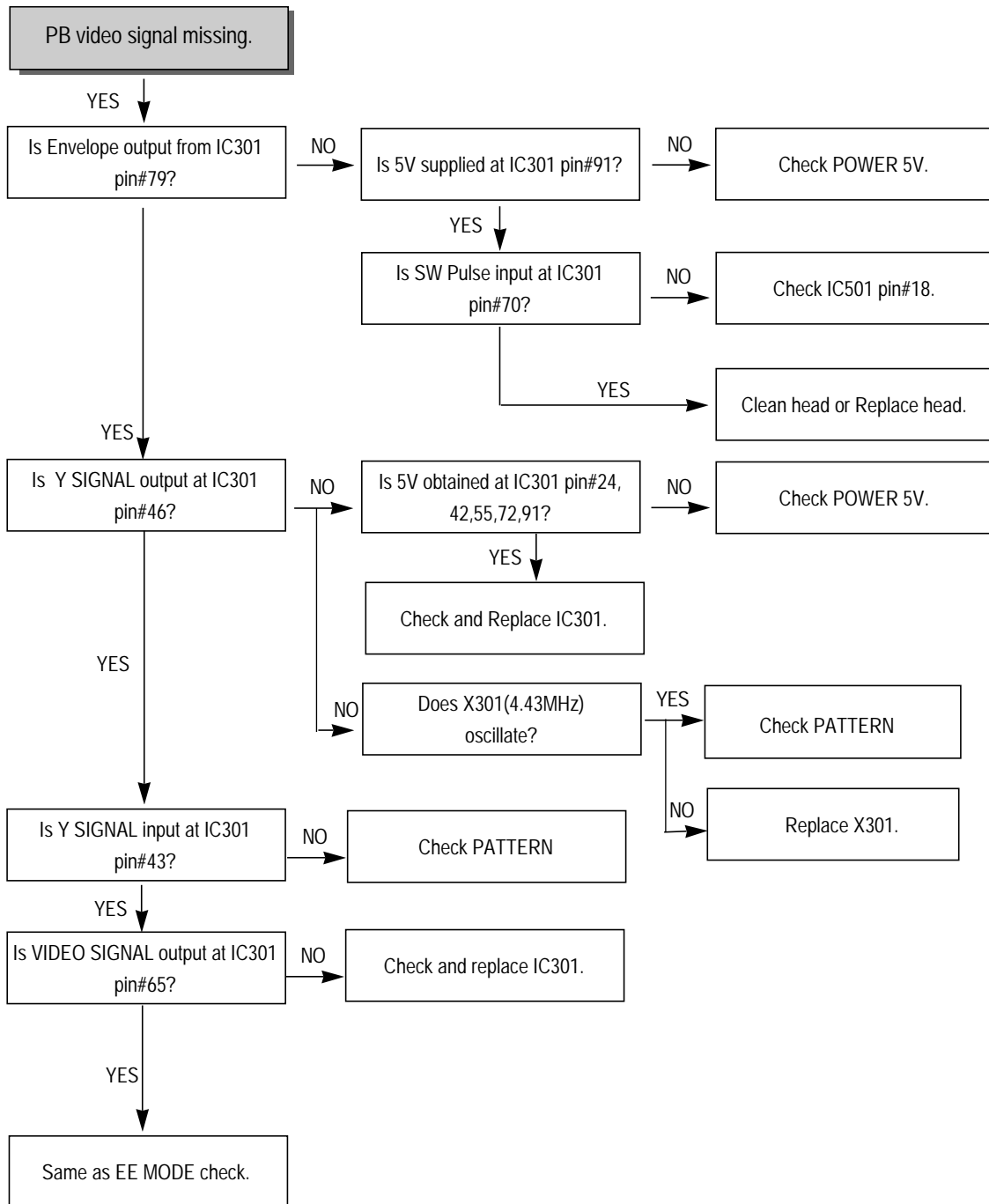

C. No recording

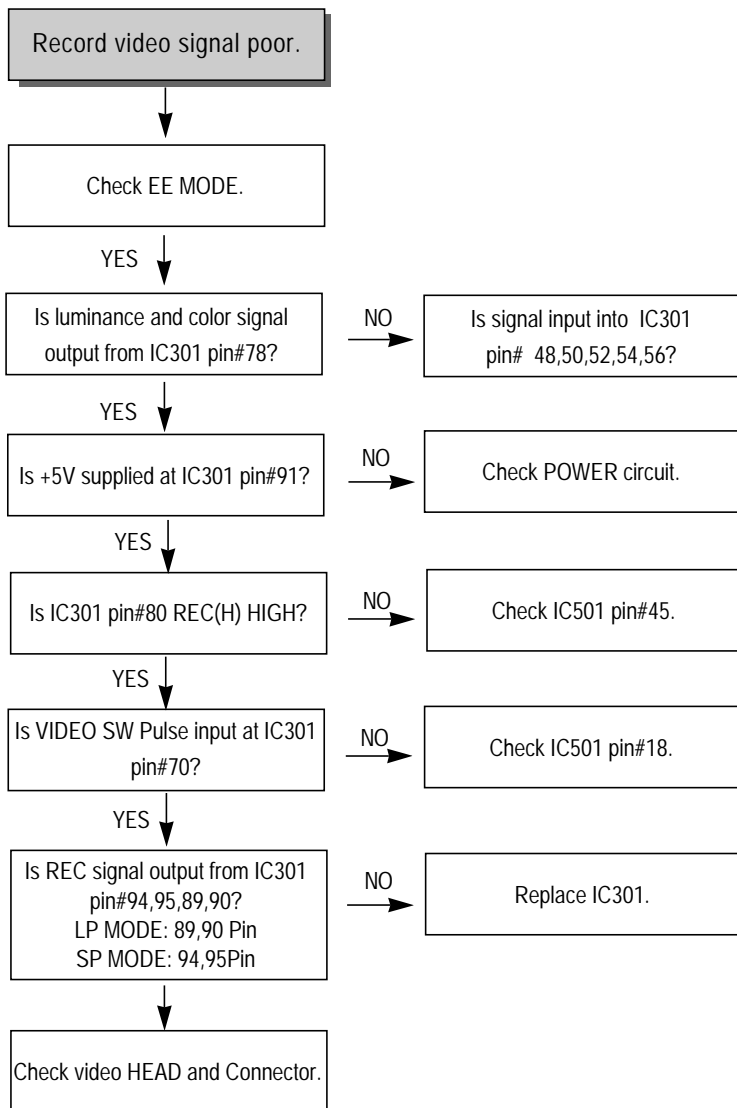

D. No OSD(On Screen Display) appears

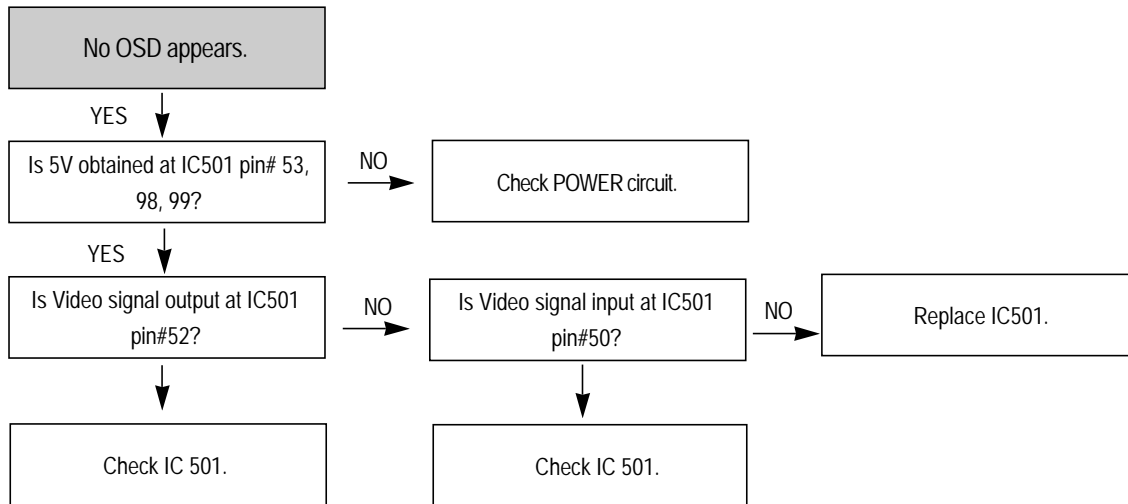

E. No DVD Video

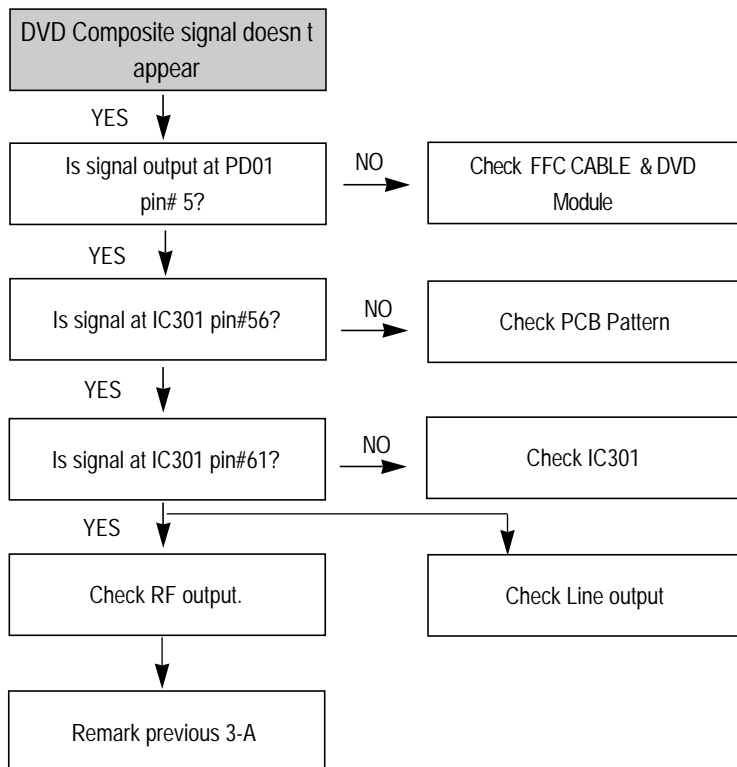

4. AUDIO (Hi-Fi MODEL)

A. No sound in E-E mode

a. RF E-E

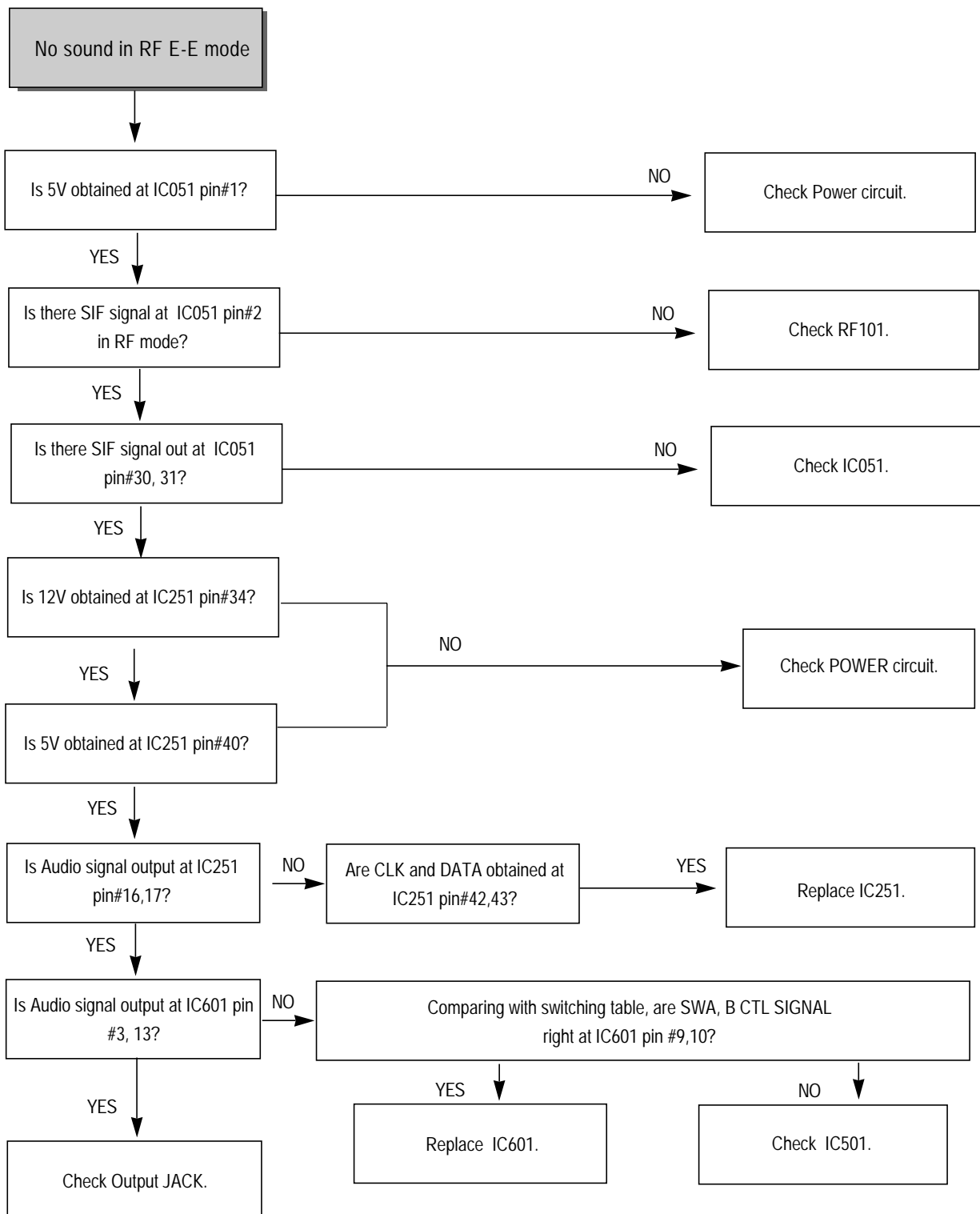

b. AV1 E-E

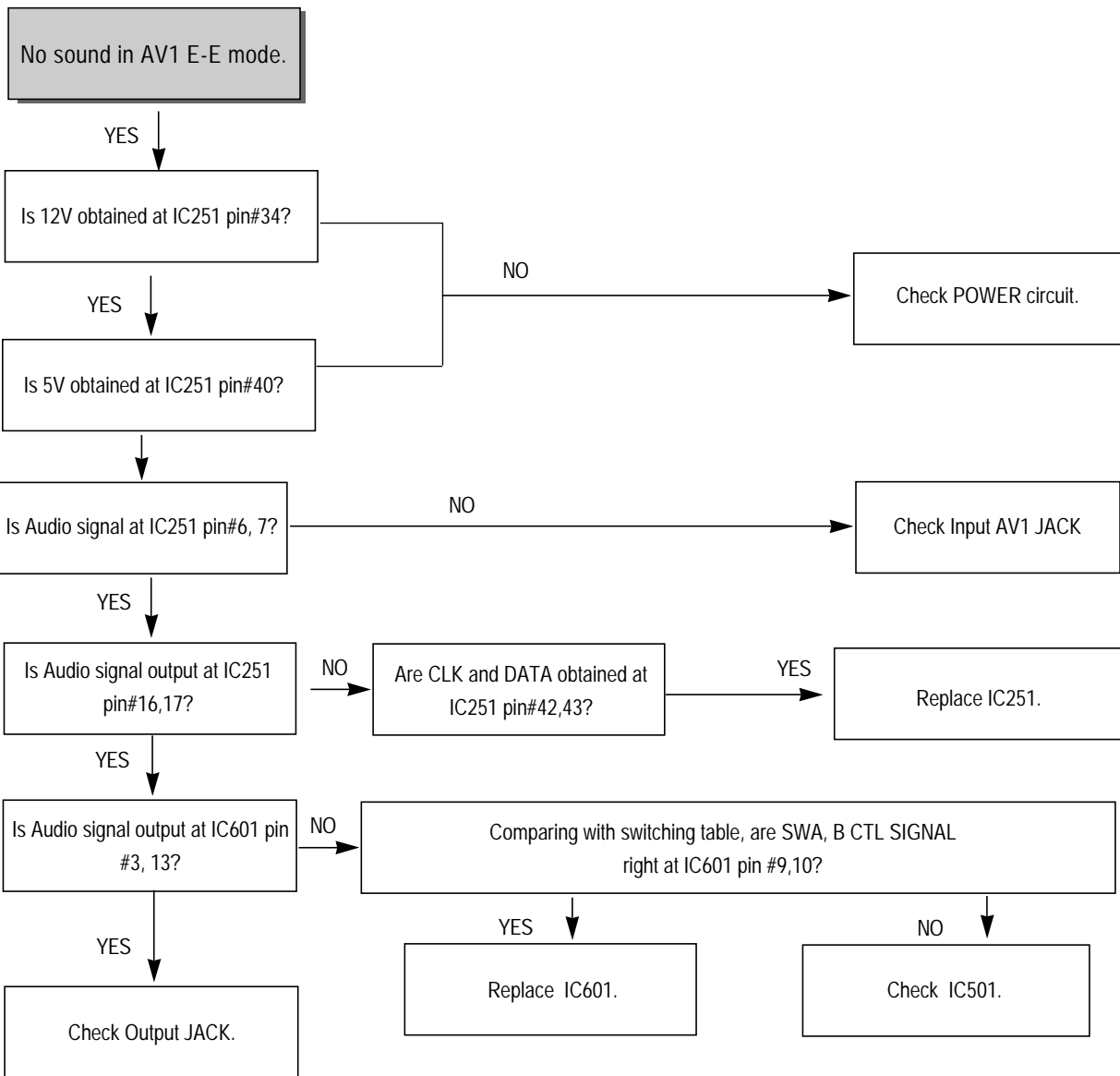

c. AV2 E-E

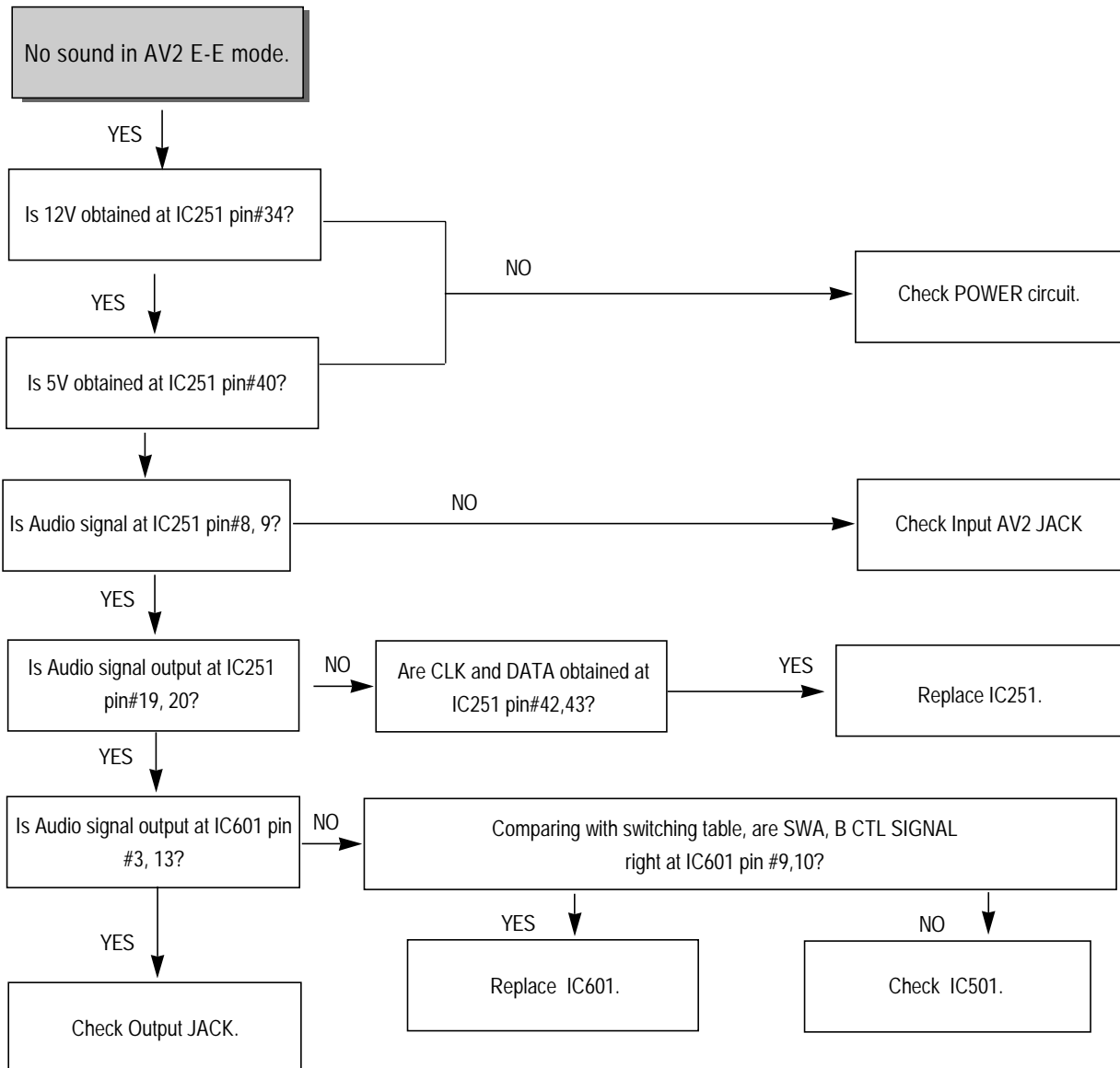

d. DVD E-E

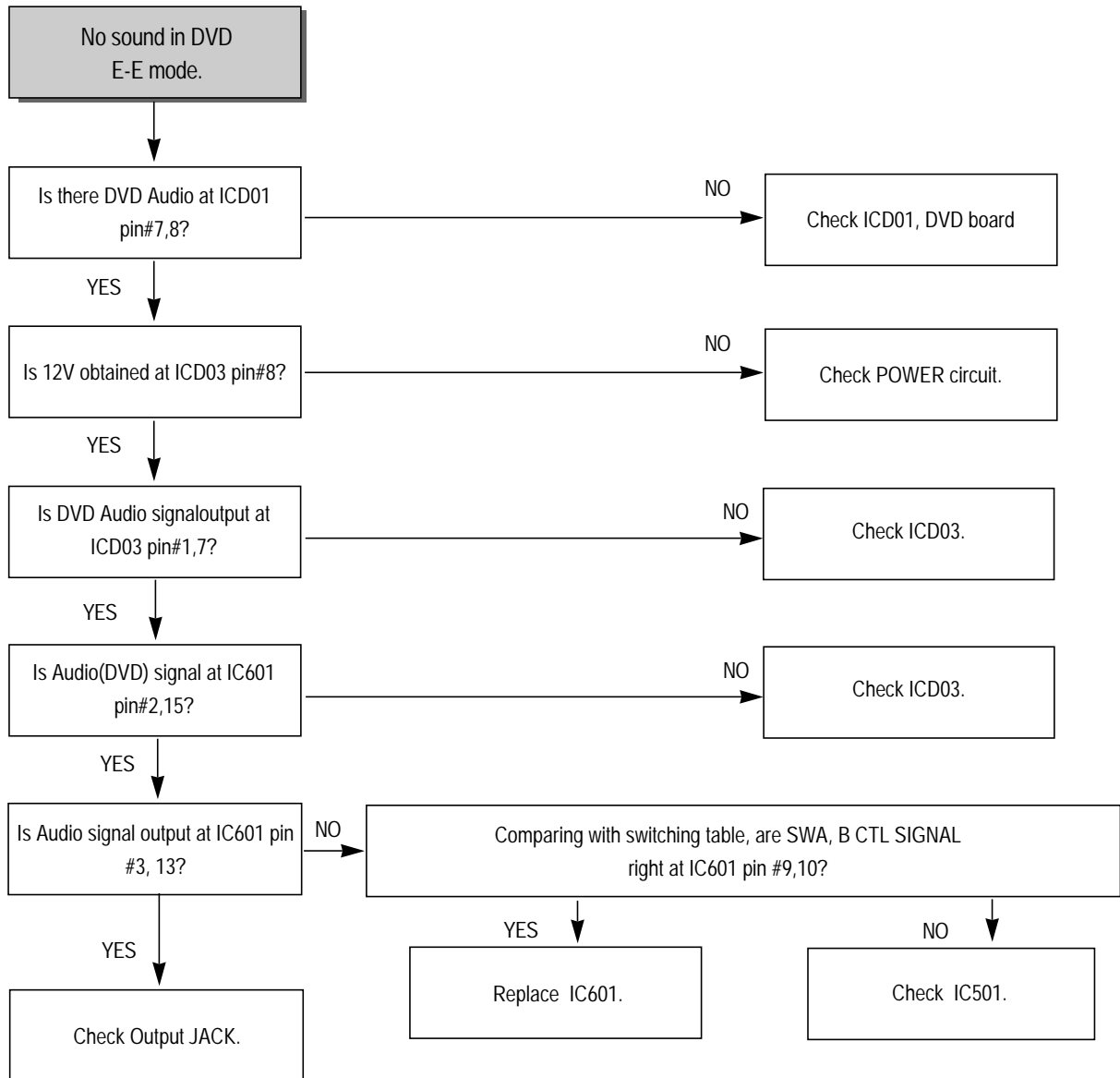

e. FRONT E-E

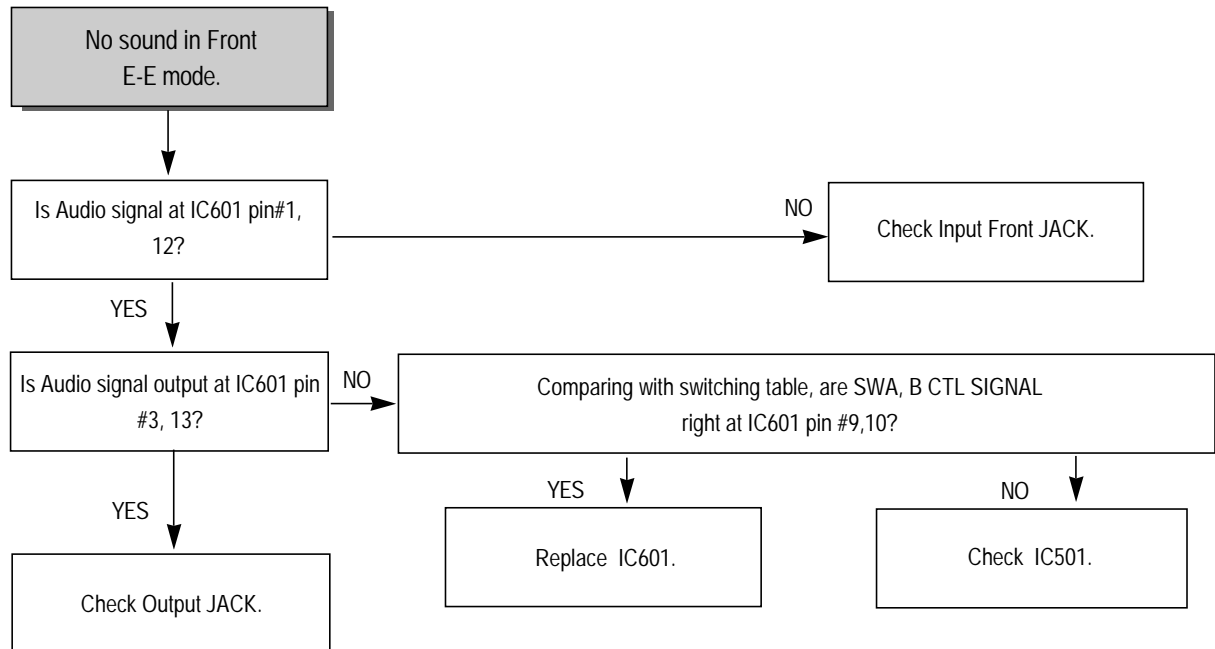

B. No Hi-Fi Playback audio(PLAY MODE)

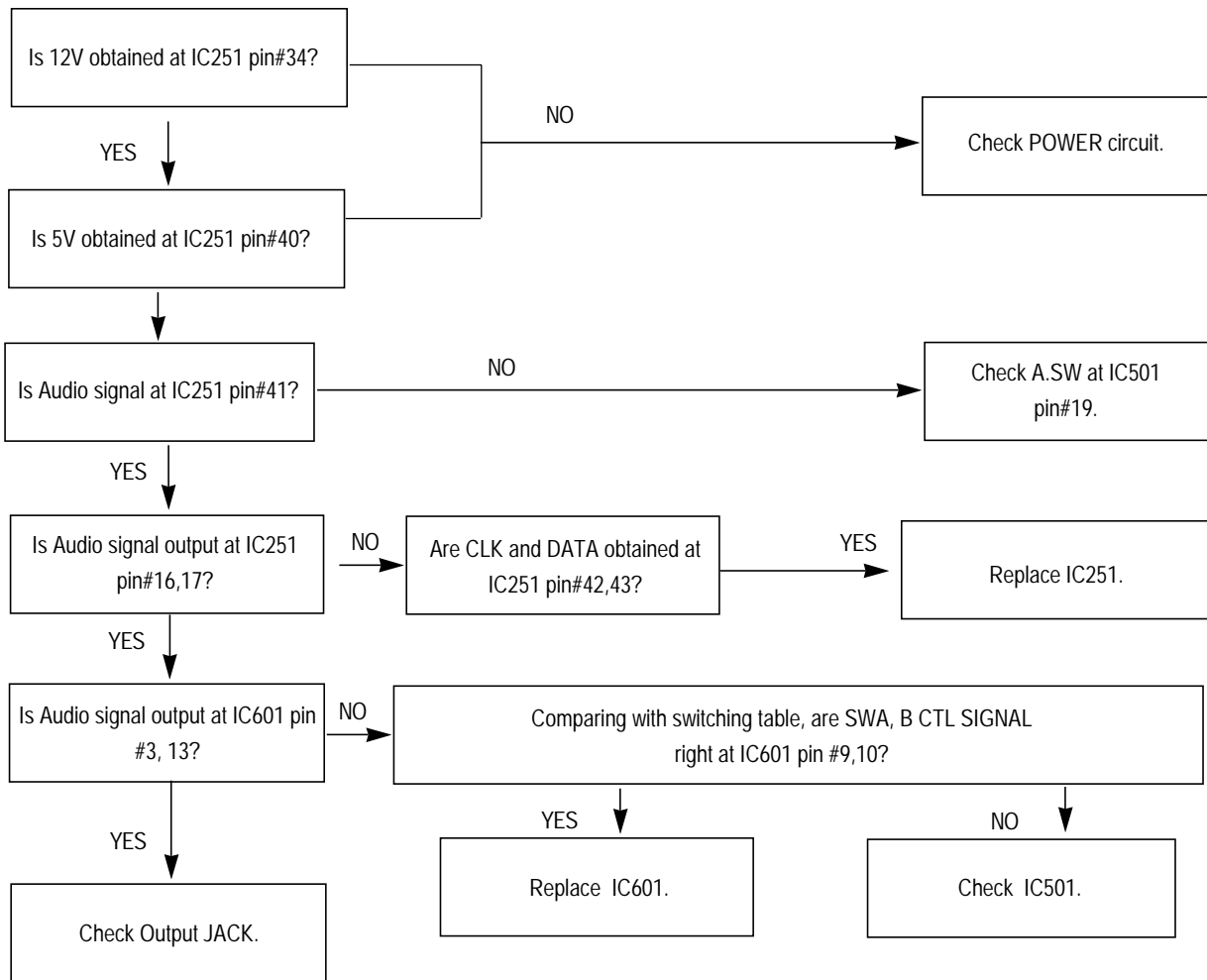

C. No Hi-Fi playback in record/playback mode (REC MODE)

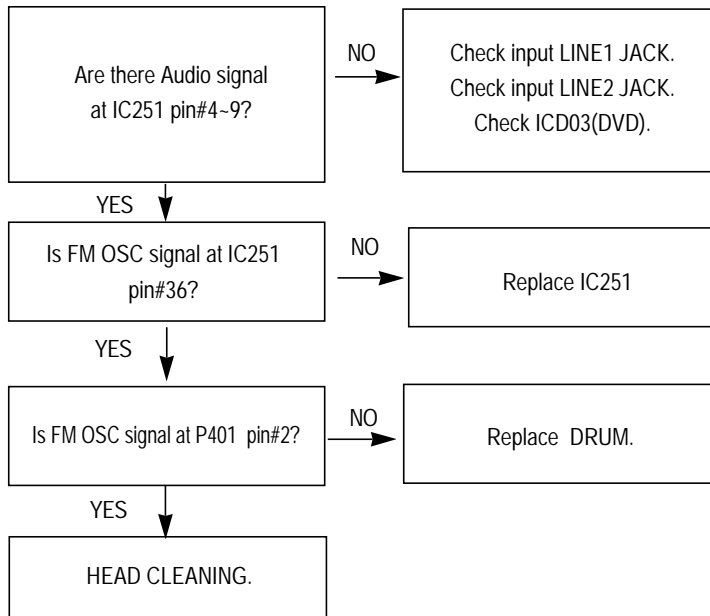

D. No NORMAL AUDIO playback (PLAY MODE)

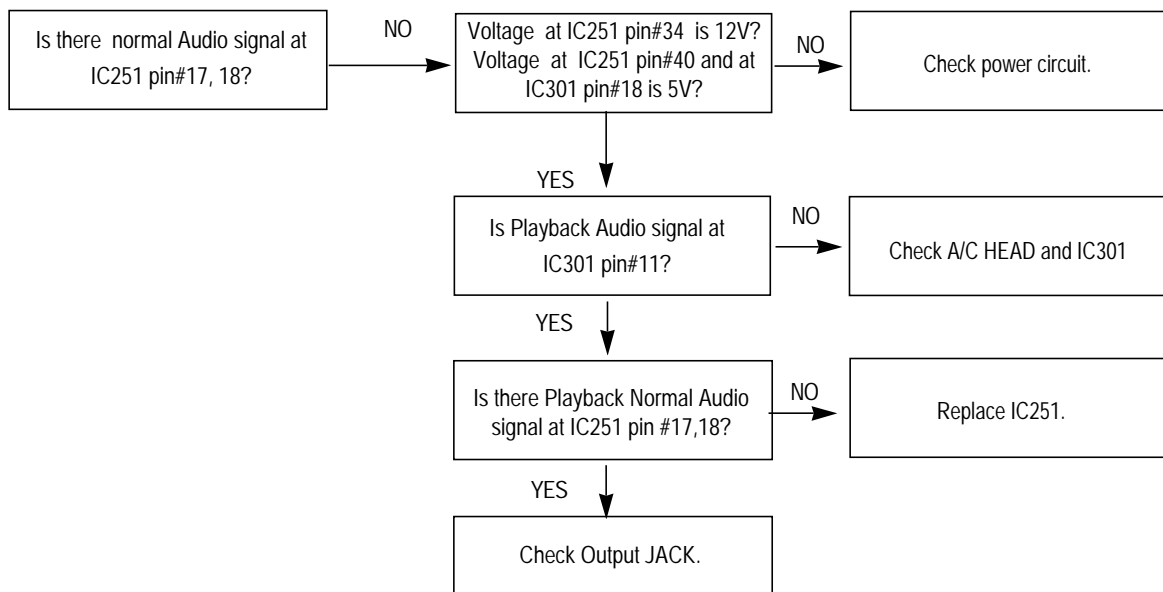

E. No NORMAL AUDIO playback in record/playback mode(Check in REC mode)

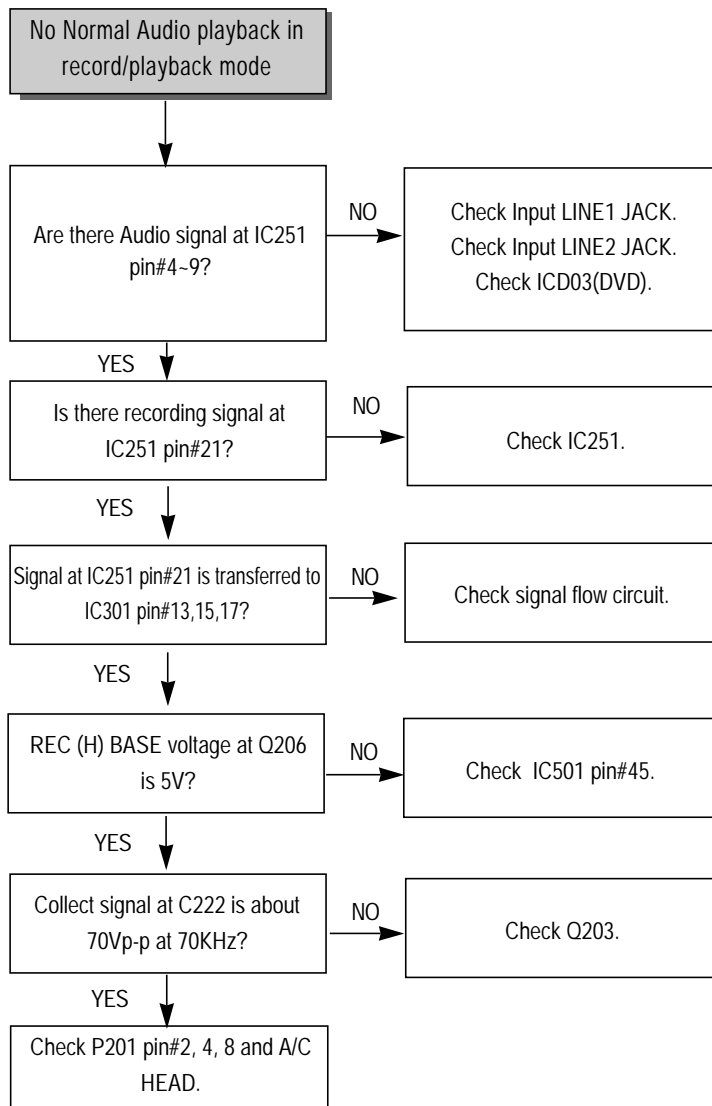

WAVEFORMS

1. VIDEO

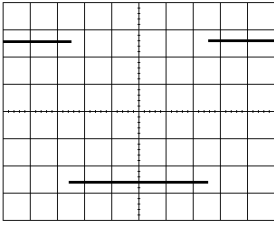

① (IC301-70) 5Vp-p
1V/2msec/cm
REC

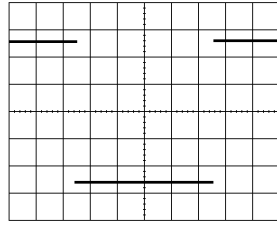

① (IC301-70) 5Vp-p
1V/2msec/cm
PLAY

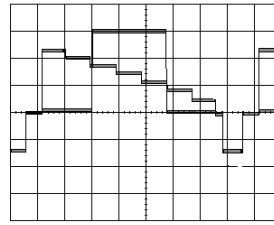

② (IC301-46) 520mVp-p
200mV/5usec/cm
REC

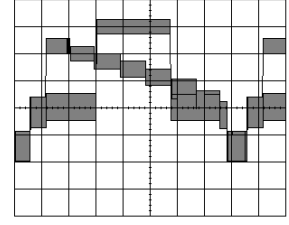

② (IC301-46) 520mVp-p
200mV/5usec/cm
PLAY

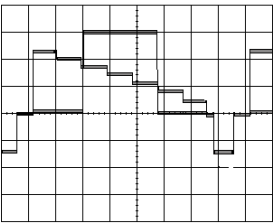

③ (IC301-43) 520mVp-p
100mV/5usec
REC

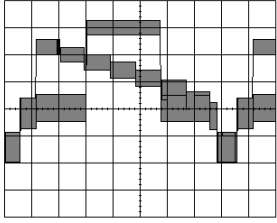

③ (IC301-43) 520mVp-p
100mV/5usec
PLAY

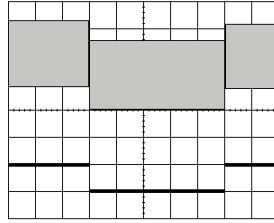

④ (IC301-21) 600mVp-p
200mV/2msec/cm
PLAY(SP) VIDEO SW TRIG

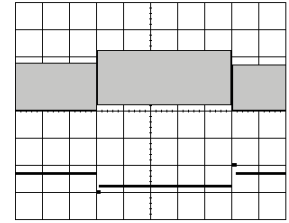

④ (IC301-21) 350mVp-p
200mV/2msec/cm
PLAY(EP) VIDEO SW TRIG

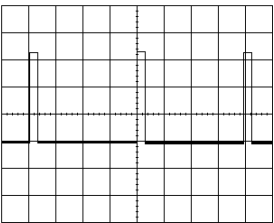

⑤ (IC301-67) 4.6Vp-p
2V/10usec/cm
REC/PLAY

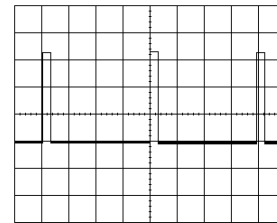

⑤ (IC301-67) 4.6Vp-p
2V/10usec/cm
PICTURE SEARCH

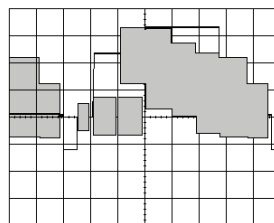

⑥ (IC301-65) 2.2Vp-p
500mV/5usec/cm
REC

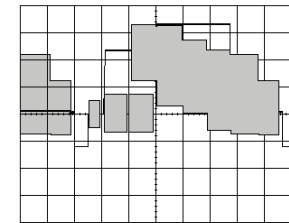

⑥ (IC301-65) 2.2Vp-p
500mV/5usec/cm
PLAY

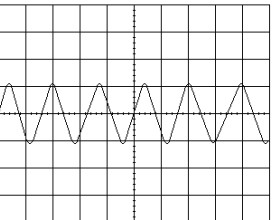

⑦ (IC301-28) 450mVp-p
200mV/0.1usec/cm

2. AUDIO

2-1 AUDIO(Normal)

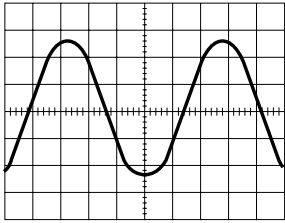

⑧ (IC301-15) 100mVp-p
20mV/0.5msec/cm
REC

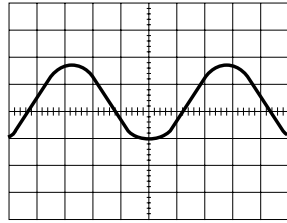

⑨ (IC301-11) 1.5Vp-p
0.5V/0.5msec/cm
REC

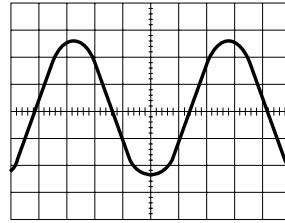

⑩ (IC301-100) 2.3Vp-p
0.5V/0.5msec/cm
REC

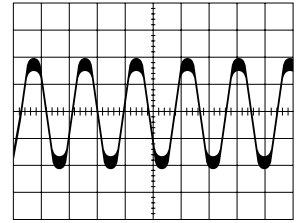

⑪ (IC301-8) 120mVp-p
50mV/0.5msec/cm
PLAY

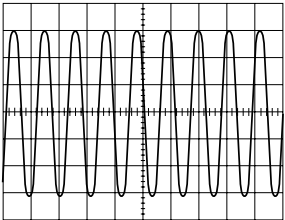

⑫ (P202-2) 75Vp-p
10V/20µsec/cm
REC

2-2 AUDIO(Hi-Fi)

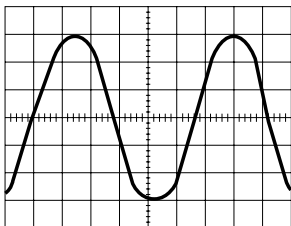

⑬ (IC251-2) 80mVp-p
20mV/0.5msec
EE/REC/PLAY

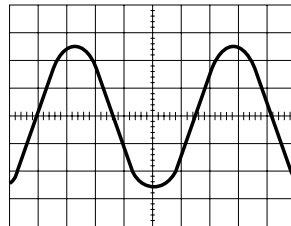

⑭ (IC251-24) 200mVp-p
50mV/0.5msec
EE/REC

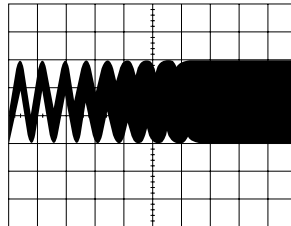

⑮ (IC251-34) 1.4Vp-p
0.5V/1msec
REC

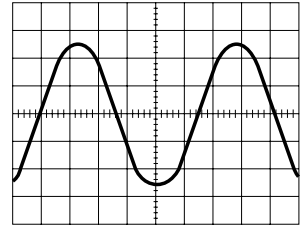

⑯ (IC251-32) 200mVp-p
50mV/0.5msec
EE/REC

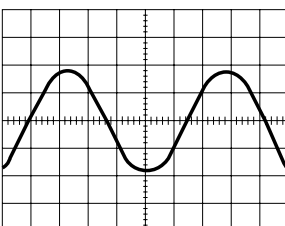

⑰ (IC251-16) 1.4Vp-p
0.5V/0.5msec
EE/REC

3. SERVO/SYSCON

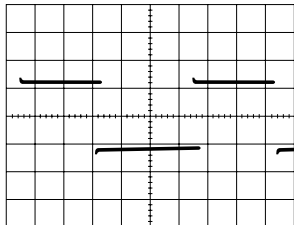

18 (IC501-18) 5Vp-p
2V/5msec/cm
REC/PLAY

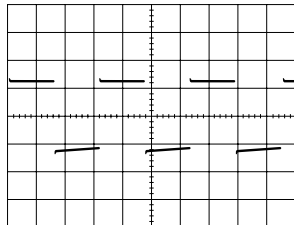

19 (IC501-77) 5Vp-p
2V/5µsec/cm
REC/PLAY

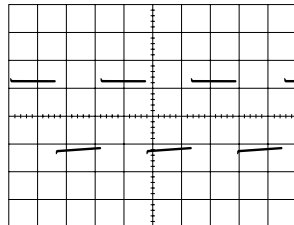

20 (IC501-76) 5Vp-p
2V/5µsec/cm
REC/PLAY

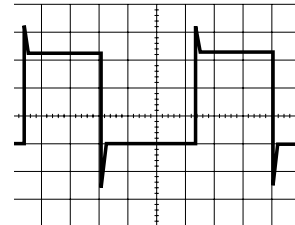

21 (IC501-94) 3Vp-p
1V/5msec/cm
REC

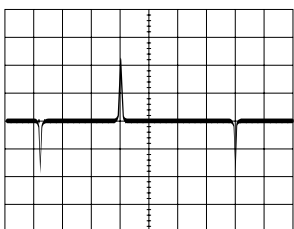

22 (IC501-97) 4.4Vp-p
1V/5msec/cm
PLAY

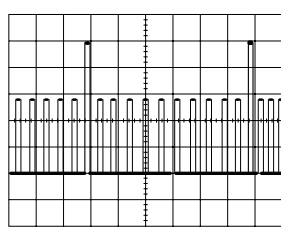

23 (IC501-90) 25Vp-p & 5Vp-p
1V/5msec/cm
REC/PLAY

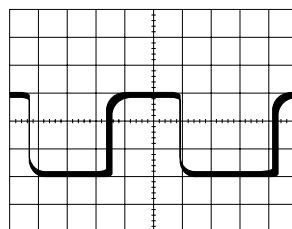

24 (IC501-87) 2.5Vp-p
1V/0.2msec/cm
REC/PLAY

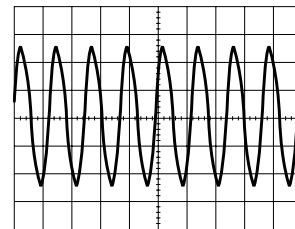

25 (IC501-38) 2.6Vp-p
0.5V/0.1µsec/cm
REC/PLAY

CIRCUIT DIAGRAM

1. POWER SUPPLY CIRCUIT DIAGRAM

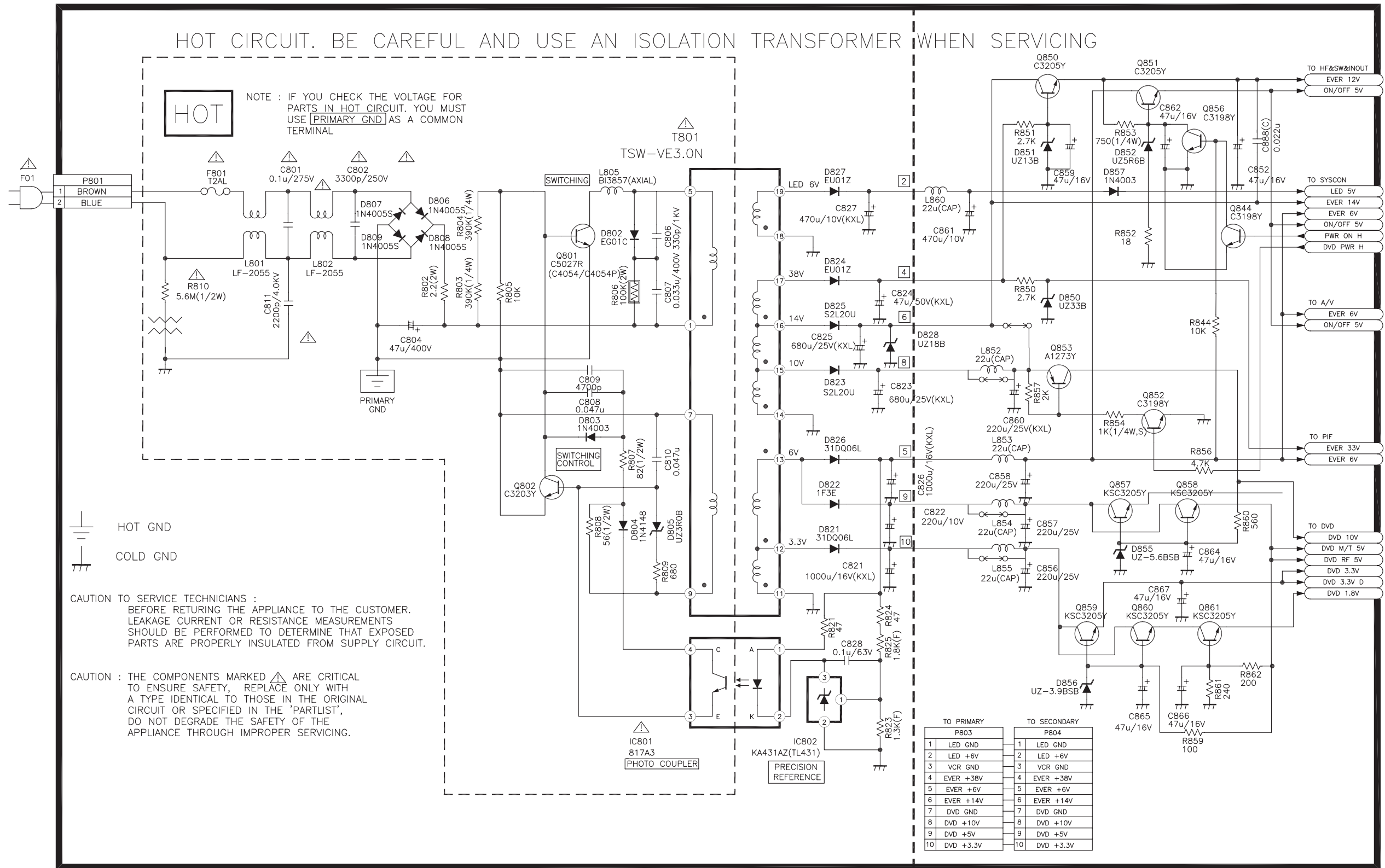

2. SERVO & SYSCON CIRCUIT DIAGRAM

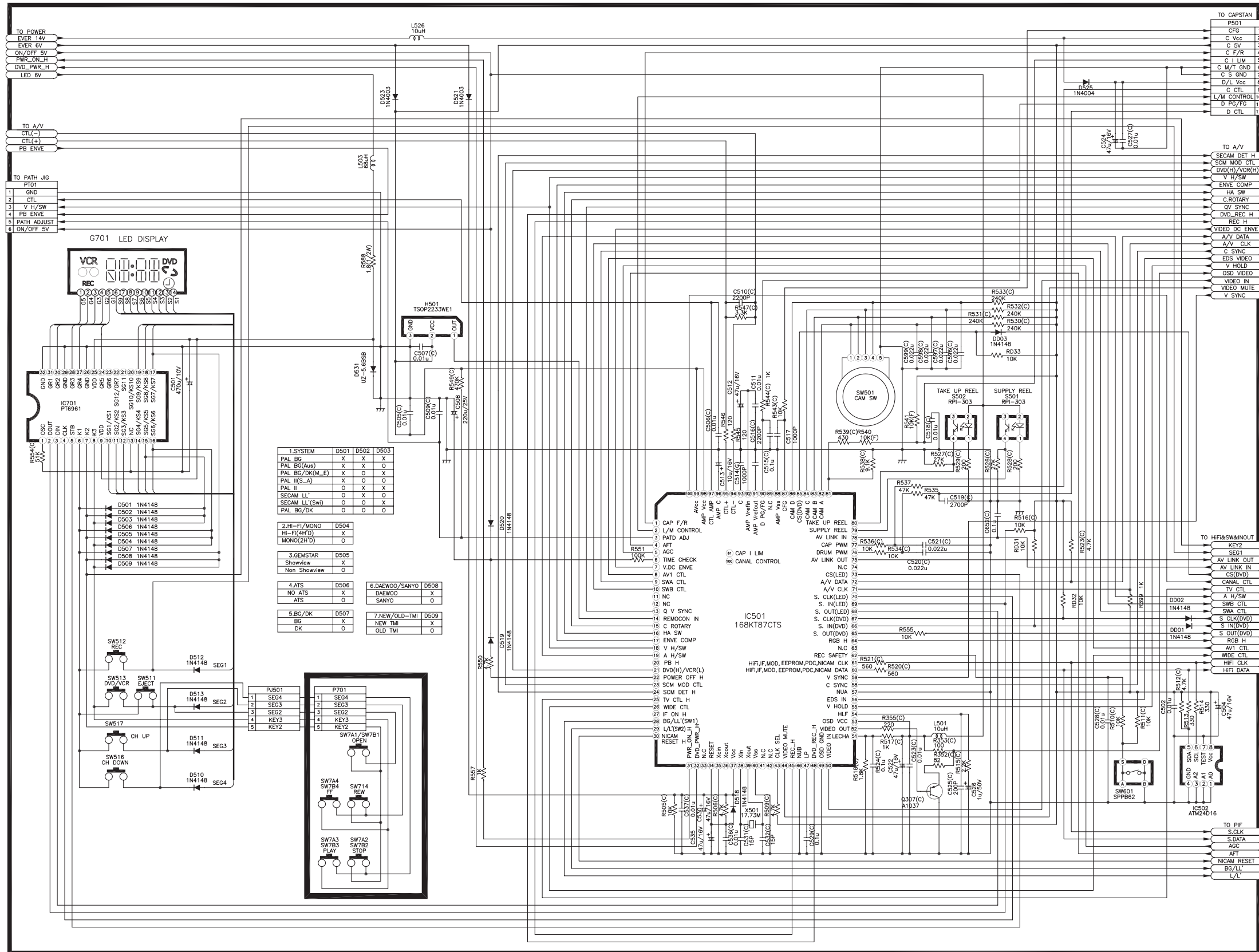

3. VIDEO/AUDIO CIRCUIT DIAGRAM

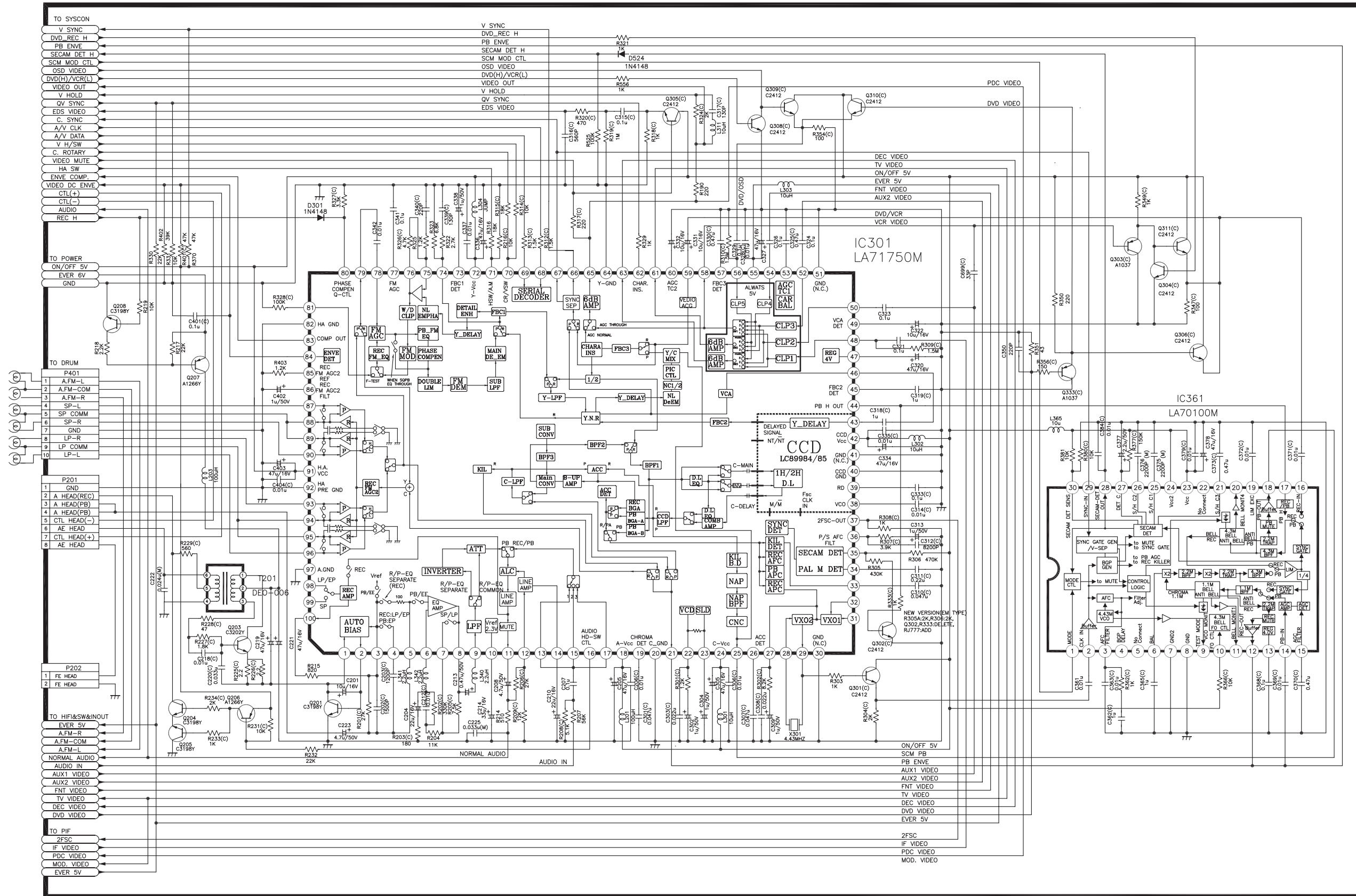

4. HiFi & SW & INPUT CIRCUIT DIAGRAM

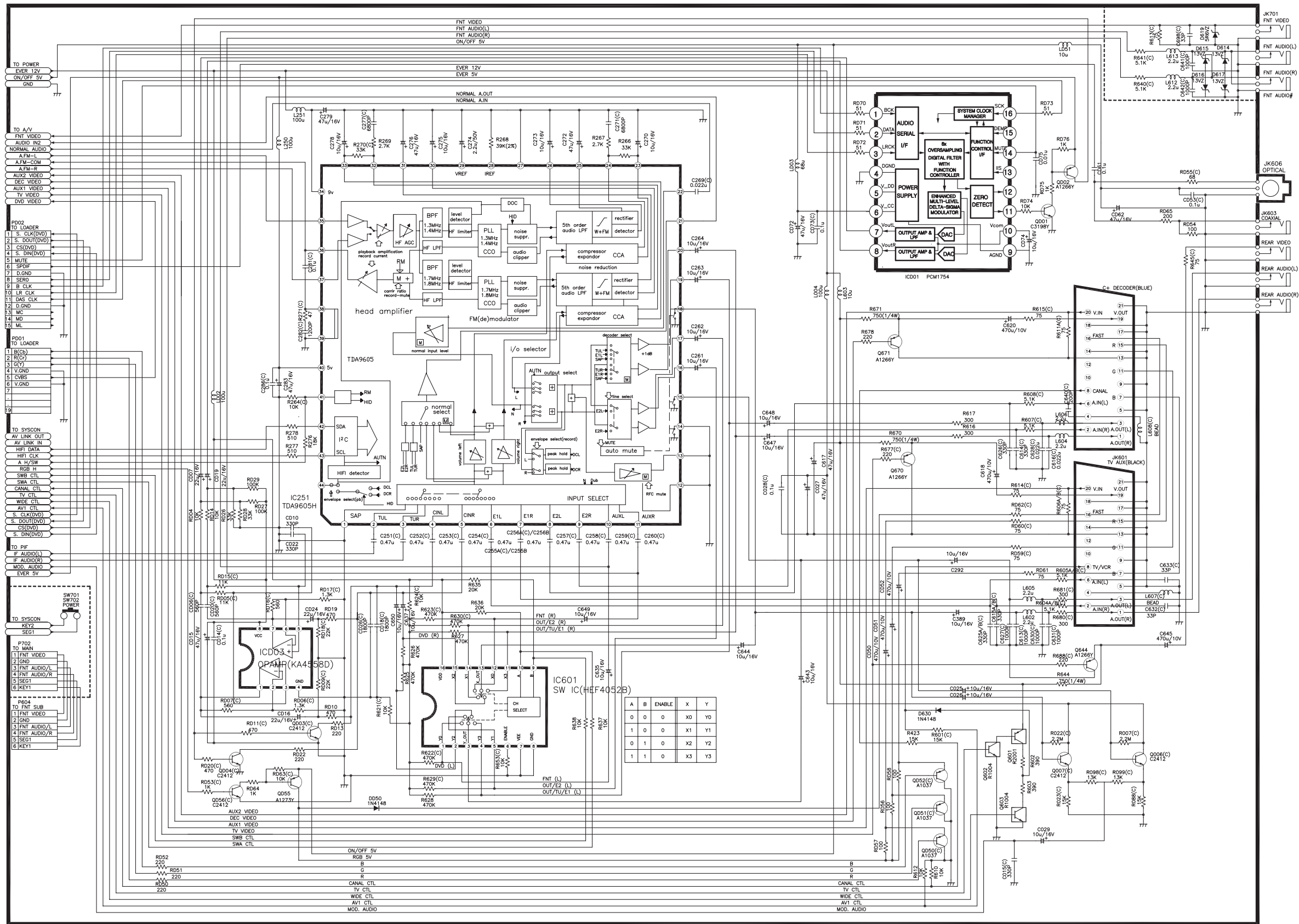

5. PIF CIRCUIT DIAGRAM

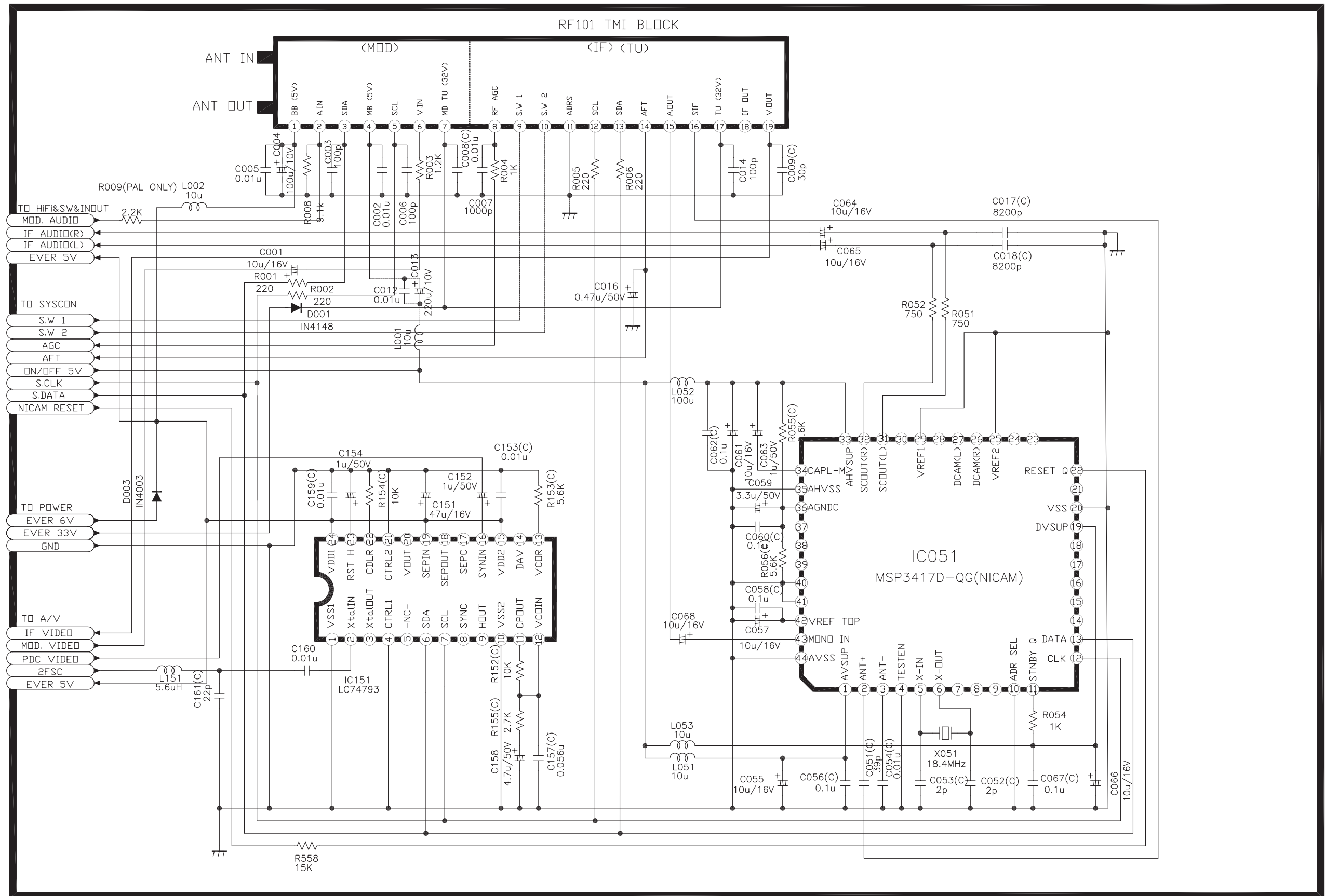

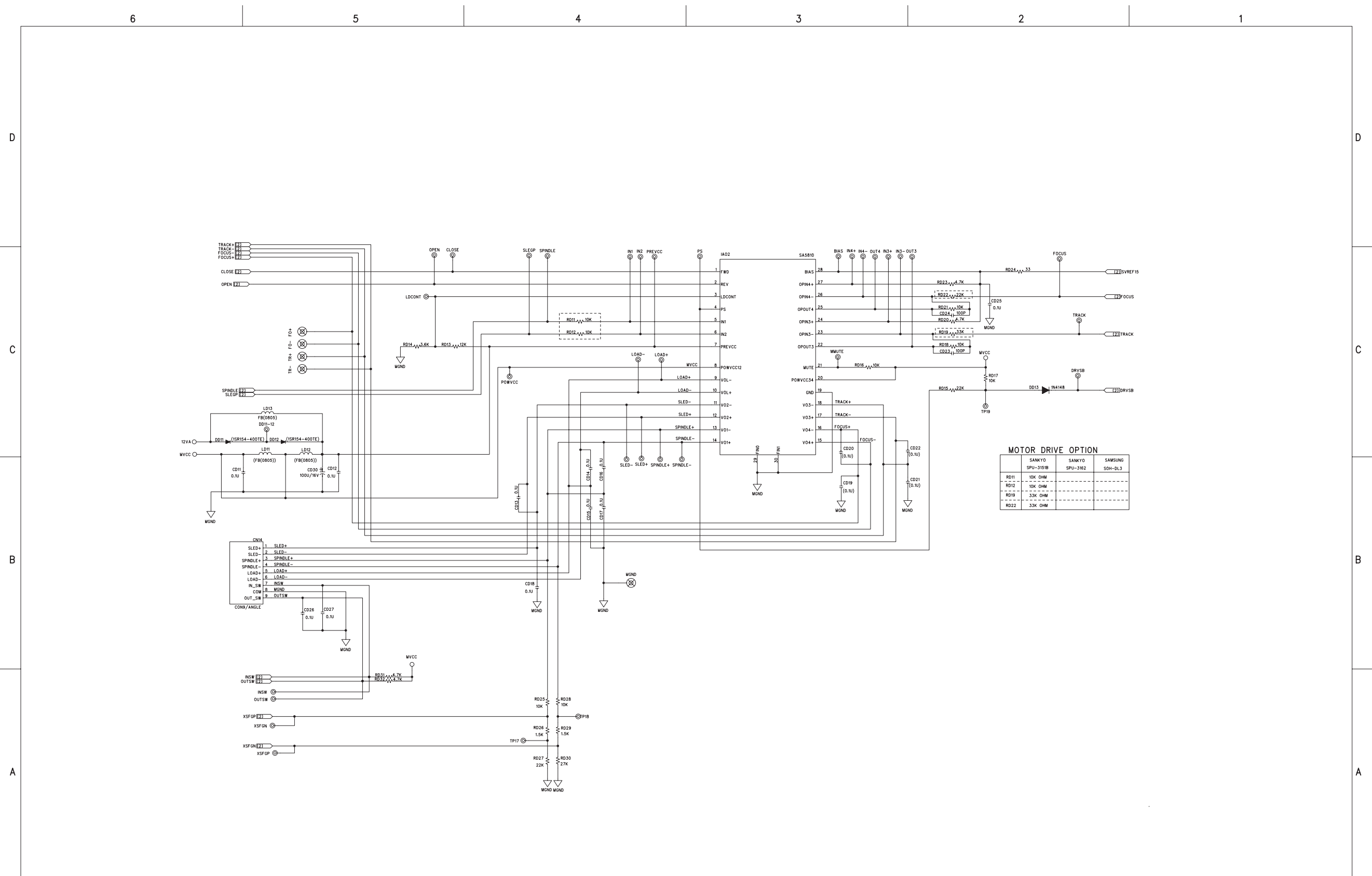

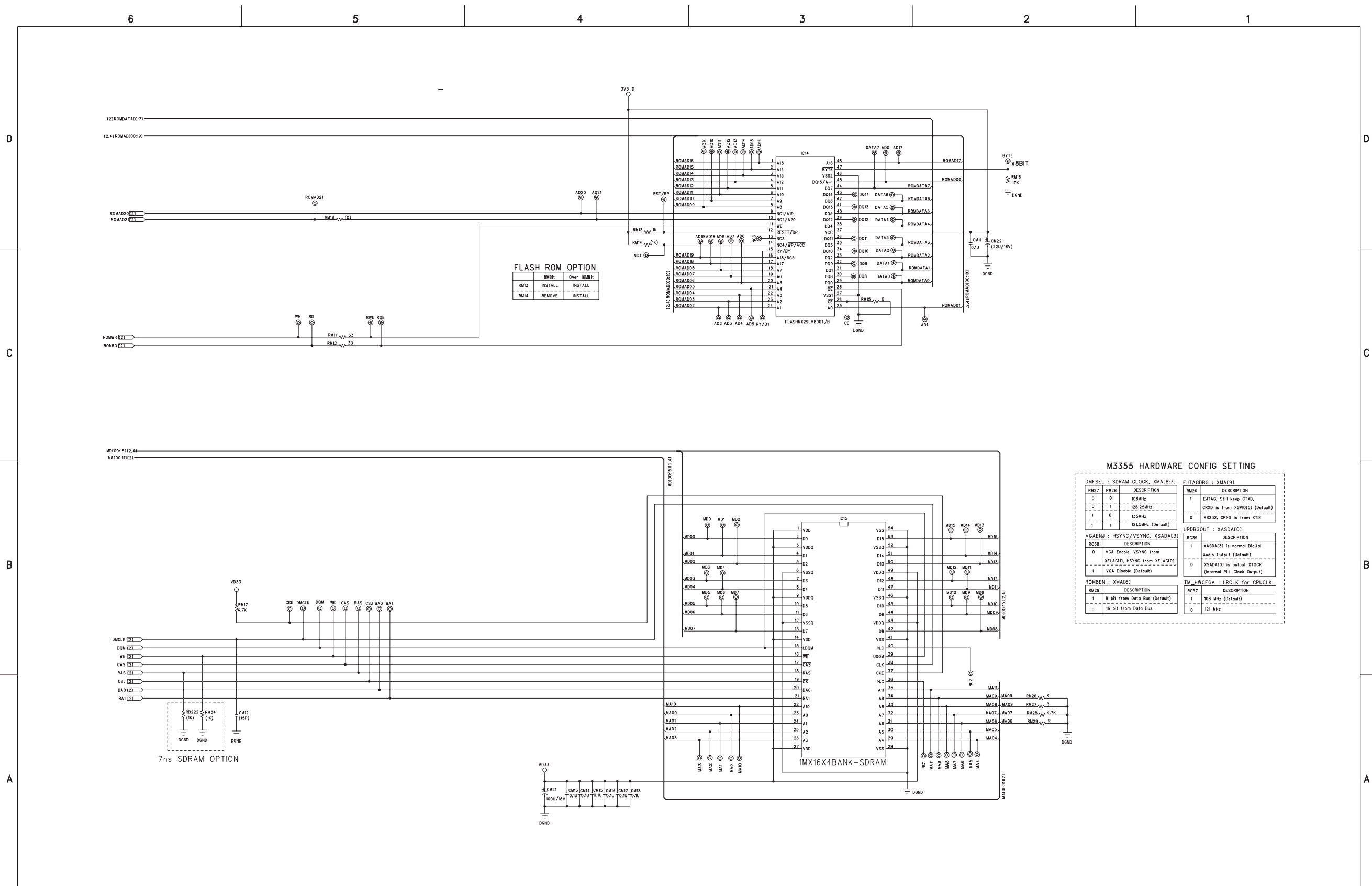

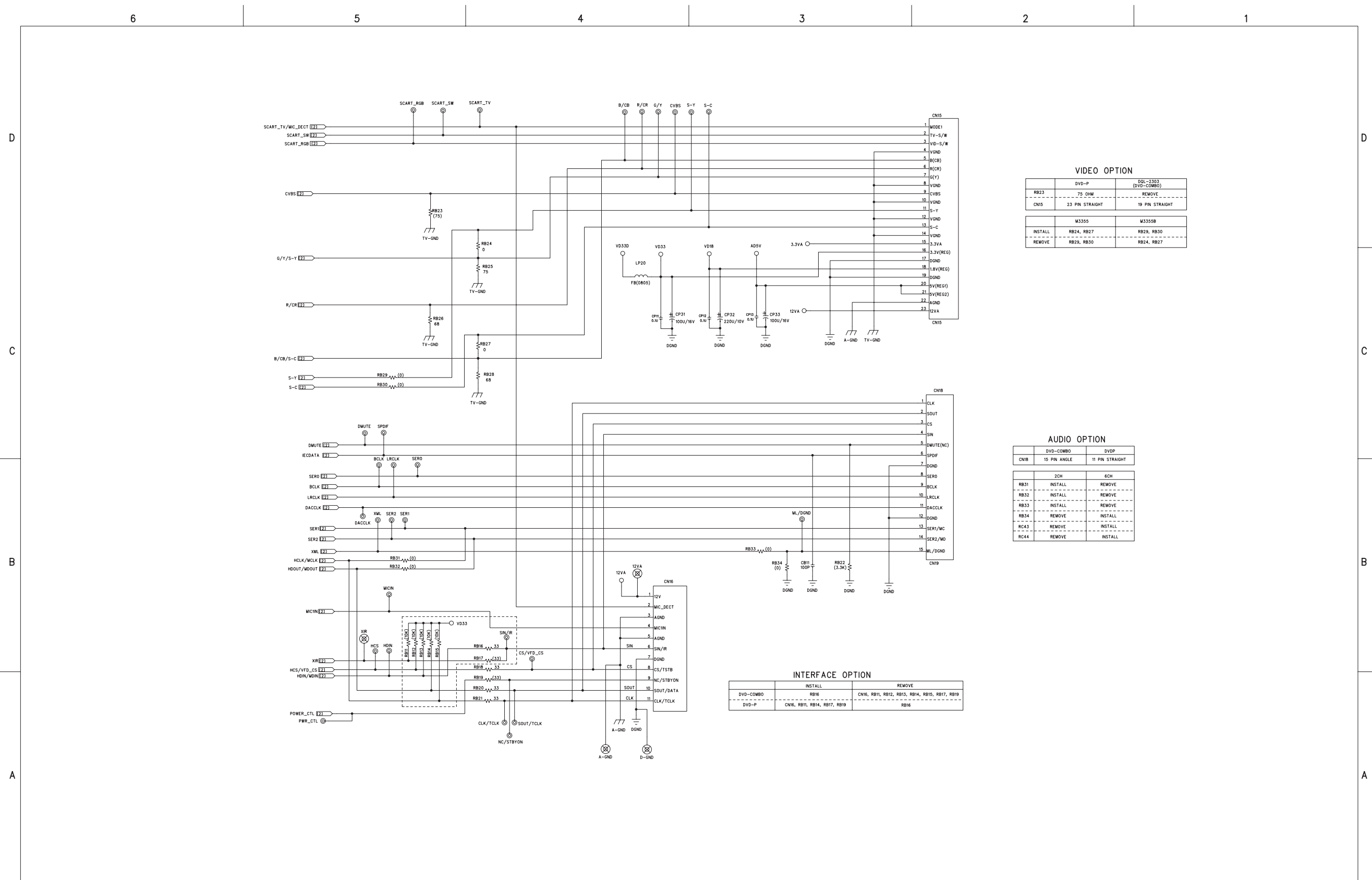

VIDEO OPTION

	DVD-P	D9L-1303 (DVD-COMBO)
RB25	75 OHM	REMOVE
CN15	23 PIN STRAIGHT	19 PIN STRAIGHT

	M3355	M3355B
INSTALL	RB24, RB27	RB29, RB30
REMOVE	RB29, RB30	RB24, RB27

AUDIO OPTION

	DVD-COMBO	DVDP
CN18	15 PIN ANGLE	11 PIN STRAIGHT

	2CH	8CH
RB31	INSTALL	REMOVE
RB32	INSTALL	REMOVE
RB33	INSTALL	REMOVE
RB34	REMOVE	INSTALL
RC43	REMOVE	INSTALL
RC44	REMOVE	INSTALL

INTERFACE OPTION

	INSTALL	REMOVE
DVD-COMBO	RB16	CN16, RB11, RB12, RB13, RB14, RB15, RB17, RB19
DVD-P	CN16, RB11, RB14, RB17, RB19	RB16

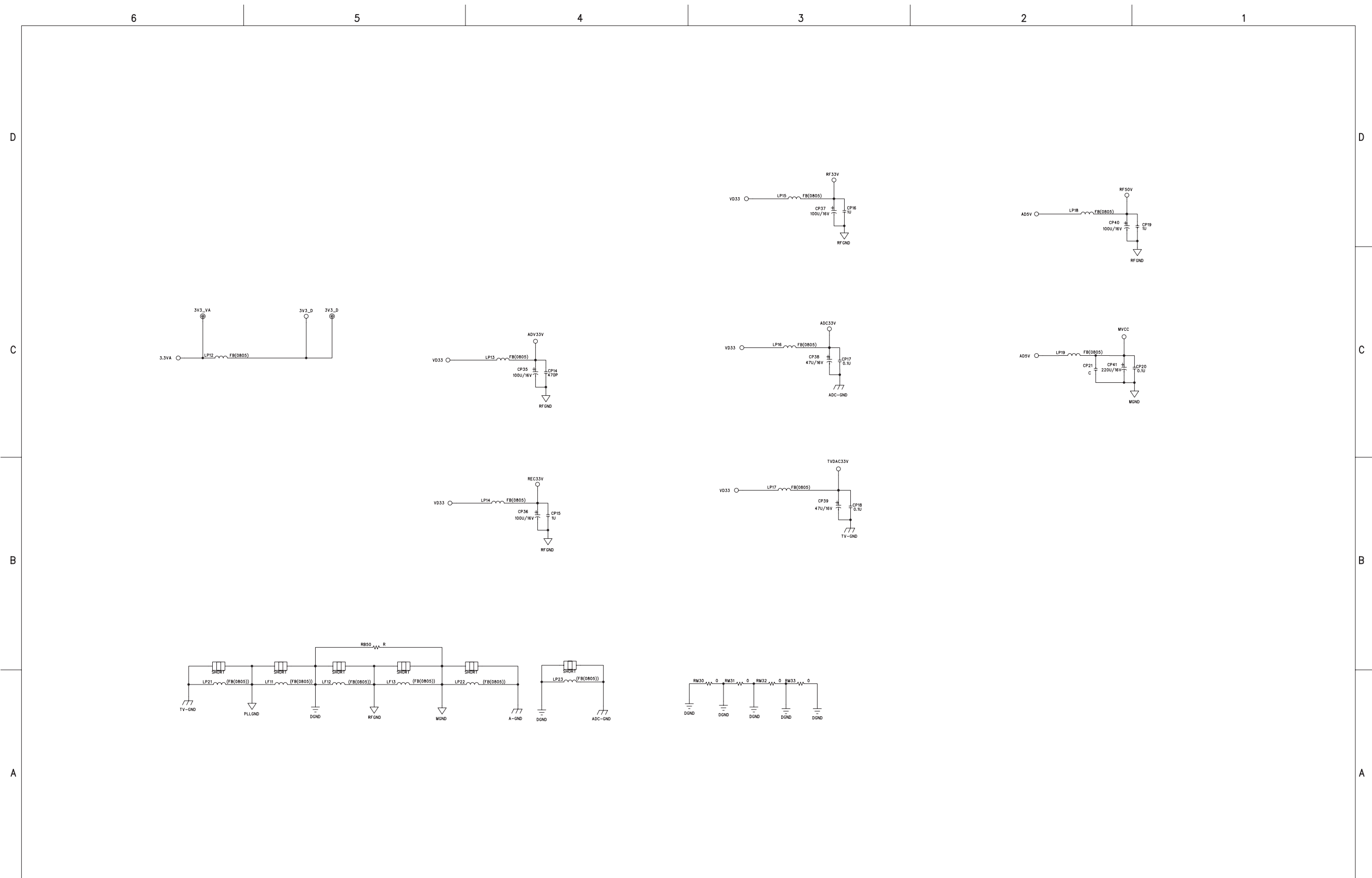

PCB CIRCUIT BOARD

1-1 . VCR (MAIN)

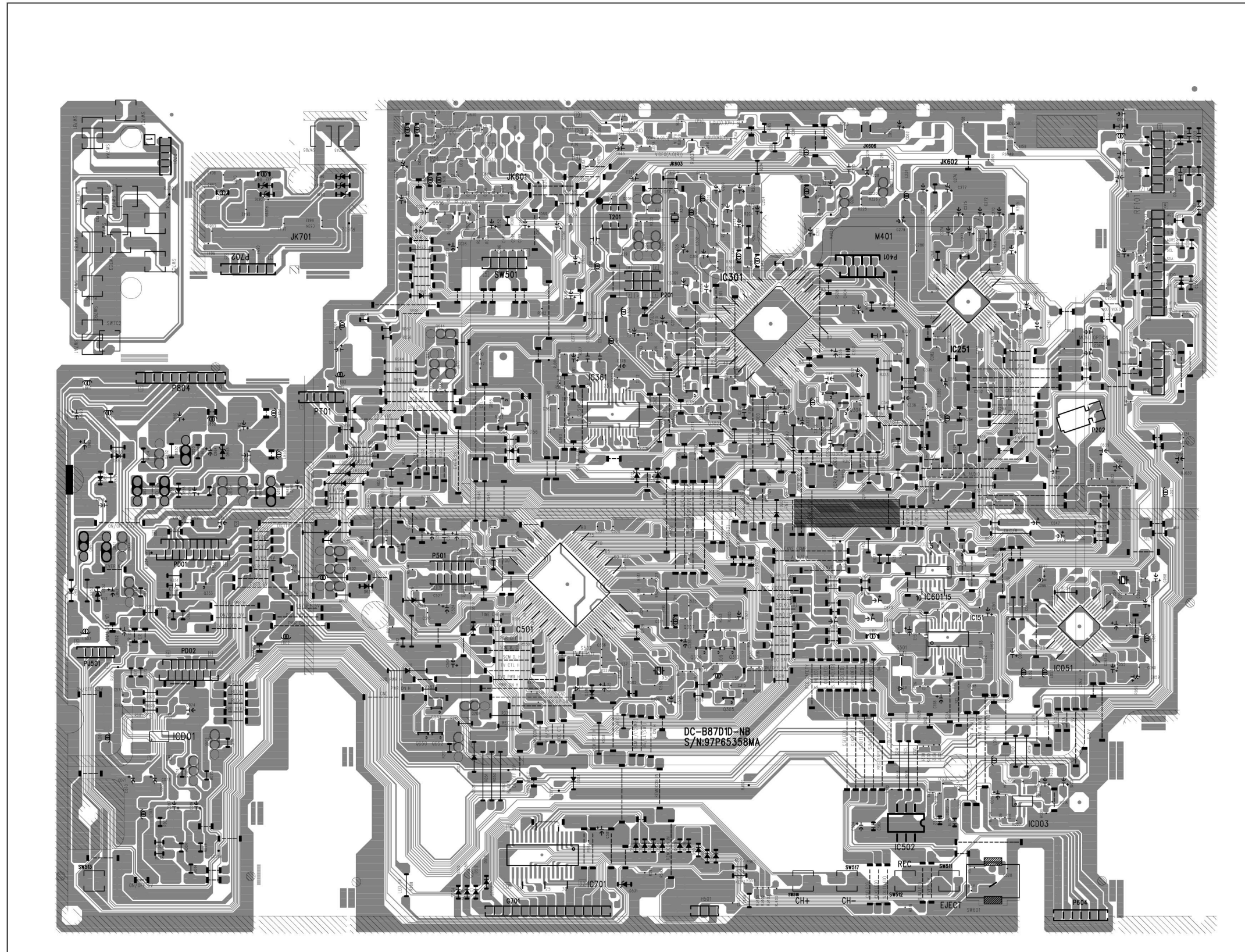

1-2. POWER

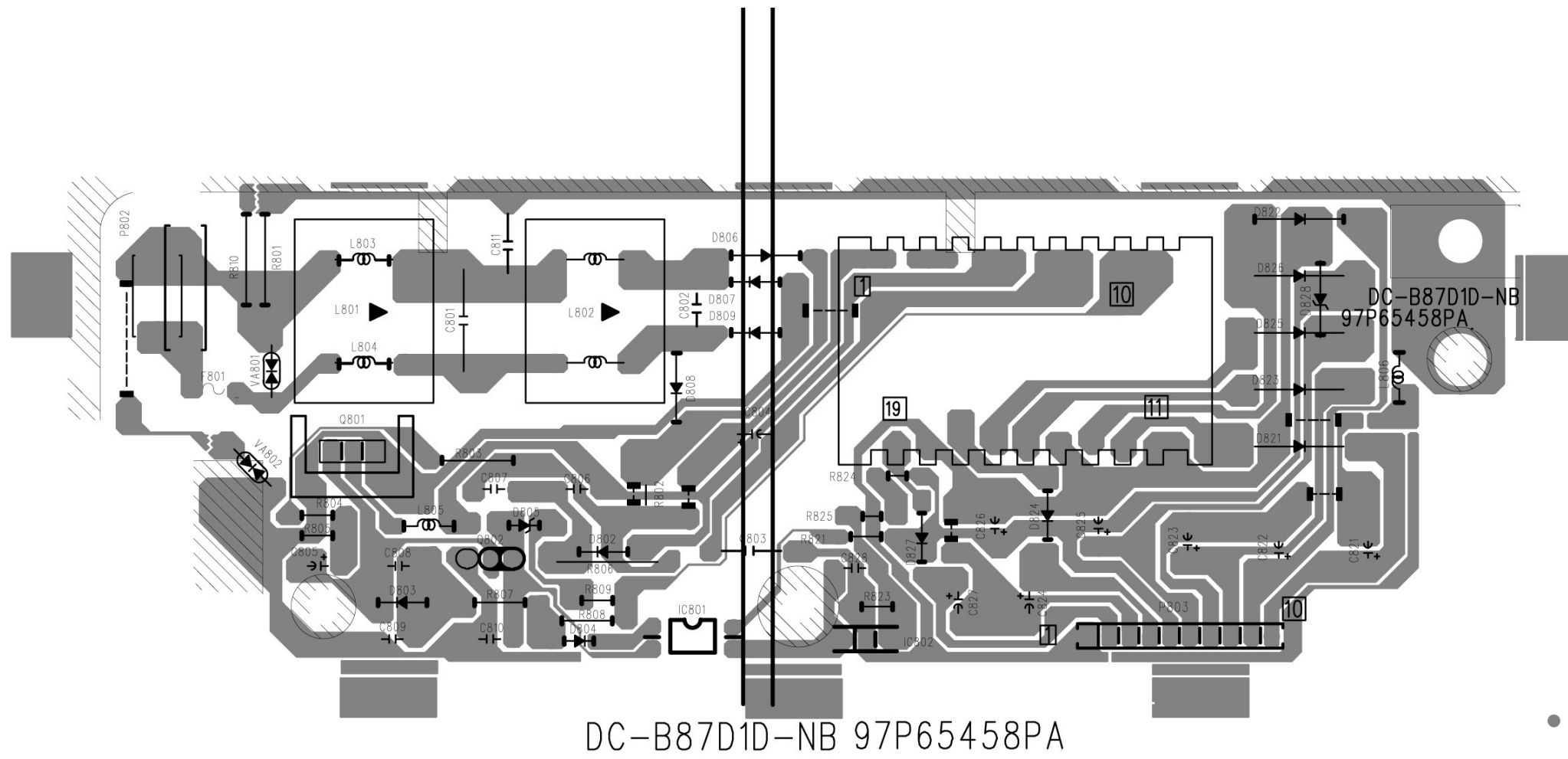

1-3. DVD (MAIN)

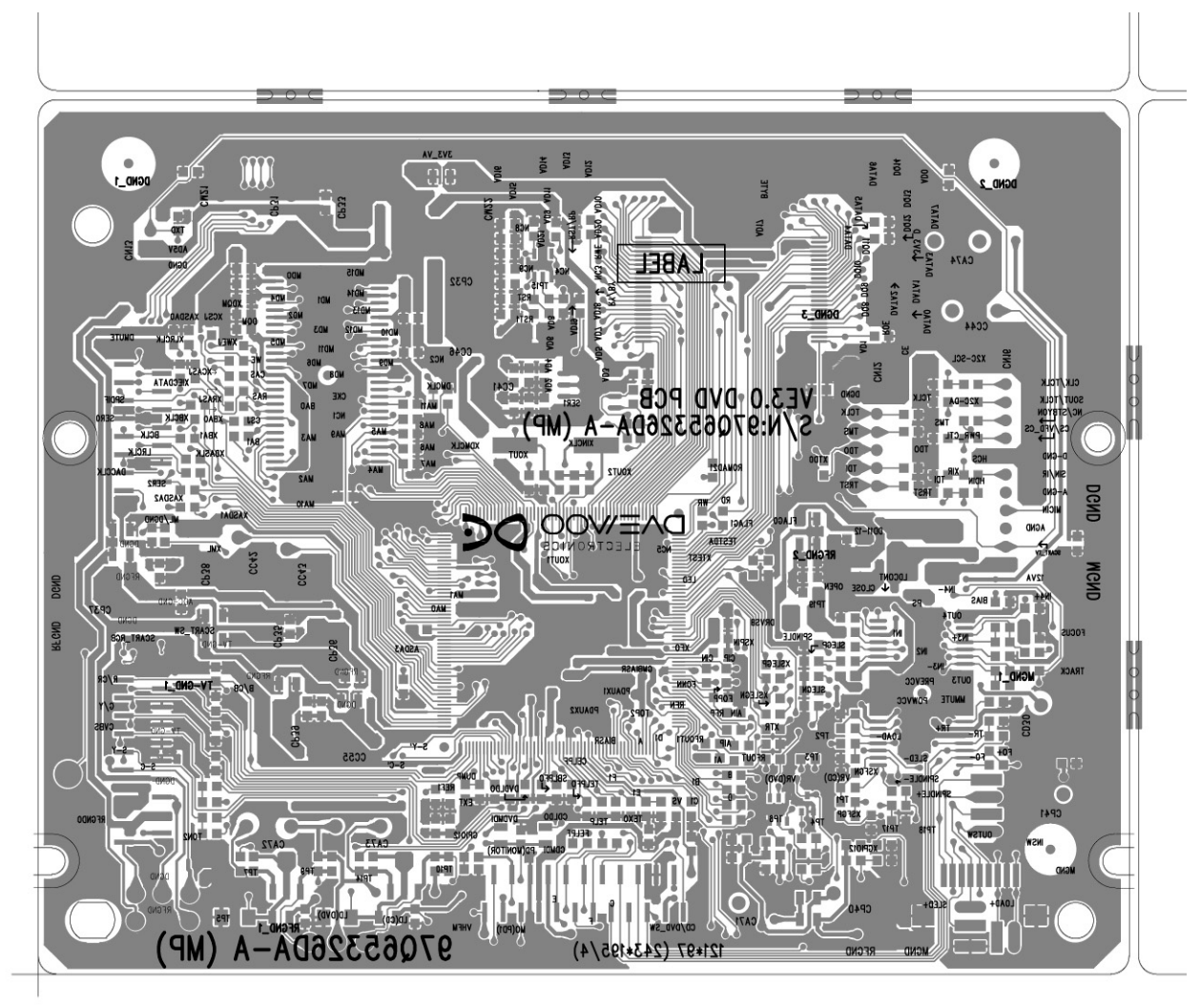
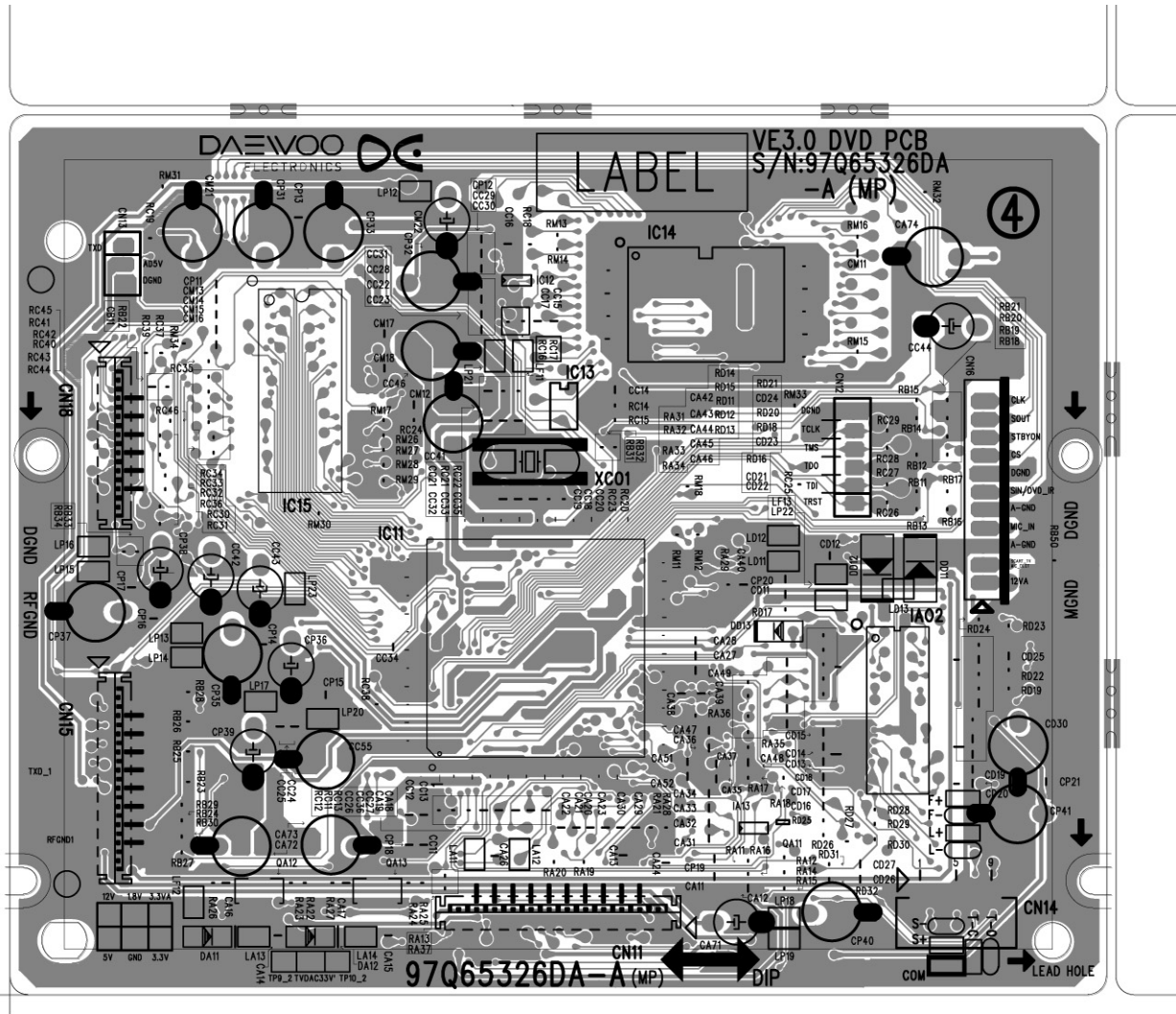

INSTRUMENT DISASSEMBLY

1. DECK DISASSEMBLY

Perform all disassembly procedures in the order presented.

When reassembling, use the reverse procedure.

Make sure that all leads/ wiring are routed correctly when reassembling.

A. TOP COVER REMOVAL

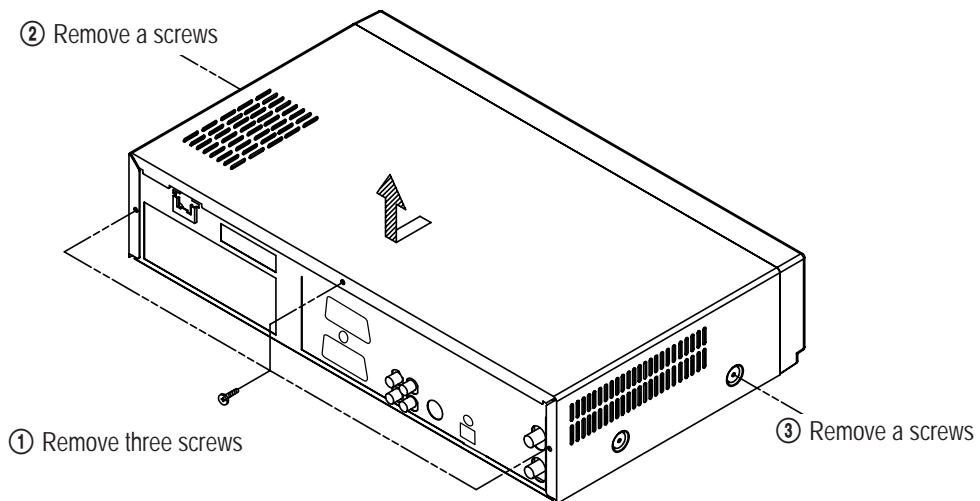

FIG. 1

B. PANEL FRONT DISASSEMBLY

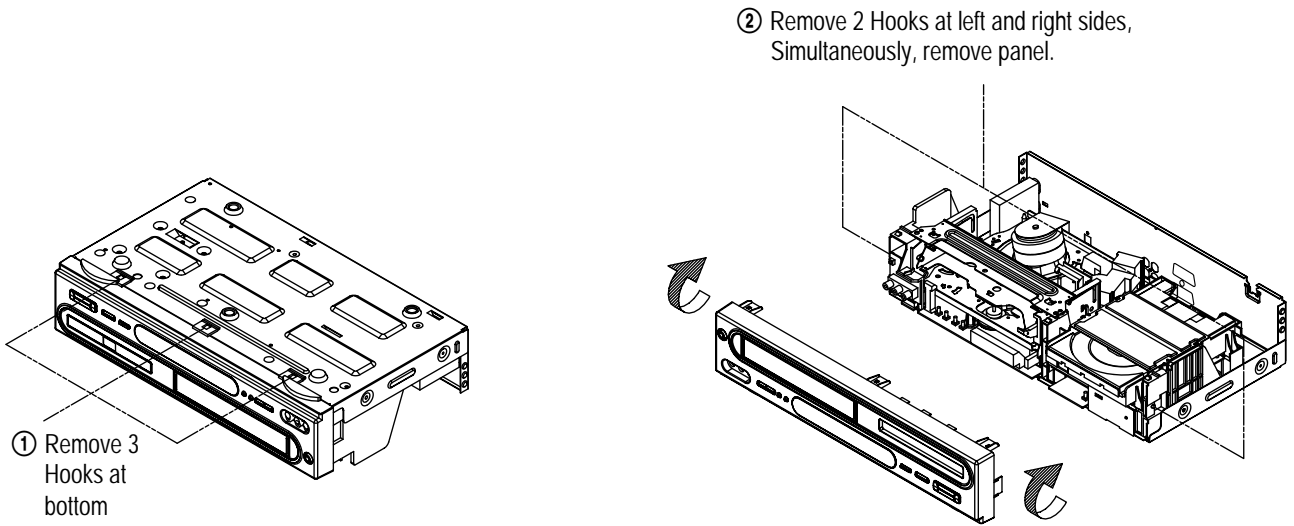

FIG.2

C. LOGIC PCB DISASSEMBLY

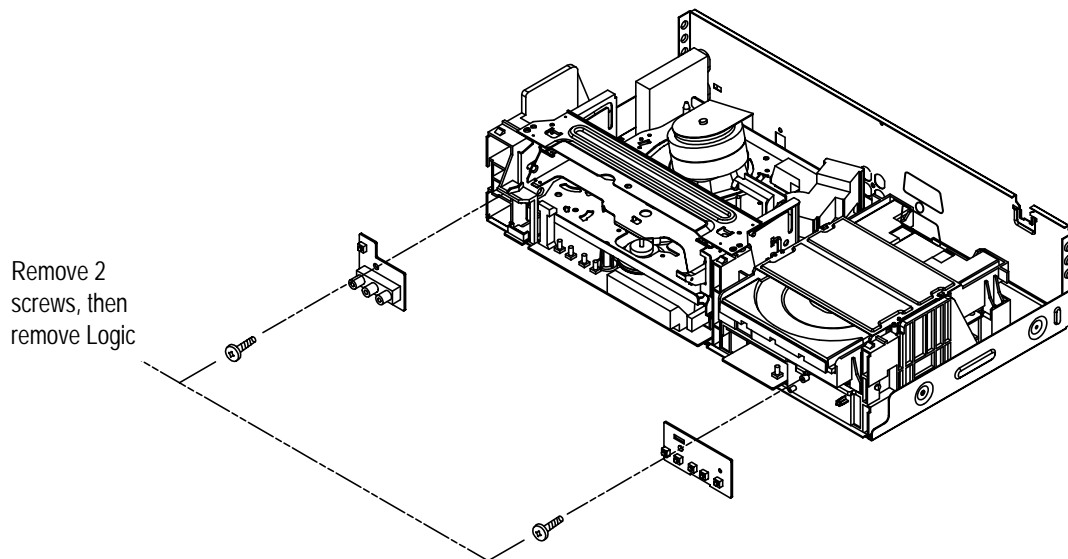
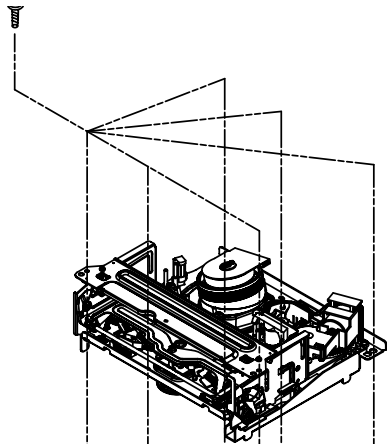

FIG.3

D. DECK AND MAIN PARTS DISASSEMBLY

① Remove 6 screws, then remove DECK



② Remove 4 screws, then remove LOADER

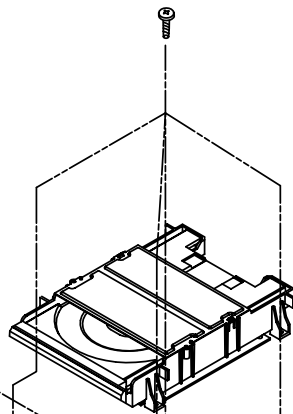

③ Remove 3 screws, then remove POWER PCB

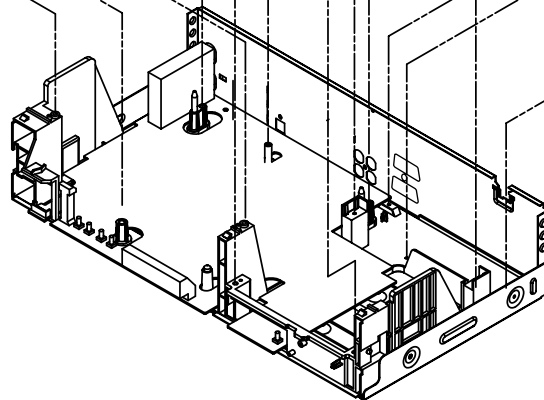
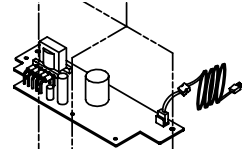

FIG. 4

E. MAIN PCB DISASSEMBLY

② Remove 2 screws, then remove MAIN PCB

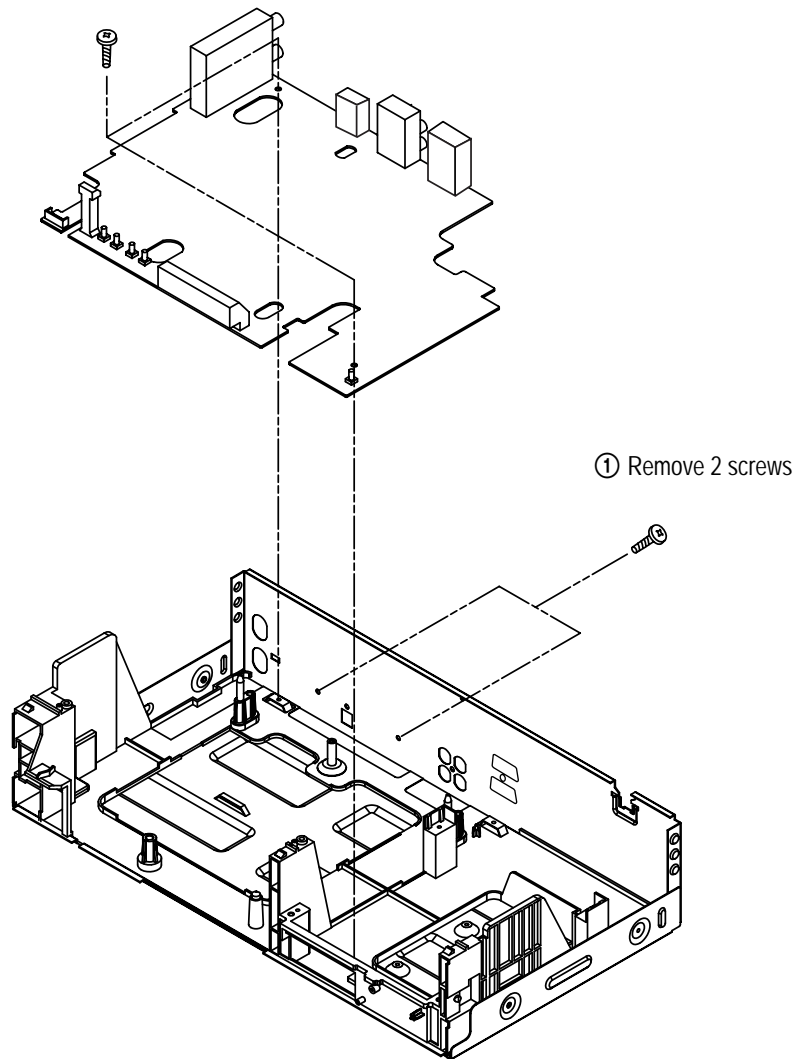

FIG. 5

F. MAIN CHASSIS DISASSEMBLY

① Remove 4 screws, then remove MAIN

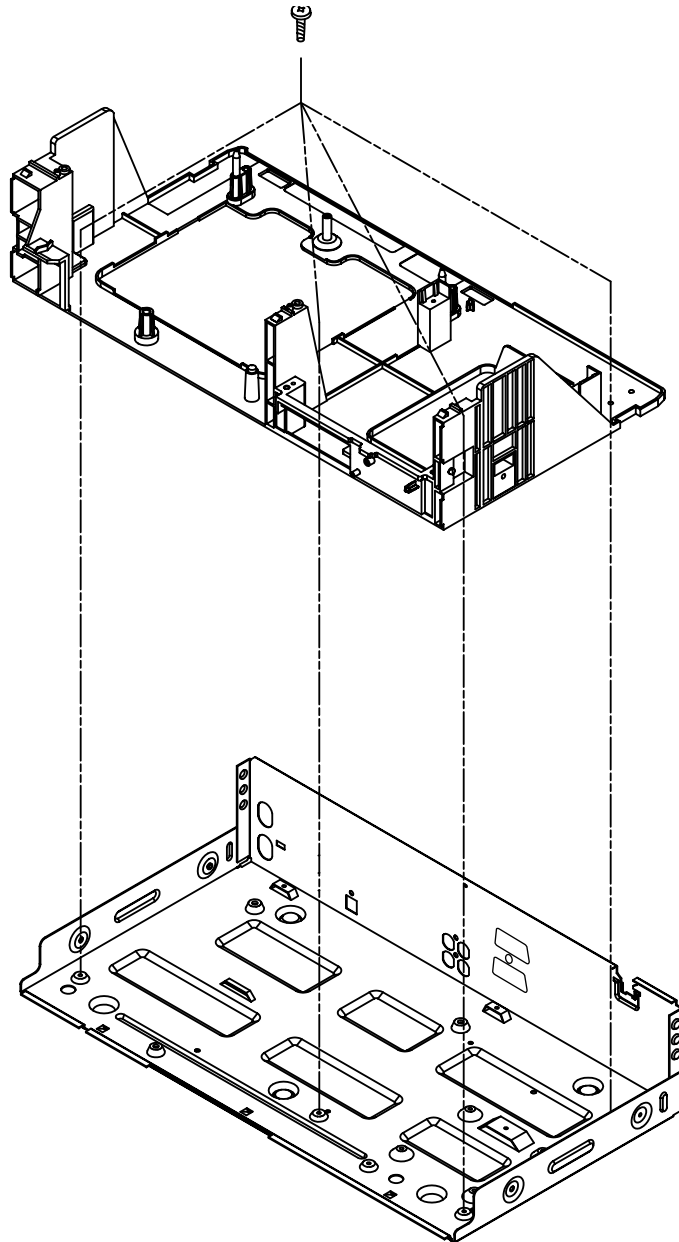
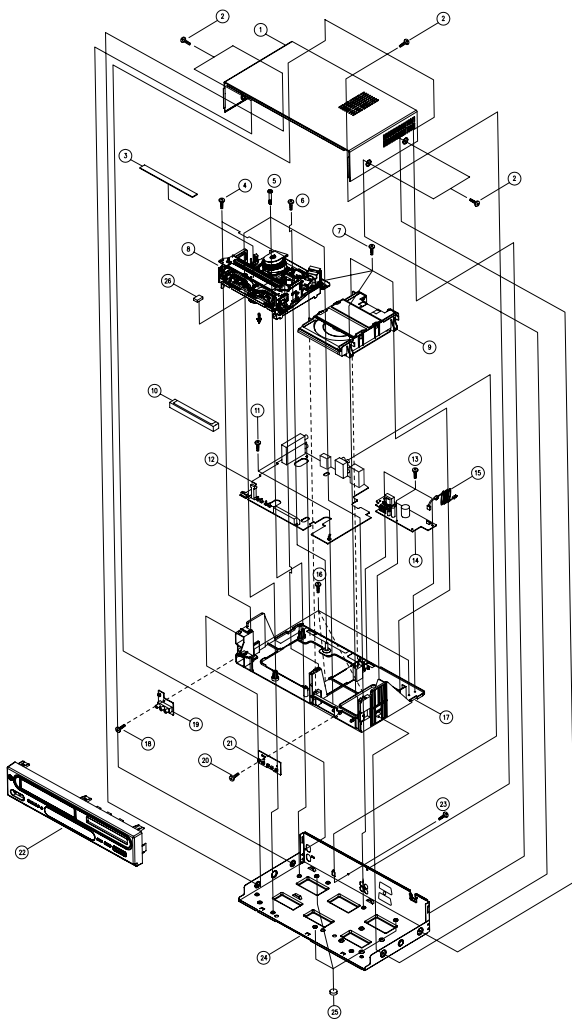

FIG. 6

G. Explode view



26	CUSHION TOP	97P4219500	1	EVA 20X14	DV6T91
25	CUSHION LEG	97P4220000	3	EVA T2.0	
24	COVER BOTTOM	97P0482800	1	SECC T0.8	
23	SCREW TAPPTITE	7174301011	6	TT2 RND 3X10 MFZN	B/COVER+M/CHASSIS FIX
22	PANEL FRONT AS	97PP328010	1		
21	PCB TACT S/W		1		
20	SCREW TAPPTITE	7173300811	1	TT2 RND 3X8 MFZN	PCB TACT S/W FIX
19	PCB JACK A/V		1		
18	SCREW TAPPTITE	7173300811	1	TT2 RND 3X8 MFZN	PCB JACK A/V FIX
17	CHASSIS MAIN	97P0612710	1	HIPS(HB)	
16	SCREW TAPPTITE	7173300811	4	TT2 RND 3X8 MFZN	B/COVER+M/CHASSIS FIX
15	CORD POWER AS	97P69BY91A	1	USA KKP-10W YH396	
14	PCB POWER MANUAL AS	PVPWMSN672	1		
13	SCREW TAPPTITE	7173300811	3	TT2 RND 3X8 MFZN	POWER PCB FIX
12	PCB MAIN MANUAL AS	PVMPMSN672	1		
11	SCREW TAPPTITE	7173300811	2	TT2 RND 3X8 MFZN	M/PCB FIX
10	DOOR DVD	97P1825800	1	ABS	
9	DVD COMBI	97QD020100	1		DVS LOADER
8	VCR DECK AS(T60)	PVDKARNC60	1	DRN-T610R NON	
7	SCREW TAPPTITE	7174301211	4	TT2 RND 3X12 MFZN	LOADER FIX
6	SCREW TAPPTITE	7174301211	1	TT2 RND 3X12 MFZN	DECK FIX
5	SCREW DECK MACHINE	97P3119800	3	BIND 4X24 MFZN	DECK FIX
4	SCREW TAPPTITE	7174301211	2	TT2 BIN 4X12 MFZN	DECK FIX
3	CUSHION TOP PLATE	97P4219700	1	EVA(SOFT) T=1 175X8	
2	SCREW TAPPTITE	7173300812	7	TT2 BIN 3X8 MFZN BK	COVER TOP FIX
1	COVER TOP	97P0482100	1	PCM T0.6	
N 0	PART NAME	PART NO.	Q'TY	MATERIAL	REMARK

ELECTRICAL PARTSLIST

✓ **Caution:** In this Service Manual, some parts can be changed for improving, their performance without notice in the parts list. So, if you need the latest parts information, please refer to PPL(Parts Price List) in Service information Center(<http://svc.dwe.co.kr>)

LOC	PARTS_CODE	PARTS_NAME	PARTS_DESCR	REMARK	LOC	PARTS_CODE	PARTS_NAME	PARTS_DESCR	REMARK
O3	PVMCASS202	CHASSIS MAIN AS	DC-B87D1S-NA		C060	HCFH104ZBA	C CHIP CERA	25V Y5V 0.1MF Z 1608	
D100	97P1RA2BA0	REMOCON HANDSET AS	VR-FA2BA0 GY3301A(AAA)		C062	HCFH104ZBA	C CHIP CERA	25V Y5V 0.1MF Z 1608	
DP08	97P882TF12	CABLE SCART	SCART-SCART 21P 1.2M	SECAM ONLY	C067	HCFH104ZBA	C CHIP CERA	25V Y5V 0.1MF Z 1608	
M01	97PP340000	PANEL FRONT AS	DC-B87D1D-NB		C153	HCBK103KBA	C CHIP CERA	50V X7R 0.01MF K 1608	
M1000	PVDKARSC60	DECK VCR AS(T60)	DRS-C610R NON	SECAM ONLY	C157	HCBK563KBA	C CHIP CERA	50V X7R 0.056MF Z 1608	
M1000	PVDKARPB66	DECK VCR AS(T50,F/L)	DRP-B610R NON	PAL ONLY	C159	HCBK103KBA	C CHIP CERA	50V X7R 0.01MF K 1608	
M200	PVLDASBD00	DVD MECHA AS	COMBO,SANKYO (97Q6010200),V3.0		C161	HCQK220JBA	C CHIP CERA	50V CH 22PF J 1608	
PD01A	97P88FBF19	CABLE FFC	1.0 R 15P 190MM		C202	HCBK152KBA	C CHIP CERA	50V X7R 1500PF K 1608	
PD02A	97P88FBK20	CABLE FFC	1.0 R 19P 200MM		C203	HCBK122KBA	C CHIP CERA	50V X7R 1200PF K 1608	
PW01	97P69DB90B	CORD POWER	EU KKP-419C YFH800 1.7M		C206	HCBK103KBA	C CHIP CERA	50V X7R 0.01MF K 1608	
Z001	PVMPMSS202	PCB MAIN MANUAL AS	DC-B87D1S-NA		C212	HCBK103KBA	C CHIP CERA	50V X7R 0.01MF K 1608	
E001	97P0993100	PLATE EARTH	C5210(PBS) T0.15(1/2H)		C218	HCBK103KBA	C CHIP CERA	50V X7R 0.01MF K 1608	
G701	DEB83D1N	LED DISPLAY	EB83D1N-F425-2SRVYWB		C220	HCBK333KBA	C CHIP CERA	50V X7R 0.033MF K 1608	
H501	10RC356VF4	IC UNIT R/RECEIVER	ORC-356VF4(38KHZ)		C251	HCFH474ZBA	C CHIP CERA	25V Y5V 0.47MF Z 1608	
IC502	14CAT2416P	IC EEPROM	CAT24WC16P(16K DIP)		C252	HCFH474ZBA	C CHIP CERA	25V Y5V 0.47MF Z 1608	
JK601	97P6313300	JACK DOUBLE SCART	DSAM-0302 2 LAYER		C253	HCFH474ZBA	C CHIP CERA	25V Y5V 0.47MF Z 1608	
JK603	97P6318230	JACK PIN	DPAM-0286		C254	HCFH474ZBA	C CHIP CERA	25V Y5V 0.47MF Z 1608	
JK606	97P0S03000	JACK SENSOR OPTIC	VST5B-12M		C255A	HCFH474ZBA	C CHIP CERA	25V Y5V 0.47MF Z 1608	
JK701	97P6316900	JACK PIN	DPSE-9946		C256A	HCFH474ZBA	C CHIP CERA	25V Y5V 0.47MF Z 1608	
M401	97P0478200	CASE SHI PREAMP	ET T0.4		C257	HCFH474ZBA	C CHIP CERA	25V Y5V 0.47MF Z 1608	
P201	97P62Y1318	CONN WAFER	DVW250 PLUG 2.5MM 8P		C258	HCFH474ZBA	C CHIP CERA	25V Y5V 0.47MF Z 1608	
P202	97P62T14B2	CONN HOUSING	TMC-EX-B1 RECEP 2.0MM 2P		C259	HCFH474ZBA	C CHIP CERA	25V Y5V 0.47MF Z 1608	
P401	97P62G06DA	CONN FFC	GF120-10S-TS 10P ST		C260	HCFH474ZBA	C CHIP CERA	25V Y5V 0.47MF Z 1608	
P501	97P62J012C	CONN B/B	JE612 PLUG 2.0 12P		C269	HCFH223ZBA	C CHIP CERA	25V Y5V 0.022MF Z 1608	
P604	97P62M06A6	CONN B/B	35337 PLUG 2.5MM 6P		C271	HCBK682KBA	C CHIP CERA	50V X7R 6800PF K 1608	
P701	97P62A24B5	CONN WAFER	440055-5 RA PLUG 5P		C277	HCBK682KBA	C CHIP CERA	50V X7R 6800PF K 1608	
P702	97P62M05A6	CONN B/B	35238 RECEP 2.5MM 6P		C281	HCFH104ZBA	C CHIP CERA	25V Y5V 0.1MF Z 1608	
P804	97P62Y17AA	CONN WAFER	YW025-10 ST PLUG 2.5MM		C282	HCBK122KBA	C CHIP CERA	50V X7R 1200PF K 1608	
PD01	97P62K04EK	CONN FFC	SCB-2119-M-2 19P ST		C286	HCFH104ZBA	C CHIP CERA	25V Y5V 0.1MF Z 1608	
PD02	97P62K04EF	CONN FFC	SCB-2115-M-2 15P ST		C301	HCBK473KBA	C CHIP CERA	50V X7R 0.047MF K 1608	
PJ501	97P885X226	CONN AS	5H-5S 150MM		C303	HCFH223ZBA	C CHIP CERA	25V Y5V 0.022MF Z 1608	
PT01	97P6269000	CONN WAFER	00-8283-0612-00000		C306	HCBK103KBA	C CHIP CERA	50V X7R 0.01MF K 1608	
RF101	97P7618700	TUNER 3 IN 1	SSTBI-SLQ2	SECAM ONLY	C307	HCBK473KBA	C CHIP CERA	50V X7R 0.047MF K 1608	
RF101	97P7615500	TUNER 3 IN 1	SSTMI-GKIQ1	PAL ONLY	C308	HCFH223ZBA	C CHIP CERA	25V Y5V 0.022MF Z 1608	
S501	97P0S02700	SENSOR REEL	KPI-261D		C310	HCBK473KBA	C CHIP CERA	50V X7R 0.047MF K 1608	
S502	97P0S02700	SENSOR REEL	KPI-261D		C311	HCBF224KCA	C CHIP CERA	16V X7R 0.22MF K 2012	
SW501	5S10104200	SW MODE	MMS01010ZMB0		C312	HCBK822KBA	C CHIP CERA	50V X7R 8200PF K 1608	
SW601	5SD0101100	SW DETE	MXS00921MPC0		C314	HCBK103KBA	C CHIP CERA	50V X7R 0.01MF K 1608	
T201	560202L692	COIL OSC	DEO-006		C315	HCFH104ZBA	C CHIP CERA	25V Y5V 0.1MF Z 1608	
X051	5XJ18R4LAE	CRYSTAL QUARTZ	HC-49/S 18.43200MHZ 30PP		C316	HCQK561JBA	C CHIP CERA	50V CH 560PF J 1608	
X501	5XJ17R7LAD	CRYSTAL QUARTZ	HC-49/S 17.73447MHZ 25PPM		C317	HCQK131JBA	C CHIP CERA	50V CH 130PF J 1608	
Z0011	PVMPJ1S202	MAIN CHIP MOUNT A AS	DC-B87D1S-NA		C318	HCFH105ZBA	C CHIP CERA	16V Y5V 1MF Z 1608	
C008	HCBK103KBA	C CHIP CERA	50V X7R 0.01MF K 1608		C319	HCFH105ZBA	C CHIP CERA	16V Y5V 1MF Z 1608	
C009	HCQK300JBA	C CHIP CERA	50V CH 30PF J 1608		C325	HCFH474ZBA	C CHIP CERA	25V Y5V 0.47MF Z 1608	
C012	HCBK103KBA	C CHIP CERA	50V X7R 0.01MF K 1608		C328	HCBK103KBA	C CHIP CERA	50V X7R 0.01MF K 1608	
C015	HCQK331JBA	C CHIP CERA	50V CH 330PF J 1608		C330	HCFH474ZBA	C CHIP CERA	25V Y5V 0.47MF Z 1608	
C017	HCBK822KBA	C CHIP CERA	50V X7R 8200PF K 1608		C333	HCFH104ZBA	C CHIP CERA	25V Y5V 0.1MF Z 1608	
C018	HCBK822KBA	C CHIP CERA	50V X7R 8200PF K 1608		C335	HCBK103KBA	C CHIP CERA	50V X7R 0.01MF K 1608	
C028	HCFH104ZBA	C CHIP CERA	25V Y5V 0.1MF Z 1608		C339	HCQK131JBA	C CHIP CERA	50V CH 130PF J 1608	
C051	HCQK390JBA	C CHIP CERA	50V CH 39PF J 1608		C340	HCQK221JBA	C CHIP CERA	50V CH 220PF J 1608	
C052	HCQK209CBA	C CHIP CERA	50V CH 2PF C 1608		C362	HCFH105ZBA	C CHIP CERA	16V Y5V 1MF Z 1608	SECAM ONLY
C053	HCQK209CBA	C CHIP CERA	50V CH 2PF C 1608		C363	HCBK103KBA	C CHIP CERA	50V X7R 0.01MF K 1608	SECAM ONLY
C054	HCBK103KBA	C CHIP CERA	50V X7R 0.01MF K 1608		C365	HCFH105ZBA	C CHIP CERA	16V Y5V 1MF Z 1608	SECAM ONLY
C056	HCFH104ZBA	C CHIP CERA	25V Y5V 0.1MF Z 1608		C368	HCFH104ZBA	C CHIP CERA	25V Y5V 0.1MF Z 1608	SECAM ONLY
C058	HCFH104ZBA	C CHIP CERA	25V Y5V 0.1MF Z 1608		C369	HCBK103KBA	C CHIP CERA	50V X7R 0.01MF K 1608	SECAM ONLY

ELECTRICAL PARTSLIST

LOC	PARTS_CODE	PARTS_NAME	PARTS_DESCR	REMARK	LOC	PARTS_CODE	PARTS_NAME	PARTS_DESCR	REMARK
C370	HCFH474ZBA	C CHIP CERA	25V Y5V 0.47MF Z 1608	SECAM ONLY	CD20	HCQK561JBA	C CHIP CERA	50V CH 560PF J 1608	
C371	HCFH474ZBA	C CHIP CERA	25V Y5V 0.47MF Z 1608	SECAM ONLY	CD26	HCBK182KBA	C CHIP CERA	X7R 50V 1800PF K 1608	
C372	HCBK103KBA	C CHIP CERA	50V X7R 0.01MF K 1608	SECAM ONLY	CD53	HCFH104ZBA	C CHIP CERA	25V Y5V 0.1MF Z 1608	
C373	HCFH474ZBA	C CHIP CERA	25V Y5V 0.47MF Z 1608	SECAM ONLY	CD73	HCFH104ZBA	C CHIP CERA	25V Y5V 0.1MF Z 1608	
C379	HCBK103KBA	C CHIP CERA	50V X7R 0.01MF K 1608	SECAM ONLY	CD75	HCBK103KBA	C CHIP CERA	50V X7R 0.01MF K 1608	
C384	HCBK103KBA	C CHIP CERA	50V X7R 0.01MF K 1608	SECAM ONLY	IC051	1MSP3417G3	IC NICAM	MSP3417G-V3	
C401	HCFH104ZBA	C CHIP CERA	25V Y5V 0.1MF Z 1608		IC151	1LC74793	IC CHIP VPS	LC74793JM	
C404	HCBK103KBA	C CHIP CERA	50V X7R 0.01MF K 1608		IC251	1TDA9605H-	IC HI-FI	TDA9605H	
C505	HCBK103KBA	C CHIP CERA	50V X7R 0.01MF K 1608		IC301	1LA71750M-	IC AV 1 CHIP	LA71750M	
C506	HCBK103KBA	C CHIP CERA	50V X7R 0.01MF K 1608		IC361	1LA70100M-	IC SECAM-L	LA70100M	SECAM ONLY
C507	HCBK103KBA	C CHIP CERA	50V X7R 0.01MF K 1608		IC501	168KT88KTS	IC MICOM	M3776AMCA-1B6GP	
C509	HCBK103KBA	C CHIP CERA	50V X7R 0.01MF K 1608		IC601	1HEF4052BD	IC CHIP SW	HEF4052B	
C510	HCBK222KBA	C CHIP CERA	50V X7R 2200PF K 1608		IC701	1PT6961 -	IC DRIVER	P76961 32P.M SOP	
C514	HCBK102KBA	C CHIP CERA	50V X7R 1000PF K 1608		ICD01	1PCM1754DD	IC CHIP DAC	PCM1754DBQ 16PIN SSOP REEL	
C515	HCFH104ZBA	C CHIP CERA	25V Y5V 0.1MF Z 1608		ICD03	1KA4558D	IC OP AMP	KA4558D(8 SOP)	
C516	HCBK222KBA	C CHIP CERA	50V X7R 2200PF K 1608		L607	HLX1210001	BEAD CHIP	TB201209Z121	
C518	HCBK103KBA	C CHIP CERA	50V X7R 0.01MF K 1608		L608	HLX1210001	BEAD CHIP	TB201209Z121	
C519	HCBK272KBA	C CHIP CERA	50V X7R 2700PF K 1608		L688	HLX1210001	BEAD CHIP	TB201209Z121	
C520	HCFH223ZBA	C CHIP CERA	25V Y5V 0.022MF Z 1608		L689	HLX1210001	BEAD CHIP	TB201209Z121	
C521	HCFH223ZBA	C CHIP CERA	25V Y5V 0.022MF Z 1608		Q006	T2SC2412KB	TR CHIP	2SC2412K-T146-BR	
C523	HCBK103KBA	C CHIP CERA	50V X7R 0.01MF K 1608		Q007	T2SC2412KB	TR CHIP	2SC2412K-T146-BR	
C525	HCQK201JBA	C CHIP CERA	50V CH 200PF J 1608		Q301	T2SC2412KB	TR CHIP	2SC2412K-T146-BR	SECAM ONLY
C527	HCBK103KBA	C CHIP CERA	50V X7R 0.01MF K 1608		Q302	T2SC2412KB	TR CHIP	2SC2412K-T146-BR	
C528	HCBK103KBA	C CHIP CERA	50V X7R 0.01MF K 1608		Q303	T2SA1037KB	TR CHIP	2SA1037AKT146-R	
C529	HCFH104ZBA	C CHIP CERA	25V Y5V 0.1MF Z 1608		Q304	T2SC2412KB	TR CHIP	2SC2412K-T146-BR	
C531	HCQK150JBA	C CHIP CERA	50V CH 15PF J 1608		Q305	T2SC2412KB	TR CHIP	2SC2412K-T146-BR	
C532	HCQK150JBA	C CHIP CERA	50V CH 15PF J 1608		Q306	T2SC2412KB	TR CHIP	2SC2412K-T146-BR	
C536	HCBK103KBA	C CHIP CERA	50V X7R 0.01MF K 1608		Q307	T2SA1037KB	TR CHIP	2SA1037AKT146-R	
C537	HCBK103KBA	C CHIP CERA	50V X7R 0.01MF K 1608		Q308	T2SC2412KB	TR CHIP	2SC2412K-T146-BR	
C596	HCFH223ZBA	C CHIP CERA	25V Y5V 0.022MF Z 1608		Q309	T2SC2412KB	TR CHIP	2SC2412K-T146-BR	
C597	HCFH223ZBA	C CHIP CERA	25V Y5V 0.022MF Z 1608		Q310	T2SC2412KB	TR CHIP	2SC2412K-T146-BR	
C598	HCFH223ZBA	C CHIP CERA	25V Y5V 0.022MF Z 1608		Q311	T2SC2412KB	TR CHIP	2SC2412K-T146-BR	
C599	HCFH223ZBA	C CHIP CERA	25V Y5V 0.022MF Z 1608		Q333	T2SA1037KB	TR CHIP	2SA1037AKT146-R	
C613	HCBK102KBA	C CHIP CERA	50V X7R 1000PF K 1608		QD03	T2SC2412KB	TR CHIP	2SC2412K-T146-BR	
C614	HCQK331JBA	C CHIP CERA	50V CH 330PF J 1608		QD04	T2SC2412KB	TR CHIP	2SC2412K-T146-BR	
C615A	HCQK331JBA	C CHIP CERA	50V CH 330PF J 1608		QD50	T2SA1037KB	TR CHIP	2SA1037AKT146-R	
C616	HCFH223ZBA	C CHIP CERA	25V Y5V 0.022MF Z 1608		QD51	T2SA1037KB	TR CHIP	2SA1037AKT146-R	
C625A	HCQK331JBA	C CHIP CERA	50V CH 330PF J 1608		QD52	T2SA1037KB	TR CHIP	2SA1037AKT146-R	
C626	HCQK331JBA	C CHIP CERA	50V CH 330PF J 1608		QD55	T2SA1037KB	TR CHIP	2SA1037AKT146-R	
C627	HCBK102KBA	C CHIP CERA	50V X7R 1000PF K 1608		QD56	T2SC2412KB	TR CHIP	2SC2412K-T146-BR	
C628	HCFH223ZBA	C CHIP CERA	25V Y5V 0.022MF Z 1608		R007	HRFS225JBA	R CHIP	1/16 2.2M OHM J 1608	
C630	HCBK102KBA	C CHIP CERA	50V X7R 1000PF K 1608		R022	HRFS225JBA	R CHIP	1/16 2.2M OHM J 1608	
C631	HCBK102KBA	C CHIP CERA	50V X7R 1000PF K 1608		R023	HRFS153JBA	R CHIP	1/16 15K OHM J 1608	
C632	HCQK330JBA	C CHIP CERA	50V CH 33PF J 1608		R055	HRFS562JBA	R CHIP	1/16 5.6K OHM J 1608	
C633	HCQK330JBA	C CHIP CERA	50V CH 33PF J 1608		R056	HRFS562JBA	R CHIP	1/16 5.6K OHM J 1608	
C636	HCQK330JBA	C CHIP CERA	50V CH 33PF J 1608		R088	HRFS153JBA	R CHIP	1/16 15K OHM J 1608	
C640	HCQK201JBA	C CHIP CERA	50V CH 200PF J 1608		R098	HRFS133JBA	R CHIP	1/16 13K OHM J 1608	
C641	HCBK102KBA	C CHIP CERA	50V X7R 1000PF K 1608		R099	HRFS133JBA	R CHIP	1/16 13K OHM J 1608	
C642	HCBK102KBA	C CHIP CERA	50V X7R 1000PF K 1608		R152	HRFS103JBA	R CHIP	1/16 10K OHM J 1608	
C698	HCQK330JBA	C CHIP CERA	50V CH 33PF J 1608		R153	HRFS562JBA	R CHIP	1/16 5.6K OHM J 1608	
C699	HCQK330JBA	C CHIP CERA	50V CH 33PF J 1608		R154	HRFS103JBA	R CHIP	1/16 10K OHM J 1608	
C888	HCFH223ZBA	C CHIP CERA	25V Y5V 0.022MF Z 1608		R155	HRFS272JBA	R CHIP	1/16 2.7K OHM J 1608	
CD06	HCQK561JBA	C CHIP CERA	50V CH 560PF J 1608		R201	HRFS273JBA	R CHIP	1/16 27K OHM J 1608	
CD14	HCFH104ZBA	C CHIP CERA	25V Y5V 0.1MF Z 1608		R202	HRFS334JBA	R CHIP	1/16 330K OHM J 1608	
CD18	HCBK182KBA	C CHIP CERA	X7R 50V 1800PF K 1608		R203	HRFS181JBA	R CHIP	1/16 180 OHM J 1608	

ELECTRICAL PARTSLIST

LOC	PARTS_CODE	PARTS_NAME	PARTS_DESCR	REMARK	LOC	PARTS_CODE	PARTS_NAME	PARTS_DESCR	REMARK
R205	HRFS752JBA	R CHIP	1/16 7.5K OHM J 1608		R516	HRFS103JBA	R CHIP	1/16 10K OHM J 1608	
R206	HRFS273JBA	R CHIP	1/16 27K OHM J 1608		R517	HRFS102JBA	R CHIP	1/16 1K OHM J 1608	
R208	HRFS512JBA	R CHIP	1/16 5.1K OHM J 1608		R518	HRFS182JBA	R CHIP	1/16 1.8K OHM J 1608	
R209	HRFS123JBA	R CHIP	1/16 12K OHM J 1608		R520	HRFS561JBA	R CHIP	1/16 560 OHM J 1608	
R216	HRFS103JBA	R CHIP	1/16 10K OHM J 1608		R521	HRFS561JBA	R CHIP	1/16 560 OHM J 1608	
R225	HRFS229JBA	R CHIP	1/16 2.2 OHM J 1608		R523	HRFS472JBA	R CHIP	1/16 4.7K OHM J 1608	
R226	HRFS229JBA	R CHIP	1/16 2.2 OHM J 1608		R524	HCFH104ZBA	C CHIP CERA	25V Y5V 0.1MF Z 1608	
R227	HRFS182JBA	R CHIP	1/16 1.8K OHM J 1608		R526	HRFS273JBA	R CHIP	1/16 27K OHM J 1608	
R228	HRFS470JBA	R CHIP	1/16 47 OHM J 1608		R527	HRFS273JBA	R CHIP	1/16 27K OHM J 1608	
R229	HRFS561JBA	R CHIP	1/16 560 OHM J 1608		R528	HRFS201JBA	R CHIP	1/16 200 OHM J 1608	
R231	HRFS103JBA	R CHIP	1/16 10K OHM J 1608		R529	HRFS201JBA	R CHIP	1/16 200 OHM J 1608	
R233	HRFS102JBA	R CHIP	1/16 1K OHM J 1608		R530	HRFS244JBA	R CHIP	1/16W 240K OHM J 1608	
R234	HRFS202JBA	R CHIP	1/16 2K OHM J 1608		R531	HRFS244JBA	R CHIP	1/16W 240K OHM J 1608	
R264	HRFS103JBA	R CHIP	1/16 10K OHM J 1608		R532	HRFS244JBA	R CHIP	1/16W 240K OHM J 1608	
R270	HRFS333JBA	R CHIP	1/16 33K OHM J 1608		R533	HRFS244JBA	R CHIP	1/16W 240K OHM J 1608	
R271	HRFS470JBA	R CHIP	1/16 47 OHM J 1608		R534	HRFS103JBA	R CHIP	1/16 10K OHM J 1608	
R301	HRFS122JBA	R CHIP	1/16 1.2K OHM J 1608		R536	HRFS103JBA	R CHIP	1/16 10K OHM J 1608	
R302	HRFS822JBA	R CHIP	1/16 8.2K OHM J 1608		R538	HRFS912JBA	R CHIP	1/16 9.1K OHM J 1608	
R304	HRFS202JBA	R CHIP	1/16 2K OHM J 1608	SECAM ONLY	R539	HRFS431JBA	R CHIP	1/16 430 OHM J 1608	
R307	HRFS392JBA	R CHIP	1/16 3.9K OHM J 1608		R543	HRFS103JBA	R CHIP	1/16 10K OHM J 1608	
R308	HRFS102JBA	R CHIP	1/16 1K OHM J 1608		R544	HRFS102JBA	R CHIP	1/16 1K OHM J 1608	
R309	HRFS155JBA	R CHIP	1/16 1.5M OHM J 1608		R547	HRFS332JBA	R CHIP	1/16 3.3K OHM J 1608	
R310	HRFS155JBA	R CHIP	1/16 1.5M OHM J 1608		R549	HRFS474JBA	R CHIP	1/16 470K OHM J 1608	
R312	HRFS152JBA	R CHIP	1/16 1.5K OHM J 1608		R554	HRFS513JBA	R CHIP	1/16 51K OHM J 1608	
R313	HRFS152JBA	R CHIP	1/16 1.5K OHM J 1608		R601	HRFS153JBA	R CHIP	1/16 15K OHM J 1608	
R314	HRFS103JBA	R CHIP	1/16 10K OHM J 1608		R604A	HRFS512JBA	R CHIP	1/16 5.1K OHM J 1608	
R315	HRFS183JBA	R CHIP	1/16 18K OHM J 1608		R605A	HRFS512JBA	R CHIP	1/16 5.1K OHM J 1608	
R317	HRFS221JBA	R CHIP	1/16 220 OHM J 1608		R606A	HRFS750JBA	R CHIP	1/16 75 OHM J 1608	
R318	HRFS102JBA	R CHIP	1/16 1K OHM J 1608		R607	HRFS512JBA	R CHIP	1/16 5.1K OHM J 1608	
R319	HRFS105JBA	R CHIP	1/16 1M OHM J 1608		R608	HRFS512JBA	R CHIP	1/16 5.1K OHM J 1608	
R320	HRFS471JBA	R CHIP	1/16 470 OHM J 1608		R611A	HRFS750JBA	R CHIP	1/16 75 OHM J 1608	
R324	HRFS202JBA	R CHIP	1/16 2K OHM J 1608		R613	HRFS750JBA	R CHIP	1/16 75 OHM J 1608	
R326	HRFS472JBA	R CHIP	1/16 4.7K OHM J 1608		R614	HRFS750JBA	R CHIP	1/16 75 OHM J 1608	
R327	HRFS332JBA	R CHIP	1/16 3.3K OHM J 1608		R615	HRFS750JBA	R CHIP	1/16 75 OHM J 1608	
R328	HRFS104JBA	R CHIP	1/16 100K OHM J 1608		R621	HRFS103JBA	R CHIP	1/16 10K OHM J 1608	
R333	HRFS102JBA	R CHIP	1/16 1K OHM J 1608		R622	HRFS474JBA	R CHIP	1/16 470K OHM J 1608	
R347	HRFS101JBA	R CHIP	1/16 100 OHM J 1608		R623	HRFS474JBA	R CHIP	1/16 470K OHM J 1608	
R349	HRFS102JBA	R CHIP	1/16 1K OHM J 1608		R624	HRFS103JBA	R CHIP	1/16 10K OHM J 1608	
R352	HRFS820JBA	R CHIP	1/16 82 OHM J 1608		R629	HRFS474JBA	R CHIP	1/16 470K OHM J 1608	
R353	HRFS101JBA	R CHIP	1/16 100 OHM J 1608		R630	HRFS474JBA	R CHIP	1/16 470K OHM J 1608	
R354	HRFS101JBA	R CHIP	1/16 100 OHM J 1608		R632	HRFS000-BA	R CHIP	1/16 0 OHM 1608	
R355	HRFS221JBA	R CHIP	1/16 220 OHM J 1608		R640	HRFS512JBA	R CHIP	1/16 5.1K OHM J 1608	
R356	HRFS151JBA	R CHIP	1/16 150 OHM J 1608		R641	HRFS512JBA	R CHIP	1/16 5.1K OHM J 1608	
R362	HRFS102JBA	R CHIP	1/16 1K OHM J 1608	SECAM ONLY	R645	HRFS750JBA	R CHIP	1/16 75 OHM J 1608	
R366	HRFS103JBA	R CHIP	1/16 10K OHM J 1608	SECAM ONLY	R653	HRFS103JBA	R CHIP	1/16 10K OHM J 1608	
R377	HRFS154JBA	R CHIP	1/16 150K OHM J 1608	SECAM ONLY	R677	HRFS221JBA	R CHIP	1/16 220 OHM J 1608	
R380	HRFS103JBA	R CHIP	1/16 10K OHM J 1608	SECAM ONLY	R680	HRFS301JBA	R CHIP	1/16 300 OHM J 1608	
R401	HRFS473JBA	R CHIP	1/16 47K OHM J 1608		R681	HRFS301JBA	R CHIP	1/16 300 OHM J 1608	
R505	HRFS103JBA	R CHIP	1/16 10K OHM J 1608		R688	HRFS221JBA	R CHIP	1/16 220 OHM J 1608	
R506	HRFS472JBA	R CHIP	1/16 4.7K OHM J 1608		R852	HRFS180JBA	R CHIP	1/16 18 OHM J 1608	
R509	HRFS472JBA	R CHIP	1/16 4.7K OHM J 1608		RD05	HRFS113JBA	R CHIP	1/16 11K OHM J 1608	
R510	HRFS103JBA	R CHIP	1/16 10K OHM J 1608		RD06	HRFS132JBA	R CHIP	1/16 1.3K OHM J 1608	
R511	HRFS103JBA	R CHIP	1/16 10K OHM J 1608		RD07	HRFS561JBA	R CHIP	1/16 560 OHM J 1608	
R512	HRFS472JBA	R CHIP	1/16 4.7K OHM J 1608		RD09	HRFS223JBA	R CHIP	1/16 22K OHM J 1608	
R515	HRFS222JBA	R CHIP	1/16 2.2K OHM J 1608		RD11	HRFS471JBA	R CHIP	1/16 470 OHM J 1608	

ELECTRICAL PARTSLIST

LOC	PARTS_CODE	PARTS_NAME	PARTS_DESCR	REMARK	LOC	PARTS_CODE	PARTS_NAME	PARTS_DESCR	REMARK
RD15	HRFS113JBA	R CHIP	1/16 11K OHM J 1608		Z0012	PVMPJRS202	PCB MAIN RADIAL AS	DC-B87D1S-NA	
RD16	HRFS561JBA	R CHIP	1/16 560 OHM J 1608		C001	CEXF1C100A	C ELECTRO	16V RSM 10MF 5X7	PAL ONLY
RD17	HRFS132JBA	R CHIP	1/16 1.3K OHM J 1608		C004	CEXF1A101A	C ELECTRO	10V RSM 100MF 6.3X7	
RD18	HRFS223JBA	R CHIP	1/16 22K OHM J 1608		C013	CEXE1A221E	C ELECTRO	10V RM 220MF 5X11	
RD20	HRFS471JBA	R CHIP	1/16 470 OHM J 1608		C016	CEXF1H478A	C ELECTRO	50V RSM 0.47MF 4X7	
RD33	HRFS103JBA	R CHIP	1/16 10K OHM J 1608		C025	CEXF1C100A	C ELECTRO	16V RSM 10MF 5X7	
RD53	HRFS102JBA	R CHIP	1/16 1K OHM J 1608		C026	CEXF1C100A	C ELECTRO	16V RSM 10MF 5X7	
RD55	HRFS680JBA	R CHIP	1/16 68 OHM J 1608		C027	CEXF1C470A	C ELECTRO	16V RSM 47MF (5X7) TP	
RD59	HRFS750JBA	R CHIP	1/16 75 OHM J 1608		C029	CEXF1C100A	C ELECTRO	16V RSM 10MF 5X7	
RD60	HRFS750JBA	R CHIP	1/16 75 OHM J 1608		C055	CEXF1C100A	C ELECTRO	16V RSM 10MF 5X7	
RD62	HRFS750JBA	R CHIP	1/16 75 OHM J 1608		C057	CEXF1C100A	C ELECTRO	16V RSM 10MF 5X7	
RD63	HRFS103JBA	R CHIP	1/16 10K OHM J 1608		C059	CEXF1H339A	C ELECTRO	50V RSM 3.3MF 4X7	
RJ001	HRF8000-EA	R CHIP	1/8 0 OHM 3216		C061	CEXF1C100A	C ELECTRO	16V RSM 10MF 5X7	
RJ002	HRF8000-EA	R CHIP	1/8 0 OHM 3216		C063	CEXF1H109A	C ELECTRO	50V RSM 1MF (4X7) TP	
RJ003	HRFS000-BA	R CHIP	1/16 0 OHM 1608		C064	CEXF1C100A	C ELECTRO	16V RSM 10MF 5X7	
RJ004	HRF8000-EA	R CHIP	1/8 0 OHM 3216		C065	CEXF1C100A	C ELECTRO	16V RSM 10MF 5X7	
RJ005	HRFS000-BA	R CHIP	1/16 0 OHM 1608		C066	CEXF1C100A	C ELECTRO	16V RSM 10MF 5X7	
RJ007	HRFS000-BA	R CHIP	1/16 0 OHM 1608		C068	CEXF1C100A	C ELECTRO	16V RSM 10MF 5X7	
RJ008	HRFS000-BA	R CHIP	1/16 0 OHM 1608		C151	CEXF1C470A	C ELECTRO	16V RSM 47MF (5X7) TP	
RJ009	HRFS000-BA	R CHIP	1/16 0 OHM 1608		C152	CEXF1H109A	C ELECTRO	50V RSM 1MF (4X7) TP	
RJ010	HRFS000-BA	R CHIP	1/16 0 OHM 1608		C154	CEXF1H109A	C ELECTRO	50V RSM 1MF (4X7) TP	
RJ011	HRF8000-EA	R CHIP	1/8 0 OHM 3216		C158	CEXF1H479A	C ELECTRO	50V RSM 4.7MF 4X7	
RJ012	HRFS000-BA	R CHIP	1/16 0 OHM 1608		C201	CEXF1C100A	C ELECTRO	16V RSM 10MF 5X7	
RJ013	HRFS000-BA	R CHIP	1/16 0 OHM 1608		C204	CEXF1C220A	C ELECTRO	16V RSM 22MF (5X7)	
RJ018	HRFS000-BA	R CHIP	1/16 0 OHM 1608		C205	CEXF1C470A	C ELECTRO	16V RSM 47MF (5X7) TP	
RJ019	HRFS000-BA	R CHIP	1/16 0 OHM 1608		C208	CEXF1H479A	C ELECTRO	50V RSM 4.7MF 4X7	
RJ01A	HRFS000-BA	R CHIP	1/16 0 OHM 1608		C210	CEXF1C220A	C ELECTRO	16V RSM 22MF (5X7)	
RJ022	HRFS000-BA	R CHIP	1/16 0 OHM 1608		C213	CEXF1H478A	C ELECTRO	50V RSM 0.47MF 4X7	
RJ023	HRFS000-BA	R CHIP	1/16 0 OHM 1608		C214	CEXF1C330A	C ELECTRO	16V RSM 33MF (6.3X7) TP	
RJ026	HRF8000-EA	R CHIP	1/8 0 OHM 3216		C219	CEXF1C470A	C ELECTRO	16V RSM 47MF (5X7) TP	
RJ02A	HRFS000-BA	R CHIP	1/16 0 OHM 1608		C221	CEXF1C470A	C ELECTRO	16V RSM 47MF (5X7) TP	
RJ031	HRF8000-EA	R CHIP	1/8 0 OHM 3216		C222	CMXM2A243J	C MYLAR	100V 0.024MF J (TP)	
RJ032	HRF8000-EA	R CHIP	1/8 0 OHM 3216		C223	CEXF1H479A	C ELECTRO	50V RSM 4.7MF 4X7	
RJ033	HRF8000-EA	R CHIP	1/8 0 OHM 3216		C225	CMXM2A333J	C MYLAR	100V 0.033MF J (TP)	
RJ034	HRF8000-EA	R CHIP	1/8 0 OHM 3216		C261	CEXF1C100A	C ELECTRO	16V RSM 10MF 5X7	
RJ03A	HRFS000-BA	R CHIP	1/16 0 OHM 1608		C262	CEXF1C100A	C ELECTRO	16V RSM 10MF 5X7	
RJ04A	HRFS000-BA	R CHIP	1/16 0 OHM 1608		C263	CEXF1C100A	C ELECTRO	16V RSM 10MF 5X7	
RJ05A	HRFS000-BA	R CHIP	1/16 0 OHM 1608		C264	CEXF1C100A	C ELECTRO	16V RSM 10MF 5X7	
RJ103	HRF8000-EA	R CHIP	1/8 0 OHM 3216		C270	CEXF1C100A	C ELECTRO	16V RSM 10MF 5X7	
RJ104	HRFS000-BA	R CHIP	1/16 0 OHM 1608		C272	CEXF1C470A	C ELECTRO	16V RSM 47MF (5X7) TP	
RJ201	HRFS000-BA	R CHIP	1/16 0 OHM 1608		C273	CEXF1C100A	C ELECTRO	16V RSM 10MF 5X7	
RJ300	HRFS000-BA	R CHIP	1/16 0 OHM 1608		C274	CEXF1H229A	C ELECTRO	50V RSM 2.2MF (4X7) TP	
RJ313	HRF8000-EA	R CHIP	1/8 0 OHM 3216		C275	CEXF1C100A	C ELECTRO	16V RSM 10MF 5X7	
RJ400	HRFS102JBA	R CHIP	1/16 1K OHM J 1608		C276	CEXF1C470A	C ELECTRO	16V RSM 47MF (5X7) TP	
RJ402	HRFS000-BA	R CHIP	1/16 0 OHM 1608		C278	CEXF1C100A	C ELECTRO	16V RSM 10MF 5X7	
RJ403	HRFS000-BA	R CHIP	1/16 0 OHM 1608		C279	CEXF1C470A	C ELECTRO	16V RSM 47MF (5X7) TP	
RJ405	HRFS102JBA	R CHIP	1/16 1K OHM J 1608		C283	CEXF1C470A	C ELECTRO	16V RSM 47MF (5X7) TP	
RJ444	HRF8000-EA	R CHIP	1/8 0 OHM 3216		C292	CEXF1C100A	C ELECTRO	16V RSM 10MF 5X7	
RJ601	HRF8000-EA	R CHIP	1/8 0 OHM 3216		C302	CEXF1H109A	C ELECTRO	50V RSM 1MF (4X7) TP	
RJ602	HRF8000-EA	R CHIP	1/8 0 OHM 3216		C304	CEXF1H109A	C ELECTRO	50V RSM 1MF (4X7) TP	
RJ666	HRFS000-BA	R CHIP	1/16 0 OHM 1608		C305	CEXF1C470A	C ELECTRO	16V RSM 47MF (5X7) TP	
RJ701	HRF8000-EA	R CHIP	1/8 0 OHM 3216		C309	CEXF1H109A	C ELECTRO	50V RSM 1MF (4X7) TP	
RJ702	HRFS000-BA	R CHIP	1/16 0 OHM 1608		C313	CEXF1H109A	C ELECTRO	50V RSM 1MF (4X7) TP	
RJ703	HRFS000-BA	R CHIP	1/16 0 OHM 1608		C320	CEXF1C470A	C ELECTRO	16V RSM 47MF (5X7) TP	
RJ812	HRFS000-BA	R CHIP	1/16 0 OHM 1608		C322	CEXF1C100A	C ELECTRO	16V RSM 10MF 5X7	

ELECTRICAL PARTSLIST

LOC	PARTS_CODE	PARTS_NAME	PARTS_DESCR	REMARK	LOC	PARTS_CODE	PARTS_NAME	PARTS_DESCR	REMARK
C327	CEXF1C470A	C ELECTRO	16V RSM 47MF (5X7) TP		CD62	CEXF1C470A	C ELECTRO	16V RSM 47MF (5X7) TP	
C331	CEXF1C100A	C ELECTRO	16V RSM 10MF 5X7		CD72	CEXF1C470A	C ELECTRO	16V RSM 47MF (5X7) TP	
C332	CEXF1C100A	C ELECTRO	16V RSM 10MF 5X7		CD74	CEXF1C100A	C ELECTRO	16V RSM 10MF 5X7	
C334	CEXF1C470A	C ELECTRO	16V RSM 47MF (5X7) TP		L001	5CPX100J2T	COIL PEAKING	10UH(BRN-BLK)	
C336	CEXF1C470A	C ELECTRO	16V RSM 47MF (5X7) TP		L002	5CPX100J2T	COIL PEAKING	10UH(BRN-BLK)	
C338	CEXF1H109A	C ELECTRO	50V RSM 1MF (4X7) TP		L004	5CPX101J2T	COIL PEAKING	100UH(BRN-BRN)	
C375	CMXM2A222J	C MYLAR	100V 2200PF J (TP)	SECAM ONLY	L051	5CPX100J2T	COIL PEAKING	10UH(BRN-BLK)	
C376	CMXM2A222J	C MYLAR	100V 2200PF J (TP)	SECAM ONLY	L052	5CPX101J2T	COIL PEAKING	100UH(BRN-BRN)	
C377	CEXF1H229A	C ELECTRO	50V RSM 2.2MF (4X7) TP	SECAM ONLY	L053	5CPX100J2T	COIL PEAKING	10UH(BRN-BLK)	
C378	CEXF1C470A	C ELECTRO	16V RSM 47MF (5X7) TP	SECAM ONLY	L201	5CPX101J2T	COIL PEAKING	100UH(BRN-BRN)	
C389	CEXF1C100A	C ELECTRO	16V RSM 10MF 5X7		L203	5CPX101J2T	COIL PEAKING	100UH(BRN-BRN)	
C402	CEXF1H109A	C ELECTRO	50V RSM 1MF (4X7) TP		L250	5CPX101J2T	COIL PEAKING	100UH(BRN-BRN)	
C403	CEXF1C470A	C ELECTRO	16V RSM 47MF (5X7) TP		L251	5CPX101J2T	COIL PEAKING	100UH(BRN-BRN)	
C501	CEXF1A471V	C ELECTRO	10V RSS 470MF (8X11.5) TP		L301	5CPX100J2T	COIL PEAKING	10UH(BRN-BLK)	
C504	CEXF1C470A	C ELECTRO	16V RSM 47MF (5X7) TP		L302	5CPX100J2T	COIL PEAKING	10UH(BRN-BLK)	
C508	CEXF1E221V	C ELECTRO	25V RSS 220MF (8X11.5) TP		L303	5CPX100J2T	COIL PEAKING	10UH(BRN-BLK)	
C512	CEXF1C470A	C ELECTRO	16V RSM 47MF (5X7) TP		L365	5CPX100J2T	COIL PEAKING	10UH(BRN-BLK)	SECAM ONLY
C513	CEXF1C100A	C ELECTRO	16V RSM 10MF 5X7		L501	5CPX100J2T	COIL PEAKING	10UH(BRN-BLK)	
C522	CEXF1C470A	C ELECTRO	16V RSM 47MF (5X7) TP		L503	5CPX680J2T	COIL PEAKING	68UH(BLU-BLK)	
C524	CEXF1C470A	C ELECTRO	16V RSM 47MF (5X7) TP		L603	5CPX100J2T	COIL PEAKING	10UH(BRN-BLK)	
C526	CEXF1H109A	C ELECTRO	50V RSM 1MF (4X7) TP		L853	56C220K695	COIL CHOKE(CAP TYPE)	22UH K 9X11.1 (CAP TYPE)	
C530	CEXF1C470A	C ELECTRO	16V RSM 47MF (5X7) TP		L860	56C220K695	COIL CHOKE(CAP TYPE)	22UH K 9X11.1 (CAP TYPE)	
C535	CEXF1C470A	C ELECTRO	16V RSM 47MF (5X7) TP		LD02	5CPX101J2T	COIL PEAKING	100UH(BRN-BRN)	
C617	CEXF1C470A	C ELECTRO	16V RSM 47MF (5X7) TP		LD03	5CPX680J2T	COIL PEAKING	68UH(BLU-BLK)	
C618	CEXF1A471V	C ELECTRO	10V RSS 470MF (8X11.5) TP		LD04	5CPX101J2T	COIL PEAKING	100UH(BRN-BRN)	
C620	CEXF1A471V	C ELECTRO	10V RSS 470MF (8X11.5) TP		LD51	5CPX100J2T	COIL PEAKING	10UH(BRN-BLK)	
C635	CEXF1C100A	C ELECTRO	16V RSM 10MF 5X7		Q201	IZTC3198Y-	TRANSISTOR	KTC3198Y-(1815Y) (AUTO)	
C637	CEXF1C100A	C ELECTRO	16V RSM 10MF 5X7		Q203	IZTC3202Y-	TR	KTC3202Y (AUTO)(1959Y)	
C643	CEXF1C100A	C ELECTRO	16V RSM 10MF 5X7		Q204	IZTC3198Y-	TRANSISTOR	KTC3198Y-(1815Y) (AUTO)	
C644	CEXF1C100A	C ELECTRO	16V RSM 10MF 5X7		Q205	IZTC3198Y-	TRANSISTOR	KTC3198Y-(1815Y) (AUTO)	
C645	CEXF1A471V	C ELECTRO	10V RSS 470MF (8X11.5) TP		Q206	IZTA1266Y-	TR	KTA1266Y- (AUTO)(1015Y)	
C647	CEXF1C100A	C ELECTRO	16V RSM 10MF 5X7		Q207	IZTA1266Y-	TR	KTA1266Y- (AUTO)(1015Y)	
C648	CEXF1C100A	C ELECTRO	16V RSM 10MF 5X7		Q208	IZTC3198Y-	TRANSISTOR	KTC3198Y-(1815Y) (AUTO)	
C649	CEXF1C100A	C ELECTRO	16V RSM 10MF 5X7		Q601	IZSR2001	TR	KSR2001 (AUTO)	
C650	CEXF1C100A	C ELECTRO	16V RSM 10MF 5X7		Q602	IZRC104M	TR	KRC104M AUTO	
C852	CEXF1C470A	C ELECTRO	16V RSM 47MF (5X7) TP		Q603	IZRC104M	TR	KRC104M AUTO	
C856	CEXF1E221V	C ELECTRO	25V RSS 220MF (8X11.5) TP		Q644	IZTA1266Y-	TR	KTA1266Y- (AUTO)(1015Y)	
C857	CEXF1E221V	C ELECTRO	25V RSS 220MF (8X11.5) TP		Q670	IZTA1266Y-	TR	KTA1266Y- (AUTO)(1015Y)	
C858	CEXF1E221V	C ELECTRO	25V RSS 220MF (8X11.5) TP		Q671	IZTA1266Y-	TR	KTA1266Y- (AUTO)(1015Y)	
C859	CEXF1C470A	C ELECTRO	16V RSM 47MF (5X7) TP		Q844	IZTC3198Y-	TRANSISTOR	KTC3198Y-(1815Y) (AUTO)	
C860	CEXF1E221V	C ELECTRO	25V RSS 220MF (8X11.5) TP		Q850	IZTC3205Y-	TR	KTC3205Y (2236Y)	
C861	CEXF1A471V	C ELECTRO	10V RSS 470MF (8X11.5) TP		Q851	IZTC3205Y-	TR	KTC3205Y (2236Y)	
C862	CEXF1C470A	C ELECTRO	16V RSM 47MF (5X7) TP		Q852	IZTC3198Y-	TRANSISTOR	KTC3198Y-(1815Y) (AUTO)	
C864	CEXF1C470A	C ELECTRO	16V RSM 47MF (5X7) TP		Q853	IZTA1273Y-	TR	KTA1273Y(966Y)	
C865	CEXF1C470A	C ELECTRO	16V RSM 47MF (5X7) TP		Q856	IZTC3198Y-	TRANSISTOR	KTC3198Y-(1815Y) (AUTO)	
C866	CEXF1C470A	C ELECTRO	16V RSM 47MF (5X7) TP		Q858	IZTC3205Y-	TR	KTC3205Y (2236Y)	
C867	CEXF1C470A	C ELECTRO	16V RSM 47MF (5X7) TP		Q859	IZTC3205Y-	TR	KTC3205Y (2236Y)	
CD07	CEXF1C220A	C ELECTRO	16V RSM 22MF (5X7)		Q860	IZTC3205Y-	TR	KTC3205Y (2236Y)	
CD15	CEXF1C470A	C ELECTRO	16V RSM 47MF (5X7) TP		Q861	IZTC3205Y-	TR	KTC3205Y (2236Y)	
CD16	CEXF1C220A	C ELECTRO	16V RSM 22MF (5X7)		QD01	IZTC3198Y-	TRANSISTOR	KTC3198Y-(1815Y) (AUTO)	
CD19	CEXF1C220A	C ELECTRO	16V RSM 22MF (5X7)		QD02	IZTA1266Y-	TR	KTA1266Y- (AUTO)(1015Y)	
CD24	CEXF1C220A	C ELECTRO	16V RSM 22MF (5X7)		SW511	5S50101Z97	SW TACT	THVV952GBA 9.5M AUTO	
CD50	CEXF1A471V	C ELECTRO	10V RSS 470MF (8X11.5) TP		SW512	5S50101Z97	SW TACT	THVV952GBA 9.5M AUTO	
CD51	CEXF1A471V	C ELECTRO	10V RSS 470MF (8X11.5) TP		SW513	5S50101Z97	SW TACT	THVV952GBA 9.5M AUTO	
CD52	CEXF1A471V	C ELECTRO	10V RSS 470MF (8X11.5) TP		SW516	5S50101Z97	SW TACT	THVV952GBA 9.5M AUTO	

ELECTRICAL PARTSLIST

LOC	PARTS_CODE	PARTS_NAME	PARTS_DESCR	REMARK	LOC	PARTS_CODE	PARTS_NAME	PARTS_DESCR	REMARK
SW517	5S50101Z97	SW TACT	THV502GDA		D616	DZUZ13BSB-	DIODE ZENER	UZ-13BSB(12.59-13.16V)	
SW7B5	5S50101Z90	SW TACT	THV502GDA		D617	DZUZ13BSB-	DIODE ZENER	UZ-13BSB(12.59-13.16V)	
SW7C1	5S50101Z90	SW TACT	THV502GDA		D619	DZUZ5R6BSB	DIODE ZENER	UZ-5.6BSB(5.46-5.70V)	
SW7C2	5S50101Z90	SW TACT	THV502GDA		D630	DZN4148 -	DIODE	1N4148 AUTO 52MM	
SW7C3	5S50101Z90	SW TACT	THV502GDA		D850	DZUZ33BSB-	DIODE ZENER	UZ-33BSB(30.32-31.38V)	
SW7C4	5S50101Z90	SW TACT	THV502GDA		D851	DZUZ13BSB-	DIODE ZENER	UZ-13BSB(12.59-13.16V)	
SW7C5	5S50101Z90	SW TACT	THV502GDA		D852	DZUZ5R6BSB	DIODE ZENER	UZ-5.6BSB(5.46-5.70V)	
X301	5XE4R433TB	CRYSTAL QUARTZ	HC-49IU 4.433619MHZ 15PPM (FORMING)		D855	DZUZ5R6BSB	DIODE ZENER	UZ-5.6BSB(5.46-5.70V)	
Z0013	PVMPJAS202	PCB MAIN AXIAL AS	DC-B87D1S-NA		D856	DZUZ3R9BSB	DIODE ZENER	UZ-3.9BSB(3.92-4.14)	
C002	CBZP1C103M	C CERA SEMI	16V Y5S 0.01MF M (AXIAL)		D857	DZN4003 -	DIODE	1N4003	
C003	CCZB1H101K	C CERA	50V B 100PF K (AXIAL)	PAL ONLY	DD01	DZN4148 -	DIODE	1N4148 AUTO 52MM	
C005	CBZP1C103M	C CERA SEMI	16V Y5S 0.01MF M (AXIAL)		DD02	DZN4148 -	DIODE	1N4148 AUTO 52MM	
C006	CCZB1H101K	C CERA	50V B 100PF K (AXIAL)	PAL ONLY	DD03	DZN4148 -	DIODE	1N4148 AUTO 52MM	
C007	CCZB1H102K	C CERA	50V B 1000PF K (AXIAL)		DD50	DZN4148 -	DIODE	1N4148 AUTO 52MM	
C014	CCZB1H101K	C CERA	50V B 100PF K (AXIAL)		JP230	85801060TA	WIRE COPPER	0.6X52MM TAPING	SECAM ONLY
C160	CBZP1C103M	C CERA SEMI	16V Y5S 0.01MF M (AXIAL)		JP288	85801060TA	WIRE COPPER	0.6X52MM TAPING	SECAM ONLY
C207	CCZF1H104Z	C CERA	HIKF 50V 0.1MF Z AXIAL		JP298	85801060TA	WIRE COPPER	0.6X52MM TAPING	SECAM ONLY
C321	CCZF1H104Z	C CERA	HIKF 50V 0.1MF Z AXIAL		JP299	85801060TA	WIRE COPPER	0.6X52MM TAPING	SECAM ONLY
C323	CCZF1H104Z	C CERA	HIKF 50V 0.1MF Z AXIAL		JP303	RD-AZ102J-	R CARBON FILM	1/6 1K OHM J	
C324	CCZF1H104Z	C CERA	HIKF 50V 0.1MF Z AXIAL		JP304	RD-AZ102J-	R CARBON FILM	1/6 1K OHM J	
C326	CCZF1H104Z	C CERA	HIKF 50V 0.1MF Z AXIAL		L151	5CPZ569K02	COIL PEAKING	5.6UH K (AXIAL 3.5MM)	
C329	CCZF1H104Z	C CERA	HIKF 50V 0.1MF Z AXIAL		L311	5CPZ100K02	COIL PEAKING	10UH K (AXIAL 3.5MM)	
C337	CBZP1C103M	C CERA SEMI	16V Y5S 0.01MF M (AXIAL)		L340	5CPZ229K02	COIL PEAKING	2.2UH K (AXIAL 3.5MM)	
C341	CCZF1H104Z	C CERA	HIKF 50V 0.1MF Z AXIAL		L341	5CPZ229K02	COIL PEAKING	2.2UH K (AXIAL 3.5MM)	
C342	CBZP1C103M	C CERA SEMI	16V Y5S 0.01MF M (AXIAL)		L342	5CPZ229K02	COIL PEAKING	2.2UH K (AXIAL 3.5MM)	
C350	CCZB1H221K	C CERA	50V B 220PF K (AXIAL)		L526	5CPZ100K02	COIL PEAKING	10UH K (AXIAL 3.5MM)	
C361	CBZP1C103M	C CERA SEMI	16V Y5S 0.01MF M (AXIAL)	SECAM ONLY	L602	5CPZ229K02	COIL PEAKING	2.2UH K (AXIAL 3.5MM)	
C502	CBZP1C103M	C CERA SEMI	16V Y5S 0.01MF M (AXIAL)		L604	5CPZ229K02	COIL PEAKING	2.2UH K (AXIAL 3.5MM)	
C511	CBZP1C103M	C CERA SEMI	16V Y5S 0.01MF M (AXIAL)		L605	5CPZ229K02	COIL PEAKING	2.2UH K (AXIAL 3.5MM)	
C517	CCZB1H102K	C CERA	50V B 1000PF K (AXIAL)		L606	5CPZ229K02	COIL PEAKING	2.2UH K (AXIAL 3.5MM)	
CD10	CCZB1H181K	C CERA	50V B 180PF K (AXIAL)		L612	5CPZ229K02	COIL PEAKING	2.2UH K (AXIAL 3.5MM)	
CD22	CCZB1H181K	C CERA	50V B 180PF K (AXIAL)		L613	5CPZ229K02	COIL PEAKING	2.2UH K (AXIAL 3.5MM)	
CD61	CCZF1H104Z	C CERA	HIKF 50V 0.1MF Z AXIAL		R001	RD-AZ221J-	R CARBON FILM	1/6 220 OHM J	PAL ONLY
D001	DZN4148 -	DIODE	1N4148 AUTO 52MM		R002	RD-AZ221J-	R CARBON FILM	1/6 220 OHM J	PAL ONLY
D003	DZN4003 -	DIODE	1N4003		R003	RD-AZ122J-	R CARBON FILM	1/6 1.2K OHM J	PAL ONLY
D301	DZN4148 -	DIODE	1N4148 AUTO 52MM		R004	RD-AZ102J-	R CARBON FILM	1/6 1K OHM J	
D501	DZN4148 -	DIODE	1N4148 AUTO 52MM		R005	RD-AZ221J-	R CARBON FILM	1/6 220 OHM J	
D503	DZN4148 -	DIODE	1N4148 AUTO 52MM		R006	RD-AZ221J-	R CARBON FILM	1/6 220 OHM J	
D509	DZN4148 -	DIODE	1N4148 AUTO 52MM		R009	RD-AZ222J-	R CARBON FILM	1/6 2.2K OHM J	PAL ONLY
D510	DZN4148 -	DIODE	1N4148 AUTO 52MM		R051	RD-AZ751J-	R CARBON FILM	1/6 750 OHM J	
D511	DZN4148 -	DIODE	1N4148 AUTO 52MM		R052	RD-AZ751J-	R CARBON FILM	1/6 750 OHM J	
D512	DZN4148 -	DIODE	1N4148 AUTO 52MM		R054	RD-AZ102J-	R CARBON FILM	1/6 1K OHM J	
D513	DZN4148 -	DIODE	1N4148 AUTO 52MM		R190	RD-AZ221J-	R CARBON FILM	1/6 220 OHM J	
D518	DZN4148 -	DIODE	1N4148 AUTO 52MM		R204	RD-AZ113J-	R CARBON FILM	1/6 11K OHM J	
D519	DZN4148 -	DIODE	1N4148 AUTO 52MM		R207	RD-AZ563J-	R CARBON FILM	1/6 56K OHM J	
D520	DZN4148 -	DIODE	1N4148 AUTO 52MM		R214	RD-AZ511J-	R CARBON FILM	1/6 510 OHM J	
D521	DZN4003 -	DIODE	1N4003		R215	RD-AZ821J-	R CARBON FILM	1/6 820 OHM J	
D523	DZN4003 -	DIODE	1N4003		R217	RD-AZ223J-	R CARBON FILM	1/6 22K OHM J	
D524	DZN4148 -	DIODE	1N4148 AUTO 52MM		R218	RD-AZ222J-	R CARBON FILM	1/6 2.2K OHM J	
D525	DZN4004 -	DIODE	1N4004(AUTO)		R219	RD-AZ103J-	R CARBON FILM	1/6 10K OHM J	
D531	DZUZ5R6BSB	DIODE ZENER	UZ-5.6BSB(5.46-5.70V)		R232	RD-AZ223J-	R CARBON FILM	1/6 22K OHM J	
D612	DZUZ5R6BSB	DIODE ZENER	UZ-5.6BSB(5.46-5.70V)		R265	85801060TA	WIRE COPPER	0.6X52MM TAPING	
D613	DZUZ5R6BSB	DIODE ZENER	UZ-5.6BSB(5.46-5.70V)		R266	RD-AZ333J-	R CARBON FILM	1/6 33K OHM J	
D614	DZUZ13BSB-	DIODE ZENER	UZ-13BSB(12.59-13.16V)		R267	RD-AZ272J-	R CARBON FILM	1/6 2.7K OHM J	
D615	DZUZ13BSB-	DIODE ZENER	UZ-13BSB(12.59-13.16V)		R268	RN-AZ3902F	R METAL FILM	1/6 39K OHM F	

ELECTRICAL PARTSLIST

LOC	PARTS_CODE	PARTS_NAME	PARTS_DESCR	REMARK	LOC	PARTS_CODE	PARTS_NAME	PARTS_DESCR	REMARK
R269	RD-AZ272J-	R CARBON FILM	1/6 2.7K OHM J		R638	RD-AZ103J-	R CARBON FILM	1/6 10K OHM J	
R276	RD-AZ183J-	R CARBON FILM	1/6 18K OHM J		R644	RD-4Z751J-	R CARBON FILM	1/4 750 OHM J	
R277	RD-AZ511J-	R CARBON FILM	1/6 510 OHM J		R670	RD-4Z751J-	R CARBON FILM	1/4 750 OHM J	
R278	RD-AZ511J-	R CARBON FILM	1/6 510 OHM J		R671	RD-4Z751J-	R CARBON FILM	1/4 750 OHM J	
R303	RD-AZ102J-	R CARBON FILM	1/6 1K OHM J	SECAM ONLY	R678	RD-AZ221J-	R CARBON FILM	1/6 220 OHM J	
R305	RD-AZ434J-	R CARBON FILM	1/6 430K OHM J		R844	RD-AZ103J-	R CARBON FILM	1/6 10K OHM J	
R306	RD-AZ474J-	R CARBON FILM	1/6 470K OHM J		R850	RD-AZ272J-	R CARBON FILM	1/6 2.7K OHM J	
R316	RD-AZ183J-	R CARBON FILM	1/6 18K OHM J		R851	RD-AZ272J-	R CARBON FILM	1/6 2.7K OHM J	
R321	RD-AZ102J-	R CARBON FILM	1/6 1K OHM J		R853	RD-2Z751JS	R CARBON FILM	1/2 750 OHM J SMALL	
R322	RD-AZ272J-	R CARBON FILM	1/6 2.7K OHM J		R854	RD-4Z102JS	R CARBON FILM	1/4 1K OHM J SMALL	
R323	RD-AZ682J-	R CARBON FILM	1/6 6.8K OHM J		R856	RD-AZ472J-	R CARBON FILM	1/6 4.7K OHM J	
R325	RD-AZ122J-	R CARBON FILM	1/6 1.2K OHM J		R857	RD-AZ202J-	R CARBON FILM	1/6 2K OHM J	
R329	RD-AZ102J-	R CARBON FILM	1/6 1K OHM J		R859	RD-AZ101J-	R CARBON FILM	1/6 100 OHM J	
R330	RD-AZ223J-	R CARBON FILM	1/6 22K OHM J		R860	RD-AZ561J-	R CARBON FILM	1/6 560 OHM J	
R331	RD-AZ103J-	R CARBON FILM	1/6 10K OHM J		R861	RD-AZ241J-	R CARBON FILM	1/6 240 OHM J	
R350	RD-AZ221J-	R CARBON FILM	1/6 220 OHM J		R862	RD-AZ201J-	R CARBON FILM	1/6 200 OHM J	
R351	RD-AZ430J-	R CARBON FILM	1/6 43 OHM J		RD04	RD-AZ102J-	R CARBON FILM	1/6 1K OHM J	
R370	RD-AZ473J-	R CARBON FILM	1/6 47K OHM J		RD10	RD-AZ471J-	R CARBON FILM	1/6 470 OHM J	
R381	RD-AZ103J-	R CARBON FILM	1/6 10K OHM J	SECAM ONLY	RD13	RD-AZ221J-	R CARBON FILM	1/6 220 OHM J	
R399	RD-AZ102J-	R CARBON FILM	1/6 1K OHM J		RD14	RD-AZ102J-	R CARBON FILM	1/6 1K OHM J	
R402	RD-AZ393J-	R CARBON FILM	1/6 39K OHM J		RD19	RD-AZ471J-	R CARBON FILM	1/6 470 OHM J	
R403	RD-AZ122J-	R CARBON FILM	1/6 1.2K OHM J		RD22	RD-AZ221J-	R CARBON FILM	1/6 220 OHM J	
R423	RD-AZ153J-	R CARBON FILM	1/6 15K OHM J		RD26	RD-AZ333J-	R CARBON FILM	1/6 33K OHM J	
R513	RD-AZ331J-	R CARBON FILM	1/6 330 OHM J		RD27	RD-AZ104J-	R CARBON FILM	1/6 100K OHM J	
R514	RD-AZ331J-	R CARBON FILM	1/6 330 OHM J		RD28	RD-AZ333J-	R CARBON FILM	1/6 33K OHM J	
R525	RD-AZ104J-	R CARBON FILM	1/6 100K OHM J		RD29	RD-AZ104J-	R CARBON FILM	1/6 100K OHM J	
R535	RD-AZ473J-	R CARBON FILM	1/6 47K OHM J		RD31	RD-AZ103J-	R CARBON FILM	1/6 10K OHM J	
R537	RD-AZ473J-	R CARBON FILM	1/6 47K OHM J		RD32	RD-AZ103J-	R CARBON FILM	1/6 10K OHM J	
R540	RN-AZ103F-	R METAL FILM	1/6 10K OHM F		RD50	RD-AZ221J-	R CARBON FILM	1/6 220 OHM J	
R541	RN-AZ103F-	R METAL FILM	1/6 10K OHM F		RD51	RD-AZ221J-	R CARBON FILM	1/6 220 OHM J	
R545	RD-AZ121J-	R CARBON FILM	1/6 120 OHM J		RD52	RD-AZ221J-	R CARBON FILM	1/6 220 OHM J	
R546	RD-AZ121J-	R CARBON FILM	1/6 120 OHM J		RD54	RD-AZ220J-	R CARBON FILM	1/6 22 OHM J	
R550	RD-AZ472J-	R CARBON FILM	1/6 4.7K OHM J		RD56	RD-AZ101J-	R CARBON FILM	1/6 100 OHM J	
R551	RD-AZ104J-	R CARBON FILM	1/6 100K OHM J		RD57	RD-AZ101J-	R CARBON FILM	1/6 100 OHM J	
R555	RD-AZ103J-	R CARBON FILM	1/6 10K OHM J		RD58	RD-AZ101J-	R CARBON FILM	1/6 100 OHM J	
R556	RD-AZ102J-	R CARBON FILM	1/6 1K OHM J		RD61	RD-AZ750J-	R CARBON FILM	1/6 75 OHM J	
R557	RD-AZ102J-	R CARBON FILM	1/6 1K OHM J		RD64	RD-AZ102J-	R CARBON FILM	1/6 1K OHM J	
R558	RD-AZ153J-	R CARBON FILM	1/6 15K OHM J		RD65	RD-AZ470J-	R CARBON FILM	1/6 47 OHM J	
R559	RD-AZ102J-	R CARBON FILM	1/6 1K OHM J		RD70	RD-AZ510J-	R CARBON FILM	1/6 51 OHM J	
R560	RD-AZ102J-	R CARBON FILM	1/6 1K OHM J		RD71	RD-AZ510J-	R CARBON FILM	1/6 51 OHM J	
R588	RD-2Z189JS	R CARBON FILM	1/2 1.8 OHM J SMALL		RD72	RD-AZ510J-	R CARBON FILM	1/6 51 OHM J	
R602	RD-AZ391J-	R CARBON FILM	1/6 390 OHM J		RD73	RD-AZ510J-	R CARBON FILM	1/6 51 OHM J	
R603	RD-AZ391J-	R CARBON FILM	1/6 390 OHM J		RD74	RD-AZ103J-	R CARBON FILM	1/6 10K OHM J	
R610	RD-AZ103J-	R CARBON FILM	1/6 10K OHM J		RD75	RD-AZ102J-	R CARBON FILM	1/6 1K OHM J	
R612	RD-AZ103J-	R CARBON FILM	1/6 10K OHM J		RD76	RD-AZ102J-	R CARBON FILM	1/6 1K OHM J	
R616	RD-AZ301J-	R CARBON FILM	1/6 300 OHM J		U001	97P65358MA	PCB MAIN	330X246 D1B	
R617	RD-AZ301J-	R CARBON FILM	1/6 300 OHM J		Z0011	PVMGJ1LG00	PCB MPEG CHIP AS	DOL-2303 BASIC(2CH)	
R625	RD-AZ474J-	R CARBON FILM	1/6 470K OHM J		CA11	HCFH104ZBA	C CHIP CERA	25V Y5V 0.1MF Z 1608	
R626	RD-AZ474J-	R CARBON FILM	1/6 470K OHM J		CA12	HCFH104ZBA	C CHIP CERA	25V Y5V 0.1MF Z 1608	
R627	RD-AZ474J-	R CARBON FILM	1/6 470K OHM J		CA13	HCFH104ZBA	C CHIP CERA	25V Y5V 0.1MF Z 1608	
R628	RD-AZ474J-	R CARBON FILM	1/6 470K OHM J		CA14	HCQK121JBA	C CHIP CERA	50V CH 120PF J 1608	
R631	85801060TA	WIRE COPPER	0.6X52MM TAPING		CA16	HCBK102KBA	C CHIP CERA	50V X7R 1000PF K 1608	
R635	RD-AZ203J-	R CARBON FILM	1/6 20K OHM J		CA17	HCBK102KBA	C CHIP CERA	50V X7R 1000PF K 1608	
R636	RD-AZ203J-	R CARBON FILM	1/6 20K OHM J		CA18	HCFH104ZBA	C CHIP CERA	25V Y5V 0.1MF Z 1608	
R637	RD-AZ103J-	R CARBON FILM	1/6 10K OHM J		CA19	HCQK331JBA	C CHIP CERA	50V CH 330PF J 1608	

ELECTRICAL PARTSLIST

LOC	PARTS_CODE	PARTS_NAME	PARTS_DESCR	REMARK	LOC	PARTS_CODE	PARTS_NAME	PARTS_DESCR	REMARK
CA20	HCBF224KBA	C CHIP CERA	16V X7R 0.22MF K 1608		CD13	HCFH104ZBA	C CHIP CERA	25V Y5V 0.1MF Z 1608	
CA21	HCBK471KBA	C CHIP CERA	50V X7R 470PF K 1608		CD14	HCFH104ZBA	C CHIP CERA	25V Y5V 0.1MF Z 1608	
CA22	HCBK471KBA	C CHIP CERA	50V X7R 470PF K 1608		CD15	HCFH104ZBA	C CHIP CERA	25V Y5V 0.1MF Z 1608	
CA23	HCBK391KBA	C CHIP CERA	50V X7R 390PF K 1608		CD16	HCFH104ZBA	C CHIP CERA	25V Y5V 0.1MF Z 1608	
CA24	HCFH104ZBA	C CHIP CERA	25V Y5V 0.1MF Z 1608		CD17	HCFH104ZBA	C CHIP CERA	25V Y5V 0.1MF Z 1608	
CA26	HCBK561KBA	C CHIP CERA	50V X7R 560PF K 1608		CD18	HCFH104ZBA	C CHIP CERA	25V Y5V 0.1MF Z 1608	
CA27	HCFH104ZBA	C CHIP CERA	25V Y5V 0.1MF Z 1608		CD23	HCQK101JBA	C CHIP CERA	50V CH 100PF J 1608	
CA28	HCFH104ZBA	C CHIP CERA	25V Y5V 0.1MF Z 1608		CD24	HCQK101JBA	C CHIP CERA	50V CH 100PF J 1608	
CA29	HCFH104ZBA	C CHIP CERA	25V Y5V 0.1MF Z 1608		CD25	HCFH104ZBA	C CHIP CERA	25V Y5V 0.1MF Z 1608	
CA30	HCFH104ZBA	C CHIP CERA	25V Y5V 0.1MF Z 1608		CD26	HCFH104ZBA	C CHIP CERA	25V Y5V 0.1MF Z 1608	
CA31	HCBK102KBA	C CHIP CERA	50V X7R 1000PF K 1608		CD27	HCFH104ZBA	C CHIP CERA	25V Y5V 0.1MF Z 1608	
CA32	HCBK102KBA	C CHIP CERA	50V X7R 1000PF K 1608		CM11	HCFH104ZBA	C CHIP CERA	25V Y5V 0.1MF Z 1608	
CA33	HCBK102KBA	C CHIP CERA	50V X7R 1000PF K 1608		CM13	HCFH104ZBA	C CHIP CERA	25V Y5V 0.1MF Z 1608	
CA34	HCBK102KBA	C CHIP CERA	50V X7R 1000PF K 1608		CM14	HCFH104ZBA	C CHIP CERA	25V Y5V 0.1MF Z 1608	
CA35	HCBK561KBA	C CHIP CERA	50V X7R 560PF K 1608		CM15	HCFH104ZBA	C CHIP CERA	25V Y5V 0.1MF Z 1608	
CA36	HCBK102KBA	C CHIP CERA	50V X7R 1000PF K 1608		CM16	HCFH104ZBA	C CHIP CERA	25V Y5V 0.1MF Z 1608	
CA37	HCBK102KBA	C CHIP CERA	50V X7R 1000PF K 1608		CM17	HCFH104ZBA	C CHIP CERA	25V Y5V 0.1MF Z 1608	
CA38	HCBK471KBA	C CHIP CERA	50V X7R 470PF K 1608		CM18	HCFH104ZBA	C CHIP CERA	25V Y5V 0.1MF Z 1608	
CA39	HCBK471KBA	C CHIP CERA	50V X7R 470PF K 1608		CN11	97P62K06EP	CONN FFC SMD	SCB-2223-M-2 SMD ST 1.0	
CA42	HCBK471KBA	C CHIP CERA	50V X7R 470PF K 1608		CN14	97P62K08E9	CONN FFC SMD	SCB-2209-T-2 SMD RA 1.0	
CA43	HCBK471KBA	C CHIP CERA	50V X7R 470PF K 1608		CN15	97P62K06EK	CONN FFC SMD	SCB-2219-M-2 SMD ST 1.0	
CA44	HCBK471KBA	C CHIP CERA	50V X7R 470PF K 1608		CN18	97P62K06EF	CONN FFC SMD	SCB-2215-M-2 SMD ST 1.0	
CA45	HCBK471KBA	C CHIP CERA	50V X7R 470PF K 1608		CP11	HCFH104ZBA	C CHIP CERA	25V Y5V 0.1MF Z 1608	
CA46	HCBK471KBA	C CHIP CERA	50V X7R 470PF K 1608		CP12	HCFH104ZBA	C CHIP CERA	25V Y5V 0.1MF Z 1608	
CA47	HCFH104ZBA	C CHIP CERA	25V Y5V 0.1MF Z 1608		CP13	HCFH104ZBA	C CHIP CERA	25V Y5V 0.1MF Z 1608	
CA48	HCFH104ZBA	C CHIP CERA	25V Y5V 0.1MF Z 1608		CP14	HCBK471KBA	C CHIP CERA	50V X7R 470PF K 1608	
CA49	HCFH104ZBA	C CHIP CERA	25V Y5V 0.1MF Z 1608		CP15	HCFH105ZBA	C CHIP CERA	16V Y5V 1MF Z 1608	
CB11	HCQK101JBA	C CHIP CERA	50V CH 100PF J 1608		CP16	HCFH105ZBA	C CHIP CERA	16V Y5V 1MF Z 1608	
CC11	HCFH104ZBA	C CHIP CERA	25V Y5V 0.1MF Z 1608		CP17	HCFH104ZBA	C CHIP CERA	25V Y5V 0.1MF Z 1608	
CC12	HCFH104ZBA	C CHIP CERA	25V Y5V 0.1MF Z 1608		CP18	HCFH104ZBA	C CHIP CERA	25V Y5V 0.1MF Z 1608	
CC13	HCBK103KBA	C CHIP CERA	50V X7R 0.01MF K 1608		CP19	HCFH105ZBA	C CHIP CERA	16V Y5V 1MF Z 1608	
CC14	HCFH104ZBA	C CHIP CERA	25V Y5V 0.1MF Z 1608		CP20	HCFH104ZBA	C CHIP CERA	25V Y5V 0.1MF Z 1608	
CC16	HCBK393KBA	C CHIP CERA	50V X7R 0.039MF K 1608		DA11	DRLS4148-B	DIODE CHIP	RLS4148TE-11 3415	
CC17	HCFH104ZBA	C CHIP CERA	25V Y5V 0.1MF Z 1608		DA12	DRLS4148-B	DIODE CHIP	RLS4148TE-11 3415	
CC18	HCQK330JBA	C CHIP CERA	50V CH 33PF J 1608		DD13	DRLS4148-B	DIODE CHIP	RLS4148TE-11 3415	
CC19	HCQK330JBA	C CHIP CERA	50V CH 33PF J 1608		IA02	1SA5810 E	IC CHIP DRIVER	SA5810 28 PIN HSOP REEL	
CC20	HRFS000-BA	R CHIP	1/16 0 OHM 1608		IA13	TZM6K2 -Q	FET CHIP	SM6K2 T110 SOT-457 60V 0.2A 2EA	
CC21	HCBK471KBA	C CHIP CERA	50V X7R 470PF K 1608		IC11	1M3355 -Q	IC DVD 1 CHIP	M3355 216-PIN LOFP TRAY	
CC22	HCFH104ZBA	C CHIP CERA	25V Y5V 0.1MF Z 1608		IC12	1BD5229G-B	IC CHIP RESET	BD5229G-TR 2.9V 5 PIN SSOP5 REEL	
CC23	HCFH104ZBA	C CHIP CERA	25V Y5V 0.1MF Z 1608		IC13	14ATM24D08	IC CHIP EEPROM	AT24C08N 10SI-2.7 SOIC	
CC24	HCFH104ZBA	C CHIP CERA	25V Y5V 0.1MF Z 1608		IC14	1MX26LV80Q	IC CHIP FLASH ROM	MX26LV800TTC-55 48PIN TSOP TRAY	
CC25	HCFH104ZBA	C CHIP CERA	25V Y5V 0.1MF Z 1608		IC15	1ADS6616AQ	IC CHIP SDRAM	ADS6616A4A-6 (4X16) 166M 54PIN TSOP TRAY	
CC26	HCFH104ZBA	C CHIP CERA	25V Y5V 0.1MF Z 1608		LA11	HLX1210001	BEAD CHIP	TB201209Z121	
CC27	HCFH104ZBA	C CHIP CERA	25V Y5V 0.1MF Z 1608		LA12	HLX1210001	BEAD CHIP	TB201209Z121	
CC28	HCFH104ZBA	C CHIP CERA	25V Y5V 0.1MF Z 1608		LA13	HLX1210001	BEAD CHIP	TB201209Z121	
CC29	HCFH104ZBA	C CHIP CERA	25V Y5V 0.1MF Z 1608		LA14	HLX1210001	BEAD CHIP	TB201209Z121	
CC30	HCFH104ZBA	C CHIP CERA	25V Y5V 0.1MF Z 1608		LD13	HLX1210001	BEAD CHIP	TB201209Z121	
CC31	HCFH104ZBA	C CHIP CERA	25V Y5V 0.1MF Z 1608		LP12	HLX1210001	BEAD CHIP	TB201209Z121	
CC32	HCFH104ZBA	C CHIP CERA	25V Y5V 0.1MF Z 1608		LP13	HLX1210001	BEAD CHIP	TB201209Z121	
CC33	HCFH104ZBA	C CHIP CERA	25V Y5V 0.1MF Z 1608		LP14	HLX1210001	BEAD CHIP	TB201209Z121	
CC34	HCFH104ZBA	C CHIP CERA	25V Y5V 0.1MF Z 1608		LP15	HLX1210001	BEAD CHIP	TB201209Z121	
CC35	HCFH104ZBA	C CHIP CERA	25V Y5V 0.1MF Z 1608		LP16	HLX1210001	BEAD CHIP	TB201209Z121	
CC36	HCFH104ZBA	C CHIP CERA	25V Y5V 0.1MF Z 1608		LP17	HLX1210001	BEAD CHIP	TB201209Z121	
CD11	HCFH104ZBA	C CHIP CERA	25V Y5V 0.1MF Z 1608		LP18	HLX1210001	BEAD CHIP	TB201209Z121	
CD12	HCFH104ZBA	C CHIP CERA	25V Y5V 0.1MF Z 1608		LP19	HLX1210001	BEAD CHIP	TB201209Z121	

ELECTRICAL PARTSLIST

LOC	PARTS_CODE	PARTS_NAME	PARTS_DESCR	REMARK	LOC	PARTS_CODE	PARTS_NAME	PARTS_DESCR	REMARK
LP20	HLX1210001	BEAD CHIP	TB201209Z121		RC29	HRFS103JBA	R CHIP	1/16 10K OHM J 1608	
QA11	TZHU002N-Q	FET CHIP	RHU002N06 T106 SOT-323 60V 0.2A		RC30	HRFS330JBA	R CHIP	1/16 33 OHM J 1608	
QA12	T2SB1132-B	TR CHIP	2SB1132 R MTP3 T100		RC31	HRFS330JBA	R CHIP	1/16 33 OHM J 1608	
QA13	T2SB1132-B	TR CHIP	2SB1132 R MTP3 T100		RC32	HRFS330JBA	R CHIP	1/16 33 OHM J 1608	
RA11	HRFS472JBA	R CHIP	1/16 4.7K OHM J 1608		RC33	HRFS330JBA	R CHIP	1/16 33 OHM J 1608	
RA12	HRFS472JBA	R CHIP	1/16 4.7K OHM J 1608		RC34	HRFS330JBA	R CHIP	1/16 33 OHM J 1608	
RA14	HRFS472JBA	R CHIP	1/16 4.7K OHM J 1608		RC35	HRFS330JBA	R CHIP	1/16 33 OHM J 1608	
RA16	HRFS000-BA	R CHIP	1/16 0 OHM 1608		RC36	HRFS330JBA	R CHIP	1/16 33 OHM J 1608	
RA17	HRFS101JBA	R CHIP	1/16 100 OHM J 1608		RC37	HRFS472JBA	R CHIP	1/16 4.7K OHM J 1608	
RA18	HRFS101JBA	R CHIP	1/16 100 OHM J 1608		RC39	HRFS472JBA	R CHIP	1/16 4.7K OHM J 1608	
RA19	HRFS102JBA	R CHIP	1/16 1K OHM J 1608		RC40	HRFS000-BA	R CHIP	1/16 0 OHM 1608	
RA20	HRFS102JBA	R CHIP	1/16 1K OHM J 1608		RC41	HRFS101JBA	R CHIP	1/16 100 OHM J 1608	
RA21	HRFS000-BA	R CHIP	1/16 0 OHM 1608		RC42	HRFS101JBA	R CHIP	1/16 100 OHM J 1608	
RA22	HRFS100JBA	R CHIP	1/16W 10 OHM J 1608		RC45	HRFS101JBA	R CHIP	1/16 100 OHM J 1608	
RA23	HRFS100JBA	R CHIP	1/16W 10 OHM J 1608		RC46	HRFS000-BA	R CHIP	1/16 0 OHM 1608	
RA24	HRFS100JBA	R CHIP	1/16W 10 OHM J 1608		RD11	HRFS103JBA	R CHIP	1/16 10K OHM J 1608	
RA25	HRFS100JBA	R CHIP	1/16W 10 OHM J 1608		RD12	HRFS103JBA	R CHIP	1/16 10K OHM J 1608	
RA26	HRFS000-BA	R CHIP	1/16 0 OHM 1608		RD13	HRFS123JBA	R CHIP	1/16 12K OHM J 1608	
RA27	HRFS000-BA	R CHIP	1/16 0 OHM 1608		RD14	HRFS362JBA	R CHIP	1/16 3.6K OHM J 1608	
RA28	HRFS123JBA	R CHIP	1/16 12K OHM J 1608		RD15	HRFS223JBA	R CHIP	1/16 22K OHM J 1608	
RA31	HRFS822JBA	R CHIP	1/16 8.2K OHM J 1608		RD16	HRFS103JBA	R CHIP	1/16 10K OHM J 1608	
RA32	HRFS222JBA	R CHIP	1/16 2.2K OHM J 1608		RD17	HRFS103JBA	R CHIP	1/16 10K OHM J 1608	
RA33	HRFS222JBA	R CHIP	1/16 2.2K OHM J 1608		RD18	HRFS103JBA	R CHIP	1/16 10K OHM J 1608	
RA34	HRFS222JBA	R CHIP	1/16 2.2K OHM J 1608		RD19	HRFS333JBA	R CHIP	1/16 33K OHM J 1608	
RA35	HRFS222JBA	R CHIP	1/16 2.2K OHM J 1608		RD20	HRFS472JBA	R CHIP	1/16 4.7K OHM J 1608	
RA36	HRFS433JBA	R CHIP	1/16W 43K OHM J 1608		RD21	HRFS103JBA	R CHIP	1/16 10K OHM J 1608	
RA37	HRFS103JBA	R CHIP	1/16 10K OHM J 1608		RD22	HRFS223JBA	R CHIP	1/16 22K OHM J 1608	
RB16	HRFS330JBA	R CHIP	1/16 33 OHM J 1608		RD23	HRFS472JBA	R CHIP	1/16 4.7K OHM J 1608	
RB18	HRFS330JBA	R CHIP	1/16 33 OHM J 1608		RD24	HRFS330JBA	R CHIP	1/16 33 OHM J 1608	
RB20	HRFS330JBA	R CHIP	1/16 33 OHM J 1608		RD25	HRFS103JBA	R CHIP	1/16 10K OHM J 1608	
RB21	HRFS330JBA	R CHIP	1/16 33 OHM J 1608		RD26	HRFS152JBA	R CHIP	1/16 1.5K OHM J 1608	
RB22	HRFS102JBA	R CHIP	1/16 1K OHM J 1608		RD27	HRFS223JBA	R CHIP	1/16 22K OHM J 1608	
RB24	HRFS000-BA	R CHIP	1/16 0 OHM 1608		RD28	HRFS103JBA	R CHIP	1/16 10K OHM J 1608	
RB25	HRFS750JBA	R CHIP	1/16 75 OHM J 1608		RD29	HRFS152JBA	R CHIP	1/16 1.5K OHM J 1608	
RB26	HRFS680JBA	R CHIP	1/16 68 OHM J 1608		RD30	HRFS273JBA	R CHIP	1/16 27K OHM J 1608	
RB27	HRFS000-BA	R CHIP	1/16 0 OHM 1608		RD31	HRFS472JBA	R CHIP	1/16 4.7K OHM J 1608	
RB28	HRFS680JBA	R CHIP	1/16 68 OHM J 1608		RD32	HRFS472JBA	R CHIP	1/16 4.7K OHM J 1608	
RC11	HRFS180JBA	R CHIP	1/16 18 OHM J 1608		RM11	HRFS330JBA	R CHIP	1/16 33 OHM J 1608	
RC12	HRFS180JBA	R CHIP	1/16 18 OHM J 1608		RM12	HRFS330JBA	R CHIP	1/16 33 OHM J 1608	
RC13	HRFS561JBA	R CHIP	1/16 560 OHM J 1608		RM13	HRFS102JBA	R CHIP	1/16 1K OHM J 1608	
RC14	HRFS472JBA	R CHIP	1/16 4.7K OHM J 1608		RM15	HRFS000-BA	R CHIP	1/16 0 OHM 1608	
RC15	HRFS472JBA	R CHIP	1/16 4.7K OHM J 1608		RM16	HRFS103JBA	R CHIP	1/16 10K OHM J 1608	
RC16	HRFS102JBA	R CHIP	1/16 1K OHM J 1608		RM17	HRFS472JBA	R CHIP	1/16 4.7K OHM J 1608	
RC17	HRFS472JBA	R CHIP	1/16 4.7K OHM J 1608		RM28	HRFS472JBA	R CHIP	1/16 4.7K OHM J 1608	
RC18	HRFS201JBA	R CHIP	1/16 200 OHM J 1608		RM30	HRFS000-BA	R CHIP	1/16 0 OHM 1608	
RC19	HRFS472JBA	R CHIP	1/16 4.7K OHM J 1608		RM31	HRFS000-BA	R CHIP	1/16 0 OHM 1608	
RC20	HRFS105JBA	R CHIP	1/16 1M OHM J 1608		RM32	HRFS000-BA	R CHIP	1/16 0 OHM 1608	
RC21	HRFS689JBA	R CHIP	1/16 6.8 OHM J 1608		RM33	HRFS000-BA	R CHIP	1/16 0 OHM 1608	
RC22	HRFS689JBA	R CHIP	1/16 6.8 OHM J 1608		RM34	HRFS102JBA	R CHIP	1/16 1K OHM J 1608	
RC23	HRFS000-BA	R CHIP	1/16 0 OHM 1608		UL01	97Q65326DA	PCB DVD	121X97(243X195/4) C2V	
RC24	HRFS330JBA	R CHIP	1/16 33 OHM J 1608		XC01	5XJ27R00SE	CRYSTAL QUARTZ	HC-49/S 27.000MHZ 20PF 30PPM (SMD)	
RC25	HRFS330JBA	R CHIP	1/16 33 OHM J 1608		Z0012	PVMGJRLG00	PCB MPEG RADIAL AS	DOL-2303 BASIC(2CH)	
RC26	HRFS103JBA	R CHIP	1/16 10K OHM J 1608		CA71	CEXF1C100A	C ELECTRO	16V RSM 10MF 5X7	
RC27	HRFS103JBA	R CHIP	1/16 10K OHM J 1608		CA72	CEXF1A101A	C ELECTRO	10V RSM 100MF 6.3X7	
RC28	HRFS103JBA	R CHIP	1/16 10K OHM J 1608		CA73	CEXF1A101A	C ELECTRO	10V RSM 100MF 6.3X7	

ELECTRICAL PARTSLIST

LOC	PARTS_CODE	PARTS_NAME	PARTS_DESCR	REMARK	LOC	PARTS_CODE	PARTS_NAME	PARTS_DESCR	REMARK
CA74	CEXF1C101A	C ELECTRO	16V RSM 100MF (6.3X7) TP		C806	CBXB3A331K	C CERA SEMI	1KV RR 330PF K	
CC42	CEXF1C100A	C ELECTRO	16V RSM 10MF 5X7		C807	CMXL2G333K	C MYLAR	400V MEU 0.033MF K	
CC43	CEXF1H109A	C ELECTRO	50V RSM 1MF (4X7) TP		C808	CMXM2A473J	C MYLAR	100V 0.047MF J (TP)	
CC55	CEXEJ221S	C ELECTRO	6.3V RSA 220MF 6.3X7		C809	CMXM2A472J	C MYLAR	100V 4700PF J (TP)	
CD30	CEXF1C101A	C ELECTRO	16V RSM 100MF (6.3X7) TP		C810	CMXM2A473J	C MYLAR	100V 0.047MF J (TP)	
CM21	CEXF1A101A	C ELECTRO	10V RSM 100MF 6.3X7		C822	CEXF1A221V	C ELECTRO	10V RSS 220MF	
CP31	CEXF1A101A	C ELECTRO	10V RSM 100MF 6.3X7		C824	CEXK1H470L	C ELECTRO	50V 47MF KXL	
CP32	CEXEJ221S	C ELECTRO	6.3V RSA 220MF 6.3X7		C827	CEXK1A471L	C ELECTRO	10V470UF KXL	
CP33	CEXF1A101A	C ELECTRO	10V RSM 100MF 6.3X7		C828	CMXL1J104K	C MYLAR	MEU 63V 0.1MF K	
CP35	CEXF1A101A	C ELECTRO	10V RSM 100MF 6.3X7		F801	5FWPS2022L	FUSE	WIDE TL 250V 2A CASE	
CP36	CEXF1C470A	C ELECTRO	16V RSM 47MF (5X7) TP		IC802	1KA431AZ	IC REGULATOR	KA431AZ 1% TO-92	
CP37	CEXF1A101A	C ELECTRO	10V RSM 100MF 6.3X7		Q802	TZTC3203Y-	TR	KTC3203Y (2120Y)	
CP38	CEXF1C470A	C ELECTRO	16V RSM 47MF (5X7) TP		Z0082	PVPWJAE435	POWER AXIAL AUTO AS	DC-B87D1D-NB	
CP39	CEXF1C470A	C ELECTRO	16V RSM 47MF (5X7) TP		C805	85801065GY	WIRE COPPER	AWG22 1/0.65 TIN COATING	
CP40	CEXF1A101A	C ELECTRO	10V RSM 100MF 6.3X7		D802	DHER108S	DIODE	HER108S A-405 TYPE	
CP41	CEXEJ221S	C ELECTRO	6.3V RSA 220MF 6.3X7		D803	DZN4003 -	DIODE	IN4003	
Z008	PVPWMSE435	PCB POWER MANUAL AS	DC-B87D1D-NB		D804	DZN4148 -	DIODE	1N4148 AUTO 52MM	
C801	CL2EE3104M	C LINE ACROSS	AC 275V 0.1MF M PCX2 335M		D805	DZUZ3R0BSB	DIODE ZENER	UZ-3.0BSB(3.01-3.22V)	
C802	CHICEE332M	C CERA AC	2.5KV 3300PF M DE AC250V		D806	DZN4005S	DIODE	IN4005S 1A 600V	
C804	CEXF2G470V	C ELECTRO	400V RSS 47MF 16X25		D807	DZN4005S	DIODE	IN4005S 1A 600V	
C811	CHITFE222M	C CERA AC	4.0KV 2200PF M AD AC250V		D808	DZN4005S	DIODE	IN4005S 1A 600V	
C821	CEXK1C102L	C ELECTRO	16V 1000UF KXL (10X20)		D809	DZN4005S	DIODE	IN4005S 1A 600V	
C823	CEXK1E681L	C ELECTRO	25V 680UF KXL		D822	DZ1F3E	DIODE FR	1F3E	
C825	CEXK1E681L	C ELECTRO	25V 680UF KXL		D824	DZ1F3E	DIODE FR	1F3E	
C826	CEXK1C102L	C ELECTRO	16V 1000UF KXL (10X20)		D827	DZ1F3E	DIODE FR	1F3E	
D821	D31DQ06 F	DIODE SCHOTTKY	31DQ06-FC5		D828	DZGDZP18B-	DIODE ZENER	GDZP18B1	
D823	DS2L20U F	DIODE	S2L20U 4004 P15		L805	5PB13857	COIL BEAD	BI3857(AXIAL)	
D825	DS2L20U F	DIODE	S2L20U 4004 P15		R803	RD-4Z394JS	R CARBON FILM	1/4 390K OHM J SMALL	
D826	D31DQ06 F	DIODE SCHOTTKY	31DQ06-FC5		R804	RD-4Z394JS	R CARBON FILM	1/4 390K OHM J SMALL	
IC801	1K1010HE01	IC PHOTO COUPLER	K1010HE01		R805	RD-AZ103J-	R CARBON FILM	1/6 10K OHM J	
L801	5PLF2055	FILTER LINE	LF-2055		R807	RD-2Z820JS	R CARBON FILM	1/2 82 OHM J SMALL	
L802	5PLF2055	FILTER LINE	LF-2055		R808	RD-2Z560JS	R CARBON FILM	1/2 56 OHM J SMALL	
P802	97P62Y02X2	CONN WAFER	YFW800 STR 10MM 2P		R809	RD-AZ681J-	R CARBON FILM	1/6 680 OHM J	
P803	97P885X206	CONN AS	10H-10S 60MM		R810	RC-2Z565KP	R CARBON COMP	1/2 5.6M OHM K	
Q801	TKSC5027FR	TR	KSC5027FR		R821	RD-AZ470J-	R CARBON FILM	1/6 47 OHM J	
R802	RW02B229J-	R WIRE WOUND	2W 2.2 OHM J		R823	RN-AZ132F-	R METAL FILM	1/6 1.3K OHM F	
R806	RS02F104JS	R M-OXIDE FILM	2W 100K OHM J SMALL		R824	RD-AZ470J-	R CARBON FILM	1/6 47 OHM J	
T801	57M8282320	TRANS SMPS	TSW-VE3.0N		R825	RN-AZ182F-	R METAL FILM	1/6 1.8K OHM F	
Z0081	PVPWJRE435	PCB POWER RADIAL AS	DC-B87D1D-NB		UP01	97P65458PA	PCB POWER	(330X199/5)D1B	

* OPTION TABLE

OPTION DIODE(D50*) : DZN4148 - - -(1N4148 AUTO 52MM)

1. SYSTEM

SYSTEM	D501	D502	D503
PAL BG	X	X	X
PAL BG(AUSTRALIA)	X	X	0
PAL BG/DK(MIDDLE EAST)	X	0	X
PAL II(S.AFRICA)	X	0	0
PAL II	0	X	X
SECAM LL'	0	X	0
SECAM LL'(SWISS)	0	0	X
PAL BG/DK	0	0	0

2. Hi-Fi/ Mono

HI-FI/MONO	D504
HI-FI(4H'D)	X
MONO(2H'D)	0

3. MODULATOR output change: BG->DK

BG/DK	D507
BG	X
DK	0

4. SANYO REMOCON KEY CODE

DAEWOO/SANYO	D508
DAEWOO	X
SANYO	0

5. NEW/OLD TMI

NEW/OLD TMI	D509
NEW(SMALL)TMI	X
OLD TMI	0

* REMARK

PAL BG/DK	2 Scart Jack (Non 1 Scart)
PAL II	
SECAM LL'	
SECAM LL'(SWISS)	Phone Jack
PAL BG/DK(AUSTRALIA)	
PAL BG/DK(MIDDLE EAST)	
PAL II(S.AFRICA)	

DAEWOO

DAEWOO ELECTRONICS Corp.

686, AHYEON-DONG MAPO-GU
SEOUL, KOREA
C.P.O. BOX 8003 SEOUL, KOREA