

371

DENON

AV Surround Amplifier

SERVICE MANUAL MODEL AVC-3030 AV SURROUND AMPLIFIER

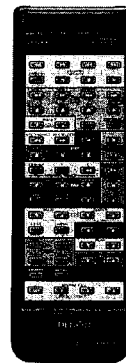
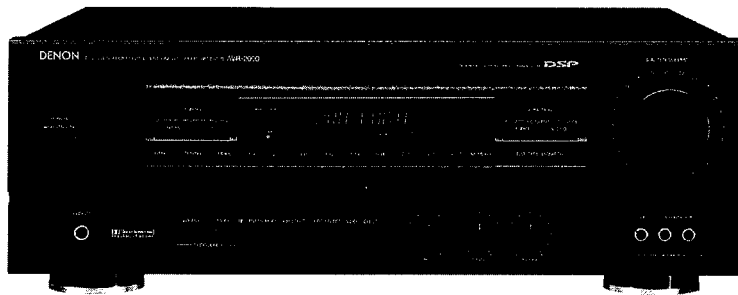

CONTENTS

OPERATING INSTRUCTIONS	2 ~ 28
DISASSEMBLY	29
ADJUSTMENT	30
SEMICONDUCTORS	31 ~ 37
PRINTED WIRING BOARD	38 ~ 42
PRINTED WIRING BOARD PARTS LIST	42 ~ 49
WIRING DIAGRAM	50
SCHEMATIC DIAGRAM	51 ~ 54
BLOCK DIAGRAM	55
EXPLODED VIEW OF CHASSIS AND CABINET	56
PARTS LIST OF EXPLODED VIEW	57
REMOTE CONTROL UNIT	58 ~ 60
SCHEMATIC DIAGRAM	58
EXPLODED VIEW	59
PARTS LIST	60
KEY LAYOUT	60

NIPPON COLUMBIA CO., LTD.

SPECIFICATIONS

- **Audio Section**
 - (Power amplifier)**
 - Rated output:** MAIN (main 2ch driven)
110 W + 110 W (8 ohms, 20 Hz – 20 kHz with 0.03% THD)
CENTER (center 1ch driven)
110 W (8 ohms, 20 Hz – 20 kHz with 0.03% THD)
REAR (rear 2ch driven)
35 W + 35 W (8 ohms, 1 kHz with 0.05% THD)
 - Frequency response:** 5 Hz to 50 kHz (Main in – speaker out)
 - Rated input level / impedance:** 1 V / 47 k ohms (Main in – speaker out)
 - Signal-to-noise ratio:** 120 dB (Main in – speaker out)
 - Output terminals:** Main: A or B 6 to 16 ohms
A + B 12 to 16 ohms
Center: 6 to 16 ohms
Rear: 6 to 16 ohms
 - (Pre-amplifier)**
 - Line input (Each line input – FRONT PRE OUT)**
 - Input sensitivity / impedance:** 150 mV / 47 k ohms PHONO (MM): 2.5 mV / 47 kohms, CD DIRECT: 150 mV / 33 kohms
 - Frequency response:** 5 Hz to 100 kHz: ± 3 dB
5 Hz to 150 kHz: ± 3 dB (CD DIRECT)
 - Tone control range:** BASS: ± 10 dB at 100 Hz
TREBLE: ± 10 dB at 10 kHz
 - Signal-to-noise ratio** 92 dB
 - (FRONT PRE OUT):** 95 dB (CD DIRECT)
 - Distortion factor:** 0.01% 1 kHz 1 V (BYPASS mode)
0.003% 1 kHz 3 V (CD DIRECT)
 - Rated output / Maximum output:** 1 V / 8 V (common for FRONT, CENTER, REAR, MONO, each PRE OUT)
 - Maximum headphone output:** 284 mW (8 ohms)
 - Phono equalizer (PHONO input – REC OUT)**
 - RIAA deviation:** ± 1 dB (20 Hz to 20 kHz)
 - Signal-to-noise ratio:** 76 dB (A weighting, with 5 mV input)
 - Rated output / Maximum output:** 150 mV / 8 V
 - Distortion factor:** 0.03% (1 kHz, 3 V)
- **Video Section**
 - Standard video jacks**
 - Input and output level / impedance:** 1 Vp-p / 75 ohms
 - Frequency response:** 1 Hz to 10 MHz +0, -3 dB
 - S-video output jacks**
 - Input and output level / impedance:** Y (brightness) signal: 1 Vp-p / 75 ohms
C (color) signal: 0.286 Vp-p / 75 ohms
 - Frequency response:** 1 Hz to 11 MHz +0, -3 dB
 - **General**
 - Power supply:** 120 V AC, 60 Hz
 - Power consumption:** 5.5 A
 - Maximum external dimensions:** 434 (W) \times 184 (H) \times 421 (D) mm (17-3/32" \times 7-1/4" \times 16-37/64")
 - Weight:** 15.0 kg (33 lbs 2 oz)
 - **Remote control unit (RC-162):**
 - System remote control with learning function**
 - Total buttons: 62
 - DENON system code
 - DAT: 8 buttons
 - CD player: 8 buttons
 - Cassette deck: 8 buttons
 - Tuner: 2 buttons
 - VDP: 8 buttons
 - AVC-3030 fixed codes: 47 buttons
 - Learning buttons
 - System call buttons: 3 (maximum of 10 codes per button)
 - Program – AMP: 8 buttons
 - AV: 58 buttons
 - Maximum total: 35 codes
 - Batteries: R6P/AA Type (two batteries)
 - External dimensions: 70 (W) \times 215 (H) \times 18 (D) mm (2-3/4" \times 8-15/32" \times 45/64")
 - Weight: 170 g (Approx. 6 oz) (including batteries)

* For purposes of improvement, specifications and design are subject to change without notice.



CAUTION
RISK OF ELECTRIC SHOCK
DO NOT OPEN

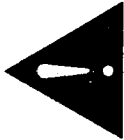

CAUTION: TO REDUCE THE RISK OF ELECTRIC SHOCK, DO NOT REMOVE COVER (OR BACK). NO USER SERVICE-ABLE PARTS INSIDE. REFER SERVICING TO QUALIFIED SERVICE PERSONNEL.

The lightning flash with arrowhead symbol, within an equilateral triangle, is intended to alert the user to the presence of uninsulated "dangerous voltage" within the product's enclosure that may be of sufficient magnitude to constitute a risk of electric shock to persons.

The exclamation point within an equilateral triangle is intended to alert the user to the presence of important operating and maintenance (servicing) instructions in the literature accompanying the appliance.

WARNING: TO REDUCE THE RISK OF FIRE OR ELECTRIC SHOCK, DO NOT EXPOSE THIS APPLIANCE TO RAIN OR MOISTURE.

CAUTION

TO PREVENT ELECTRIC SHOCK DO NOT USE THIS POLARIZED PLUG WITH AN EXTENSION CORD, RECEPTACLE OR POWER OUTLET UNLESS THE BLADES CAN BE FULLY INSERTED TO PREVENT BLADE EXPOSURE.

ATTENTION

POUR PREVENIR LES CHOCs ELECTRIQUES NE PAS UTILISER CETTE FICHE POLARISEE AVEC UN PROLONGATEUR UNE PRISE DE COURANT OU UNE AUTRE SORTIE DE COURANT, SAUF SI LES LAMES PEUVENT ETRE INSEREES A FOND SANS EN LAISSER AUCUNE PARTIE A DECOUVERT.

IMPORTANT SAFEGUARDS

1. Read Instructions - All the safety and operating instructions should be read before the appliance is operated.
2. Retain Instructions - The safety and operating instructions should be retained for future reference.
3. Head Warnings - All warnings on the appliance and in the operating instructions should be adhered to.
4. Follow Instructions - All operating and use instructions should be followed.
5. Cleaning - Unplug this video product from the wall outlet before cleaning. Do not use liquid cleaners or aerosol cleaners. Use a damp cloth for cleaning.
6. Attachments - Do not use attachments not recommended by the video product manufacturer as they may cause hazards.
7. Water and Moisture - Do not use this video product near water—for example, near a bath tub, wash bowl, kitchen sink, or laundry tub, in a wet basement, or near a swimming pool, and the like.
8. Accessories - Do not place this video product on an unstable cart, stand, tripod, bracket, or table. The video product may fall, causing serious injury to a child or adult, and serious damage to the appliance. Use only with a cart, stand, tripod, bracket, or table recommended by the manufacturer, or sold with the video product. Any modifications should follow the manufacturer's instructions, and should use a mounting assembly recommended by the manufacturer.
- 9A. An appliance and cart combination should be moved with care. Quick stops, excessive force, and uneven surfaces may cause the combination to overturn.
9. Ventilation - Slots and openings in the cabinet are provided for protection from overheating operation of the video product and should not be blocked or covered. The openings should never be blocked by placing the video product on a bed, sofa, rug or other similar surface. This video product should never be placed near or over a radiator or heat register. This video product should not be placed in a built-in installation. Proper ventilation is provided or the manufacturer's instructions have been adhere to.
10. Power Sources - This video product should be operated only from the type of power source indicated on the marking label. If you are not sure of the type of power supply to your home, consult your appliance dealer or local power company. For video products intended to operate from battery power, or other sources, refer to the operating instructions.
11. Grounding or Polarization - This video product is equipped with a polarized alternating-current line plug (a plug having one blade wider than the other). This plug will fit into the power outlet only one way. This is a safety feature. If you are having difficulty inserting the plug into the outlet, try reversing the plug. If the plug should still fail to fit, contact your electrician to replace your obsolete outlet. Do not defeat the safety purpose of the polarized plug.
12. Power-Cord Protection - Power-Supply cords should be routed so that they are not likely to be walked on or pinched by items placed upon or against them, paying particular attention to cords at plugs, convenience receptacles, and the point where they exit from the appliance.
13. Outdoor Antenna Grounding - If an outside antenna or cable system is connected to the video product, be sure the system is grounded so as to provide some protection against voltage surges and built-up static charges. Section 810 of the National Electrical Code, ANSI/NFPA No. 70-1984, provides information on proper grounding of the mast and supporting structure, grounding of the lead-in conductors, size of grounding conductors, location of antenna discharge unit, connection to grounding electrodes, and requirements for the grounding electrode. See Figure A.
14. Lightning - For added protection for this video product receiver during a lightning storm, or when it is left unattended and unused for long periods of time, unplug it from the wall outlet and disconnect the antenna or cable system. This will prevent damage to the video product due to lightning and power-line surges.
15. Power Lines - An outside antenna system should not be located in the vicinity of overhead power lines or other electric light or power lines. Also, avoid power lines or circuits. When installing an outside antenna system, extreme caution should be taken to keep from touching such power lines or circuits as contact with them might be fatal.
16. Overloading - Do not overload wall outlets and extension cords as this can result in a risk of fire or electric shock.
17. Object and Liquid Entry - Never push objects of any kind into this video product, or use liquid to clean the surface of this video product. Never spill liquid of any kind on the video product.
18. Servicing - Do not attempt to service this video product yourself as opening or removing covers may expose you to dangerous voltage points or short-circuit parts that could result in fire, electric shock. Never spill liquid of any kind on the video product.
19. Damage Requiring Service - Unplug this video product from the wall outlet and refer servicing to qualified service personnel under the following conditions:
 - a. When the power-supply cord or plug is damaged.
 - b. If liquid has been spilled, or objects have fallen into the video product.
 - c. If the video product has been exposed to rain or water.
 - d. If the video product does not operate normally by following the operating instructions. Adjustments or repairs are required, covered by the operating instructions as an improper adjustment of other controls may result in damage and will often require extensive work by a qualified technician to restore the video product to its normal operation.
 - e. If the video product has been dropped or the cabinet has been damaged.
 - f. When the video product exhibits a distinct change in performance - this indicates a need for service.
20. Replacement Parts - When replacement parts are required, be sure the service technician has used replacement parts specified by the manufacturer or have the same characteristics as the original part. Unauthorized substitutions may result in fire, electric shock or other hazards.
21. Safety Check - Upon completion of any service or repairs to this video product, ask the service technician to perform safety checks to determine that the video product is in proper operating condition.

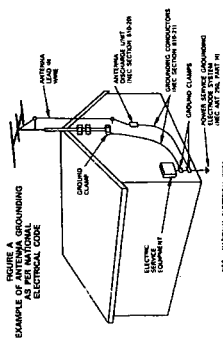

PART NAMES AND FUNCTIONS (Refer to pages 14 ~ 17)

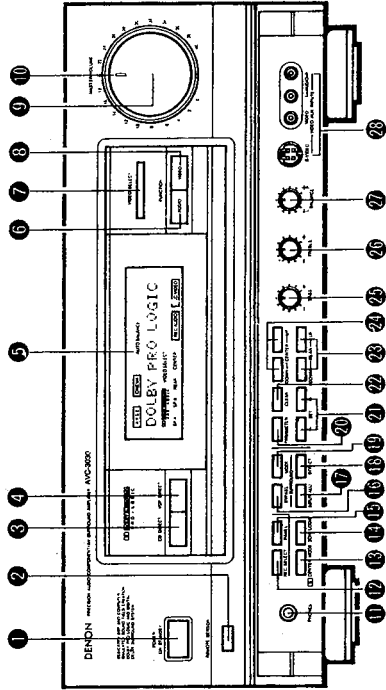

Front panel (10 ~ 20)

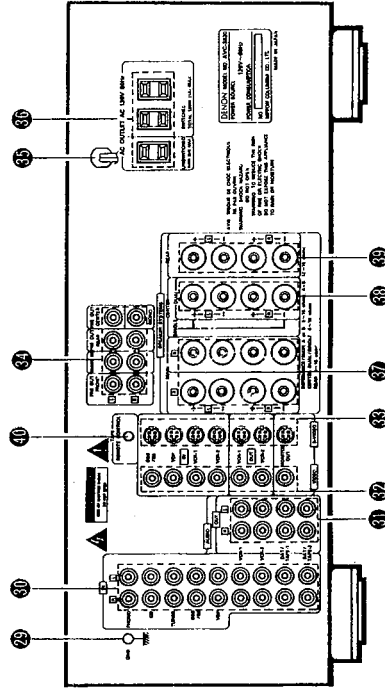

Rear panel (23 ~ 31)

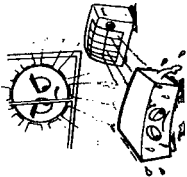

NOTE ON USE

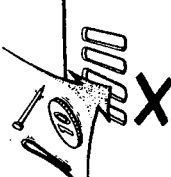
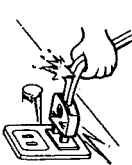
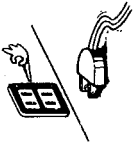
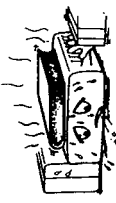
 <p>Be careful of high temperatures</p> <ul style="list-style-type: none"> Do not place the set in a location where it will be exposed to direct sunlight or near a heating appliance. <p>Caution on rack/cabinet installation</p> <ul style="list-style-type: none"> Avoid installing the set in a closed-type rack. When installing in a rack or cabinet, provide a sufficiently large ventilation opening to promote heat radiation. 	 <p>Caution on humidity, water, and dust</p> <ul style="list-style-type: none"> Do not place the set in a location where there is high humidity or a lot of dust. Flower vases or other items containing water should not be placed on top of the set. 	 <p>Do not open the case</p> <ul style="list-style-type: none"> Opening the top cover or the bottom plate of the case and inserting your hand is dangerous. Do not open the case. If some trouble arises with the performance of the set, remove the power plug soon and contact the store where the set was purchased or a nearby dealer. 	
 <p>Do not allow foreign matter into the equipment</p> <ul style="list-style-type: none"> Be especially careful of needles, hair pins, and coins getting into the set. 	 <p>Care with the power cord</p> <ul style="list-style-type: none"> When removing the plug from the receptacle, do not pull the power cord; be sure to hold the plug when removing it. 	 <p>During your absence</p> <ul style="list-style-type: none"> When not using the set for an extended period such as when taking a trip, be sure to disconnect the plug from the receptacle. 	
			 <p>For sets with ventilation holes</p> <p>Do not block the ventilation holes of the set</p> <ul style="list-style-type: none"> Blocking of the ventilation holes will lead to damage of the set. The ventilation holes are very important for heat radiation from within the set. Care must be taken since placing an object against the holes will result in an extreme rise of temperature within the set.

- We greatly appreciate your purchase.
- Read these operating instructions carefully to obtain the best performance and a long, trouble-free life from this amplifier. Be sure to keep these operating instructions for future reference.

— CONTENTS —

1	Before Using	6	9	DSP modes	34~47
2	Installation Precautions	7	10	Parameters	35~37
3	Handling Precautions	7	11	Dolby Pro Logic Surround	38, 39
4	Initialization of the Microprocessor	8	12	DSP operation	40~42
5	Connections	9~13	13	Technical advice	43~47
6	Part Names and Functions	14~21	14	On-screen Display	48, 49
7	Remote Control Unit	22~29	15	Last Function Memory	50
	• Part names and functions of the remote control unit	23~25	16	Troubleshooting	50, 51
	• AVC-3030 code buttons	26		Specifications	50, 51
	• System call buttons	27		DENON SERVICE NETWORK	52
	• Remote control unit learning function	28			53
	• Preset memory	29			
8	Operation	30~33			
	• Preparations for playback	30			

Check that the following items are included in the package in addition to the main unit:

- ① Operating instructions
- ② Remote control unit RC-162
- ③ R6P7AA batteries

1 BEFORE USING

Read the following cautions carefully before using the amplifier:

- Moving the set: correct and that there are no problems with the connection cords. Be sure to turn the power STANDBY before disconnecting or connecting cords.
- Be sure to unplug the power cord and disconnect other cords connecting the amplifier to other audio units before moving the amplifier to prevent damaging or short-circuiting the cords.
- Retain the operating instructions
- After reading this manual, store it in a safe place.
- The illustrations used in this manual may differ somewhat from the actual amplifier.

NOTICE

The DENON AVC-3030 is equipped with sophisticated heat detection circuitry to protect the unit from excessive heat. This protection circuit may be activated when the unit is operating at continuous high power conditions and/or inadequate ventilation.

When activated all signal outputs are muted and "PROTECTION!!" is indicated on the display. If protection is activated, switch off unit and allow unit to cool, this action will reset protection device. After cool down, turn on unit, it will operate normally.

Note: If unit does not receive adequate air circulation, move to location that will allow proper cooling.

2 INSTALLATION PRECAUTIONS

Using this amplifier or other electronic equipment containing microprocessors simultaneously with a tuner or TV may result in noise in the sound or picture. If this should happen, take the following steps:

- Install the amplifier as far as possible from the tuner or TV set.
- Keep the antenna lines of the tuner or TV as far as possible from the amplifier's power cord and connection cables.
- This problem is especially frequent when using indoor antennas or 300 ohm feeder lines. We recommend using outdoor antennas and 75 ohm coaxial cables.

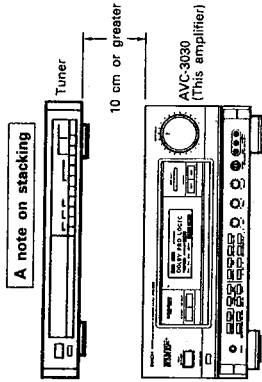

For cooling purposes, do not place another AV component directly on top of the amplifier. Be sure to leave a space of at least 10 cm.

3 HANDLING PRECAUTIONS

- Switching the input function when the input jacks are unconnected: Switching the input function when a component is not connected to the input jacks may result in the generation of click noise. If this should happen, turn down the MASTER VOLUME or connect a component to the input jacks.
- Playback with Dolby Pro Logic: The Dolby Pro Logic position provides optimum effectiveness for sources recorded with Dolby surround. A different surround mode should be selected when playing back sources other than this type. Note in particular that when playing back monaural recording sources, the bypass mode or the simulated mode should be used. Other modes will not provide a suitable effect.
- Muting of the PRE OUT jacks: An electronic muting circuit has been connected to the PRE OUT jacks. This circuit greatly attenuates the output signal for approximately 6 seconds after the power has been switched on. Raising the volume during this operation will result in an extremely large output once the muting has ended, so volume adjustments should be made only after the completion of muting.
- Rear output level while in the surround mode: The rear level will seem small for sources other than Dolby surround sources. The reason for this is that a rear playback signal is not contained in the software. When playing back such software with a surround mode, the mode should be set to something other than Dolby Pro Logic surround. The rear output level may seem small for software having a small rear signal, even Dolby surround sources.
- Opening and closing the door: This amplifier is equipped with a door on the front panel. Press the "PUSH OPEN" portion printed at the upper right edge of the door to release and open the door. Likewise, to close the door, press in the same manner until a click sound is heard.

NOTE:
The door will open naturally once it has been released, but it may stop before fully opening. This is not a fault; just lightly push the door open.

4 INITIALIZATION OF THE MICROPROCESSOR

When the indication of the MFD display is not normal or when the operation of the unit does not show the reasonable result, the initialization of the microprocessor is required by the following procedure.

- 1 Switch off the unit and remove the AC power cord from the wall outlet.
 - 2 Hold the following 3 buttons of the main unit at the same time (as illustrated in the diagram below. ① VIDEO SELECT button, ② AUDIO FUNCTION button, and ③ VIDEO FUNCTION button) plug the power cord into the outlet.
 - 3 Check that the entire MFD display is flashing with an interval of about 1 second, and release your fingers from the 3 buttons.
 - 4 Switch on the unit and the microprocessor will be initialized. The input function is set to tuner with the bypass mode automatically.
- NOTE:**
- When the unit does not show the result of above 3 and 4, repeat the procedure from 1 again.
 - When the microprocessor is initialized, all the previous setting of the unit is released and is set to the shipping condition from the manufacturer.

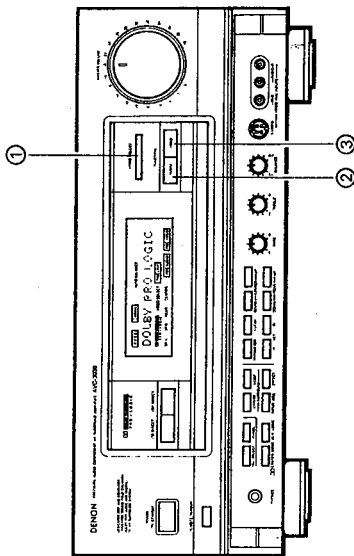

5 CONNECTIONS

Speaker System Connections

- This amplifier can accommodate connections of a total of eight speakers including two sets of (front) main amplifier speakers (A and B), one set of rear speakers, and one or two center speakers.
- Connect the speaker terminals with the speakers making sure that like polarities are matched (⊕ with ⊕, ⊖ with ⊖). Mismatching of polarities will result in weak central sound, unclear orientation of the various instruments, and the sense of direction of the stereo being impaired.
- When making connections, take care that none of the individual conductors of the speaker cord come in contact with adjacent terminals, with other speaker cord conductors, or with the rear panel.

- ① Peel off the insulation from the tip of the cord.
- ② Twist the conductors.
- ③ Turn the speaker terminal counterclockwise to loosen it.
- ④ Insert the exposed portion of wire completely and turn the terminal clockwise to tighten it.

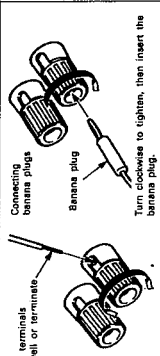

Speaker connections using the PRE OUT and MAIN IN jacks

These jacks are used when a separate pre-main (power) amplifier is used to amplify the front, rear, and center sounds. Using a second pre-main (power) amplifier [Use the included short pin, inserting it fully.

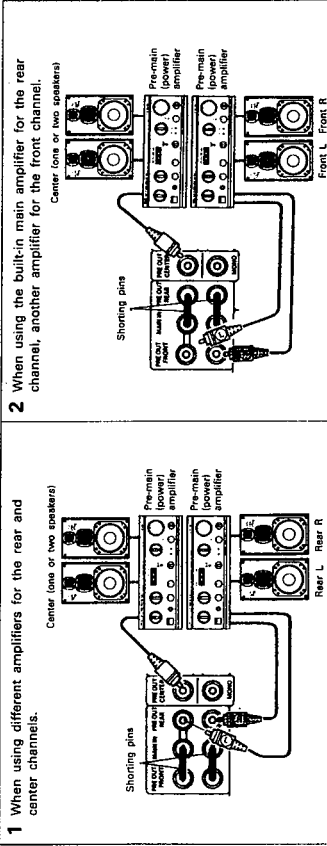

3 Using other equipment

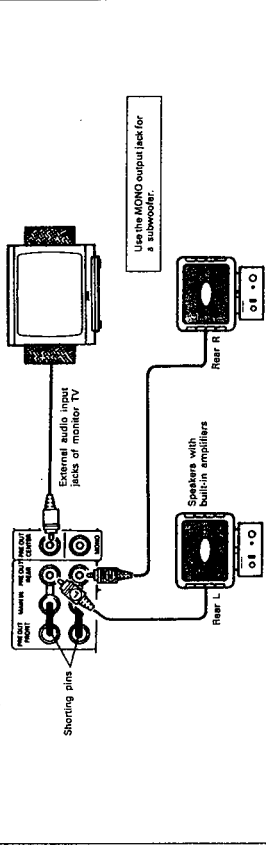

Continued

When two speakers are connected as dual center outputs a better effect will be obtained when speakers having uniform characteristics are used.

For a single center output (when only using one speaker for the center channel), connect the speaker to the (left) "+" terminal and the (right) "-" terminal.

Connection jacks for subwoofers with builtin amplifier (super woofers), etc.

PRE OUT and MAIN IN jacks
See page 9.

Audio Section

- Do not plug in the power cord until all connections have been completed.
- Be sure to connect the left and right channels properly (left with left, right with right).
- Insert the plugs securely. Incomplete connections will result in the generation of noise.

Connecting a turntable

Plug the output cable of the turntable into the PHONO jack of the amplifier, the L plug into the left (L) jack and the right plug into the right (R) jack.

If the turntable is equipped with a ground wire, connect it to the GND terminal.

If hum or other noise is produced when the ground wire is connected, disconnect it.

NOTE:
The amplifier cannot be used with MC cartridges directly. Use a separate head amplifier or step-up transformer.

Connecting a CD player

Use pin plug cords to connect the analog output jacks of the CD player to the CD jacks of the amplifier.

Connecting a tuner

Use pin plug cords to connect the output jacks of the tuner to the TUNER jacks of the amplifier.

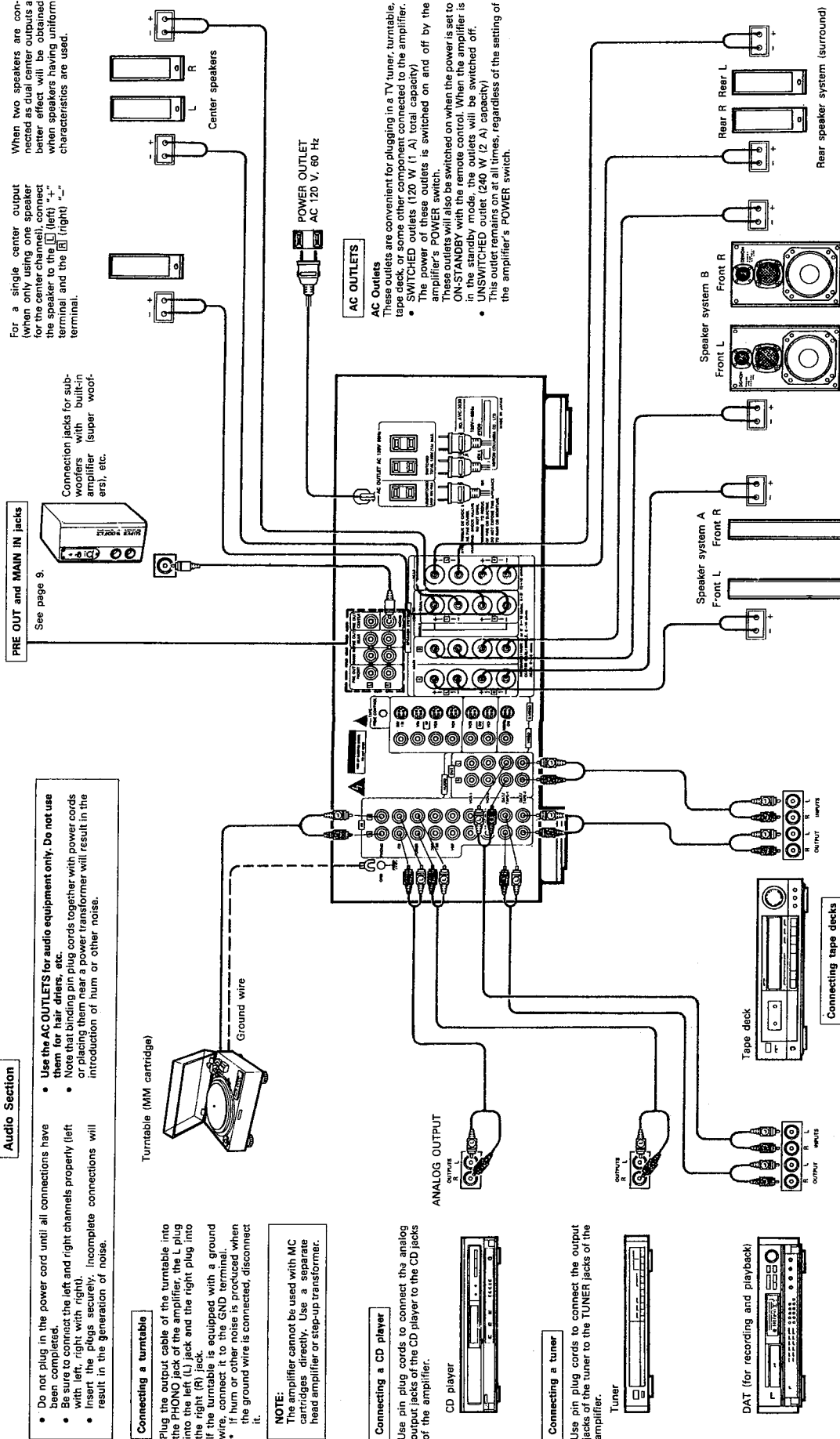

Precautions when connecting speakers

If a speaker is placed near a TV or video monitor, the colors on the screen may be disturbed by the speaker's magnetism. If this should happen, move the speaker away to a position where it does not have this effect.

Connecting speaker systems

Connect the speaker systems for the left channel (the left side as seen from the front) to the L terminals, and the speaker systems for the right channel to the R terminals.

Connecting tape decks

Connections for recording: Connect the tape deck's recording input jacks (LINE IN or REC) to the amplifier's tape recording (OUTPUT) jacks using pin plug cords.

Connections for playback: Connect the tape deck's playback output jacks (LINE OUT or PB) to the amplifier's tape playback (INPUT) jacks using pin plug cords.

Connecting a DAT (Digital Audio Tape Recorder)

Connections for recording: Connect the DAT's analog recording input jacks (LINE IN or REC) to the amplifier's tape recording (OUTPUT) jacks using pin plug cords.

Connections for playback: Connect the DAT's analog playback output jacks (LINE OUT or PB) to the amplifier's tape playback (INPUT) jacks using pin plug cords.

Video Section

Connecting a BS tuner

- Connect the BS tuner's S-output jack to the amplifier's [S-VIDEO] DBS/BS-IN jack using an S-jack connection cord.
- Connect the BS tuner's video output jack to the amplifier's [VIDEO] (yellow) DBS/BS-IN jack using a 75-ohm video coaxial cable pin plug cord.
- Connect the BS tuner's analog audio output jacks to the amplifier's [AUDIO] DBS/BS-IN jacks using pin plug cords.

BS tuner

S-output Video output
Audio output

Connecting a video disc player (VDP)

- (VDP, CDV, etc.)
- Connect the video disc player's S-output jack to the amplifier's [S-VIDEO] VDP IN jack using an S-jack connection cord.
 - Connect the video disc player's video output jacks to the amplifier's [VIDEO] VDP (yellow) jack using a 75-ohm video coaxial cable pin plug cord.
 - Connect the video disc player's analog audio output jacks to the amplifier's [AUDIO] VDP jacks using pin plug cords.

LD player, CDV player, etc.

S-output

Video output

Audio output

Connecting a video deck (VCR-1)

- There are two sets of VCR jacks allowing connection of two video decks for simultaneous recording and video copying.
- Connect the VCR S-output jack to the amplifier's [S-VIDEO] IN jack using a S-jack connection cord.
- Connect the VCR video output jack to the amplifier's [VIDEO] (yellow) VCR-1 IN jack and the VCR [VIDEO] (yellow) VCR-1 OUT jack using 75-ohm video coaxial cable pin plug cords.

Video deck 1 equipped with S-jacks

- Connecting the audio input and output jacks**
- Connect the video deck's audio output jacks to the amplifier's [AUDIO] VCR-1 IN jacks and the video deck's audio input jacks to the amplifier's [AUDIO] VCR-1 OUT jacks using pin plug cords.
 - A second video deck may be connected to the VCR-2 jacks in the same way.

A note on the S input jacks

- The input selector for the S inputs and that for the pin jack inputs work in conjunction with each other.

Precaution when using S-jacks

This amplifier's S-jacks (input and output) and video pin jacks (input and output) have independent circuit structures, so that video signals input from the S-jacks are only output from the pin jacks and video signals input from the pin jacks are only output from the pin jack outputs. When connecting to the amplifier with equipment that is equipped with S-jacks, keep the above point in mind and make connections according to the equipment instruction manuals.

The AVC-3030 is equipped with VIDEO AUX jacks on the front panel for playback of video equipment. This permits video cam-corders with playback functions as well as other equipment to be connected. The connection method is the same as that for the VDP.

Connecting cam corder (V-AUX)

- Connections for video input and output:**
- Connect the cam corder's video output jack to the amplifier's [VIDEO] (yellow) V-AUX IN jack and the cam corder's video input jack to the amplifier's [VIDEO] (yellow) V-AUX OUT jack using 75-ohm video coaxial cable pin plug cords.
- Connecting the audio input and output jacks**
- Connect the cam corder's audio output jacks to the amplifier's [AUDIO] V-AUX IN jacks and the cam corder's audio input jacks to the amplifier's [AUDIO] V-AUX OUT jacks using pin plug cords.

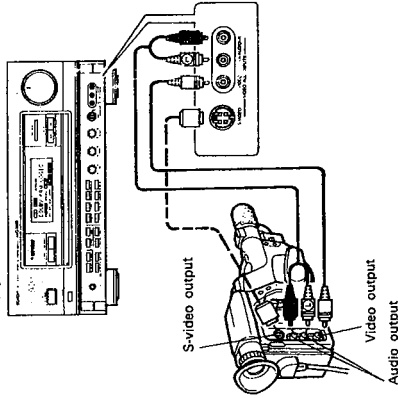

Connecting a monitor TV

- Connect the TV's S-video input jack to the amplifier's [S-VIDEO] MONITOR OUT jack using an S-jack connection cord.
- Connect the TV's video input jack to the amplifier's [VIDEO] MONITOR OUT jack using a 75-ohm video coaxial cable pin plug cord.

Monitor TV

- Connecting the S-jacks**
- Connect the video deck's S-output jack to the amplifier's [S-VIDEO] IN jack and the video deck's S-input jack to the amplifier's [S-VIDEO] OUT jack using S-jack connection cords.

6 PART NAMES AND FUNCTIONS

(Refer to the figures on page 5.)

1 POWER switch

- ON

When this switch is pressed once, the power turns on and the MASTER VOLUME LED (1) flashes. (The muting circuit is activated while "MUTING" is flashing to prevent noise when the POWER switch is operated.) After several seconds, the LED stops flashing, remaining lit and the muting circuit turns off. The set is now in the normal operating mode.

- STANDBY

When the POWER switch is pressed once again, the power turns off and the standby mode is set. The MASTER VOLUME LED (1) remains lit. In addition, when the power turns off, the power supply from the SWITCHED AC outlets on the rear panel also turns off.

2 REMOTE SENSOR

This is where the signals from the wireless remote control unit are received. Point the remote control unit (RC-162) at this sensor when operating it.

3 CD DIRECT button

This button is used to enjoy the audio signals input from the component connected to the CD jacks on the rear panel with higher sound quality. In the CD direct mode, the audio signals bypass such circuitry as the surround and tone control circuits, and are output directly to the front speakers for higher sound quality.

- ※ Cancelling the CD direct mode

When in the CD direct mode, either press the CD DIRECT button once again, or press the AUDIO FUNCTION selector button (6) or VIDEO FUNCTION selector button (7) or BYPASS button (8) or SURROUND MODE selector button (9) to cancel the CD direct mode.

4 VDP DIRECT button

This button is used to enjoy the audio signals input from the component connected to the VDP jacks on the rear panel with higher sound quality. In the VDP direct mode, the audio signals bypass such circuitry as the surround and tone control circuits, and are output directly to the front speakers for higher sound quality.

- ※ Cancelling the VDP direct mode

When in the VDP direct mode, either press the VDP DIRECT button once again, or press the VIDEO FUNCTION selector button (6) or AUDIO FUNCTION selector button (7) or SURROUND MODE selector button (8) or BYPASS button (9) to cancel the VDP direct mode.

NOTE:

When the CD or VDP DIRECT button (3) or (4) is selected, the output of signals to the audio and video output jacks is automatically prohibited, so the REC SELECT (independent audio/video recording) and VIDEO SELECT (independent video signal selector) buttons do not work. Also, if the REC SELECT button (7) is selected, the CD and VDP DIRECT buttons (3) and (4) will not function.

5 MFD (multi-function fluorescent display)

Information such as the surround mode and the input and output are displayed here when the power is turned on.

Normally the surround mode is displayed. If another button is pressed, a display pertaining to that button is shown for approximately 5 seconds (this time differs according to the display), after which the surround mode is once again displayed. Refer to pages 18 to 21 for details on the MFD displays.

6 AUDIO FUNCTION selector button

This button is used to switch the audio input. Press this button repeatedly or hold it in to change the input in the following order:

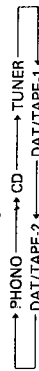

(All the video outputs are off unless a video function is selected with the VIDEO SELECT button or the REC SELECT button.)

7 VIDEO SELECT (independent video signal selector) button

This button is used to select the video signal independently of the audio signal. When pressed once, the video selector function turns on. When the button is held in, the video input signal changes in the order shown below. Release the button when the desired video input signal is displayed on the MFD or on the monitor screen. After this is done, the video signal will not change even if the AUDIO FUNCTION selector button (6) is pressed and the audio input is changed.

To cancel the independent video signal selection mode, either press the VIDEO SELECT button again, or press the VIDEO FUNCTION selector button (6).

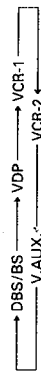

8 VIDEO FUNCTION selector button

This button is used to switch the video input. Press this button repeatedly or hold it in to change the input in the following order:

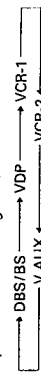

9 MASTER VOLUME control

Turn the control clockwise (↻) to increase the volume, counterclockwise (↺) to decrease it.

10 MASTER VOLUME LED

This LED remains lit when the set is in the normal operating mode or in the standby mode, and flashes when in the muting mode.

11 PHONES jack

This jack is for connecting headphones. To cut the sound from the speakers, either turn off the output (speakers) from the remote control unit or turn off the output of the component connected to the PRE OUT jacks.

→ Continued

12 REC SELECT (independent recording output selector) button

This button makes it possible to select the audio or video recording mode independently of the mode selected with the FUNCTION selector buttons. It selects the audio recording signals output to the DAT/TAPE-1, DAT/TAPE-2, VCR-1 and VCR-2 audio output jacks, and the video (and audio) recording signals output to the VCR-1 and VCR-2 output jacks. For the audio recording output, normally the signal input selected with the FUNCTION selector buttons is output to the recording output side, but when this button is used, signals from input jacks other than the ones selected with the FUNCTION selector buttons can be selected.

In addition, for the video (and audio) recording output, normally the video (and audio) signals selected with the VIDEO FUNCTION selector button (8) are output to the recording output side, but when this button is used, input signals other than the ones selected with the VIDEO FUNCTION selector button can be selected.

When this button is pressed once, the independent recording output selection function turns on. When the button is held in, the video and audio recording output changes in the order shown below. Release the button when the desired video and audio recording output is displayed on the MFD or on the monitor screen.

Press the REC SELECT button again to cancel the independent recording output selection mode.

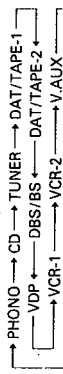

If the CD DIRECT or the VDP DIRECT button is selected, the audio and video recording output is automatically prohibited, so it is advisable to use the REC SELECT button (12) to prevent accidentally interrupting the recording.

13 CENTER MODE selector button

This button is used to select the center mode when in the Dolby Pro Logic, WIDE SCREEN or LIVE modes. Select the mode according to the speaker system you are using.

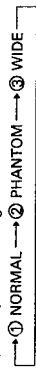

The mode switches as follows in the Dolby 3CH Logic mode:

- ① NORMAL ← ② WIDE

* In the WIDE SCREEN and LIVE modes, the center mode only changes when the adaptive matrix is on.

* If this button is pressed in a mode other than Dolby Pro Logic, live, wide screen or CD DIRECT, VDP DIRECT, the Dolby Pro Logic mode is set automatically.

For details, refer to pages 38 and 39.

14 SURROUND MODE selector button
Use this button to select the surround mode. Either press it repeatedly or hold it in to change the surround mode in the order shown at the top right of this page.
For details, refer to pages 33 to 34.

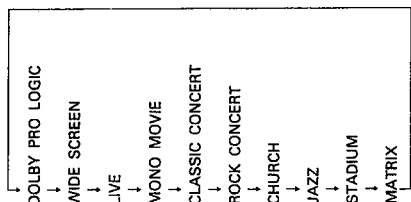

15 3CH. LOGIC (three-channel logic) button
This button only functions when in the Dolby Pro Logic mode. When pressed again, the three-channel logic mode turns off and the normal Pro Logic mode is set.
The 3CH. LOGIC key does not function when in the Dolby Pro Logic Phantom mode.
For details, refer to page 39.

16 PANEL button
Pressing this button provides a display of the current operating condition on the multifunction display. Pressing this button will switch the multifunction display.
For details, see Pages 18 to 21.

17 BYPASS (surround bypass) button
When this button is pressed, the surround mode is bypassed and the normal stereo sound is produced. No signals are output to the rear channel. If the SURROUND MODE button is pressed when in the bypass mode, the mode returns to the mode which was set before the bypass mode was turned on.
* In the initial setting the center output is turned off.

18 INPUT ADJ. (input level adjustment selector) button
This function makes it possible to increase the input level by +6dB, and is used when playing a source with a low input level, such as the tuner.
For details, refer to page 33.

19 EFFECT selector button
This button turns the effect of the DSP (digital signal processor) on and off. When turned off, only direct sounds are played on the front left and right speakers. This function can be used to check the effect of the sound processor.
* The effect turns back on if this button is pressed once again when the effect is off, or when a parameter is selected and data is changed with the "←" or "→" keys.
* If the power is turned off when the effect is off, that mode is stored in the memory, so only the direct sound is played when the power is turned back on.

24 CENTER (center speaker volume adjust) buttons
Use these buttons to adjust the volume of the center (surround) speaker.
Press the UP button to increase the volume, the DOWN button to decrease the volume.
The volume changes while the button is held in, and stops changing when the button is released. The volume change is indicated on the MFD or monitor screen. These buttons only function when in the bypass, Dolby Pro (3ch.) Logic normal or wide modes, and in the normal and wide modes with the adaptive matrix on when in the WIDE SCREEN and LIVE modes.

25 BASS control
Use this to adjust the bass sound of the front speaker output or PRE-OUT FRONT jacks. The bass sound is emphasized when turned clockwise (↻) from the center position, reduced when turned counterclockwise (↻) from the center position.

26 TREBLE control
Use this to adjust the treble sound of the front speaker output or PRE-OUT FRONT jacks. The treble sound is emphasized when turned clockwise (↻) from the center position, reduced when turned counterclockwise (↻) from the center position.

27 BALANCE control
Use this to adjust the left/right balance of the front speakers (PRE-OUT FRONT jacks).
* This control does not function in the CD direct and VDP direct modes.

28 VIDEO AUX INPUTS
These are auxiliary inputs for connecting video cameras or other AV equipment.
S-VIDEO: Connect the S-jack output of the other component here.
VIDEO: Connect the video output of the other component here. (Use a 75 ohm coaxial cable pin-plug cord.)
AUDIO L and R: Connect the audio output of the other component here.

29 GND (ground) terminal
Connect the ground wire of the record player here.

30 AUDIO IN (audio input) jacks

31 AUDIO OUT (audio output) jacks

32 VIDEO (video input/output) jacks

33 S-VIDEO (video input/output) jacks

34 PRE OUT (FRONT, CENTER, REAR and MONO) jacks
Refer to page 9.
Connect the monaural audio input jack of a separately sold subwoofer or TV here.

35 AC cord (power cord)

36 AC OUTLETS
Refer to page 11.

37 MAIN SPEAKER SYSTEMS terminals

38 CENTER SPEAKER SYSTEMS terminals

Note on the center speaker terminals:
The center channel output on the AVC-3030 is dual center compatible, so two center speakers can be used. The Pro Logic surround effect can be obtained with a single center channel speaker, but connecting two speakers with similar performance are connected to the L and R terminals creates a more effective dual center channel output.
For details, refer to pages 10 and 11.

39 REAR SPEAKER SYSTEMS terminals

40 TAPE/REMOTE CONTROL
This terminal is exclusively used for sending the remote control signals to the tape deck. Connect it with a 3.5mm mini-jack cord.

NOTE:
Do not hook up a headphones or microphone jack cord. Use this jack to connect a Denon cassette deck with a remote control jack (wired). If the cassette deck does not have this jack, wired remote control is not possible.

→ Continued

Multi-function fluorescent Display (MFD)

The multi-function fluorescent display indicates the status of the mode which has been operated by pressing the buttons on the front panel or on the remote control unit.

Display pattern examples

1. When the power is turned on

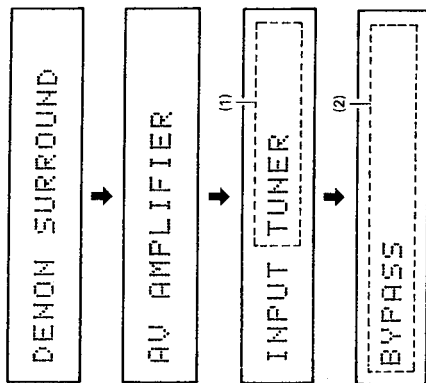

(1) The function name is displayed.

(2) The surround mode name is displayed.

Display

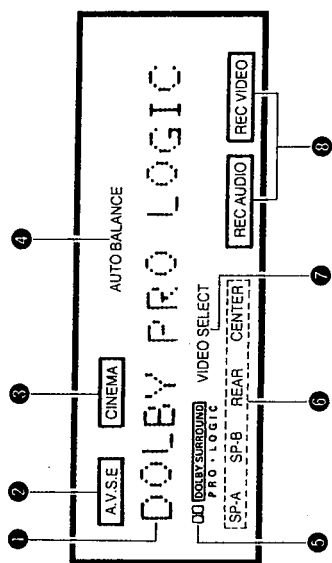

1 Multi-function fluorescent display

A maximum of 16 letters are displayed. The mode to which this display is set changes successively each time the PANEL button on the remote control unit is pressed. Normally, the display is set to the surround mode.

2 AV.S.E. indicator

This lights when the A.V.S.E button on the remote control unit is pressed. When pressed again, the indicator turns off.

3 CINEMA indicator

This lights when the CINEMA button on the remote control unit is pressed. When pressed again, the indicator turns off.

4 AUTO BALANCE indicator

This lights when the adaptive matrix is on when the Dolby Pro Logic, theater and live surround modes are set.

5 DOLBY SURROUND* indicator

This lights when the SURROUND MODE button is pressed and the Dolby Pro Logic mode is selected.

6 Output channel indicators

These indicate the speaker channel(s) to which signals are currently being output.
* None of these indicators lights when all the speakers are turned off.

7 VIDEO SELECT indicator

This indicates that video input signals have been selected independently of the audio input signals.

8 Recording select indicators

REC AUDIO lights when one of positions PHONO through DAT/TAPE-2 is selected with the REC SELECT button, and both REC AUDIO and REC VIDEO light when one of positions DBS/BS through VAUX is selected.

→ Continued

2. Surround mode display

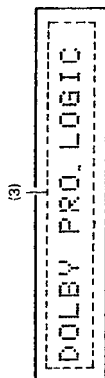

- (3) "DOLBY PRO LOGIC", "DOLBY 3CH-LOGIC", "WIDE SCREEN", "LIVE", "MONO MOVIE", "CLASSIC CONCERT", "ROCK CONCERT", "CHURCH", "JAZZ", "STADIUM" or "BYPASS" is displayed.



- (4) "NORMAL", "PHANTOM" or "WIDE" is displayed. * These are not displayed in modes not using the Dolby center modes or when the adaptive matrix is off in the WIDE SCREEN or LIVE modes.



- (5) The delay time is displayed. * The delay time is not displayed in the Dolby 3ch. Logic mode or any surround modes other than the ones shown above, the CD direct, the VDP direct.

3. Center level display



- (6) "MATRIX" is displayed. "DELAY" is displayed when the adaptive matrix is off in the WIDE SCREEN or LIVE modes.
- (7) "CENTER" is displayed when one of the CENTER buttons is pressed.
- (8) The level is displayed in steps of 2dB, from -48dB (minimum) to 0dB (maximum).

NOTE: This is not displayed in modes in which no signals are output to the center speaker(s).

4. Rear level and balance display

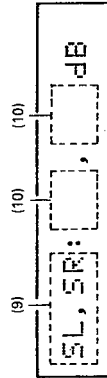

- (9) This is displayed when one of the REAR buttons is pressed.
- (10) The level is displayed in steps of 2dB, from -48dB (minimum) to 0dB (maximum).

NOTE: This is not displayed in modes in which no signals are output to the rear speakers.

5. Input display

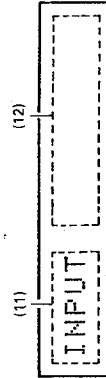

- (11) "INPUT" is displayed when one of the FUNCTION buttons (AUDIO or VIDEO) is pressed, and the name of the function is displayed in section (12). If the video signal has already been selected with the VIDEO SELECT button, the audio input and video input are displayed for 3 seconds when the AUDIO FUNCTION button is pressed.

6. Recording output display



- (13) "REC" is displayed when the REC SELECT button is pressed.
- (14) The name of the function ("PHONO", "CD", "TUNER", "DAT/TAPE-1", "DAT/TAPE-2", "DBS/BS", "VDP", "VCR-1", "VCR-2", or "V-AUX") is displayed. Normally the source is displayed. When the recording output selection function is off and the video selection function is on, the source is displayed for the audio output and the selected signal ("DBS/BS", "VDP", "VCR-1", "VCR-2", or "V-AUX") is displayed for the video output.

7. Test tone display

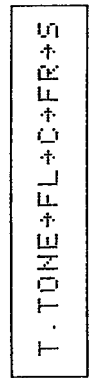

This is displayed when the T.TONE button on the remote control unit is pressed. The arrow moves as the output changes. This message is displayed until the test tone function is turned off.

8. DSP parameter display

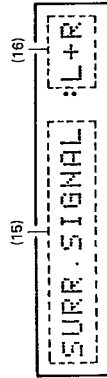

- (15) The following are displayed in modes for which the PARAMETER key is effective:

"SURR.SIGNAL"
"ADAPT.MATRIX"
"7kHz L.P.F."
"SOUND SIM."
"INIT.DELAY"
"ROOM SIZE"
"EFFECT LEVEL"
"EFFECT"

- (16) The parameter settings are displayed here.

9. Clear display

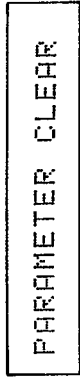

- This is displayed when the CLEAR button is pressed.
- * This is not displayed in the CD direct, VDP direct modes.

10. Input level adjustment display

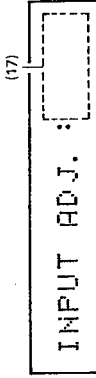

- This is displayed when the INPUT ADJ. button is pressed, and the level (0dB or +6dB) is displayed at section (17).
- * This is not displayed in the CD direct, VDP direct modes.

11. Muting display



- This is displayed when the MUTING button on the included remote control unit is pressed, and remains displayed until the muting function turns off.

12. Protection display

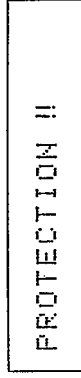

- This is displayed when the protection circuit is on. For details, refer to page 30.

13. No display (MFD off)



- Use this when you do not need or do not want to use the MFD.
- When the PANEL key on the remote control unit is pressed and held in, the display on the MFD changes continuously and finally turns off. After this is done, when a button is pressed, the corresponding display appears for several seconds, but the MFD then automatically turns back off. To turn the MFD back to the normal display mode, press the PANEL button on the remote control unit once again.

7 REMOTE CONTROL UNIT

Following the procedure outlined below, insert the batteries before using the remote control unit.

■ Cautions for batteries

- Use R6P/AA batteries in the remote control unit.
- Replace the batteries with new ones approximately once each year, though this depends on the frequency with which the remote control unit is operated.
- If the remote control unit does not operate from close to the main unit, replace the batteries with new ones even if less than one year has passed since the new batteries were inserted.
- Be sure that the ⊕ and ⊖ ends of the batteries match the marks on the battery case of the remote control unit.
- Replace weak batteries as soon as possible.
- Do not mix new batteries with used ones.
- Do not use batteries of different types together. Note that some batteries of the same shape and size may provide different performance.
- Some batteries are rechargeable, others are not. Read the battery instructions carefully.
- Do not connect the ⊕ and ⊖ ends of the batteries directly with metal objects. (Do not short-circuit the batteries.)
- Do not disassemble, heat, or dispose of batteries in a fire. If the batteries should leak, carefully wipe off any fluid from the battery case, then insert new batteries.

■ Using the remote control unit

The remote control unit uses highly linear infrared rays. Point it at the amplifier's remote sensor when operating it. The amplifier will not operate if the remote sensor is covered or if there is an obstacle between the remote control unit and the sensor.

Also note that strong light shining on the remote sensor may result in mistaken operations. In addition, using the amplifier near neon signs which generate pulse type noise may result in mistaken operations, so keep the amplifier as far as possible from such neon signs.

■ Range of operation of the remote control unit

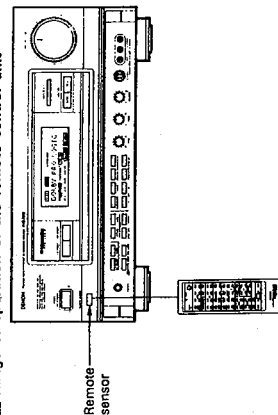

Point the remote control unit at the remote sensor when operating it, as shown on the diagram. The remote control unit can be used at a direct distance of approximately 7 meters from the main unit, though this distance will be shorter if there is an obstacle between the remote control unit and main unit or if the remote control unit is operated from an angle.

→ Continued

Part names and functions of the remote control unit

AVC-3030 codes

System codes

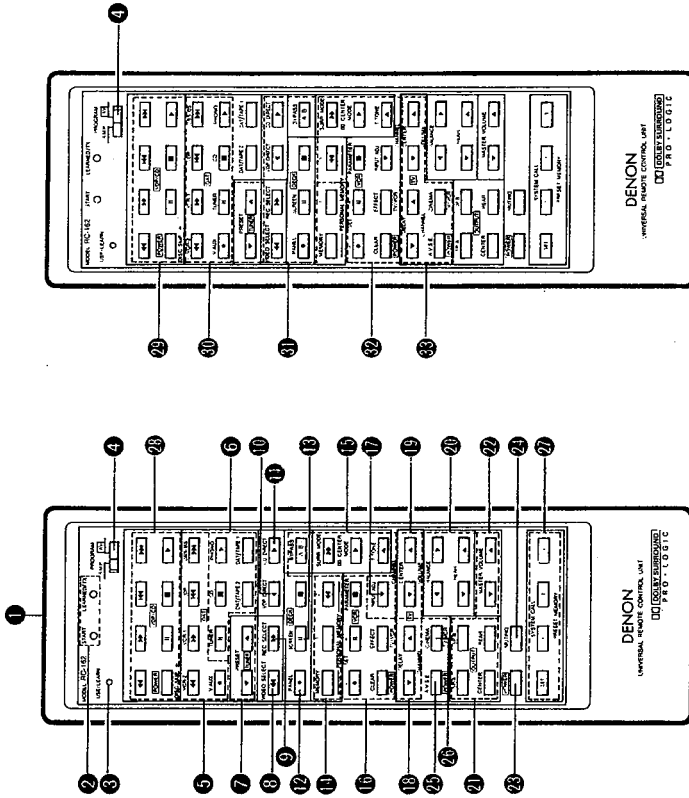

■ A note on battery replacement

Have replacement batteries on hand so that the old batteries can be replaced as quickly as possible when the time comes. The codes that have been learned may be lost if removed batteries are not replaced within about 5 minutes.

1. Open the bottom cover of the remote control unit and remove the battery cover.

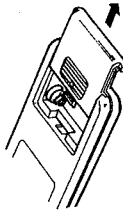

2. Insert the two R6P/AA batteries, matching the ⊕ and ⊖ marks on the batteries with those in the case.

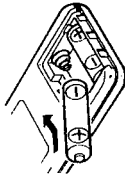

3. Close the bottom cover until it clicks shut.

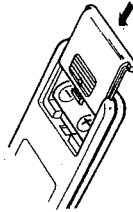

AVC-3030 Codes

Use with the PROGRAM switch ④ set to the AMP side.

- ① **Transmitting window**
The remote control signals (infrared rays) are sent from this window.
- ② **Indicator section (START, LEARNED/TX)**
- ③ **USE/LEARN (normal use/learn mode) selector button**
Press this button with the tip of a pen, etc., to set the learn mode. Both the START and LEARNED/TX indicators in the indicator section ② flash and codes can be learned.

- ④ **PROGRAM switch**
- ⑤ **Video input selector buttons**
These buttons are used to select the video input signals directly. They select the input signals and switch the video signals.
DBS/BS: Use this to play the BS tuner connected to the DBS/BS jacks.
VDP: Use this to play the VDP connected to the VDP jacks.
VCR-1: Use this to play the video deck connected to the VCR-1 jacks.
VCR-2: Use this to play the video deck connected to the VCR-2 jacks.
V. AUX: Use this to play the cam. corder with playback function, etc., connected to the V-AUX jacks on the front panel.

- ⑥ **Audio input selector buttons**
This can only be set from the remote control unit. These buttons select the audio input signal directly.
PHONO: Use this to play the record player connected to the PHONO jacks.
CD: Use this to play the CD player connected to the CD jacks.
TUNER: Use this to play the tuner.
DAT/TAPE-1: Use this to play the DAT or tape deck connected to the DAT/TAPE-1 jacks.
DAT/TAPE-2: Use this to play the DAT or tape deck connected to the DAT/TAPE-2 jacks.

- ⑦ **TUNER | PRESET ▼ and ▲ buttons**
With these buttons, a Denon remote controllable tuner can be controlled directly.
For details, refer to the tuner's operating instructions. Note that operation may not be possible for some models.
▲ : Preset (preset channel up).
▼ : Preset (preset channel down)

⑩

- SURROUND MODE button**
- **BYPASS (Surround bypass) button**
- **SURR. MODE (Surround mode) button**
- **□ CENTER MODE Selector button**
(Same function as on amplifier.)
- **T.TONE (test tone) button**
This can only be set from the remote control unit. To obtain the maximum Dolby Pro Logic surround effect, the volume of all the speakers must be adjusted to the same level. When this button is pressed, test tones are produced from each of the speakers in the following order:
→ Front left → Center → Front right → Rear

In addition, there are two modes, auto and manual. The speaker volume balance can be adjusted in either of these modes.
For details, refer to page 39.

⑪

- DSP parameter adjustment buttons**
(Same functions as on amplifier.)
- **EFFECT selector button**
- **PARAMETER (DSP parameter selector) button**
- **CLEAR (User preset clear) button**
- **“-” and “+” SET button**

⑫

- INPUT ADJ. button**
(input level adjustment selector) button
(Same function as on amplifier.)

⑬

- DELAY time buttons**
This can only be set from the remote control unit. When these buttons are pressed, the delay time changes in steps of 1.5ms from 6ms to 60ms, 10.0ms from 60ms to 370ms.
The delay time increases when the ▲ button is pressed.
The delay time decreases when the ▼ button is pressed.

⑭

- Center level adjustment buttons**
(setting range → 15.0ms to 30.0ms)

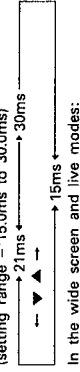

⑮

- REAR Speaker adjustment buttons**
(Same function as on amplifier.)
- **BALANCE adjustment buttons**
This can only be set from the remote control unit. Use these to adjust the output balance of the rear speakers.
When the ◀ button (left) is pressed, the volume of the right rear speaker decreases.
When the ▶ button (right) is pressed, the volume of the left rear speaker decreases.

⑰

- OUTPUT (speaker output selector) buttons**
This can only be set from the remote control unit. Use these buttons to turn the speaker outputs on and off.
The settings are displayed on the MFD and on-screen display.

SP-A: The speaker systems connected to the FRONT MAIN "A" speaker output terminals operate.

SP-B: The speaker systems connected to the FRONT MAIN "B" speaker output terminals operate.

CENTER: The speaker system(s) connected to the CENTER speaker output terminals and the PRE OUT CENTER terminal operate(s).

REAR: The speaker systems connected to the REAR speaker output terminals and the PRE OUT REAR terminal operate.

MASTER VOLUME buttons
These button functions in the same way as the MASTER VOLUME control on the main unit.

MUTING button
When this button is pressed, the output from the PRE OUT jacks and SYSTEM SPEAKERS terminals is cut. The MASTER VOLUME LED flashes when the muting mode is set. Press this button again to cancel the muting mode.

AV.S.E (Bass correction button)
This button is used to emphasize the bass range of the front speakers.
Setting this switch to ON when using movie video software provides even greater impressiveness. Use this function as desired.

CINEMA (Treble correction button)
This button is used when playing back movie video software and the speech portion is felt to be harsh upon the ears.
This function attenuates the treble range of the center speaker.

SYSTEM CALL buttons
This button cannot be used in the CD direct mode and the VDP direct mode.

For details, refer to page 27.

→ Continued

AVC-3030 Code Buttons

26

When the PROGRAM switch ④ is set to the AMP side:

VDP system buttons

With these buttons, a Denon remote controllable LD player can be controlled directly. For details, refer to the LD player's operating instructions. Note that operation may not be possible for some models.

- : Power on/off
- : Play
- : Pause
- : Stop
- : Manual search (reverse and forward)
- : Auto search (reverse and forward)

27

When the PROGRAM switch ④ is set to the AV side:

CD system buttons

With these buttons, a Denon remote controllable CD player can be controlled directly. For details, refer to the CD player's operating instructions. Note that operation may not be possible for some models.

- : Play
- : Pause
- : Stop
- : Manual search (reverse and forward)
- : Auto search (reverse and forward)
- : CD changer, disc skip

30

DAT system buttons

With these buttons, a Denon remote controllable DAT can be controlled directly. For details, refer to the DAT's operating instructions. Note that operation may not be possible for some models.

- : Play
- : Pause
- : Stop
- : Record
- : Manual search (reverse and forward)
- : Auto search (reverse and forward)

31

Tape deck system buttons

With these buttons, a Denon remote controllable tape deck can be controlled directly. For details, refer to the tape deck's operating instructions. Note that operation may not be possible for some models.

- : Forward play
- : Reverse play
- : Pause
- : Stop
- : Record
- : Rewind
- : Fast-forward
- : Switching between decks A and B for double decks

32

VCR system buttons

No system codes are stored here.

33

TV system buttons

No system codes are stored here.

System Call Buttons

The system call function is a function which allows you to store a series of remote control operations consisting of the operations of up to a maximum of ten buttons, then perform this series of operations by pressing a single button.

Storing the System Call Operations

1. Press the **SET** button.
2. The START LED in the indicator section flashes.
3. Set the PROGRAM switch ④ to the desired side, then press the buttons for the system call operations in the order you want to send the signals (up to a maximum of ten buttons). The LEARNED/TX LED lights each time a button is pressed.
4. It is not possible to store the codes of more than ten buttons. If the button which has been pressed is a non-storable button or if an 11th button is pressed, the START LED will turn off while that button is pressed.
5. Press one of buttons ① to ③ at which you want to store the system call series.
6. The START LED turns off. The system call series has now been stored.
7. Three system call series can be stored, one each at buttons ① to ③.

To continue storing another series, repeat steps 1 to 4.

NOTE:

Signals are sent from the remote control unit when buttons are pressed while storing the system call series, so prevent the components from operating by covering the transmitting window, etc.

Clearing the System Call Series

1. Press the **SET** button. The START LED starts flashing.
2. Press the button, ① to ③, which you want to clear.
3. The START LED turns off and the system call series is cleared.
4. To clear another button, repeat steps 1 to 3.

Using the System Call Buttons

1. Press the desired button, ① to ③, once.
2. The LEARNED/TX LED lights, and the remote control codes are sent in the order in which they were stored at a speed of approximately one second per code.
3. The LEARNED/TX LED turns off once all the codes have been sent.

28

AVC-3030 Code Buttons

29

When the PROGRAM switch ④ is set to the AMP side:

VDP system buttons

With these buttons, a Denon remote controllable LD player can be controlled directly. For details, refer to the LD player's operating instructions. Note that operation may not be possible for some models.

- : Power on/off
- : Play
- : Pause
- : Stop
- : Manual search (reverse and forward)
- : Auto search (reverse and forward)

30

When the PROGRAM switch ④ is set to the AV side:

CD system buttons

With these buttons, a Denon remote controllable CD player can be controlled directly. For details, refer to the CD player's operating instructions. Note that operation may not be possible for some models.

- : Play
- : Pause
- : Stop
- : Manual search (reverse and forward)
- : Auto search (reverse and forward)
- : CD changer, disc skip

Remote Control Unit Learning Function

Follow the procedures explained below to use the remote control unit's learning function.

Operation

1. Press the USE/LEARN (normal use/learn mode) selector button ④ with the tip of a pen, etc., to set the learn mode. Both the START and LEARNED/TX indicators in the indicator section ② flash, indicating that codes can be "learned".
2. Set the PROGRAM switch ① to the desired side, AMP or AV.
3. Point the heads (transmitting window) of the RC-162 and the other remote control unit at each other at a distance of approximately 5cm.
4. Press the button on the RC-162 at which you want to store the code for one or two seconds, then release it. The LEDs stop flashing, and only the START LED remains lit.
5. If a non-learnable button is pressed or if two or more buttons are pressed, both the LEDs will stop flashing, remaining lit, when the button(s) is (are) released.)
6. Check that the START LED ② is lit, then press in the button on the other remote control unit whose code you want to store in the RC-162.
7. When the START LED ② turns off and the LEARNED LED lights, release the button. That code is now stored. Both LEDs once again start flashing. This operation can now be repeated to store other codes in the RC-162.

NOTE:

- If the code was not stored in the RC-162, the LEARNED LED will light after the START LED turns off. For a very limited number of models, codes cannot be stored in the RC-162.
- If after the START LED lights both LEDs start flashing rapidly, this means that the memory is full. The code you just tried to store in the RC-162 was not registered. To store a different code at a certain button, first use the "Resetting Procedure".

7. To store codes at other buttons, repeat steps 4 to 6.
8. After you finish storing all the codes you want, press the USE/LEARN (normal use/learn mode) selector button ④ again. Both LEDs stop flashing and the sending (use) mode is set. Check that the stored codes work properly.

Learnable buttons:

When the PROGRAM switch is at the AMP side 8 buttons
 When the PROGRAM switch is at the AV side 58 buttons
 Maximum of 35 codes in 66 buttons

NOTE:

Depending on the types of codes stored, it may not be possible to store 35 codes.

Resetting (Clearing) Procedure

1. Press the USE/LEARN (normal use/learn mode) selector button ④ with the tip of a pen, etc., to set the learn mode.
2. Set the PROGRAM switch ① to the side whose codes you want to clear, AMP or AV.
3. Press the POWER button ⑤ and REAR ▼ button ④ simultaneously, and hold them in for at least four seconds.
4. When both the START and LEARNED LEDs ② light simultaneously, all the learned codes for the selected source are cleared.

Remote Control Operation

1. Check that both the LEDs are off. If they are flashing or lit, press the USE/LEARN (normal use/learn mode) selector button ④ so that the LEDs turn off.
2. When a button at which a code was "learned" is pressed, the LEARNED/TX LED lights and the remote control code is sent.

Preset Memory

The VDP ④, VCR ⑤ and TV ⑥ system buttons can be preset to system codes of other manufacturers instead of to the Denon component system codes. For some components, operation is possible simply by registering the manufacturer, without using the learning function.

Registering the Preset System Codes

1. Set the PROGRAM switch to the side to be preset.
 AMP VDP ④
 AV VCR ⑤ or TV ⑥
 be preset.
2. Press and hold in the POWER button for the source to be preset.
3. While pressing the POWER button, first press the SYSTEM CALL button, [1], [2] or [3], for the A block. (Select the proper SYSTEM CALL button from Table 1.) The LEARNED/TX LED ② now flashes.
4. Now press and hold in the POWER button and press the button for the B block, as shown on Table 1.
5. The LEARNED/TX LED turns off and the preset system codes have been registered.

NOTE:
 Signals are sent from the remote control unit when buttons are pressed while registering the preset system codes, so prevent the components from operating by covering the transmitting window, etc. In addition, the learning function has priority over the preset memory. If codes have been stored with the learning function at any one of the VDP ④, VCR ⑤ or TV ⑥ keys, they will remain stored even if the preset memory codes are registered.

Some models even of applicable manufacturers use different formats, in which case operation is not possible. In such cases, using the learning function.

Table 1 Combinations of Preset System Codes for Different Manufacturers

"VCR"		[1] button		[2] button		[3] button	
B block	A block						
CENTER VOL. ▼	▶	SONY	A	MITSUBISHI	A	TOSHIBA	
CENTER VOL. ▲	▶	SONY	B	MITSUBISHI	B		
REAR BAL. ◀	▶	SONY	C	MITSUBISHI	C	VICTOR	
REAR BAL. ▶	▶						
REAR VOL. ▼	▶	PANASONIC	A			HITACHI	
REAR VOL. ▲	▶	PANASONIC	B				
MASTER VOL. ▼	▶	SHARP		SANYO		RCA	
MASTER VOL. ▲	▶						
"TV"		[1] button		[2] button		[3] button	
B block	A block						
CENTER VOL. ▼	▶	SONY		MITSUBISHI		TOSHIBA	
CENTER VOL. ▲	▶						
REAR BAL. ◀	▶					VICTOR	
REAR BAL. ▶	▶						
REAR VOL. ▼	▶	PANASONIC	A			HITACHI	
REAR VOL. ▲	▶	PANASONIC	B				
MASTER VOL. ▼	▶	SHARP		SANYO			
MASTER VOL. ▲	▶						
"VDP"		[1] button		[2] button		[3] button	
B block	A block						
CENTER VOL. ▼	▶	SONY	A	DENON	A		
CENTER VOL. ▲	▶	SONY	B	DENON	B		
REAR BAL. ◀	▶	SONY	C	DENON	C		
REAR BAL. ▶	▶						
REAR VOL. ▼	▶	PANASONIC					
REAR VOL. ▲	▶						
MASTER VOL. ▼	▶	PIONEER		SANYO		PHILIPS	
MASTER VOL. ▲	▶					MAGNAVOX	

Continued

8 OPERATION

Preparations for playback

1. **Checking connections**
 - Referring to the connection diagrams (Pages 9 to 13) check to make sure that the connections are made properly.
 - Check that the left and right speakers are connected properly and also that the polarity (+, -) is correct.
 - Check that the left and right sides of the pin plug cords are connected properly.
 - Check that each cord is securely connected
 - Check that each cord is of the proper type.
2. **Checking the positions of the controls**

(See Pages 14 to 17 for a reference to the circled numbers.)

 - Turn the **MASTER VOLUME** control fully counterclockwise to the "0" position.
 - Set the **BALANCE**, **BASS**, and **TREBLE** controls to their center positions.

After making the above checks, press **POWER switch** to switch on the power.
The amplifier will be operable when the **LED of the MASTER VOLUME control stops flashing after several seconds of muting.**

Note on playback

The sound will be interrupted if one of the **FUNCTION selector buttons** is pressed during playback. This is due to the operation of the muting circuit which prevents noise from being amplified at the time of switching, and is not a malfunction.

- When using the accompanying remote control unit, press the corresponding button. For details, see Page 22 of Section 7 **REMOTE CONTROL UNIT**.

Protection Circuit

This amplifier is provided with a high-speed protection circuit. This circuit protects the internal circuitry from large currents which may be created by the output signals when the speaker terminals are not completely connected or are short-circuited. The operation of this protection circuit automatically cuts off the output to the speakers and displays "PROTECTION!" on the multi-function display. If this should happen be sure to unplug the power cord, check the speaker connections, then plug in the power cord and switch on the power again. If, after another check, the "PROTECTION!" display comes on again, contact your store of purchase.

Playback

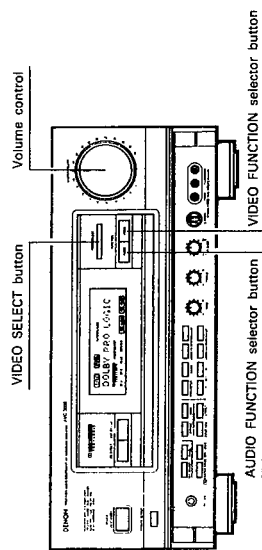

1. Playing a program source (Normal playback)

- 1 Select the desired program source by pressing the **AUDIO FUNCTION selector button** or the **VIDEO FUNCTION selector button**.

• **AUDIO FUNCTION SELECTOR**
(Setting the program source)

Program source	AUDIO FUNCTION SELECTOR
To listen to a record	PHONO
To listen to a CD	CD
To listen to FM or AM broadcasts	TUNER
To listen to the DAT or tape deck connected to the DAT/TAPE-1 jacks	DAT/TAPE-1
To listen to the DAT or tape deck connected to the DAT/TAPE-2 jacks	DAT/TAPE-2

• **VIDEO FUNCTION SELECTOR**
(Setting the video program source)

Video program source	VIDEO FUNCTION SELECTOR
To watch a satellite broadcast	DBS/BS
To watch the video disc player connected to the VDP jacks	VDP
To watch the video deck connected to the VCR-1 jacks	VCR-1
To watch the video deck connected to the VCR-2 jacks	VCR-2
To watch the video camcorder equipped with playback function or another component connected to the (front panel) VIDEO-AUX jacks	V-AUX

MFD display



2. Simulcast playback (Playing video and audio sources)

- 1 Select the program source you wish to listen to with the **AUDIO FUNCTION selector** or the **VIDEO FUNCTION selector**.

MFD display



- 2 Hold down the **VIDEO SELECT** button for the video program source you wish to watch.

MFD display

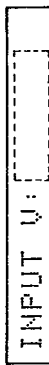

- 3 Begin playback of the program source. For operating details, see the manual of the respective component.

- 4 Adjust the volume and tone.

Note that when the **VIDEO FUNCTION** button is again used to select the video program source during Simulcast playback, the Simulcast playback will be cancelled automatically.

- 2 Begin playback of the program source. For operating details, see the manual of the respective component.

- 3 Adjust the volume and tone.

Operations in the Different Modes

Mode	SP-A	SP-B	CENTER SPIFFE ¹⁾	REAR SPIFFE ¹⁾	CENTER LEVEL	REAR LEVEL	REAR BAL	CONVER MODE	TEST TONE	RECALL TIME	SNR SIGNAL	A. MATRIX
CD DIRECT, VDP DIRECT	O	O	X	X	X	X	X	X	X	X	X	X
BYPASS	O	O	O	O	C	C	X	Δ ²⁾	O	O	X	X
DOLBY PRO LOGIC	O	O	O	O	O	O	O	O	O	O	X	X
DOLBY 3CH LOGIC	O	O	O	O	O	O	O	O	O	O	X	X
WIDE	O	O	O	O	O	O	O	O	O	O	X	X
SCREEN & A. MATRIX ON	O	O	O	O	J	J	O	O	X	O	O	O
LIVE	O	O	O	O	O	O	O	O	O	O	O	O
A. MATRIX OFF (S, SIG, L+R, L/R)	O	O	O	O	O	O	O	O	O	O	O	O
MONO MOVIE	O	O	O	O	O	O	O	Δ ²⁾	X	O	X	X
CLASSIC CONCERT	O	O	O	O	O	O	O	Δ ²⁾	X	X	X	X
ROCK CONCERT	O	O	O	O	O	O	O	Δ ²⁾	X	X	X	X
CHURCH	O	O	O	O	O	O	O	Δ ²⁾	X	X	X	X
JAZZ	O	O	O	O	O	O	O	Δ ²⁾	X	X	X	X
STADIUM	O	O	O	O	O	O	O	Δ ²⁾	X	X	X	X
MATRIX	O	O	O	O	O	O	O	Δ ²⁾	X	O	X	X

Mode	7MHz L.P.F.	SOUND SIM.	INIT DELAY	ROOM SIZE	EFFECT LEVEL	EFFECT ON/OFF	AV, SE.	CINEMA	INPUT ADJ.	CLR
CD DIRECT, VDP DIRECT	X	X	X	X	X	X	X	X	X	X
BYPASS	X	X	X	X	X	X	X	O	O	O
DOLBY PRO LOGIC	X	X	X	X	X	X	X	O	O	O
DOLBY 3CH LOGIC	X	X	X	X	X	X	X	O	O	O
WIDE	X	X	X	X	X	X	X	O	O	O
SCREEN & A. MATRIX ON	O	O	X	Δ ⁴⁾	Δ ⁴⁾	Δ ⁴⁾	X	O	O	O
LIVE	O	O	X	Δ ⁴⁾	Δ ⁴⁾	Δ ⁴⁾	X	O	O	O
MONO MOVIE	X	X	O	Δ ⁴⁾	Δ ⁴⁾	Δ ⁴⁾	X	O	O	O
CLASSIC CONCERT	X	X	O	O	O	O	O	O	O	O
ROCK CONCERT	X	X	O	O	O	O	O	O	O	O
CHURCH	X	X	O	O	O	O	O	O	O	O
JAZZ	X	X	O	O	O	O	O	O	O	O
STADIUM	X	X	O	O	O	O	O	O	O	O
MATRIX	X	X	X	X	X	X	X	O	O	O

O: Operation possible
X: Operation not possible

- When the power is turned on and when switching from other modes, the center and rear speaker pre-outputs are automatically turned on, even if they were off. In the bypass mode, however, the center speaker pre-outputs do not change.
 - Switches to the Dolby Pro (3CH.) Logic mode for any modes other than CD direct, VDP direct, Dolby Pro (3CH.) Logic, Wide Screen, and LIVE.
 - Only when the surround signal parameter is set to "L,R".
 - Only when the sound simulation parameter is set to "ON".
- Operating the INPUT ADJ. button**
For low input sources such as records or the tuner, if the INPUT ADJ. button is pressed and the attenuator is set to +6dB when listening to low input sources, the result is quality sound with an improved SN ratio.
* If the sound seems distorted when set to +6dB, set it back to 0dB.
* This input level setting (on or off) setting for the different input functions is automatically stored in the memory.
* This operation is not possible for the CD and the VDP direct mode.

Recording (Audio and Video)

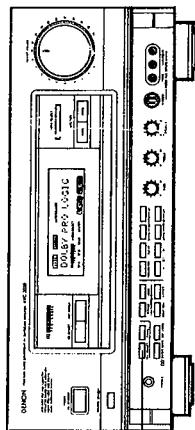

REC SELECT button

- Recording program sources (Recording the sound and picture of the source currently being monitored)
Follow the playback instructions for program sources (page 31).

Simultaneous Recording (audio or video)
The signals of the source selected with the FUNCTION selector button are output simultaneously from the DAT/TAPE-1, DAT/TAPE-2, VCR-1 and VCR-2 REC OUT jacks. If a total of four decks - two tape decks and two video decks - are connected and all four are set to the recording mode, the same source can be recorded simultaneously on all for decks.

- Press in the REC SELECT (independent recording selector) button, then release the button when the program source you want to record is displayed. The display changes in the following order:
PHONO → CD → TUNER → DAT/TAPE-1
VDP → DBS/BS → DAT/TAPE-2 → V.AUX

MFD display

REC : []

* If "PHONO", "CD", "TUNER", "DAT/TAPE-1" or "DAT/TAPE-2" is selected, no video signals will be output to the video REC OUT jacks.

- Start playback of the program source you want to record.
- Start recording on the tape deck, DAT (analog) or video deck.
For instructions on operation, refer to the manual for the corresponding component.
* This mode is cancelled if the REC SELECT button is pressed again.
* This is not possible in the CD or the VDP direct mode.

Monitoring the Recording

The actual recorded sound can be monitored when recording on a three-headed tape deck.
To monitor the sound being recorded on the tape, after performing the above settings, use the AUDIO FUNCTION selector button to select the position, DAT/TAPE-1 or DAT/TAPE-2, to which the three-headed tape deck is connected.

→ Continued

9 USING THE DSP (DIGITAL SOUND PROCESSOR)

DSP Modes

The AVC-3030 includes a DSP (Digital Signal Processor) for adjusting the sound field using digital signals. This DSP offers an excellent S/N ratio, channel separation, distortion characteristic, etc. The various parameters can be set according to conditions in the listening room to create a more realistic sound. The sound field processing modes are as follows:

1. **Modes not using the DSP**
 - Bypass: In this mode, the surround mode (DSP) is bypassed and the normal stereo sound is produced.
 - CD direct and VDP direct: In these modes, the CD input signals are sent directly to the output jacks. (No signals are output to the center and rear channels.)
2. **Modes using the DSP**
 - Surround modes: In these modes, signals are output to the center and rear speakers as well for four- or five-channel playback.

The surround modes are as follows:

1	Dolby Pro Logic	Use this when playing program sources recorded in Dolby Surround.
2	Wide Screen	Use this to enjoy program sources with the atmosphere of a movie theater, recorded in Dolby Surround.
3	Live	Use this to enjoy program sources with the atmosphere of a live performance, recorded in Dolby Surround.
4	Mono movie	In this mode, a sense of expansion is added to monaural audio sources. This mode is effective for old movies, bilingual TV movies, or monaural music sources.
5	Classic concert	This mode simulates the sound of a large concert hall. It is suited for classical music, etc.
6	Rock concert	This mode is best for playing rock, popular music, etc.
7	Church	Use this mode when playing religious music, pipe organ music, etc.
8	Jazz	This mode recreates the sound of a live music house with a low ceiling and strong vibrations.
9	Stadium	This mode simulates the sound field of an outdoor stadium.
10	Matrix	Use this to create a sense of expansion with sources recorded in stereo. The differential components of the input signals are output from the rear channel.

* These effects may not be very pronounced for some sources. If this is the case, try other modes, not relying too much on their names, and find the mode you like best. Also, if the sound seems distorted, either lower the effect level or press the CLEAR button and readjust the parameters. * To adjust the speaker balance for the different surround modes, first adjust for the Dolby Pro Logic Surround mode as explained on page 38, then use the position of the center level and rear level controls at this time as a guide to adjust the balance for that surround mode.

Parameters

The parameters are important data when using the DSP, and the parameters which can be used differ according to the DSP mode. (Refer to page 37 for a table of the usable parameters.) The various parameters are preset upon shipment from the factory, but can be changed to suit your own tastes.

1. **Independent functions (buttons)**
In each DSP mode, there are some functions which can be used, others which cannot.
 - (1) DELAY (▲ up and ▼ down) buttons
These adjust the delay time of the rear speaker signals. Remote control unit
 - (2) T.TONE (on/off) button
When pressed, test tones are emitted for adjusting the level, balance of the different channels. Remote control unit
(For details, refer to page 39.)
 - (3) EFFECT button
This is a parameter which turns the DSP on and off. When turned off, only the direct sounds are produced, as in the bypass mode. Main unit and remote control unit
Use this to check the effect of the DSP.

MFD display

EFFECT: []

2. **PARAMETER button**

Use this button to select the parameter. The normal procedure for setting parameters is to first select the parameter with the PARAMETER button, then use the ▲ and ▼ buttons to set the selected parameter. If no button is pressed for approximately 15 seconds, the parameter setting mode is automatically cancelled. (1) Initial delay
This parameter sets the distance (delay time) from the sound source to the reflecting walls. The larger the value, the further away the sound source seems.

MFD display

INIT. DELAY: []ms

(2) Room size

This parameter sets the time interval between the initial reflected sounds. The larger the value, the larger the sound field seems to be, and the greater the sense of expansion.

MFD display

ROOM SIZE: []

→ Continued

DSP Parameter Table

Parameter	Mode										
	DOLBY PRO LOGIC	WIDE SCREEN	LIVE	MONO MOVIE	CLASSIC CONCERT	ROCK CONCERT	CHURCH	JAZZ	STADIUM	MATRIX	
Independent functions											
(1) DELAY	O	O	O	X	X	X	X	X	X	O	O
(2) TEST TONE	O	X	X	X	X	X	X	X	X	X	X
(2) EFFECT	X	X	X	O	O	O	O	O	O	O	X
PARAMETER											
(1) INIT. DELAY	X	X	X	O	O	O	O	O	O	O	X
(2) ROOM SIZE	X	O	O	O	O	O	O	O	O	O	X
(3) EFFECT LEVEL	X	O	O	O	O	O	O	O	O	O	X
(4) SURROUND SIGNAL	X	O	O	X	X	X	X	X	X	X	X
(5) ADAPTIVE MATRIX	X	O	O	X	X	X	X	X	X	X	X
(6) 7kHz L.P.F.	X	O	O	X	X	X	X	X	X	X	X
(7) SOUND SIM.	X	O	O	X	X	X	X	X	X	X	X

Parameters which can be used for the different modes are stored, except for the test tone function.

NOTE:

The sound is interrupted momentarily when the delay, initial delay, room size and effect level parameters are changed, but this is normal.
For some playback sources, noise may be generated if the DSP parameters are changed.

(3) Effect level
This parameter adjusts the level of the reflected sound.
The larger the value, the greater the level of the reflected sound.

MFD display
EFFECT LEVEL: []

(4) Surround signal
This parameter is only for the WIDE SCREEN and LIVE modes.
Select the surround input signal.

MFD display
SURR. SIGNAL: []

(5) Adaptive matrix
This parameter is only for the WIDE SCREEN and LIVE modes.
The adaptive matrix is a function for emphasizing a sense of movement and positioning.
This turns the adaptive matrix, which is necessary for emphasizing the directivity, on and off.
Normally leave it on, but for sources with which emphasizing the directivity seems unnatural, turn it off.

MFD display
ADAPT. MATRIX: []

(6) 7kHz L.P.F. (low-pass filter)
This parameter is only for the WIDE SCREEN and LIVE modes.
This filter reduces the high frequencies in the reflected sound, cutting all frequencies of 7kHz and above.

MFD display
7kHz L.P.F.: []

(7) Sound simulation
This parameter is only for the WIDE SCREEN and LIVE modes.
This parameter turns various types of sound field simulations on and off. When turned off, only the direct, unprocessed signals are produced.
* If the power is turned off when the SOUND SIM. parameter set to "OFF", only the sound will be played when the power is turned back on.

MFD display
SOUND SIM.: []

DOLBY PRO LOGIC SURROUND

- Setting the delay time**
 The optimum delay time will differ depending on the listening position. Referring to the chart at right, set the optimum delay time for your room's space and setting position. For example, when the distance from the front speakers to the listening position is 4 m and that from the rear speakers to the listening position is 4 m, the optimum delay time will be 21 ms.
 The variable range of the delay time differs depending on the mode.
 For details about the variable range, see Page 25.

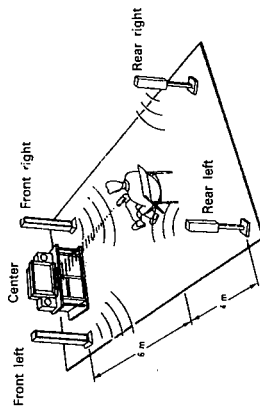

- Speaker arrangement and Dolby Pro Logic and the center mode**
 Ideally, center speakers are used for playback of Dolby Pro Logic surround.

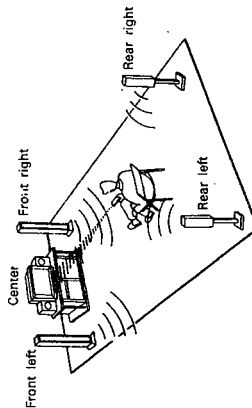

Listening position and optimum delay time for playback with Dolby Pro Logic surround

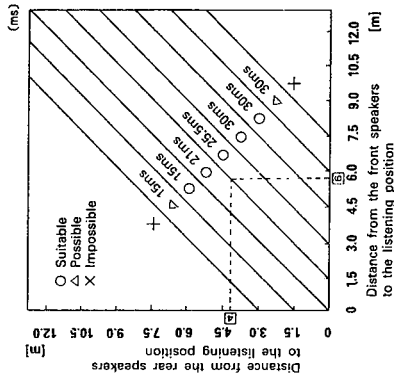

PHANTOM mode

Phantom mode: Use this mode when center channel speakers are not used. A directional emphasis circuit provides signal reproduction which is electrically oriented to the center and this provides an exciting sound field for your enjoyment.

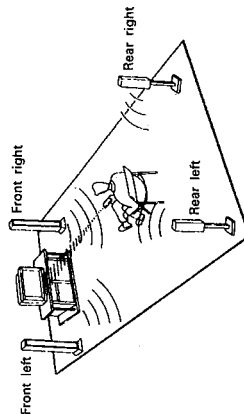

NORMAL mode

Normal mode: This mode is suited for an arrangement in which the center channel speakers are smaller than the left and right speakers. Signals below 100 Hz which have almost no effect on directional orientation are distributed to the left and right channels, whereas the center channel outputs signals greater than 100 Hz. As a result, the bass of the left and right channels increases the apparent deepness of the sound.

Continued

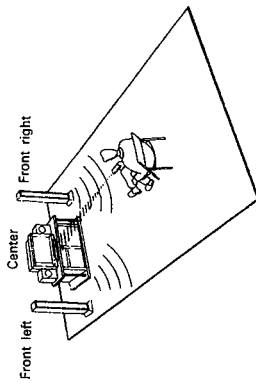

3CH LOGIC

Three-channel logic mode: Use this mode when rear channel speakers are not used. The rear channel information is reproduced by the front speakers.
NOTE: The Phantom mode cannot be set when in the 3CH Logic mode.

Automatic mode

The test tones are emitted in the order shown below, at four second intervals the first two times around, two second intervals from the third time around on.



(In the Dolby 3ch Logic mode!)



- The test tone is always emitted from the front left channel first.
- The tone will not switch to the next channel when adjusting the center level for the center channel output or when adjusting the rear level or rear balance for the rear channel output. The tone switches to the next channel two seconds after the level key is released.

Manual mode

In this mode, the channels from which the test tones are emitted are selected manually.

Use the [] and [] buttons to select the channels. The test tones are emitted in the following order each time the [] button is pressed:



The test tones are emitted in the following order each time the [] button is pressed:



- When switched from the automatic mode to the manual mode, test tones are emitted starting from the channel from which they were being output in the automatic mode.

MFD display

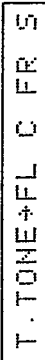

- [FL] : Front left channel
- [C] : Center channel
- [FR] : Front right channel
- [S] : Rear channels

Manufactured under license from Dolby Laboratories Licensing Corporation. Additionally licensed under one or more of the following patents: U.S. numbers 3,632,886, 3,746,792 and 3,959,590; Canadian numbers 1,004,603 and 1,037,877. "Dolby" and the double-D symbol are trademarks of Dolby Laboratories Licensing Corporation.

DSP Operation

1. Surround modes – four-channel and five-channel playback modes

SURROUND MODE button

The DSP surround mode switches in order each time this button is pressed.
 (1) Dolby Pro Logic and 3ch. Logic
 Modes for playing program sources recorded in Dolby surround

MFD display

PRO or 3CH.



① CENTER MODE button

Set the Dolby center mode according to the center speaker(s) being used.
 Refer to pages 38 to 39.

Main unit and remote control unit

MFD display

Center mode

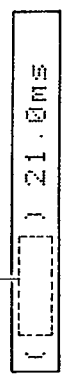

② T.TONE button

Use this to adjust the speaker levels and balance.
 Refer to page 39.

Remote control unit

PARAMETER button

Automatic mode → manual mode (Refer to page 39.)

Main unit and remote control unit

③ DELAY buttons (▲ and ▼)

Use these to set the delay time (between 15 and 30msec).

Remote control unit

④ Start playing the source.

⑤ A.V.S.E. button

CINEMA button

Set these to suit your tastes.
 (Refer to page 25.)

Remote control unit

Remote control unit

(2) WIDE SCREEN

MFD display

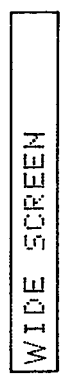

LIVE

MFD display



• The usable parameters are the same for the above two modes.

① CENTER MODE button

Same as for the Dolby Pro Logic mode.

Main unit and remote control unit

② PARAMETER button

Use this to select and set the parameters.

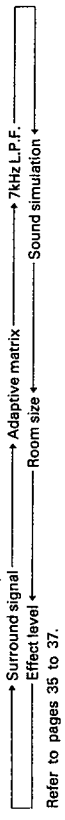

Main unit and remote control unit

Refer to pages 35 to 37.
 • The adaptive matrix (on/off) can only be turned on when the surround signal parameter is set to "L-R". If the surround signal parameter is set to "L+R", the adaptive matrix is automatically set to "OFF". If the surround signal parameter is set back to "L-R", the adaptive matrix remains set to "OFF", even if it was set to "ON" before. In addition, the room size and effect level parameters can only be set when the sound simulator parameter is set to "ON".

③ DELAY buttons (▲ and ▼)

Use these to set the delay time (between 6.0 and 30.0msec).

Remote control unit

④ Start playing the source.

⑤ A.V.S.E. button

CINEMA button

Set these to suit your tastes.
 (Refer to page 25.)

Remote control unit

Remote control unit

Continued

Technical Advice

1. "Sound field"

The sounds we hear normally or in concert halls, etc., does not only consist of sounds heard directly from the sound source (direct sound). Sound disperses in all directions and is reflected repeatedly off the walls and ceilings, and these reflected sounds reach our ears with a certain delay. Reflected sounds can be classified into two main categories. The first is initial reflected sound, and this is sound which we hear after it has reflected once or a few times off of walls. This creates an echo-like effect, but as the time difference with respect to the direct sound is short, we do not perceive this initial reflected sound as a distinct sound. Rather, it has the effect of increasing the sense of expansion or depth of the direct sound. The second category of reflected sound is called reverberations. These are sounds which reach our ears after an elaborate series of reflections. These reverberations are responsible for the richness of the overall sound. These different sounds can be graphed as follows:

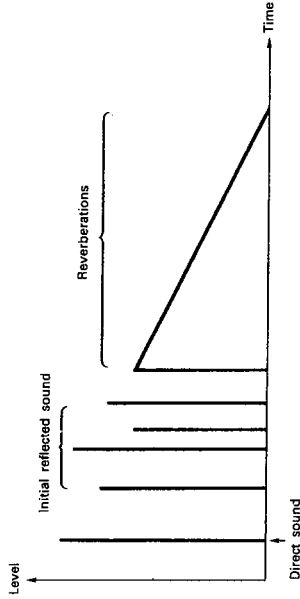

The above is only one example. Actually the reflected sound takes on a particular form depending on the environment surrounding the sound source, that is such conditions as the size of the room, the distance to the walls, the shape and material of the walls, and our position within the room. This reflected sound combines with the direct sound, and we recognize as it as the particular sound to the listening environment. This particular sound is called the sound field. Normally we hear it without paying special attention to it. The AVC-3030 uses an advanced DSP (digital signal processor) to create various sound fields.

2. DSP sound fields

We now have access to many types of music and movie sources, including LDs, CD, videos, satellite broadcasts, and so on. In most cases, some sort of sound field has already been added to these sound sources. For live recordings, of course, but also for studio recordings, the reflected sounds are recorded along with the direct sound. But when we listen to them, we sometimes feel we would like a richer sound, or for example that we would like to recreate the exciting sense of presence at a live concert. By adding the DSP sound fields to the sources, we can create a more real sound with greater atmosphere. The sound fields created by the DSP are created based on the sound source. Because of this, some adjustments are necessary to achieve an effect which fits the source, including the sound field already included in the source. The AVC-3030 offers various parameters so that the user can make these adjustments. Values have already been preset for the different parameters in the various modes upon shipment from the factory, they can be adjusted to create your own original sound fields.

- The parameters which the AVC-3030 includes for adjusting the sound field are as follows:
1 Initial delay
2 Room size
3 Effect level
4 Effect
5 7kHz L.P.F. (low-pass filter)

MFD display

MONO MOVIE
CLASSIC CONCERT
ROCK CONCERT
CHURCH
JAZZ
STADIUM

- The usable parameters are the same for the above six DSP surround modes.
• Set the parameters according to the DSP surround mode.
• Even if the parameters are set to the same values for all the surround modes, there are also internally fixed parameters, so the effects created with the various modes will be different.

PARAMETER button
Main unit and remote control unit
Initial delay Room size Effect level

- Start playing the source.
EFFECT button
Main unit and remote control unit

A.V.S.E. button
CINEMA button
Remote control unit
Remote control unit

Set these to suit your tastes. (Refer to page 25.)

MFD display

MATRIX
Remote control unit
Remote control unit
Remote control unit
Remote control unit

- MATRIX
DELAY buttons (up and down arrows)
Use these to set the delay time (between 6.0 and 370.0msec).
Start playing the source.
A.V.S.E. button
CINEMA button
Set these to suit your tastes. (Refer to page 25.)

(3)

42

→ Continued

3. Description of parameters

- (1) Initial delay
 This parameter sets the distance (delay) time from the sound source to the reflecting walls.
 Variable range: 0 to 50msec (in 10msec steps)

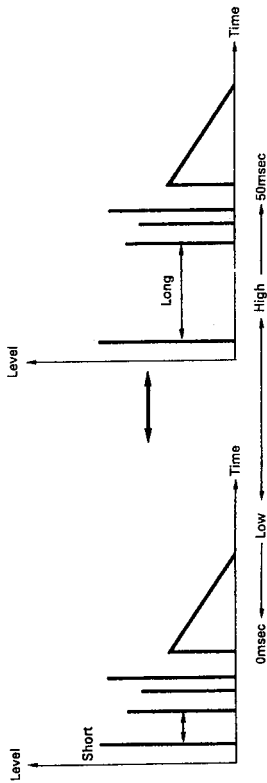

This adjusts the time difference between the direct sound and the initial reflected sound. Think of it like changing the distance from the sound source to the wall behind the stage. The higher the value, the deeper the stage seems to be.

- (2) Room size
 This parameter sets the time interval between initial reflected sounds.
 Variable range: 0.4 to 2.0 (in 0.2 steps)

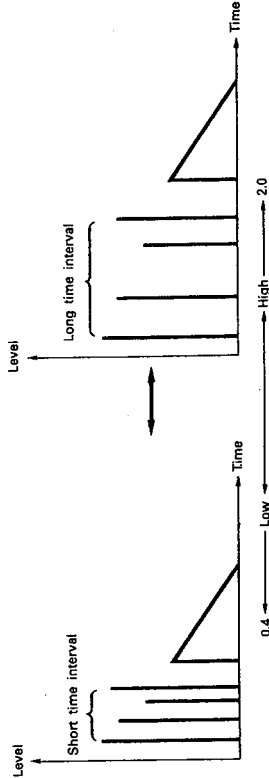

This parameter controls the size of the room. The higher this value, the greater the time interval between initial reflected sounds, and the greater the time difference between the direct sound and the initial reflected sounds. In other words, the time until which the sound reaches the listeners ears after reflecting off walls increases, as if the size of the room increased. Inversely, the lower the value, the smaller the room. This parameter has a strong effect, so if changed the sound may seem unnatural with some sources. If so, either lower the effect level or decrease the room size parameter.

- (3) Effect level
 This parameter adjusts the level of the reflected sound.
 The higher the value, the greater the level of the reflected sound.
 Variable range: 0 to 15

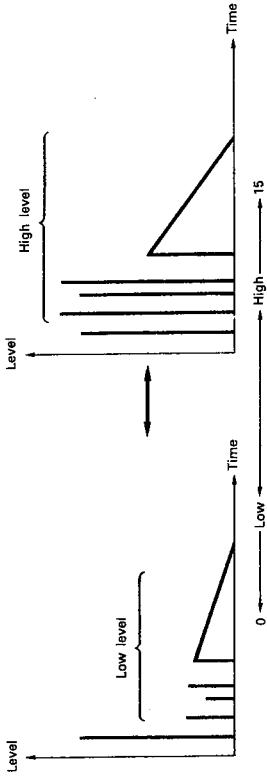

Normally the number of reflected sounds runs from several sounds to several tens of sounds, and specific data is set for each of these in the different modes. For some sources, the level of the reflected sound may be too high, making the sound harsh to listen to. In other cases, the effect will be too low and not perceivable. In such cases, use this parameter to change the overall level of the reflected sounds without changing the balance between the level of the different reflected sounds, that is without changing the specific character of the sound field. If this parameter is set too high or too low, the resulting sound may be bizarre. At level 0, in particular, there is no reflected sound at all.
 Lower the effect level if the sound seems distorted.

- (4) Effect
 This parameter turns the DSP sound field effect on and off.
 When turned off, the sound is the same as in the bypass mode, and only the direct sound is played.

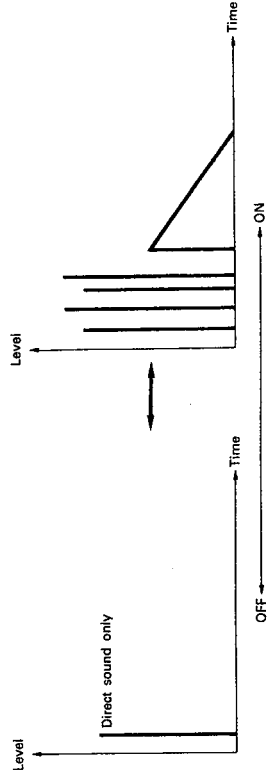

This parameter is used to check the effect of the DSP sound field. When turned off, only the direct sound is produced, and no reflected sounds are heard, regardless of the settings of the other parameters. The DSP sound field effect can be turned on and off without changing other parameters, making it easy to check the effect. The effect parameter turns back on automatically if other parameters are changed when the effect parameter is turned off.

5. Initial settings of parameters
 The initial settings of the different parameters are as shown below.
 When the CLEAR button is pressed, the settings are all reset to these values.

	SP-A	SP-B	CENTER SPFRE	REAR SPFRE	CENTER LEVEL	REAR LEVEL	CENTER MODE	3CH LOGIC	TEST TONE	DELAY TIME
BYPASS	ON	OFF	OFF	OFF	-12dB	-	-	-	-	-
DOLBY PRO LOGIC	ON	OFF	ON	ON	-12dB	-12dB	NORMAL	OFF	OFF	21msec
WIDE SCREEN	ON	OFF	ON	ON	-12dB	-12dB	NORMAL	-	-	21msec
LIVE	ON	OFF	ON	ON	-12dB	-12dB	NORMAL	-	-	21msec
MONO MOVIE	ON	OFF	OFF	ON	-	-12dB	-	-	-	-
CLASSIC CONCERT	ON	OFF	OFF	ON	-	-12dB	-	-	-	-
ROCK CONCERT	ON	OFF	OFF	ON	-	-12dB	-	-	-	-
CHURCH	ON	OFF	OFF	ON	-	-12dB	-	-	-	-
JAZZ	ON	OFF	OFF	ON	-	-12dB	-	-	-	-
STADIUM	ON	OFF	OFF	ON	-	-12dB	-	-	-	-
MATRIX	ON	OFF	OFF	ON	-	-12dB	-	-	-	21msec

	SURR. SIGNAL	A. MATRIX	7kHz L.P.F.	SOUND SIM.	INIT DELAY	ROOM SIZE	EFFECT LEVEL	EFFECT ON/OFF	AVSE ON/OFF	CINEMA
BYPASS	-	-	-	-	-	-	-	-	-	OFF
DOLBY PRO LOGIC	-	-	-	-	-	-	-	-	-	OFF
WIDE SCREEN	L-R	ON	ON	ON	-	1.0	10	ON	-	OFF
LIVE	L-R	ON	ON	ON	-	1.0	10	ON	-	OFF
MONO MOVIE	-	-	-	L	0msec	1.0	10	ON	-	OFF
CLASSIC CONCERT	-	-	-	-	0msec	1.0	10	ON	-	OFF
ROCK CONCERT	-	-	-	-	0msec	1.0	10	ON	-	OFF
CHURCH	-	-	-	-	0msec	1.0	10	ON	-	OFF
JAZZ	-	-	-	-	0msec	1.0	10	ON	-	OFF
STADIUM	-	-	-	-	0msec	1.0	10	ON	-	OFF
MATRIX	-	-	-	-	0msec	1.6	10	ON	-	OFF

*1: Both the left and right rear channels are set to -12dB.

- (5) 7kHz L.P.F. (low-pass filter)
 This filter cuts the high frequency range of reflected sounds.
 All frequencies of 7kHz and higher are cut.
 When the filter is turned off, all the frequencies are produced (this is the "through" mode).

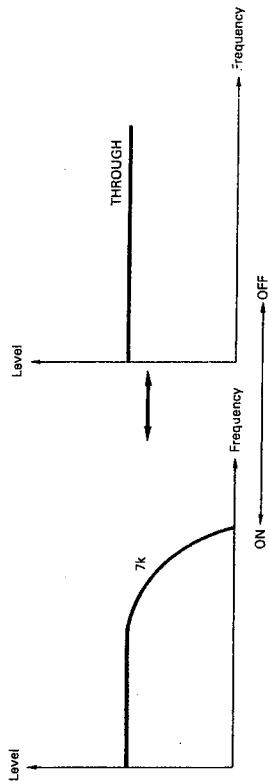

Use this to change the quality of the reflected sounds.
 When turned off, the sound is as if the room has hard, concrete walls, and when turned on, the sound becomes softer.

4. Creating original sound fields

Here we offer a general example of how to create original sound fields.

- (1) Select the surround mode to use as the base.
- (2) Adjust the room size and initial delay parameters.
 First adjust the room size parameter. At this stage, roughly determine the size of the sound field. After roughly adjusting the room size parameter, adjust the initial delay parameter. If the room size and initial delay values are too high, the result may be an unnatural sound for some sources. Find the sound you like.
- (3) Adjust the 7kHz L.P.F. (for the WIDE SCREEN and LIVE modes only)
 Use the 7kHz L.P.F. to determine the quality of the reflected sound.
- (4) Overall adjustment
 Use the effect level parameter to adjust the balance between the direct sound and the reflected sound. The atmosphere changes substantially just by changing this balance.
 If you cannot achieve the desired effect, try returning to the previous step. In particular, the relationship between steps 2 and 1 is important, so it may be a good idea to try something else. Sometimes you might discover surprising effects through different combinations.
 The preset modes have been given names indicating sound fields appropriate for different types of music sources, but when creating your own original sound fields there is no need to worry too much about these names. To create a sound field to your liking, it may be best to try different variations.
 * Press the CLEAR button to start over from scratch.

10 ON-SCREEN DISPLAY

If the SCREEN button on the remote control unit is pressed when the power is turned on, the operating modes are displayed on the monitor. TV's screen when buttons are operated, etc. The displays shown below appear on the screen when the power is turned on and the SCREEN button is operated. The mode changes between screen 1, screen 2, screen 3, screen 4 and off each time the SCREEN button is pressed. When the power is turned on, screens 1 to 3 are displayed for approximately 7 seconds, after which the on-screen display automatically turns off. When other buttons are pressed, messages related to the button that was pressed are displayed for approximately 5 seconds, then automatically turn off. (The normal picture is displayed under the message, but if no picture is being input, the background turns a color which is internally produced.)

NOTES:

- The on-screen display signals are not output to the S-VIDEO MONITOR OUT jacks or the video output jacks for recording.
- If a video source is selected but no video signals are being input (when a color background is displayed), the color background turns off after the message is displayed.

The following screens are examples of displays.

Screen 1 Surround mode display

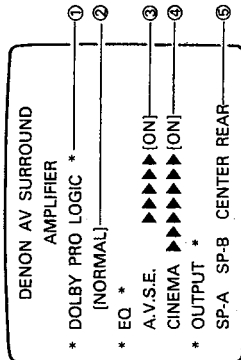

- 1 Surround mode
- 2 Center mode
- 3 A.V.S.E. setting (on/off)
- 4 Cinema setting (on/off)
- 5 Output indicators

These indicators are displayed when signals are being output to these channels.

Screen 2 Level display, etc.

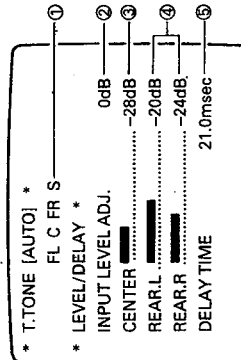

- 1 Test tone display
This is displayed when the test tone mode is set.
- 2 Input level adjustment 0dB/+6dB
- 3 Center level
The level is displayed by a bar graph and by the decibel (dB) value.
If the level is increased, the bar becomes longer.
- 4 Rear level and balance
The levels are displayed by a bar graph and by the decibel (dB) value.
If the level is increased, the bar becomes longer.
- 5 Delay time
This displays the delay time.

Screen 3 Input/output display

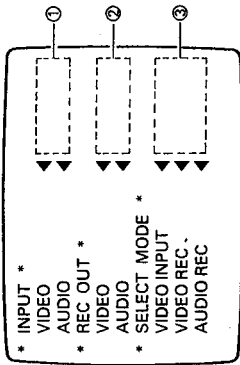

- 1 Input selector display
The set input is displayed here.
- 2 Recording output selector
This indicates the recording output.
- 3 Select mode display
This is displayed when a select mode such as the recording output select or video select mode is set.

Screen 4 Parameter display, etc.

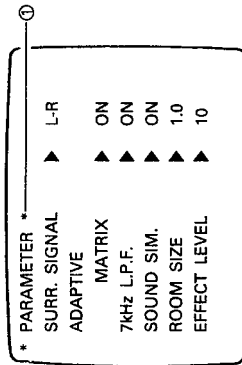

- 1 Parameter display
This indicates the DSP parameters.
Displayed for approximately 15 seconds.

Other 1

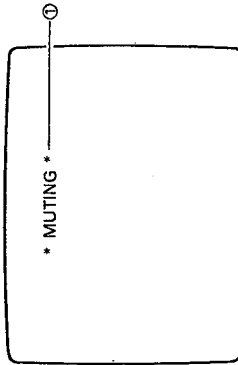

- 1 Muting display
This flashes when in the muting mode.

Other 2

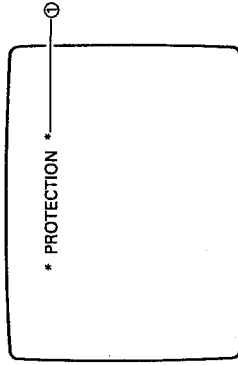

- 1 Protection circuit display
This flashes when the protection circuit is activated.
For details, refer to page 30.

11 LAST FUNCTION MEMORY

- This amplifier is equipped with a last function memory which stores the input and output setting conditions as they were immediately before the power is switched off. This function eliminates the need to perform complicated resettings when the power is switched on.
- This amplifier is also equipped with a back-up memory. This function provides approximately one month of memory storage with the power cord disconnected.

12 TROUBLESHOOTING

- If a problem should arise, first check the following:
1. Are the connections correct?
 2. Have you operated the amplifier according to the Operating Instructions?
 3. Are the speakers, turntable, and other components operating properly?
- If the amplifier is not operating properly, check the items listed in the table below. Should the problem persist, there may be a malfunction. Disconnect the power immediately and contact your store of purchase.

Symptom	Cause	Measures	Page
LED not lit and sound not produced when power switch set to on.	<ul style="list-style-type: none"> • Power cord not plugged in securely. 	<ul style="list-style-type: none"> • Check the insertion of the power cord plug. 	11
LED lit but sound not produced.	<ul style="list-style-type: none"> • Speaker cards not securely connected. • OUTPUT button is off. • Improper position of the audio input selection button. • Volume control set to minimum. • MUTING is on. 	<ul style="list-style-type: none"> • Connect securely. • Select SP-A, SP-B, CENTER, or REAR of the remote control's OUTPUT button. • Set to a suitable position. • Turn volume up to suitable level. • Switch off MUTING. 	9-11 25
"PROTECTION!" display appears multi-function fluorescent display.	<ul style="list-style-type: none"> • Speaker terminals are short-circuited. • Incomplete connection of the shorting pin between PRE OUT and MAIN IN. 	<ul style="list-style-type: none"> • Turn volume up to suitable level. • Switch off MUTING. • Switch power off, connect speakers properly, then switch power back on. • Connect shorting pin properly. 	9, 14-17 15 25
Sound produced only from one channel.	<ul style="list-style-type: none"> • Incomplete connection of speaker cords. • Incomplete connection of input/output cords. • Left/right balance is off. 	<ul style="list-style-type: none"> • Connect securely. • Connect securely. • Adjust balance knob properly. 	9-11 9-13
Positions of instruments reversed during stereo playback.	<ul style="list-style-type: none"> • Reverse connections of left and right speakers or left and right input/output cords. 	<ul style="list-style-type: none"> • Check left and right connections. 	9-13
Sound seems distorted.	<ul style="list-style-type: none"> • INPUT LEVEL ADJ. button set to +6dB. • Effect level parameter is high. 	<ul style="list-style-type: none"> • Set to 0dB. • Lower effect level parameter. 	33 36-48
Sound seems strange.	<ul style="list-style-type: none"> • DSP parameter settings are poor. 	<ul style="list-style-type: none"> • Press the CLEAR button then adjust the DSP parameters. 	34-47
Sound field effect cannot be heard.	<ul style="list-style-type: none"> • EFFECT is turned off. • SOUND SIM. is turned off. 	<ul style="list-style-type: none"> • Turn EFFECT on. • Turn SOUND SIM. on. 	16 36
Recording (audio and/or video) is not possible.	<ul style="list-style-type: none"> • CD or VDP direct mode set. 	<ul style="list-style-type: none"> • Cancel CD or VDP direct mode. 	14, 15
CD or VDP direct mode does not work.	<ul style="list-style-type: none"> • REC SELECT is on. 	<ul style="list-style-type: none"> • Cancel REC SELECT. 	14, 15

Symptom	Cause	Measures	Page
Humming noise produced when record is playing.	<ul style="list-style-type: none"> • Ground wire of turntable not connected. • Incorrect PHONO jack connection. • TV or radio transmission antenna nearby. 	<ul style="list-style-type: none"> • Connect securely. • Connect securely. • Contact your store of purchase. 	10
Howling noise produced when volume is high.	<ul style="list-style-type: none"> • Turntable and speaker systems too close together. • Floor is unstable and vibrates easily. 	<ul style="list-style-type: none"> • Separate as much as possible. • Use cushions to absorb speaker vibrations transmitted by floor. If turntable is not equipped with insulators, use audio insulators (commonly available). 	-
Sound is distorted.	<ul style="list-style-type: none"> • Stylus pressure too weak. • Dust or dirt on stylus. • Cartridge defective. 	<ul style="list-style-type: none"> • Apply proper stylus pressure. • Check stylus. • Replace cartridge. 	-
Volume is weak.	<ul style="list-style-type: none"> • MC cartridge being used. 	<ul style="list-style-type: none"> • Replace with MM cartridge or use a head amplifier or step-up transformer. 	10
Amplifier does not operate properly when remote control unit is used. (When LEARNED/TX LED is lit)	<ul style="list-style-type: none"> • Batteries dead. • Remote control unit too far from amplifier. • Obstacle between amplifier and remote control unit. • Learning process to the button improper. • Different button is being pressed. 	<ul style="list-style-type: none"> • Replace with new batteries. • Move closer. • Remove obstacle. • Set learning again. • Press the proper button. 	22 22 22 28
Amplifier does not operate properly when remote control unit is used. (When LEARNED/TX LED is not lit)	<ul style="list-style-type: none"> • Learning process to the button improper. • Learning process has not been applied to the button. • Batteries dead. • ⊕ and ⊖ ends of battery inserted in reverse. • Improper position of PROGRAM switch. 	<ul style="list-style-type: none"> • Set learning again. • Apply learning process. • Replace with new batteries. • Insert batteries properly. • Set to desired position (AMP, AV). 	28 28 22 22
Presat memory codes do not operate.	<ul style="list-style-type: none"> • Other code already learned at that key. 	<ul style="list-style-type: none"> • Reset. 	29

Common problems arising when listening to the CD, records, tapes, and FM broadcasts

13 SPECIFICATIONS

- **Audio Section**
 (Power amplifier)
 Rated output:
 110 W + 110 W (8 ohms, 20 Hz - 20 kHz with 0.03% THD)
 CENTER (center 1 ch driven)
 110 W (8 ohms, 20 Hz - 20 kHz with 0.03% THD)
 REAR (rear 2 ch driven)
 35 W + 35 W (8 ohms, 1 kHz with 0.05% THD)
 5 Hz to 50 kHz (Main in - speaker out)
 1 V/47 k ohms (Main in - speaker out)
 Signal-to-noise ratio:
 120 dB (Main in - speaker out)
 Output terminals:
 Main: A or B 6 to 18 ohms
 A + B 12 to 18 ohms
 Center: 6 to 18 ohms
 Rear: 6 to 18 ohms
- **(Pre-amplifier)**
 Line input (Each line input - FRONT PRE OUT)
 150 mV/47 k ohms PHONO (MMI): 2.5 mV/47 kohms, CD DIRECT: 150 mV/33 kohms
 Frequency response:
 5 Hz to 100 kHz: ±3 dB (CD DIRECT)
 5 Hz to 150 kHz: ±3 dB (CD DIRECT)
 BASS: ±10 dB at 100 Hz
 TREBLE: ±10 dB at 10 kHz
 Signal-to-noise ratio (FRONT PRE OUT): 92 dB
 95 dB (CD DIRECT)
 Distortion factor:
 0.01% 1 kHz 1 V (BYPASS mode)
 0.003% 1 kHz 3 V (CD DIRECT)
 0.003% 1 kHz 3 V (common for FRONT, CENTER, REAR, MONO, each PRE OUT)
- **Rated output/Maximum output:** 284 mW (8 ohms)
Maximum headphone output: 284 mW (8 ohms)
Phono equalizer (PHONO input - REC OUT)
 RIAA deviation: ±1 dB (20 Hz to 20 kHz)
 Signal-to-noise ratio: 76 dB (A weighting, with 5 mV input)
Rated output/Maximum output: 150 mV/8 V
 Distortion factor: 0.03% (1 kHz, 3 V)
- **Video Section**
 Standard video jacks
 Input and output level/impedance: 1 Vp-p/75 ohms
 1 Hz to 10 MHz +0, -3 dB
S-video output jacks
 Frequency response:
 Input and output level/impedance: Y (brightness) signal: 1 Vp-p/75 ohms
 C (color) signal: 0.286 Vp-p/75 ohms
 1 Hz to 11 MHz +0, -3 dB
- **General**
Power supply: 120 V AC, 60 Hz.
Power consumption: 5.5 A
Maximum external dimensions: 494 (W) x 184 (H) x 421 (D) mm (17-3/32" x 7-1/4" x 16-37/64")
Weight: 15.0 kg (33 lbs 2 oz)
 • Remote control unit (RC-102):
 • System remote control with learning function
 Total buttons: 62
 DENON system code
 DAT: 8 buttons
 CD player: 8 buttons
 Cassette deck: 8 buttons
 Tuner: 2 buttons
 VDP: 8 buttons
 AVC-3030 fixed codes: 47 buttons
Learning buttons
 System call buttons: 3 (maximum of 10 codes per button)
 Program - AMP: 9 buttons
 - AV: 58 buttons
Maximum total: 35 codes
Batteries: R6P/AA Type (two batteries)
External dimensions: 70 (W) x 215 (H) x 18 (D) mm (2-3/4" x 8-15/32" x 46/64")
Weight: 17.5 g (Approx. 6 oz) (including batteries)

* For purposes of improvement, specifications and design are subject to change without notice.

DENON SERVICE NETWORK

- Please contact one of our overseas service centers, listed below, for follow-up service consultation.
- Wenden Sie sich für anfallende Wartungs- bzw. Reparaturarbeiten bitte an eine der folgenden aufgeführten Kundendienststellen.
- Adressez-vous à nos centres de service d'outre-mer indiqués ci-dessous, pour le service après-vente.
- Per il servizio dopo vendita rivolgetevi Vi al nostro centro di servizio estero appropriato della lista seguente.
- Para consultas de servicio por favor dirigirse a cualquiera de nuestros centros de servicio en el extranjero, enlistados abajo.
- Neem contact op met één van onze reparatie-inrichtingen in het buitenland, waarvan hier een lijst volgt, voor na-service.
- Ta kontakt med nedan angivna servicecenter för rådgivning om servicearbeten efter försäljningen.
- Favor contactar um de nossos centros de serviços internacionais, abaixo listados, para consulta de serviços de acompanhamento.

- Australia** AWA Limited, 112-118 Talavera Road, North Ryde NSW 2113, Australia, Postal Locked Bag No. 12, North Ryde, Tel: (02) 888-9000, Fax: (02) 888-9310, Telex: AA 22692
- Austria** Boyd U. Haas Electronic-Baulementa Vertriebsges. mbH & Co., KG Rupertusplatz 3 A-1170 Wien Tel: 0222-460288
- Belgium** Transel-Sabima P.V.B.A., Harmoniestraat 13, 2018 Antwerpen 1, België Tel: 03-237-3807
- Canada** Denon Canada Inc., 17 Denison Street, Markham, Ontario, Canada L3R 1B5 Tel: 416-475-4085
- Denmark** Audionord Danmark A/S, Vester Alle 7, 8000 Århus C, Tel: 96-128811
- Finland** Suomen Hi-Fi Klubi OY, Nylandsгатан 4-6, Helsingfors, Tel: 0644401
- France** Denon France S.A., 3 Boulevard Ney, 75018 Paris, Tel: (1) 40 35 14 14
- Germany** Denon Electronic GmbH, Halskestraße 32, 40330 Ratingen, Tel: 02102-4895-0
- Greece** Kinoshiki Ass., 47 Stouras Str., Athens, Tel: 3606-998
- Hong Kong** Tai Lun Radio Services Ltd., 310 Nathan Road, Kowloon, Hong Kong Tel: K-855005-9
- Iceland** Japis Ltd., Brautarholt 2, Box 396, 101 Reykjavik, Iceland Tel: 27133
- Indonesia** PT Autoconco Jaya, Cideng Barat No. 7 Jakarta, Indonesia Tel: 6016599
- Italy** Melchioni S.P.A., Via P. Colletta 37-20135 Milano Tel: 02-57941
- Malaysia** Pertamina Audio Sdn. Bhd., 44-46 Jalan SS 22/21 Damansara Jaya, 47400 Selangor, Malaysia Tel: 719 3957
- Mexico** Labrador, S.A. de C.V. Zamora No. 154 Col. Condesa 06140 Mexico, D.F. Tel: 286 55 09 Fax: 286 34 62
- Netherlands** Penhold B.V., Isanweg 6, 1043 AK Amsterdam Tel: 020-611-4957
- New Zealand** Avalon Audio Corp. Limited, 119 Wellesley Street, Auckland 1, New Zealand Tel: 09-779-351, 09-775-370
- Norway** Hi-Fi Klubben, Box 70 Ankerthorget, 0133 Oslo 1 Tel: 02-112218
- Portugal** Videoacustica Cta. Do Paizinho-Armazém 5-Estrada De Circunvalação-Apart. 3127 1303 Lisboa Codex Tel: 2187004/2187096
- Singapore** Pertamina Audio Pte. Ltd., Alexandra Distripark Bk 4, No. 03-39 Pasir Panjang Road, Singapore 0511 Tel: 278-4411
- Spain** Gapiasa S.A., Conde de Torroja, 24, 28022 Madrid Tel: 747-7777
- Sweden** Sveriges Hi-Fi Klubb, Box 5116, S-402 23 Göteborg, Tel: 031-200040
- Switzerland** Diethelm & Co., AG, Eggbühlstrasse 28, 8052 Zürich, Tel: 01-3013030
- Taiwan R.O.C.** Taiwan Kolin Co., Ltd., 8th Fl., 83, Sec. 1, Chung-king S. Rd., Taipei, Taiwan R.O.C. Tel: (02) 314-3151 (20 Lines), Fax: (886) 02-3614037, Telex: 11102 TKOLN
- Thailand** Mahajak Development Co., Ltd., 6th Fl., Mahajak Building, 46 Sukhumvit 3 (Nanana), Klongtoey, Prakanong, Bangkok 10110, Tel: 255-0000
- United Kingdom & Ireland** Hayden Laboratories Ltd., Hayden House, Chiltern Hill, Chalfont St. Peter Gerrards Cross, Bucks, SL9 9JG, Tel: 0753-858447
- U.S.A.** Denon America Inc., 222 New Road Parsippany, NJ 07054, U.S.A., Tel: 201-882-7490, Fax: 201-575-1213

- If there is no service center in your local area, consult the outlet where the equipment was purchased.
- Falls sich in Ihrer Nähe keine Kundendienststelle befindet, wenden Sie sich an das Geschäft, wo das Gerät gekauft wurde.
- Si n'y a aucun centre de service dans votre région, consultez votre revendeur.
- Se nella Vostra zona non c'è il centro di servizio, rivolgetevi al negozio dove avete acquistato l'apparecchio.
- Si no hay centros de servicio en su área local, consulte en donde haya comprado su equipo.
- Als er in uw streek geen reparatie-inrichting is, neemt u contact op met de vestiging waar u de apparatuur gekocht heeft.
- Se não existir um centro de serviços em sua área local, consulte o estabelecimento onde o equipamento foi adquirido.

H20701

DISASSEMBLY

(To reassemble reverse disassembly)

1. Top Cover

- (1) Remove 4 screws ① each on left and right sides which fix the both sides.
- (2) Remove 4 rear screws ②.

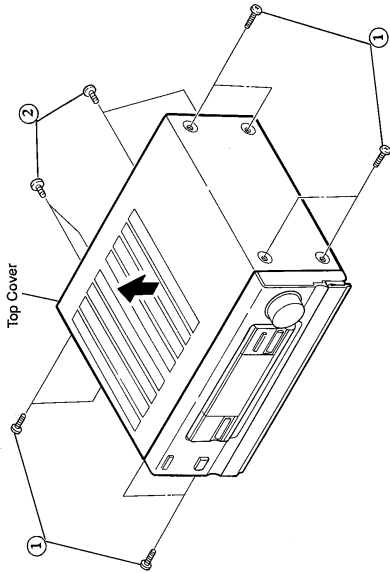

2. Front Aluminium Panel

- (1) Remove each on left and right screws ③ and detach Side Plate.
- (2) Remove 2 upper screws ④, unfasten upper hooks at two places, and detach Panel from upper-portion in arrow direction.

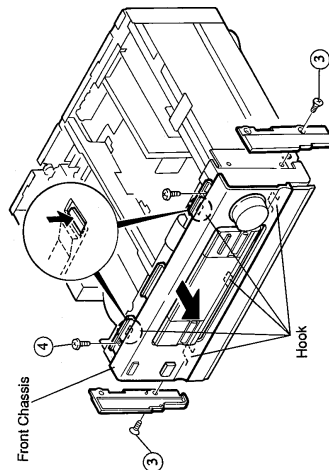

3. Front Mold Panel

- (1) Remove connector of wire, for LED of Motor VR ⑤, and pull out Master VR knob ⑥ and 3 round knobs ⑦.
- (2) Remove all connectors of wire, connected to FLD P.C.B.
- (3) Remove fixing screws ⑧ from upper and lower positions. (Totally 4 screws).

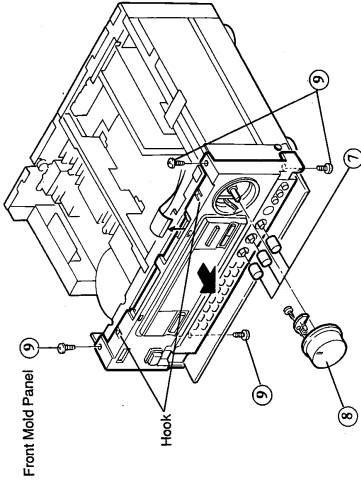

4. Front Chassis

- (1) Remove Master VR and 3 VR nuts of one set, and then remove bracket ⑩.
- (2) Remove 3 fixing screws of V-AUX P.C.B. ⑪.
- (3) Remove snap plate for fixing headphone jack and fixing screws for fixing wire ⑫.
- (4) Remove 2 screws ⑬ for attaching FOOT.
- (5) Remove screws for attaching chassis ⑭. (Upper 2, front 2, and lower 4 screws).

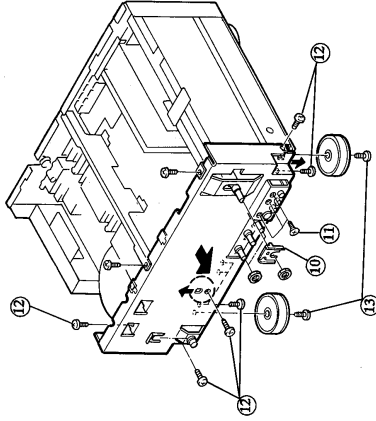

5. Rear Panel

- (1) Remove short circuit pin ⑮, and remove cord bush ⑯.
- (2) Remove 20 terminal connecting screws ⑰.
- (3) Remove panel fixing screws (Lower 4, front 6 screws).

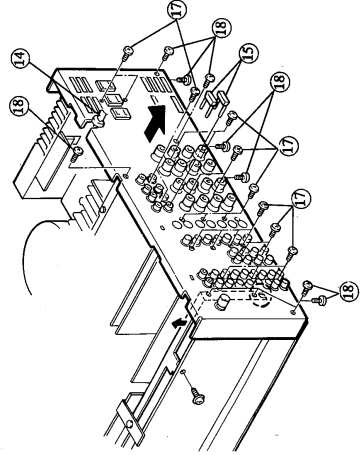

ADJUSTMENT

Idling Current (1U-2433A-1)

Required measurement equipment: DC Voltmeter

Arrangement

- (1) Avoid direct blow from an air conditioner or an electric fan, and adjust the unit at normal room temperature 15°C ~ 30°C. (59 F ~ 86 F).

(2) Presetting

- POWER (Power source switch) → OFF
- MODE (Mode button) → BY PASS
- FUNCTION (Function button) → CD
- VOLUME (Volume control) → 0: fully counterclockwise (1 min.)
- CENTER VOLUME (Center volume control) → -12dB
- BASS, TREBLE (Tone control) → 0: (Controls to center)
- SPEAKERS (Speaker terminal) → No load (Do not connect speaker, dummy resistor, etc.)

- (3) Output 10mVrms, 1kHz sine wave from sine wave oscillator and connect it to input terminal on reverse side.

Adjustment

- (1) Remove top cover and set VR251, VR301, VR302, and VR503, VR504 of 1U-2433A-1 (Main Unit) at counterclockwise fully.
- (2) Connect DC Voltmeter to test points (Lch T.P.1, Rch T.P.2, CENTER th T.P.3).
- (3) Connect power cord to AC Line, and turn power switch "ON".
- (4) Allow 15 minutes, and turn VR301, VR302 and VR251 clockwise (1 min.) and adjust the TEST POINTS voltage to 1.5 mV ± 1.0 mV DC.
- (5) After 2 minutes from preset, turn VR301, VR302, and VR251 to set the voltage to 3 mV ± 1.0mV DC.

Idling Adjustment in Operation of OPTICAL CLASS A.

- (6) Allow 10 minutes, and turn VOLUME (Main tuning knob) to MAX (1 min.) and turn VR503, VR504 and VR253 clockwise within 15 minutes, and adjust the TEST point voltage to 15 mV ± 5mV DC.
- (7) Allow 1 minutes, and adjust the VR503, VR504 and VR253 so that the meter reads 20 mV ± 10 mV DC.
- (8) Allow 5 minutes further, and confirm that the TEST POINT Voltage is 20 mV ± 10 mV DC.

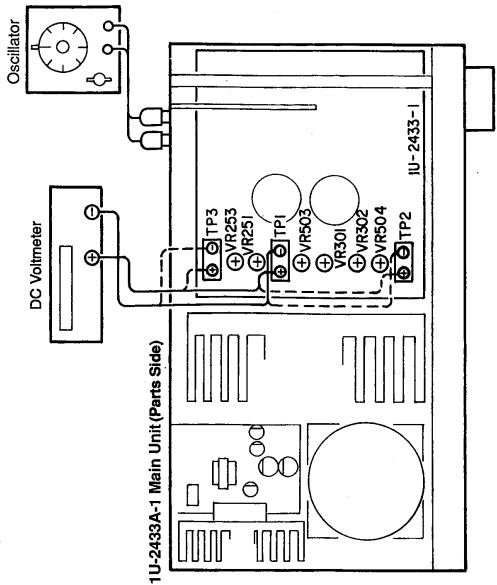

Video H SYNC-V SYNC Oscillation Frequency Adjustment

Required measurement equipment: Frequency Counter

Arrangement

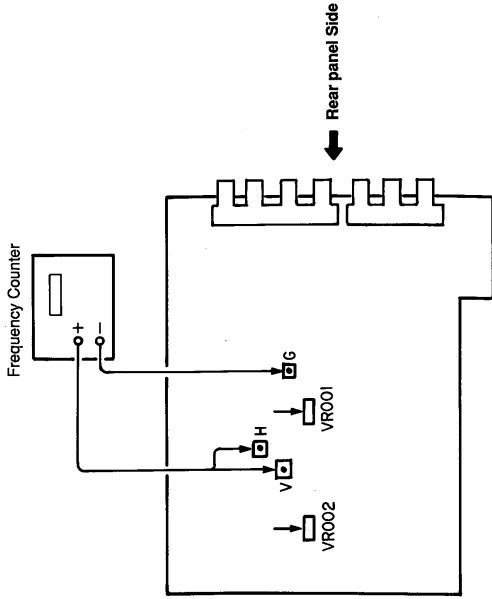

Video & Microcomputer PWB (1U-2435C-2) (Component Side)

- (1) H SYNC (Horizontal synchronous pulse Adjustment)
 - Ground (-) side of frequency counter to G-terminal at the test point (T.P.) of Video and microcomputer P.W.B. (1U-2435C-2).
 - Confirm that no insertion of video input or output is made. (With optional function)
- (2) V SYNC (Vertical synchronous pulse Adjustment)
 - Connect probe for frequency counter to H.
 - Turn VR002 with non-magnetic screwdriver and adjust the frequency counter so as to read 15.734 kHz ± 200 Hz.
- (3) Adjustment completion
 - Disconnect the frequency counter.

SEMICONDUCTORS

IC's
TMP87CKM70AF-6040
(V.V:IC601)

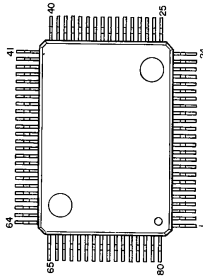

(Note)
Indicators before IC numbers denote P.W.B. Name.

- MA : Main Amp P.W.B. Unit
- RE : Rear Input P.W.B. Unit
- VV : VFD, Video P.W.B. Unit
- SU : Surround P.W.B. Unit

Terminal Voltage	Terminal Name		Initial Setting	Usage
	Power OFF (V)	ON (V)		
0.4	5.0	49 P77(S0)	O L*	L AMP MUTE (H at MUTE mode)
0.3	4.8	50 P80(S0)	O H	L POWER Power relay control
0.4	4.8	51 P81(S1)	O H	L FUSH Flash preventive control
0.3	-6.6	52 P82(S2)	O H	L KS1
0.3	-6.6	53 P83(S3)	O H	L KS2
0.3	-6.6	54 P84(S4)	O H	L KS3 Key Scan Stable
0.3	-6.6	55 P85(S5)	O H	L KS4
0.3	-6.6	56 P86(S6)	O H	L KS5
0.3	-6.6	57 P87(S7)	O H	L KS6
0.3	-7.0	58 P88(S8)	I H	L K41
0.3	-7.0	59 P89(S9)	I H	L K42 Key Scan Receive
0.3	-7.0	60 P90(S10)	I H	L K43
0.3	-7.0	61 P91(S11)	I H	L K44
0.3	-7.0	62 P94(S12)	I H	L K45 Key Scan Receive
0.3	-7.0	63 P95(S13)	I H	L K46
0.4	4.9	64 P96(S14)	O L*	L VCR-1 REC NH (H at inhibit mode)

Terminal Voltage	Terminal Name		Initial Setting	Usage
	Power OFF (V)	ON (V)		
0.4	4.9	65 P97(S15)	O L*	L VCR-2 REC NH (H at inhibit mode)
0.4	-15.0	66 Vxx	PW	- Vxx
0.5	0.0	67 P40(KEY0)	O H	L A
0.0	0.0	69 P41(KEY1)	O H	L B VIDEO INPUT CONTROL (H-D1405BP)
0.0	0.0	70 P48(KEY2)	O H	L A
0.0	0.0	71 P44(KEY4)	O H	L B VIDEO REC OUT CONTROL (H-D1405BP)
0.0	0.0	72 P45(KEY5)	O H	L C
0.0	0.0	73 P46(CIN5/KEY6)	O H	L C (VCR-1)
0.0	0.0	74 P47(CIN6/KEY7)	O H	L ASP-OUT1 (MONITOR)
0.3	0.3	75 P90(CIN3)	-	- vacant
0.3	0.6	76 P51(CIN2)	I H	L ASP-3 (VCR-1)
0.2	0.6	77 P92(CIN1)	I H	L ASP-2 (VDP)
0.3	0.6	78 P93(CIN0)	I H	L ASP-1 (DBSGS)
0.0	0.3	79 P54	O H*	L TUNER MUTE (H at MUTE mode)
0.2	0.5	80 P95(PWMPFD0)	I H*	L SYNCDET OSD Synchronization (H at externally synchronized)

SSM-2125D (SU: IC601)

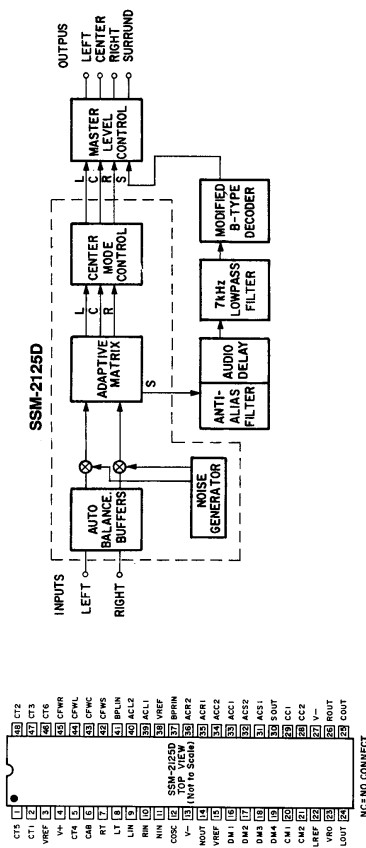
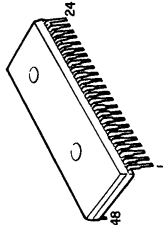

Terminal Voltage	Terminal Name		Initial Setting	Usage
	Power OFF (V)	ON (V)		
0.0	0.0	25 P00	O H	L CK
0.0	0.0	26 P01	O H*	L CE Audio I/O Surround (H at initial Mode)
0.0	0.0	27 P02	O H	L DATA (L2R21, R222)
0.0	0.0	28 P03	O H	L CK
0.0	5.0	29 P04	O H	L DATA Volume control (T03179P)
0.0	0.0	30 P05	O H	L ST1 REAR CH
0.0	0.0	31 P06	O H	L ST2 CENTER CH
0.0	0.0	32 P07	O H	L INPUT ADJ INPUT LEVEL ADJ
5.2	5.0	33 V00	PW	- +5V
0.3	-15.0	34 P60(G15)	O H	L VOLUP Motor drive control (B4610)
0.4	-15.0	35 P61(G14)	O H	L VOLDOWN
4.9	5.0	36 P62(G13)	O H*	L LED MOTOR VOLUME LED (H at full time)
0.4	-15.0	37 P63(G12)	O H	L AV8E AVSE Control
0.4	5.0	38 P64(G11)	O L	H CINEMA: CINEMA Equalizer control
0.4	-15.0	39 P65(G10)	O L*	L CD or VDP DIRECT (H at VDP DIRECT mode)
0.4	-15.0	40 P66(G9)	O H*	L DIRECT MODE ON/OFF (H at DIRECT mode)
0.4	-15.0	41 P67(G8)	O L	H L+R
0.4	4.8	42 P70(G7)	O L	H PRO LOGIC CENTER SIGNAL SWITCH
0.4	4.8	43 P71(G6)	O L	H H-Vision (LC-486)
0.4	4.8	44 P72(G5)	O H	L SP-A
0.4	-15.0	45 P73(G4)	O H	L SP-B Speaker relay control
0.4	-15.0	46 P74(G3)	O H	L SP-REAR
0.4	-15.0	47 P75(G2)	O H	L SP-CENTER
0.4	4.7	48 P76(G1)	O H	L HFP PRE MUTE Premute control

Terminal Voltage	Terminal Name		Initial Setting	Usage
	Power OFF (V)	ON (V)		
5.3	5.2	1 P10(INT0)	I L*	- Power breakdown: Break down detect input (L at Breakdown)
0.0	0.0	2 P11(INT1)	I H*	- PROTECTION: PROTECTION INPUT (H at detect mode)
0.0	5.0	3 P12(INT2/TC1)	O L*	L OSD_CS OSD Control (H at data transfer mode)
0.0	0.0	4 P13(DV0)	I -	- MODE Shift 1 (Shift of Previous AVCAVR MODE)
0.0	0.0	5 P14	O H	L DM1
0.0	0.0	6 P15(TC2)	O H	L DM2 Dolby-Prologic Control (SSK2125)
0.0	0.0	7 P16	O H	L DM3
0.0	0.0	8 P17	O H	L DM4
0.0	0.0	9 TEST	I -	- Connect to GND
0.0	0.0	10 P21(XTN)	O H	L CM1 Dolby-Prologic Control (SSK2125)
0.0	0.0	11 P22(XTOUT)	O H	L CM2
5.0	4.9	12 RESET	I L	- RESET: Microcomputer reset input
2.3	2.0	13 XIN	I -	- Oscillator connection (8MHz)
2.4	2.0	14 XOUT	I -	-
0.0	0.0	15 Vss	PW	- 0V (GND)
0.0	0.0	16 P20(INT5/STOP)	I -	- MODE Shift 2 (Shift of Previous OBM MODE)
5.2	5.1	17 P30(INT3/TC3)	I L	- REMOTE: REMOTE Control reception signal input
0.0	5.1	18 P31(TC4)	O L*	L FL Driver Control (MS02128)
0.0	0.0	19 P32(SCK)	O H	L CK FL OSD Control (H at data transfer mode)
0.0	5.2	20 P33(SI)	O L*	L RESET (MS02128, MS0554) (H at reset)
0.0	0.0	21 P42(SO)	O H	L DATA: FL OSD Control
0.0	5.1	22 P35(HSK)	O H	L BCK
0.0	0.0	23 P36	O H	L WCK DSP Control (VSS-215)
0.0	5.1	24 P37(HSO)	O H	L CD

LC7821 (RI: IC153, 155)
LC7822 (RI: IC154)(SU: IC605)

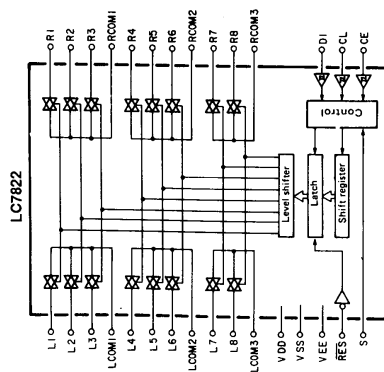
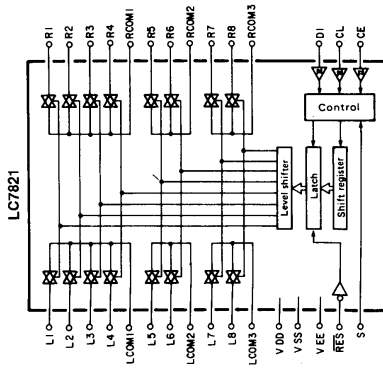
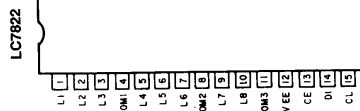
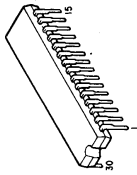
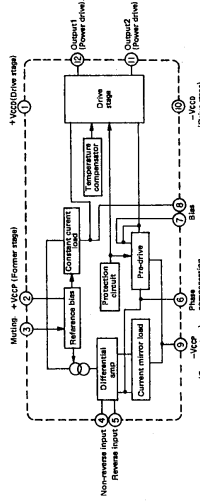
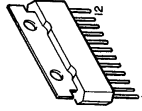

Table of LC7821, LC7822 Terminal Function

Name of Terminal	IO	Equivalent Internal Circuit	Function of Terminal
VDD, VSS, VEE L1 - L3, R1 - R3 LCOM1 - LCOM4 RCOM1 - RCOM4			Power terminal. In/Out terminal of analog switch.
CL, D1, CE	I	Serial data input terminal (Schmitt trigger). Data input terminal. Chip enable terminal. Selection terminal for using of two. Address will be shifted as per below table when switching S terminal to L or H.	
S	I		
RES	I		Reset terminal. Condition of analog switch is not fixed at the time of turning on the power. When shift this terminal to L, all analog switches become OFF.

Name of Item	S Terminal	Address
LC7821	L	A0 A1 A2 A3
LC7822	H	1 1 0 1

μPC1225H (RI: IC401, 402)



NJM2220S (V.V: IC005)

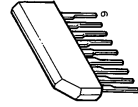

1. M.M time constant setting.
2. SYNC input (Comp. H. V. SYNC).
3. SYNC output.
4. SSG SYNC input.
5. GND
6. SYNC DET. Determine Control.
7. SYNC DET
8. M.M Smoother
9. V+ -5 - 10V

MSC7128-03SS (VV:IC802)

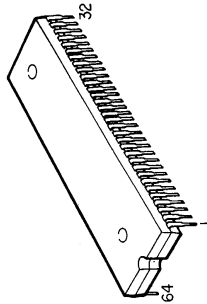

MSC7128-03SS Terminal Function

Terminal Name	Terminal No.	I/O	Connection to:	Function
Vcc1	60			Vcc1 — Vcc Internal logic power supply.
Vcc2	59			Vcc2 — Vcc Fluorescent display tube drive circuit power supply.
Vss	5		Power Supply	
VEE	6			
DA	63	I	Microcomputer	Serial data input. Input from (Positive logic) LBS.
CP	62	I	Microcomputer	Shift clock input. Data shift at rise time of CP.
CS	64	I	Microcomputer	Chip select input. Serial transfer of data is prohibited when set to "H".
OSCI	2			External terminal of CR for CR oscillation.
OSCO	1	O		fosc: 250 KHz at C=100 PF, R=47 KΩ
RESET	61	I		Reset input (Built-in Pull-up resistor). Internal logic is reset when "LOW" is set, and output of SEG1 - 36, COM1 - 16 all become "LOW".
COM1 - COM16	7 - 22	O	Fluorescent display tube grid	Drive output of fluorescent display tube grid. Able to connect directly to fluorescent display tube, and no Pull-down resistor is needed. I _o > -30 mA
SEG1 - SEG35	58 - 24	O	Fluorescent display tube anode	Drive output of anode for fluorescent display tube 5x7 dot. Able to connect directly to fluorescent display tube and no Pull-down resistor is needed. I _o > -2 mA.
SEG36	23	O	Fluorescent display tube anode	Drive output of anode for fluorescent display tube cathode. Able to connect directly to fluorescent display tube and no Pull-down resistor is needed. I _o > -10 mA.
TEST STEP	4	I		Test mode setting input (Normally opened).
TEST COUNT	3	I		Test clock input (Normally opened).

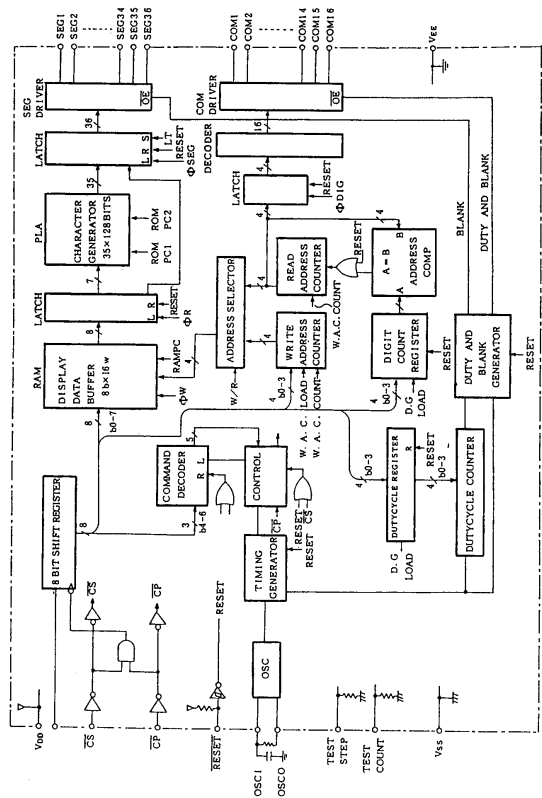
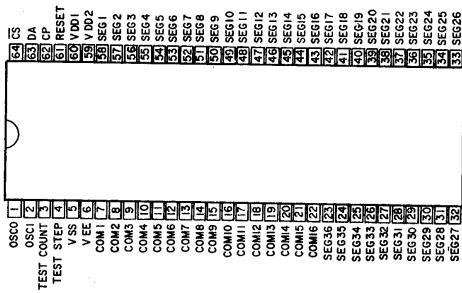

M50554-001SP (V.V.: IC004)

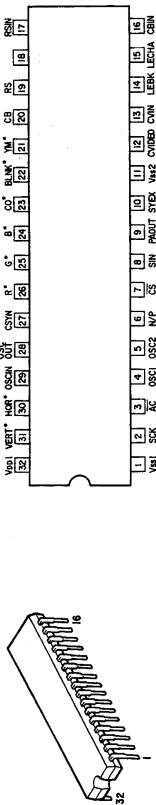

M50554-001SP Terminal Function

Pin No.	Symbol	Terminal Name	Function
1	V _{DD} 1	Ground terminal	Digital ground terminal; connect to GND.
2	SCK	Serial clock input	When "L" at CS terminal, takes in SIN serial data at rise time of SCK. Hysteresis input. Built-in Pull-up resistor.
3	AC	Auto clear input	Reset IC internal circuit at "L" mode. Built-in Pull-up resistor. Hysteresis input.
4	OSC1	Oscillator circuit external terminal	External terminal for display oscillator circuit.
5	OSC2	Oscillator circuit external terminal	Reference oscillation frequency is approx. 7MHz. Display position is horizontal of TV screen and character width are determined by this oscillation frequency.
6	N/P	NTSC/PAL switch input	Synchronous signal generator switch terminal of NTSC or PAL system. Generates synchronous signal of NTSC type at "H" mode, and synchronous signal of PAL type at "L" mode. Built-in Pull-up resistor.
7	CS	Chip select input	Chip select terminal; set to "L" mode for serial transfer. Built-in Pull-up resistor.
8	SIN	Serial data input	Serially inputs memory data and address for display control register and display data. Built-in Pull-up resistor.
9	PAOUT	Parity output	Odd number parity output; detects one-bit error in one word of SIN.
10	SYEX	Synchronous signal switch input	Switch terminal for external or internal synchronous signal. Enter external synchronous signal mode at "H" and internal synchronous signal mode at "L". SYEX comprises logic sum with EX register and address 24 in display control register and internal synchronization. Built-in Pull-up resistor.
11	V _{SS} 2	Ground terminal	Analog ground terminal; connect to GND.
12	CVIDEO	Composite Video output	Output terminal of composite video signal. Outputs 2Vp-p composite video signal. At superimpose mode, outputs output characters, etc. superimposed on CVIN signal.
13	CVIN	Composite Video input	Input terminal of composite video signal. At superimpose mode, output characters, etc. are superimposed on this composite video signal.
14	LEBK	Blanking level	Input terminal to determine blanking level of video signal.
15	LECHA	Character level input	Input terminal to determine character output level of video signal.
16	CBIN	Color burst signal input	Input CB output after converting to color burst signal level of video signal, via external circuit.
17	RSIN	Character background carrier color signal input	Input RS output after converting to carrier color signal level of video signal, via external circuit.
18	V _{DD} 2	Power supply terminal	Analog power supply terminal; connect to +5V.
19	RS	Character background carrier color signal output	Carrier color signal output for coloring character background. Outputs signal with phase angle to color burst signal CB. Amplitude 5V.
20	CB	Color burst signal output	Outputs color burst signal of 3.58MHz for NTSC system, 4.43MHz for PAL system. Amplitude 5V.
21	YH	Brightness signal output	Brightness signal output; able to select polarity at character ROM determination.
22	BLNK	Character background output	Outputs character background signal; able to select polarity at character ROM determination.
23	CO	Character output	Outputs character signal; able to select polarity at character ROM determination.
24	B	Blue color output	Blue color output; able to select polarity at character ROM determination.
25	G	Green color output	Green color output; able to select polarity at character ROM determination.
26	R	Red color output	Red color output; able to select polarity at character ROM determination.
27	CSYN	Composite synchronous signal output	Outputs composite synchronous signal of NTSC or PAL system. Negative polarity. Amplitude 5V.
28	OSCOUT	Synchronous signal generating oscillator circuit	External terminal of synchronous signal generating oscillator circuit. For NTSC system, oscillation frequency of 14.32MHz, and for PAL system, of 17.73MHz, are used.
29	OSCIN	Synchronous signal's signal	Inputs horizontal synchronous signal. Hysteresis input. Able to select polarity at character ROM determination.
30	HOR	Vertical synchronous signal's signal	Inputs vertical synchronous signal. Hysteresis input. Able to select polarity at character ROM determination.
31	VERT	Vertical synchronous signal's signal	Inputs vertical synchronous signal. Hysteresis input. Able to select polarity at character ROM determination.
32	V _{DD} 1	Power supply terminal	Digital power supply terminal; connect to +5V.

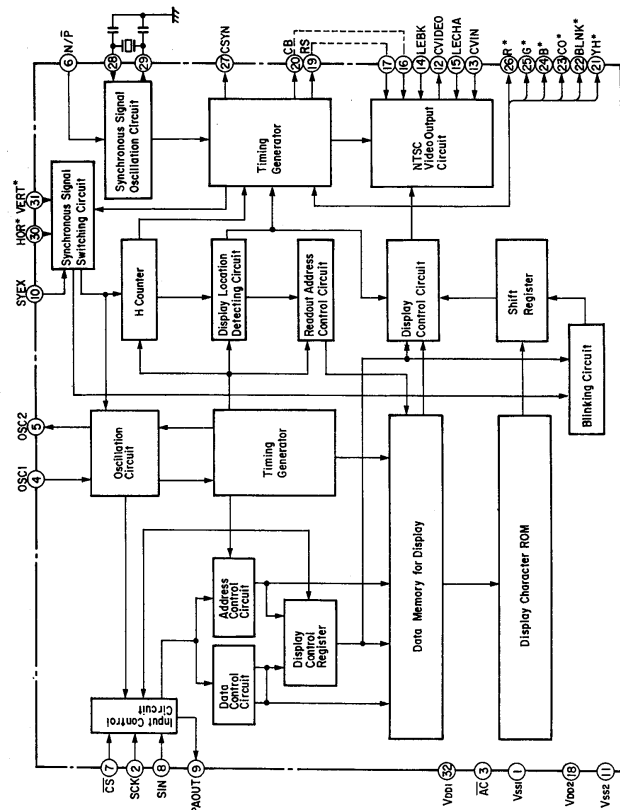

LA7820 (VV: IC006)

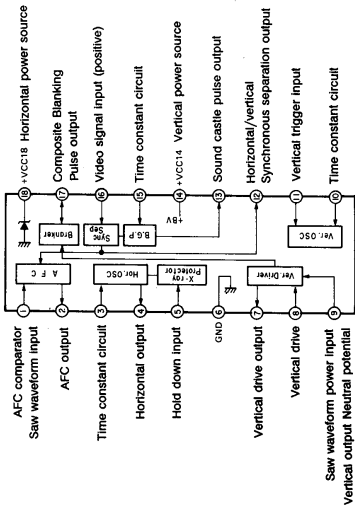
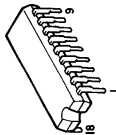

TC4051BP (VV: IC001, 002, 101, 102, 104, 105)

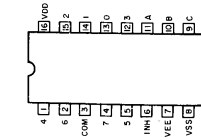
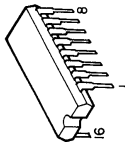

HD14066BP (VV: IC003, 103)

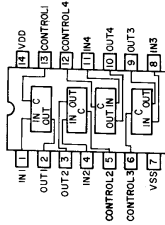
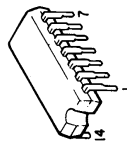

M51953B (VV: IC803)

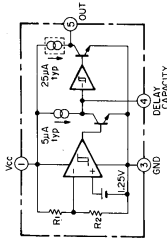
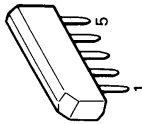

M5128AP (MA: IC351) (SU: IC351) (SU: IC452, 602, 607, 609, 611, 703, 706, 709-712, 716) (RH: IC051, 152)

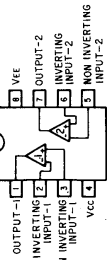

BA1639 (SU: IC714)

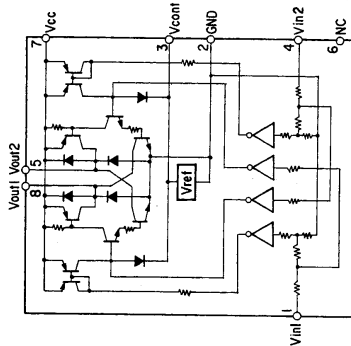
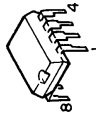

LC4966 (SU: IC604)

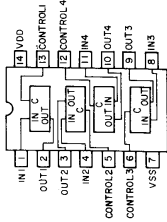
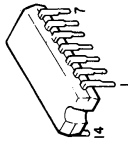

NUM456D (MA: IC231) (SU: IC231) (RH: IC151) (SU: IC451, 606, 610) (SU: IC451, 606, 610) (SU: IC451, 606, 610) (SU: IC713)

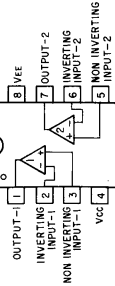

TLP521-1(BL) (MA: IC453-455)
INFRARED LED + PHOTO TRANSISTOR

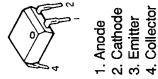

1. Anode
2. Cathode
3. Emitter
4. Collector

HM65256BLFP-10
(SU: IC705)

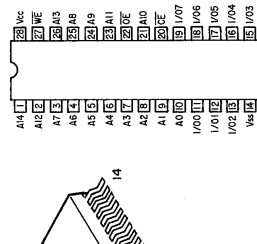
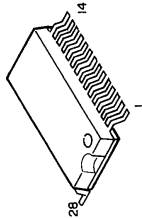

NJM7805FA(S) (SU: IC715)
NJM7806FA(S) (M: IC503, 505)
NJM7815FA(S) (M: IC501)

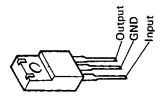

TC9176P (SU: IC707, 708)

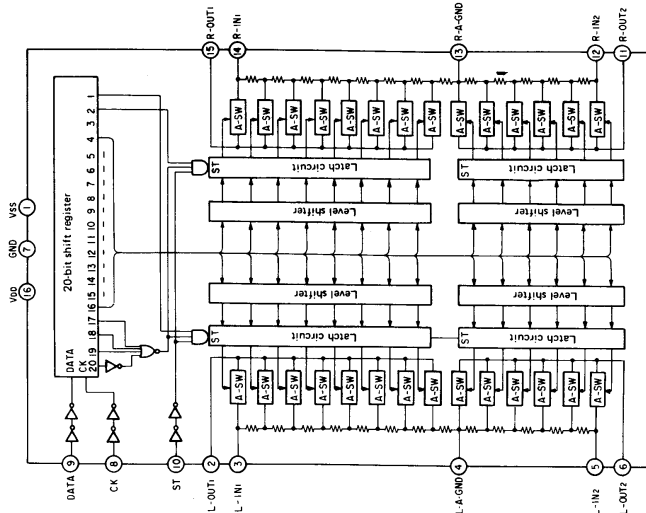
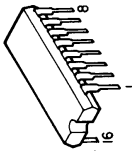

NJM7905FA (M: IC504)
NJM7915FA (M: IC502)

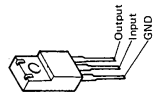

F71002B
(SU: IC704)

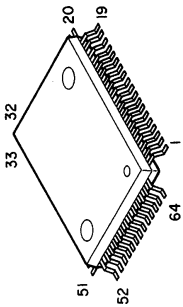
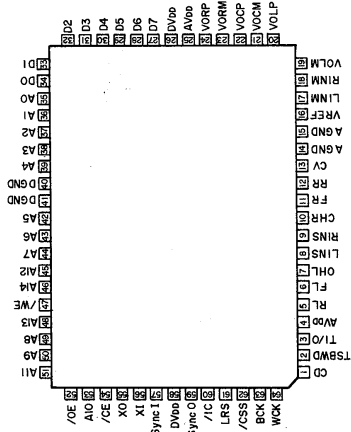

BLOCK DIAGRAM

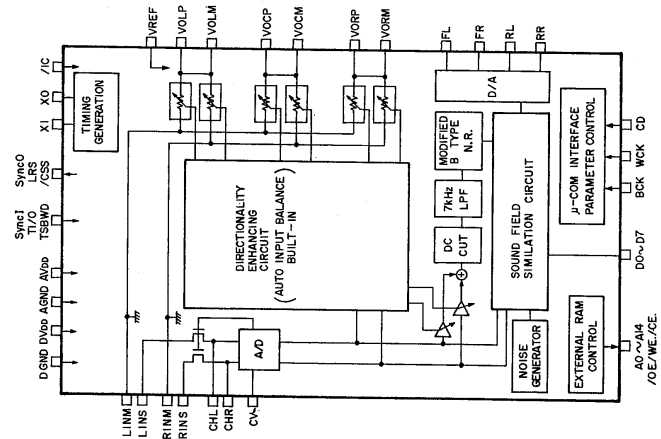

• TRANSISTORS

- 2SA970 (BL)
- 2SA988 (E/F)
- 2SC1015 (GR/V)
- 2SC1815 (V)(BL)
- 2SC1841 (E/F)
- 2SC2878 (A/E)

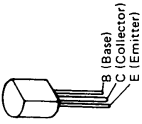

- 2SA1490 (OP/Y) (Z)
- 2SC3854 (OP/Y) (Z)

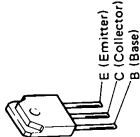

- 2SB647A (C)
- 2SD667A (C)

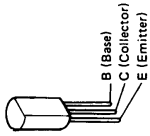

- 2SA1048 (GR)(V)(GR)
- 2SC2488 (BL)

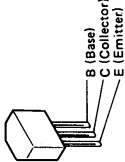

- 2SB1928 (P)
- 2SD2004 (P)

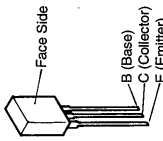

- 2SK184 (GR)(BL)

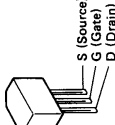

- RN1202
- RN1204
- RN2201
- RN2204



RN1202	10 kohm	R1	R2
RN1204	47 kohm	R1	R2

- RN2201
- RN2204

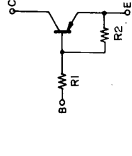

RN2201	4.7 kohm	R1	R2
RN2204	47 kohm	R1	R2

• IC PROTECTORS

- ICP-N15 (RH: IC509-511)
- ICP-N20 (RH: IC507, 508)

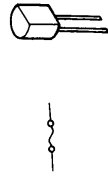

• POSISTOR

- PTH9M04BB222TS2F333 (MA: F301)



• DIODES (included LED)

- 1SS270A
- 1SZ076A

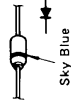

- HZ54B-1
- HZ56B-1
- HZ57C-1
- HZ57B-1
- HZ59A-1
- HZ512B-1
- HZ520-1

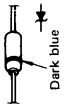

- 1SR35-200A

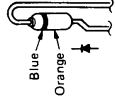

- DSM1D2 (Type-3)

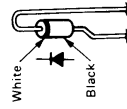

- SFOR1A42 (Thyristor)

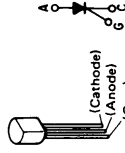

- S4VB20F

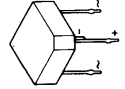

- D5FB20 (4001)

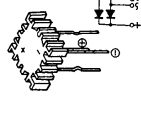

- SEL1210R (Red)

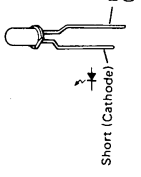

• FL DISPLAY (Part No.: 3934115000)

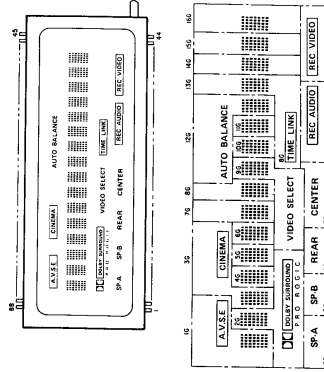

TERMINAL CONNECTION

(UPPER)		(LOWER)	
TERMINAL No.	F1, F2, F3, F4, F5, F6, F7, F8, F9, F10, F11, F12	TERMINAL No.	F1, F2, F3, F4, F5, F6, F7, F8, F9, F10, F11, F12
ELECTRODE	F1, F2, F3, F4, F5, F6, F7, F8, F9, F10, F11, F12	ELECTRODE	F1, F2, F3, F4, F5, F6, F7, F8, F9, F10, F11, F12
TERMINAL No.	F1, F2, F3, F4, F5, F6, F7, F8, F9, F10, F11, F12	TERMINAL No.	F1, F2, F3, F4, F5, F6, F7, F8, F9, F10, F11, F12
ELECTRODE	F1, F2, F3, F4, F5, F6, F7, F8, F9, F10, F11, F12	ELECTRODE	F1, F2, F3, F4, F5, F6, F7, F8, F9, F10, F11, F12

• OTHERS

- SX1610-S2 (Remote Control Receiver) (VV: IC804)

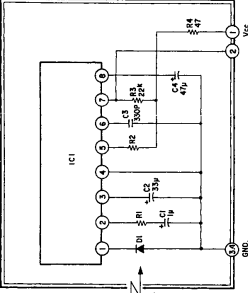
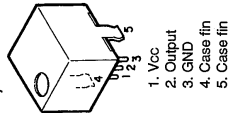

- IC1 : CX20108A chip
- D1 : Pin photodiode chip
- C1, C2, C4 : Aluminum electrolytic capacitor
- C3 : SL characteristic ±5%
- R1 : Gain control resistor
- R2 : to control resistor (using ±1%)
- R : (Other than above items) : ±5%

PRINTED WIRING BOARD (Pattern Side)

1 2 3 4 5 6 7 8

1U-2433A MAIN AMP UNIT ASSY

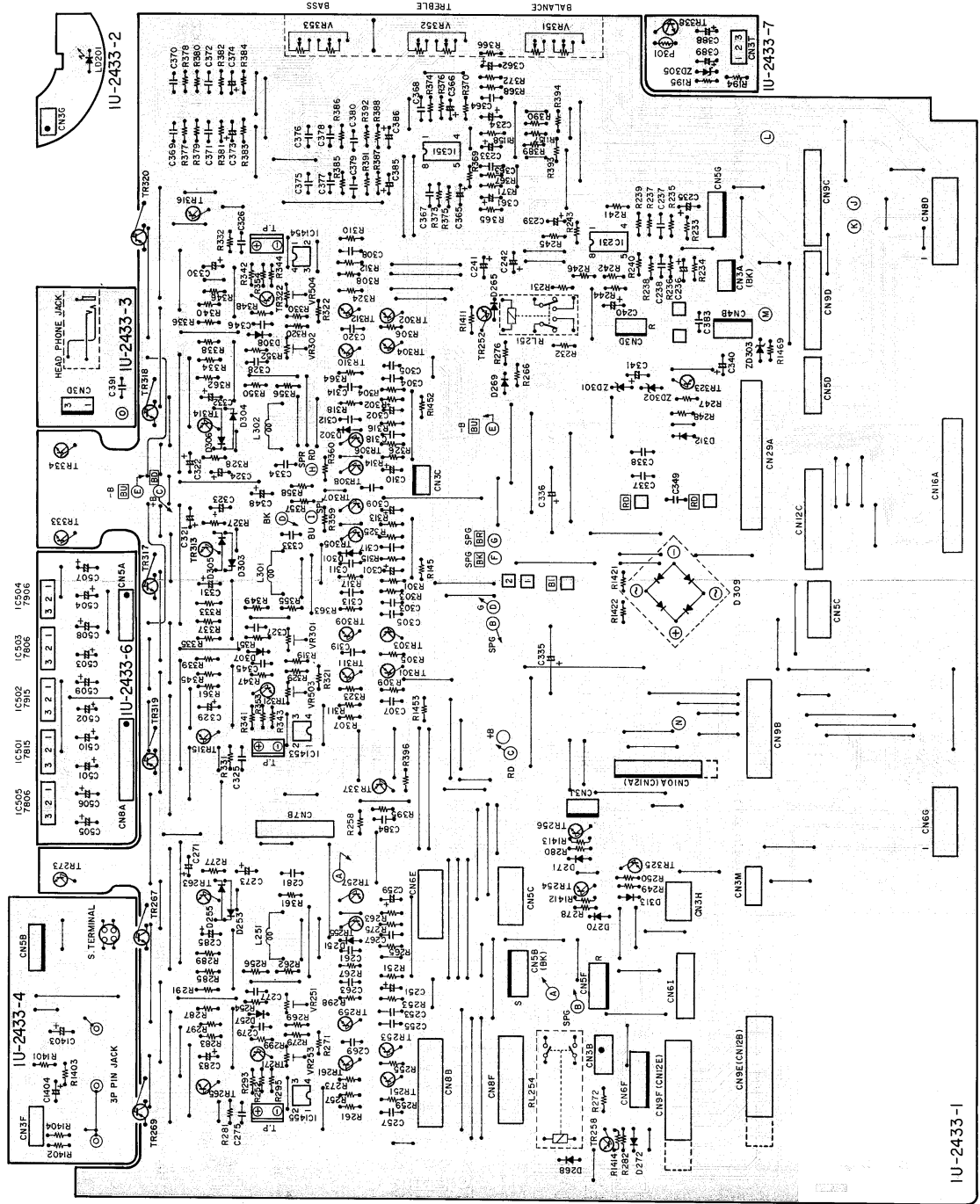

1 2 3 4 5 6 7 8

1U-2434D REAR INPUT UNIT ASSY

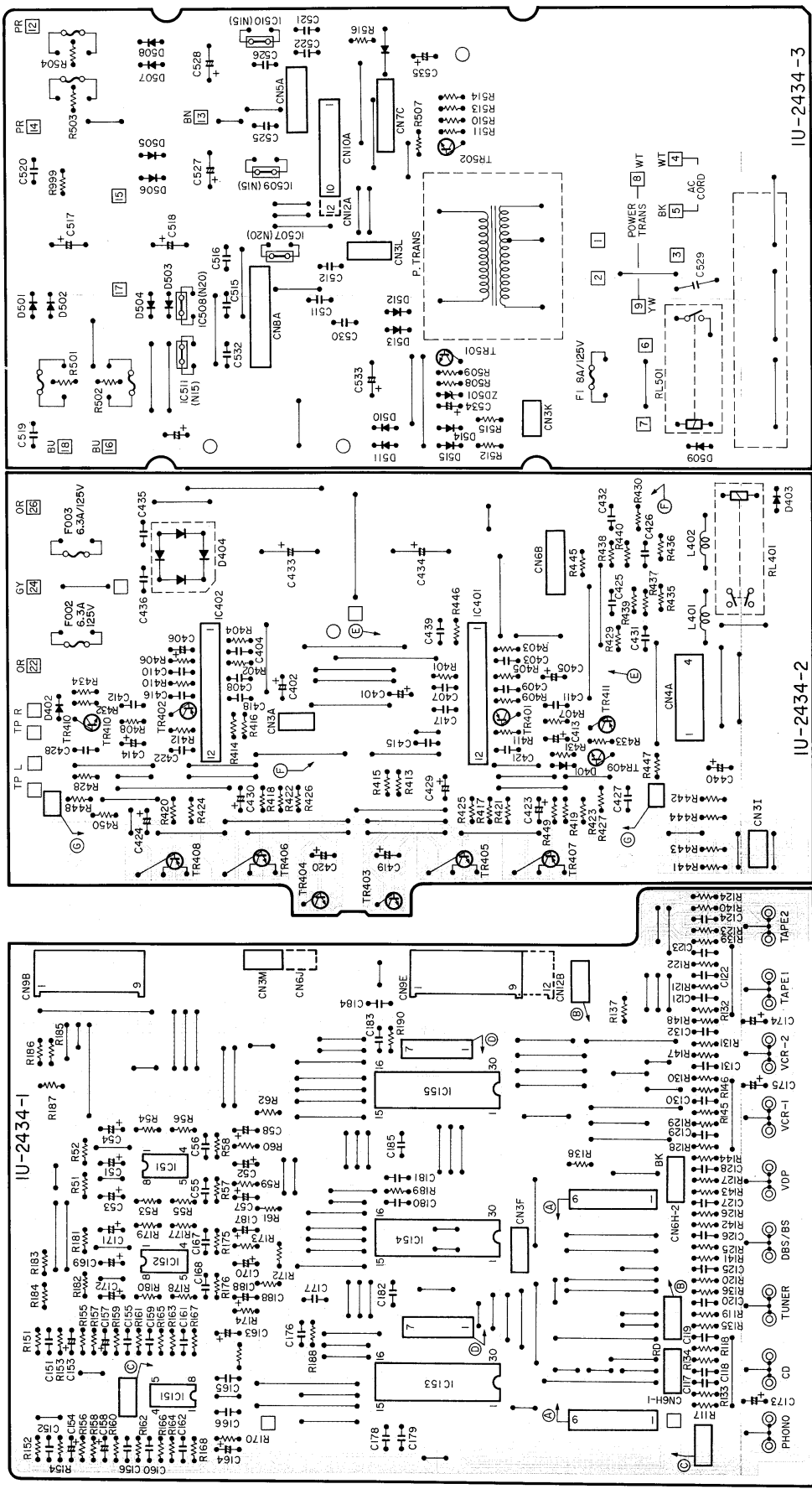

1 2 3 4 5 6 7 8

1U-2435C VED, VIDEO UNIT ASSY

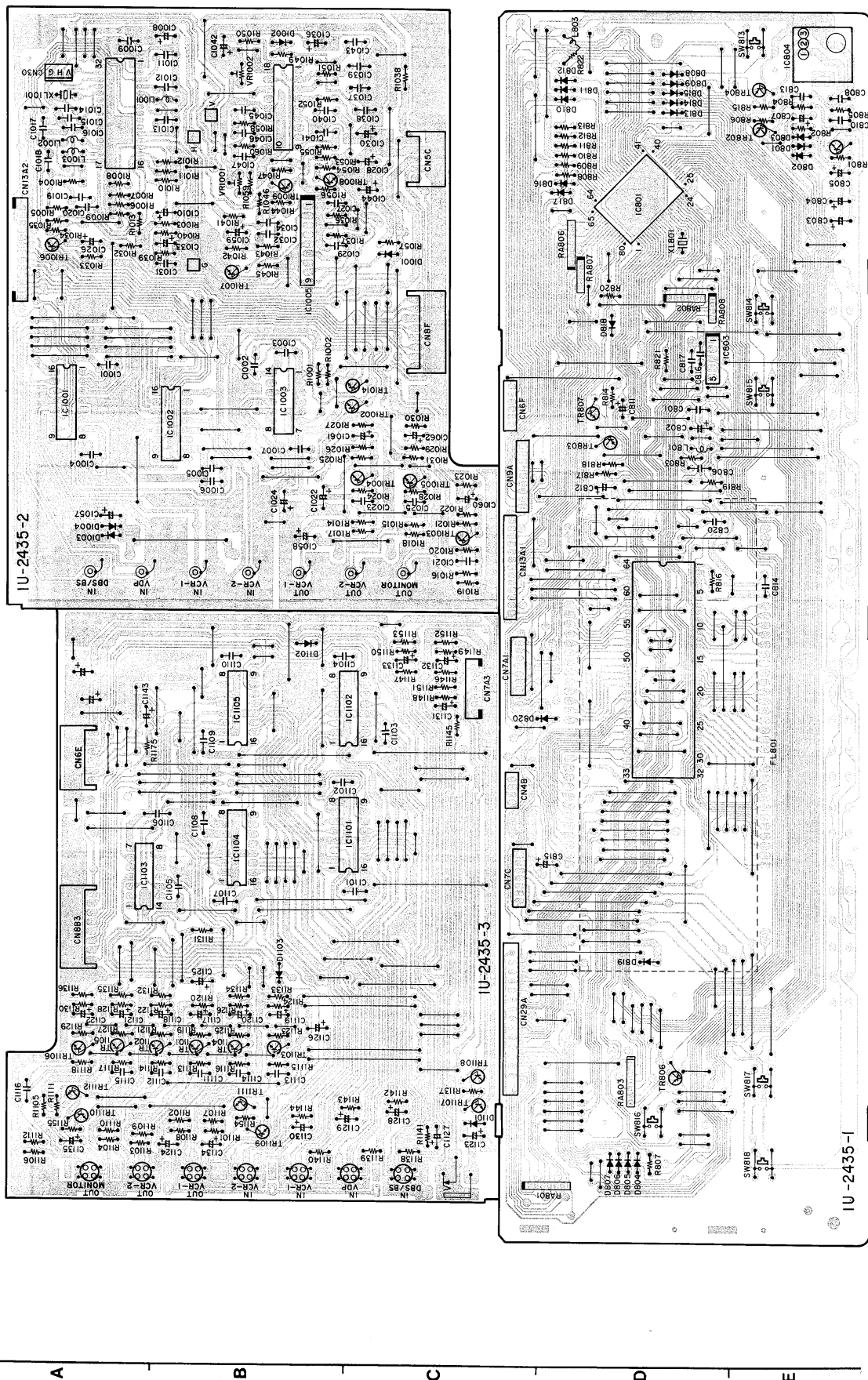

1 2 3 4 5 6 7 8

1U-2436A SURROUND UNIT ASS'Y

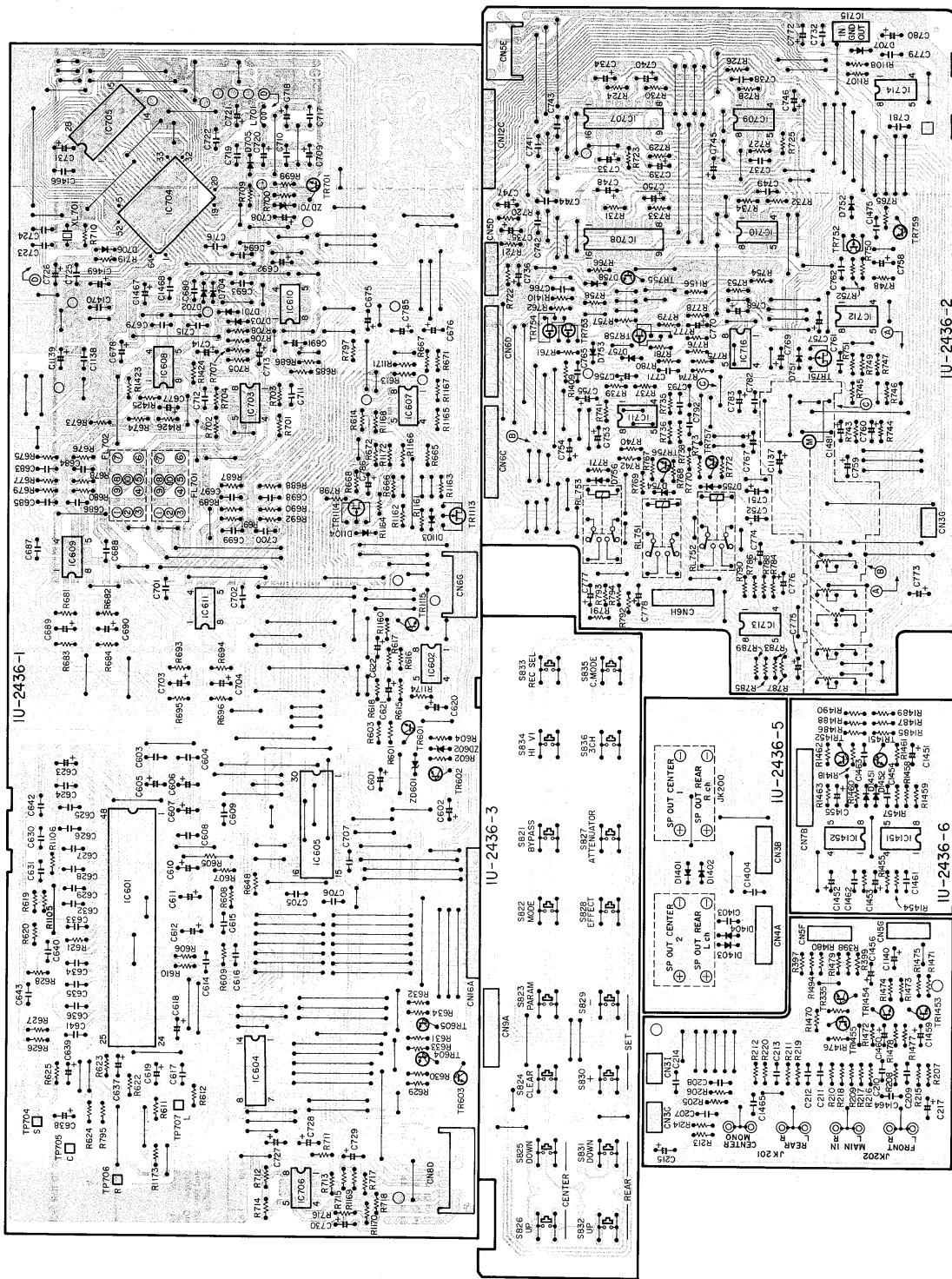

1 2 3 4

1U-2442A AUDIO, REC UNIT ASSY

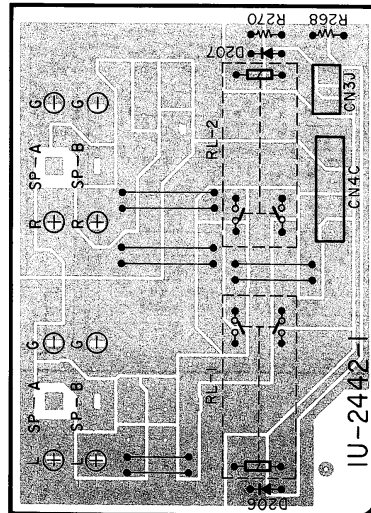
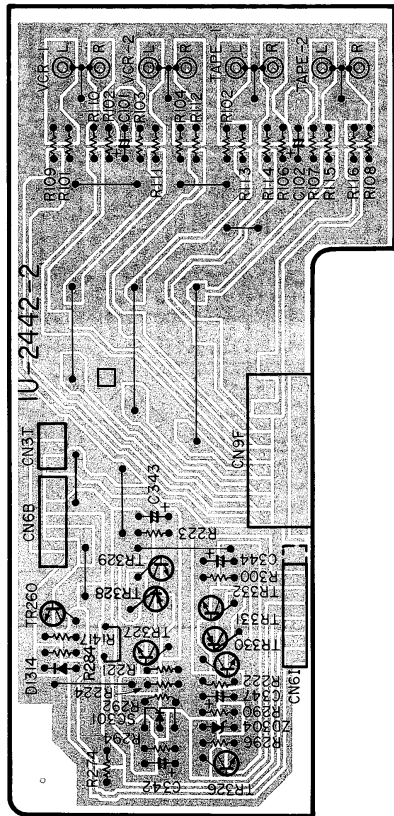

NOTE FOR PARTS LIST

- Part indicated with the mark "⊗" are not always in stock and possibly to take a long period of time for supplying, or in some case supplying of part may be refused.
- When ordering of part, clearly indicate "1" and "1" (1) to avoid mis-supplying.
- Ordering part without stating its part number can not be supplied.
- Part indicated with the mark "⊗" is not illustrated in the exploded view.
- Not including Carbon Film ±5%, 1/4W Type in the P.W.Board parts list. (Refer to the Schematic Diagram for those parts.)

WARNING:
Parts marked with this symbol have critical characteristics. Use ONLY replacement parts recommended by the manufacturer.

● Resistors

Ex.: RN 14K 2E 182 G FR
Type Shape Power Resist. Allowable Others
formance error

RD : Carbon Resistor	2B : 18W	F : ±1%	P : Pulse-resistant type
RE : Metal oxide film	2H : 12W	J : ±5%	NR : Non-burning type
RW : Wirewound	3A : 1W	K : ±10%	FR : Fuse-resistor
RK : Metal meander	3F : 3W	M : ±20%	F : Leads wire forming
	3H : 5W		

• Resistance
1 B 2 ⇒ 1800 ohm ± 1.8 kOhm
2 2 2 ⇒ 1.2 ohm
1 1 2 ⇒ 1.2 ohm
1 1 2 ⇒ 1.2 ohm effective number, decimal point indicated by R.
• Units: ohm

• Capacity (electrolyte only)
2 2 2 ⇒ 2200µF
Indicates number of zeros after effective number.
• Units: µF

• Units: µF
2 2 1 ⇒ 220PF
Indicates number of zeros after effective number.
• Units: PF

• Units: PF
2 2 1 ⇒ 220PF
Indicates number of zeros after effective number.
• Units: PF

● Capacitors

Ex.: CE 041W 2E2 M BP
Type Shape Dielectric Capacity Allowable Others
formance error

CE : Aluminum foil	DJ : 63V	F : ±1%	HS : High stability type
CA : Aluminum solid	1A : 10V	G : ±2%	BP : Non-polar type
CA : electrolytic	1C : 18V	J : ±5%	HR : Ripple-resistant type
CS : Aluminum electrolytic	1E : 25V	K : ±10%	DL : For charge and discharge
CO : Film	1V : 35V	M : ±20%	HF : Frequency
CC : Ceramic	1H : 50V	Z : ±80%	U : UJ part
CM : mica	1K : 100V		U : UJ part
CP : Metallized	2C : 180V	P : ±100%	W : UL-CSA type
CH : Metallized	2E : 250V	D : ±50PF	F : Lead wire forming
	2H : 350V		
	2J : 500V		

• Capacity (except electrolyte)
2 2 2 ⇒ 2200µF = 0.002µF
Indicates number of zeros after effective number.
• Units: µF
2 2 1 ⇒ 220PF
Indicates number of zeros after effective number.

• Units: µF
2 2 1 ⇒ 220PF
Indicates number of zeros after effective number.
• Units: PF
2 2 1 ⇒ 220PF
Indicates number of zeros after effective number.

• Units: PF
2 2 1 ⇒ 220PF
Indicates number of zeros after effective number.
• Units: PF

PARTS LIST OF P.W. BOARD
1U-2433A MAIN AMP UNIT

Ref. No.	Part No.	Part Name	Remarks	Ref. No.	Part No.	Part Name	Remarks
SEMICONDUCTORS GROUP				RESISTORS GROUP			
				(Not included Carbon Film $\pm 5\%$, 1/4W Type. Refer to the Schematic Diagram for those Parts.)			
IC231	263 0198 005	IC NJM4556D		△ R195	241 2381 904	Carbon Film 3.3kohm, 1/4W (N.B)	RD14B2E332JNBS
IC351	273 0711 000	IC M5218AP		△ R243,244	244 2051 961	Metal Oxide 100ohm, 1W (N.B)	RS14B3A101JNBS(S)
IC453-455	262 0874 009	IC TLP521-1(BL)		△ R247	241 2376 964	Carbon Film 47ohm, 1/4W (N.B)	RD14B2E470JNBS
IC501	263 0812 006	IC NJM7815FA(S)	Regulator	△ R256	244 2051 987	Metal Oxide 4.7ohm, 1W (N.B)	RS14B3A4R7JNBS(S)
IC502	263 0561 001	IC NJM7915FA	Regulator	△ R257	241 2380 963	Carbon Film 2.2Kohm, 1/4W (N.B)	RD14B2E222JNBS
IC503	263 0793 002	IC NJM7806FA(S)	Regulator	△ R258	244 2043 937	Metal Oxide 10ohm, 1W (N.B)	RS14B3A100JNBS(S)
IC504	263 0683 002	IC NJM7906FA	Regulator	△ R261	241 2380 963	Carbon Film 2.2Kohm, 1/4W (N.B)	RD14B2E222JNBS
IC505	263 0793 002	IC NJM7806FA(S)	Regulator	△ R266	241 2380 950	Carbon Film 2Kohm, 1/4W (N.B)	RD14B2E202JNBS
TR251	271 0094 919	Transistor 2SA970(BL)		△ R267	241 2377 976	Carbon Film 130ohm, 1/4W (N.B)	RD14B2E131JNBS
TR252	273 0317 906	Transistor 2SC2458(BL)		△ R272	244 2052 973	Metal Oxide 560ohm, 1W (N.B)	RS14B3A561JNBS(S)
TR253	271 0094 919	Transistor 2SA970(BL)		△ R273	241 2315 967	Fusible 68ohm, 1/4W	RD14B2E680GFRS
TR254	273 0317 906	Transistor 2SC2458(BL)		△ R283	241 2378 920	Carbon Film 220ohm, 1/4W (N.B)	RD14B2E221JNBS
TR255	273 0235 923	Transistor 2SC1841(E/F)		△ R285	244 2043 982	Metal Oxide 0.22ohm, 1W (N.B)	RS14B3AR22JNBS(S)
TR256	273 0317 906	Transistor 2SC2458(BL)		△ R287	244 2043 982	Metal Oxide 0.22ohm, 1W (N.B)	RS14B3AR22JNBS(S)
TR257	271 0131 924	Transistor 2SA988(E/F)		△ R289	244 2043 982	Metal Oxide 0.22ohm, 1W (N.B)	RS14B3AR22JNBS(S)
TR258	273 0317 906	Transistor 2SC2458(BL)		△ R291	244 2043 982	Metal Oxide 0.22ohm, 1W (N.B)	RS14B3AR22JNBS(S)
TR259	273 0235 923	Transistor 2SC1841(E/F)		△ R297	241 2380 950	Carbon Film 2Kohm, 1/4W (N.B)	RD14B2E202JNBS
TR261	273 0235 923	Transistor 2SC1841(E/F)		△ R298	241 2377 976	Carbon Film 130ohm, 1/4W (N.B)	RD14B2E131JNBS
TR263	274 0151 000	Transistor 2SD2004(P)		△ R299	241 2380 950	Carbon Film 2Kohm, 1/4W (N.B)	RD14B2E202JNBS
TR265	272 0107 906	Transistor 2SB1328(P)		△ R307,308	241 2380 963	Carbon Film 2.2Kohm, 1/4W (N.B)	RD14B2E222JNBS
TR271	273 0235 923	Transistor 2SC1841(E/F)		△ R311,312	241 2380 963	Carbon Film 2.2Kohm, 1/4W (N.B)	RD14B2E222JNBS
TR273	273 0198 905	Transistor 2SC1815(Y)		△ 317,318	241 2377 976	Carbon Film 130ohm, 1/4W (N.B)	RD14B2E131JNBS
TR301-304	271 0094 919	Transistor 2SA970(BL)		△ R323,324	241 2315 967	Fusible 68ohm, 1/4W	RD14B2E680GFRS
TR305,306	273 0235 923	Transistor 2SC1841(E/F)		△ R333-340	244 2043 982	Metal Oxide 0.22ohm, 1W (N.B)	RS14B3AR22JNBS(S)
TR307,308	271 0131 924	Transistor 2SA988(E/F)		△ R345-348	241 2380 950	Carbon Film 2kohm, 1/4W (N.B)	RD14B2E202JNBS
TR309-312	273 0235 923	Transistor 2SC1841(E/F)		△ R349,350	244 2051 987	Metal Oxide 4.7ohm, 1W (N.B)	RS14B3A4R7JNBS(S)
TR313,314	274 0151 000	Transistor 2SD2004(P)		△ R357,358	244 2043 937	Metal Oxide 10ohm, 1W	RS14B3A100JNBS(S)
TR315,316	272 0107 906	Transistor 2SB1328(P)		△ R361,362	241 2378 920	Carbon Film 220ohm, 1/4W (N.B)	RD14B2E221JNBS
TR321,322	273 0235 923	Transistor 2SC1841(E/F)		△ R363,364	241 2377 976	Carbon Film 130ohm, 1/4W (N.B)	RD14B2E131JNBS
TR323	272 0053 908	Transistor 2SB647A(C)		VR251	211 6044 048	Semi Fixed Resistor 5Kohm	V06PB502
TR325	271 0102 937	Transistor 2SA1015(GR/Y)		VR253	211 6044 019	Semi Fixed Resistor 47Kohm	V06PB473
TR333,334	273 0198 905	Transistor 2SC1815(Y)		VR301,302	211 6044 048	Semi Fixed Resistor 5Kohm	V06PB502
TR337	271 0131 924	Transistor 2SA988(E/F)		VR351	211 0760 005	Variable Resistor	V1603V25F---K
TR338	273 0198 918	Transistor 2SC1815(BL)		VR356	211 0760 005	Variable Resistor	V1603V25F---K
D251	276 0432 903	Diode 1SS270A		VR503,504	211 6064 019	Semi Fixed Resistor 47Kohm	V06PB473
D253	276 0049 011	Diode 1S2076A		CAPACITORS GROUP			
D255	276 0049 011	Diode 1S2076A		C233,234	254 4260 045	Electrolytic 1 μ F/50V	CE04W1H010M
D257	276 0432 903	Diode 1SS270A		C235,236	254 4254 006	Electrolytic 10 μ F/16V	CE04W1C100M
D265	276 0432 903	Diode 1SS270A		C237,238	253 1179 000	Ceramic 100PF/50V	CK45B1H101K
D268-272	276 0432 903	Diode 1SS270A		C239,240	254 4254 006	Electrolytic 10 μ F/16V	CE04W1C100M
D301,302	276 0432 903	Diode 1SS270A		C241,242	254 4260 045	Electrolytic 1 μ F/50V	CE04W1H010M
D303-306	276 0049 011	Diode 1S2076A		C251	254 4254 006	Electrolytic 10 μ F/16V	CE04W1C100M
D307,308	276 0432 903	Diode 1SS270A		C253	253 1179 000	Ceramic 100PF/50V	CK45B1H101K
△ D309	276 0356 005	Diode D5FB20(4001)	Bridge	C255	253 1179 042	Ceramic 220PF/50V	CK45B1H221K
D312	276 0548 910	Diode DSM1D2 (Type 3)		C257	255 1264 908	Plastic Film 0.001 μ F/50V	CQ93M1H102J(B)
D313	276 0432 903	Diode 1SS270A					
ZD301,302	276 0479 908	Zener Diode HZS20-1	20V				
ZD303	276 0467 907	Zener Diode HZS9A-1	9V				
ZD305	276 0474 903	Zener Diode HZS12B-1	12V				
LD201	393 9434 906	LED SEL1210S	Red				
P301	279 0034 067	Thermistor PTH9M04BB 222 TS2F333	Posistor				

Ref. No.	Part No.	Part Name	Remarks	Ref. No.	Part No.	Part Name	Remarks	Q'ty	
C259	254 4256 046	Electrolytic 100μF/25V	CE04W1E101M	CN3F,T	205 0233 032	3P EH Connector Base		1	
C261	255 1265 936	Plastic Film 0.01μF/50V	CQ93M1H103J(B)	CN3A,C, D,D,J	205 0343 032	3P Connector Base (KR-PH)		5	
C263	255 1120 042	Plastic Film 0.0022μF/50V	CQ93M1H222J	CN4B	205 0343 045	4P Connector Base (KR-PH)		1	
C267	253 4536 006	Ceramic 10PF/50V	CC45SL1H100D	CN5B,B,F,G	205 0343 058	5P Conn. Base (KR-PH)		4	
C269	253 4482 008	Ceramic 33PF/500V	CC45SL2H330J	CN6F	205 0343 061	6P Conn. Base (KR-PH)		1	
C271	254 4260 045	Electrolytic 1μF/50V	CE04W1H010M	CN10A	205 0375 000	10P Conn. Base (KR-PH)		1	
C273	254 4260 087	Electrolytic 10μF/50V	CE04W1H100M	CN3M	205 0666 036	3P Conn. Base (9130)		1	
C275	253 1128 006	Ceramic 220PF/500V	CK45B2H221K	CN5D	205 0666 052	5P Conn. Base (9130)		1	
C277	256 1034 076	Metalized 0.1μF/50V	CF93A1H104J	CN6I	205 0666 065	6P Conn. Base (9130)		1	
C279	255 1265 936	Plastic Film 0.01μF/50V	CQ93M1H103J(B)	CN7B	205 0666 078	7P Conn. Base (9130)		1	
C281	256 1042 974	Metalized 0.022μF/250V	CF93A2E223K	CN5C,E	205 0696 051	JL Connector (BT-E)		2	
C283	254 4262 014	Electrolytic 10μF/63V	CE04W1J100M	CN6E,G	205 0696 064	JL Connector (BT-E)	6P	2	
C285	254 4262 014	Electrolytic 10μF/63V	CE04W1J100M	CN8B,D,F	205 0696 080	JL Connector (BT-E)	8P	3	
C301,302	254 4260 087	Electrolytic 10μF/50V	CE04W1H100M	CN9B,9E, 9F	205 0696 093	JL Connector (BT-E)	9P	3	
C303,304	253 1179 000	Ceramic 100PF/50V	CK45B1H101K	CN3B	205 0185 025	2P Wire Holder		1	
C305,306	253 1179 042	Ceramic 220PF/50V	CK45B1H221K	CN9C,D	205 0666 094	9P Connector Base (9130)		2	
C307,308	255 1264 966	Plastic Film 0.0033μF/50V	CQ93M1H332J(B)	CN12C	205 0535 028	12P Connector Base (9130)		1	
C309,310	254 4256 046	Electrolytic 100μF/25V	CE04W1E101M	CN16A	205 0772 001	16P Connector Base (9110B)		1	
C311,312	255 1265 936	Plastic Film 0.01μF/50V	CQ93M1H103J(B)	CN29A	205 0736 034	29P FFC Connector (9603)		1	
C313,314	255 1120 042	Plastic Film 0.0022μF/50V	CQ93M1H222J	CN3B	203 4868 009	3P VH Conn. Cord		1	
C317,318	253 4536 006	Ceramic 10PF/50V	CC45SL1H100D	CN3G	203 4869 008	3P PH-SAN Conn. Cord		1	
C319,320	253 4269 001	Ceramic 10PF/500V	CC45SL2H100D	CN5A	203 8346 006	5P EH-SCN Conn. Cord		1	
C321,322	254 4260 045	Electrolytic 1μF/50V	CE04W1H010M	CN8A	204 2451 026	8P EH-SCN Conn. Cord		1	
C323,324	254 4261 028	Electrolytic 100μF/50V	CE04W1H101M	B-B	203 0525 029	1P SIN Cord Ass'y		1	
C325,326	253 1054 057	Ceramic 100PF/500V	CK45B2H101K	A-A	203 0525 032	1P SIN Cord Ass'y		1	
C327,328	256 1034 076	Metalized 0.1μF/50V	CF93A1H104J		203 0524 004	1P SIN Cord Ass'y		2	
C329-332	254 4262 014	Electrolytic 10μF/63V	CE04W1J100M		203 0524 017	1P SIN Cord Ass'y		1	
C333,334	256 1042 974	Metalized 0.022μF/250V	CF93A2E223K	CN4C	203 6391 008	4P VH Conn. Cord		1	
C335,336	254 6170 007	Electrolytic 15000μF/63V	CE04W1J153M(DL)		203 0426 005	1P Conn. Cord Ass'y		1	
C337,338	253 1151 905	Ceramic 4700PF/500V	CK45E2H472P		001 0112 043	Vinyl Wire		1	
C340,341	254 4260 045	Electrolytic 1μF/50V	CE04W1H010M		205 0452 004	Style Pin		1	
C345,346	255 1265 936	Plastic Film 0.01μF/50V	CQ93M1H103J(B)		125 9002 078	UL Tube (L=30)	for P301	2	
C348	254 4263 042	Electrolytic 1μF/100V	CE04W2A010M						
C349	256 1042 903	Metalized 0.1μF/250V	CF93A2E104K						
C361,362	254 4254 022	Electrolytic 33μF/16V	CE04W1C330M						
C363,364	253 1179 000	Ceramic 100PF/50V	CK45B1H101K						
C365,366	254 4258 002	Electrolytic 4.7μF/35V	CE04W1V4R7M						
C367,368	253 1179 000	Ceramic 100PF/50V	CK45B1H101K						
C369,370	255 1264 908	Plastic Film 0.001μF/50V	CQ93M1H102J(B)						
C371,372	256 1034 092	Metalized 0.15μF/50V	CF93A1H154J						
C373,374	254 4260 045	Electrolytic 1μF/50V	CE04W1H010M						
C375,376	255 1120 039	Plastic Film 0.0018μF/50V	CQ93M1H182J						
C377,378	255 1121 038	Plastic Film 0.012μF/50V	CQ93M1H123J						
C379,380	256 1034 050	Metalized 0.068μF/50V	CF93A1H683J						
C383	256 1034 076	Metalized 0.1μF/50V	CF93A1H104J						
C384	255 1265 936	Plastic Film 0.01μF/50V	CQ93M1H103J(B)						
C385,386	254 4260 032	Electrolytic 0.47μF/50V	CE04W1HR47M						
C388,389	254 4254 035	Electrolytic 47μF/16V	CE04W1C470M						
C391	253 9031 027	BC Ceramic 0.1μF/25V	CK45=1E104K						
C403,404	254 4260 045	Electrolytic 1μF/50V	CE04W1H010M						
C501,502	254 4256 033	Electrolytic 47μF/25V	CE04W1E470M						
C503-510	254 4260 087	Electrolytic 10μF/50V	CE04W1H100M						
OTHER GROUP				Q'ty					
	—	(P.W. Board)		(1)					
L251	235 0068 004	Inductor 1mH		1					
L301,302	235 0068 004	Inductor 1mH		2					
RL251	214 0127 003	Relay (RY-12W)		1					
RL254	214 0129 001	Relay (DH2TU)		1					
	204 8341 017	Head Phone Jack		1					
	204 8342 003	3P Pin Jack (C-GND)	(Gold Flash)	1					
	205 0605 000	S-Terminal	(Gold Flash)	1					
	205 0190 036	3P NH Connector Base	TP	3					

1U-2434D REAR, INPUT UNIT

Ref. No.	Part No.	Part Name	Remarks	Ref. No.	Part No.	Part Name	Remarks
SEMICONDUCTORS GROUP							
IC051	263 0711 000	IC M5218AP		C167,168	253 1179 042	Ceramic 220PF/50V	CK45B1H221K
IC151	265 0030 004	IC NJM4558DD		C169,170	254 4260 045	Electrotyc 1μF/50V	CE04W1H010M
IC152	263 0711 000	IC M5218AP		C173-175	254 4260 045	Electrotyc 1μF/50V	CE04W1H010M
IC153	262 1227 008	IC LC7821		C176,177	253 1181 014	Ceramic 0.022μF/50V	CK45F1H223Z
IC154	262 1228 007	IC LC7822		C178	253 1006 005	Ceramic 220PF/50V	CK45B1H222K
IC155	262 1227 008	IC LC7821		C179-185	253 1181 014	Ceramic 0.022μF/50V	CK45F1H223Z
IC401,402	263 0206 007	IC μPC1225H		C187,188	254 4260 058	Electrotyc 2.2μF/50V	CE04W1H2R2M
IC507,508	268 0074 904	IC ICP-N20	IC Protector	C401,402	254 4260 045	Electrotyc 1μF/50V	CE04W1H010M
IC509-511	268 0073 905	IC ICP-N15	IC Protector	C403,404	253 1179 042	Ceramic 220PF/50V	CK45B1H221K
				C405,406	254 4256 059	Electrotyc 220μF/25V	CE04W1E221M
				C407,408	253 1179 000	Ceramic 100PF/50V	CK45B1H101K
TR401,402	271 0102 937	Transistor 2SA1015 (GR/Y)		C413,414	254 4261 028	Electrotyc 100μF/50V	CE04W1H101M
TR403,404	273 0198 918	Transistor 2SC1815 (BL)		C415,416	253 1179 026	Ceramic 150PF/50V	CK45B1H151K
TR409,410	273 0235 923	Transistor 2SC1841 (E/F)		C417,418	253 4537 063	Ceramic 47PF/50V	CC45L1H470J
TR411	271 0191 906	Transistor 2SA1048 (GR)		C419,420	254 4260 045	Electrolytic 1μF/50V	CE04W1H010M
TR501-503	273 0317 906	Transistor 2SC2458 (BL)		C421,422	255 1121 083	Plastic Film 0.033μF/50V	CQ93M1H333J
				C423,424	254 4260 087	Electrolytic 10μF/50V	CE04W1H100M
				C425,426	256 1034 076	Metalized 0.1μF/50V	CF93A1H104J
D401-403	276 0432 903	Diode 1SS270A		C427,428	255 1121 025	Plastic Film 0.01μF/50V	CQ93M1H103J
▲ D404	276 0338 007	Diode S4VB20F	Bridge	C429,430	254 4260 087	Electrolytic 10μF/50V	CE04W1H100M
D501-508	276 0548 910	Diode DSM1D2 (Type 3)		C431,432	256 1042 974	Metalized 0.022μF/250V	CF93A2E223K
D509	276 0432 903	Diode 1SS270A		C433,434	254 4355 002	Electrolytic 6800μF/50V	CE04W1H682MDL
D510-515	276 0553 905	Diode 1SR35-200A		C435,436	253 1151 905	Ceramic 4700PF/500V	CK45B2H472P
D517	276 0049 011	Diode 1S2076A		C439	255 1121 025	Plastic Film 0.01μF/50V	CQ93M1H103J
ZD501	276 0456 905	Zener Diode HZS4B-1	4V	C511,512	253 1181 001	Ceramic 0.01μF/50V	CK45F1H103Z
RESISTORS GROUP							
(Not included Carbon Film ±5%, 1/4W Type. Refer to the Schematic Diagram for those Parts.)							
▲ R411,412	241 2379 903	Carbon Film 470ohm, 1/4W (N.B)	RD14B2E471JNBS	▲ C529	253 8014 702	Ceramic 0.01μF/400V(AC)	CK45F2GAC103MC
▲ R417-424	244 2055 912	Metal Oxide 0.47ohm, 1W (N.B)	RS14B3AR47JNBS(S)	C530	253 1181 001	Ceramic 0.01μF/50V	CK45F1H103Z
▲ R425,426	241 2380 950	Carbon Film 2Kohm, 1/4W (N.B)	RD14B2E202JNBS	C532	253 1181 001	Ceramic 0.01μF/50V	CK45F1H103Z
▲ R427,428	241 2380 921	Carbon Film 1.5Kohm, 1/4W (N.B)	RD14B2E152JNBS	C533	254 4256 790	Electrolytic 2200μF/25V	CE04W1E222MC
▲ R429,430	244 2050 904	Metal Oxide 22ohm, 1W (N.B)	RS14B3A220JNBS(S)	C534	254 4260 032	Electrolytic 0.47μF/50V	CE04W1HR47M
▲ R437,438	244 2043 937	Metal Oxide 10ohm, 1W (N.B)	RS14B3A100JNBS(S)	C535	259 0007 702	Back Up Cap 8200μF/5.5V	SB CAP==822=C
▲ R501,502	244 2043 982	Metal Oxide 0.22ohm, 1W (N.B)	RS14B3AR22JNBS(S)	OTHER GROUP			
▲ R503,504	241 2387 908	Carbon Film 1ohm, 1/4W (N.B)	RD14B2E010JNBS	L401,402	235 0068 004	(P.W.Board) Inductor 1mH	(1)
▲ R512	241 2375 978	Carbon Film 20ohm, 1/4W (N.B)	RD14B2E200JNBS	RL401	214 0129 001	Relay (DH2TU)	2
▲ R515	241 2375 978	Carbon Film 200ohm, 1/4W (N.B)	RD14B2E200JNBS	▲ RL501	214 0120 000	Relay (TV-8)	1
▲ R516	241 2387 940	Carbon Film 4.7ohm, 1/4W (N.B)	RD14B2E4R7JNBS		204 8378 006	6P Pin Jack (S-GND)	3
CAPACITORS GROUP				▲ F001	206 1046 014	Fuse 8A	1
C051,052	254 4260 045	Electrotyc 1μF/50V	CE04W1H010M	▲ F002,003	206 1046 001	Fuse 6.3AUL	20m
C053,054	254 4254 006	Electrotyc 10μF/16V	CE04W1C100M		202 0022 008	Fuse Holder	6
C055,056	253 1179 042	Ceramic 220PF/50V	CK45B1H221K	▲	203 3946 003	AC Outlet (Polarized)	1
C057,058	254 4260 058	Electrotyc 2.2μF/50V	CE04W1H2R2M	▲	233 5818 004	Power Trans (Mini)	1
C151,152	253 1179 042	Ceramic 220PF/50V	CK45B1H221K		513 1451 044	Fuse Label	1
C153,154	254 4254 006	Electrotyc 10μF/16V	CE04W1C100M	CN6H-1	205 0277 030	3P EH Conn. Base (RD)	1
C155,156	253 1179 084	Ceramic 470PF/50V	CK45B1H471K	CN6-2	205 0278 039	3P EH Conn. Base (BK)	1
C157,158	254 4250 039	Electrotyc 220μF/6.3V	CE04WQJ221M	CN3F	205 0233 032	3P EH Conn. Base (BK)	1
C159,160	255 4199 999	Plastic Film 0.024μF/50V (MRZ)	CQ92M1H243J	CN5A	205 0233 058	5P EH Conn. Base (BK)	1
				CN8A	205 0233 087	8P EH Conn. Base (BK)	1
C161,162	255 1121 009	Plastic Film 0.0068μF/50V	CQ93M1H682J	CN3A,I	205 0343 032	3P EH Conn. Base (KR-PH)	2
C163,164	254 4260 058	Electrotyc 2.2μF/50V	CE04W1H2R2M	CN6B	205 0343 061	6P EH Conn. Base (KR-PH)	1
C165,166	253 1181 014	Ceramic 0.022μF/50V	CK45F1H223Z	CN7C	205 0343 074	7P EH Conn. Base (KR-PH)	1
				CN10A	205 0375 000	10P EH Conn. Base (KR-PH)	1
				CN9E	205 0697 092	JL Connector (F-E)	9P
				CN3M	205 0731 039	3P Connector Base-L (9131)	1
				CN9B	205 0748 093	9P JL Connecor (R)	1
				CN4A	203 6384 002	4P VH-SDN Conn. Cord	1

1U-2435C VFD, VIDEO UNIT

Ref. No.	Part No.	Part Name	Remarks	Q'ty	Ref. No.	Part No.	Part Name	Remarks
D-D	204 2540 005	7P SAN-SAN Conn. Cord		1	SEMICONDUCTORS GROUP			
A-A	204 2542 003	9P SAN-SAN Conn. Cord		1	IC001,002	262 1108 004	IC TC4051BP	
C-C	203 4870 000	3P SCN-SCN Conn. Cord		1	IC003	262 0276 005	IC D14066BP	
E-E	203 0525 003	1P SIN Cord Ass'y		1	IC004	262 1403 000	IC M50554-001SP	
F-F	203 0525 016	1P SIN Cord Ass'y		1	IC005	263 0603 008	IC NJM2220S	
	203 2318 001	2P SAN-SAN Cord	l=180	1	IC006	263 0619 005	IC LA7820	
	513 1674 009	Fuse label		1	IC101,102	262 1108 004	IC TC4051BP	
	513 1715 007	Fuse label		1	IC103	262 0276 005	IC HD14066BP	
	513 2011 072	Fuse label		1	IC104,105	262 1108 004	IC TC4051BP	
					IC801	262 1722 008	IC TMP87CM70AF-6040	μ-Com
					IC802	262 1418 105	IC MSC7128-03SS-D	
					IC803	263 0423 000	IC M51953B	
					IC804	499 0150 008	IC SBX1610-52	Remocon Receiver
					TR002	269 0029 907	Transistor RN1204 (47K-47K)	Built in Resistor
					TR003-006	273 0198 918	Transistor 2SC1815 (BL)	
					TR007	271 0194 903	Transistor 2SA1048 (/GR)	
					TR008,009	273 0317 906	Transistor 2SC2458 (BL)	
					TR014	269 0029 907	Transistor RN1204 (47K-47K)	Built in Resistor
					TR101-106	273 0198 918	Transistor 2SC1815 (BL)	
					TR107	269 0029 907	Transistor RN1204 (47K-47K)	Built in Resistor
					TR108	269 0030 909	Transistor RN2204 (47K-47K)	Built in Resistor
					TR109,110	—	—	
					TR111,112	—	—	
					TR801,802	273 0317 906	Transistor 2SC2458 (BL)	
					TR803	269 0024 902	Transistor RN2201 (4.7K-4.7K)	Built in Resistor
					TR804	269 0030 909	Transistor RN2204 (47K-47K)	Built in Resistor
					TR806	269 0030 909	Transistor RN2204 (47K-47K)	Built in Resistor
					TR807	269 0029 907	Transistor RN1204 (47K-47K)	Built in Resistor
					D001-004	276 0432 903	Diode 1SS270A	
					D101-103	276 0432 903	Diode 1SS270A	
					D801-819	276 0432 903	Diode 1SS270A	
					RESISTORS GROUP			
					(Not included Carbon Film ±5%, 1/4W Type.			
					Refer to the Schematic Diagram for those Parts.)			
					⚠ R038	241 2376 964	Carbon Film 47ohm, 1/4W (N.B)	RD14B2E470JNBS
					⚠ R057	241 2376 964	Carbon Film 47ohm, 1/4W (N.B)	RD14B2E470JNBS
					RA801	246 2044 013	Resistor Array 47Kohm×6	RK99==473JP6
					RA802	246 2053 033	Resistor Array 4.7Kohm×5	RK99==472JP5
					RA803	246 2044 039	Resistor Array 10Kohm×6	RK99==103JP6
					RA806	246 2044 013	Resistor Array 47Kohm×6	RK99==473JP6
					RA807	246 2052 005	Resistor Array 10Kohm×4	RK99==103JP4
					RA808	246 2076 023	Resistor Array 1.5Kohm×3	RK99==152JP3
					VR001	211 6046 024	Semi Fixed Resistor 100Kohm	V06PB104
					VR002	211 6046 082	Semi Fixed Resistor 5Kohm	V06QB502

Ref. No.	Part No.	Part Name	Remarks	Ref. No.	Part No.	Part Name	Remarks	
CAPACITORS GROUP				C821	253 1027 000	Ceramic 0.1μF/50V	CK45F1H104Z	
C001-007	253 1181 001	Ceramic 0.01μF/50V	CK45F1H103Z	OTHER GROUP				Q'ty
C008	254 4252 037	Electrolytic 100μF/10V	CE04W1A101M	L001	235 0060 963	(P.W. Board) Inductor 15μH		(1)
C009	253 1181 001	Ceramic 0.01μF/50V	CK45F1H103Z	L002,003	235 0070 924	Inductor 27μH		1
C010	254 4252 037	Electrolytic 100μF/10V	CE04W1A101M	L801	235 0060 989	Inductor 120μH		1
C011	253 1181 014	Ceramic 0.022μF/50V	CK45F1H223Z	L803	235 0060 989	Inductor 120μH		1
C012	253 4537 063	Ceramic 47PF/50V	CC45SL1H470J	S813-818	212 4388 907	Tact Switch		6
C013	253 4537 018	Ceramic 30PF/50V	CC45SL1H300J	XL001	399 0121 009	Crystal Vibrator (14.32MHz)		1
C014,015	253 4536 064	Ceramic 18PF/50V	CC45SL1H180J	XL801	399 0160 002	Ceramic Vibrator	CST8.00MTW	1
C016	253 1181 001	Ceramic 0.01μF/50V	CK45F1H103Z	FL801	393 4115 000	FLD (FIP16X1JA)		1
C017,018	253 4536 080	Ceramic 22PF/50V	CC45SL1H220J		204 8394 006	3P Pin Jack (C-GND)	Gold Flash	1
C019,020	253 1181 001	Ceramic 0.01μF/50V	CK45F1H103Z		204 8412 001	4P Pin Jack (C-GND)	Gold Flash	1
C021	253 1179 042	Ceramic 220PF/50V	CK45B1H221K		204 8414 008	2P S-Terminal	Gold Flash	2
C022	254 4252 037	Electrolytic 100μF/10V	CE04W1A101M		204 8415 008	3P S-Terminal	Gold Flash	1
C023	253 1179 042	Ceramic 220PF/50V	CK45B1H221K		204 8260 004	Mini Jack	Remote	1
C024	254 4252 037	Electrolytic 100μF/10V	CE04W1A101M	CN4B	205 0355 046	4P KR Conn. Base (L)		1
C025	253 1179 042	Ceramic 220PF/50V	CK45B1H221K	CN6F	205 0355 062	6P KR Conn. Base (L)		1
C026	254 4254 035	Electrolytic 47μF/16V	CE04W1C470M	CN7A-3	205 0343 074	7P Conn. Base (KR-PH)		1
C027	253 9030 905	BC Ceramic 1000PF/25V	CK45-1E102K	CN7A-1,7C	205 0355 075	7P KR Conn. Base (L)		2
C028	254 4254 006	Electrolytic 10μF/16V	CE04W1C100M	CN9A	205 0355 091	9P KR Conn. Base (L)		1
C029	253 1181 001	Ceramic 0.01μF/50V	CK45F1H103Z	CN13A-2	205 0375 039	13P Conn. Base (KR-PH)		1
C030	254 4254 006	Electrolytic 10μF/16V	CE04W1C100M	CN13A-1	205 0480 034	13P KR Conn. Base (L)		1
C031	253 1179 084	Ceramic 470PF/50V	CK45B1H471K	CN8B,8F	205 0679 089	JL Connector (F-E)	8P	2
C033	254 4260 045	Electrolytic 1μF/50V	CE04W1H010M	CN5C	205 0748 051	5P JL Connector (R)		1
C034	253 1180 015	Ceramic 820PF/50V	CK45B1H821K	CN6E	205 0748 064	JL Connector (R)	6P	1
C035	253 1181 014	Ceramic 0.022μF/50V	CK45F1H223Z	CN29A	205 0702 042	29P FFC Conn. Base (L)		1
C036	254 4254 006	Electrolytic 10μF/16V	CE04W1C100M		125 9002 049	UL Tube (L=25)	for C821	2
C037	255 1120 055	Plastic Film 0.0027μF/50V	CQ93M1H272J					
C038	255 1121 025	Plastic Film 0.01μF/50V	CQ93M1H103J					
C039	255 1120 097	Plastic Film 0.0056μF/50V	CQ93M1H562J					
C040	253 1179 042	Ceramic 220PF/50V	CK45B1H221K					
C041	256 1034 034	Metalized 0.047μF/50V	CF93A1H473J					
C042	254 4260 045	Electrolytic 1μF/50V	CE04W1H010M					
C043	256 1034 034	Metalized 0.047μF/50V	CF93A1H473J					
C044	254 4254 035	Electrolytic 47μF/16V	CE04W1C470M					
C045	255 1121 041	Plastic Film 0.015μF/50V	CQ93M1H153J					
C046	256 1034 050	Metalized 0.068μF/50V	CF93A1H683J					
C047	256 1034 076	Metalized 0.1μF/50V	CF93A1H104J					
C057-059	254 4260 045	Electrolytic 1μF/50V	CE04W1H010M					
C060-062	254 4252 037	Electrolytic 100μF/10V	CE04W1A101M					
C101-110	253 1181 001	Ceramic 0.01μF/50V	CK45F1H103Z					
C111-116	253 1179 084	Ceramic 470PF/50V	CK45B1H471K					
C117-122	254 4252 037	Electrolytic 100μF/10V	CE04W1A101M					
C123	254 3053 004	Electrolytic 10μF/16V (Bipole)	CE04D1C100MBP					
C124	254 4260 045	Electrolytic 1μF/50V	CE04W1H010M					
C125,126	254 4252 037	Electrolytic 100μF/10V	CE04W1A101M					
C127-130	254 4260 045	Electrolytic 1μF/50V	CE04W1H010M					
C143	254 4260 045	Electrolytic 1μF/50V	CE04W1H010M					
C801	253 1181 001	Ceramic 0.01μF/50V	CK45F1H103Z					
C802	254 4250 042	Electrolytic 330μF/6.3V	CE04W0J331M					
C803	254 4195 916	Electrolytic 4.7μF/35V	CE04W1V4R7M(SRA)					
C804	254 4196 944	Electrolytic 1μF/50V	CE04W1H010M(SRA)					
C805	254 4196 928	Electrolytic 0.33μF/50V	CE04W1HR33M(SRA)					
C806	256 1034 089	Metalized 0.12μF/50V	CF93A1H124J					
C807	254 4250 039	Electrolytic 220μF/6.3V	CE04W0J221M					
C808	253 1181 001	Ceramic 0.01μF/50V	CK45F1H103Z					
C810	253 1181 001	Ceramic 0.01μF/50V	CK45F1H103Z					
C811	254 4260 045	Electrolytic 1μF/50V	CE04W1H010M					
C812	254 4254 006	Electrolytic 10μF/16V	CE04W1C100M					
C813	253 1181 001	Ceramic 0.01μF/50V	CK45F1H103Z					
C814	253 1179 000	Ceramic 100PF/50V	CK45B1H101K					
C815	254 4261 028	Electrolytic 100μF/50V	CE04W1H101M					
C816	253 9030 905	BC Ceramic 1000PF/25V	CK45-1E102K					
C817	253 9030 921	BC Ceramic 2200PF/25V	CK45-1E222K					
C820	253 1025 002	Ceramic 0.022μF/50V	CK45F1H223Z					

1U-2436A SURROUND UNIT

Ref No.	Part No.	Part Name	Remarks
SEMICONDUCTORS GROUP			
IC451	263 0654 002	IC NJM2082D	
IC452	263 0711 000	IC M5218AP	
IC601	263 0756 104	IC SSM2125D	
IC602	263 0711 000	IC M5218AP	
IC604	263 0359 006	IC LC4966	
IC605	262 1228 007	IC LC7822	
IC607	263 0711 000	IC M5218AP	
IC608	263 0654 002	IC NJM2082D	
IC609	263 0711 000	IC M5218AP	
IC610	263 0654 002	IC NJM2082D	
IC611	263 0711 000	IC M5218AP	
IC703	263 0711 000	IC M5218AP	
IC704	262 1609 105	IC F71002B	
IC705	262 1610 000	IC HM65256BLFP-10T	
IC706	263 0711 000	IC M5218AP	
IC707,708	262 0625 009	IC TC9176P	
IC709-712	263 0711 000	IC M5218AP	
IC713	263 0609 002	IC NJM2068DDC	
IC714	263 0476 002	IC LB1639	
IC715	263 0809 006	IC NJM7805FA(S)	Regulator +5V
IC716	263 0711 000	IC M5218AP	
TR113114	275 0061 902	FET 2SK184(GR)/(BL)	FET
TR115	269 0025 901	Transistor RN1202(10K-10K)	Buit in Resistor
TR335	273 0317 906	Transistor 2SC2458(BL)	
TR451,452	273 0317 906	Transistor 2SC2458(BL)	
TR453-455	273 0253 918	Transistor 2SC2878 (A/B)	
TR601	274 0060 900	Transistor 2SD667A(C)	
TR602	272 0053 908	Transistor 2SB647A(C)	
TR603-605	269 0025 901	Transistor RN1202 (10K-10K)	Buit in Resistor
TR701	274 0060 900	Transistor 2SD667A(C)	
TR751-754	275 0061 902	FET 2SK184(GR)/(BL)	FET
TR755	269 0025 901	Transistor RN1202 (10K-10K)	Buit in Resistor
TR756,757	273 0317 906	Transistor 2SC2458(BL)	
TR758	275 0061 902	FET 2SK184 (GR)/(BL)	FET
TR759	269 0025 901	Transistor RN1202 (10K-10K)	Buit in Resistor
D103,104	276 0432 903	Diode 1SS270A	
D401-404	276 0432 903	Diode 1SS270A	
D451,452	276 0432 903	Diode 1SS270A	
D701-707	276 0432 903	Diode 1SS270A	
D751-758	276 0432 903	Diode 1SS270A	
ZD601,602	276 0466 908	Zener Diode HZS7C-1	7V
ZD701	276 0462 902	Zener Diode HZS6B-1	6V
RESISTORS GROOUP			
(Not included Carbon Film ±5% 1/4W Type. Refer to the Schematic Diagram for those Parts.)			
R603,604	241 2387 940	Carbon Film 100Kohm 1/4W (NIP)	RD14E2541JNE-S
R605	242 0203 903	Carbon Composition 100Kohm 1/4W	RD036F1106K
R699	241 2387 940	Carbon Film 100Kohm 1/4W (NIP)	RD14E2541JNE-S
R709	241 2379 974	Carbon Film 910ohm 1/4W	RD14E2541JNE-S
VR701	211 0759 003	Variable Resistor 100Kohm	Main

Ref No.	Part No.	Part Name	Remarks
CAPACITORS GROUP			
C137	254 4254 006	Electroytic 10μF/16V	CE04W1C100M
C140	254 4254 006	Electroytic 10μF/16V	CE04W1C100M
C207-214	253 1179 000	Ceramic 100PF/50V	CK45B1H101K
C215	254 4260 045	Electroytic 1μF/50V	CE04W1H010M
C217	254 4260 045	Electroytic 1μF/50V	CE04W1H010M
C403,404	253 1024 003	Ceramic 0.01μF/50V	CK45F1H103Z
C451,452	254 4260 045	Electroytic 1μF/50V	CE04W1H010M
C453	254 4260 087	Electroytic 10μF/50V	CE04W1H100M
C454	253 1024 003	Ceramic 0.01μF/50V	CK45F1H103Z
C455	254 4260 090	Electroytic 22μF/50V	CE04W1H220M
C456	254 4254 006	Electroytic 10μF/16V	CE04W1C100M
C459,460	254 4254 006	Electroytic 10μF/16V	CE04W1C100M
C461,462	253 4536 006	Ceramic 10PF/50V	CC45SL1H100D
C463	253 1024 003	Ceramic 0.01μF/50V	CK45F1H103Z
C464,465	253 1024 003	Ceramic 0.01μF/50V	CK45F1H103Z
C466	253 1181 001	Ceramic 0.01μF/50V	CK45F1H103Z
C467	254 4254 006	Electroytic 10μF/16V	CE04W1C100M
C468	253 1181 001	Ceramic 0.01μF/50V	CK45F1H103Z
C469	254 4254 006	Electroytic 10μF/16V	CE04W1C100M
C470	253 1181 001	Ceramic 0.01μF/50V	CK45F1H103Z
C475	253 1181 001	Ceramic 0.01μF/50V	CK45F1H103Z
C601,602	254 4261 015	Electroytic 47μF/50V	CE04W1H470M
C603,604	256 1034 076	Metalized 0.1μF/50V	CF93A1H104J
C605,606	254 4254 048	Electroytic 100μF/16V	CE04W1C101M
C607	254 4258 002	Electroytic 4.7μF/35V	CE04W1V4R7M
C608,609	256 1035 017	Metalized 0.22μF/50V	CF93A1H224J
C610	254 4258 015	Electroytic 10μF/35V	CE04W1V100M
C611,612	254 4260 087	Electroytic 10μF/50V	CE04W1H100M
C614	253 1181 001	Ceramic 0.01μF/50V	CK45F1H103Z
C615-617	255 1121 025	Plastic Film 0.01μF/50V	CQ93M1H103J
C618	254 4254 048	Electroytic 100μF/16V	CE04W1C101M
C619	254 4258 002	Electroytic 47μF/35V	CE04W1V4R7M
C620	254 4260 045	Electroytic 1μF/50V	CE04W1H010M
C621	254 4254 006	Electroytic 10μF/16V	CE04W1C100M
C622	254 4260 045	Electroytic 1μF/50V	CE04W1H010M
C623	254 4258 002	Electroytic 4.7μF/35V	CE04W1V4R7M
C624,625	256 1035 017	Metalized 0.22μF/50V	CF93A1H224J
C626-629	256 1035 033	Metalized 0.33μF/50V	CF93A1H334J
C630,631	256 1034 076	Metalized 0.1μF/50V	CF93A1H104J
C632	253 1180 002	Ceramic 680PF/50V	CK45B1H681K
C633-635	255 1121 067	Plastic Film 0.022μF/50V	CQ93M1H223J
C636	256 1034 076	Metalized 0.1μF/50V	CF93A1H104J
C637-639	254 4258 002	Electroytic 4.7μF/35V	CE04W1V4R7M
C640	255 1121 067	Plastic Film 0.022μF/50V	CQ93M1H223J
C641	253 1180 002	Ceramic 680PF/50V	CK45B1H681K
C642,643	256 1034 076	Metalized 0.1μF/50V	CF93A1H104J
C675-678	254 4260 045	Electroytic 1μF/50V	CE04W1H010M
C679,680	255 6177 919	Plastic Film 56PF/50V (SMT)	CQ09S1H560J
C683,684	253 9030 015	BC Ceramic 1500PF/25V	CK45-1E152K
C685,686	253 1179 042	Ceramic 220PF/50V	CK45B1H221K
C687,688	253 9031 072	BC Ceramic 3900PF/25V	CK45-1E392K
C689,690	254 4254 006	Electroytic 10μF/16V	CE04W1C100M
C691,692	254 4260 045	Electroytic 1μF/50V	CE04W1H010M
C693,694	255 6177 919	Plastic Film 56PF/50V (SMT)	CQ09S1H560J
C697,698	253 9030 015	BC Ceramic 1500PF/25V	CK45-1E152K
C699,700	253 1179 042	Ceramic 220PF/50V	CK45B1H221K
C701,702	253 9031 072	BC Ceramic 3900PF/25V	CK45-1E392K
C703,704	254 4254 006	Electroytic 10μF/16V	CE04W1C100M
C705-707	253 1181 014	Ceramic 0.022μF/50V	CK45F1H223Z
C708	254 4254 006	Electroytic 10μF/16V	CE04W1C100M
C709	254 4254 048	Electroytic 100μF/16V	CE04W1C101M
C710	253 1181 001	Ceramic 0.01μF/50V	CK45F1H103Z
C711,712	253 1179 013	Ceramic 120PF/50V	CK45B1H121K
C713,714	254 4054 006	Electroytic 10μF/16V	CE04W1C100M

1U-2422A AUDIO REC UNIT

Ref No	Part No	Part Name	Remarks
SEMICONDUCTORS GROUP			
TR280	273 0317 906	Transistor 2SC2458 (BL)	
TR326,327	273 0317 906	Transistor 2SC2458 (BL)	
TR328	271 0191 906	Transistor 2SA1048 (GR)	
TR329,330	273 0317 906	Transistor 2SC2458 (BL)	
TR331	271 0191 906	Transistor 2SA1048 (GR)	
TR332	273 0317 906	Transistor 2SC2458 (BL)	
D206,207	276 0432 903	Diode 1SS270A	
D314	276 0432 903	Diode 1SS270A	
ZD304	276 0465 909	Zener Diode HZS7B-1	7V
SC301	279 0016 904	Thyristor SP01A42	
RESISTORS GROUP			
(Not included Carbon Film ±5%, 1/4W Type. Refer to the Schematic Diagram for those Parts.)			
RA24	244 2052 902	Metal Oxide 27Kohm±1% (W,N,B)	RS14B3A27J (MBS(S))
RA68	244 2052 973	Metal Oxide 560ohm, 1W (N,B)	RS14B3A56J (MBS(S))
RA70	244 2052 973	Metal Oxide 560ohm, 1W (N,B)	RS14B3A56J (MBS(S))
RA74	244 2052 973	Metal Oxide 560ohm, 1W (N,B)	RS14B3A56J (MBS(S))
CAPACITORS GROUP			
C101,102	254 4260 045	Electrolytic 1uF50V	CE04W1H010M
C342	254 4260 090	Electrolytic 22uF50V	CE04W1H220M
C343,344	254 4250 042	Electrolytic 330uF6.3V	CE04W1H331M
C347	254 4261 002	Electrolytic 33uF50V	CE04W1H330M
OTHER GROUP			
RL001,002	214 0129 001	(PW Board) Relay (DH2TLU)	(1)
	204 6993 007	4P Pin-Jack (S-GND)	2
	205 0472 039	8P SP Terminal	1
CN3T	203 4833 021	3P EH-SCN Conn. Cord	1
CN3J	205 0343 032	3P Conn. Base (KR-PH)	1
CN6B	205 0343 061	6P Conn. Base (KR-PH)	1
CN4C	205 0653 049	4P VH Conn. Base	1
CN6I	205 0731 068	6P Conn. Base-L (9131)	1
CN6F	205 0748 033	9P J-L Connector (R)	1

Ref. No.	Part No.	Part Name	Remarks	Q'ty
C715,716	255 1264 063	Plastic Film 0.0033uF50V (SMT)	C039M1H332(B)	1
C717	253 9031 027	BC Ceramic 0.1uF25V	CK45-1E104K	1
C718	254 4254 035	Electrolytic 47uF16V	CE04W1C470M	1
C719	253 9031 027	BC Ceramic 0.1uF25V	CK45-1E104K	1
C720	254 4254 035	Electrolytic 47uF16V	CE04W1C470M	1
C722	253 9031 027	BC Ceramic 0.1uF25V	CK45-1E104K	1
C723,724	253 4536 077	Ceramic 200PF50V	C046SL1H200J	2
C725	253 9031 027	BC Ceramic 0.1uF25V	CK45-1E104K	1
C726	254 4260 074	Electrolytic 47uF50V	CE04W1H470M	1
C727,728	254 4260 045	Electrolytic 1uF50V	CE04W1H010M	1
C729,730	254 4254 006	Electrolytic 10uF16V	CE04W1C100M	1
C731	254 4254 051	Electrolytic 220uF16V	CE04W1C221M	1
C732	253 1181 001	Ceramic 0.01uF50V	CK45FH103Z	1
C733-736	254 4254 006	Electrolytic 10uF16V	CE04W1C100M	1
C737,738	253 1179 000	Ceramic 100PF50V	CK45B1H01K	1
C739,740	254 4254 006	Electrolytic 10uF16V	CE04W1C100M	1
C741-744	253 1181 014	Ceramic 0.022uF50V	CK45FH223Z	1
C745,746	254 4260 045	Electrolytic 1uF50V	CE04W1H010M	1
C747,748	254 4254 006	Electrolytic 10uF16V	CE04W1C100M	1
C749	253 1179 000	Ceramic 100PF50V	CK45B1H01K	1
C750-754	254 4254 006	Electrolytic 10uF16V	CE04W1C100M	1
C755-758	254 4260 045	Electrolytic 1uF50V	CE04W1H010M	1
C759,760	254 4254 022	Electrolytic 33uF16V	CE04W1C330M	1
C761,762	256 1034 069	Metallized 0.22uF50V	CF39A1H124J	1
C763,766	255 1121 054	Plastic Film 0.01uF50V	C039M1H183J	1
C767	254 4254 006	Electrolytic 10uF16V	CE04W1C100M	1
C768,769	254 4260 045	Electrolytic 1uF50V	CE04W1H010M	1
C770	254 4254 006	Electrolytic 10uF16V	CE04W1C100M	1
C771	255 1121 054	Plastic Film 0.01uF50V	C039M1H183J	1
C772	254 4259 057	Electrolytic 100uF35V	CE04W1H010M	1
C773,774	254 4260 045	Electrolytic 1uF50V	CE04W1H010M	1
C775,776	254 4260 045	Electrolytic 10uF16V	CE04W1C100M	1
C777,778	254 4261 028	Electrolytic 47uF10V	CE04W1H470M	1
C779	254 4252 024	Electrolytic 1uF50V	CE04W1H010M	1
C780-782	253 1181 001	Ceramic 0.01uF50V	CK45F1H103Z	1
C783	254 3956 014	Ceramic 10uF50V (BI Pole)	CE04D1H10MBP	1
C785,786	254 4254 006	Electrolytic 10uF16V	CE04W1C100M	1
C787,793	253 1179 000	Ceramic 100PF50V	CK45B1H01K	1
C794	254 4260 045	Electrolytic 1uF50V	CE04W1H010M	1
OTHER GROUP				Q'ty
L701	235 0060 989	(PW Board) Inductor 120mH		(1)
S921-606	212 4988 907	Fac. Switch		16
XL701	399 0162 000	Crystal Vibrator (11.289MHz)		1
RL751-753	214 0127 000	Relay (RY:12W)		3
	204 8393 007	4P Pin-Jack (S-GND)		2
FL701,702	232 0168 002	LC Filter		2
	205 0472 039	8P SP Terminal		1
CN3G,I	205 0343 032	3P Conn. Base (KR-PH)		2
CN3C	205 0323 036	3P Conn. Base (BLK)		1
CN5G	205 0343 056	5P Conn. Base (KR-PH)		1
CN6F	205 0323 052	5P Conn. Base (BLK)		1
CN6H	205 0233 061	6P Conn. Base (Base)		1
CN5E	205 0637 050	J-L Connector (F-E)	5P	1
CN6D	205 0637 063	J-L Connector (F-E)	6P	1
CN8D	205 0637 069	J-L Connector (F-E)	8P	1
CN3B	205 0653 036	3P VH Conn. Base		1
CN4A	205 0653 049	4P VH Conn. Base		1
CN5D	205 0731 055	5P Conn. Base-L (9131)		1
CN7B	205 0667 077	7P Conn. Base-L (9130)		1
CN8C,D	205 0731 097	9P Conn. Base-L (9131)		2
CN12C	205 0536 027	12P Conn. Socket		1

WIRING DIAGRAM

1 2 3 4 5 6 7 8

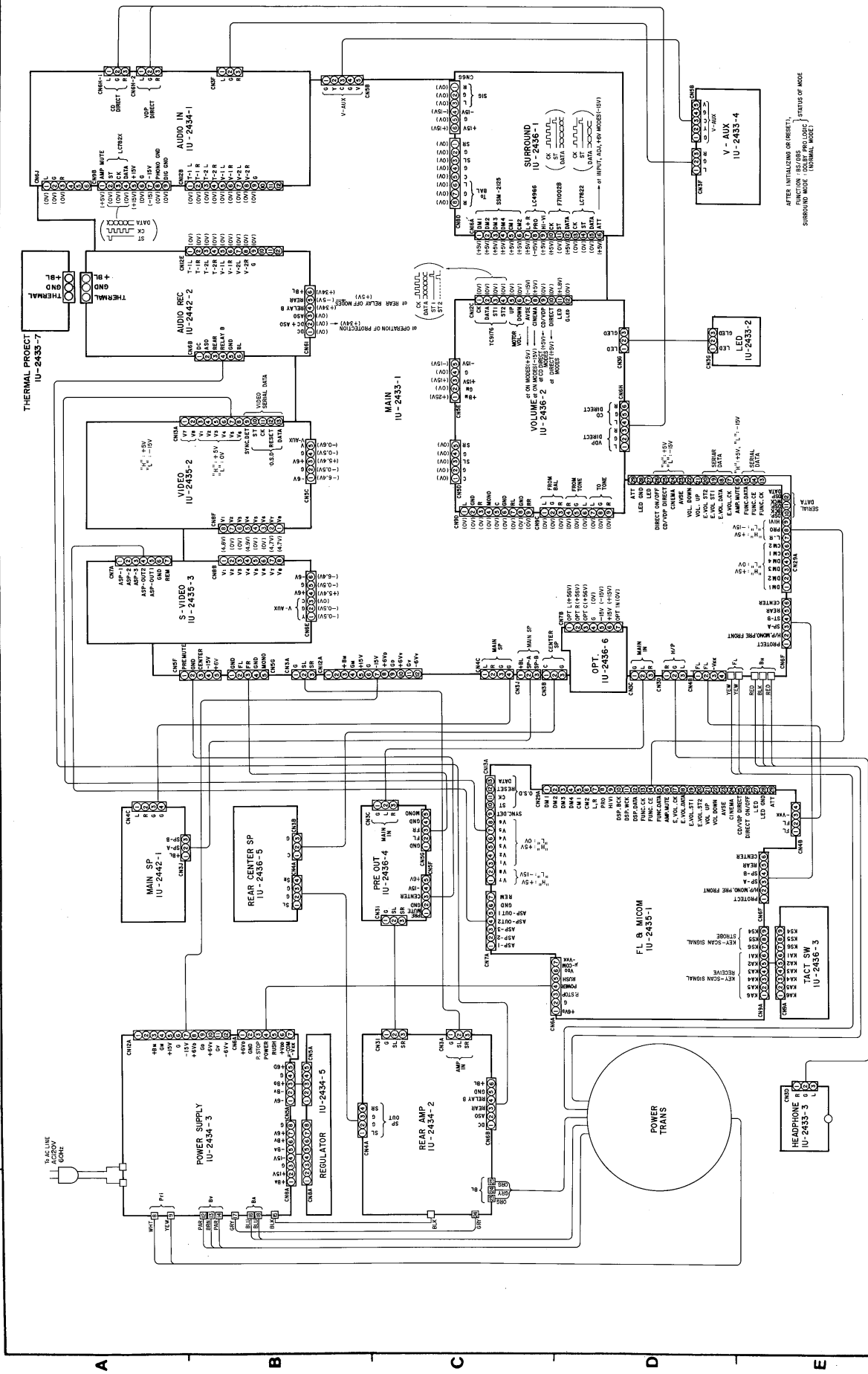

SCHEMATIC DIAGRAM - 1/4

1 2 3 4 5 6 7 8 9 10 11

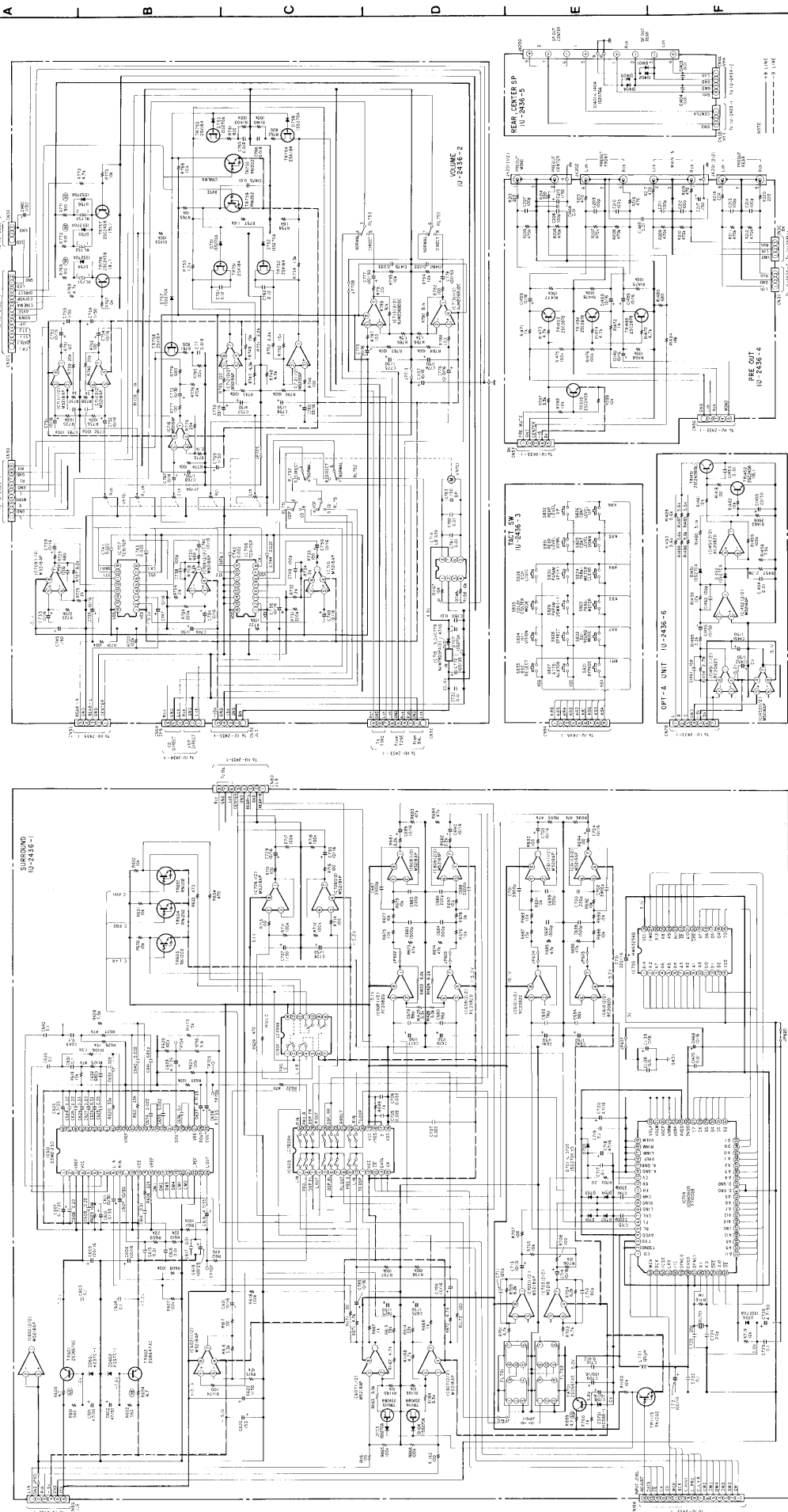

NOTES
 ALL RESISTANCE VALUES IN OHM. K=1,000 OHM. M=1,000,000 OHM
 ALL CAPACITANCE VALUES IN MICRO FARAD. P=PICTO-MICRO FARAD
 EACH VOLTAGE AND CURRENT ARE MEASURED WITH INSTRUMENTS
 CROUD AND PARTS ARE SUBJECT TO CHANGE WITHOUT NOTICE

SCHEMATIC DIAGRAM - 2/4

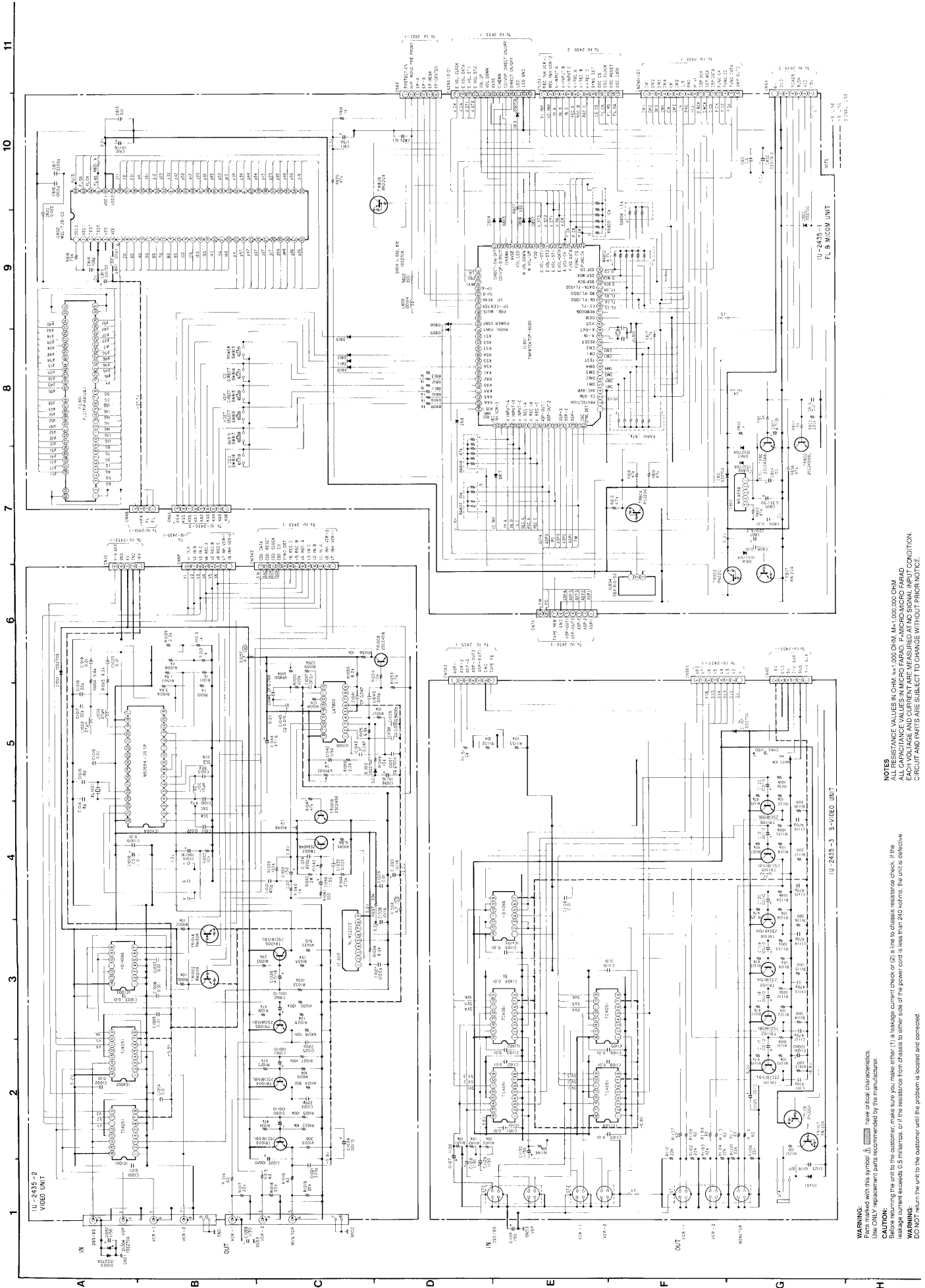

NOTES
 ALL RESISTANCE VALUES IN OHM. $\times 10^3$ KHM. $\times 10^6$ OHM.
 ALL CAPACITANCE VALUES IN MICRO FARAD. P-MICRO MICRO-FARAD.
 C-CIRCUIT AND PARTS ARE SUBJECT TO CHANGE WITHOUT PRIOR NOTICE.

WARNING:
 Use ONLY replacement parts recommended by the manufacturer.
CAUTION:
 Before returning the unit to the customer, make sure you make either (1) a leakage current check or (2) a line to chassis resistance check. If the leakage current exceeds 0.5 millamps, or if the resistance from chassis to either side of the power cord is less than 500 ohms, the unit is defective. DO NOT return the unit to the customer until the problem is located and corrected.

SCHEMATIC DIAGRAM - 3/4

1 2 3 4 5 6 7 8 9 10 11

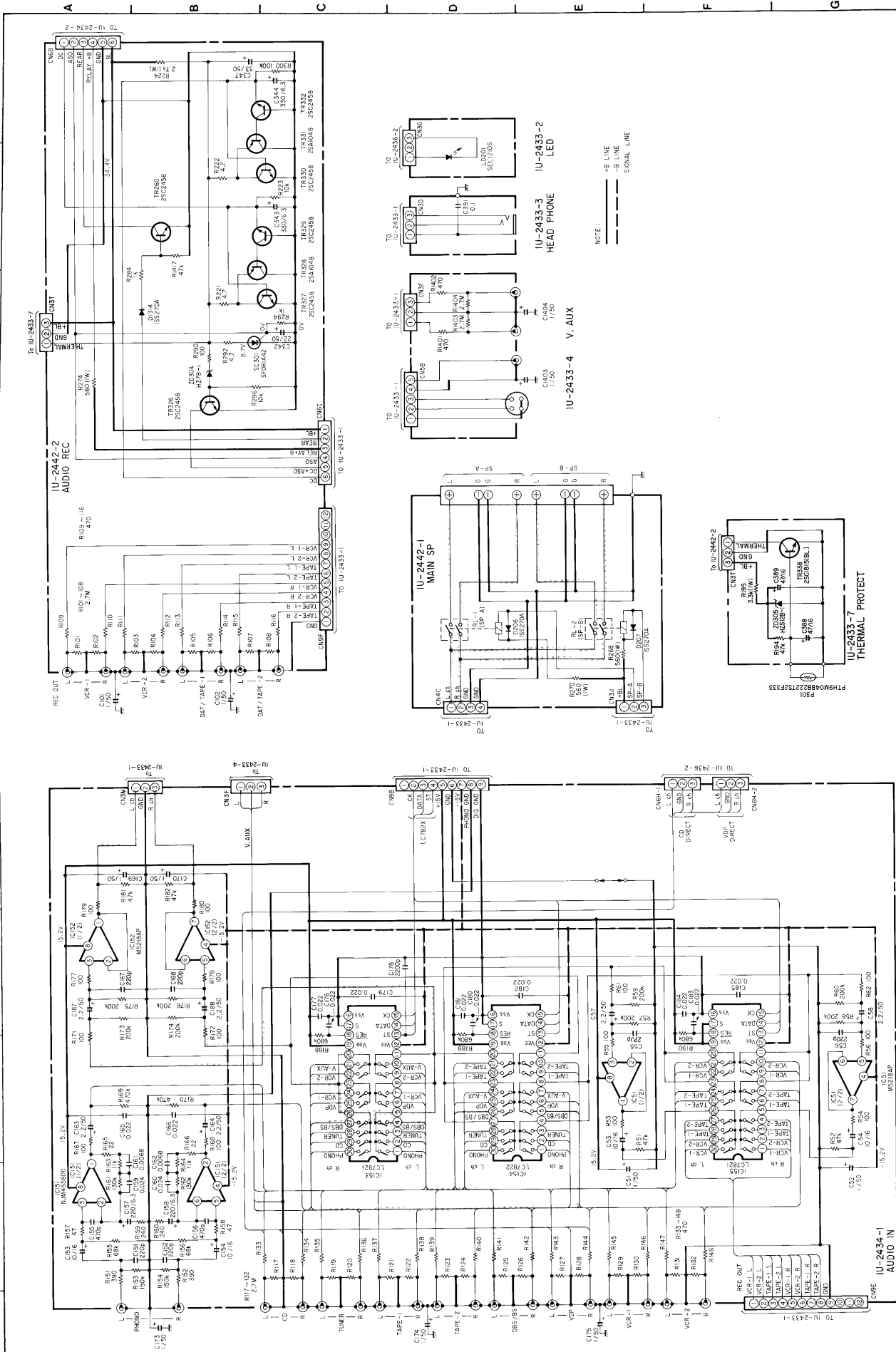

WARNINGS:
 Parts marked with this symbol have critical characteristics. Use ONLY replacement parts recommended by the manufacturer.

CAUTION:
 Before using this unit to the customer, make sure you make either (1) a leakage current check or (2) a line to chassis resistance check. If the leakage current exceeds 0.5 milliamperes, or if the resistance from chassis to either side of the power cord is less than 240 kohms, the unit is defective.

NOTES:
 RESISTANCE VALUES IN OHMS, IN K OHMS, IN M OHMS, IN G OHMS, IN MEG OHMS, IN MICRO OHMS, IN PICO OHMS, IN MICRO MICRO OHMS. EACH VOLTAGE AND CURRENT ARE MEASURED AT NO SIGNAL INPUT CONDITION. CIRCUIT AND PARTS ARE SUBJECT TO CHANGE WITHOUT PRIOR NOTICE.

NOTE:
 --- 4B LINE
 - - - - - 5B LINE
 - - - - - SIGNAL LINE

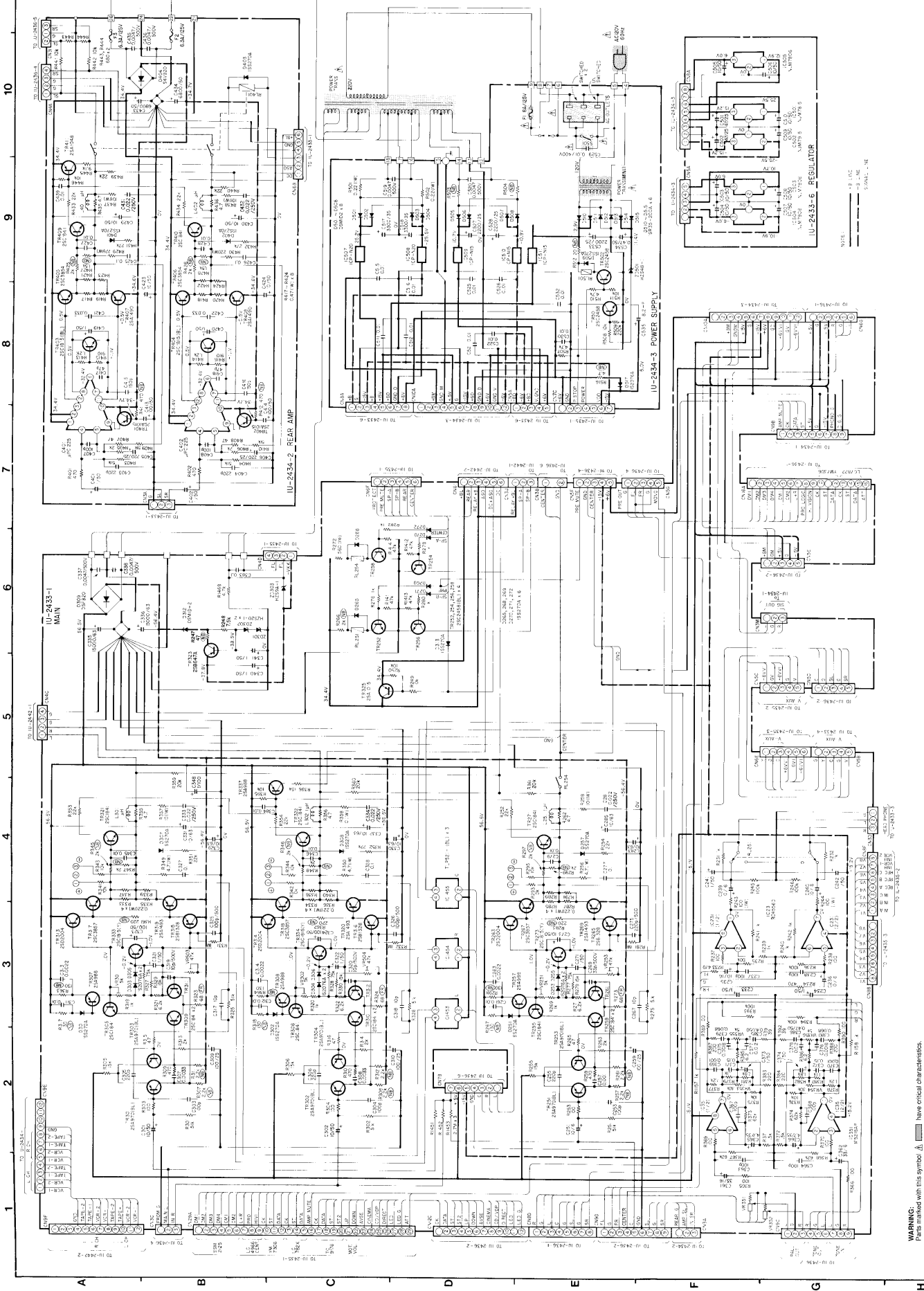

WARNING: Parts marked with this symbol Δ have critical characteristics. Use ONLY replacement parts recommended by the manufacturer.

CAUTION: When the unit is returned to the customer, make sure you make either (1) a leakage current check, or (2) a line to chassis resistance check. If the average current exceeds 0.5 millamps, or if the resistance from chassis to either side of the power cord is less than 250 kOhms, the unit is defective.

WARNING: DO NOT return the unit to the customer until the problem is located and corrected.

NOTES:
 1. CAPACITANCE VALUES IN OHMS, IN μ ARE OHMS. IN μ ARE OHMS.
 2. ALL CAPACITANCE VALUES IN MICRO-FARADS.
 3. EACH VOLTAGE AND CURRENT ARE MEASURED AT NO SIGNAL INPUT CONDITION.
 4. CIRCUIT AND PARTS ARE SUBJECT TO CHANGE WITHOUT PRIOR NOTICE.

BLOCK DIAGRAM

1 2 3 4 5 6 7 8

(VIDEO SECTION)

S. SIG

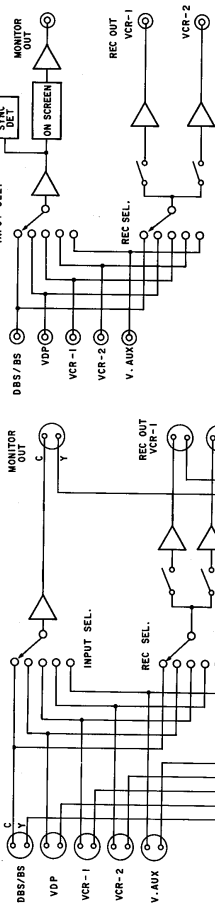

(AUDIO SECTION)

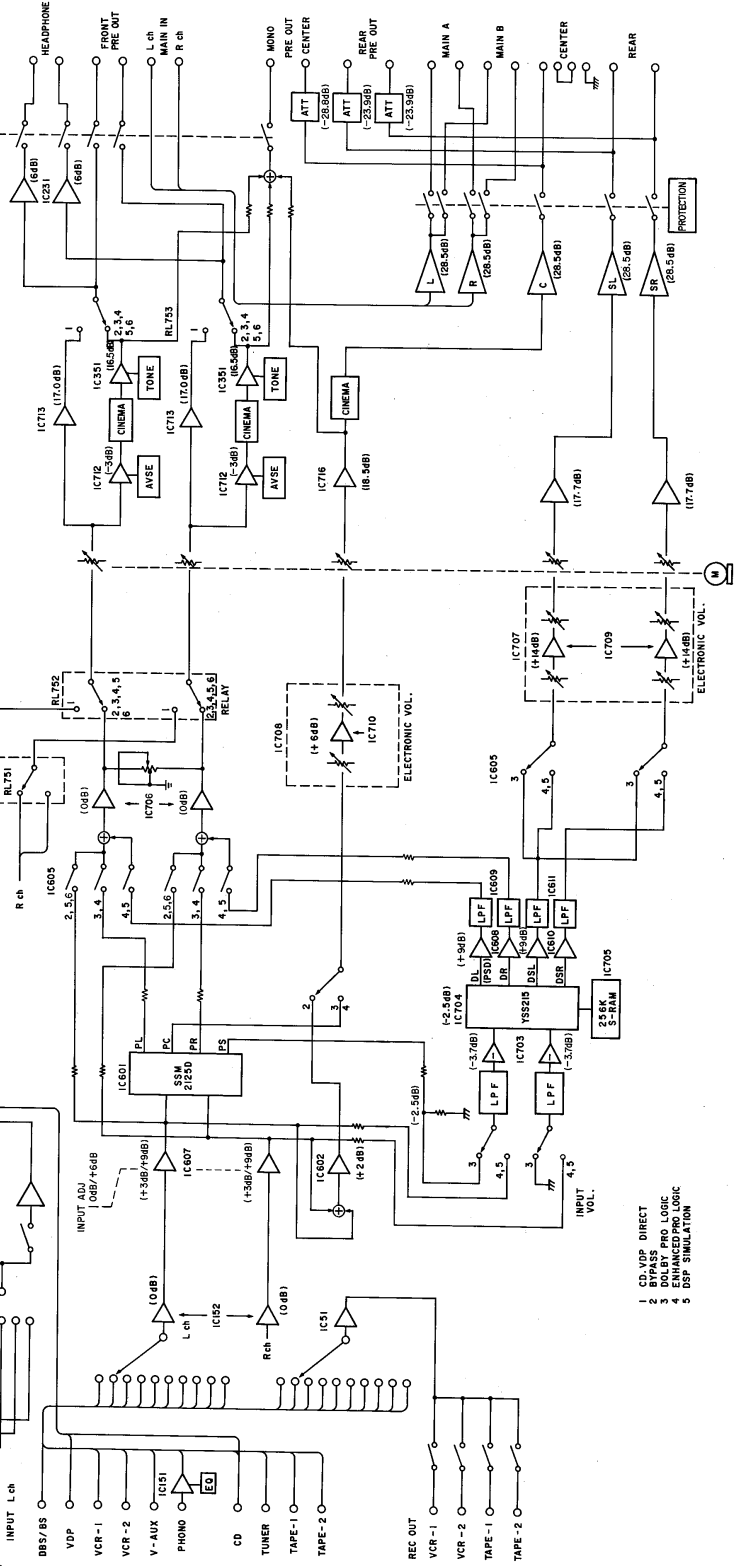

- 1 CD, VDP DIRECT
- 2 BYPASS PRO LOGIC
- 4 ENHANCED PRO LOGIC
- 5 DSP SIMULATION

EXPLODED VIEW OF CHASSIS AND CABINET

1 2 3 4 5 6 7 8

WARNING:
Parts marked with this symbol Δ have critical characteristics.
Use ONLY replacement parts recommended by the manufacturer.

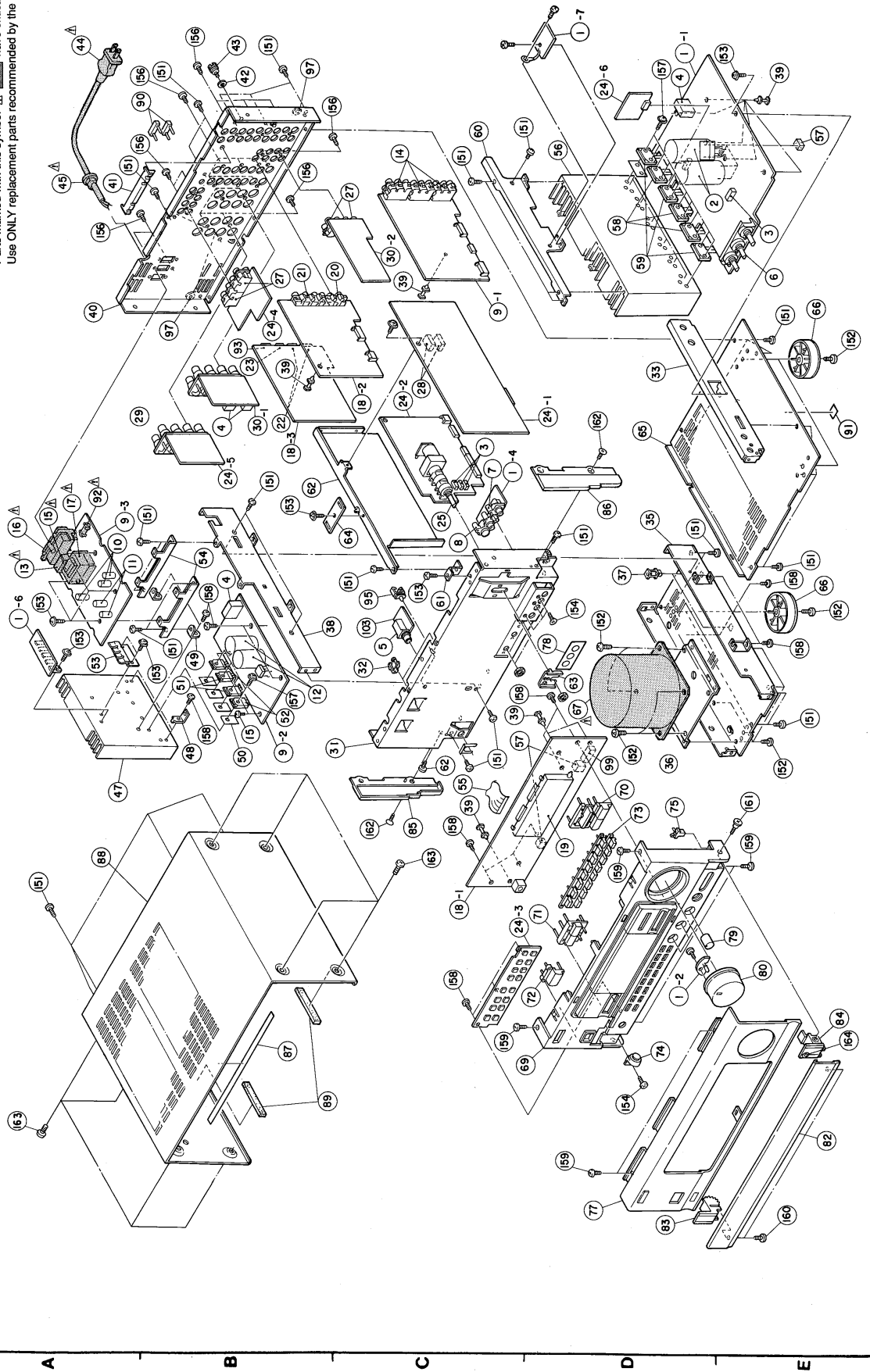

PARTS LIST OF EXPLODED VIEW

Ref. No.	Part No.	Part Name	Remarks	Q'ty	Ref. No.	Part No.	Part Name	Remarks	Q'ty
1	1U-2433A	Main Amp Unit Assy		1	41	412 3519 005	PWB Support (A)		1
1-1		Main Amp Unit		(1)	42	477 0018 001	Washer (P-47)		1
1-2		LED Unit		(1)	43	205 0071 016	Terminal Assy	GND	1
1-3		Head Phone Unit		(1)	44	206 2050 002	AC Cord (Polished)		1
1-4		Video Aux. Unit		(1)	45	412 3519 005	AC Cord (Polished)		1
1-5		Regulator Unit		(1)	46	412 3519 005	AC Cord (Polished)		1
1-6		Regulator Unit		(1)	47	0459 215	Power Radiator (B)		1
2	254 6170 007	Thermal Protect Unit		(1)	48	412 3225 108	PWB Bracket (A)		2
3	254 0127 003	Chemicon 1500uF63V	C335,336	2	49	412 3227 003	L Bracket		4
4	214 0128 001	Relay (RV-12W)		2	50	415 0284 007	Insulating Sheet		2
5	204 8341 017	Headphone Jack	Gold Flash	2	51	273 0386 005	Transistor 2SC3854 (OPV)	TR405,406	2
6	211 0780 005	Variable Resistor	VR351,356	1	52	412 3519 005	Spring Plate (A)	TR407,408	2
7	204 8342 003	3P Pin Jack (C-GND)		1	53	412 3519 103	PWB Bracket		2
8	205 0835 000	S-Terminal		1	54	412 3521 006	PWB Bracket		2
9	1U-2434D	Rear Input Unit Assy		1s	55	002 0045 003	29C FF Cable		1
9-1		Audio Input Unit		(1)	56	417 0459 313	Power Radiator (A)		1
9-2		Rear Amp Unit		(1)	57	461 0539 046	Rubber Sheet	15x10xT10	6
9-3		Power Supply Unit		(1)	58	273 0354 008	Transistor 2SC3857 (O)(V)	TR267,317,318	3
10	254 4256 790	Chemicon 2200uF25V	C527,528,333	3	59	271 0220 000	Transistor 2SA1493 (O)(V)	TR689,319,320	3
11	254 4259 014	Chemicon 3300uF35V	C517,518	2	60	412 3529 204	Radiator Bracket		1
12	254 4355 002	Chemicon 6800uF50V	C433,434	2	61	412 3529 008	Support Bracket		1
14	204 8378 003	6P Pin Jack (S-GND)		3	62	411 1177 103	Shield Chassis		1
18	1U-2435C	VFD, VIDEO Unit Assy		1s	63	412 3520 100	PWB Support (B)		1
18-1		VFD, LC-Comm. Unit		(1)	64	412 3520 007	PWB Support (B)		1
18-2		Video Unit		(1)	65	105 1051 007	Bottom Cover		1
18-3		S-Video Unit		(1)	66	104 0164 108	Front Assy		4
19	393 4115 000	FLD (FP 15X,UA)		(1)	67	415 1375 344	Inner Panel Assy		1
20	204 8394 006	3P Pin Jack (C-GND)	Gold Flash	1	70	113 1594 017	Function Knob (A)		1
21	204 8412 001	4P Pin Jack (C-GND)	Gold Flash	1	71	113 1594 017	Function Knob (B)		1
22	204 8414 009	2P S-Terminal	Gold Flash	2	72	113 1292 236	Push Knob (P)		2
23	204 8415 008	3P S-Terminal	Gold Flash	2	73	113 1464 019	Push Knob		2
24	1U-2436A	Surround Unit Assy		1s	74	421 9007 007	Mini Damper		1
24-1		Volume Unit		(1)	75	435 0113 009	Latch (Y3Y18)		1
24-2		Tact Switch Unit		(1)	76	445 8004 007	Wire Clamp		1
24-3		Pre Out Unit		(1)	77	144 2201 314	Front Panel Assy		1
24-4		Center, Rear SP Unit		(1)	78	146 9045 207	Blind Sheet		1
24-5		OPT-A Unit		(1)	79	112 0712 015	Vol. Knob (B)		3
24-6		Variable Resistor 100 Kohm	Main VR	(1)	80	112 0555 007	Trap Door		1
25	211 0759 003	Variable Resistor 100 Kohm		1	82	144 1941 109	Vol. Knob Assy		1
26	204 8393 007	4P Pin Jack (S-GND)		4	83	401 0166 309	Hinge (L)		1
27	232 0168 002	LC Filter		2	84	401 0166 309	Hinge (R)		1
28	205 0472 033	8P SP Terminal		2	85	146 1378 011	Side Plate (L)		1
29	205 0472 033	8P SP Terminal		2	86	146 1378 011	Side Plate (R)		1
30	1U-2436A	Audio Rec. Unit Assy		1s	87	122 0163 049	Spacer	t=1	1
30-1		Main SP Unit		(1)	88	102 0515 118	Top Cover		1
30-2		Audio Rec. Unit		(1)	89	461 8001 043	Rubber Sheet		2
30-3		Main SP Unit		(1)	90	205 0752 005	Short Pin	T5x10x70	2
30-4		Impush Unit		(1)	91	513 8286 009	Dangerous Mark	AC Cord	2
30-5		Pre Out Unit		(1)	92	306 1066 901	Fuse (3A/0.125A)	3A/0.125A	1
30-6		Regulator Unit		(1)	93	204 8200 004	Mini Jack	Remote	1
31	411 1175 309	Front Chassis Assy		1	94	513 1796 097	Fuse Caution Label		1
32	445 0073 007	Wire Clip		3	95	449 0068 014	Wire Saddle		2
33	411 0957 610	Side Chassis		1	96	513 1673 000	Fuse Caution Label		1
34	411 1021 314	Trans Chassis		1	97	477 0224 031	SP Washer		2
35	415 9169 209	Trans Bracket		1	98	513 2046 018	IC Caution Label		1
36	415 9032 006	PCB Holder (T)		2	99	461 0334 052	Rubber Sheet		1
37	415 9032 006	PCB Holder (T)		2	100	513 2046 021	IC Caution Label	30x10xT10	1
38	411 0928 104	Center Chassis		1					
39	412 2814 028	Card Spacer (L=10)		11					
40	105 1037 393	Rear Panel		1					

PACKING & ACCESSORIES
(Not included EXPLODED VIEW)

Ref. No.	Part No.	Part Name	Remarks	Q'ty	Ref. No.	Part No.	Part Name	Remarks	Q'ty
151	473 7015 018	Tapping Screw (S) 3x8	Black	35	201	504 0692 060	Styrene Paper	for AC Cord	1
152	473 7007 000	Tapping Screw (S) 4x8	Black	12	202	504 9102 029	Styrene Paper	for Set	1
153	473 8007 025	Cup Screw 3x8	Black	13	203	505 9102 019	Poly Cover		1
154	473 7511 004	F.H. Tapping Screw (P) 3x10	Black	4	204	503 1017 203	Cushion		2
155	477 0064 107	Fixing Screw		21	205	511 2650 006	Inst. Manual	Incl. RFP	1
156	473 8007 009	Cup Screw 3x12		16	206	498 0257 008	Remoon Receiver (RC-162)	Batteries (2)	1
157	473 7501 001	Tapping Screw (P) 3x10		19	207	501 1610 170	Carbon Case		1
158	473 7502 021	Tapping Screw (S) 3x8	Black	7	208	505 8006 010	Envelope		1
159	473 7500 044	Tapping Screw (P) 3x8	Black	2	209	502 0741 069	Pad	170x110x45	1
160	473 7514 001	Special Screw		1	210	502 0741 043	Pad	185x45x45	1
161	473 7009 011	F.H. Tapping Screw (S) 3x10		4	211	515 0623 002	Dat Warranty Home		1
162	477 0263 005	3P Swelling Screw		8					
163	477 0231 024	Washer #4 (S)		1					
164									
165									
166									

NOTE FOR PARTS LIST

- Part indicated with the mark "●" are not always in stock and possibly to take a long period of time for supplying, or in some cases supplying of part may be refused.
 - When ordering of part, clearly indicate "1" and "1" (1) to avoid mis-supplying.
 - Part indicated with the mark "▲" is not illustrated in the exploded view.
 - Part indicated with the mark "▲" is not illustrated in the exploded view.
- WARNING:**
Parts marked with this symbol ▲ have critical characteristics. Use ONLY replacement parts recommended by the manufacturer.

REMOTE CONTROL UNIT
SCHEMATIC DIAGRAM

8

7

6

5

4

3

2

1

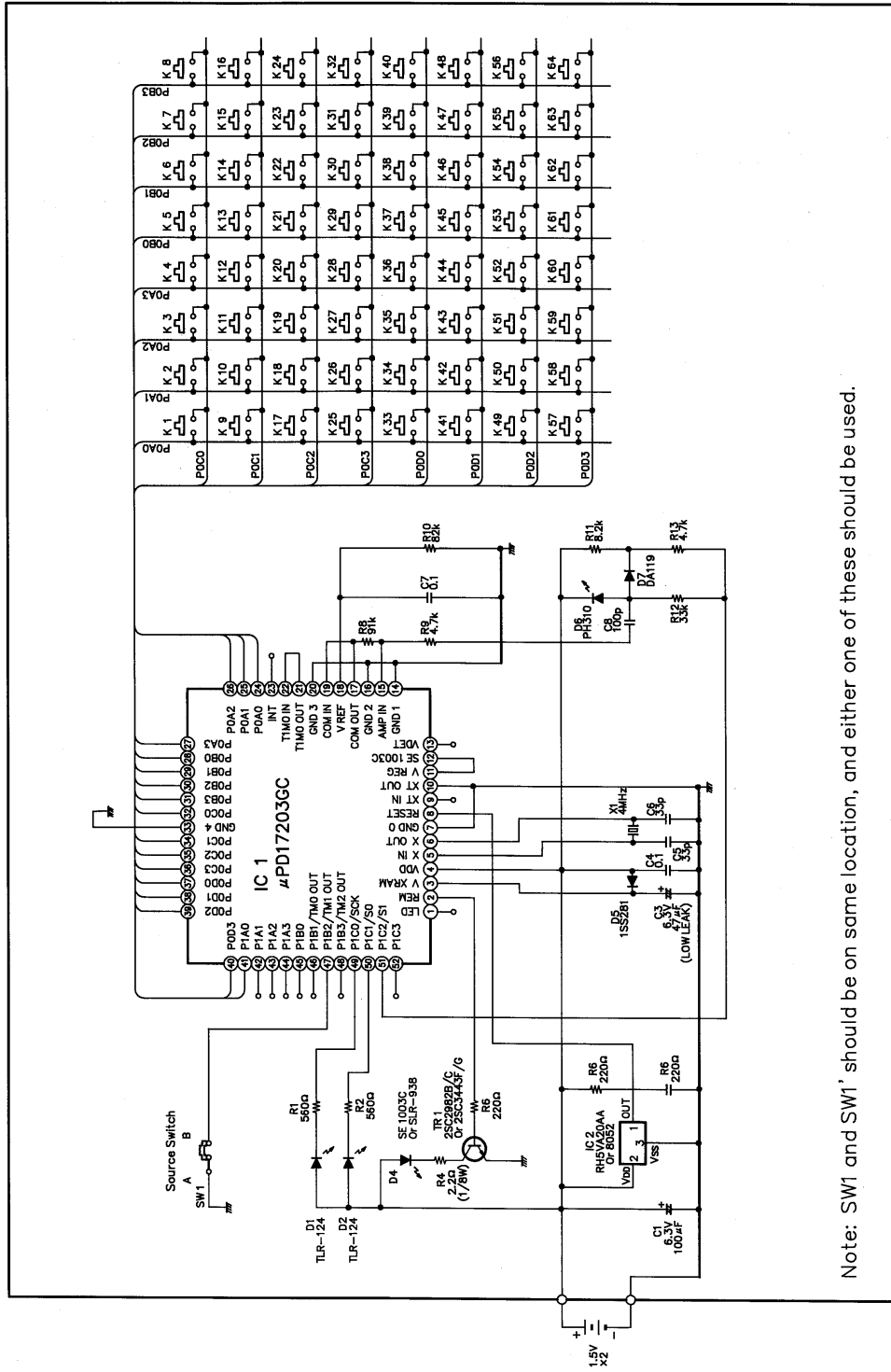

Note: SW1 and SW1' should be on same location, and either one of these should be used.

EXPLODED VIEW

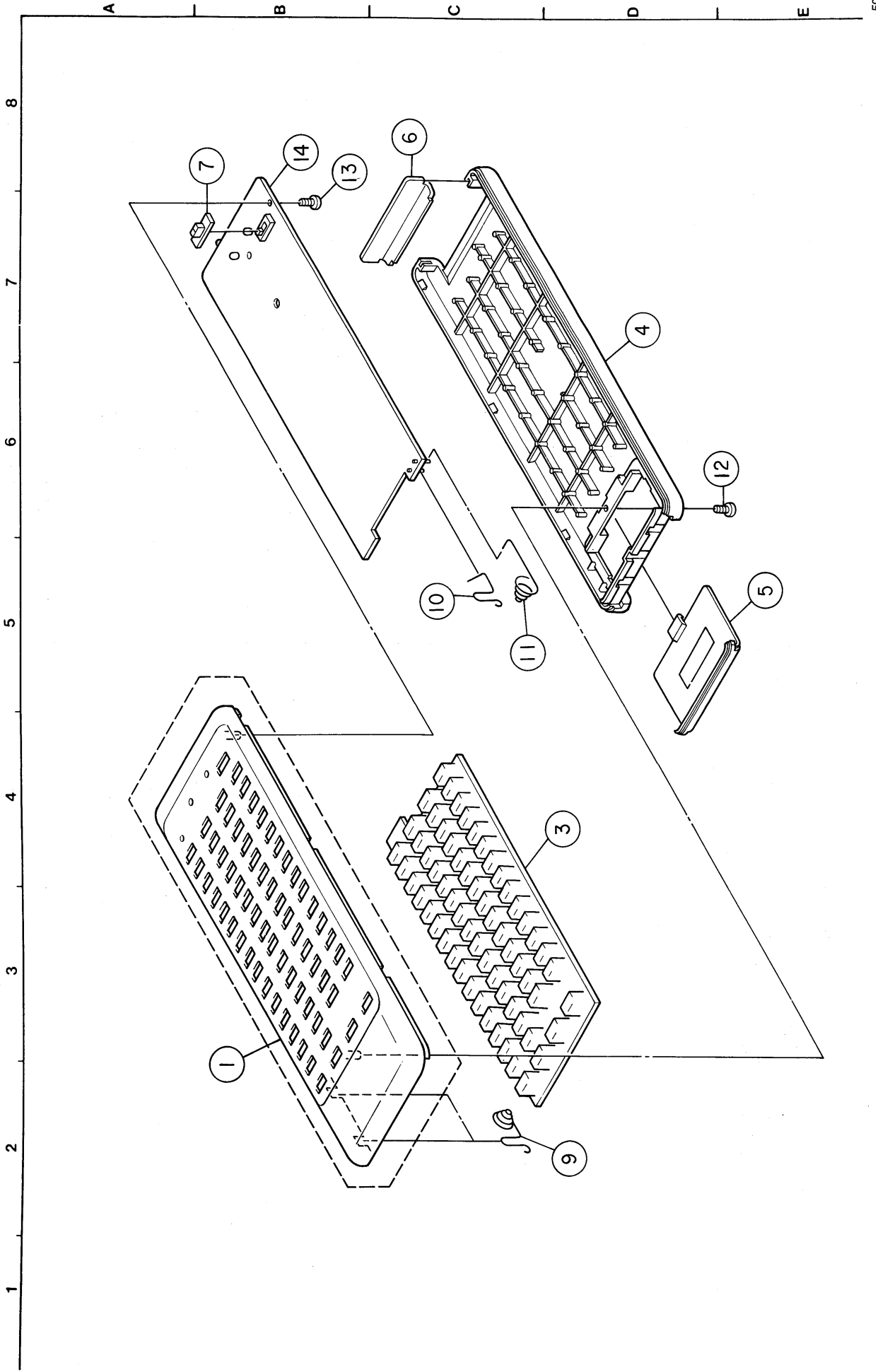

REMOTE CONTROL UNIT ASS'Y

PARTS LIST OF EXPLODED VIEW

KEY LAYOUT

Ref. No.	Part No.	Part Name	Remarks	Qty
SEMICONDUCTORS GROUP				
IC1	9H3 1000 157	IC LPD1703AGC-701	µ-Com	
IC2	9H3 1000 158	IC RH5VA20AA	VOL. Detector	
TR1	9H3 1000 070	Transistor 2SC3443BF6G	Chip	
	9H3 1000 070	Transistor 2SC2922BC	Chip	
D1,2	9H3 1000 028	LED TLRY24	Visible-Red	
D3	9H3 1000 131	LED SE1003-C	Infrared	
D5	9H3 1000 087	Diode 1SS233 (1)		
D6	9H3 1000 029	Diode PH410	Photo-PIN	
D7	9H3 1000 071	Diode DA119.DA118	Chip	
Or	9H3 1000 156	Diode 1SS196		
RESISTORS GROUP				
R1,2	247 0006 988	Chip Resistor 560ohm, 1/10W	RM73B-561J	
R4	247 0001 909	Chip Resistor 2.2ohm, 1/10W	RM73B-2R2J	
R6	247 0005 989	Chip Resistor 220ohm, 1/10W	RM73B-221J	
R7	247 0012 927	Chip Resistor 100kohm, 1/10W	RM73B-104J	
R8	247 0012 914	Chip Resistor 91kohm, 1/10W	RM73B-913J	
R9	247 0009 901	Chip Resistor 4.7kohm, 1/10W	RM73B-472J	
R10	247 0012 901	Chip Resistor 82kohm, 1/10W	RM73B-823J	
R11	247 0009 989	Chip Resistor 2kohm, 1/10W	RM73B-333J	
R12	247 0011 902	Chip Resistor 33kohm, 1/10W	RM73B-333J	
R13	247 0009 901	Chip Resistor 4.7kohm, 1/10W	RM73B-472J	
J7,8	247 0018 905	Chip Resistor 10ohm, 1/10W	RM73B-0R0K	
CAPACITORS GROUP				
C1	254 4213 034	Electrolytic 100µF±6.3V	C54W0101M	
C2	—	Chip Ceramic 0.33µF±25V	CK73P-TE64Z	
C3	254 4213 021	Electrolytic 47µF±6.3V	CE4W0470M	
C4	257 0014 935	Chip Ceramic 0.1µF±25V	CK73P-1E104Z	
C5,6	257 0003 946	Chip Ceramic 33PF±50V	CK73S-1H830J	
C7	257 0014 935	Chip Ceramic 0.1µF±25V	CK73P-1E104Z	
C8	257 0004 961	Chip Ceramic 100PF±50V	CC73SL1H10J	
OTHER GROUP				
X1	9H3 1000 088	(P.W. Board)		(1)
SW1	9H3 1000 089	Ceramic Resonator	KBR4.0M503	1
	—	Slide Switch		1
	—	Port Wrapping		2

Ref. No.	Part No.	Part Name	Remarks	Qty
1	9H3 1000 145	Case Top Assy		1
2	9H3 1000 148	Switch Rubber		1
3	9H3 1000 145	Case Bottom Assy		1
4	9H3 1000 147	Cover Battery		1
5	9H3 1000 148	IR Filter		1
6	9H3 1000 150	Switch Button		1
7	—	—		1
8	9H3 1000 153	Spring Coil		1
9	9H3 1000 151	Spring Coil		1
10	9H3 1000 152	Spring Coil		1
11	9H3 1000 154	Tapping Screw 2x6		1
12	9H3 1000 155	Tapping Screw 2x5		1
13	9H3 1000 156	P.W. Unit Assy		1
14	—	Label		4 ³
15	—	Sheet		1
16	—	Sheet		1

↑ Transmitting direction (upper side)

K5	K6	K7	K8
K13	K14	K15	K16
K21	K22	K23	K24
K29	K30	K31	K32
K37	K38	K39	K40
K45	K46	K47	K48
K53	K54	K55	K56
K61	K62	K63	K64
K57	K58	K59	K60
K49	K50	K51	K52
K41	K42	K43	K44
K33	K34	K35	K36
K25	K26	K27	K28
K17	K18	K19	K20
K9	K10	K11	K12
K1	K2	K3	K4

NOTE FOR PARTS LIST

- Part indicated with the mark "⊙" are not always in stock and possibly to take a long period of time for supplying, or in some case supplying of part may be refused.
- When ordering of part, clearly indicate "1" and "1" (1) to avoid mis-supplying.
- Ordering part without stating its part number can not be supplied.
- Part indicated with the mark "✳" is not illustrated in the exploded view.

WARNING:

Parts marked with this symbol  have critical characteristics. Use ONLY replacement parts recommended by the manufacturer.