

DENON

Hi-Fi AV Surround Receiver

SERVICE MANUAL

MODEL AVR-800

AV SURROUND RECEIVER



CONTENTS

OPERATING INSTRUCTIONS (U.S.A. & CANADA MODELS)	2-15
OPERATING INSTRUCTIONS (EUROPE MODEL)	16-30
WIRE ARRANGEMENT	32
DISASSEMBLY	33
ADJUSTMENT	34-37
SEMICONDUCTORS	38-45
PRINTED WIRING BOARD	46-48
PRINTED WIRING BOARD PARTS LIST	49-58
BLOCK DIAGRAM	59
WIRING DIAGRAM	60
SCHEMATIC DIAGRAM	61-63
EXPLODED VIEW OF CHASSIS AND CABINET	64
PARTS LIST OF EXPLODED VIEW	64
REMOTE CONTROL UNIT	65
PARTS LIST	65
SCHEMATIC DIAGRAM	65
CORDS TABLE	66

NIPPON COLUMBIA CO., LTD.

(U.S.A. AND CANADA MODELS.) SPECIFICATIONS

- **Audio Section**

(Power amplifier)
Rated output: (All properties shown are only for the power amplifier stage.)

for North America model
Front (main 2ch driven)
60 W + 60 W (8 ohms, 20 Hz – 20 kHz with 0.08% THD)
CENTER (center 1ch driven)
60 W (8 ohms, 20 Hz – 20 kHz with 0.08% THD)
REAR (rear 2ch driven)
15 W + 15 W (8 ohms, 1 kHz with 0.3% THD)

Output terminals:
Front: 6 to 16 ohms
Center: 8 to 16 ohms
Rear: 8 to 16 ohms

Line input (Each line input – FRONT SP OUT)
Input sensitivity / impedance: 150 mV / 47 k ohms PHONO (MM): 2.5 mV / 47 kohms
Frequency response: 10 Hz to 50 kHz: ±3 dB
Tone control range: BASS: ±10 dB at 100 Hz
TREBLE: ±10 dB at 10 kHz

Signal-to-noise ratio 92 dB (BYPASS)
Phono equalizer (PHONO input – REC OUT)
RIAA deviation: ±1 dB (20 Hz to 20 kHz)
Signal-to-noise ratio: 74 dB (A weighting, with 5 mV input)
Rated output / Maximum output: 150 mV / 8 V
Distortion factor: 0.03% (1 kHz, 1 V)
- **Tuner Section**

[FM] (note: μV at 75 ohms, 0 dBf = 1×10^{-15} W)
Receiving Range: 87.5 MHz ~ 108.0 MHz (for North America model)
87.50 MHz ~ 108.00 MHz (for multi-voltage model)
Usable Sensitivity: 1.0 μV (11.2 dBf)
50 dB Quieting Sensitivity: MONO 1.6 μV (15.3 dBf)
STEREO 23 μV (38.5 dBf)
Signal to Noise Ratio (IHF-A): MONO 80 dB
STEREO 75 dB
Total Harmonic Distortion (at 1 kHz): MONO 0.15%
STEREO 0.3%

[AM]
Receiving Range: 520 kHz ~ 1710 kHz (for North America model)
522 kHz ~ 1611 kHz (for multi-voltage model)
Usable Sensitivity: 18 μV
Signal to Noise Ratio: 50 dB
- **Video Section**

Standard video jacks
Input and output level / impedance: 1 Vp-p / 75 ohms
Frequency response: 2 Hz to 8 MHz +0, -3 dB
- **General**

Power supply: AC 120 V, 60 Hz (for North America model)
AC 110/220 V, 50/60 Hz (for multi-voltage model)
Power consumption: 4.0 A (for North America model)
W (for multi-voltage model)
Maximum external dimensions: 434 (W) × 142 (H) × 325 (D) mm (17-3/32" × 5-19/32" × 12-51/64")
Weight: 9.1 kg (20 lbs 1 oz)
- **Remote control unit**

System remote control
RC-169:

Total buttons:	36
DENON system code	
CD player:	6 buttons
Cassette deck:	6 buttons
AVR-800 fixed codes:	24 buttons
Batteries:	R6P/AA Type (two batteries)
External dimensions:	55 (W) × 18 (H) × 180 (D) mm (2-11/64" × 45/64" × 7-3/32")
Weight:	110 g (Approx. 4 oz) (including batteries)

* For purposes of improvement, specifications and design are subject to change without notice.

1 INTRODUCTION
SAFETY PRECAUTIONS

CAUTION
RISK OF ELECTRIC SHOCK
DO NOT OPEN

CAUTION: TO REDUCE THE RISK OF ELECTRIC SHOCK, DO NOT REMOVE COVER (OR BACK). NO USER SERVICE-ABLE PARTS INSIDE. REFER SERVICING TO QUALIFIED SERVICE PERSONNEL.

The lightning flash with arrowhead symbol, within an equilateral triangle, is intended to alert the user to the presence of uninsulated "dangerous voltage" within the product's enclosure that may be of sufficient magnitude to constitute a risk of electric shock to persons.

The exclamation point within an equilateral triangle is intended to alert the user to the presence of important operating and maintenance (servicing) instructions in the literature accompanying the appliance.

WARNING: TO REDUCE THE RISK OF FIRE OR ELECTRIC SHOCK, DO NOT EXPOSE THIS APPLIANCE TO RAIN OR MOISTURE.

CAUTION

TO PREVENT ELECTRIC SHOCK DO NOT USE THIS (POLARIZED) PLUG WITH AN EXTENSION CORD, RECEPTACLE OR OTHER OUTLET UNLESS THE BLADES CAN BE FULLY INSERTED TO PREVENT BLADE EXPOSURE.

ATTENTION

POUR PREVENIR LES CHOCs ELECTRIQUES NE PAS UTILISER CETTE FICHE POLARISEE AVEC UN PROLONGATEUR UNE PRISE DE COURANT OU UNE AUTRE SORTIE DE COURANT, SAUF SI LES LAMES PEUVENT ETRE INSEREES A FOND SANS EN LAISSER AUCUNE PARTIE A DECOUVERT.

SAFETY INSTRUCTIONS

1. Read Instructions – All the safety and operating instructions should be read before the appliance is operated.
2. Retain Instructions – The safety and operating instructions should be retained for future reference.
3. Heed Warnings – All warnings on the appliance and in the operating instructions should be adhered to.
4. Follow Instructions – All operating and use instructions should be followed.
5. Water and Moisture – The appliance should not be used near water – for example, near a bathtub, washbowl, kitchen sink, laundry tub, in a wet basement, or near a swimming pool, and the like.
6. Carts and Stands – The appliance should be used only with a cart or stand that is recommended by the manufacturer.
- 6A. An appliance and cart combination should be moved with care. Quick stops, excessive force, and uneven surfaces may cause the appliance and cart combination to overturn.
7. Wall or Ceiling Mounting – The appliance should be mounted to a wall or ceiling only as recommended by the manufacturer.
8. Ventilation – The appliance should be situated so that its location or position does not interfere with its proper ventilation. For example, the appliance should not be situated on a bed, sofa, rug, or similar surface that may block the ventilation openings; or placed in a built-in installation, such as a bookcase or cabinet that may impede the flow of air through the ventilation openings.
9. Heat – The appliance should be situated away from heat sources such as radiators, heat registers, stoves, or other appliances (including amplifiers) that produce heat.
10. Power Sources – The appliance should be connected to a power supply only of the type described in the operating instructions or as marked on the appliance.
11. Grounding or Polarization – Precautions should be taken so that the grounding or polarization means of an appliance is not defeated.
12. Power-Cord Protection – Power-supply cords should be routed so that they are not likely to be walked on or pinched by items placed upon or against them, paying particular attention to cords at plugs, convenience receptacles, and the point where they exit from the appliance.
14. Cleaning – The appliance should be cleaned only as recommended by the manufacturer.
15. Power Lines – An outdoor antenna should be located away from power lines.
16. Outdoor Antenna Grounding – If an outside antenna is connected to the receiver, be sure the antenna system is grounded so as to provide some protection against voltage surges and built-up static charges. Article 810 of the National Electrical Code, ANSI/NFPA 70, provides information with regard to proper grounding of the mast and supporting structure, grounding of the lead-in wire to an antenna-discharge unit, size of grounding conductors, location of antenna-discharge unit, connection to grounding electrodes, and requirements for the grounding electrode. See Figure A.
17. Nonuse Periods – The power cord of the appliance should be unplugged from the outlet when left unused for a long period of time.
18. Object and Liquid Entry – Care should be taken so that objects do not fall and liquids are not spilled into the enclosure through openings.
19. Damage Requiring Service – The appliance should be serviced by qualified service personnel when:
 - A. The power-supply cord or the plug has been damaged; or
 - B. Objects have fallen, or liquid has been spilled into the appliance; or
 - C. The appliance has been exposed to rain; or
 - D. The appliance does not appear to operate normally or exhibits a marked change in performance; or
 - E. The appliance has been dropped, or the enclosure damaged.
20. Servicing – The user should not attempt to service the appliance beyond that described in the operating instructions. All other servicing should be referred to qualified service personnel.

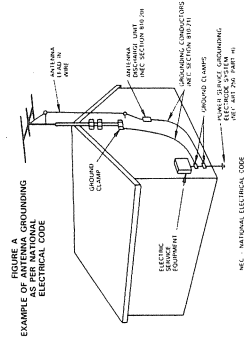

NOTE ON USE

Be careful of high temperatures

- Do not place the set in a location where it will be exposed to direct sunlight or near a heating appliance.

Caution on rack/cabinet installation

- Avoid installing the set in a closed-type rack.
- When installing in a rack or cabinet, provide a sufficiently large ventilation opening to promote heat radiation.

Caution on humidity, water, and dust

- Do not place the set in a location where there is high humidity or a lot of dust.
- Flower vases or other items containing water should not be placed on top of the set.

Do not open the case

- Opening the top cover or the bottom plate of the case and inserting your hand is dangerous. Do not open the case.
- If some trouble arises with the performance of the set, remove the power plug soon and contact the store where the set was purchased or a nearby dealer.

Care of the case

- Avoid the use of pesticides near the set as well as wiping the case with benzene, thinner or other solvents since they may cause a change in quality or color. Use a soft cloth when wiping away dirt and follow the instructions carefully when using chemically treated cloths.

Care with the power cord

- When removing the plug from the receptacle, do not pull the power cord; be sure to hold the plug when removing it.

During your absence

- When not using the set for an extended period such as when taking a trip, be sure to disconnect the plug from the receptacle.

Do not allow foreign matter into the equipment

- Be especially careful of needles, hair pins, and coins getting into the set.

Do not block the ventilation holes of the set

- Blocking of the ventilation holes will lead to damage of the set.
- The ventilation holes are very important for heat radiation from within the set. Care must be taken since placing an object against the holes will result in an extreme rise of temperature within the set.

For sets with ventilation holes

■ We greatly appreciate your purchase of the AVR-800.
 ■ To be sure you take maximum advantage of all the features the AVR-800 has to offer, read these instructions carefully and use the set properly. Be sure to keep this manual for future reference should any questions or problems arise.

ACCESSORIES

Check that the following parts are included in addition to the main unit:

- ① Operating instructions 1
- ② Warranty (for North American model only) 1
- ③ Remote control unit (RC-169) 1
- ④ RP/AA batteries 2
- ⑤ AM loop antenna 1
- ⑥ FM indoor antenna 1

INSTALLATION PRECAUTIONS

Using this receiver or other electronic equipment containing microprocessors simultaneously with a tuner or TV may result in noise in the sound or picture.

If this should happen, take the following steps:

- Install the receiver as far as possible from the tuner or TV set.
- Keep the antenna lines of the tuner or TV as far as possible from the receiver's power cord and connection cables.
- This problem is especially frequent when using indoor antennas or 300 ohm feeder lines. We recommend using outdoor antennas and 75 ohm coaxial cables.

A note on stacking

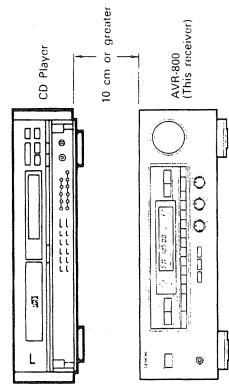

For cooling purposes, do not place another AV component directly on top of the receiver. Be sure to leave a space of at least 10 cm.

TABLE OF CONTENTS

1 Introduction	2-4	11 Listening to the Radio	18, 19
• Safety Precautions	2	12 Surround Playback	20-25
• Safety Instructions	3	• Surround Modes	20
• Note on Use	4	• Using Dolby Pro Logic Surround	20-23
2 Names of Parts - 1		• Other Surround Modes	23
(Front Panel and Remote Control Unit)	6	• Using the Personal Memory	24
3 Multi Function Display (MFD)	7	• Operations Possible in the Various Surround Modes	25
4 Names of Parts - 2 (Rear Panel)	8-9	Initialization of the Microprocessor	25
5 Remote Control Unit	10	13 Troubleshooting	26
6 Connections	11-14	15 Last Function Memory	26
7 Playback	15, 16	16 Specifications	27
8 Recording	16	DENON SERVICE NETWORK	Bottom
9 Tape Monitor Function	17		
10 Using Headphones	17		

2 NAMES OF PARTS - 1
(Front Panel and Remote Control Unit)

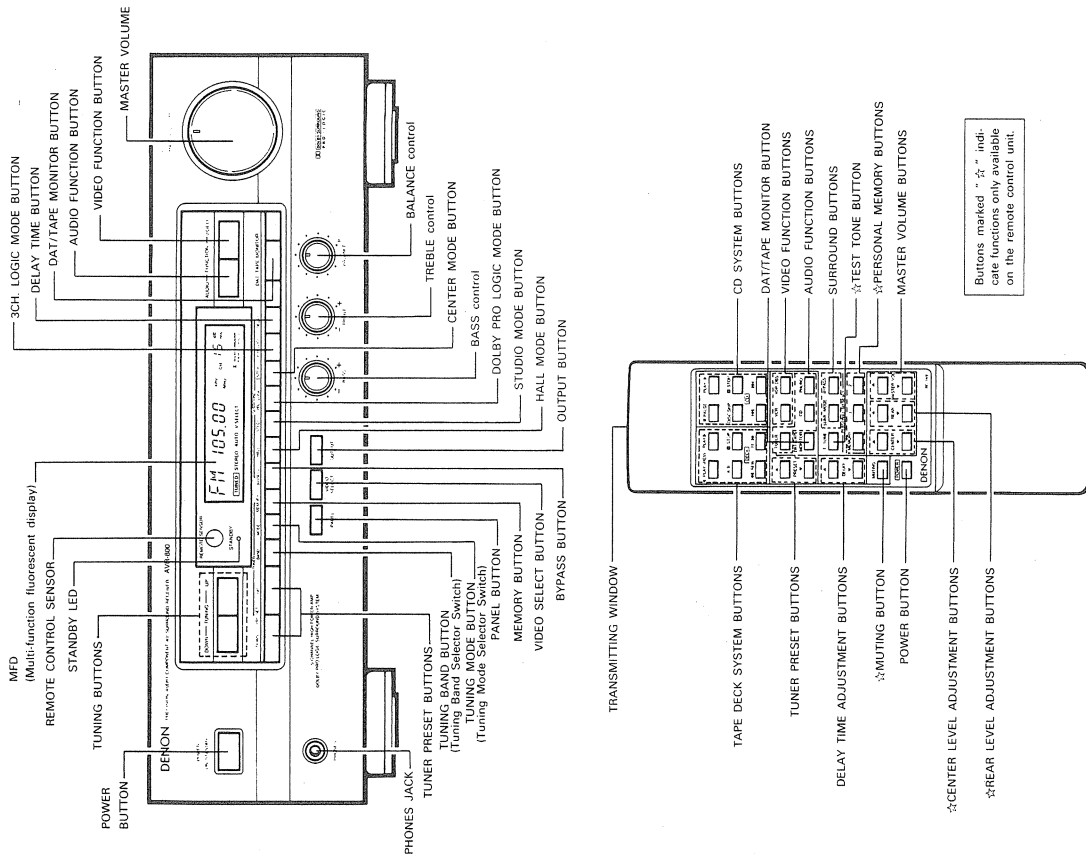

3 MULTI FUNCTION DISPLAY (MFD)

The MFD indicates the operating modes when operations are performed and when PANEL button is pressed.

■ FLD (Fluorescent Light Display)

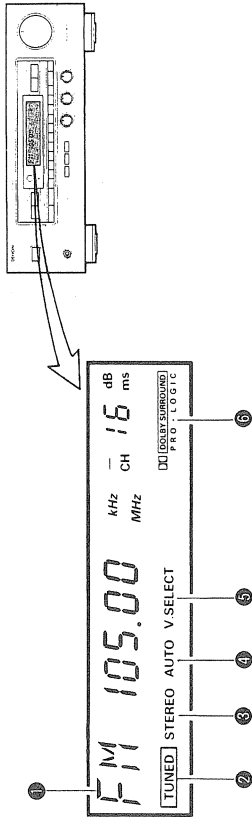

1 MULTI FUNCTION DISPLAY

Normally, the reception frequency is displayed when the function is set to tuner, and the surround mode is displayed when the function is set to other positions. The display also indicates various other information according to the buttons pressed.

4 AUTO TUNING (AUTO TUNING Indicator)

This indicator lights when the auto tuning mode is selected by pressing the TUNING MODE button.

5 V. SELECT (VIDEO SELECT Indicator)

This indicator lights when the video monitor output is fixed in the video select mode.

6 DOLBY SURROUND Indicator

This indicator lights when DOLBY PRO LOGIC, 3CH, LOGIC are selected.

2 TUNED (TUNED indicator)

This indicator lights when broadcast signals are received.

3 STEREO (Stereo Indicator)

The STEREO indicator will automatically light up when a stereo broadcast is received.

■ To check the settings of the different modes

1. Press the PANEL button.

Either hold the PANEL button in or press it repeatedly to display the settings for the different modes.

■ FLD OFF

Turning the FLD off.

1. Press and hold in the PANEL button.

The FLD display changes continuously and finally turns off. Now when a button is pressed, the related display appears for a few seconds then turns off automatically.

2. Turning the FLD back on.

Press the PANEL button once again.

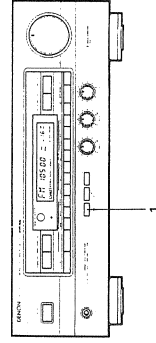

4 NAMES OF PARTS - 2 (Rear Panel)

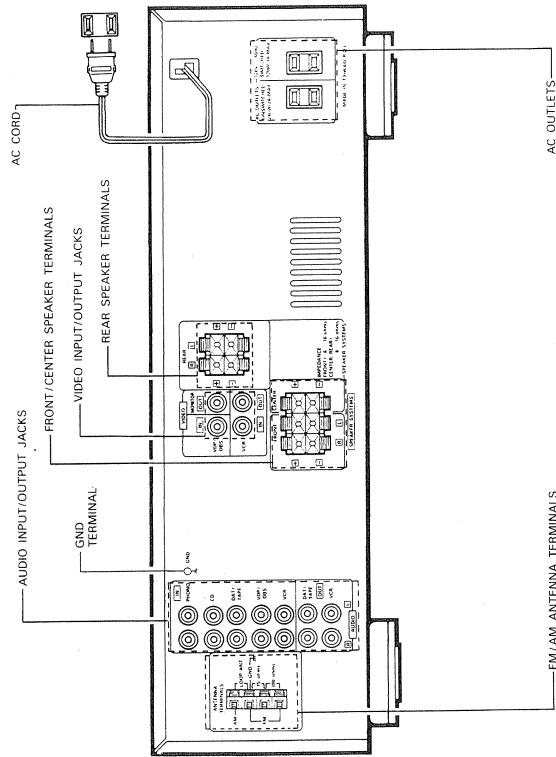

MULTI-VOLTAGE MODEL ONLY

Make the following settings before connecting the components.

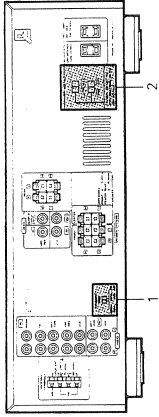

1. Setting the frequency step

- Set the **FREQUENCY STEP** switch as described below.
- In the U.S.A. and Canada - set the switch to 100 kHz / 10 kHz side.
 - With this setting, the frequency varies in 100 kHz steps in the range of 87.5 to 108.0 MHz (FM) and in 10 kHz steps in 520 to 1710 kHz (AM).
 - Elsewhere - set the switch to 50 kHz / 9 kHz side.
 - With this setting, the frequency varies in 50 kHz steps in the range of 87.50 to 108.0 MHz (FM) and in 9 kHz steps in 522 to 1611 kHz (AM).

Only switch the frequency when the power cord is unplugged. Plug in the power cord securely after switching the frequency.

2. Setting the line voltage

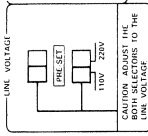

- The customer can set the **VOLTAGE SELECTORS** on the back panel for appropriate line voltage by using a screwdriver.
- Do not use excessive force in setting the **VOLTAGE SELECTOR KNOB** - you may damage it.
- If the **VOLTAGE SELECTOR KNOB** does not turn smoothly, contact your store of purchase.
- Be sure to set both voltage selectors to same position.

AC OUTLETS

- Always turn off the power of the various components when making connections. Also refer to the operating instructions for the other components.
- Do not plug in the power cord until all connections are completed.

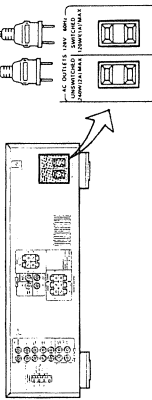

NOTE: Only use the AC outlets for audio equipment. Never use them for hair driers, TVs or other electrical appliances.

Connecting the AC Outlets

- AC Outlets**
- SWITCHED** (total capacity - 120W (1A))
- The power to this outlet is turned on and off in conjunction with the **POWER** switch on the AVR-800, and when the power is switched between on and standby from the remote control unit. No power is supplied from these outlets when the AVR-800's power is at standby. Never connect equipment whose total capacity is above 120W (1A).
- STANDBY** (total capacity - 240W (2A))
- Power is supplied from this outlet constantly, regardless of whether or not the AVR-800's power is on. Never connect equipment whose total capacity is above 240W (2A).

5 REMOTE CONTROL UNIT

Following the procedure outlined below, insert the batteries before using the remote control unit.

Range of operation of the remote control unit

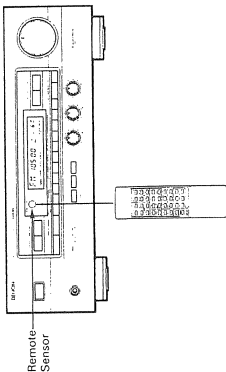

Inserting the batteries

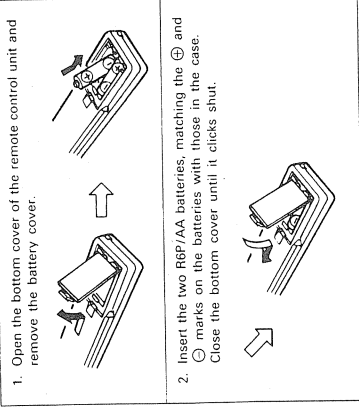

System codes

The system codes for Denon tape decks and CD players are set in this remote control unit.

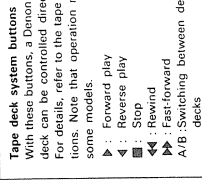

6 CONNECTIONS

Connecting the antenna terminals

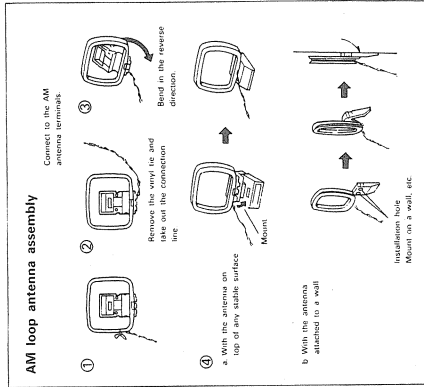

ANTENNA INSTALLATION

FM ANTENNA
The supplied T-type indoor FM antenna (300 ohms) is designed for use in houses for receiving local FM stations and other strong FM signals. Stretch out the ends of the antenna and mount the antenna on the wall or ceiling, where optimum reception is achieved. FM T-type antennas may not consistently ensure stable reception, due to environment changes. In such cases, the FM T-type antenna should only be used temporarily until an outdoor FM antenna has been installed.

When connecting an outdoor FM antenna, the use of 75-ohm coaxial cable (3C-2V, 5C-2V) is strongly recommended. Using a 300-ohm feeder cable will cause noise and you will not be able to achieve the high sound quality the built-in tuner is capable of.

AM ANTENNA

Assemble the included AM loop antenna as shown in the diagram, then place it in a position where reception is good. In some cases reception is better if the polarities are inverted. AM broadcasts will not be received well if the loop antenna is not connected or if it is connected but near a metal part.

Attach the loop antenna even when using an outdoor AM antenna.

Adjust the loop antenna to obtain optimum reception. Where broadcast stations are distant and only weak signals are received, or where signals are blocked, it is best to install an outdoor AM antenna.

NOTES

- The receiver has a full lock-up system. When the power is turned on, the INPUT SELECTOR buttons are set to the last mode set before the power was turned off.
- When using this receiver in close proximity to video equipment (TV, VCR, VDP, etc.), noise may be generated in AM broadcasts. To avoid this, keep the receiver as far away from other video components as possible. If the noise is not reduced, turn off the power of the video components when listening to AM broadcasts.

Note to CATV system installer

This reminder is provided to call the CATV system installer's attention to Article 820-40 of the NEC which provides guidelines for proper grounding and, in particular, specifies that the cable ground shall be connected to the grounding system of the building, as close to the point of cable entry as practical.

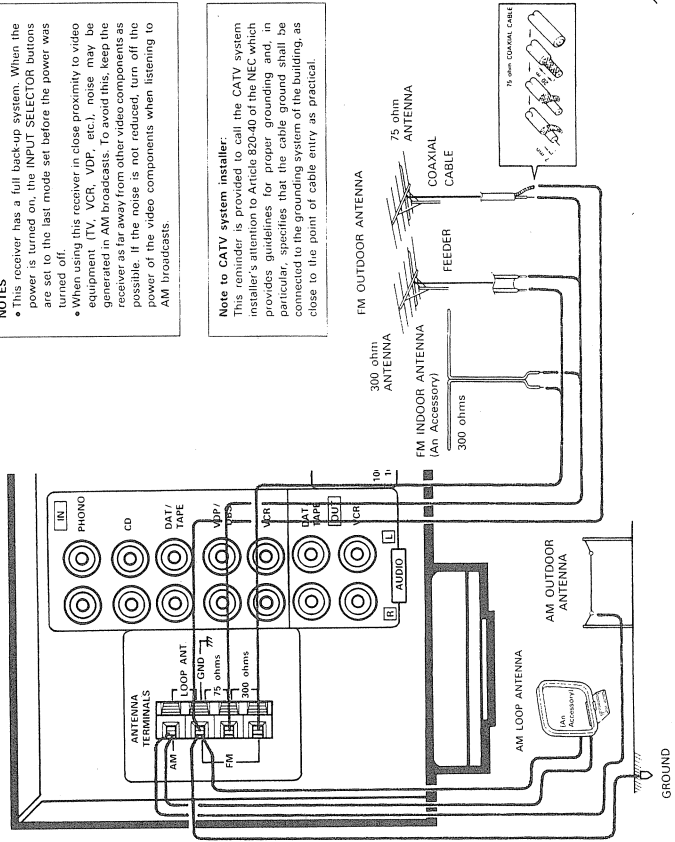

→ Continued

→ Continued

Video Section

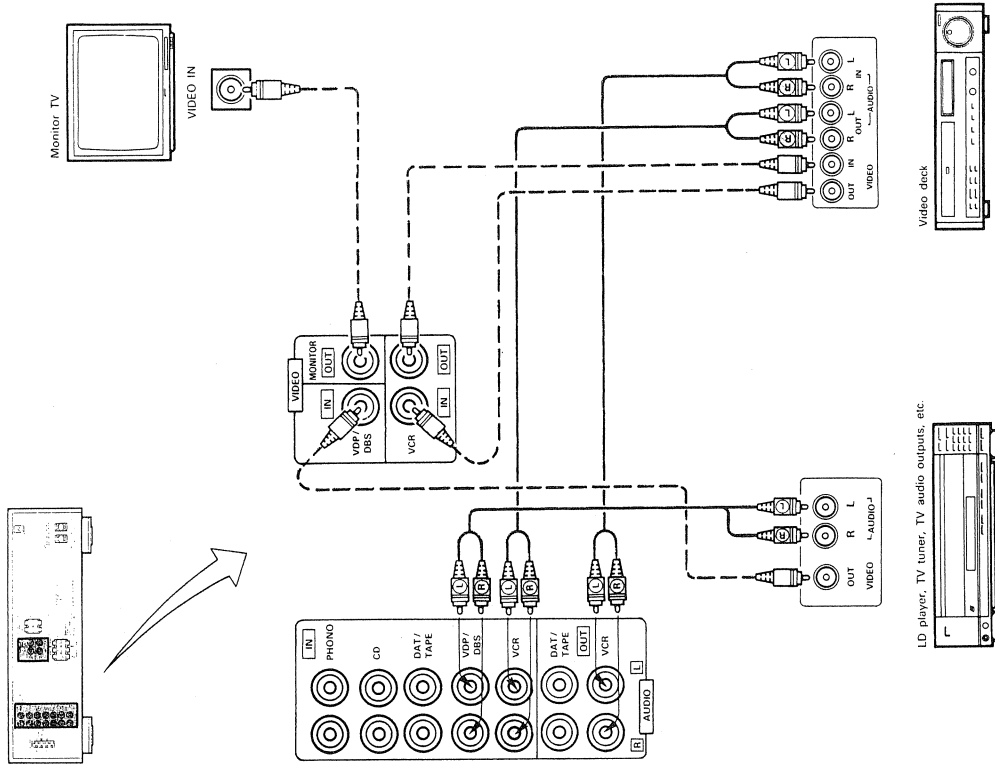

Audio Section

- Do not plug in the power cord until all connections have been completed.
- Be sure to connect the left and right channels properly (left with left, right with right).
- Insert the plugs securely. Incomplete connections will result in the generation of noise.
- Note that binding pin plug cords together with power cords or placing them near a power transformer will result in the introduction of hum or other noise.
- If hum or other noise is produced when the ground wire is connected, disconnect it.
- Noise or humming may be generated if a connected component is used independently, without turning the power of the AVR 800 on. If this happens, turn on the power of the AVR 800.

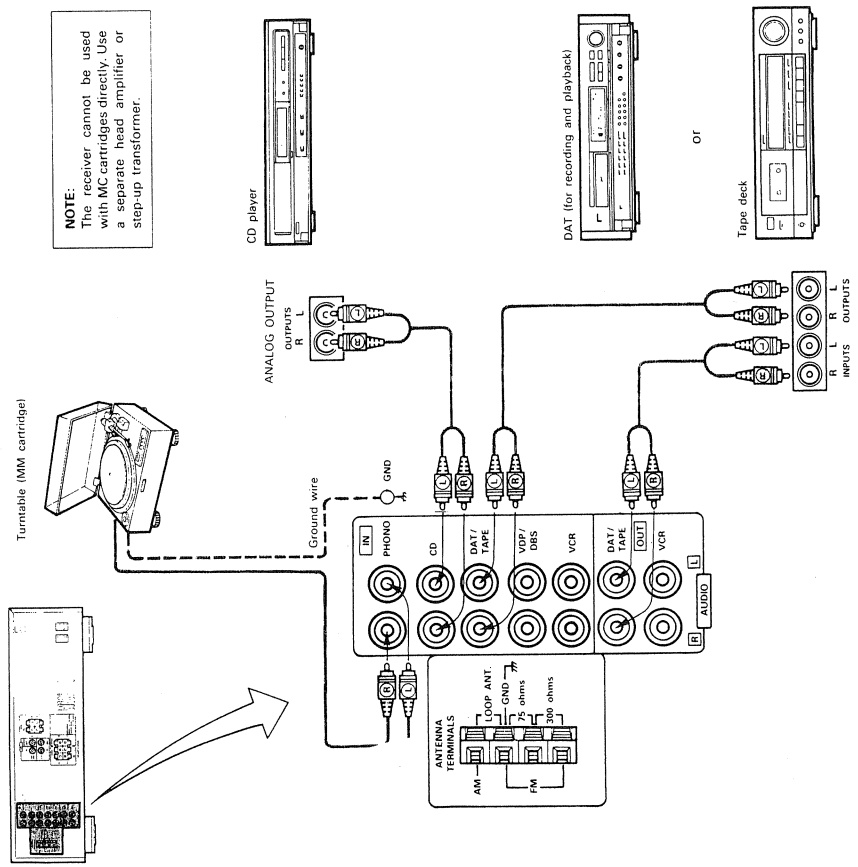

NOTE:
The receiver cannot be used with MC cartridges directly. Use a separate head amplifier or step-up transformer.

→ Continued

Speaker System Connections

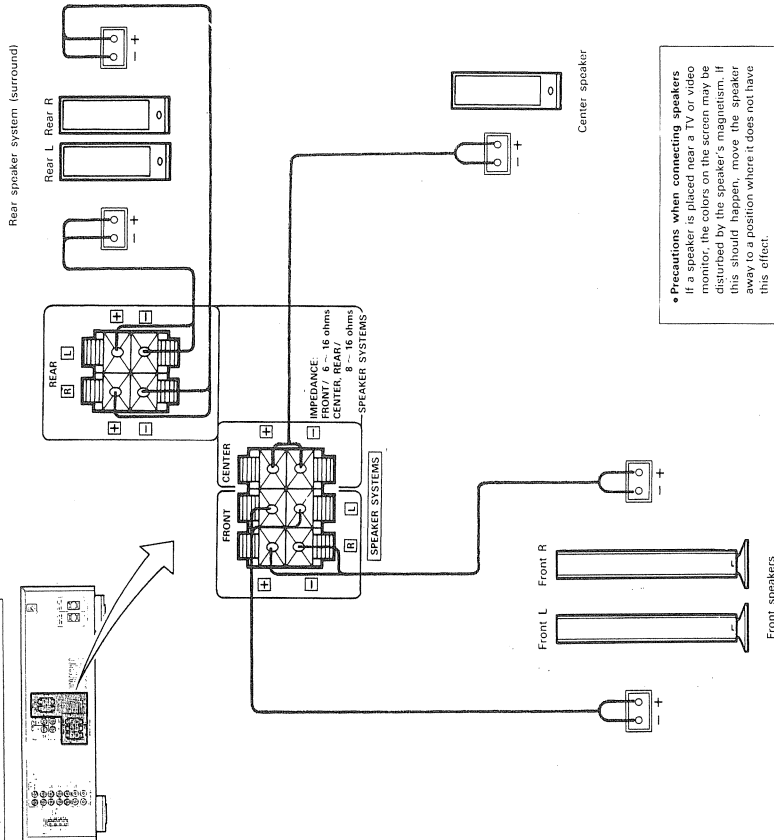

- This receiver can accommodate connections of a total of five speakers including one set of front speakers, one set of rear speakers, and one center speaker.
- Connect the speaker terminals with the speakers making sure that like polarities are matched (⊕ with ⊕, ⊖ with ⊖). Mismatching of polarities will result in weak central sound, unclear orientation of the various instruments, and the sense of direction of the stereo being impaired.
- When making connections, take care that none of the individual conductors of the speaker cord come in contact with adjacent terminals, with other speaker cord conductors, or with the rear panel.
- **Speaker impedance**
 - Speakers with an impedance of 6 to 16 ohms can be connected for use as front speakers 8 to 16 ohms can be connected for use as center and rear speakers.
 - Using speakers with an impedance other than the specified one may result in damage. Be sure to use speakers of the specified impedance.

Preparing the cord

1. Peel off the sheath.
2. Twist the wires.

Connecting the center and rear speaker terminals.

1. Press the lever.
2. Insert the cord and release the lever.

7 PLAYBACK

Preparations for Playback

- Check the connections
- Check that all connections are proper, referring to the connections diagrams (pages 10 to 14).

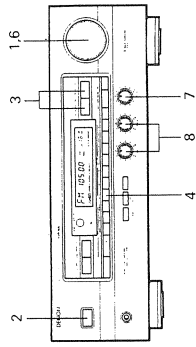

Playing the program source (normal stereo playback)

<p>1. Set the MASTER VOLUME control to the minimum.</p>	<p>2. Press the POWER button to turn the power on.</p> <p>The muting mode is set for several seconds, after which the STANDBY LED flashes for several seconds.</p>	<p>3. Select the source to be played.</p> <p>Audio function button</p> <p>Example:</p> <p>The source switches as shown above MFD.</p>	<p>4. Press the BYPASS button.</p>	<p>5. Start playback the source.</p> <p>For instructions, refer to the source's operating instructions.</p> <p>Remote control unit</p>	<p>6. Adjust the volume.</p> <p>Turn the control clockwise to increase the volume, counterclockwise to decrease it.</p> <p>Press the button to increase the volume, the button to decrease it.</p> <p>Remote control unit</p>	<p>7. Adjust the left/right balance.</p> <p>Turn the control counterclockwise to reduce the volume of the right channel, clockwise to reduce the volume of the left channel.</p>	<p>8. Adjust the tone.</p> <p>Turn the control clockwise to increase the treble, counterclockwise to decrease it.</p> <p>Turn the control clockwise to increase the bass, counterclockwise to decrease it.</p>
---	--	--	------------------------------------	---	--	--	--

NOTE:
The sound may be interrupted if switches are operated during playback. This is because the muting circuit is activated to prevent switching noise.

■ Simulcast playback (playing different video and audio sources simultaneously)

1. Follow steps 1 to 3 under "Playing the program source".

2. Press the VIDEO SELECT button until the desired video source is displayed on the MFD.

The source switches as shown above.

3. Follow steps 4 to 8 under "Playing the program source".

2

Canceling simulcast playback

- Press the VIDEO SELECT button again.
- Press the video function button on the main unit or remote control unit.

■ Using the muting function

Use this to turn off the audio output temporarily.

1. Press the MUTING button.

This function can only be set from the remote control unit.

The STANDBY LED flashes when the muting function is set.

2. Press the MUTING button again.

The muting function is cancelled.

■ 9 TAPE MONITOR FUNCTION

■ When playing a DAT or tape deck

Use this function to switch between the DAT or tape deck and the input (source) selected with the audio or video function buttons.

1. Follow steps 1 and 2 under "Playing the program source".

2. Select the deck to be played.

The source switches as shown at the left.

3. Follow steps 5 to 8 under "Playing the program source".

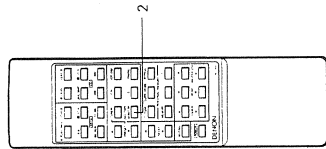
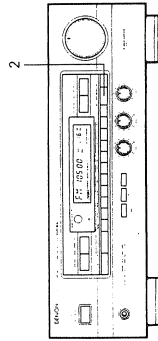

■ Monitoring the recording on a three-headed tape deck

The sound actually being recorded can be monitored during recording when a three-headed tape deck is used.

1. Select the deck to be monitored.

The source switches as shown at the left.

2. Follow steps 1 to 3 under "Playing the program source".

3. Start recording on the tape deck. For instructions, refer to the component's operating instructions.

4. Press the three-headed tape deck's source/tape button to monitor the recording.

NOTE:

- Also refer to the three-headed tape deck's operating instructions.

■ 8 RECORDING

■ Recording the program source (recording the source currently being monitored)

1. Follow steps 1 to 3 under "Playing the program source".

2. Start recording on the tape or video deck.

For instructions, refer to the component's operating instructions.

■ Simultaneous recording

The signals of the source selected with the function selector button are output simultaneously to the DAT/TAPE and VCR REC OUT jacks. If a total of two tape and/or video decks are connected and set to the recording mode, the same source can be recorded simultaneously on both decks. In addition, if the TAPE MONITOR (DAT/TAPE) button is pressed, the audio signals from the tape deck are output to the VCR AUDIO REC OUT jacks.

■ 10 USING HEADPHONES

The sound from the speakers can be turned off using the OUTPUT button to listen to the sound over the headphones only, for example at night.

1. Press the OUTPUT button.

"H/P ONLY" appears on the MFD.

2. Insert the headphones' plug into the headphones' jack.

■ Cancelling

Either press the OUTPUT button again or press the POWER button to turn off the power.

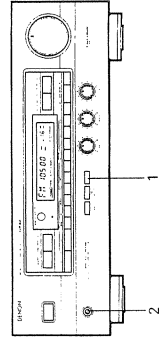

11 LISTENING TO THE RADIO

Tuning

1. Set the input function to "TUNER".



2. Select the reception band.

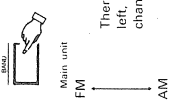

There is a change as mentioned at the left, and indication ① inside the MFD changes.

3. Select the tuning mode.

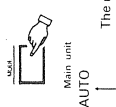

The mode switches as shown at the left. When the auto mode is set, "AUTO" lights on the MFD ④.

MANUAL
Set the auto mode for automatic tuning, the manual mode for manual tuning.

4. Tune in the station.

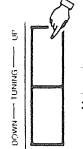

In the manual tuning mode:
Press the UP button once to increase the frequency by one step, the DOWN button once to decrease the frequency by one step.
The frequency changes continuously when the buttons are held in.
The "TUNED" indicator ② lights on the MFD when a station is tuned in.
In the auto tuning mode:
When the UP or DOWN button is pressed, automatic searching begins, and searching stops when a station is tuned in.

NOTES:

- When in the auto tuning mode on the FM band, the "STEREO" indicator ③ lights on the MFD when a stereo broadcast is tuned in. At open frequencies, the noise is muted and the "TUNED" ② and "STEREO" ③ indicators turn off.
- When the manual tuning mode is set, FM stereo broadcasts are received in monaural and the "STEREO" indicator ③ turns off.

Storing stations at the preset buttons

1. Follow steps 1 to 4 under "Tuning" to tune in a station.

2. Press the MEMORY button.

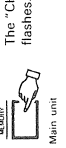

The "CH" indicator on the MFD flashes.

3. Select the preset channels.

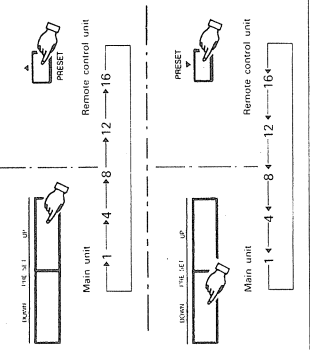

4. Press the MEMORY button that you want to store to memory.



NOTES:

- The preset memory standby mode is set for 10 seconds when the MEMORY button is pressed.
- The preset memory standby mode is cancelled if any button other than preset buttons, the MEMORY button is pressed.

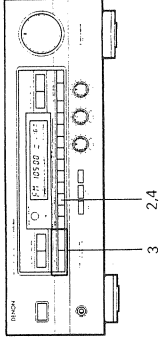

Recalling stations with the preset buttons

First store stations at the preset buttons using the above procedure.

3. Select the preset channels.

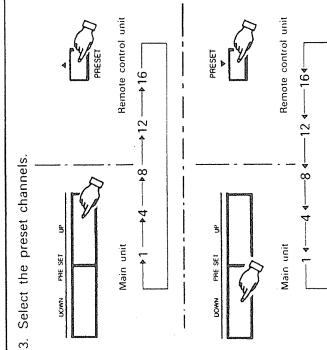
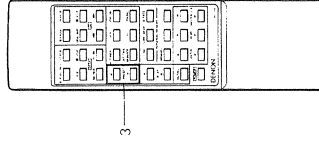
→ Continued

Center Mode

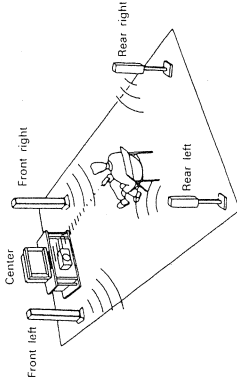

NORMAL mode

This mode is suited for an arrangement in which the center channel speaker is smaller than the left and right speakers. Signals below 100 Hz which have almost no effect on directional orientation are distributed to the left and right channels, whereas the center channel output signals greater than 100 Hz. As a result, the bass of the left and right channels increases the apparent depth of the sound.

PHANTOM mode

Use this mode when center channel speaker is not used. A directional emphasis circuit provides signal reproduction which is electrically oriented to the center and this provides an exciting sound field for your enjoyment.

WIDE mode

This mode is suited for an arrangement in which the center channel speaker is of the same grade as the left and right speakers. The entire sound band from low region to high is output to the center channel to provide an exciting sound field for your enjoyment.

Dolby 3CH. Logic (three-channel logic mode)

Select this mode when not using rear speakers.

<p>1. Set the Dolby Pro Logic mode.</p> Main unit	<p>2. Press the 3CH. LOGIC button.</p> Remote control unit
<p>3CH. LOGIC PRO LOGIC</p> <p>The mode changes as shown at the left.</p>	
<p>3. Select the center mode according to your speaker system.</p> Main unit	
<p>The mode changes as shown above.</p> <p>NORMAL → WIDE</p>	

3CH. LOGIC MODE

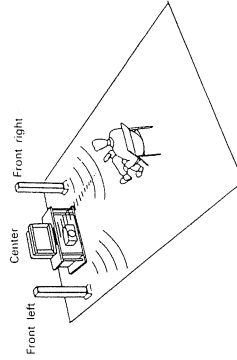

3CH. LOGIC mode

Use this mode when rear channel speakers are not used. The rear channel information is reproduced by the front speakers.

12 SURROUND PLAYBACK

SURROUND modes

The surround modes are as follows:

1	Dolby Pro Logic	Use this when playing program sources recorded in Dolby Surround or Dolby stereo.
2	HALL	Use this setting to create the atmosphere of a concert hall. There will be no output from the center speaker.
3	STUDIO	Use this setting to create the atmosphere of watching a live program in a studio. There will be no output from the center speaker.

• These effects may not be very pronounced for some sources.
 • To adjust the speaker balance for the different surround modes, first adjust for the Dolby Pro Logic Surround mode as explained on page 23, then use the position of the center level and rear level controls at this time as a guide to adjust the balance for that surround mode.

Manufactured under license from Dolby Laboratories Licensing Corporation. Additionally licensed under one or more of the following patents: U.S. number 3,959,590; Canadian numbers 1,004,603 and 1,037,877. "Dolby," "Pro Logic," and the double-D symbol are trademarks of Dolby Laboratories Licensing Corporation.

Using Dolby Pro Logic Surround

Speaker disposition and the Dolby Pro Logic Center mode

Ideally, center speakers should be used when playing sources in Dolby Pro Logic Surround. Select the center mode according to your speaker system.

<p>1. Set the Dolby Pro Logic mode.</p> Main unit	<p>2. Select the center mode.</p> Remote control unit
<p>The mode changes as shown above.</p> <p>NORMAL → PHANTOM</p>	

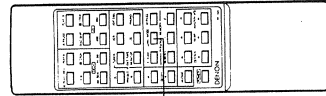
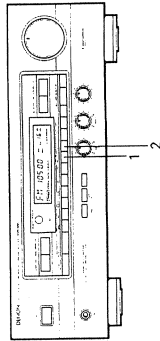

→ Continued

● **Speaker volume adjustment and Dolby Pro Logic mode**

To obtain the maximum surround effect, use the test tones to adjust the volume and balance of the speakers for the best balance for the listening position and so that the sound from all the speakers is heard at the same level. Set the master volume control to a suitable level, then adjust using the following procedure.

1. Press the T.TONE button.
 Test tones are produced from the speakers in the order shown below, at 4 second intervals for the first two cycles, 2 second intervals after that.
 For the Dolby 3CH Logic mode:
 → [FL] → [LC] → [FR] → [S] → [R]
 For the Dolby 3CH Logic mode:
 → [FL] → [LC] → [FR] → [R]
 2. To increase the level of the center speakers.
 CANCELLING
 Press the T.TONE button again.
3. To decrease the level of the center speakers.
4. To increase the level of the rear speakers.
5. To decrease the level of the rear speakers.
6. Press the T.TONE button again.

NOTES:

- The test tone will not move on to the next channel when it is being emitted from the center channel and the level of the center speakers is being adjusted, or when it is being emitted from the rear channel and the level of the rear speakers is being adjusted. It only moves on to the next channel approximately two seconds after the level key has been released.

■ **Other Surround Modes**

1. Set the HALL mode/STUDIO mode.
 HALL STUDIO
 Main unit
 SHIRL MODE
 Remote control unit
 HALL STUDIO DOLBY PRO LOGIC
 Remote control unit
2. Play the desired software.
3. Adjust the volume.
 MASTER VOL
 Main unit
 Remote control unit
4. Adjust the level of the center and rear channels. Adjust the levels according to the source, using the Dolby Pro Logic settings as reference.
5. Adjust the delay time as desired.

Listening position and optimum delay time for playback with Dolby Pro Logic surround

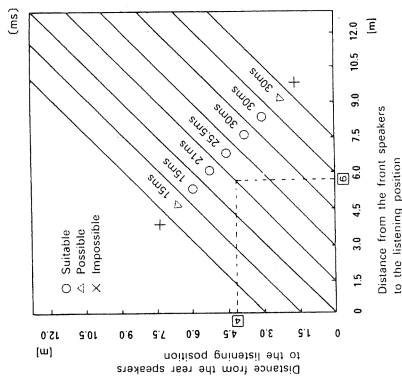

● **Setting the delay time**

The optimum delay time will differ depending on the listening position. Referring to the chart at right, set the optimum delay time for your room's space and seating position. For example, when the distance from the front speakers to the listening position is 6 m and that from the rear speakers to the listening position is 4 m, the optimum delay time will be 21 ms. The variable range of the delay time differs depending on the mode. For details about the variable range, see Page 25.

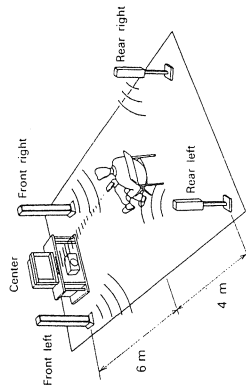

1. To increase the delay time.
 DELAY
 Main unit
 Remote control unit
2. To decrease the delay time.
 DELAY
 Remote control unit

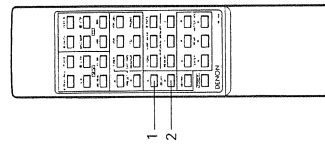
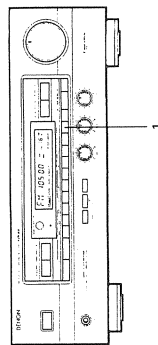

- Once the delay time is set, there is no need to readjust it unless you change the speaker system or the listening position.
- It is available to memorize the adjusted values of delay time and rear (center) level for each surround mode.

Using the Personal Memory

Surround mode settings and the input function can be stored at personal memory buttons "1" and "2", then recalled directly from any surround mode simply by pressing button "1" or "2".

1 Storing the setting in the personal memory

1. Set the desired surround mode and input function.
2. Press the personal memory button.

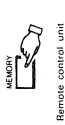

Remote control unit

(The memory setting mode is set and the indicator on the MFD flashes.)

3. Press the desired personal memory button ("1" or "2").

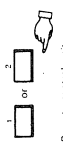

Remote control unit

4. "M 1 (2) SET" appears on the MFD indicating that the setting has been stored.

NOTE:

- The memory setting mode is set for 6 seconds. If any button other than personal memory button "1" or "2" is pressed, the memory setting mode is cancelled.

2 Recalling the personal memory

5. Press the personal memory button ("1" or "2") at which the desired setting was stored.

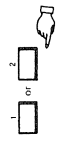

Remote control unit

6. The surround mode and input function switch automatically.

NOTES:

- Personal memory buttons "1" and "2" will not function during the tape monitor mode.
- The surround mode recalled with the PERSONAL MEMORY "1" or "2" button is the same as the mode selected with the surround mode button. Thus, if the parameters of the surround mode which was stored in the memory are cleared, when the mode is recalled it is set to the initial values.
- Upon shipment from the factory, the "DOLBY PRO LOGIC" mode is stored at personal memory "1", the "HALL" mode at personal memory "2". The input function is set to VDP/DBS for both "1" and "2".
- Do not press personal memory buttons "1" or "2" buttons during recording on the cassette deck.

Operations Possible in the Various Surround Modes

The following is a list of the buttons and functions which can be operated during the different surround modes. Figures in parentheses indicate adjustment ranges.

	OUTPUT	CENTER LEVEL	REAR LEVEL	CENTER MODE	3CH LOGIC	TEST TONE	DELAY TIME
BYPASS	○	X	X	△ ¹	X	X	X
DOLBY PRO LOGIC	○	○ (0--24dB)	○ (0--24dB)	○	○	○	○ (15--30ms)
	○	○ (0--24dB)	○ (0--24dB)	○	○	○	○ (15--30ms)
DOLBY 3CH LOGIC	○	○ (0--24dB)	X	○	○	○	○ (15--30ms)
	○	○ (0--24dB)	X	○	○	○	X
HALL	○	○	○	△ ¹	X	X	○ (0--33ms)
STUDIO	○	X	○	△ ¹	X	X	○ (0--33ms)

¹ Switches to the Dolby Pro (3CH) Logic for any modes other than Dolby Pro (3CH) Logic. The level of the center and rear channels can be adjusted by 2 dB step. The delay time can be set by 1.5 ms step.

- The sound may be distorted for some sources if the rear level is raised during surround playback. If this happens, lower the rear level.

13 INITIALIZATION OF THE MICROPROCESSOR

When the indication of the MFD display is not normal or when the operation of the unit does not show the reasonable result, the initialization of the microprocessor is required by the following procedure.

1. Switch off the unit and remove the AC power cord from the wall outlet.
2. Hold the following 2 buttons of the main unit at the same time (as illustrated in the diagram below, ① AUDIO FUNCTION button, ② VIDEO FUNCTION button) and plug the power cord into the outlet.
3. Check that the entire MFD display is flashing with an interval of about 1 second, and release your fingers from the 2 buttons.
4. Switch on the unit and the microprocessor will be initialized. The input function is set to tuner with the bypass mode automatically.

NOTE:

- When the unit does not show the result of above 3 and 4, repeat the procedure from 1 again.
- When the microprocessor is initialized, all settings you have made are reset to the factory presettings.

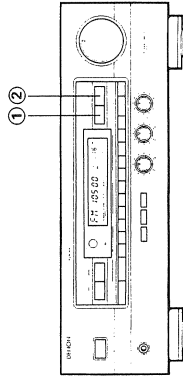

Initial parameter values for the different modes

	OUTPUT	CENTER LEVEL	REAR LEVEL	CENTER MODE	3CH LOGIC	DELAY TIME
BYPASS	ON	—	—	—	—	—
DOLBY PRO LOGIC	ON	-12dB	-12dB	NORMAL	OFF	21msec
HALL	ON	—	-12dB	—	—	21msec
STUDIO	ON	—	-12dB	—	—	21msec

- INPUT FUNCTION : TUNER
- Reception band : FM
- Reception mode : AUTO
- Reception frequency : 87.5MHz (for North American models)
- PERSONAL MEMORY 1 : VDP/DBS
- INPUT SURROUND MODE : DOLBY PRO LOGIC
- PERSONAL MEMORY 2 : VDP/DBS
- INPUT SURROUND MODE : HALL

14 TROUBLESHOOTING

If a problem should arise, first check the following:

1. Are the connections correct?
 2. Have you operated the amplifier according to the Operating Instructions?
 3. Are the speakers, turntable, and other components operating properly?
- If the receiver is not operating properly, check the items listed in the table below. Should the problem persist, there may be a malfunction. Disconnect the power immediately and contact your store of purchase.

Symptom	Cause	Measures	Page
MFD not lit and sound not produced when power switch set to on.	<ul style="list-style-type: none"> Power cord not plugged in securely. 	<ul style="list-style-type: none"> Check the insertion of the power cord plug. 	6
MFD lit but sound not produced.	<ul style="list-style-type: none"> Speaker cords not securely connected. OUTPUT button is off. Volume position of the audio function button. Volume control set to minimum. MUTING is on. 	<ul style="list-style-type: none"> Connect securely. Press the OUTPUT button. Set to a suitable position. Turn volume up to suitable level. Switch off MUTING. 	14 17 15 16
PROTECT display appears multi-function display.	<ul style="list-style-type: none"> Speaker terminals are short-circuited. Block the ventilation holes of the set. The unit is operating at continuous high power conditions and/or inadequate ventilation. 	<ul style="list-style-type: none"> Switch power off, connect speakers properly, then switch power back on. Turn off the set's power, then ventilate it well to cool it down. Once the set is cooled down, turn the power back on. 	14
Sound produced only from one channel.	<ul style="list-style-type: none"> Incomplete connection of speaker cords. Incomplete connection of input/output cords. Left/right balance is off. 	<ul style="list-style-type: none"> Connect securely. Connect securely. Adjust balance knob properly. 	14 11-13 15
Positions of instruments reversed during stereo playback.	<ul style="list-style-type: none"> Reverse connections of left and right speakers or left and right input/output cords. 	<ul style="list-style-type: none"> Check left and right connections. 	12-14
Sound seems distorted.	<ul style="list-style-type: none"> Rear level is too high. 	<ul style="list-style-type: none"> Set the rear level to lower level. 	23, 25
Personal memory function does not work.	<ul style="list-style-type: none"> DAT/Tape monitor mode set. 	<ul style="list-style-type: none"> Press the DAT/TAPE button to set the source. 	17
Humming noise produced when record is playing.	<ul style="list-style-type: none"> Ground wire of turntable not connected properly. Incomplete PHONO jack connection. TV or radio transmission antenna nearby. 	<ul style="list-style-type: none"> Connect securely. Connect securely. Contact your store of purchase. 	12 12
Howling noise produced when volume is high.	<ul style="list-style-type: none"> Turntable and speaker systems too close together. Floor is unstable and vibrates easily. 	<ul style="list-style-type: none"> Separate as much as possible. Use cushions to absorb speaker vibrations transmitted by floor. If turntable is not mounted on a shock absorber, use audio insulators (commonly available). 	- -
Sound is distorted.	<ul style="list-style-type: none"> Stylus pressure too weak. Dust or dirt on stylus. Cartridge defective. 	<ul style="list-style-type: none"> Apply proper stylus pressure. Check stylus. Replace cartridge. 	- -
Volume is weak.	<ul style="list-style-type: none"> MC cartridge being used. 	<ul style="list-style-type: none"> Replace with MM cartridge or use a head amplifier or step-up transformer. 	12
Receiver does not operate properly when remote control unit is used.	<ul style="list-style-type: none"> Batteries dead. Remote control unit too far from receiver. Obstacle between receiver and remote control unit. Different button is being pressed. Ends of battery inserted in reverse. 	<ul style="list-style-type: none"> Replace with new batteries. Move closer. Remove obstacle. Press the proper button. Insert batteries properly. 	- 10 10

15 LAST FUNCTION MEMORY

- This receiver is equipped with a last function memory which stores the input and output setting conditions as they were immediately before the power is switched off.
- This function eliminates the need to perform complicated resetting when the power is switched on.
- This receiver is also equipped with a back-up memory. This receiver provides approximately one week of memory storage with the power cord disconnected.

16 SPECIFICATIONS

- Audio Section**
Power amplifier
 Rated output: 60W + 60W (8 ohms, 20 Hz - 20 kHz with 0.08% THD)
 CENTER (center 1ch driven)
 60W (8 ohms, 20 Hz - 20 kHz with 0.08% THD)
 REAR (rear 2ch driven)
 15W + 15W (8 ohms, 1 kHz with 0.3% THD)
Output terminals:
 Front: 6 to 16 ohms
 Center: 8 to 16 ohms
 Rear: 8 to 16 ohms
Line input (Each line input - FRONT SP OUT)
 Input sensitivity/impedance: 150 mV/47 k ohms PHONO (MM): 2.5 mV/47 kohms
 Frequency response: 10 Hz to 50 kHz: ±3 dB
 Tone control range: +10 dB at 100 Hz
 -10 dB at 10 kHz
Signal-to-noise ratio
 92 dB (BYPASS)
Phono equalizer (PHONO input - REC OUT)
 RIAA deviation: ±1 dB (20 Hz to 20 kHz)
 Signal-to-noise ratio: 74 dB (A weighting, with 5 mV input)
 Rated output/Maximum output: 150 mV/8 V
 Distortion factor: 0.03% (1 kHz, 1 V)
Tuner Section
[FM] (note: μV at 75 ohms, 0 dBf = 1 × 10⁻¹⁵ W)
 Receiving Range: 87.5 MHz ~ 108.0 MHz (for North America model)
 87.5 MHz ~ 108.0 MHz (for multi-voltage model)
 Usable Sensitivity: 1.0 μV (11.2 dBf)
 50 dB Quieting Sensitivity: MONO 1.6 μV (15.3 dBf)
 STEREO 23 μV (38.5 dBf)
 Signal to Noise Ratio (IHF-A): MONO 80 dB
 STEREO 75 dB
 Total Harmonic Distortion MONO 0.15%
 STEREO 0.3%
[AM]
 Receiving Range: 520 kHz ~ 1710 kHz (for North America model)
 522 kHz ~ 1611 kHz (for multi-voltage model)
 Usable Sensitivity: 18 μV
 Signal to Noise Ratio: 50 dB
Video Section
Standard video jacks
 Input and output level/impedance: 1 Vp-p/75 ohms
 Frequency response: 2 Hz to 6 MHz ±0, -3 dB
General
Power supply: AC 120 V, 60 Hz (for North America model)
 AC 110/220 V, 50/60 Hz (for multi-voltage model)
 4.0 A (for North America model)
 W (for multi-voltage model)
Power consumption: 434 (W) × 142 (H) × 325 (D) mm (17-3/32" × 5-19/32" × 12-51/64")
Maximum external dimensions: 9.1 kg (20 lbs, 1 oz)
Weight:
Remote control unit
 RC-168: Total buttons: 36
 DENON system code: 6 buttons
 CD player: 6 buttons
 Cassette deck: 24 buttons
 AVR-800 fixed codes: R6P7/AA Type (two batteries)
 Batteries: 55 (W) × 18 (H) × 180 (D) mm (2-11/64" × 45/64" × 7-3/32")
 External dimensions: 110 g (Approx. 4 oz) (including batteries)
 Weight:

* For purposes of improvement, specifications and design are subject to change without notice.

**(EUROPE MODEL)
SPECIFICATIONS**

- **Audio Section**

(Power amplifier) Front (main 2ch driven)
Rated output: 60 W + 60 W (8 ohms, 20 Hz – 20 kHz with 0.1% THD)
 (All properties shown are only for the power amplifier stage.) CENTER (center 1ch driven)
 60 W (8 ohms, 20 Hz – 20 kHz with 0.1% THD)
 REAR (rear 2ch driven)
 15 W + 15 W (8 ohms, 1 kHz with 0.5% THD)

Output terminals: Front: 6 to 16 ohms
 Center: 8 to 16 ohms
 Rear: 8 to 16 ohms

Line input (Each line input – FRONT SP OUT)
Input sensitivity / impedance: 150 mV / 47 k ohms PHONO (MM): 2.5 mV / 47 kohms
Frequency response: 10 Hz to 50 kHz: ±3 dB
Tone control range: BASS: ±10 dB at 100 Hz
 TREBLE: ±10 dB at 10 kHz

Signal-to-noise ratio 92 dB (BYPASS)
Phono equalizer (PHONO input – REC OUT)
RIAA deviation: ±1 dB (20 Hz to 20 kHz)
Signal-to-noise ratio: 74 dB (A weighting, with 5 mV input)
Rated output / Maximum output: 150 mV / 8 V
Distortion factor: 0.03% (1 kHz, 1 V)
- **Tuner Section**

[FM] (note: μV at 75 ohms, 0 dBf = 1×10^{15} W)
Receiving Range: 87.50 MHz ~ 108.00 MHz
Usable Sensitivity: 1.0 μV (11.2 dBf)
50 dB Quieting Sensitivity: MONO 1.6 μV (15.3 dBf)
 STEREO 23 μV (38.5 dBf)
Signal to Noise Ratio (IHF-A): MONO 80 dB
 STEREO 75 dB
Total Harmonic Distortion (at 1 kHz): MONO 0.4%
 STEREO 0.5%

[AM]
Receiving Range: 522 kHz ~ 1611 kHz
Usable Sensitivity: 18 μV
Signal to Noise Ratio: 50 dB
- **Video Section**

Standard video jacks
Input and output level / impedance: 1 V_{p-p} / 75 ohms
Frequency response: 2 Hz to 8 MHz +0, -3 dB
- **General**

Power supply: AC 230 V, 50 Hz (for Europe model)
 AC 240 V, 50 Hz (for U.K. model)
Power consumption: 200 W
Maximum external dimensions: 434 (W) × 142 (H) × 325 (D) mm (17-3/32" × 5-19/32" × 12-51/64")
Weight: 9.1 kg (20 lbs 1 oz)
- **Remote control unit**

System remote control
RC-169: Total buttons: 36
 DENON system code
 CD player: 6 buttons
 Cassette deck: 6 buttons
 AVR-800 fixed codes: 24 buttons
 Batteries: R6P/AA Type (two batteries)
 External dimensions: 55 (W) × 18 (H) × 180 (D) mm (2-11/64" × 45/64" × 7-3/32")
 Weight: 110 g (Approx. 4 oz) (including batteries)

* For purposes of improvement, specifications and design are subject to change without notice.





● NUR FÜR EUROPÄISCHE MODELLE

Konformitätserklärung

Die DENON Electronic GmbH
Halskestraße 32
4030 Ratingen 1

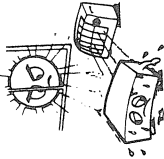
Erklärt als Hersteller/Importeur, daß das in dieser Bedienungsanleitung beschriebene Gerät den Technischen Vorschriften für Ton- und Fernseh-Rundfunkempfänger nach der Amtsblattverfügung 868/1989 (Amtsblatt des Bundesministers für Post und Telekommunikation vom 31. 8. 1989) entspricht.

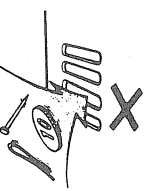
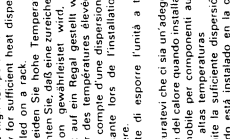
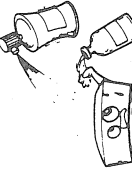
1 INTRODUCTION / EINFÜHRUNG / INTRODUCTION
INTRODUZIONE / INTRODUCCION / INLEIDING / INLEDNING
NOTE ON USE / HINWEISE ZUM GEBRAUCH / OBSERVATIONS RELATIVES A L'UTILISATION
NOTE SULL'USO / NOTAS SOBRE EL USO / ALVORENS TE GEBRUIKEN / OBSERVERA

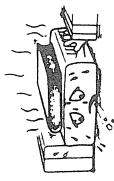
 <ul style="list-style-type: none"> • Avoid high temperatures • Allow for sufficient heat dispersion when installed on a rack. • Vermeiden Sie hohe Temperaturen • Lassen Sie genügend Platz für die Wärmeabfuhr. • Evite altas temperaturas • Permitte la suficiente dispersión del calor cuando está instalado en la consola. • Zerknüllt hohe temperaturen, indien het apparaat op een rek wordt geplaatst. • Undvik höga temperaturer • Se till att det finns möjlighet till god värmeavledning vid montering i ett rack. • Conceda suficiente dispersión de calor cuando o equipamento for instalado numa prateleira. 	 <ul style="list-style-type: none"> • Keep the set free from moisture, water, and dust. • Halten Sie das Gerät von Feuchtigkeit, Wasser und Staub fern. • Protéger l'appareil contre l'humidité, l'eau et la poussière. • Tenete l'unità lontana dall'umidità, dall'acqua e dal polvere. • Mantenga el equipo libre de humedad, agua y polvo. • Laat geen vochtigheid, water of stof in het apparaat binnendringen. • Hold the apparatus free from dust, vapour and damp. • Mantenha o aparelho livre de qualquer umidade, água ou poeira. 	 <ul style="list-style-type: none"> • Do not let foreign objects in the set. • Keine fremden Gegenstände in das Gerät kommen lassen. • Ne pas laisser des objets étrangers dans l'appareil. • E' importante che nessun oggetto è inserito all'interno dell'unità. • No djne objekta extraños dentro del equipo. • Geen vreemde voorwerpen in dit apparaat vallen. • Se till att frammande föremål inte tränger in i apparaten. • Não deixar objetos estranhos no aparelho.
 <ul style="list-style-type: none"> • Unplug the power cord when not using the set. • Wenn das Gerät eine längere Zeit nicht verwendet werden soll, trennen Sie das Netzkabel vom Netzstecker. • Débrancher le cordon d'alimentation lors de longues périodes. • Disinnestare il filo di alimentazione quando avete l'intenzione di non usare il filo di alimentazione per un lungo periodo di tempo. • Desconecte el cordón de energía cuando no utilice el equipo por mucho tiempo. • Neem altijd het netsnoer uit het stopcontact wanneer het apparaat gedurende een langere periode niet wordt gebruikt. • Koppla ur nätkablen om apparaten inte kommer att användas i lång tid. • Desligue o fio condutor de força quando o aparelho não tiver que ser usado por um longo período. 	 <ul style="list-style-type: none"> • Do not let insecticides, benzene, and thinner come in contact with the set. • Lassen Sie das Gerät nicht mit Insektiziden, Benzin oder Verdünnungsmitteln in Berührung kommen. • Ne laissez pas entrer en contact des insecticides, benzène et un diluant avec l'appareil. • Assicuratevi che l'unità non venga in contatto con insetticidi, benzolo o solventi. • No permita el contacto de insecticidas, benceno o disolventes con el aparato. • Laat geen insectenverdelgende middelen, benzine of verdunner met dit apparaat in contact komen. • Se till att inte insektsmedel på språk, bly, bensin eller lösningsmedel kommer i kontakt med apparaten. • Não permita que inseticidas, benzina e dissolventes entrem em contacto com o aparelho. 	 <ul style="list-style-type: none"> • Never disassemble or modify the set in any way. • Verändern Sie niemals das Gerät ausserhalb der zu nehmenden oder auf jegliche Art zu verändern. • Ne jamais démonter ou modifier l'appareil d'une manière ou d'une autre. • Nunca desarme o modifique el equipo de ninguna manera. • Noot dit apparaat demonteren of op andere wijze wijzigen. • Ta inte sär apparaten eller försök inte bygga om den. • Nunca desmonte o modifique o aparelho de alguma forma.
 <ul style="list-style-type: none"> • Handle the power cord carefully. • Handle the cable with care when plugging the cord into the power outlet. • Gehen Sie vorsichtig mit dem Netzkabel um. • Halten Sie das Kabel am Stecker, wenn Sie den Stecker herausziehen. • Manipulez le cordon d'alimentation avec précaution. • Tenga la prise con cuidado al desbranchamiento del cordón. • Maneggiare il filo di alimentazione con cura. • Maneje o cordão de energia com cuidado, desde a tomada até o cabo da presa. • Sostenga el enchufe cuando desconecte el cordón de energía. • Houd het snoer bij de stekker vast wanneer deze moet worden aan of losgekoppeld. • Hantera nätkablen försiktigt. • Håll i kabein när den kopplas från elenergi. • Manuseie com cuidado o fio condutor de energia. • Segure a tomada ao desconectar o fio. 	 <ul style="list-style-type: none"> • Do not obstruct the ventilation holes. • Die Belüftungsöffnungen dürfen nicht verdeckt werden. • Ne pas obstruer les trous de aération. • No cubra i los orificios de ventilación. • De ventilatieopeningen mogen niet worden beblokkeerd. • Tapp inte till ventilationsöppningarna. • Não obstrua os orificios de ventilação. 	<p>"SERIAL NO. _____" PLEASE RECORD UNIT SERIAL NUMBER ATTACHED TO THE REAR OF THE CABINET FOR FUTURE REFERENCE"</p>

2 NAMES OF PARTS

(Front Panel)

BEZEICHNUNG DER TEILE

(Frontplatte)

NOMENCLATURE

(Panneau avant)

OMENCLATURA

(Pannello anteriore)

NOMBRE DE LAS PARTES

(Panel delantero)

NAMEN VAN ONDERDELEN

(Voorpaneel)

DE OLIKA DELARNAS NAMN

(Frontpanel)

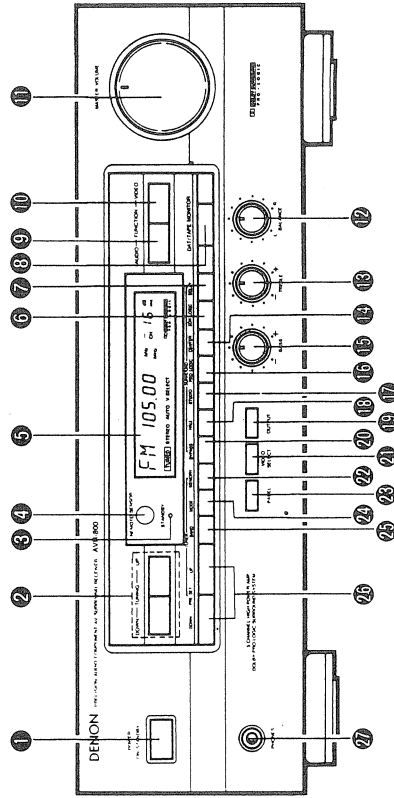

FOR ENGLISH READERS

- 1 POWER BUTTON
- 2 TUNING BUTTONS
- 3 STANDBY LED
- 4 REMOTE CONTROL SENSOR
- 5 MFD (Multi-function fluorescent display)
- 6 3CH. LOGIC MODE BUTTON
- 7 DELAY TIME BUTTON
- 8 DAT/TAPE MONITOR BUTTON
- 9 AUDIO FUNCTION BUTTON
- 10 VIDEO FUNCTION BUTTON
- 11 MASTER VOLUME
- 12 BALANCE control
- 13 TREBLE control
- 14 CENTER MODE BUTTON
- 15 BASS control
- 16 DOLBY PRO LOGIC MODE BUTTON
- 17 STUDIO MODE BUTTON
- 18 HALL MODE BUTTON
- 19 OUTPUT BUTTON
- 20 BYPASS BUTTON
- 21 VIDEO SELECT BUTTON
- 22 MEMORY BUTTON
- 23 PANEL BUTTON
- 24 TUNING MODE BUTTON
- 25 (Tuning Mode Selector Switch)
- 26 TUNING BAND BUTTON
- 27 (Tuning Band Selector Switch)
- 28 TUNER PRESET BUTTONS
- 29 PHONES JACK

FÜR DEUTSCHE LESER

- 1 Netztaсте (POWER)
- 2 Abstimmasten (TUNING)
- 3 Bereitschaftsanzeige (STANDBY LED)
- 4 Sensor für Fernbedienung
- 5 Multi-Funktions-Display (MFD)
- 6 3-Kanal Logik-Modus-Taste (3CH. LOGIC MODE)
- 7 Zeitverzögerungstaste (DELAY TIME)
- 8 DAT-/Cassettendeck-Überwachungstaste (DAT/TAPE MONITOR)
- 9 Audio-Funktionstaste (AUDIO FUNCTION)
- 10 Video-Funktionstaste (VIDEO FUNCTION)
- 11 Hauptlautstärke (MASTER VOLUME)
- 12 Balance-Steuerung (BALANCE)
- 13 Höhen-Steuerung (TREBLE)
- 14 Mittel-Modus Taste (CENTER MODE)
- 15 Bass-Steuerung (BASS)
- 16 Dolby-Pro Logik-Modus Taste (DOLBY PRO LOGIC MODE)
- 17 Taste für Studio-Modus (STUDIO MODE)
- 18 Taste für Saal-Modus (HALL MODE)
- 19 Ausgangstaste (OUTPUT)
- 20 Bypass-Taste (BYPASS)
- 21 Videoauswahl-Taste (VIDEO SELECT)
- 22 Speichertaste (MEMORY)
- 23 Konsolentaste (PANEL)
- 24 Abstimmungsmodus-Taste (TUNING MODE)
- 25 (Abstimmungsmodus-Wahlschalter)
- 26 Abstimmungsband-Tasten (TUNING BAND)
- 27 (Abstimmungsband-Wahlschalter)
- 28 Tuner-Voreinstellungs-Tasten (TUNER PRESET)
- 29 Kopfhörerbuchsen (PHONES JACK)

- POUR LES LECTEURS FRANÇAIS**
- 1 TOUCHE D'ALIMENTATION (POWER)
 - 2 TOUCHES DE SYNTONISATION (TUNING)
 - 3 TEMOIN DE VELLE (STANDBY LED)
 - 4 DETECTEUR DE TELECOMMANDE
 - 5 MFD (Affichage fluorescent multifonction)
 - 6 TOUCHE DE MODE LOGIQUE 3 CANAUX (3CH. LOGIC MODE)
 - 7 TOUCHES DE RETARD (DELAY TIME)
 - 8 TOUCHES DAT/CONTROLE DE BANDE (DAT/TAPE MONITOR)
 - 9 TOUCHES DE FONCTION AUDIO (AUDIO FUNCTION)
 - 10 TOUCHES DE FONCTION VIDEO (VIDEO FUNCTION)
 - 11 Commande de VOLUME GLOBAL (MASTER VOLUME)
 - 12 Commande d'équilibre (BALANCE)
 - 13 Commande des aigus (TREBLE)
 - 14 TOUCHES DE MODE CENTRAL (CENTER MODE)

PER IL LETTORE ITALIANO

- 1 TASTO DI ACCENSIONE
- 2 TASTI DI SINTONIZZAZIONE
- 3 LED DI ATTESA
- 4 SENSORE A DISTANZA
- 5 Display MFD (display fluorescente multifunzione)
- 6 TASTO DEL MODO 3CH. LOGIC
- 7 TASTO DELLA DURATA DEL RITARDO
- 8 Tasto di monitoraggio della piastra DAT/piastra a cassette (DAT/TAPE MONITOR)
- 9 TASTO DI FUNZIONE AUDIO
- 10 TASTO DI FUNZIONE VIDEO
- 11 VOLUME PRINCIPALE
- 12 CONTROLLO DEL BILANCIAMENTO
- 13 CONTROLLO DEGLI ACUTI

PARA LECTORES DE ESPAÑOL

- 1 INTERRUPTOR DE ALIMENTACION
- 2 BOTONES DE SINTONIZACION
- 3 LED DE MODO DE ESPERA
- 4 SENSOR DE CONTROL REMOTO
- 5 MFD (visualizador fluorescente multifuncion)
- 6 BOTON SELECTOR DE MODO 3CH. LOGIC
- 7 BOTON DAT/TAPE MONITOR (DAT/TAPE MONITOR)
- 8 BOTON SELECTOR DE ENTRADA DE AUDIO
- 9 BOTON SELECTOR DE ENTRADA DE VIDEO
- 10 CONTROL PRINCIPAL DE VOLUMEN
- 11 Control de tonos agudos (TREBLE)
- 12 BOTON SELECTOR DE MODO CENTRAL

VOOR NEDERLANDSTALIGE LEZERS

- 1 SPANNINGSTOETS (POWER)
- 2 AFSTEMTOETSEN (TUNING)
- 3 STANDBY-AAN/UITDING (STANDBY LED)
- 4 AFSTANDBEDIENINGSSENSOR (REMOTE CONTROL SENSOR)
- 5 MFD (Multifunctionele lichtgevende display)
- 6 3-KANAALS LOGIC-STANDTOETS (3CH. LOGIC MODE)
- 7 VERTRAGINGSTUDDTOETS (DELAY TIME)
- 8 DAT/bandmeelusttoets (DAT/TAPE MONITOR)
- 9 AUDIOFUNKTIE TOETS (AUDIO FUNCTION)
- 10 VIDEOFUNKTIE TOETS (VIDEO FUNCTION)
- 11 HOOFDVOLUME (MASTER VOLUME)
- 12 Balansregelaar (BALANCE)
- 13 Hoge tonen-regelaar (TREBLE)
- 14 MIDDENSTANDTOETS (CENTER MODE)
- 15 Lage-tonenregelaar (BASS)

FÖR SVENSKA LÄSARE

- 1 Strömbytare (POWER)
- 2 Avstämningstangerter (TUNING)
- 3 Beredskapsindikator (STANDBY)
- 4 Fjärrkontrollsensor (REMOTE CONTROL SENSOR)
- 5 MFD-display
- 6 Tangent för 3-kanalslogik (3CH. LOGIC MODE)
- 7 Tangent för reglering av ljudfördröjning (DELAY TIME)
- 8 DAT-/DACKVALJARE (DAT/TAPE MONITOR)
- 9 Audiofunktionstangent (AUDIO FUNCTION)
- 10 Videofunktionstangent (VIDEO FUNCTION)
- 11 Ljudstyrkekontroll (MASTER VOLUME)
- 12 Balanskontroll (BALANCE)
- 13 Diskantkontroll (TREBLE)

- 8 Commande de graves (BASS)
- 9 TOUCHES DOLBY PRO LOGIC MODE
- 10 TOUCHE DE MODE STUDIO
- 11 TOUCHE DE MODE HALL
- 12 TOUCHE DE MODE BYPASS
- 13 TOUCHE DE DERIVATION (BYPASS)
- 14 TOUCHE DE SELECTION VIDEO (VIDEO SELECT)
- 15 TOUCHE DE MEMOIRE (MEMORY)
- 16 TOUCHE DE PANNEAU (PANEL)
- 17 MODE) Sélécteur de mode de syntonisation (TUNING BAND)
- 18 TOUCHES DE GAMME DE SYNTONISATION (TUNING BAND)
- 19 (Sélécteur de gamme de syntonisation)
- 20 TOUCHES DE PREREGLAGE DE TUNER (TUNER PRESET)
- 21 PRISE CASQUE (PHONES)

- 16 TASTO DEL MODO CENTRALE
- 17 CONTROLLO DEI BASSI
- 18 TASTO DEL MODO DOLBY PRO LOGIC
- 19 TASTO DEL MODO STUDIO
- 20 TASTO DEL MODO HALL
- 21 TASTO DI USCITA
- 22 TASTO BYPASS
- 23 TASTO DI SELEZIONE VIDEO
- 24 TASTO DI MEMORIZZAZIONE
- 25 TASTO DEL DISPLAY
- 26 TASTO DEL MODO DI SINTONIZZAZIONE
- 27 TASTO DELLA BANDA DI SINTONIZZAZIONE
- 28 TASTI DI PRESELEZIONE DEL SINTONIZZATORE
- 29 PRESA DELLE CUFFIE

- 16 Control de tonos bajos (BASS)
- 17 BOTON SELECTOR DE MODO DOLBY PRO LOGIC
- 18 BOTON SELECTOR DE MODO "STUDIO"
- 19 BOTON SELECTOR DE MODO "HALL"
- 20 BOTON DE SALIDA
- 21 BOTON DE OMISION
- 22 BOTON VIDEO SELECT
- 23 BOTON DE MEMORIA
- 24 BOTON DE INDICACION EN VISUALIZADOR
- 25 Interruptor selector de modo de syntonización (TUNING BAND)
- 26 Interruptor selector de banda de syntonización (TUNING BAND)
- 27 CONECTOR PARA AURICULARES

- 16 DOLBY PRO LOGIC-STANDTOETS
- 17 (DOLBY PRO LOGIC MODE)
- 18 STUDIOSTANDTOETS (STUDIO MODE)
- 19 CONCERTZAAL-STANDTOETS (HALL MODE)
- 20 UITVOERTOETS (OUTPUT)
- 21 NEGEERTOETS (BYPASS)
- 22 VIDEOKEUZE TOETS (VIDEO SELECT)
- 23 GEHEUGENTOETS (MEMORY)
- 24 PANEELTOETS (PANEL)
- 25 AFSTEMSTANDTOETS (TUNING MODE)
- 26 (Afstemstand-keuzeschakelaar)
- 27 GOLFBANDAFSTEMTOETS (TUNING BAND)
- 28 (Golfband-afstemkeuzeschakelaar)
- 29 HOOFDTELEFOONAANSLUITING (PHONES)

- 16 Mittkanalsväljare (CENTER MODE)
- 17 Baskontroll (BASS)
- 18 DOLBY PRO LOGIC-tangent
- 19 STUDIO-tangent
- 20 HALL-tangent
- 21 Högtalaromkopplare (OUTPUT)
- 22 Förbikopplingstangent (BYPASS)
- 23 Videoväljare (VIDEO SELECT)
- 24 Minnestangent (MEMORY)
- 25 PANELL-tangent
- 26 Avstämningsskopplare (TUNING MODE)
- 27 Frekvensbandväljare (TUNING BAND)
- 28 Snabbvalstangerter (TUNER PRESET)
- 29 Hörlursuttag (PHONES)

(Remote Control Unit)
(Fernbedienungsgerät)
(Télécommande)
(Telecomando)

(Unidad de Control Remoto)
(Afstandsbediening)
(Fjärrkontroll)

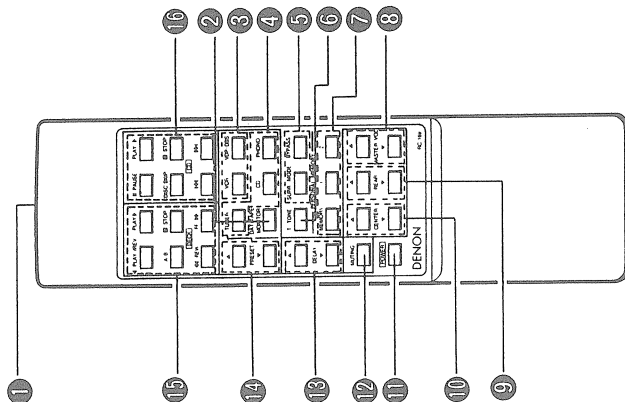

- 1 TOUCHE D'ALIMENTATION (POWER)
- 2 ☆TOUCHE DE SOURDINE (MUTING)
- 3 TOUCHE DE REGLAGE DE RETARD (DELAY TIME ADJUSTMENT)
- 4 TOUCHES PREREGLAGÉ DE TUNER
- 5 TOUCHES DE SYSTEME DE PLATINE CASSETTE (TAPE DECK SYSTEM)
- 6 TOUCHES DE SYSTEME CD (CD SYSTEM)

Les touches marquées " ☆ " indiquent des fonctions disponibles seulement sur la télécommande.

- 7 TASTO DI ACCENSIONE
- 8 ☆TASTO DI SILENZIAMENTO
- 9 TASTI DI REGOLAZIONE DELLA DURATA DEL RITARDO
- 10 TASTI DI PRESELEZIONE DEL SINTONIZZATORE
- 11 TASTI DELLA PIASTRA A CASSETTE
- 12 TASTI DEL SISTEMA CD

I tasti che recano il marchio " ☆ " indicano funzioni che sono disponibili solo usando il telecomando.

- 13 INTERRUPTOR DE ALIMENTACION
- 14 ☆BOTON DE SILENCIAMIENTO (MUTING)
- 15 BOTONES DE AJUSTE DE TIEMPO DE RETARDO
- 16 BOTONES DE PRESINTONIZACION
- 17 BOTONES DE MAGNETOFONO DE CASSETTES
- 18 BOTONES DE REPRODUCTOR CD

Los botones marcados " ☆ " indican funciones solo disponibles en la unidad de control remoto.

- POUR LES LECTEURS FRANCAIS
- 1 FENETRE D'EMISSION
 - 2 TOUCHE DAT/CONTROLE DE BANDE (DAT/TAPE MONITOR)
 - 3 TOUCHES DE FONCTION VIDEO (VIDEO FUNCTION)
 - 4 TOUCHES DE FONCTION AUDIO (AUDIO FUNCTION)
 - 5 TOUCHES D'AMBIANCE (SURROUND)
 - 6 ☆TOUCHE DE TONALITE TEST (TONE TEST)
 - 7 ☆TOUCHES DE MEMOIRE PERSONNALISEE (PERSONAL MEMORY)
 - 8 TOUCHES DE VOLUME GLOBAL (MASTER VOLUME)
 - 9 ☆TOUCHES DE REGLAGE DE NIVEAU ARRIERE (REAR LEVEL)
 - 10 ☆TOUCHES DE REGLAGE DE NIVEAU CENTRAL (CENTER LEVEL)

- PER IL LETTORE ITALIANO
- 1 FINESTRELLA DI TRASMISSIONE
 - 2 TASTO DELLA PIASTRA DAT/MONITORAGGIO DEL NASTRO
 - 3 TASTI DELLA FUNZIONE VIDEO
 - 4 TASTI DELLA FUNZIONE AUDIO
 - 5 TASTI SURROUND
 - 6 ☆TASTO DEL TONO DI PROVA
 - 7 ☆TASTI DELLA MEMORIA PERSONALE
 - 8 TASTI DEL VOLUME PRINCIPALE
 - 9 ☆TASTI DI REGOLAZIONE DEL LIVELLO POSTERIORE
 - 10 ☆TASTI DI REGOLAZIONE DEL LIVELLO CENTRALE

- PARA LECTORES DE ESPANOL
- 1 VENTANILLA TRANSMISORA
 - 2 BOTON DAT/TAPE MONITOR
 - 3 BOTONES SELECTORES DE ENTRADA DE VIDEO
 - 4 BOTONES SELECTORES DE ENTRADA DE AUDIO
 - 5 BOTONES DE SONIDO ENVOLVENTE
 - 6 ☆BOTON DE TONO DE PRUEBA (TEST TONE)
 - 7 ☆BOTONES DE MEMORIA PERSONAL (PERSONAL MEMORY)
 - 8 BOTONES DE VOLUMEN PRINCIPAL
 - 9 ☆BOTONES DE AJUSTE DE NIVEL TRASERO (REAR LEVEL)
 - 10 ☆BOTONES DE AJUSTE DE NIVEL CENTRAL (CENTER LEVEL)

VOOR NEDERLANDSTALIGE LEZERS

- 1 ZENDEVENSTERTJE
- 2 DAT/TAPE-MEELUUSTERTOETS (DAT/TAPE MONITOR)
- 3 VIDEOFUNKTIEETOETS (VIDEO FUNCTION)
- 4 AUDIOFUNKTIEETOETS (AUDIO FUNCTION)
- 5 SURROUND-TOETS
- 6 ☆TESTTOONTOETS (TEST TONE)
- 7 ☆PERSONLIJK GEHEUGENTOETS (PERSONAL MEMORY)
- 8 HOOFDVOLUMEETOETS (MASTER VOLUME)
- 9 ☆ACHTERNIVEAU-INSTELTOETS (REAR LEVEL ADJUSTMENT)
- 10 ☆MIDDENNIVEAU-INSTELTOETS (CENTER LEVEL ADJUSTMENT)

FÖR SVENSKA LÄSARE

- 1 Sändarfönster
- 2 DAT-/däckkopplare (DAT/TAPE MONITOR)
- 3 Videotangenter (VIDEO FUNCTION)
- 4 Audiotangenter (AUDIO FUNCTION)
- 5 SURROUND-tangenter
- 6 ☆Testton-tangent (TEST TONE)
- 7 ☆Tangenter för användarminne (PERSONAL MEMORY)
- 8 Ljudstyrketangenter (MASTER VOLUME)
- 9 ☆Tangenter för justering av den bakre nivån (REAR LEVEL ADJUSTMENT)
- 10 ☆Tangenter för justering av mittkanalnivån (CENTER LEVEL ADJUSTMENT)

FÜR DEUTSCHE LESER

- 1 Übertragungsfenster (TRANSMITTING WINDOW)
- 2 Datum/Band Überwachungsstaste (DAT/TAPE MONITOR)
- 3 Video-Funktionstasten (VIDEO FUNCTION)
- 4 Audio-Funktionstasten (AUDIO FUNCTION)
- 5 Klangumgebungs-Tasten (SURROUND)
- 6 ☆Testton-Taste (TEST TONE)
- 7 ☆Persönliche Speichertasten (PERSONAL MEMORY)
- 8 Hauptauslaste-Tasten (MASTER VOLUME)
- 9 ☆Einstellungstasten für hintere Stufe (REAR LEVEL ADJUSTMENT)
- 10 ☆Einstellungstasten für Mittelstufe (CENTER LEVEL ADJUSTMENT)
- 11 Netztaste (POWER)
- 12 ☆Stummenschaltungs-Taste (MUTING)
- 13 Einstellungstasten für Zeitverzögerung (DELAY TIME ADJUSTMENT)
- 14 Tuner-Voreinstellungstasten (TUNER PRESET)
- 15 Systemtasten für Tape Deck (TAPE DECK SYSTEM)
- 16 CD-Systemtasten (CD SYSTEM)

Die mit " ☆ " markierten Tasten zeigen Funktionen an, die nur mit Hilfe des Fernbedienungsgerätes aktiviert werden können.

- FOR ENGLISH READERS
- 1 TRANSMITTING WINDOW
 - 2 DAT/TAPE MONITOR BUTTON
 - 3 VIDEO FUNCTION BUTTONS
 - 4 AUDIO FUNCTION BUTTONS
 - 5 SURROUND BUTTONS
 - 6 ☆TEST TONE BUTTON
 - 7 ☆PERSONAL MEMORY BUTTONS
 - 8 MASTER VOLUME BUTTONS
 - 9 ☆REAR LEVEL ADJUSTMENT BUTTONS
 - 10 ☆CENTER LEVEL ADJUSTMENT BUTTONS
 - 11 POWER BUTTON
 - 12 ☆MUTING BUTTON
 - 13 DELAY TIME ADJUSTMENT BUTTONS
 - 14 TUNER PRESET BUTTONS
 - 15 TAPE DECK SYSTEM BUTTONS
 - 16 CD SYSTEM BUTTONS

Buttons marked " ☆ " indicate functions only available on the remote control unit.

- 13 SPANNINGSTOETS (POWER)
- 14 ☆DEMPINGSTOETS (MUTING)
- 15 VERTRAGINGSTIJD-INSTELTOETS (DELAY TIME ADJUSTMENT)
- 16 TUNER-VOORKEUZETOETS (TUNER PRESET)
- 17 TAPEDECK-SYSTEEMTOETS (TAPE DECK SYSTEM)
- 18 CD-SYSTEEMTOETS (CD SYSTEM)

De met " ☆ " gemerkte toetsen duiden functies aan die enkel met de afstandsbediening kunnen worden gebruikt.

- 13 Strömbrytare (POWER)
- 14 ☆Dämp tangent (MUTING)
- 15 Tangenter för justering av tidsfördröjningen (DELAY TIME ADJUSTMENT)
- 16 Snabbvalstangenter (TUNER PRESET)
- 17 Systemtangenter för kassettdäcket (TAPE DECK SYSTEM)
- 18 CD-tangenter (CD SYSTEM)

Tangenter märkta " ☆ " motsvarar funktioner som bara kan utnyttjas via fjärrkontrollen.

(Rear Panel)
(Rückseite)
(Panneau arrière)
(Pannello posteriore)

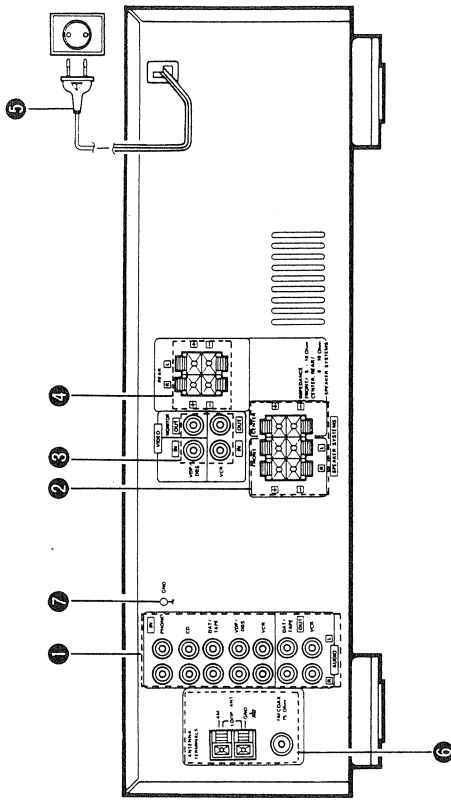

POUR LES LECTEURS FRANÇAIS
 1 PRISES D'ENTRÉE/SORTIE AUDIO (AUDIO INPUT/OUTPUT)
 2 BORNES D'ENCEINTE AVANT/CENTRALE (FRONT/CENTER SPEAKER)
 3 PRISES D'ENTRÉE/SORTIE VIDEO (VIDEO INPUT/OUTPUT)

PER IL LETTORE ITALIANO
 1 PRESE DI INGRESSO/USCITA AUDIO CENTRALI
 2 TERMINALI DEGLI ALTOPARLANTI ANTERIORI/ CENTRALI
 3 PRESE DI INGRESSO/USCITA VIDEO

PARA LECTORES DE ESPAÑOL
 1 CONECTORES DE ENTRADA/SALIDA DE AUDIO CENTRAL
 2 CONECTORES DE ENTRADA/SALIDA DE VIDEO

VOOR NEDERLANDSTALIGE LEZERS
 1 AUDIO-INVVOER-/UITVOERAANSLUITINGEN
 2 MIDDENLUIDSPREKERS
 3 VIDEO-INVVOER-/UITVOERAANSLUITINGEN

FÖR SVENSKA LÄSARE
 1 Audioingångar och -utgångar (AUDIO INPUT/OUTPUT)
 2 Anslutningar för främre/mittöglare (FRONT/CENTER SPEAKER)
 3 Videoingångar och -utgångar (VIDEO INPUT/OUTPUT)

4 BORNES D'ENCEINTE ARRIERE (REAR SPEAKER)
 5 CORDON SECTEUR
 6 BORNES D'ANTENNE FM/AM (FM/AM ANTENNA)
 7 GND (Borne de mise à la masse)

4 TERMINALI DEGLI ALTOPARLANTI POSTERIORI
 5 CAVO CA
 6 TERMINALI DELL'ANTENNA FM/AM
 7 GND (Terminale di massa)

4 TERMINALES DE ALTAVOCES TRASEROS
 5 CABLE DE ALIMENTACION DE CA
 6 TERMINALES DE ANTENA DE FM/AM
 7 GND (Terminal de conexión a tierra)

4 AANSLUITPUNTEN ACHTERSTE LUIDSPREKERS
 5 NETKABEL
 6 AANSLUITPUNTEN FM/AM-ANTENNE
 7 GND (Aardingsaansluitpunt)

4 Anslutningar för bakre högtalare (REAR SPEAKER)
 5 Nätsladd
 6 Anslutningar för FM-/AM-antenn (FM/AM ANTENNA)
 7 GND (Jordpunkt)

FOR ENGLISH READERS

- 1 AUDIO INPUT/OUTPUT JACKS
- 2 FRONT/CENTER SPEAKER TERMINALS
- 3 VIDEO INPUT/OUTPUT JACKS
- 4 REAR SPEAKER TERMINALS
- 5 AC CORD
- 6 FM/AM ANTENNA TERMINALS
- 7 GND (Grounding terminal)

FÜR DEUTSCHE LESER

- 1 Audio Eingangs-/Ausgangs-Buchsen (AUDIO INPUT/OUTPUT)
- 2 Lautsprecheranschlüsse für Vorne und Mitte (FRONT/CENTER SPEAKER)
- 3 Video Eingangs-/Ausgangs-Buchsen (VIDEO INPUT/OUTPUT)
- 4 Anschlüsse für Hecklautsprecher (REAR SPEAKER)
- 5 Netzkabel
- 6 UKW/MW-Antennenanschlüsse (FM/AM ANTENNA)
- 7 GND (Masseanschluss)

- Always turn off the power of the various components when making connections. Also refer to the operating instructions for the other components.
- Do not plug in the power cord until all connections are completed.
- Schalten Sie beim Vornehmen von Anschlüssen immer den Strom zu den verschiedenen Komponenten aus. Beziehen Sie sich darüberhinaus auf die Bedienungsanleitungen für die anderen Komponenten.
- Schließen Sie das Netzkabel nicht an, bevor alle anderen Anschlüsse komplett ausgeführt worden sind.
- Mettre toujours les divers appareils hors circuit lors de la réalisation des connexions. Se reporter également aux modes d'emploi des autres appareils.
- Ne pas brancher le cordon d'alimentation avant d'avoir terminé toutes les connexions.
- Spagnete sempre la corrente dei vari componenti prima di fare i collegamenti. Inoltre, fate riferimento al manuale di ciascun componente.
- Non inserite il filo di alimentazione finché tutti i collegamenti non saranno stati fatti.
- Antes de hacer las conexiones, desconecte la alimentación a los distintos componentes. Consulte también los manuales de instrucciones de los componentes en uso.
- No conecte el cable de alimentación hasta haber finalizado todas las conexiones.
- Schakel altijd de spanning van de verschillende componenten uit wanneer u aansluitingen maakt. Raadpleeg ook de gebruiksaanwijzing van de andere componenten.
- Steek het netsnoer pas in als alle aansluitingen tot stand zijn gebracht.
- Kom alltid ihåg att stänga av alla apparater innan du ändrar några anslutningar. Läs respektive bruksanvisningar för närmare upplysningar.
- Nätkabeln skall inte sättas i vägguttaget förrän alla andra anslutningar är klara.

3 REMOTE CONTROL UNIT

Following the procedure outlined below, insert the batteries before using the remote control unit.

Range of operation of the remote control unit

Point the remote control unit at the remote control sensor as shown on the diagram at the left.

NOTES:

- The remote control unit can be used from a straight distance of approximately 7 meters, but this distance will shorten or operation will become difficult if there are obstacles between the remote control unit and the remote control sensor, if the remote control sensor is exposed to direct sunlight or other strong light, or if operated from an angle.
- Neon signs or other devices emitting pulse-type noise nearby may result in malfunction, so keep the set as far away from such devices as possible.

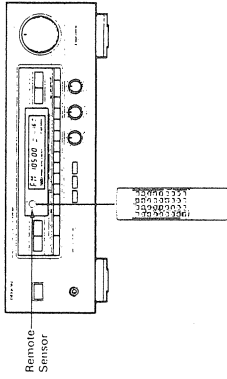

Inserting the batteries

1. Open the bottom cover of the remote control unit and remove the battery cover.

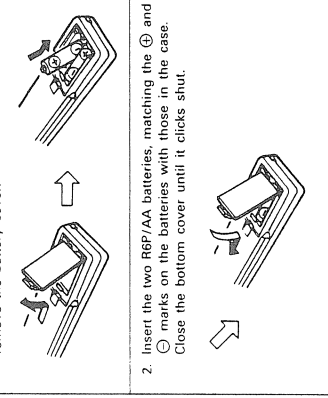

NOTES

- Use only R6P, AA, UM-3 batteries for replacement.
- Be sure the polarities are correct. (See the illustration inside the battery compartment.)
- Remove the batteries if the remote control transmitter will not be used for an extended period of time.
- If batteries leak, dispose of them immediately. Avoid touching the leaked material or letting it come in contact with clothing, etc. Clean the battery compartment thoroughly before installing new batteries.
- When replacing the batteries, always replace both batteries with new ones.

We greatly appreciate your purchase of the AVR-800. To be sure you take maximum advantage of all the features the AVR-800 has to offer, read these instructions carefully and use the set properly. Be sure to keep this manual for future reference should any questions or problems arise.

ACCESSORIES

Check that the following parts are included in addition to the main unit:

- Operating instructions 1
- Warranty (for North American model only) 2
- Remote control unit (RC-169) 1
- R6P/AA batteries 2
- AM loop antenna 5
- FM indoor antenna 6

INSTALLATION PRECAUTIONS

Using this receiver or other electronic equipment containing microprocessors simultaneously with a tuner or TV may result in noise in the sound or picture.

- If this should happen, take the following steps:
- Keep the receiver as far as possible from the tuner or TV set.
- Install the antenna lines of the tuner or TV as far as possible from the receiver's power cord and connection cables.
- This problem is especially frequent when using indoor antennas or 300 ohm feeder lines. We recommend using outdoor antennas and 75 ohm coaxial cables.

A note on stacking

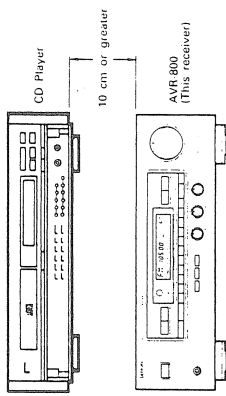

For cooling purposes, do not place another AV component directly on top of the receiver. Be sure to leave a space of at least 10 cm.

TABLE OF CONTENTS

1	Introduction	2
	• Note on Use	2
2	Names of Parts	3~5
	• Front Panel	3
	• Remote Control Unit	4
	• Rear Panel	4
3	Remote Control Unit	6
4	Multi Function Display (MFD)	7
5	Connections	7~9
6	Playback	9, 10
7	Recording	10
8	Tape Monitor Function	10
9	Using Headphones	10
10	Listening to the Radio	11
11	Surround Playback	12~14
	• Surround Modes	12
	• Using Dolby Pro Logic Surround	12, 13
	• Other Surround Modes	13
	• Using the Personal Memory	14
	• Operations Possible in the Various Surround Modes	14
12	Initialization of the Microprocessor	14
13	Troubleshooting	15
14	Last Function Memory	15
15	Specifications	15
	DENON SERVICE NETWORK	76, 77

System codes for Denon tape decks and CD players are set in this remote control unit.

Tape deck system buttons
With these buttons, a Denon remote controllable tape deck can be controlled directly. For details, refer to the tape deck's operating instructions. Note that operation may not be possible for some models.

- ▶ : Forward play
- ◀ : Reverse play
- : Stop
- ◀▶ : Rewind
- ▶◀ : Fast-forward
- A/B : Switching between decks A and B for double decks

CD system buttons
With these buttons, a Denon remote controllable CD player can be controlled directly. For details, refer to the CD player's operating instructions. Note that operation may not be possible for some models.

- ▶ : Play
- : Pause
- ◀▶ : Stop
- ▶◀ : Auto search (reverse and forward)
- DISC-SET : CD changer, disc skip

→ Continued

5 CONNECTIONS

Connecting the antenna terminals

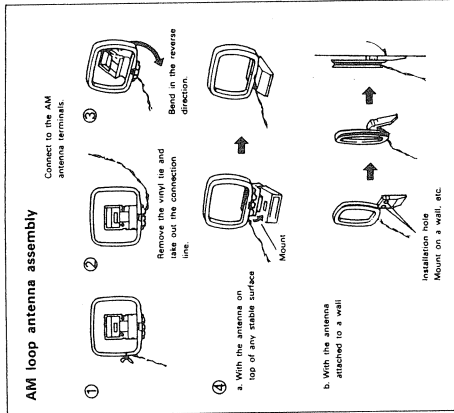

ANTENNA INSTALLATION

FM ANTENNA
The supplied T-type indoor FM antenna (300 ohms) can be used inside wooden houses for receiving local FM stations and other strong FM signals. Stretch out the ends of the antenna and mount the antenna on the wall or ceiling where optimum reception is achieved. FM T-type antennas may not consistently ensure stable reception, due to environment changes. In such cases, the FM T-type antenna should only be used temporarily until an outdoor FM antenna has been installed.

When connecting an outdoor FM antenna, the use of 75 ohm coaxial cable (3C-2V, 5C-2V) is strongly recommended. Using a 300-ohm feeder cable will cause noise and you will not be able to achieve the high sound quality the built-in tuner is capable of delivering.

OUTDOOR ANTENNA

Assemble the included AM loop antenna as shown in the diagram, then place it in a position where reception is good. In some cases reception is better if the polarities are inverted. AM broadcasts will not be received well if the loop antenna is not connected or if it is connected but near a metal part.

Attach the loop antenna even when using an outdoor AM antenna.

Adjust the loop antenna to obtain optimum reception. Where broadcast stations are distant and only weak signals are received, or where signals are blocked, it is best to install an outdoor AM antenna.

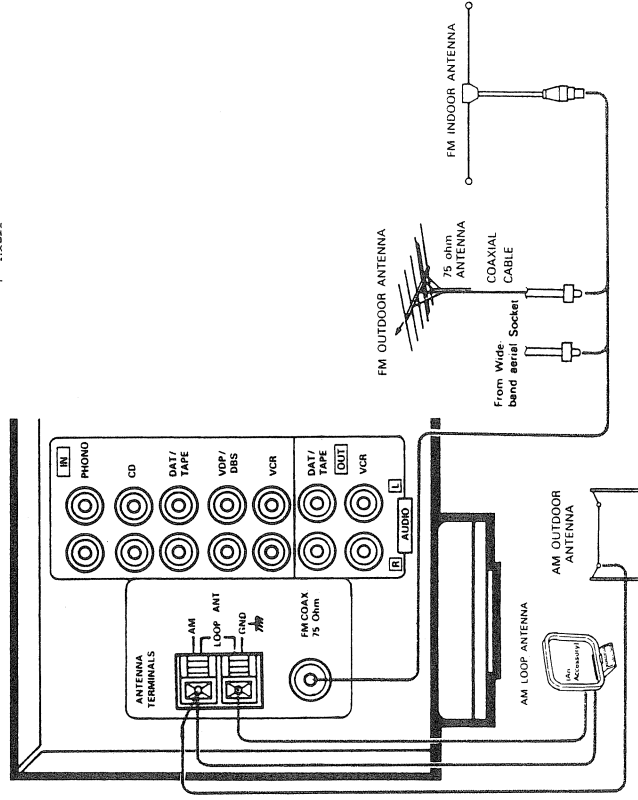

4 MULTI FUNCTION DISPLAY (MFD)

The MFD indicates the operating modes when operations are performed and when PANEL button is pressed.

■ FLD (Fluorescent Light Display)

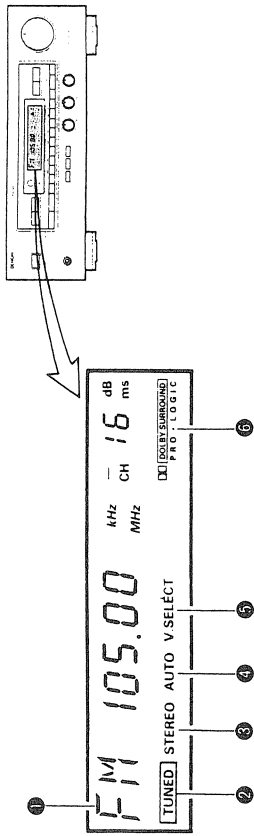

1 MULTI FUNCTION DISPLAY

Normally the reception frequency is displayed when the function is set to tuner, and the surround mode is displayed when the function is set to other positions. The display also indicates various other information according to the buttons pressed.

2 TUNED (TUNED indicator)

This indicator lights when broadcast signals are received.

3 STEREO (Stereo Indicator)

The STEREO indicator will automatically light up when a stereo broadcast is received.

To check the settings of the different modes

1. Press the PANEL button.

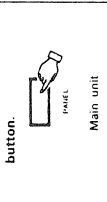

Either hold the PANEL button in or press it repeatedly to display the settings for the different modes.

FLD OFF

Turning the FLD off.

1. Press and hold in the PANEL button.

The FLD display changes continuously and finally turns off. Now when a button is pressed, the related display appears for a few seconds then turns off automatically.

2. Turning the FLD back on.

Press the PANEL button once again.

4 AUTO TUNING (AUTO TUNING Indicator)

This indicator lights when the auto tuning mode is selected by pressing the TUNING MODE button.

5 V SELECT (VIDEO SELECT Indicator)

This indicator lights when the video monitor output is fixed in the video select mode.

6 DOLBY SURROUND Indicator

This indicator lights when DOLBY PRO LOGIC, 3CH, LOGIC are selected.

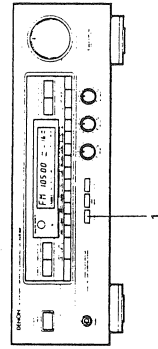

Audio Section

- Do not plug in the power cord until all connections have been completed.
- Be sure to connect the left and right channels properly (left with left, right with right).
- Insert the plugs securely. Incomplete connections will result in the generation of noise.

- Noise that binding pin plug cords together with power cords or placing them near a power transformer will result in the introduction of hum or other noise.
- If hum or other noise is produced when the ground wire is connected, disconnect it.
- Noise or humming may be generated if a connected component is used independently without turning the power of the AVR-800 on. If this happens, turn on the power of the AVR-800.

NOTE:
The receiver cannot be used with MC cartridges directly. Use a separate head amplifier or step-up transformer.

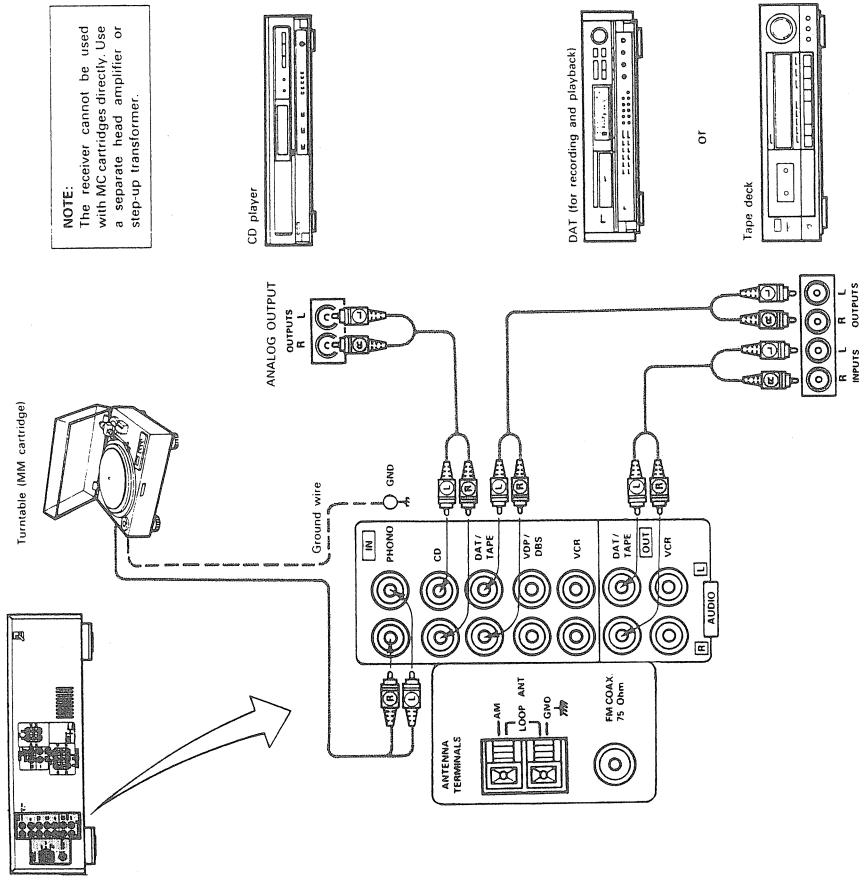

Video Section

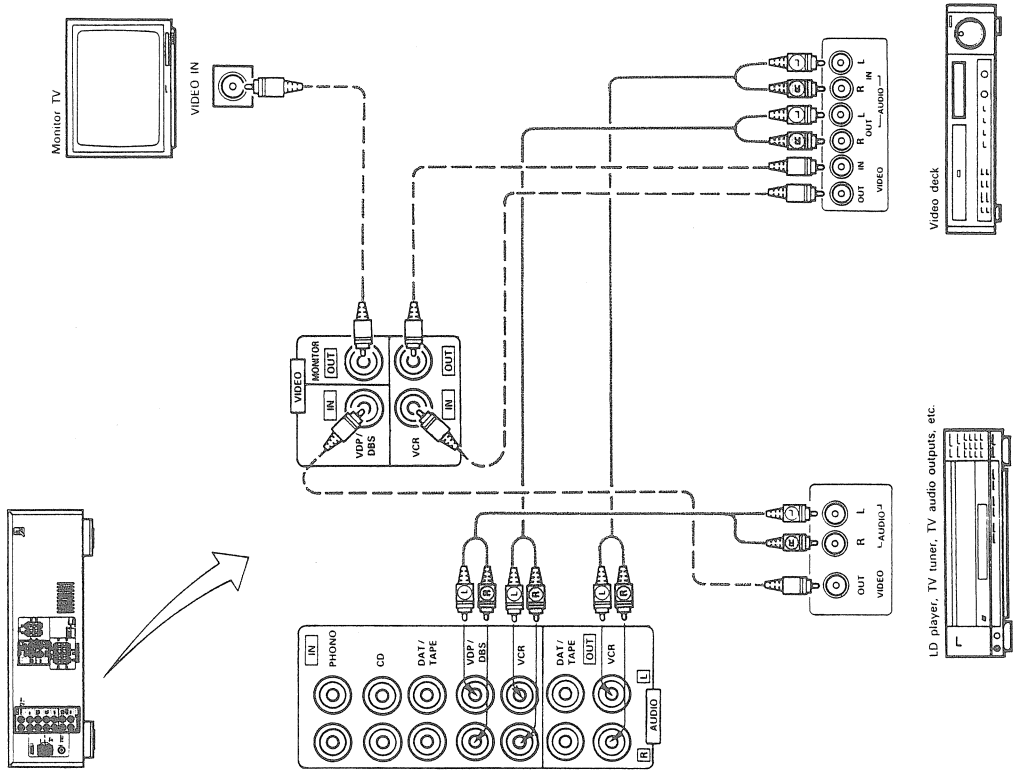

Continued

6 PLAYBACK

Preparations for Playback

- Check the connections
- Check that all connections are proper, referring to the connections diagrams (pages 7 to 9).

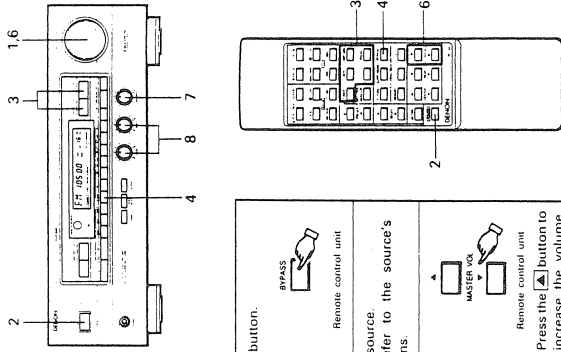

Playing the program source (normal stereo playback)

<p>1. Set the MASTER VOLUME control to the minimum.</p>	<p>4. Press the BYPASS button.</p>
<p>2. Press the POWER button to turn the power on. The muting mode is set for several seconds, after which the STANDBY LED flashes for several seconds.</p>	<p>5. Start playback the source. For instructions, refer to the source's operating instructions.</p>
<p>3. Select the source to be played.</p> <p>Audio function button</p> <p>Example:</p> <p>PHONO, CD or TUNER can be selected directly.</p> <p>The source switches as shown above MFD.</p>	<p>6. Adjust the volume.</p> <p>Turn the control clockwise to increase the volume, counterclockwise to decrease it.</p> <p>Press the button to increase the volume, the button to decrease it.</p>
<p>Video function button</p> <p>Example:</p> <p>VDP/DBS and VCR can be selected directly.</p> <p>The source switches as shown above MFD.</p>	<p>7. Adjust the left/right balance.</p> <p>Turn the control counterclockwise to reduce the volume of the right channel, clockwise to reduce the volume of the left channel.</p>
<p>8. Adjust the tone.</p> <p>Turn the control clockwise to increase the bass, counterclockwise to decrease it.</p> <p>Turn the control clockwise to increase the treble, counterclockwise to decrease it.</p>	<p>NOTE: The sound may be interrupted if switches are operated during playback. This is because the muting circuit is activated to prevent switching noise.</p>

Speaker System Connections

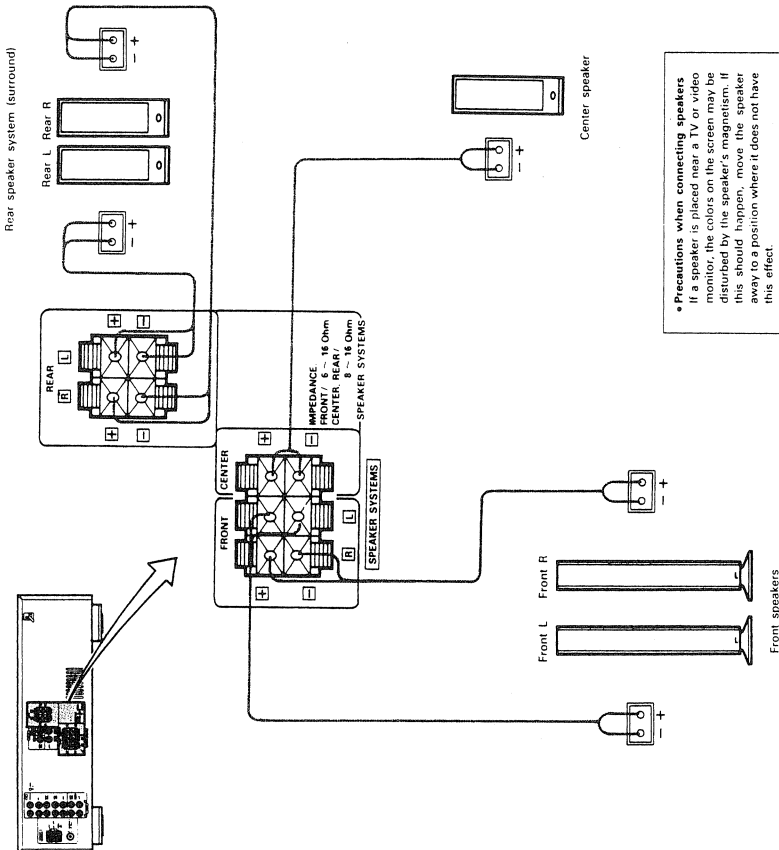

- This receiver can accommodate connections of a total of five speakers including one set of front speakers, one set of rear speakers, and one center speaker.
- Connect the speaker terminals with the speakers making sure that like polarities are matched (⊕ with ⊕, ⊖ with ⊖). Mismatching of polarities will result in weak central sound, unclear orientation of the various instruments, and the sense of direction of the stereo being impaired.
- When making connections, take care that none of the individual conductors of the speaker cord come in contact with adjacent terminals, with other speaker cord conductors, or with the rear panel.
- Speaker Impedance**
 - Speakers with an impedance of 6 to 16 ohms can be connected for use as front speakers 8 to 16 ohms can be connected for use as center and rear speakers.
 - Using speakers with an impedance other than the specified one may result in damage. Be sure to use speakers of the specified impedance.

Preparing the cord

- Peel off the sheath.
- Twist the wires.

Connecting the center and rear speaker terminals.

- Press the lever.
- Insert the cord and release the lever.

Precautions when connecting speakers
If a speaker is placed near a TV or video monitor, the colors on the screen may be distorted by the speaker's magnetism. If this occurs, move the speaker away from the TV or video monitor to prevent this effect.

8 Simulcast playback (playing different video and audio sources simultaneously)

- Follow steps 1 to 3 under "Playing the program source".
- Press the VIDEO SELECT button until the desired video source is displayed on the MFD.

Main unit
Remote control unit

VDP/DBS
VCR

The source switches as shown above.
- Follow steps 4 to 8 under "Playing the program source".

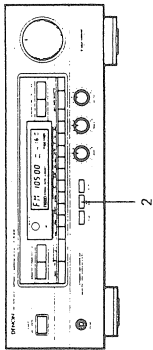

3 Cancelling simulcast playback

- Press the VIDEO SELECT button again.
- Press the video function button on the main unit or remote control unit.

4 Using the muting function

Use this to turn off the audio output temporarily.

- Press the MUTING button.

Muting

This function can only be set from the remote control unit.

The STANDBY LED flashes when the muting function is set.
- Press the MUTING button again. The muting function is cancelled.

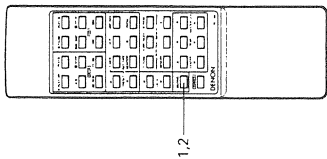

8 TAPE MONITOR FUNCTION

When playing a DAT or tape deck

Use this function to switch between the DAT or tape deck and the input (source) selected with the audio or video function buttons.

- Follow steps 1 and 2 under "Playing the program source".
- Select the deck to be played.

Main unit
Remote control unit

DAT/TAPE

The source switches as shown at the left.

SOURCE
- Follow steps 5 to 8 under "Playing the program source".

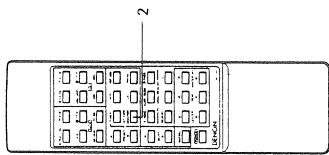
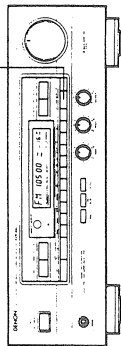

Monitoring the recording on a three-headed tape deck

The sound actually being recorded can be monitored during recording when a three-headed tape deck is used.

- Select the deck to be monitored.

Main unit
Remote control unit

DAT/TAPE

The source switches as shown at the left.

SOURCE
- Follow steps 1 to 3 under "Playing the program source".
- Start recording on the tape deck. For instructions, refer to the component's operating instructions.
- Press the three-headed tape deck's source/tape button to monitor the recording.

NOTE:
Also refer to the three-headed tape deck's operating instructions.

7 RECORDING

Recording the program source (recording the source currently being monitored)

- Follow steps 1 to 3 under "Playing the program source".
- Start recording on the tape or video deck. For instructions, refer to the component's operating instructions.

NOTE:
The recording source switches if the audio function, video function, personal memory "1" or "2" or tuner preset buttons are pressed during recording. Do not press these buttons during recording.

Simultaneous recording

The signals of the source selected with the function selector button are output simultaneously to the DAT/TAPE and VCR REC OUT jacks. If a total of two tape and/or video decks are connected and set to the recording mode, the same source can be recorded simultaneously on both decks. In addition, if the TAPE MONITOR (DAT/TAPE) button is pressed, the audio signals from the tape deck are output to the VCR AUDIO REC OUT jacks.

9 USING HEADPHONES

The sound from the speakers can be turned off using the OUTPUT button to listen to the sound over the headphones only, for example at night.

- Press the OUTPUT button.

Output



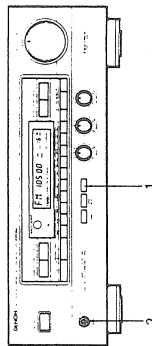

"H/P ONLY" appears on the MFD.
- Insert the headphones' plug into the headphones' jack.



Cancelling
Either press the OUTPUT button again or press the POWER button to turn off the power.

10 LISTENING TO THE RADIO

Tuning

<p>1 Set the input function to "TUNER".</p>  <p>Main unit</p>	<p>2 Select the reception band.</p>  <p>Main unit</p> <p>There is a change as mentioned at the left, and indication ① inside the MFD changes.</p> <p>FM</p> <p>AM</p>	<p>3. Select the tuning mode.</p>  <p>Main unit</p> <p>AUTO</p> <p>MANUAL</p> <p>Set the auto mode for automatic tuning, the manual mode for manual tuning.</p>	<p>4. Tune in the station.</p>  <p>Main unit</p> <p>In the manual tuning mode: Press the UP button once to increase the frequency by one step, the DOWN button once to decrease the frequency by one step. The frequency changes continuously when the buttons are held in. The "TUNED" indicator ② lights on the MFD when a station is tuned in. In the auto tuning mode: When the UP or DOWN button is pressed, automatic searching begins, and searching stops when a station is tuned in.</p>
--	--	--	--

Storing stations at the preset buttons

- Follow steps 1 to 4 under "Tuning" to tune in a station.
- Press the MEMORY button.
The "CH" indicator on the MFD flashes.
- Select the preset channels.
Main unit: 1 → 4 → 8 → 12 → 16
Remote control unit: PRESET → 16
Main unit: 1 → 4 → 8 → 12 → 16
Remote control unit: PRESET → 16
- Press the MEMORY button that you want to store to memory.

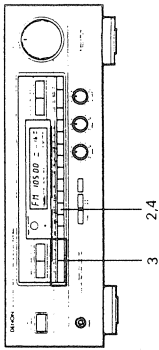

- NOTES:
- The preset memory standby mode is set for 10 seconds when the MEMORY button is pressed.
 - The preset memory standby mode is cancelled if any button other than preset buttons, the MEMORY button is pressed.

Recalling stations with the preset buttons

First store stations at the preset buttons using the above procedure.

- Select the preset channels.
Main unit: 1 → 4 → 8 → 12 → 16
Remote control unit: PRESET → 16
Main unit: 1 → 4 → 8 → 12 → 16
Remote control unit: PRESET → 16

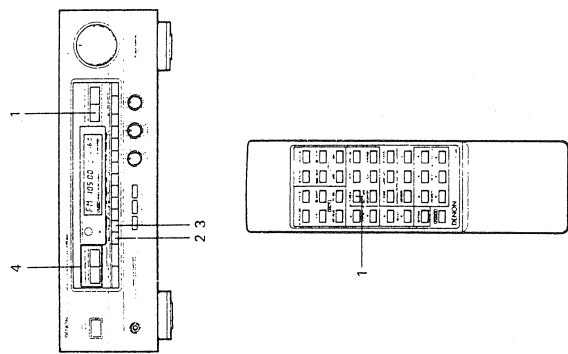
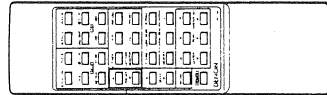

MFD display

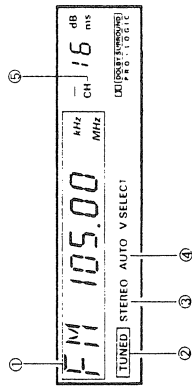

- NOTES:
- When in the auto tuning mode on the FM band, the "STEREO" indicator ③ lights on the MFD when a stereo broadcast is tuned in. At open frequencies, the noise is muted and the "TUNED" ② and "STEREO" ③ indicators turn off.
 - When the manual tuning mode is set, FM stereo broadcasts are received in monaural and the "STEREO" indicator ③ turns off.

→ Continued

• **Speaker volume adjustment and Dolby Pro Logic mode**

To obtain the maximum surround effect, use the test tones to adjust the volume and balance of the speakers for the best balance for the listening position and so that the sound from all the speakers is heard at the same level. Set the master volume control to a suitable level, then adjust using the following procedure.

1. Press the **T TONE** button.
 - Test tones are produced from the speakers in the order shown below, at 4 second intervals for the first two cycles, 2 second intervals after that.
 - For the Dolby 3CH Logic mode:
 - [FL] → [C] → [FR] → [S]
 - [FL] → [C] → [FR]
2. To increase the level of the center speakers.
 - [CENTER] → [T TONE]
3. To decrease the level of the center speakers.
 - [T TONE]
4. To increase the level of the rear speakers.
 - [REAR] → [T TONE]
5. To decrease the level of the rear speakers.
 - [REAR]
6. Press the **T TONE** button again.
 - [T TONE]

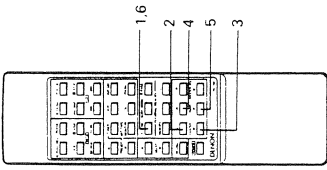

• **Other Surround Modes**

- **HALL mode / STUDIO mode**

1. Set the **HALL mode / STUDIO mode**.
 - [HALL] → [STUDIO]
2. Play the desired software.
3. Adjust the volume.
 - [MASTER VOL]
4. Adjust the level of the center and rear channels. Adjust the levels according to the source, using the Dolby Pro Logic settings as reference.
5. Adjust the delay time as desired.

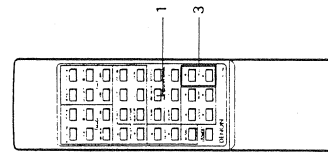
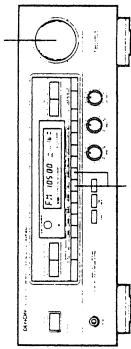

Listening position and optimum delay time for playback with Dolby Pro Logic surround

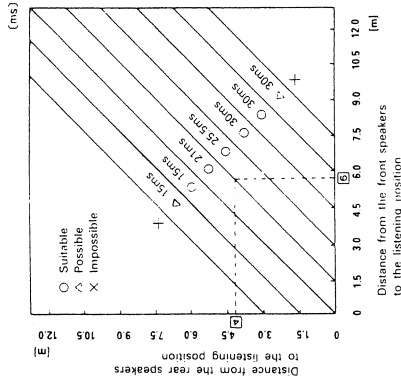

• **Setting the delay time**

The optimum delay time will differ depending on the listening position. Referring to the chart at right, set the optimum delay time for your room's space and seating position. For example, when the distance from the front speakers to the listening position is 6 m and that from the rear speakers to the listening position is 4 m, the optimum delay time will be 21 ms. The variable range of the delay time differs depending on the mode. For details about the variable range, see Page 14.

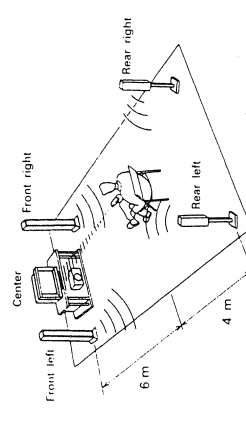

1. To increase the delay time.
 - [DELAY]
2. To decrease the delay time.
 - [DELAY]

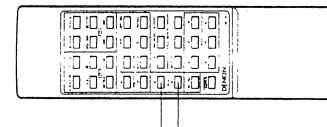
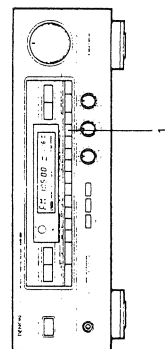

- Once the delay time is set, there is no need to readjust it unless you change the speaker system or the listening position.
- It is available to memorize the adjusted values of delay time and rear (center) level for each surround mode.

Using the Personal Memory

Surround mode settings and the input function can be stored at personal memory buttons "1" and "2", then recalled directly from any surround mode simply by pressing button "1" or "2".

1 Storing the setting in the personal memory

1. Set the desired surround mode and input function.

2. Press the personal memory button.

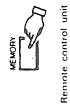

Remote control unit

(The memory setting mode is set and the indicator on the MFD flashes.)

3. Press the desired personal memory button ("1" or "2").

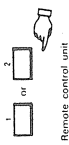

Remote control unit

4. "M 1 [2] SET" appears on the MFD indicating that the setting has been stored.

NOTES:

- The memory setting mode is set for 6 seconds. If any button other than personal memory button "1" or "2" is pressed, the memory setting mode is cancelled.

2 Recalling the personal memory

5. Press the personal memory button ("1" or "2") at which the desired setting was stored.

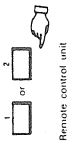

Remote control unit

6. The surround mode and input function switch automatically.

NOTES:

- Personal memory buttons "1" and "2" will not function during the tape monitor mode.
- The surround mode recalled with the PERSONAL MEMORY "1" or "2" button is the same as the mode selected with the surround mode button. Thus, if the parameters of the surround mode which was stored in the memory are cleared, when the mode is recalled it is set to the initial values.
- Upon shipment from the factory, the "DOLBY PRO LOGIC" mode is stored at personal memory "1"; the "HALL" mode at personal memory "2". The input function is set to VDP/DBS for both "1" and "2".
- Do not press personal memory buttons "1" or "2" buttons during recording on the cassette deck.

Operations Possible in the Various Surround Modes

The following is a list of the buttons and functions which can be operated during the different surround modes. Figures in parentheses indicate adjustment ranges.

	OUTPUT	CENTER LEVEL	REAR LEVEL	CENTER MODE	3CH LOGIC	TEST TONE	DELAY TIME
BYPASS	<input type="radio"/>	X	X	△*1	X	X	X
DOLBY PRO LOGIC	<input type="radio"/>	<input type="radio"/>	<input type="radio"/>	<input type="radio"/>	<input type="radio"/>	<input type="radio"/>	<input type="radio"/>
	<input type="radio"/>	<input type="radio"/>	<input type="radio"/>	<input type="radio"/>	<input type="radio"/>	<input type="radio"/>	<input type="radio"/>
	<input type="radio"/>	<input type="radio"/>	<input type="radio"/>	<input type="radio"/>	<input type="radio"/>	<input type="radio"/>	<input type="radio"/>
DOLBY 3CH LOGIC	<input type="radio"/>	<input type="radio"/>	<input type="radio"/>	<input type="radio"/>	<input type="radio"/>	<input type="radio"/>	<input type="radio"/>
	<input type="radio"/>	<input type="radio"/>	<input type="radio"/>	<input type="radio"/>	<input type="radio"/>	<input type="radio"/>	<input type="radio"/>
HALL	<input type="radio"/>	X	X	△*1	X	X	<input type="radio"/>
STUDIO	<input type="radio"/>	X	X	△*1	X	X	<input type="radio"/>

△: Operation possible X: Operation not possible

*1 Switches to the Dolby Pro (3CH) Logic for any modes other than Dolby Pro (3CH) Logic. The level of the center and rear channels can be adjusted by 2 dB step. The delay time can be set by 1.5 ms step.

- The sound may be distorted for some sources if the rear level is raised during surround playback. If this happens, lower the rear level.

12 INITIALIZATION OF THE MICROPROCESSOR

When the indication of the MFD display is not normal or when the operation of the unit does not show the reasonable result, the initialization of the microprocessor is required by the following procedure.

1. Switch off the unit and remove the AC power cord from the wall outlet.
2. Hold the following 2 buttons of the main unit at the same time (as illustrated in the diagram below, ① AUDIO FUNCTION button, ② VIDEO FUNCTION button) and plug the power cord into the outlet.

3. Check that the entire MFD display is flashing with an interval of about 1 second, and release your fingers from the 2 buttons.
4. Switch on the unit and the microprocessor will be initialized. The input function is set to tuner with the bypass mode automatically.

NOTE:

- When the unit does not show the result of above 3 and 4, repeat the procedure from 1 again.
- When the microprocessor is initialized, all settings you have made are reset to the factory presettings.

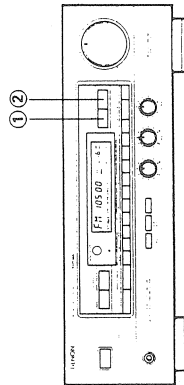

Initial parameter values for the different modes

	OUTPUT	CENTER LEVEL	REAR LEVEL	CENTER MODE	3CH LOGIC	DELAY TIME
BYPASS	ON	—	—	—	—	—
DOLBY PRO LOGIC	ON	-12dB	-12dB	NORMAL	OFF	21msec
HALL	ON	—	-12dB	—	—	21msec
STUDIO	ON	—	-12dB	—	—	21msec

- INPUT FUNCTION : TUNER
- Reception band : FM
- Reception mode : AUTO
- Reception frequency : 87.5MHz (for North American models) / 87.50MHz (for multi-voltage models)
- PERSONAL MEMORY 1 INPUT : VDP/DBS
- SURROUND MODE : DOLBY PROLOGIC
- PERSONAL MEMORY 2 INPUT : VDP/DBS
- SURROUND MODE : HALL

13 TROUBLESHOOTING

If a problem should arise, first check the following:
 1. Are the connections correct?
 2. Have you operated the amplifier according to the Operating Instructions?
 3. Are the speakers, turntable, and other components operating properly?
 If the receiver is not operating properly, check the items listed in the table below. Should the problem persist, there may be a malfunction. Disconnect the power immediately and contact your store of purchase.

Symptom	Cause	Measures	Page
MFD not lit and sound not produced when power switch set to on.	<ul style="list-style-type: none"> Power cord not plugged in securely. 	<ul style="list-style-type: none"> Check the insertion of the power cord plug. 	5
MFD lit but sound not produced.	<ul style="list-style-type: none"> Speaker cords not securely connected. OUTPUT button is off. Improper position of the audio function selector. VOLUME control set to minimum. MUTING is on. 	<ul style="list-style-type: none"> Connect securely. Press the OUTPUT button. Set to a suitable position. Turn volume up to suitable level. Switch off MUTING. 	9 10 9 9 10
-PROTECT- display appears multi-function display.	<ul style="list-style-type: none"> Speaker terminals are short-circuited. Block the ventilation holes of the set. The unit is operating at continuous high power conditions and/or inadequate ventilation. 	<ul style="list-style-type: none"> Switch power off, connect speakers properly. Turn off the set's power, then ventilate it well to cool it down. Once the set is cooled down, turn the power back on. 	9
Sound produced only from one channel.	<ul style="list-style-type: none"> Incomplete connection of input/output cords. Left/right balance is off. 	<ul style="list-style-type: none"> Connect securely. Adjust balance knob properly. 	5, 9 7, 8
Positions of instruments reversed during stereo playback.	<ul style="list-style-type: none"> Reverse connections of left and right speakers or left and right input/output cords. 	<ul style="list-style-type: none"> Check left and right connections. 	8, 9
Sound seems distorted.	<ul style="list-style-type: none"> Rear level is too high. 	<ul style="list-style-type: none"> Set the rear level to lower level. 	13, 14
Common problems arising when listening to tapes and FM broadcasts, etc.	<ul style="list-style-type: none"> DAT/Tape monitor mode set. 	<ul style="list-style-type: none"> Press the DAT/TAPE button to set the source. 	10
Humming noise produced when record is playing	<ul style="list-style-type: none"> Ground wire of turntable not connected Incomplete PHONO jack connection. TV or radio transmission antenna nearby. 	<ul style="list-style-type: none"> Connect securely. Connect securely. Contact your store of purchase. 	8
Howling noise produced when volume is high.	<ul style="list-style-type: none"> Turntable and speaker systems too close together. Floor is unstable and vibrates easily. 	<ul style="list-style-type: none"> Separate as much as possible. Use cushions to absorb speaker vibrations transmitted by floor. If turntable is not equipped with insulators, use audio insulators (commonly available). 	-
Sound is distorted.	<ul style="list-style-type: none"> Stylus pressure too weak. Dust or dirt on stylus. Cartridge defective. 	<ul style="list-style-type: none"> Apply proper stylus pressure. Check stylus. Replace cartridge. 	-
Volume is weak.	<ul style="list-style-type: none"> MC cartridge being used. 	<ul style="list-style-type: none"> Replace with MM cartridge or use a head amplifier or step-up transformer. 	8
Receiver does not operate properly when remote control unit is used	<ul style="list-style-type: none"> Batteries dead. Remote control unit too far from receiver. Obstacle between receiver and remote. Different button is being pressed. + and - ends of battery inserted in reverse. 	<ul style="list-style-type: none"> Replace with new batteries. Move closer. Remove obstacle. Press the proper button. Insert batteries properly. 	- 6 6 6
Remote control unit			6

14 LAST FUNCTION MEMORY

This receiver is equipped with a last function memory which stores the input and output setting conditions as they were immediately before the power is switched off. This function eliminates the need to perform complicated resettings when the power is switched on. This receiver is also equipped with a back-up memory. This function provides approximately one week of memory storage with the power cord disconnected.

15 SPECIFICATIONS

- **Audio Section:**
 - (Power amplifier)
 - Front (main 2ch driven) 60W + 60W (8 ohms, 20 Hz - 20 kHz with 0.1% THD)
 - CENTER (center 1ch driven) 60W (8 ohms, 20 Hz - 20 kHz with 0.1% THD)
 - REAR (rear 2ch driven) 15W + 15W (8 ohms, 1 kHz with 0.5% THD)
 - (All properties shown are only for the power amplifier stage.)
 - Output terminals:**
 - Front: 6 to 16 ohms
 - Center: 8 to 16 ohms
 - Rear: 8 to 16 ohms
 - Line input (Each line input - FRONT SP OUT)**
 - Input sensitivity/impedance: 150 mV/47 k ohms PHONO (MM): 2.5 mV/47 kohms
 - Frequency response: 10 Hz to 50 kHz; ±3 dB
 - Tone control range: BASS: ±10 dB at 100 Hz
 - TREBLE: ±10 dB at 10 kHz
 - Signal-to-noise ratio** 92 dB (BYPASS)
 - Phono equalizer (PHONO input - REC OUT)**
 - RIAA deviation: ±1 dB (20 Hz to 20 kHz)
 - Signal-to-noise ratio: 74 dB (A weighting, with 5 mV input)
 - Rated output/Maximum output: 150 mV/8 V
 - Distortion factor: 0.03% (1 kHz, 1 V)
- **Tuner Section**
 - [FM] (note: μ V at 75 ohms, 0 dBf \sim 1×10^{-15} W)
 - Receiving Range: 87.50 MHz \sim 108.00 MHz
 - Usable Sensitivity: 1.0 μ V (11.2 dBf)
 - 50 dB Quieting Sensitivity: MONO 1.6 μ V (15.3 dBf)
 - STEREO 23 μ V (36.5 dBf)
 - MONO 80 dB
 - STEREO 75 dB
 - MONO 0.4%
 - STEREO 0.5%
 - Signal to Noise Ratio (IHF-A):
 - Total Harmonic Distortion (at 1 kHz):
- **Video Section**
 - Receiving Range: 522 kHz \sim 1611 kHz
 - Usable Sensitivity: 18 μ V
 - Signal to Noise Ratio: 50 dB
- **Standard video jacks**
 - Input and output level/impedance: 1 Vp-p/75 ohms
 - Frequency response: 2 Hz to 8 MHz \sim 10, \sim 3 dB
- **General**
 - Power supply: AC 230 V, 50 Hz (for Europe model)
 - AC 240 V, 50 Hz (for U.K. model)
 - Power consumption: 200 W
 - Maximum external dimensions: 434 (W) \times 142 (H) \times 325 (D) mm (17.3/32" \times 5.19/32" \times 12.51/64")
 - Weight: 9.1 kg (20 lbs. 1 oz)
- **Remote control unit**
 - System remote control RC-169:
 - Total buttons: 36
 - DENON system code
 - CD player: 6 buttons
 - Cassette deck: 6 buttons
 - AVR-800 fixed codes: 24 buttons
 - Batteries: R6P/AA Type (two batteries)
 - External dimensions: 55 (W) \times 18 (H) \times 180 (D) mm (2.11/64" \times 45/64" \times 7.3/32")
 - Weight: 110 g (Approx. 4 oz) (including batteries)

* For purposes of improvement, specifications and design are subject to change without notice.

MEMO:

WIRE ARRANGEMENT

In case of wires require unclasping or loosening to move the location to perform adjustment or part replacement, be sure to rearrange them neatly to restore properly in the same location as they were originally placed, or causing to produce a noise may occasionally occur.

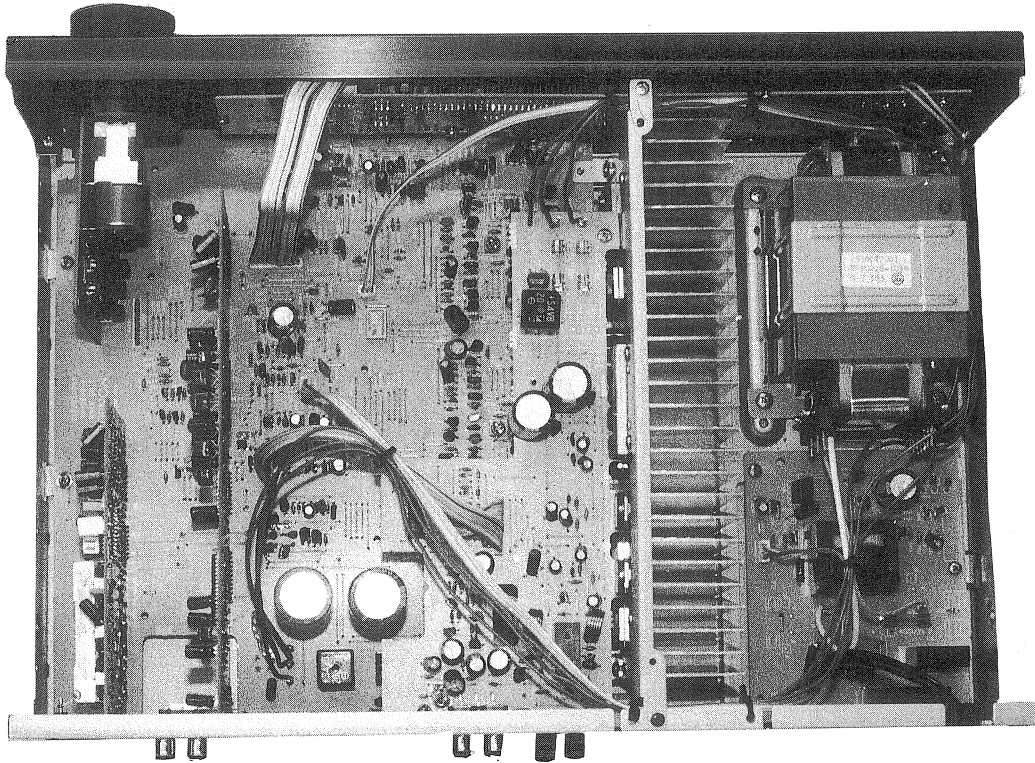

DISASSEMBLY

(To reassemble reverse disassembly)

1. Top Cover

Remove 4 screws ① and 2 screws ② .

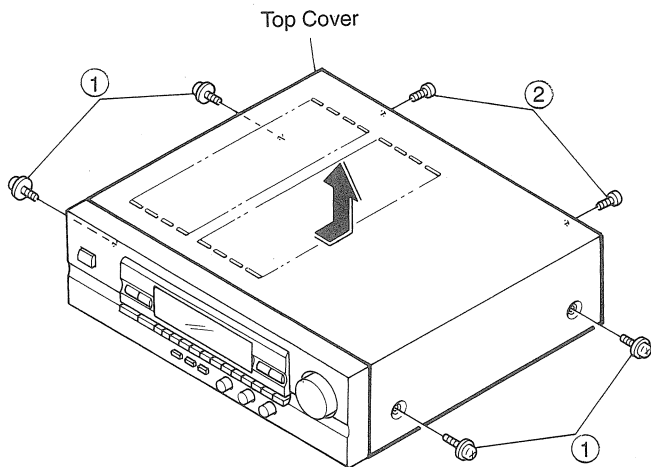

3. Front Mold Panel

- (1) Pull out Volume knob ④ and 3 round knobs ⑤ .
- (2) Remove 4 nuts ⑥ and nut ⑦ .
- (3) Remove 3 screws ⑨ .

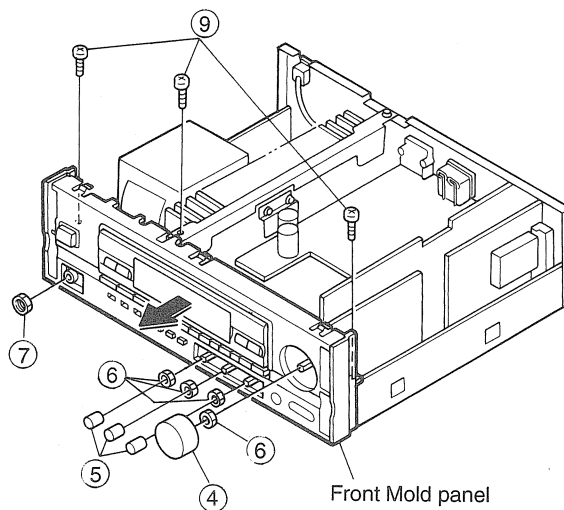

2. Front Aluminium Panel

Remove 3 screws ③ and undo hooks at 3 places.

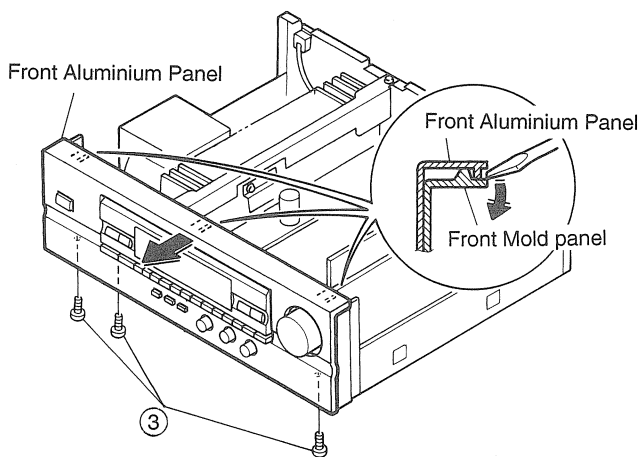

4. Rear Panel

- (1) Disconnect cord bush ⑩ .
- (2) Remove 5 screws ⑪ , and 10 screws ⑫ , and a screw ⑬ .

* Screws ⑫ is tighten.

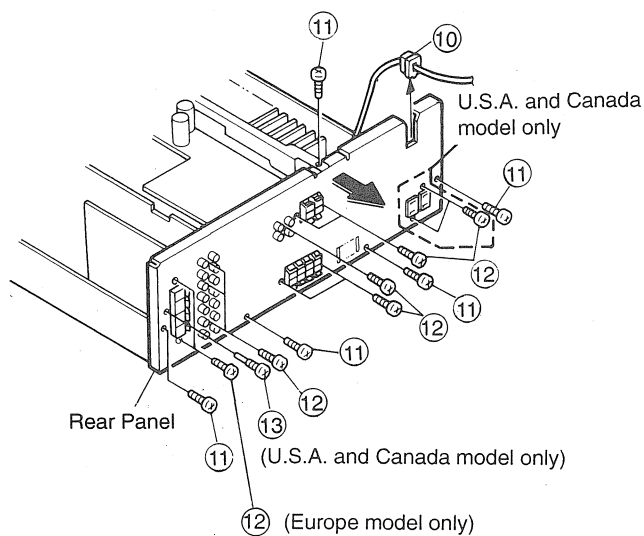

ADJUSTMENT

● TUNER SECTION
CONNECTION DIAGRAM OF MEASURING INSTRUMENTS

● FM

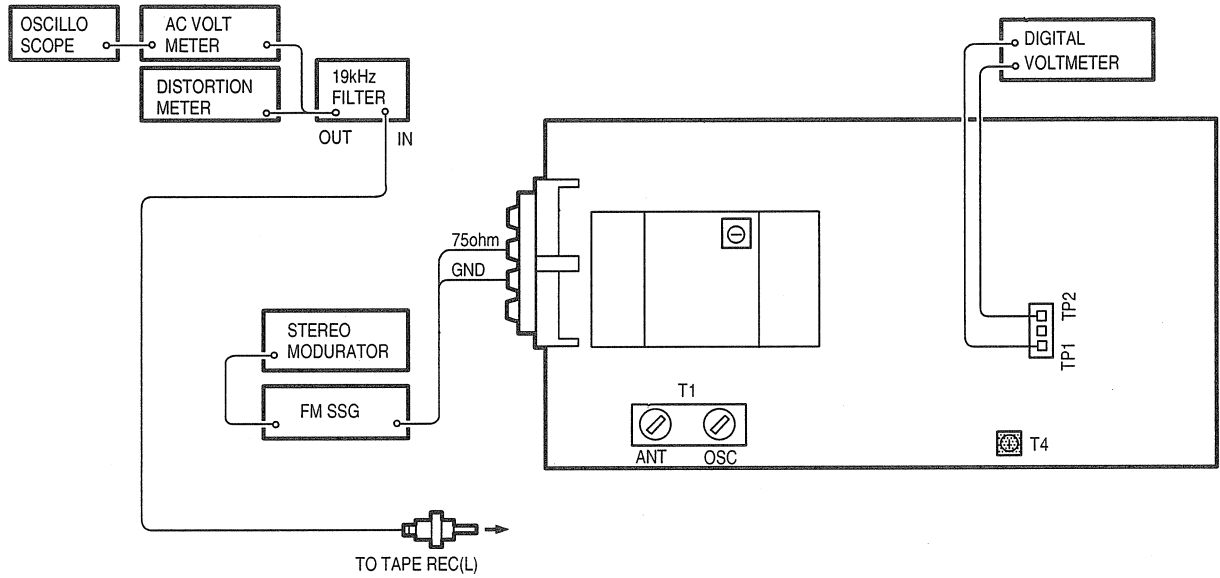

● AM

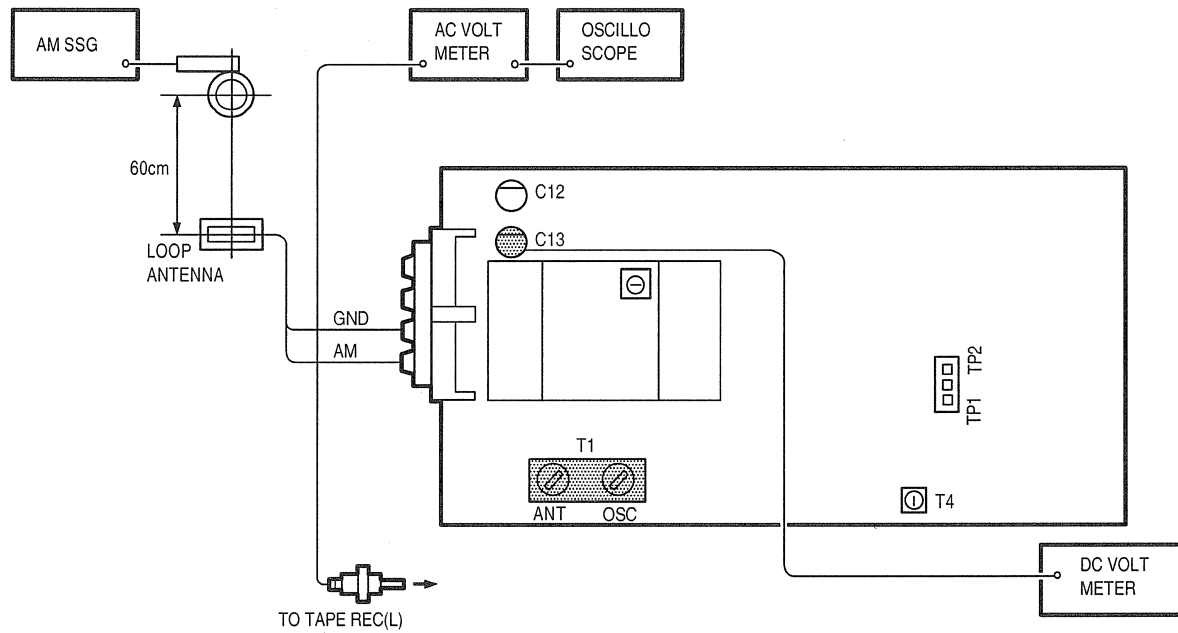

FM/MPX ALIGNMENT

Step	Alignment Item	Tuning Frequency Setting	Input			Output			Adjust		Remarks	
			Type	Frequency	Input Level	Modulation	Coupling	Type	Connect to	Points		Adjust to
1	Tuning Center	98.0MHz (98.00)	FM SSG	98.0 MHz (98.00)	60 dB μ	None	Antenna Terminal	Digital Voltmeter	T.P. 1,2	T4	\pm 50mV	Function : FM Mode : Auto

() are Europe model.

AM ALIGNMENT

Step	Alignment Item	Tuning Frequency Setting	Input			Output			Adjust		Remarks	
			Type	Frequency	Input Level	Modulation	Coupling	Type	Connect to	Points		Adjust to
1	Receiving Band Alignment	520 KHz (522 KHz)	AM SSG	520 KHz (522 KHz)	Input Level is not over to work A.G.C.	400 Hz 30%	Loop Antenna	Electric DC Voltmeter	C13 (+ Side) GND	T1 (OSC)	1.0 V \pm 100mV	Function : AM
		1710 KHz (1611 KHz)	AM SSG	1710 KHz (1611 KHz)	Input Level is not over to work A.G.C.	400 Hz 30%	Loop Antenna	Electric DC Voltmeter	C13 (+ Side) GND			less than 9.0V (check the voltage)
2	Tracking Alignment	600 KHz (603 KHz)	AM SSG	600 KHz (603 KHz)	Input Level is not over to work A.G.C.	400 Hz 30%	Loop Antenna	Audio V.M.	TAPE REC (L) -1	T1 (ANT)	Maximum Output	Function : AM
		1400 KHz (1404 KHz)	AM SSG	1400 KHz (1404 KHz)	Input Level is not over to work A.G.C.	400 Hz 30%	Loop Antenna	Audio V.M.	TAPE REC (C) -1			Maximum Output (check)

() are Europe model.

● Initiating (Memory clearing) Method

To clear memory contents of microcomputer and restore to the initial state, take the following steps;

1. Press power switch, turn off power of the unit, and set to standby mode.
2. Pull out power cord from wall outlet temporarily.
3. Insert power cord into outlet while simultaneously pressing two keys of AUDIO and VIDEO.
4. Press power switch to confirm that memory contents are cleared.

By completion of the above, the initial state is restored. In case the memory can not be cleared due to some reasons, repeat steps 1 through 3.

● AUDIO SECTION

Idling Current (1U-2650-1)

Required measurement equipment: DC Voltmeter

Arrangement

(1) Avoid direct blow from an air conditioner or an electric fan, and adjust the unit at normal room temperature 15°C ~ 30°C. (59°F ~ 86°F).

(2) Presetting

- POWER (Power source switch) → OFF
- MODE (Mode button) → BY PASS
- FUNCTION (Function button) → CD
- VOLUME (Volume control) → 0: fully counterclockwise (⤴ min.)
- BASS, TREBLE (Tone control) → 0: (Controls to center)
- SPEAKERS (Speaker terminal) → No load (Do not connect speaker, dummy resistor, etc.)

Adjustment

- (1) Remove top cover and set VR401, VR301 and VR302 of 1U-2650-1 or 1U-2650B-1 (Main Unit) at counterclockwise fully.
- (2) Connect DC Voltmeter to test points (Lch T.P.302, Rch T.P.301, CENTER ch T.P.401).
- (3) Connect power cord to AC Line, and turn power switch "ON".
- (4) Allow 15 minutes, and turn VR301, VR302 and VR401 clockwise (⤵) and adjust the TEST POINTS voltage to 1.5 mV ± 0.5 mV DC.
- (5) After 2 minutes from preset, turn VR301, VR302 and VR401 to set the voltage to 3 mV ± 0.5mV DC.

1U-2650-1 Main Unit (Component Side)

	UNIT No.
U.S.A. and CANADA	1U-2650
EUROPE	1U-2650B

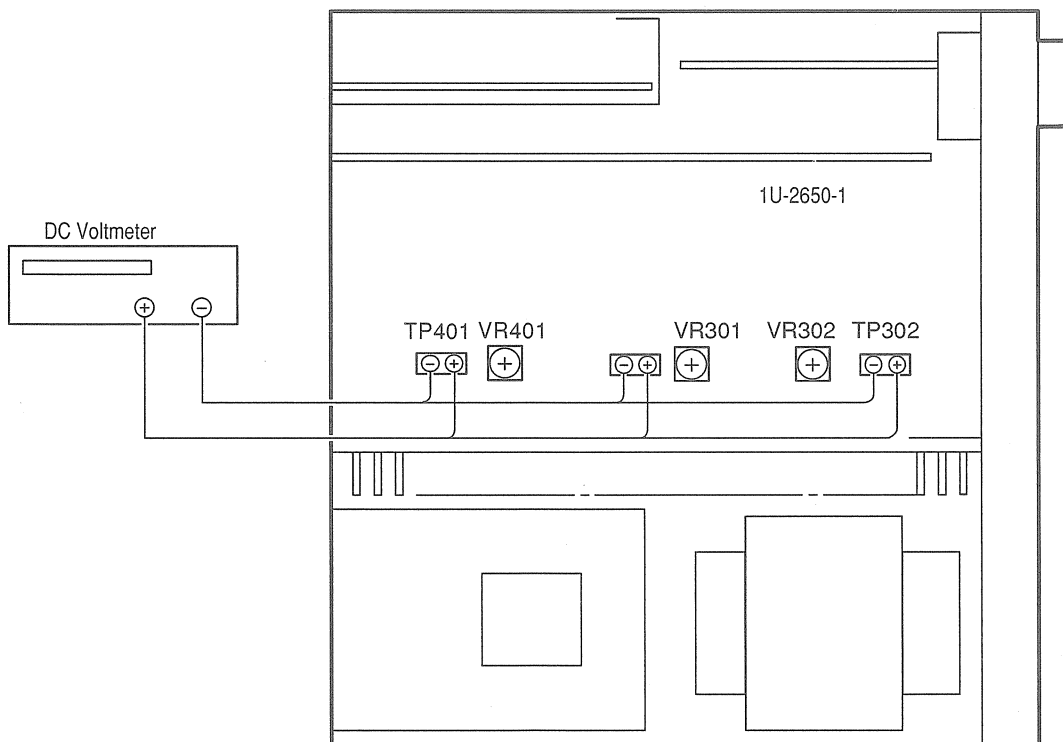

SEMICONDUCTORS

IC's

Note)
 Indications before IC numbers denote P.W.B. Name.
 MA : Main Amp P.W.B. Unit
 RE : Rear Amp P.W.B. Unit
 SU : Surround P.W.B. Unit

LA3401
 (SU: IC002)

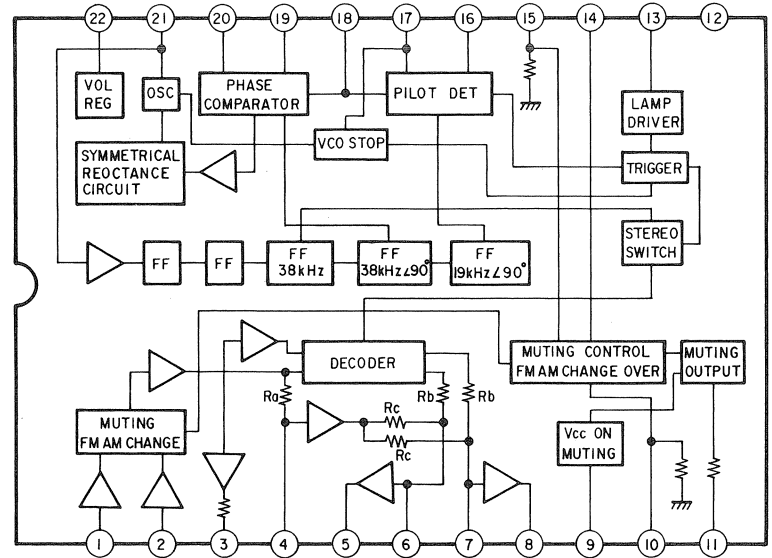
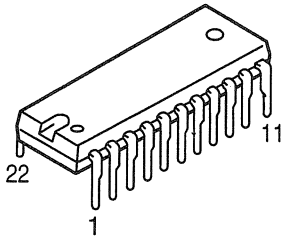

LA1265 (S)
 (SU: IC001)

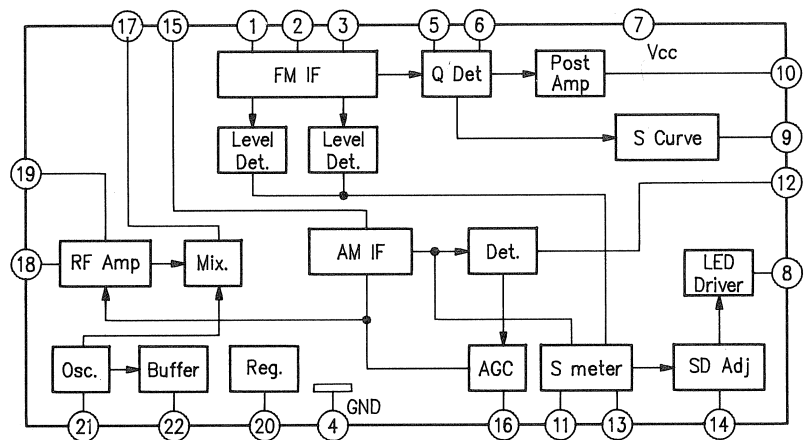
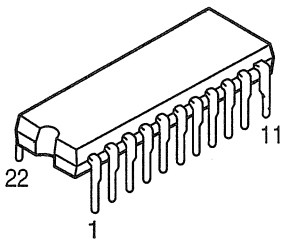

● IC PROTECTORS

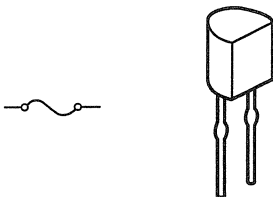

ICP-N15 (RE: IC552)
 ICP-N20 (RE: IC505, 506)

NJM2177AF
(SU: IC201)

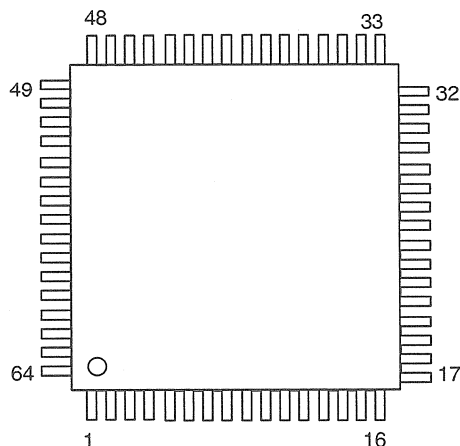

Pin No.	Pin Name	Pin No.	Pin Name	Pin No.	Pin Name
1	NC	23	NOISE-HPF	45	LPF-INV-IN
2	L-RECT-IC	24	NOISE-LPF	46	LPF-NINV-IN
3	R-BPF-OUT	25	S-OUT	47	NR-TC
4	R-BPF-IN	26	CENTER-CNT	48	NC
5	R-RECT-TC	27	MODE-CNT	49	NC
6	GND	28	L-OUT	50	VLR-TC3
7	AB-GATE	29	R-OUT	51	VCS-TC3
8	AB-HOLD-TC	30	L+R-OUT	52	VCS-TC2
9	L-AB-IN	31	L-R-OUT	53	VCS-TC1
10	L-AB-OUT	32	NC	54	VLR-TC1
11	L-IN	33	NC	55	VLR-TC2
12	L-INBUF-OUT	34	CENTER-MODE	56	S-RECT-OUT
13	R-INBUF-OUT	35	V _{CC}	57	C-RECT-OUT
14	R-IN	36	C-OUT	58	R-RECT-OUT
15	R-AB-OUT	37	S'-OUT	59	L-RECT-OUT
16	NC	38	IREF	60	S-RECT-TC
17	NC	39	NR-VCF	61	C-RECT-TC
18	R-AB-IN	40	NR-IN	62	L-BPF-OUT
19	NOISE-CNT-E	41	VREF	63	L-BPF-IN
20	NOISE-CNT-A	42	VREF	64	NC
21	NOISE-CNT-B	43	NR-WT		
22	NOISE-REF	44	LPF-OUT		

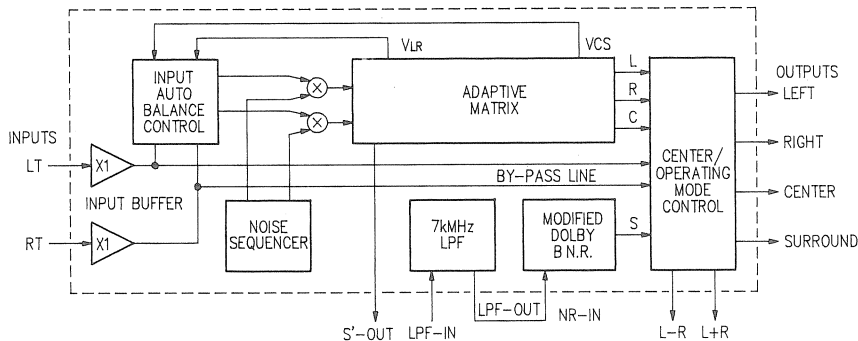

NJU9701G
(SU: IC202)

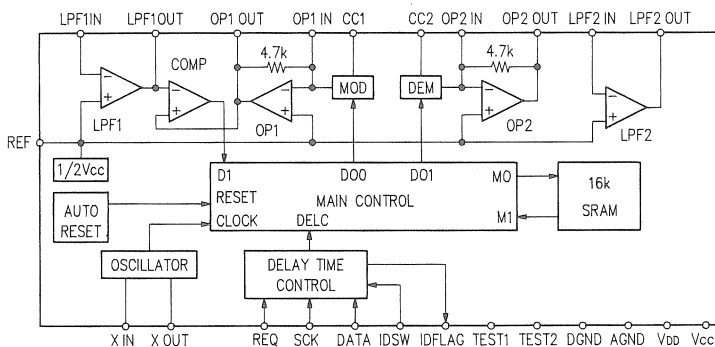
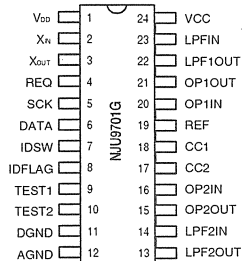

MSC1937-01 (RE: IC702)

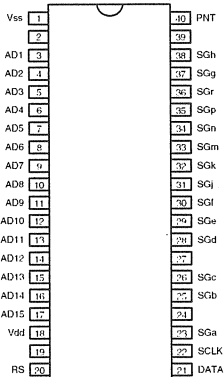
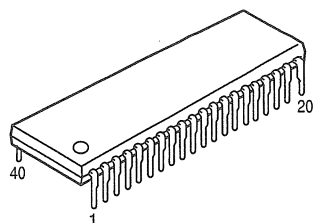

Pin No.	Terminal Function
1	Power Supply (+5V)
3	Digit 1 Output
17	Digit 17 Output
18	GND
19	—
20	POWER-ON-RESET
21	Data Input
22	Shift Clock Input
23	Segment a Output
38	Segment h Output
39	—
40	POINT Output

TMP87CH40AF
(MA: IC801)

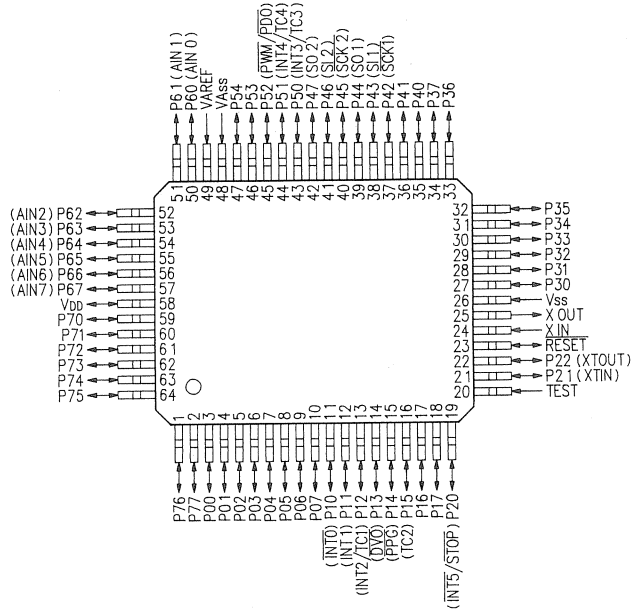
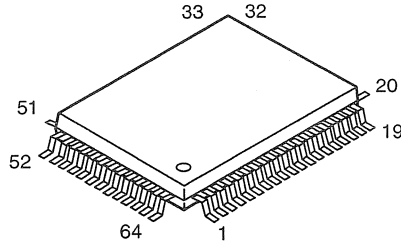

TMP87CH40AF Terminal Function

Pin No.	SYMBOL	Name	I/O	Det	Res	Ext	Ini	Function
1	P76	ST/MONO	O	-	Z	-	H	STEREO/MONO control signal ("L" at STEREO mode)
2	P77	No connection	I	-	Z	GND	-	No connection
3	P00	Video Control A	O	-	Z	-	H	Video input/output control ("L" at selection)
4	P01	Video Control B	O	-	Z	-	H	Video input/output control ("L" at selection)
5	P02	No connection	I	-	Z	GND	-	No connection
6	P03	No connection	I	-	Z	GND	-	No connection
7	P04	CK	O	-	Z	-	H	Serial delay time control output (NJU9701)
8	P05	REQ	O	-	Z	-	H	Delay time control output
9	P06	DATA	O	-	Z	-	L	Serial delay time control output
10	P07	SURR.	O	-	Z	-	H	Rear signal control
11	P10/INT0	Stop Power	I	Lv	Z	Pu	-	Stop power detect ("L" at stop power)
12	P11/INT1	PROTECTION	I	E&L	Z	Pu	-	Protective input ("H" at protection)
13	P12/INT2	L+R	O	-	Z	-	H	Rear signal control
14	P13/DV0	L-R	O	-	Z	-	H	Rear signal control
15	P14/PPG	CNT-E	O	-	Z	-	H	Test tone control
16	P15/TC2	CNT-A	O	-	Z	-	L	Test tone control
17	P16	CNT-B	O	-	Z	-	L	Test tone control
18	P17	NORMAL	O	-	Z	-	L	Center mode control
19	P20/INT5	WIDE	O	-	Z	Pu	H	Center mode control
20	TEST		I	-	-	-	-	Connect to GND
21	P21/XT1	BYPASS	O	-	Z	Pu	L	PRO LOGIC Change signal
22	P22/XT0	PRO LOGIC	O	-	Z	-	H	PRO LOGIC Change signal
23	RESET		I	-	-	-	-	Reset input
24	XIN		-	-	-	-	-	Oscillate circuit (4MHz)
25	XOUT		-	-	-	-	-	Oscillate circuit (4MHz)
26	Vss	GND	-	-	-	-	-	
27	P30	SP-FRONT	O	-	Z	Pu	H	Speaker relay control output
28	P31	SP-REAR	O	-	Z	Pu	L	Speaker relay control output
29	P32	SP-CENTER	O	-	Z	Pu	L	Speaker relay control output
30	P33	H/P	O	-	Z	Pu	H	Headphone relay control output
31	P34	POWER	O	-	Z	Pu	L	Power relay control output ("L" at ON)
32	P35	STANDBY-LED	O	-	Z	Pu	L	LED drive output for STANDBY indication ("L" at display lights)
33	P36	BYPASS	O	-	Z	Pu	L	PRO LOGIC change signal
34	P37	No connection	I	-	Z	GND	-	No connection
35	P40	VOL. UP	O	-	Z	Pu	L	Electrical volume control output (LB1639)

Pin No.	Symbol	Name	I/O	Det	Res	Ext	Ini	Function
36	P41	VOL. DOWN	O	-	Z	Pu	L	Electrical volume control output (LB1639)
37	P42/SCK1	CK	O	-	Z	Pu	L	Serial electrical volume control output (TC9176)
38	P43/SI1	ST	O	-	Z	Pu	L	Electrical volume control output
39	P44/SO1	DATA	O	-	Z	Pu	H	Serial electrical volume control output
40	P45/SCK2	FL-CK	O	-	Z	Pu	H	Serial Liquid Crystal Display control output (MSC1937)
41	P46/SI2	FL-RS	O	-	Z	Pu	L	Liquid Crystal Display control output
42	P47/SO2	FL-DATA	O	-	Z	Pu	H	Serial Liquid Crystal Display control output.
43	P50/INT3	REMOTE	I	E&L	Z	Pu	-	Remote control signal input
44	P51/INT4	CK	O	-	Z	Pu	L	Serial surround control signal output (LC7822)
45	P52/PWM	CE	O	-	Z	Pu	L	Surround control output
46	P53	DATA	O	-	Z	Pu	L	Serial surround control output
47	P54	No connection	I	-	Z	GND	-	No connection
48	VASS	GND	-	-	-	-	-	Analog reference GND for A/D conversion
49	VAREF	+5V	-	-	-	-	-	Analog reference voltage for A/D conversion. Connect to 5V
50	P60/AIN0	KEY1	I	Lv	Z	Pu	-	Button input
51	P61/AIN1	KEY2	I	Lv	Z	Pu	-	Button input
52	P62/AIN2	KEY3	I	Lv	Z	Pu	-	Button input
53	P63/AIN3	MODE	I	Lv	Z	Pu	-	AVC/AVR change signal
54	P64/AIN4	No connection	I	-	Z	GND	-	No connection
55	P65/AIN5	No connection	I	-	Z	GND	-	No connection
56	P66/AIN6	No connection	I	-	Z	GND	-	No connection
57	P67/AIN7	No connection	I	-	Z	GND	-	No connection
58	VDD	+5V	-	-	-	-	-	Connect to 5V
59	P70	CK	O	-	Z	-	L	Serial control output (LM7001)
60	P71	DATA	O	-	Z	-	L	Serial control output (LM7001)
61	P72	ST	O	-	Z	-	L	latch control
62	P73	TUNER MUTE	O	-	Z	-	H	Mute output ("H" at muting)
63	P74	TUNED SIGNAL	I	Lv	Z	Pu	-	Synchronous detect ("L" at synchronous)
64	P75	STEREO SIGNAL	I	Lv	Z	Pu	-	"L" at stereo receive mode

TC9176P (SU: IC262)

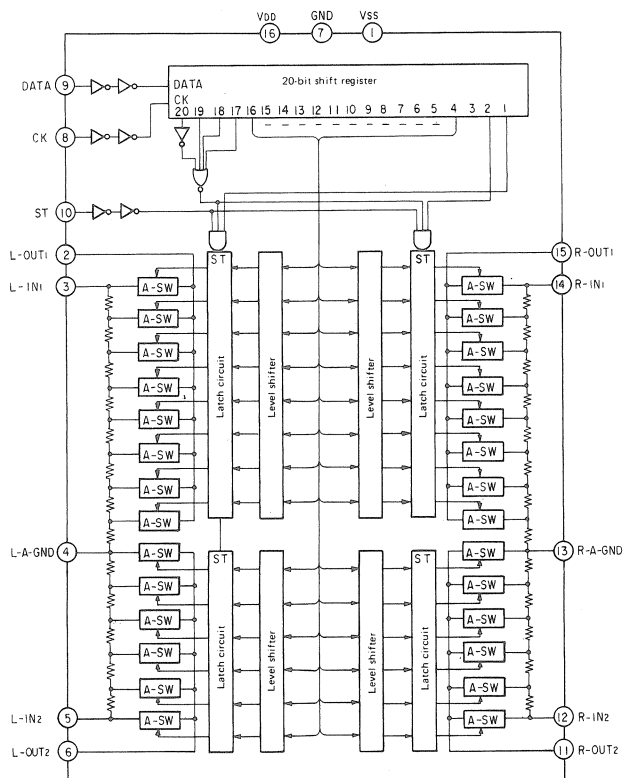
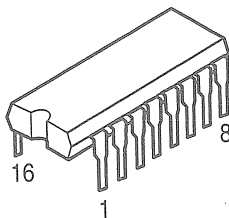

LM7001M
(SU: IC003)

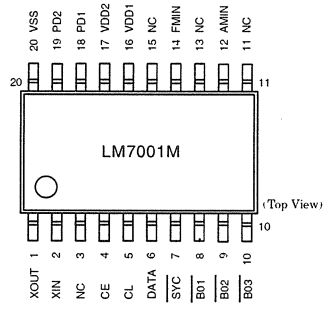
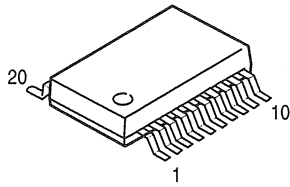

* (NC) pin : Use at opened.

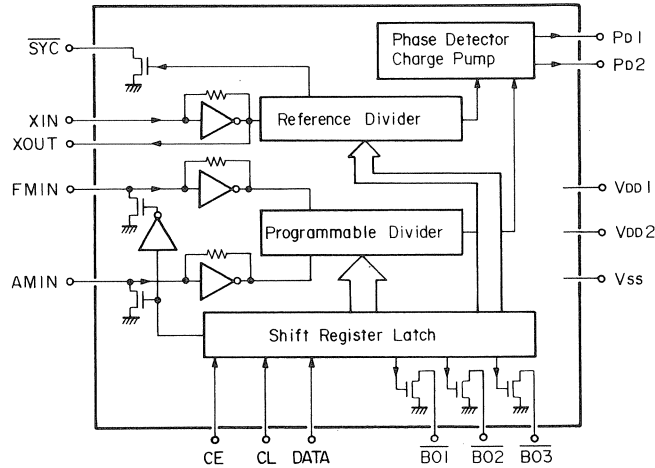

Terminal Description

- $\overline{\text{SYC}}$: Clock for controller (400 kHz)
- XIN, XOUT : X'tal OSC (7.2MHz)
- FMIN, AMIN : Station oscillation signal input.
- CE, CL, DATA : Data input.
- BO1, BO2, BO3: Band data output. BO1 is feasible for time base output (8Hz).
- VDD1, VDD2, VSS: Power supply. (VDD2 is for back-up)
- PD1, PD2 : Charge pump output.

Data input

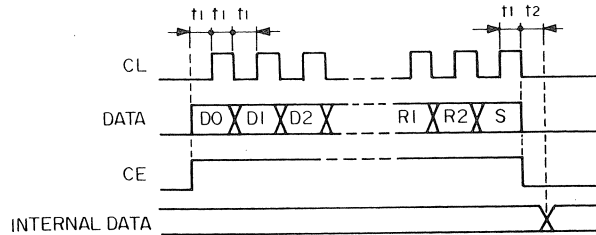

$t_1 > 1.5 \mu\text{s}$ (X'tal at 7.2MHz)
 $t_2 < 1.5 \mu\text{s}$

Input from D0.

D0	D1	D2	D3	D4	D5	D6	D7	D8	D9	D10	D11	D12	D13	T0	T1	B0	B1	B2	TB	R0	R1	R2	S
----	----	----	----	----	----	----	----	----	----	-----	-----	-----	-----	----	----	----	----	----	----	----	----	----	---

- (1) D0 (LSB)~D13 (MSB) :Frequency dividend data
For FMIN, use D0~D13; for AMIN, use D4~D13.

D0	D1	D2	D3	D4	D5	D6	D7	D8	D9	D10	D11	D12	D13
1	0	1	0	0	0	0	0	0	1	0	1	1	1
LSB													MSB
x	x	x	x	0	0	0	0	0	1	0	1	1	1
				LSB									MSB

→ FMIN Frequency dividend number = 14853

→ AMIN Frequency dividend number = 928

- (2) T0, T1 : For test of LSI(0,0)

BU4066BC
(RE: IC601)

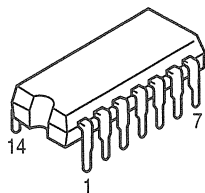

BU4066BCF
(SU: IC203, 205)

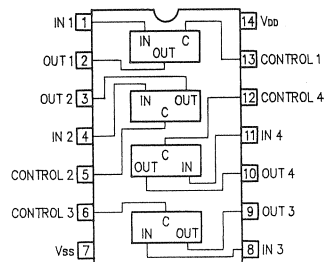
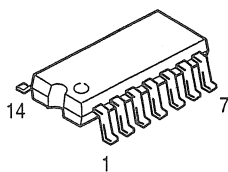

BA4558
(MA: IC451)

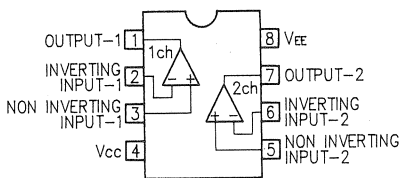
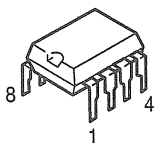

BA4558F (SU: IC101, 103, 261, 263)
NJM2068MD (SU: IC101): Europe model only

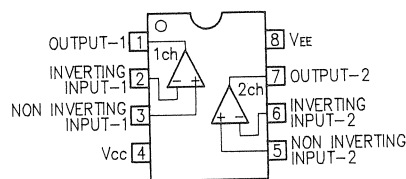
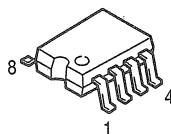

BA6208F (SU: IC264)

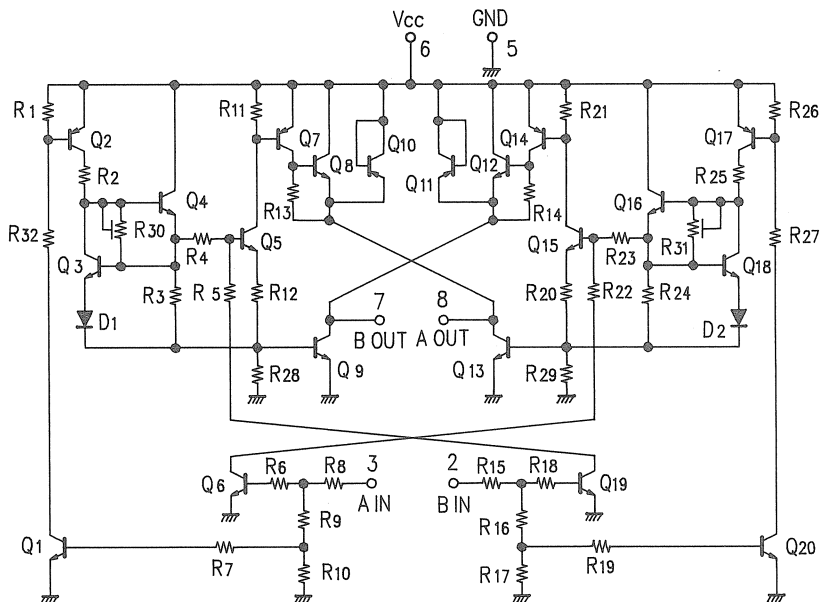
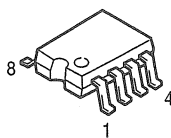

SI-18752 (RE: IC501, 502)

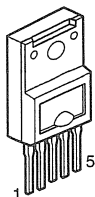

- 1. +IN
- 2. -IN
- 3. -VEE
- 4. Output
- 5. +Vcc

NJM7806FA(S) (RE: IC551)
NJM7812FA(S) (RE: IC503)

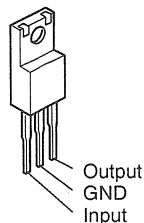

NJM7912FA
(RE: IC504)

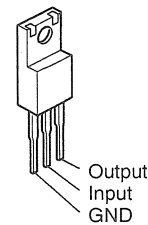

LC7822 (SU: IC102)

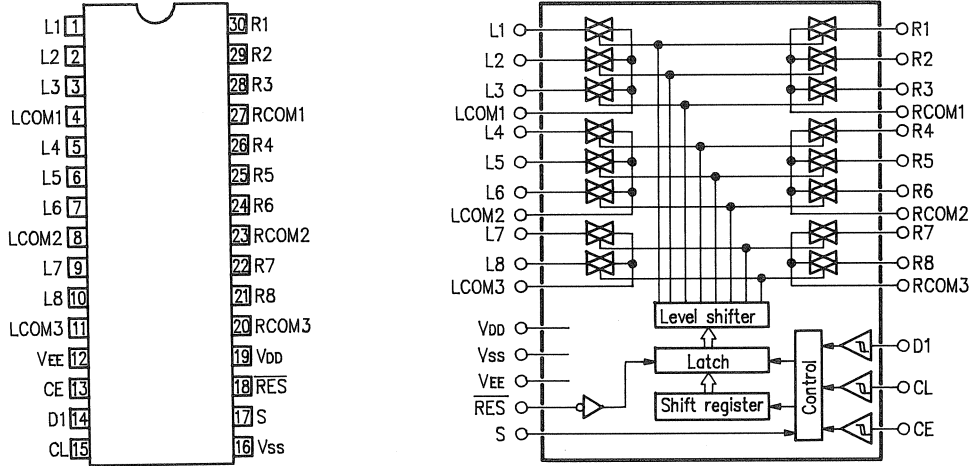
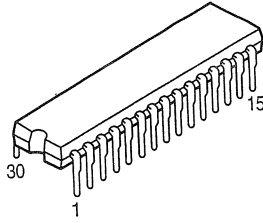
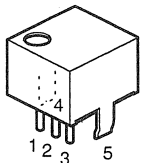

Table of LC7822 Terminal Function

Name of Terminal	I/O	Equivalent Internal Circuit	Function of Terminal																					
VDD, VSS, VEE			Power terminal.																					
L1 ~ L8, R1 ~ R8 LCOM1 ~ LCOM4, BCOM1 ~ BCOM4		Refer to block diagram	In/Out terminal of analog switch.																					
CL, DI, CE	I		Serial data input terminal (Schmidt buffer). CL = Clock input terminal. DI = Data input terminal. CE = Chip enable terminal.																					
S	I		Selection terminal for using of two. Address will be shifted as per below table when switching S terminal to L or H. <table border="1" style="margin: 10px auto;"> <thead> <tr> <th rowspan="2">Name of Item</th> <th rowspan="2">S Terminal</th> <th colspan="4">Address</th> </tr> <tr> <th>A0</th> <th>A1</th> <th>A2</th> <th>A3</th> </tr> </thead> <tbody> <tr> <td rowspan="2">LC7822</td> <td>L</td> <td>0</td> <td>1</td> <td>0</td> <td>1</td> </tr> <tr> <td>H</td> <td>1</td> <td>1</td> <td>0</td> <td>1</td> </tr> </tbody> </table>	Name of Item	S Terminal	Address				A0	A1	A2	A3	LC7822	L	0	1	0	1	H	1	1	0	1
Name of Item	S Terminal	Address																						
		A0	A1	A2	A3																			
LC7822	L	0	1	0	1																			
	H	1	1	0	1																			
RES	I		Reset terminal. Condition of analog switch is not fixed at the time of turning on the power. When shift this terminal to L, all analog switches become OFF.																					

SBX1610-52 (Remote Control Receiver)
(RE: IC701)



1. Vcc
2. Output
3. GND
4. Case fin
5. Case fin

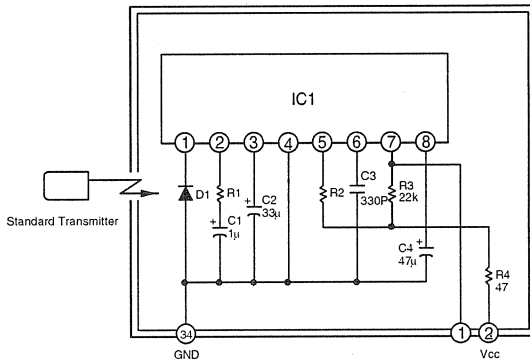

- IC1 : CX20106A chip
- D1 : Pin photodiode chip
- C1, C2, C4 : Aluminum electrolytic capacitor
- C3 : SL characteristic ± 5%
- R1 : Gain control resistor
- R2 : fo control resistor (using ± 1%)
- R (Other than above items) : ± 5%

1 2 3 4 5 6 7 8

REAR AMP. UNIT ASS'Y
1U-2651 for U.S.A. and Canada
1U-2651B for Europe

1U-2651, B	
1	Rear Amp. Unit
2	VFD Unit
3	Power Supply Unit

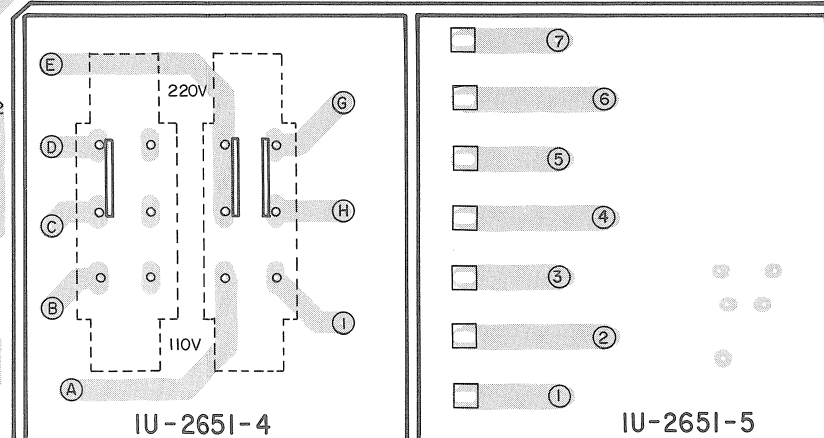
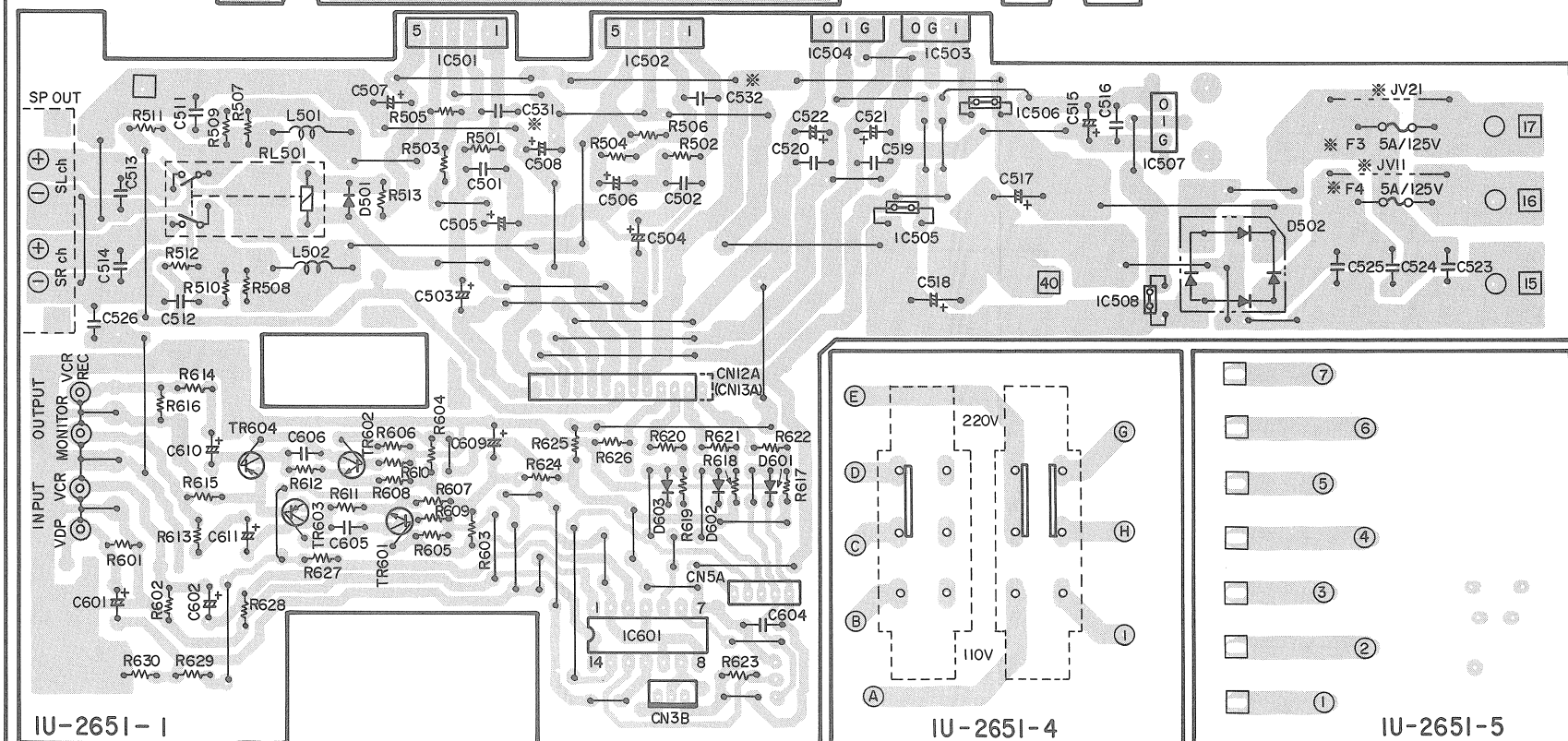
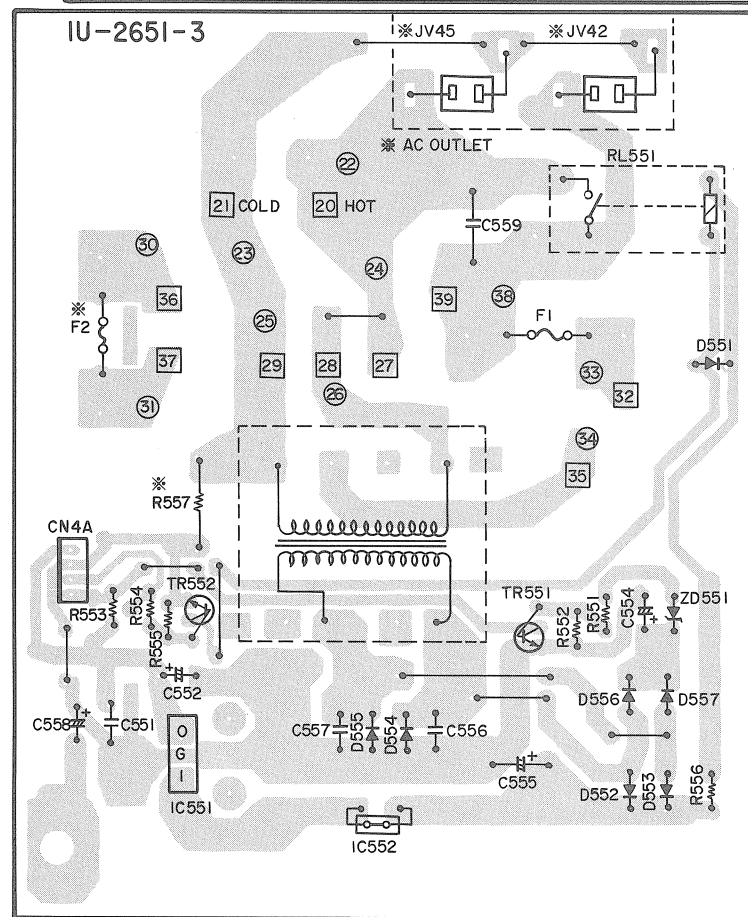
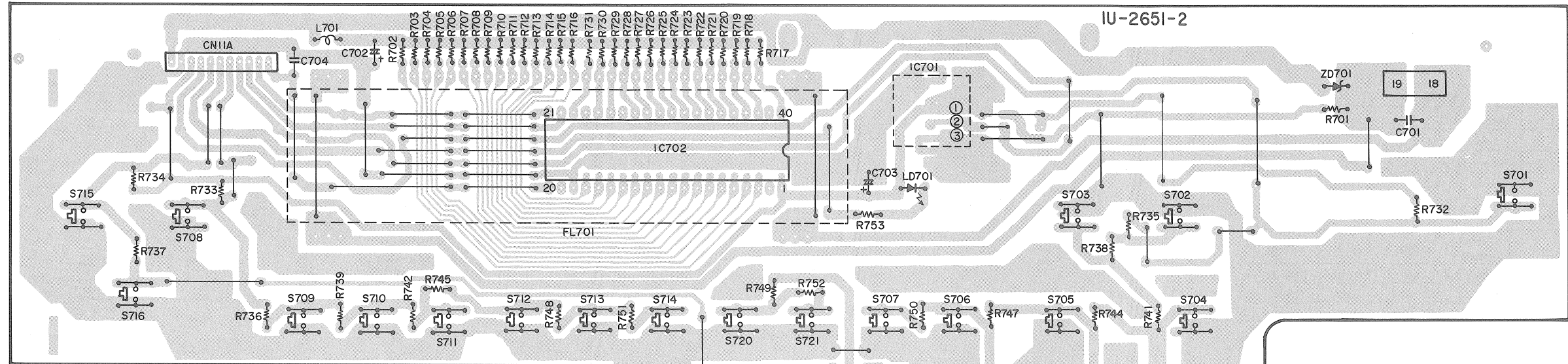

*

	JV11	JV21	JV42	JV45	F2	F3	F4	C531	C532	R557	AC OUTLET		
Multi-Voltage	Used	Used	Not used	Not used	Used	Not used	Not used	Not used	Not used	Not used	Not used		
Europe	Used	Used	Not used	Not used	Not used	Not used	Not used	Used	Used	Not used	Not used		
U.S.A.	Not used	Not used	Used	Used	Not used	Used	Used	Not used	Not used	Used	Used		
Canada	Not used	Not used	Used	Used	Not used	Used	Used	Not used	Not used	Used	Used		

Please refer to diagram in difference of fixed value.

1

2

3

4

5

6

7

8

SURROUND UNIT ASS'Y
 1U-2652 for U.S.A. and Canada
 1U-2652B for Europe

1U-2652, B	
1	Surround Unit
2	Volume Unit
3	Tuner Unit

※

	Multi-Voltage	Europe	U.S.A.	Canada
TR1	Not used	Used	Not used	Not used
J4	Used	Not used	Used	Used
J5	Used	Not used	Used	Used
J6	Used	Not used	Used	Used
J101	Used	4.7k	Used	Used
J102	Used	4.7k	Used	Used
J200	Not used	Used	Not used	Not used
C2	Not used	Used	Not used	Not used
C6	Not used	Used	Not used	Not used
C23	Used	Not used	Used	Used
C26	Not used	Used	Not used	Not used
C121	Not used	Used	Not used	Not used
C122	Not used	Used	Not used	Not used
C123	Not used	Used	Not used	Not used
C124	Not used	Used	Not used	Not used
C125	Not used	Used	Not used	Not used
C126	Not used	Used	Not used	Not used
C127	Not used	Used	Not used	Not used
C128	Not used	Used	Not used	Not used
C147	Not used	Used	Not used	Not used
C148	Not used	Used	Not used	Not used
C281	Not used	Used	Not used	Not used
C282	Not used	Used	Not used	Not used
R2	Not used	Used	Not used	Not used
R4	Not used	Used	Not used	Not used
R6	Not used	Used	Not used	Not used
R50	Used	Not used	Used	Used
R71	Not used	Used	Not used	Not used
R72	Used	Not used	Used	Used
R80	Used	Not used	Used	Used
R81	Not used	Used	Not used	Not used
R82	Used	Not used	Used	Used
R93	Not used	Used	Not used	Not used
LF1	Not used	Used	Not used	Not used
LF2	Not used	Used	Not used	Not used
LF3	Not used	Used	Not used	Not used
LF101	Not used	Used	Not used	Not used
LF102	Not used	Used	Not used	Not used

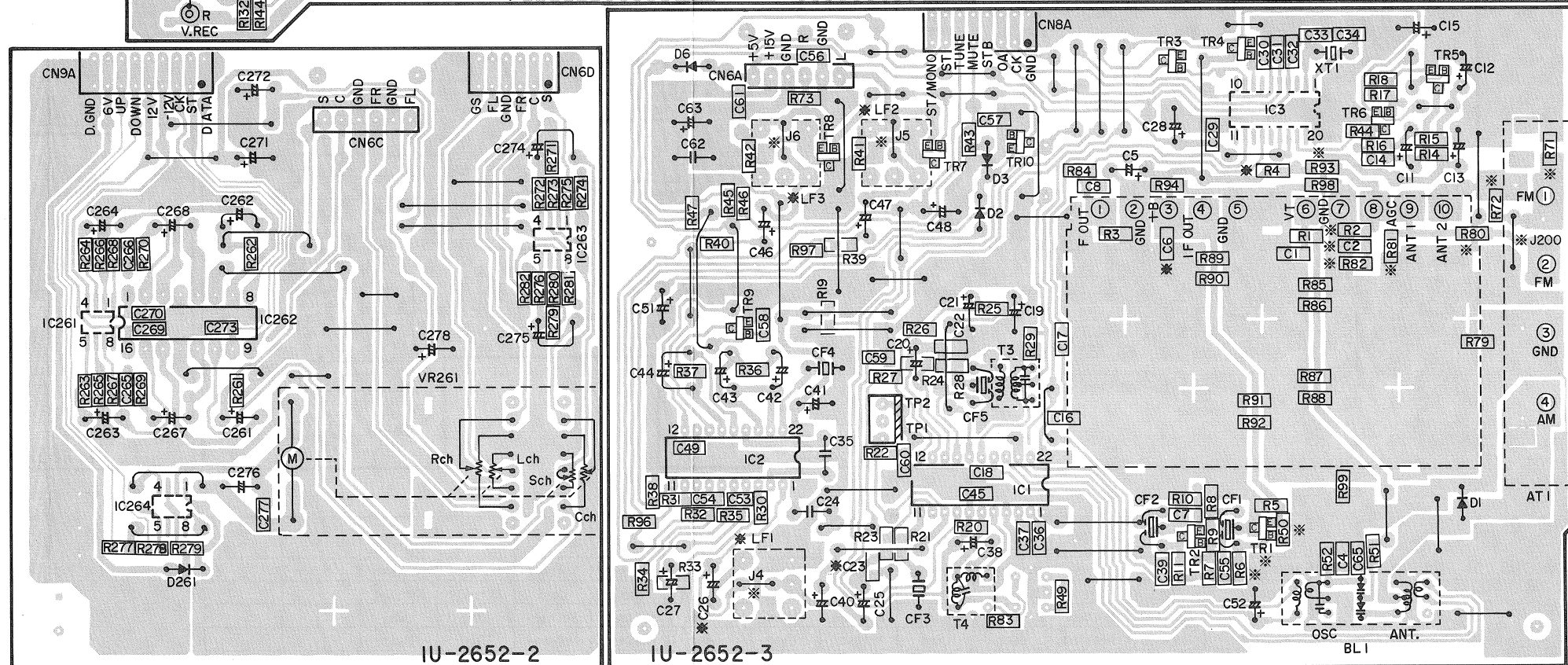
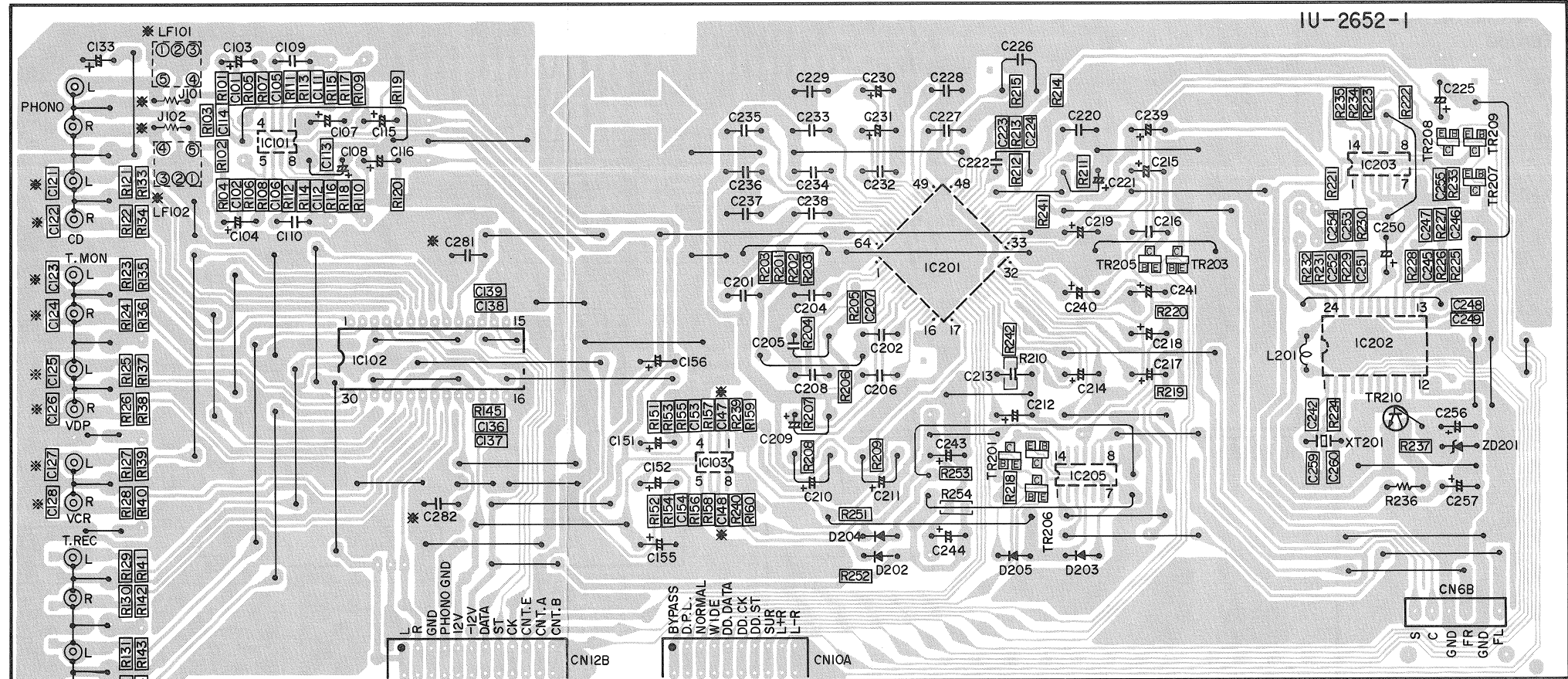

Please refer to diagram in difference of fixed value.

A

B

C

D

E

NOTE FOR PARTS LIST

- Part indicated with the mark "◎" are not always in stock and possibly to take a long period of time for supplying, or in some case supplying of part may be refused.
- When ordering of part, clearly indicate "1" and "I" (i) to avoid mis-supplying.
- Ordering part without stating its part number can not be supplied.
- Part indicated with the mark "★" is not illustrated in the exploded view.
- Not including Carbon Film ±5%, 1/4W Type in the P.W.Board parts list. (Refer to the Schematic Diagram for those parts.)

WARNING:

Parts marked with this symbol  have critical characteristics.
Use ONLY replacement parts recommended by the manufacturer.

● **Resistors**

Ex.: RN 14K 2E 182 G FR
 Type Shape and performance Power Resistance Allowable error Others

RD : Carbon	2B : 1/8W	F : ±1%	P : Pulse-resistant type
RC : Composition	2E : 1/4W	G : ±2%	NL : Low noise type
RS : Metal oxide film	2H : 1/2W	J : ±5%	NB : Non-burning type
RW : Winding	3A : 1W	K : ±10%	FR : Fuse-resistor
RN : Metal film	3D : 2W	M : ±20%	F : Lead wire forming
RK : Metal mixture	3F : 3W		
	3H : 5W		

* **Resistance**

1 8 2 ⇒ 1800 ohm = 1.8 kohm
 Indicates number of zeros after effective number.
 2-digit effective number.

• Units: ohm

1 R 2 ⇒ 1.2 ohm
 1-digit effective number.
 2-digit effective number, decimal point indicated by R.

• Units: ohm

● **Capacitors**

Ex.: CE 04W 1H 2R2 M BP
 Type Shape and performance Dielectric strength Capacity Allowable error Others

CE : Aluminum foil electrolytic	0J : 6.3V	F : ±1%	HS : High stability type
CA : Aluminum solid electrolytic	1A : 10V	G : ±2%	BP : Non-polar type
CS : Tantalum electrolytic	1C : 16V	J : ±5%	HR : Ripple-resistant type
CO : Film	1E : 25V	K : ±10%	DL : For charge and discharge
CK : Ceramic	1V : 35V	M : ±20%	HF : For assuring high frequency
CC : Ceramic	1H : 50V	Z : +80%	U : UL part
CP : Oil	2A : 100V	-20%	C : CSA part
CM : Mica	2B : 125V	P : +100%	W : UL-CSA type
CF : Metallized	2C : 160V	-0%	F : Lead wire forming
CH : Metallized	2D : 200V	C : ±0.25pF	
	2E : 250V	D : ±0.5pF	
	2H : 500V	= : Others	
	2J : 630V		

* **Capacity (electrolyte only)**

2 2 2 ⇒ 2200µF
 Indicates number of zeros after effective number.
 2-digit effective number.

• Units: µF.

2 R 2 ⇒ 2.2µF
 1-digit effective number.
 2-digit effective number, decimal point indicated by R.

• Units: µF.

* **Capacity (except electrolyte)**

2 2 2 ⇒ 2200pF = 0.0022µF
 (More than 2) — Indicates number of zeros after effective number.
 2-digit effective number.

• Units: µF.

2 2 1 ⇒ 220pF
 (0 or 1) — Indicates number of zeros after effective number.
 2-digit effective number.

• Units: pF.

• When the dielectric strength is indicated in AC, "AC" is included after the dielectric strength value.

P.W.B. ASS'Y PARTS LIST
1U-2650 MAIN UNIT ASS'Y (U.S.A. and Canada models)

Ref. No.	Part No.	Part Name	Remarks	Ref. No.	Part No.	Part Name	Remarks
SEMICONDUCTORS				CAPACITORS GROUP			
IC451	263 0322 004	IC BA4558		VR301,302	211 6047 023	Semi Fixed Resistor 4.7kohm	V06PB472
IC801	262 1876 006	IC TMP87CH40F-4066	μ-com	VR401	211 6047 023	Semi Fixed Resistor 4.7kohm	V06PB472
TR301-304	271 0094 919	Transistor 2SA970(BL)		VR451	211 0798 103	Variable Resistor 100kohm	Balance
TR305,306	271 0131 924	Transistor 2SA988(E/F)		VR452	211 0797 117	Variable Resistor 30kohm	Bass
TR307-312	273 0235 923	Transistor 2SC1841(E/F)		VR453	211 0797 104	Variable Resistor 5kohm	Treble
TR313,314	273 0198 002	Transistor 2SC1815(Y)		RA801	246 2067 003	Resistor Array 4.7kohmx11	RK99==472JP11
TR315,316	274 0060 900	Transistor 2SD667A(C)		RESISTORS GROUP (Not included Carbon Film ±5% 1/4 W Type. Refer to the Schematic Diagram for those Parts.)			
TR319,320	272 0053 908	Transistor 2SB647A(C)		R311-314	241 2380 963	Carbon Film 2.2kohm 1/4W(NB)	RD14B2E222JNBS
TR323,324	273 0235 923	Transistor 2SC1841(E/F)		R317,318	241 2377 976	Carbon Film 130ohm 1/4W(NB)	RD14B2E131JNBS
TR351	271 0131 924	Transistor 2SA988(E/F)		R325,326	241 2315 967	Fusible 68ohm 1/4W(NB)	RD14B2E680GFRS
TR353	272 0131 901	Transistor 2SB1041(R)		R327,328	241 2378 920	Carbon Film 220ohm 1/4W(NB)	RD14B2E221JNBS
TR401,402	271 0094 919	Transistor 2SA970(BL)		R329-336	244 2043 982	Metal Oxide 0.22ohm 1W(NB)	RS14B3AR22JNBS(S)
TR403	271 0131 924	Transistor 2SA988(E/F)		R341-344	241 2380 950	Carbon Film 2kohm 1/4W(NB)	RD14B2E202JNBS
TR404-406	273 0235 923	Transistor 2SC1841(E/F)		R345,346	244 2051 987	Metal Oxide 4.7ohm 1W(NB)	RS14B3A4R7JNBS(S)
TR407	273 0198 002	Transistor 2SC1815(Y)		R355,356	241 2377 976	Carbon Film 130ohm 1/4W(NB)	RD14B2E131JNBS
TR408	274 0060 900	Transistor 2SD667A(C)		R365-368	244 2051 958	Metal Oxide 220ohm 1W(NB)	RS14B3A221JNBS(S)
TR409	272 0053 908	Transistor 2SB647A(C)		R369-371	244 2051 987	Metal Oxide 4.7ohm 1W(NB)	RS14B3A4R7JNBS(S)
TR412	273 0235 923	Transistor 2SC1841(E/F)					
TR413,414	271 0131 924	Transistor 2SA988(E/F)					
TR415	273 0235 923	Transistor 2SC1841(E/F)					
TR416	271 0131 924	Transistor 2SA988(E/F)					
TR480-485	273 0388 906	Transistor 2SC1740S(E)					
TR486	271 0192 905	Transistor 2SA933S(S)					
TR487	273 0388 906	Transistor 2SC1740S(E)					
TR489	271 0192 905	Transistor 2SA933S(S)					
TR490	273 0388 906	Transistor 2SC1740S(E)					
TR801-803	269 0022 904	Transistor DTA143ES	Built in Resistor				
TR805	273 0388 906	Transistor 2SC1740S(E)					
TR806	269 0018 905	Transistor DTC143ES	Built in Resistor				
TR807	269 0022 904	Transistor DTA143ES	Built in Resistor				
D301-306	276 0616 907	Diode 1SS252					
D307-310	276 0619 904	Diode 1S2471					
D311-316	276 0616 907	Diode 1SS252					
▲ D351	276 0305 001	Diode S4VB20	Bridge				
D401-403	276 0616 907	Diode 1SS252					
D404,405	276 0619 904	Diode 1S2471					
D406,407	276 0616 907	Diode 1SS252					
D480-482	276 0616 907	Diode 1SS252					
D801	276 0619 904	Diode 1S2471					
D804	276 0616 907	Diode 1SS252					
D810,811	276 0616 907	Diode 1SS252					
ZD351,352	276 0473 904	Zener Diode HZS12A-1	12V				
ZD480	276 0466 908	Zener Diode HZS7C-1	7V				
ZD801	276 0454 907	Zener Diode HZS3C-1	3V				
SC480	279 0016 904	Thyrister SF0R1A42					

1U-2650B MAIN UNIT ASS'Y (Europe model)
[Same as 1U-2650 (for U.S.A. and Canada models)
except the followings.]

Ref. No.	Part No.	Part Name	Remarks
C457,458	254 4254 938	Electrolytic 47 μ F/16V	CE04W1C470M
C459,460	255 1264 908	Plastic Film 0.001 μ F/50V	CQ93M1H102J(B)
C461,462	256 1034 995	Metalized 0.15 μ F/50V	CF93A1H154J
C463,464	254 4260 948	Electrolytic 1 μ F/50V	CE04W1H010M
C465,466	255 1264 937	Plastic Film 0.0018 μ F/50V	CQ93M1H182J(B)
C467,468	255 1265 949	Plastic Film 0.012 μ F/50V	CQ93M1H123J(B)
C469,470	256 1034 953	Metalized 0.068 μ F/50V	CF93A1H683J
C471,472	254 4260 935	Electrolytic 0.47 μ F/50V	CE04W1HR47M
C473	253 9038 907	BC Ceramic 0.047 μ F/50V	CK45=1H473Z
C474	255 1265 978	Plastic Film 0.022 μ F/50V	CQ93M1H223J(B)
C480	254 4260 980	Electrolytic 10 μ F/50V	CE04W1H100M
C481	254 4260 993	Electrolytic 22 μ F/50V	CE04W1H220M
C482	254 4250 945	Electrolytic 330 μ F/6.3V	CE04W0J331M
C801	254 4250 783	Electrolytic 3300 μ F/6.3V	CE04W0J332MC
C802,803	253 1181 904	Ceramic 0.01 μ F/50V	CK45F1H103Z
C804	254 4250 932	Electrolytic 220 μ F/6.3V	CE04W0J221M
C805	256 1034 982	Metalized 0.12 μ F/50V	CF93A1H124J
C812	254 4258 905	Electrolytic 4.7 μ F/35V	CE04W1V4R7M
C813	255 1265 936	Plastic Film 0.01 μ F/50V	CQ93M1H103J(B)

Ref. No.	Part No.	Part Name	Remarks
SEMICONDUCTORS			
D313-316	276 0616 907	Diode 1SS252	Delete
CAPACITORS GROUP			
C314	253 1146 907	Ceramic 0.01 μ F/50V	Add
C316	253 1146 907	Ceramic 0.01 μ F/50V	Add
C357,358	255 1264 982	Plastic Film 0.0047 μ F/50V	Add
C360	255 1264 982	Plastic Film 0.0047 μ F/50V	Add





OTHER GROUP				Q'ty
	—	(P.W.Board)		1
L301,302	235 0104 007	Inductor 1 μ H		2
L401	235 0104 007	Inductor 1 μ H		1
RL480	214 0167 005	Relay(G5Z-2A)		1
RL481	214 9003 005	Relay		1
RL482	214 0162 000	Relay(A12W-K)		1
XT801	399 0191 903	Ceramic Resonator	CST4.00MGW19MGW	1
	204 8354 004	Headphone Jack		
	205 0846 005	6P Push Terminal	Front	1
	205 0255 007	Terminal		3
	415 0309 013	P.V.C. Tube(L=10)		6
TP	205 0190 036	3P NH Conn. Base		3
CN3A	205 0343 032	3P Conn. Base(KR-PH)		2
CN4A	205 0343 045	4P Conn. Base(KR-PH)		1
CN11A	205 0375 013	11P Conn. Base(KR-PH)		1
CN6A	205 0696 064	JL Connector(BT-E)		1
CN6B	205 0696 064	JL Connector(BT-E)		1
CN6C	205 0696 064	JL Connector(BT-E)		1
CN6D	205 0330 003	6P MQ-ST Conn. Base		1
CN8A	205 0330 029	8P MQ-ST Conn. Base		1
CN9A	205 0330 045	9P MQ-ST Conn. Base		1
CN10A	205 0330 058	10P MQ-ST Conn. Base		1
CN12A	205 0375 026	12P Conn. Base(KR-PH)		1
CN12B	205 0330 016	12P MQ-ST Conn. Base		1

1U-2651 REAR AMP. UNIT ASS'Y
(U.S.A. and Canada models)

Ref. No.	Part No.	Part Name	Remarks
SEMICONDUCTORS			
IC501,502	263 0855 005	IC SI-18752	
IC503	263 0801 004	IC NJM7812FA(S)	Regulator +12V
IC504	263 0641 002	IC NJM7912FA	Regulator -12V
IC505,506	268 0074 904	IC ICP-N20	IC Protector 20V
IC551	263 0793 002	IC NJM7806FA(S)	Regulator +6V
IC552	268 0073 905	IC ICP-N15	IC Protector 15V
IC601	262 1873 009	IC BU4066BC	
IC701	499 0150 008	IC SBX1610-52	Remocon Receiver
IC702	262 1564 004	IC MSC1937-01	µ-com
TR551,552	273 0388 906	Transistor 2SC1740S(E)	
TR601,602	273 0198 918	Transistor 2SC1815(BL)	
TR603,604	271 0102 924	Transistor 2SA1015(GR)	
TR605	269 0018 905	Transistor DTC143ES	Built in Resistor
D501	276 0616 907	Diode 1SS252	
▲ D502	276 0305 001	Diode S4VB20	Bridge
D551	276 0616 907	Diode 1SS252	
D552-557	276 0553 905	Diode 1SR35-200A	
D601-603	276 0616 907	Diode 1SS252	
ZD551	276 0465 909	Zener Diode HZS7B-1	7V
ZD701	276 0467 907	Zener Diode HZS9A-1	9V
LD701	393 9434 906	LED SEL1210S	Red
FL701	393 4131 000	FLD Ass'y FIP14PM8	
RESISTORS GROUP (Not included Carbon Film ± 5% 1/4 W Type. Refer to the Schematic Diagram for those Parts.)			
▲ R509,510	244 2051 987	Metal Oxide 4.7ohm 1 W(NB)	RS14B3A4R7JNBS(S)
▲ R513	241 2387 908	Carbon Film 1ohm 1/4 W(NB)	RD14B2E010JNBS
▲ R556	241 2375 978	Carbon Film 20ohm 1/4 W(NB)	RD14B2E200JNBS
▲ R557	242 0073 000	Carbon Composit 2.2Mohm 1/2W	RC05GF2H225K
▲ R624	241 2375 907	Carbon Film 10ohm 1/4 W(NB)	RD14B2E100JNBS
▲ R625	241 2387 908	Carbon Film 1ohm 1/4 W(NB)	RD14B2E010JNBS
▲ R626	241 2387 940	Carbon Film 4.7ohm 1/4 W(NB)	RD14B2E4R7JNBS
CAPACITORS GROUP			
C501,502	253 1179 903	Ceramic 100pF/50V	CK45B1H101K
C503,504	254 4260 951	Electrolytic 2.2µF/50V	CE04W1H2R2M
C505,506	254 4254 938	Electrolytic 47µF/16V	CE04W1C470M
C507,508	254 4260 948	Electrolytic 1µF/50V	CE04W1H010M
C511,512	256 1034 979	Metalized 0.1µF/50V	CF93A1H104J
C513,514	253 1146 907	Ceramic 0.01µF/50V	CK45F1H103Z
C517,518	254 4259 713	Electrolytic 3300µF/35V	CE04W1V332MC
C519,520	253 1146 907	Ceramic 0.01µF/50V	CK45F1H103Z
C521,522	254 4258 918	Electrolytic 10µF/35V	CE04W1V100M
C524	256 1042 903	Metalized 0.1µF/250V	CF93A2E104K
C526	253 1146 907	Ceramic 0.01µF/50V	CK45F1H103Z
C551	253 1146 907	Ceramic 0.01µF/50V	CK45F1H103Z
C552	254 4254 909	Electrolytic 10µF/16V	CE04W1C100M
C554	254 4260 948	Electrolytic 1µF/50V	CE04W1H010M
C555	254 4256 790	Electrolytic 2200µF/25V	CE04W1E222MC
C556,557	253 1146 907	Ceramic 0.01µF/50V	CK45F1H103Z
C558	254 4260 948	Electrolytic 1µF/50V	CE04W1H010M
▲ C559	253 8014 702	Ceramic 0.01µF/400V(AC)	CK45F2GAC103MC
C601,602	254 4252 927	Electrolytic 47µF/10V	CE04W1A470M
C603	254 4260 948	Electrolytic 1µF/50V	CE04W1H010M
C604	253 1146 907	Ceramic 0.01µF/50V	CK45F1H103Z
C605,606	253 4535 955	Ceramic 5pF/50V	CC45SL1H050C

Ref. No.	Part No.	Part Name	Remarks	Q'ty
C609	254 4254 776	Electrolytic 470µF/16V	CE04W1C471M	
C610,611	254 4252 079	Electrolytic 1000µF/10V	CE04W1A102M	
C701	256 1034 979	Metalized 0.1µF/50V	CF93A1H104J	
C702	254 4261 921	Electrolytic 100µF/50V	CE04W1H101M	
C703	254 4250 945	Electrolytic 330µF/6.3V	CE04W0J331M	
OTHER GROUP				
	—	(P.W.Board)		1
L501,502	235 0104 007	Inductor 1µH		2
L701	235 0060 989	Inductor 120µH		1
RL501	214 0167 005	Relay(G5Z-2A)	Rear	1
▲ RL551	214 0170 005	Relay(TV-8)	Pri.	1
S701-721	212 5604 910	Tact Switch		21
	202 0040 909	Fuse Clip		6
▲	203 3941 008	AC Outlet(2 P)		1
▲	233 6073 000	Power Trans(Mini)		1
▲ F001	216 1046 001	Fuse 6.3 A(UL) 20 mm	Fuse Pri.	1
▲ F003,004	216 1046 027	Fuse 5 A	Fuse Sec.	2
	204 8442 000	4P Pin Jack(C-GND)	Video	1
	205 0592 003	4P Push Terminal	Rear	1
CN4A	205 0343 045	4P Conn. Base(KR-PH)		1
CN11A	204 6469 001	11P PH-SAN Conn. Cord		1
CN12A	204 6470 003	12P PH-SAN Conn. Cord		1
	205 0075 025	2P Terminal		1

1U-2651B REAR AMP. UNIT ASS'Y (Europe model)
 [Same as 1U-2651 (for U.S.A. and Canada models)
 except the followings.]

Ref. No.	Part No.	Part Name	Remarks
RESISTORS GROUP			
R557	242 0073 000	Carbon Composit 2.2Mohm 1/2W	Delete
CAPACITORS GROUP			
C501,502	253 1179 903	Ceramic 100pF/50V	Add
C531,532	253 1179 903	Ceramic 100pF/50V	Add
OTHER GROUP			
	203 3941 008	AC Outlet (2P)	Delete
	233 6058 012	Power Trans (Mini)	Change
	F001 205 1015 032	Fuse (2.5A)	Change
	F003,004 216 1046 027	Fuse 5A	Delete
	202 0040 909	Fuse Clip (4)	Change
	205 0692 000	2P Wrapping Terminal	Add

1U-2652 SURROUND UNIT ASS'Y
 (U.S.A. and Canada models)

Ref. No.	Part No.	Part Name	Remarks
SEMICONDUCTORS			
IC001	263 0891 001	IC LA1265(S)	
IC002	263 0439 007	IC LA3401	
IC003	263 0791 907	IC LM7001M	
IC004	216 0064 007	Front End	
IC101	263 0672 903	IC BA4558F	
IC102	262 1228 007	IC LC7822	
IC103	263 0672 903	IC BA4558F	
IC201	263 0906 006	IC NJM2177AF	
IC202	262 1874 008	IC NJU9701G	
IC203	262 1875 900	IC BU4066BCF	
IC205	262 1875 900	IC BU4066BCF	
IC261	263 0672 903	IC BA4558F	
IC262	262 0625 009	IC TC9176P	
IC263	263 0672 903	IC BA4558F	
IC264	263 0905 900	IC BA6208F	
TR002	273 0411 909	Transistor 2SC2996-Y	
TR003,004	269 0114 906	Transistor RN2402	Built in Resistor
TR005	273 0403 904	Transistor 2SC2712-Y/GR	
TR006	275 0075 901	FET 2SK209-Y/GR	
TR007,008	269 0066 902	Transistor DTC323TK	Built in Resistor
TR009	269 0085 909	Transistor DTC144TK	Built in Resistor
TR010	269 0086 908	Transistor DTA114TK	Built in Resistor
TR201	269 0055 900	Transistor DTA144EK	Built in Resistor
TR202,203	269 0054 901	Transistor DTC144EK	Built in Resistor
TR205	269 0054 901	Transistor DTC144EK	Built in Resistor
TR206	273 0384 900	Transistor 2SC2412K(S)	
TR207-209	269 0054 901	Transistor DTC144EK	Built in Resistor
TR210	274 0169 908	Transistor 2SD1292(R)	
D001-003	276 0616 907	Diode 1SS252	
D006	276 0616 907	Diode 1SS252	
D202-205	276 0616 907	Diode 1SS252	
D261	276 0616 907	Diode 1SS252	
ZD201	276 0462 902	Zener Diode HZS6B-1	6V
RESISTORS GROUP (Not included Carbon Film ±5% 1/4 W Type. Refer to the Schematic Diagram for those Parts.)			
R001	247 0007 945	Chip Carbon 1kohm 1/10W	RM73B--102J
R003	247 0004 906	Chip Carbon 39ohm 1/10W	RM73B--390J
R005	247 0007 945	Chip Carbon 1kohm 1/10W	RM73B--102J
R007	247 0009 901	Chip Carbon 4.7kohm 1/10W	RM73B--472J
R008	247 0006 920	Chip Carbon 330ohm 1/10W	RM73B--331J
R009	247 0005 989	Chip Carbon 220ohm 1/10W	RM73B--221J
R010	247 0008 902	Chip Carbon 1.8kohm 1/10W	RM73B--182J
R011	247 0006 920	Chip Carbon 330ohm 1/10W	RM73B--331J
R014	247 0005 905	Chip Carbon 100ohm 1/10W	RM73B--101J
R015	247 0009 969	Chip Carbon 8.2kohm 1/10W	RM73B--822J
R016	247 0008 986	Chip Carbon 3.9kohm 1/10W	RM73B--392J
R017	247 0006 946	Chip Carbon 390ohm 1/10W	RM73B--391J
R018	247 0005 947	Chip Carbon 150ohm 1/10W	RM73B--151J
R019	247 0005 921	Chip Carbon 120ohm 1/10W	RM73B--121J
R020	247 0010 929	Chip Carbon 15kohm 1/10W	RM73B--153J
R021	247 0005 921	Chip Carbon 120ohm 1/10W	RM73B--121J
R022	247 0010 945	Chip Carbon 18kohm 1/10W	RM73B--183J
R023	247 0018 905	Chip Carbon 0ohm 1/10W	RM73B--0R0K
R024	247 0009 943	Chip Carbon 6.8kohm 1/10W	RM73B--682J
R025,026	247 0009 985	Chip Carbon 10kohm 1/10W	RM73B--103J
R027	247 0008 960	Chip Carbon 3.3kohm 1/10W	RM73B--332J
R028	247 0009 972	Chip Carbon 9.1kohm 1/10W	RM73B--912J
R029	247 0011 986	Chip Carbon 68kohm 1/10W	RM73B--683J

Ref. No.	Part No.	Part Name	Remarks
R030,031	247 0011 973	Chip Carbon 62kohm 1/10W	RM73B--623J
R032	247 0012 927	Chip Carbon 100kohm 1/10W	RM73B--104J
R033,034	247 0012 943	Chip Carbon 120kohm 1/10W	RM73B--124J
R035	247 0012 927	Chip Carbon 100kohm 1/10W	RM73B--104J
R036	247 0008 960	Chip Carbon 3.3kohm 1/10W	RM73B--332J
R037,038	247 0012 927	Chip Carbon 100kohm 1/10W	RM73B--104J
R039,040	247 0008 960	Chip Carbon 3.3kohm 1/10W	RM73B--332J
R041,042	247 0009 943	Chip Carbon 6.8kohm 1/10W	RM73B--682J
R043	247 0010 961	Chip Carbon 22kohm 1/10W	RM73B--223J
R044,045	247 0009 985	Chip Carbon 10kohm 1/10W	RM73B--103J
R046	247 0009 927	Chip Carbon 5.6kohm 1/10W	RM73B--562J
R047	247 0009 985	Chip Carbon 10kohm 1/10W	RM73B--103J
R050	247 0005 905	Chip Carbon 100ohm 1/10W	RM73B--101J
R051,052	247 0012 927	Chip Carbon 100kohm 1/10W	RM73B--104J
R072	247 1018 904	Chip Carbon 0ohm 1/8W	RM73B2B0R0K
R080	247 1018 904	Chip Carbon 0ohm 1/8W	RM73B2B0R0K
R082,083	247 1018 904	Chip Carbon 0ohm 1/8W	RM73B2B0R0K
R084	247 0018 905	Chip Carbon 0ohm 1/10W	RM73B--0R0K
R085--092	247 1018 904	Chip Carbon 0ohm 1/8W	RM73B2B0R0K
R094	247 1018 904	Chip Carbon 0ohm 1/8W	RM73B2B0R0K
R096--098	247 1018 904	Chip Carbon 0ohm 1/8W	RM73B2B0R0K
R101,102	247 0006 946	Chip Carbon 390ohm 1/10W	RM73B--391J
R103,104	247 0011 986	Chip Carbon 68kohm 1/10W	RM73B--683J
R105,106	247 0012 969	Chip Carbon 150kohm 1/10W	RM73B--154J
R107,108	247 0004 922	Chip Carbon 47ohm 1/10W	RM73B--470J
R109,110	247 0007 945	Chip Carbon 1kohm 1/10W	RM73B--102J
R111,112	247 0014 909	Chip Carbon 560kohm 1/10W	RM73B--564J
R113,114	247 0011 944	Chip Carbon 47kohm 1/10W	RM73B--473J
R115,116	247 0003 949	Chip Carbon 22ohm 1/10W	RM73B--220J
R117,118	247 0005 905	Chip Carbon 100ohm 1/10W	RM73B--101J
R119,120	247 0013 984	Chip Carbon 470kohm 1/10W	RM73B--474J
R121--132	247 0015 966	Chip Carbon 2.7Mohm 1/10W	RM73B--275J
R133--144	247 0006 962	Chip Carbon 470ohm 1/10W	RM73B--471J
R145	247 0014 925	Chip Carbon 680kohm 1/10W	RM73B--684J
R151,152	247 0006 962	Chip Carbon 470ohm 1/10W	RM73B--471J
R153,154	247 0011 973	Chip Carbon 62kohm 1/10W	RM73B--623J
R155,156	247 0013 984	Chip Carbon 470kohm 1/10W	RM73B--474J
R157--160	247 0005 905	Chip Carbon 100ohm 1/10W	RM73B--101J
R201	247 0009 956	Chip Carbon 7.5kohm 1/10W	RM73B--752J
R202	247 0011 944	Chip Carbon 47kohm 1/10W	RM73B--473J
R203	247 0010 929	Chip Carbon 15kohm 1/10W	RM73B--153J
R204	247 0009 956	Chip Carbon 7.5kohm 1/10W	RM73B--752J
R205	247 0011 944	Chip Carbon 47kohm 1/10W	RM73B--473J
R206	247 0010 929	Chip Carbon 15kohm 1/10W	RM73B--153J
R207	247 0016 923	Chip Carbon 4.7Mohm 1/10W	RM73B--475J
R208,209	247 0011 960	Chip Carbon 56kohm 1/10W	RM73B--563J
R210	247 0012 927	Chip Carbon 100kohm 1/10W	RM73B--104J
R211	247 0019 988	Chip Carbon 100kohm 1/10W	RM73B--104J(±1%)
R212	247 0010 929	Chip Carbon 15kohm 1/10W	RM73B--153J
R213	247 0009 969	Chip Carbon 8.2kohm 1/10W	RM73B--822J
R214	247 0010 929	Chip Carbon 15kohm 1/10W	RM73B--153J
R215	247 0013 942	Chip Carbon 330kohm 1/10W	RM73B--334J
R218--220	247 0011 944	Chip Carbon 47kohm 1/10W	RM73B--473J
R221--223	247 0009 969	Chip Carbon 8.2kohm 1/10W	RM73B--822J
R224	247 0014 967	Chip Carbon 1Mohm 1/10W	RM73B--105J
R225	247 0010 929	Chip Carbon 15kohm 1/10W	RM73B--153J
R226	247 0010 945	Chip Carbon 18kohm 1/10W	RM73B--183J
R227	247 0010 929	Chip Carbon 15kohm 1/10W	RM73B--153J
R228,229	247 0003 936	Chip Carbon 20ohm 1/10W	RM73B--200J
R230	247 0009 956	Chip Carbon 7.5kohm 1/10W	RM73B--752J
R231	247 0009 927	Chip Carbon 5.6kohm 1/10W	RM73B--562J
R232	247 0010 945	Chip Carbon 18kohm 1/10W	RM73B--183J
R233--235	247 0011 944	Chip Carbon 47kohm 1/10W	RM73B--473J
R236	241 2387 940	Carbon Film 4.7ohm 1/4 W(NB)	RD14B2E4R7JNBS
R237	247 0007 945	Chip Carbon 1kohm 1/10W	RM73B--102J

Ref. No.	Part No.	Part Name	Remarks
R239,240	247 0005 905	Chip Carbon 100ohm 1/10W	RM73B--101J
R241,242	247 0006 962	Chip Carbon 470ohm 1/10W	RM73B--471J
R251,252	247 0008 928	Chip Carbon 2.2kohm 1/10W	RM73B--222J
R253,254	247 0009 901	Chip Carbon 4.7kohm 1/10W	RM73B--472J
R261,262	247 0012 927	Chip Carbon 100kohm 1/10W	RM73B--104J
R263,264	247 0013 900	Chip Carbon 220kohm 1/10W	RM73B--224J
R265,266	247 0007 945	Chip Carbon 1kohm 1/10W	RM73B--102J
R267,268	247 0008 960	Chip Carbon 3.3kohm 1/10W	RM73B--332J
R269,270	247 0005 905	Chip Carbon 100ohm 1/10W	RM73B--101J
R271	247 0013 984	Chip Carbon 470kohm 1/10W	RM73B--474J
R272	247 0005 905	Chip Carbon 100ohm 1/10W	RM73B--101J
R273	247 0007 945	Chip Carbon 1kohm 1/10W	RM73B--102J
R274	247 0009 927	Chip Carbon 5.6kohm 1/10W	RM73B--562J
R275,276	247 0005 905	Chip Carbon 100ohm 1/10W	RM73B--101J
R277,278	247 0009 985	Chip Carbon 10kohm 1/10W	RM73B--103J
R279	247 0013 984	Chip Carbon 470kohm 1/10W	RM73B--474J
R280	247 0007 945	Chip Carbon 1kohm 1/10W	RM73B--102J
R281	247 0009 927	Chip Carbon 5.6kohm 1/10W	RM73B--562J
R282	247 0005 905	Chip Carbon 100ohm 1/10W	RM73B--101J
VR261	211 0802 002	Variable Resister 100kohm	
CAPACITORS GROUP			
C001	257 0012 966	Chip Ceramic 0.01µF/50V	CK73F1H103Z
C004	257 0002 947	Chip Ceramic 12pF/50V	CC73SL1H120J
C005	254 4254 909	Electrolytic 10µF/16V	CE04W1C100M
C007,008	257 0012 966	Chip Ceramic 0.01µF/50V	CK73F1H103Z
C011	254 3056 917	Electrolytic 1µF/50V (Bipole)	CE04D1H010MBP
C012	254 4254 938	Electrolytic 47µF/16V	CE04W1C470M
C013	254 4260 906	Electrolytic 0.1µF/50V	CE04W1H0R1M
C014	257 0012 982	Chip Ceramic 0.022µF/50V	CK73F1H223Z
C016	257 0004 961	Chip Ceramic 100pF/50V	CC73SL1H101J
C017,018	257 0012 966	Chip Ceramic 0.01µF/50V	CK73F1H103Z
C019	254 4260 935	Electrolytic 0.47µF/50V	CE04W1HR47M
C020	254 4260 948	Electrolytic 1µF/50V	CE04W1H010M
C021	254 4260 980	Electrolytic 10µF/50V	CE04W1H100M
C022	257 0012 982	Chip Ceramic 0.022µF/50V	CK73F1H223Z
C023	257 0004 961	Chip Ceramic 100pF/50V	CC73SL1H101J
C024	256 1034 940	Metalized 0.056µF/50V	CF93A1H563J
C025	254 4254 912	Electrolytic 22µF/50V	CE04W1C220M
C027	254 4254 909	Electrolytic 10µF/16V	CE04W1C100M
C028	254 4260 948	Electrolytic 1µF/50V	CE04W1H010M
C029	257 0012 966	Chip Ceramic 0.01µF/50V	CK73F1H103Z
C033,034	257 0002 976	Chip Ceramic 16pF/50V	CC73SL1H160J
C035	256 1034 937	Metalized 0.047µF/50V	CF93A1H473J
C036,037	257 0012 966	Chip Ceramic 0.01µF/50V	CK73F1H103Z
C038	254 4254 938	Electrolytic 47µF/16V	CE04W1C470M
C039	257 0012 966	Chip Ceramic 0.01µF/50V	CK73F1H103Z
C040	254 4260 948	Electrolytic 1µF/50V	CE04W1H010M
C041	254 4254 938	Electrolytic 47µF/16V	CE04W1C470M
C042	254 4260 948	Electrolytic 1µF/50V	CE04W1H010M
C043	254 4260 919	Electrolytic 0.22µF/50V	CE04W1HR22M
C044	254 4260 948	Electrolytic 1µF/50V	CE04W1H010M
C045	257 0012 966	Chip Ceramic 0.01µF/50V	CK73F1H103Z
C046,047	254 4260 951	Electrolytic 2.2µF/50V	CE04W1H2R2M
C048	254 4260 948	Electrolytic 1µF/50V	CE04W1H010M
C049	257 0012 966	Chip Ceramic 0.01µF/50V	CK73F1H103Z
C051	254 4260 951	Electrolytic 2.2µF/50V	CE04W1H2R2M
C052	254 4254 909	Electrolytic 10µF/16V	CE04W1C100M
C053,054	257 0006 972	Chip Ceramic 750pF/50V	CC73SL1H751J
C056,057	257 0012 966	Chip Ceramic 0.01µF/50V	CK73F1H103Z
C059--061	257 0012 966	Chip Ceramic 0.01µF/50V	CK73F1H103Z
C063	254 4254 909	Electrolytic 10µF/16V	CE04W1C100M

Ref. No.	Part No.	Part Name	Remarks	Ref. No.	Part No.	Part Name	Remarks			
C065	257 0012 966	Chip Ceramic 0.01μF/50V	CK73F1H103Z	C276	254 3056 917	Electrolytic 1μF/50V (Bipole)	CE04D1H010MBP			
C101,102	257 0005 944	Chip Ceramic 220pF/50V	CC73SL1H221J	C277	257 0012 966	Chip Ceramic 0.01μF/50V	CK73F1H103Z			
C103,104	254 4254 909	Electrolytic 10μF/16V	CE04W1C100M	C278	254 4260 948	Electrolytic 1μF/50V	CE04W1H010M			
C105,106	257 0004 961	Chip Ceramic 100pF/50V	CC73SL1H101J	C279	257 0012 966	Chip Ceramic 0.01μF/50V	CK73F1H103Z			
C107,108	254 4254 925	Electrolytic 33μF/16V	CE04W1C330M	OTHER GROUP						Q'ty
C109,110	255 1264 995	Plastic Film 0.0056μF/50V	CQ93M1H562J(B)		—	(P.W.Board)			1	
C111,112	257 0009 908	Chip Ceramic 1500pF/50V	CK73B1H152K	CF001	261 0135 907	Ceramic Filter MA8			1	
C113,114	257 0012 982	Chip Ceramic 0.022μF/50V	CK73F1H223Z	CF002	261 0136 906	Ceramic Filter MS2G			1	
C115,116	254 4260 951	Electrolytic 2.2μF/50V	CE04W1H2R2M	CF003	261 0031 001	Ceramic Filter BFU450C4			1	
C133	254 4260 948	Electrolytic 1μF/50V	CE04W1H010M	CF004	261 0079 005	Ceramic Filter CSB456F11			1	
C136-138	257 0012 982	Chip Ceramic 0.022μF/50V	CK73F1H223Z	CF005	261 0116 007	Ceramic Filter SFU450B3			1	
C139	257 0009 924	Chip Ceramic 2200pF/50V	CK73B1H222K	L201	235 0060 989	Inductor 120μH			1	
C151,152	254 4254 909	Electrolytic 10μF/16V	CE04W1C100M	XT001	399 0075 003	Crystal 7.2 MHz			1	
C153,154	257 0004 961	Chip Ceramic 100pF/50V	CC73SL1H101J	XT201	399 0223 907	Ceramic Resonator	CSA2.00MG-TF01		1	
C155,156	254 4260 948	Electrolytic 1μF/50V	CE04W1H010M	BL001	231 2096 001	MW Ant. Osc.Coil			1	
C201,202	256 1034 979	Metalized 0.1μF/50V	CF93A1H104J	T003	231 1138 009	AM IFT			1	
C203	257 0006 969	Chip Ceramic 680pF/50V	CC73SL1H681J	T004	231 2085 009	FM Det. Trans			1	
C204	256 1034 937	Metalized 0.47μF/50V	CF93A1H474J		205 0505 003	4P Push Terminal			1	
C205,206	256 1034 979	Metalized 0.1μF/50V	CF93A1H104J		204 8313 003	4P Pin Jack(S-GND)			2	
C207	257 0006 969	Chip Ceramic 680pF/50V	CC73SL1H681J		204 8346 009	6P Pin Jack(S-GND)			1	
C208	256 1034 937	Metalized 0.47μF/50V	CF93A1H474J							
C209	254 4254 912	Electrolytic 22μF/16V	CE04W1C220M							
C210,211	254 4254 909	Electrolytic 10μF/16V	CE04W1C100M							
C212	254 4252 930	Electrolytic 100μF/10V	CE04W1A101M							
C213	255 1264 982	Plastic Film 0.0047μF/50V	CQ93M1H472J(B)							
C214	254 4254 912	Electrolytic 22μF/16V	CE04W1C220M							
C215	254 4254 909	Electrolytic 10μF/16V	CE04W1C100M							
C216	256 1035 910	Metalized 0.22μF/50V	CF93A1H224J							
C217,218	254 4254 909	Electrolytic 10μF/16V	CE04W1C100M							
C219	254 4254 941	Electrolytic 100μF/16V	CE04W1C101M							
C220	255 1264 995	Plastic Film 0.0056μF/50V	CQ93M1H562J(B)	TP	205 0190 036	3P NH Conn. Base			1	
C221	254 4250 958	Electrolytic 470μF/6.3V	CE04W0J471M	CN6A	205 0748 064	JL Connector(R)			1	
C222	256 1034 937	Metalized 0.47μF/50V	CF93A1H474J	CN6B	205 0748 064	JL Connector(R)			1	
C223	257 0006 927	Chip Ceramic 470pF/50V	CC73SL1H471J	CN6C	205 0748 064	JL Connector(R)			1	
C224	257 0009 924	Chip Ceramic 2200pF/50V	CK73B1H222K	CN6D	205 0483 060	6P MQ-ST Conn. Base			1	
C225	254 4260 948	Electrolytic 1μF/50V	CE04W1H010M	CN8A	205 0483 086	8P MQ-ST Conn. Base			1	
C226	256 1035 978	Metalized 0.68μF/50V	CF93A1H684J	CN9A	205 0483 099	9P MQ-ST Conn. Base			2	
C227-229	256 1035 910	Metalized 0.22μF/50V	CF93A1H224J	CN10A	205 0483 002	10P MQ-ST Conn. Base			1	
C230,231	254 4260 977	Electrolytic 4.7μF/50V	CE04W1H4R7M	CN12B	205 0483 025	12P MQ-ST Conn. Base			1	
C232	256 1035 910	Metalized 0.22μF/50V	CF93A1H224J							
C233-236	256 1034 979	Metalized 0.1μF/50V	CF93A1H104J							
C237,238	255 1265 978	Plastic Film 0.022μF/50V	CQ93M1H223J(B)							
C239-241	254 4260 948	Electrolytic 1μF/50V	CE04W1H010M							
C242	257 0014 935	Chip Ceramic 0.1μF/25V	CK73F1E104Z							
C243,244	254 4260 948	Electrolytic 1μF/50V	CE04W1H010M							
C245	257 0006 927	Chip Ceramic 470pF/50V	CC73SL1H471J							
C246	257 0009 940	Chip Ceramic 3300pF/50V	CK73B1H332K							
C247	257 0014 935	Chip Ceramic 0.1μF/25V	CK73F1E104Z							
C248,249	257 0013 907	Chip Ceramic 0.047μF/50V	CK73F1H473Z							
C250	254 4254 938	Electrolytic 47μF/16V	CE04W1C470M							
C251	257 0014 935	Chip Ceramic 0.1μF/25V	CK73F1E104Z							
C252	257 0006 927	Chip Ceramic 470pF/50V	CC73SL1H471J							
C253,254	257 0009 979	Chip Ceramic 5600pF/50V	CK73B1H562K							
C255	257 0014 935	Chip Ceramic 0.1μF/25V	CK73F1E104Z							
C256	254 4254 909	Electrolytic 10μF/16V	CE04W1C100M							
C257	254 4252 930	Electrolytic 100μF/10V	CE04W1A101M							
C259,260	257 0005 944	Chip Ceramic 220pF/50V	CC73SL1H221J							
C261-264	254 4254 909	Electrolytic 10μF/16V	CE04W1C100M							
C265	257 0006 927	Chip Ceramic 470pF/50V	CC73SL1H471J							
C266	257 0005 986	Chip Ceramic 330pF/50V	CC73SL1H331J							
C267,268	254 4254 909	Electrolytic 10μF/16V	CE04W1C100M							
C269,270	257 0012 982	Chip Ceramic 0.022μF/50V	CK73F1H223Z							
C271,272	254 4254 909	Electrolytic 10μF/16V	CE04W1C100M							
C273	257 0005 944	Chip Ceramic 220pF/50V	CC73SL1H221J							
C274,275	254 4254 909	Electrolytic 10μF/16V	CE04W1C100M							

1U-2652B SURROUND UNIT ASS'Y (Europe model)

Ref. No.	Part No.	Part Name	Remarks
SEMICONDUCTORS			
IC001	263 0891 001	IC LA1265(S)	
IC002	263 0439 007	IC LA3401	
IC003	263 0791 907	IC LM7001M	
IC004	216 0065 006	Front End	
IC101	263 0896 909	NJM2068MD	
IC102	262 1228 007	IC LC7822	
IC103	263 0672 903	IC BA4558F	
IC201	263 0906 006	IC NJM2177AF	
IC202	262 1874 008	IC NJU9701G	
IC203	262 1875 900	IC BU4066BCF	
IC205	262 1875 900	IC BU4066BCF	
IC261	263 0672 903	IC BA4558F	
IC262	262 0625 009	IC TC9176P	
IC263	263 0672 903	IC BA4558F	
IC264	263 0905 900	IC BA6208F	
TR001	275 0074 902	FFT 2SK211-Y/GR	
TR002	273 0411 909	Transistor 2SC2996-Y	
TR003,004	269 0114 906	Transistor RN2402	Built in Resistor
TR005	273 0403 904	Transistor 2SC2712-Y/GR	
TR006	275 0075 901	FET 2SK209-Y/GR	
TR007,008	269 0066 902	Transistor DTC323TK	Built in Resistor
TR009	269 0085 909	Transistor DTC144TK	Built in Resistor
TR010	269 0086 908	Transistor DTA114TK	Built in Resistor
TR201	269 0055 900	Transistor DTA144EK	Built in Resistor
TR202,203	269 0054 901	Transistor DTC144EK	Built in Resistor
TR205	269 0054 901	Transistor DTC144EK	Built in Resistor
TR206	273 0384 900	Transistor 2SC2412K(S)	
TR207-209	269 0054 901	Transistor DTC144EK	Built in Resistor
TR210	274 0169 908	Transistor 2SD1292(R)	
D001-003	276 0616 907	Diode 1SS252	
D006	276 0616 907	Diode 1SS252	
D202-205	276 0616 907	Diode 1SS252	
D261	276 0616 907	Diode 1SS252	
ZD201	276 0462 902	Zener Diode HZS6B-1	6V
RESISTORS GROUP (Not included Carbon Film $\pm 5\%$ 1/4 W Type. Refer to the Schematic Diagram for those Parts.)			
R001	247 0007 945	Chip Carbon 1kohm 1/10W	RM73B--102J
R002	247 0009 927	Chip Carbon 5.6kohm 1/10W	RM73B--562J
R003	247 0004 906	Chip Carbon 39ohm 1/10W	RM73B--390J
R004	247 0009 985	Chip Carbon 10kohm 1/10W	RM73B--103J
R005	247 0006 946	Chip Carbon 390ohm 1/10W	RM73B--391J
R006	247 0006 920	Chip Carbon 330ohm 1/10W	RM73B--331J
R007	247 0009 901	Chip Carbon 4.7kohm 1/10W	RM73B--472J
R008	247 0006 920	Chip Carbon 330ohm 1/10W	RM73B--331J
R009	247 0005 989	Chip Carbon 220ohm 1/10W	RM73B--221J
R010	247 0008 902	Chip Carbon 1.8kohm 1/10W	RM73B--182J
R011	247 0006 920	Chip Carbon 330ohm 1/10W	RM73B--331J
R014	247 0005 905	Chip Carbon 100ohm 1/10W	RM73B--101J
R015	247 0009 969	Chip Carbon 8.2kohm 1/10W	RM73B--822J
R016	247 0008 986	Chip Carbon 3.9kohm 1/10W	RM73B--392J
R017	247 0006 946	Chip Carbon 390ohm 1/10W	RM73B--391J
R018	247 0005 947	Chip Carbon 150ohm 1/10W	RM73B--151J
R019	247 0005 921	Chip Carbon 120ohm 1/10W	RM73B--121J
R020	247 0010 929	Chip Carbon 15kohm 1/10W	RM73B--153J
R021	247 0005 921	Chip Carbon 120ohm 1/10W	RM73B--121J
R022	247 0011 928	Chip Carbon 39kohm 1/10W	RM73B--393J
R023	247 0007 961	Chip Carbon 1.2kohm 1/10W	RM73B--122J
R024	247 0009 943	Chip Carbon 6.8kohm 1/10W	RM73B--682J

Ref. No.	Part No.	Part Name	Remarks
R025,026	247 0009 985	Chip Carbon 10kohm 1/10W	RM73B--103J
R027	247 0008 960	Chip Carbon 3.3kohm 1/10W	RM73B--332J
R028	247 0009 972	Chip Carbon 9.1kohm 1/10W	RM73B--912J
R029	247 0011 986	Chip Carbon 68kohm 1/10W	RM73B--683J
R030	247 0011 928	Chip Carbon 39kohm 1/10W	RM73B--393J
R031	247 0011 973	Chip Carbon 62kohm 1/10W	RM73B--623J
R032	247 0012 969	Chip Carbon 150kohm 1/10W	RM73B--154J
R033,034	247 0012 998	Chip Carbon 200kohm 1/10W	RM73B--204J
R035	247 0012 969	Chip Carbon 150kohm 1/10W	RM73B--154J
R036	247 0008 960	Chip Carbon 3.3kohm 1/10W	RM73B--332J
R037,038	247 0012 927	Chip Carbon 100kohm 1/10W	RM73B--104J
R039-042	247 0008 960	Chip Carbon 3.3kohm 1/10W	RM73B--332J
R043	247 0010 961	Chip Carbon 22kohm 1/10W	RM73B--223J
R044,045	247 0009 985	Chip Carbon 10kohm 1/10W	RM73B--103J
R046	247 0009 927	Chip Carbon 5.6kohm 1/10W	RM73B--562J
R047	247 0009 985	Chip Carbon 10kohm 1/10W	RM73B--103J
R051,052	247 0012 927	Chip Carbon 100kohm 1/10W	RM73B--104J
R071	247 1018 904	Chip Carbon 0ohm 1/8W	RM73B2B0R0K
R079	247 1018 904	Chip Carbon 0ohm 1/8W	RM73B2B0R0K
R081	247 1018 904	Chip Carbon 0ohm 1/8W	RM73B2B0R0K
R083	247 1018 904	Chip Carbon 0ohm 1/8W	RM73B2B0R0K
R084	247 0018 905	Chip Carbon 0ohm 1/10W	RM73B--0R0K
R085-094	247 1018 904	Chip Carbon 0ohm 1/8W	RM73B2B0R0K
R096-098	247 1018 904	Chip Carbon 0ohm 1/8W	RM73B2B0R0K
R101,102	247 0006 946	Chip Carbon 390ohm 1/10W	RM73B--391J
R103,104	247 0011 986	Chip Carbon 68kohm 1/10W	RM73B--683J
R105,106	247 0012 969	Chip Carbon 150kohm 1/10W	RM73B--154J
R107,108	247 0004 922	Chip Carbon 47ohm 1/10W	RM73B--470J
R109,110	247 0007 945	Chip Carbon 1kohm 1/10W	RM73B--102J
R111,112	247 0014 909	Chip Carbon 560kohm 1/10W	RM73B--564J
R113,114	247 0011 944	Chip Carbon 47kohm 1/10W	RM73B--473J
R115,116	247 0003 949	Chip Carbon 22ohm 1/10W	RM73B--220J
R117,118	247 0005 905	Chip Carbon 100ohm 1/10W	RM73B--101J
R119,120	247 0013 984	Chip Carbon 470kohm 1/10W	RM73B--474J
R121-132	247 0015 966	Chip Carbon 2.7Mohm 1/10W	RM73B--275J
R133-144	247 0006 962	Chip Carbon 470ohm 1/10W	RM73B--471J
R145	247 0014 925	Chip Carbon 680kohm 1/10W	RM73B--684J
R151,152	247 0006 962	Chip Carbon 470ohm 1/10W	RM73B--471J
R153,154	247 0011 973	Chip Carbon 62kohm 1/10W	RM73B--623J
R155,156	247 0013 984	Chip Carbon 470kohm 1/10W	RM73B--474J
R157-160	247 0005 905	Chip Carbon 100ohm 1/10W	RM73B--101J
R201	247 0009 956	Chip Carbon 7.5kohm 1/10W	RM73B--752J
R202	247 0011 944	Chip Carbon 47kohm 1/10W	RM73B--473J
R203	247 0010 929	Chip Carbon 15kohm 1/10W	RM73B--153J
R204	247 0009 956	Chip Carbon 7.5kohm 1/10W	RM73B--752J
R205	247 0011 944	Chip Carbon 47kohm 1/10W	RM73B--473J
R206	247 0010 929	Chip Carbon 15kohm 1/10W	RM73B--153J
R207	247 0016 923	Chip Carbon 4.7Mohm 1/10W	RM73B--475J
R208,209	247 0011 960	Chip Carbon 56kohm 1/10W	RM73B--563J
R210	247 0012 927	Chip Carbon 100kohm 1/10W	RM73B--104J
R211	247 0019 988	Chip Carbon 100kohm 1/10W	RM73B--104F($\pm 1\%$)
R212	247 0010 929	Chip Carbon 15kohm 1/10W	RM73B--153J
R213	247 0009 969	Chip Carbon 8.2kohm 1/10W	RM73B--822J
R214	247 0010 929	Chip Carbon 15kohm 1/10W	RM73B--153J
R215	247 0013 942	Chip Carbon 330kohm 1/10W	RM73B--334J
R218-220	247 0011 944	Chip Carbon 47kohm 1/10W	RM73B--473J
R221-223	247 0009 969	Chip Carbon 8.2kohm 1/10W	RM73B--822J
R224	247 0014 967	Chip Carbon 1Mohm 1/10W	RM73B--105J
R225	247 0010 929	Chip Carbon 15kohm 1/10W	RM73B--153J
R226	247 0010 945	Chip Carbon 18kohm 1/10W	RM73B--183J
R227	247 0010 929	Chip Carbon 15kohm 1/10W	RM73B--153J
R228,229	247 0003 936	Chip Carbon 20ohm 1/10W	RM73B--200J
R230	247 0009 956	Chip Carbon 7.5kohm 1/10W	RM73B--752J
R231	247 0009 927	Chip Carbon 5.6kohm 1/10W	RM73B--562J
R232	247 0010 945	Chip Carbon 18kohm 1/10W	RM73B--183J

Ref. No.	Part No.	Part Name	Remarks	Ref. No.	Part No.	Part Name	Remarks
R233-235	247 0011 944	Chip Carbon 47kohm 1/10W	RM73B--473J	C059-061	257 0012 966	Chip Ceramic 0.01μF/50V	CK73F1H103Z
▲ R236	241 2387 940	Carbon Film 4.7ohm 1/4 W(NB)	RD14B2E4R7JNBS	C063	254 4254 909	Electrolytic 10μF/16V	CE04W1C100M
R237	247 0007 945	Chip Carbon 1kohm 1/10W	RM73B--102J	C065	257 0012 966	Chip Ceramic 0.01μF/50V	CK73F1H103Z
R239,240	247 0005 905	Chip Carbon 100ohm 1/10W	RM73B--101J	C101,102	257 0005 944	Chip Ceramic 220pF/50V	CC73SL1H221J
R241,242	247 0006 962	Chip Carbon 470ohm 1/10W	RM73B--471J	C103,104	254 4254 909	Electrolytic 10μF/16V	CE04W1C100M
R251,252	247 0008 928	Chip Carbon 2.2kohm 1/10W	RM73B--222J	C105,106	257 0004 961	Chip Ceramic 100pF/50V	CC73SL1H101J
R253,254	247 0009 901	Chip Carbon 4.7kohm 1/10W	RM73B--472J	C107,108	254 4254 925	Electrolytic 33μF/16V	CE04W1C330M
R261,262	247 0012 927	Chip Carbon 100kohm 1/10W	RM73B--104J	C109,110	255 1264 995	Plastic Film 0.0056μF/50V	CQ93M1H562J(B)
R263,264	247 0013 900	Chip Carbon 220kohm 1/10W	RM73B--224J	C111,112	257 0009 908	Chip Ceramic 1500pF/50V	CK73B1H152K
R265,266	247 0007 945	Chip Carbon 1kohm 1/10W	RM73B--102J	C113,114	257 0012 982	Chip Ceramic 0.022μF/50V	CK73F1H223Z
R267,268	247 0008 960	Chip Carbon 3.3kohm 1/10W	RM73B--332J	C115,116	254 4260 951	Electrolytic 2.2μF/50V	CE04W1H2R2M
R269,270	247 0005 905	Chip Carbon 100ohm 1/10W	RM73B--101J	C121-128	257 0004 903	Chip Ceramic 56pF/50V	CC73SL1H560J
R271	247 0013 984	Chip Carbon 470kohm 1/10W	RM73B--474J	C133	254 4260 948	Electrolytic 1μF/50V	CE04W1H010M
R272	247 0005 905	Chip Carbon 100ohm 1/10W	RM73B--101J	C136-138	257 0012 982	Chip Ceramic 0.022μF/50V	CK73F1H223Z
R273	247 0007 945	Chip Carbon 1kohm 1/10W	RM73B--102J	C139	257 0009 924	Chip Ceramic 2200pF/50V	CK73B1H222K
R274	247 0009 927	Chip Carbon 5.6kohm 1/10W	RM73B--562J	C147,148	257 0004 961	Chip Ceramic 100pF/50V	CC73SL1H101J
R275,276	247 0005 905	Chip Carbon 100ohm 1/10W	RM73B--101J	C151,152	254 4254 909	Electrolytic 10μF/16V	CE04W1C100M
R277,278	247 0009 985	Chip Carbon 10kohm 1/10W	RM73B--103J	C153,154	257 0004 961	Chip Ceramic 100pF/50V	CC73SL1H101J
R279	247 0013 984	Chip Carbon 470kohm 1/10W	RM73B--474J	C155,156	254 4260 948	Electrolytic 1μF/50V	CE04W1H010M
R280	247 0007 945	Chip Carbon 1kohm 1/10W	RM73B--102J	C201,202	256 1034 979	Metalized 0.1μF/50V	CF93A1H104J
R281	247 0009 927	Chip Carbon 5.6kohm 1/10W	RM73B--562J	C203	257 0006 969	Chip Ceramic 680pF/50V	CC73SL1H681J
R282	247 0005 905	Chip Carbon 100ohm 1/10W	RM73B--101J	C204	256 1034 937	Metalized 0.47μF/50V	CF93A1H474J
VR261	211 0802 002	Variable Resister 100kohm		C205,206	256 1034 979	Metalized 0.1μF/50V	CF93A1H104J
CAPACITORS GROUP				C207	257 0006 969	Chip Ceramic 680pF/50V	CC73SL1H681J
C001,002	257 0012 966	Chip Ceramic 0.01μF/50V	CK73F1H103Z	C208	256 1034 937	Metalized 0.47μF/50V	CF93A1H474J
C004	257 0002 947	Chip Ceramic 12pF/50V	CC73SL1H120J	C209	254 4254 912	Electrolytic 22μF/16V	CE04W1C220M
C005	254 4254 909	Electrolytic 10μF/16V	CE04W1C100M	C210,211	254 4254 909	Electrolytic 10μF/16V	CE04W1C100M
C006-008	257 0012 966	Chip Ceramic 0.01μF/50V	CK73F1H103Z	C212	254 4252 930	Electrolytic 100μF/10V	CE04W1A101M
C011	254 3056 917	Electrolytic 1μF/50V (Bipole)	CE04D1H010MBP	C213	255 1264 982	Plastic Film 0.0047μF/50V	CQ93M1H472J(B)
C012	254 4254 938	Electrolytic 47μF/16V	CE04W1C470M	C214	254 4254 912	Electrolytic 22μF/16V	CE04W1C220M
C013	254 4260 906	Electrolytic 0.1μF/50V	CE04W1H0R1M	C215	254 4254 909	Electrolytic 10μF/16V	CE04W1C100M
C014	257 0012 982	Chip Ceramic 0.022μF/50V	CK73F1H223Z	C216	256 1035 910	Metalized 0.22μF/50V	CF93A1H224J
C016	257 0004 961	Chip Ceramic 100pF/50V	CC73SL1H101J	C217,218	254 4254 909	Electrolytic 10μF/16V	CE04W1C100M
C017,018	257 0012 966	Chip Ceramic 0.01μF/50V	CK73F1H103Z	C219	254 4254 941	Electrolytic 100μF/16V	CE04W1C101M
C019	254 4260 935	Electrolytic 0.47μF/50V	CE04W1HR47M	C220	255 1264 995	Plastic Film 0.0056μF/50V	CQ93M1H562J(B)
C020	254 4260 948	Electrolytic 1μF/50V	CE04W1H010M	C221	254 4250 958	Electrolytic 470μF/6.3V	CE04W0J471M
C021	254 4260 980	Electrolytic 10μF/50V	CE04W1H100M	C222	256 1034 937	Metalized 0.47μF/50V	CF93A1H474J
C022	257 0012 982	Chip Ceramic 0.022μF/50V	CK73F1H223Z	C223	257 0006 927	Chip Ceramic 470pF/50V	CC73SL1H471J
C024	256 1034 940	Metalized 0.056μF/50V	CF93A1H563J	C224	257 0009 924	Chip Ceramic 2200pF/50V	CK73B1H222K
C025,026	254 4254 912	Electrolytic 22μF/16V	CE04W1C220M	C225	254 4260 948	Electrolytic 1μF/50V	CE04W1H010M
C027	254 4254 909	Electrolytic 10μF/16V	CE04W1C100M	C226	256 1035 978	Metalized 0.68μF/50V	CF93A1H684J
C028	254 4260 948	Electrolytic 1μF/50V	CE04W1H010M	C227-229	256 1035 910	Metalized 0.22μF/50V	CF93A1H224J
C029	257 0012 966	Chip Ceramic 0.01μF/50V	CK73F1H103Z	C230,231	254 4260 977	Electrolytic 4.7μF/50V	CE04W1H4R7M
C033,034	257 0002 976	Chip Ceramic 16pF/50V	CC73SL1H160J	C232	256 1035 910	Metalized 0.22μF/50V	CF93A1H224J
C035	256 1034 937	Metalized 0.047μF/50V	CF93A1H473J	C233-236	256 1034 979	Metalized 0.1μF/50V	CF93A1H104J
C036,037	257 0012 966	Chip Ceramic 0.01μF/50V	CK73F1H103Z	C237,238	255 1265 978	Plastic Film 0.022μF/50V	CQ93M1H223J(B)
C038	254 4254 938	Electrolytic 47μF/16V	CE04W1C470M	C239-241	254 4260 948	Electrolytic 1μF/50V	CE04W1H010M
C039	257 0012 966	Chip Ceramic 0.01μF/50V	CK73F1H103Z	C242	257 0014 935	Chip Ceramic 0.1μF/25V	CK73F1E104Z
C040	254 4260 948	Electrolytic 1μF/50V	CE04W1H010M	C243,244	254 4260 948	Electrolytic 1μF/50V	CE04W1H010M
C041	254 4254 938	Electrolytic 47μF/16V	CE04W1C470M	C245	257 0006 927	Chip Ceramic 470pF/50V	CC73SL1H471J
C042	254 4260 948	Electrolytic 1μF/50V	CE04W1H010M	C246	257 0009 940	Chip Ceramic 3300pF/50V	CK73B1H332K
C043	254 4260 919	Electrolytic 0.22μF/50V	CE04W1HR22M	C247	257 0014 935	Chip Ceramic 0.1μF/25V	CK73F1E104Z
C044	254 4260 948	Electrolytic 1μF/50V	CE04W1H010M	C248,249	257 0013 907	Chip Ceramic 0.047μF/50V	CK73F1H473Z
C045	257 0012 966	Chip Ceramic 0.01μF/50V	CK73F1H103Z	C250	254 4254 938	Electrolytic 47μF/16V	CE04W1C470M
C046,047	254 4260 951	Electrolytic 2.2μF/50V	CE04W1H2R2M	C251	257 0014 935	Chip Ceramic 0.1μF/25V	CK73F1E104Z
C048	254 4260 948	Electrolytic 1μF/50V	CE04W1H010M	C252	257 0006 927	Chip Ceramic 470pF/50V	CC73SL1H471J
C049	257 0012 966	Chip Ceramic 0.01μF/50V	CK73F1H103Z	C253,254	257 0009 979	Chip Ceramic 5600pF/50V	CK73B1H562K
C051	254 4260 951	Electrolytic 2.2μF/50V	CE04W1H2R2M	C255	257 0014 935	Chip Ceramic 0.1μF/25V	CK73F1E104Z
C052	254 4254 909	Electrolytic 10μF/16V	CE04W1C100M	C256	254 4254 909	Electrolytic 10μF/16V	CE04W1C100M
C053,054	257 0005 986	Chip Ceramic 330pF/50V	CC73SL1H331J	C257	254 4252 930	Electrolytic 100μF/10V	CE04W1A101M
C056,057	257 0012 966	Chip Ceramic 0.01μF/50V	CK73F1H103Z	C259,260	257 0005 944	Chip Ceramic 220pF/50V	CC73SL1H221J
				C261-264	254 4254 909	Electrolytic 10μF/16V	CE04W1C100M
				C265	257 0006 927	Chip Ceramic 470pF/50V	CC73SL1H471J
				C266	257 0005 986	Chip Ceramic 330pF/50V	CC73SL1H331J
				C267,268	254 4254 909	Electrolytic 10μF/16V	CE04W1C100M

Ref. No.	Part No.	Part Name	Remarks	
C269,270	257 0012 982	Chip Ceramic 0.022μF/50V	CK73F1H223Z	
C271,272	254 4254 909	Electrolytic 10μF/16V	CE04W1C100M	
C273	257 0005 944	Chip Ceramic 220pF/50V	CC73SL1H221J	
C274,275	254 4254 909	Electrolytic 10μF/16V	CE04W1C100M	
C276	254 3056 917	Electrolytic 1μF/50V (Bipole)	CE04D1H010MBP	
C277	257 0012 966	Chip Ceramic 0.01μF/50V	CK73F1H103Z	
C278	254 4260 948	Electrolytic 1μF/50V	CE04W1H010M	
C279	257 0012 966	Chip Ceramic 0.01μF/50V	CK73F1H103Z	
C281,282	255 1264 908	Plastic Film 0.001μF/50V	CQ93M1H102J	
OTHER GROUP				Q'ty
	—	(P.W.Board)		1
CF001,002	261 0064 007	Ceramic Filter SFT10.7MS2		2
CF003	261 0031 001	Ceramic Filter BFU450C4		1
CF004	261 0079 005	Ceramic Filter CSB456F11		1
CF005	261 0116 007	Ceramic Filter SFU450B3		1
L201	235 0060 989	Inductor 120μH		1
XT001	399 0075 003	Crystal 7.2 MHz		1
XT201	399 0223 907	Ceramic Resonator	CSA2.00MG-TF01	1
BL001	231 2096 001	MW Ant. Osc.Coil		1
T003	231 1138 009	AM IFT		1
T004	231 2085 009	FM Det. Trans		1
LF001	232 0159 008	Anti Birdie Filter		1
LF002,003	232 0085 004	Low Pass Filter		1
LF101,102	235 9003 002	FTZ Choke Coil		2
	204 8313 003	4P Pin Jack(S-GND)		2
	204 8346 009	6P Pin Jack(S-GND)		1
	205 0776 007	3P Ant. Terminal(PAL)		1
TP	205 0190 036	3P NH Conn. Base		1
CN6A	205 0748 064	JL Connector(R)		1
CN6B	205 0748 064	JL Connector(R)		1
CN6C	205 0748 064	JL Connector(R)		1
CN6D	205 0483 060	6P MQ-ST Conn. Base		1
CN8A	205 0483 086	8P MQ-ST Conn. Base		1
CN9A	205 0483 099	9P MQ-ST Conn. Base		2
CN10A	205 0483 002	10P MQ-ST Conn. Base		1
CN12B	205 0483 025	12P MQ-ST Conn. Base		1

BLOCK DIAGRAM

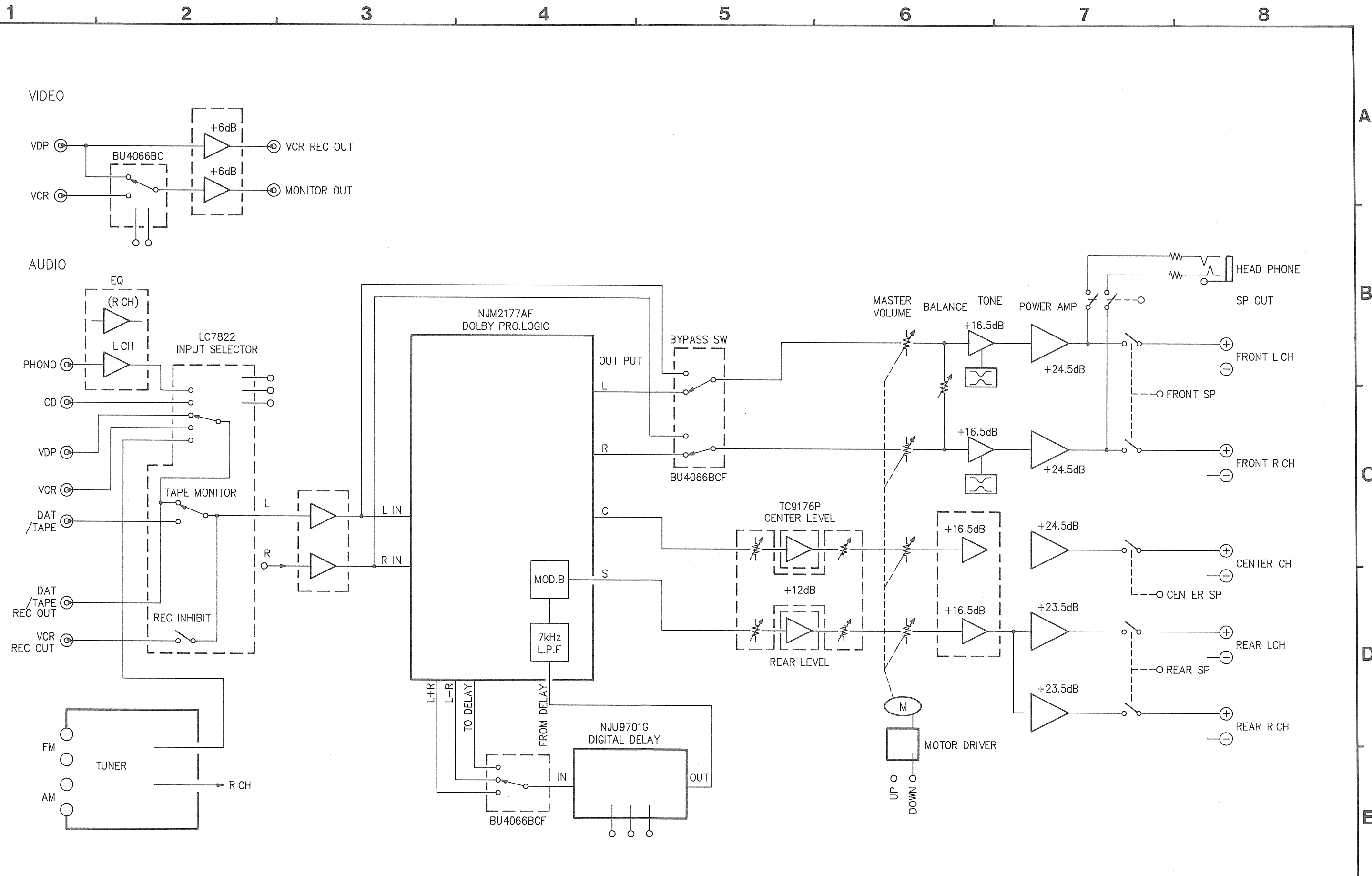

WIRING DIAGRAM

1 2 3 4 5 6 7 8

A

B

C

D

E

	MAIN AMP UNIT	REAR AMP UNIT	SURROUND UNIT
U.S.A. & CANADA	1U-2650	1U-2651	1U-2652
EUROPE	1U-2650B	1U-2651B	1U-2652B

To AC LINE AC120V,60Hz for U.S.A. and Canada
AC230V,50Hz for Europe

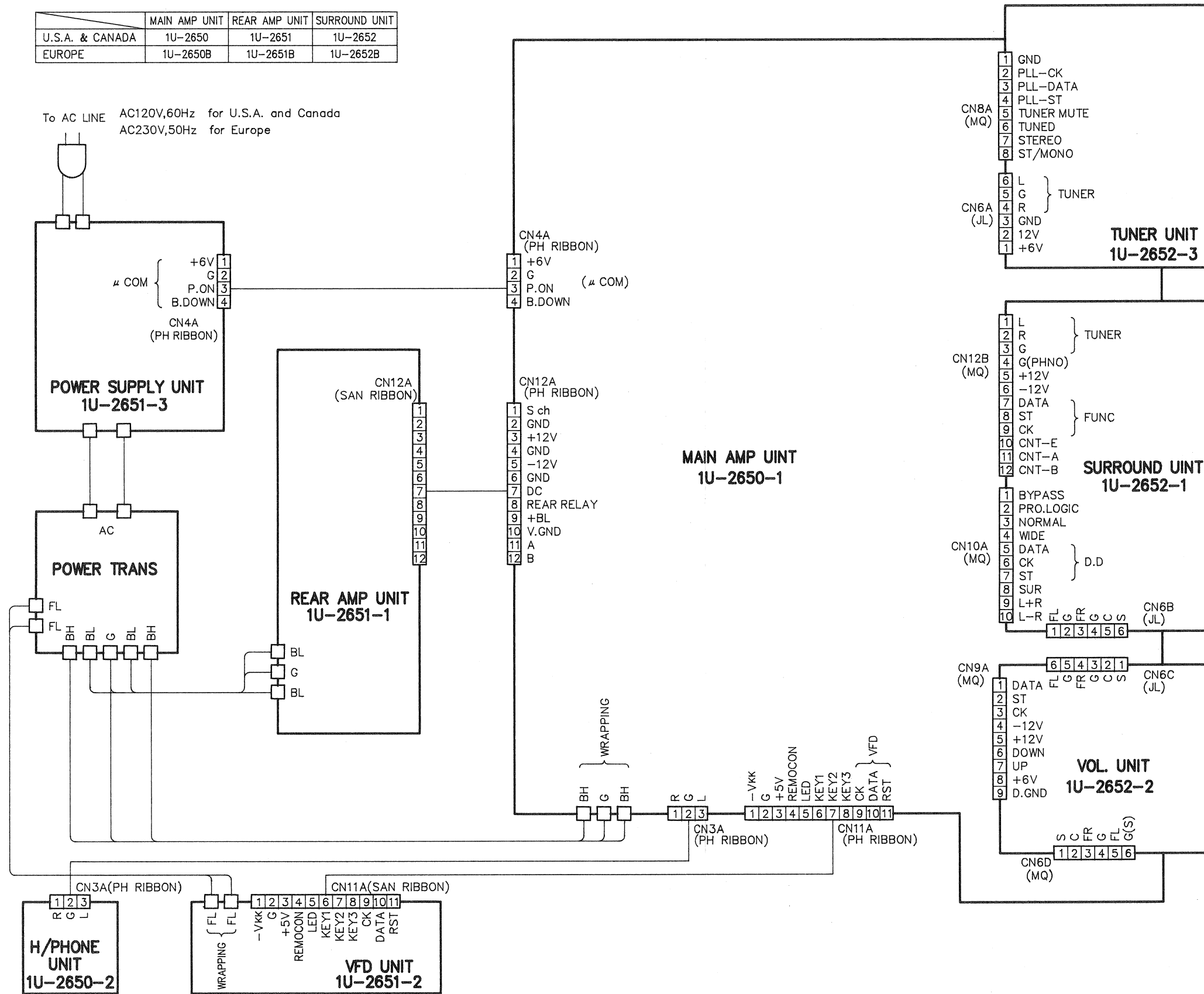

1U-2652-1 SURROUND UNIT

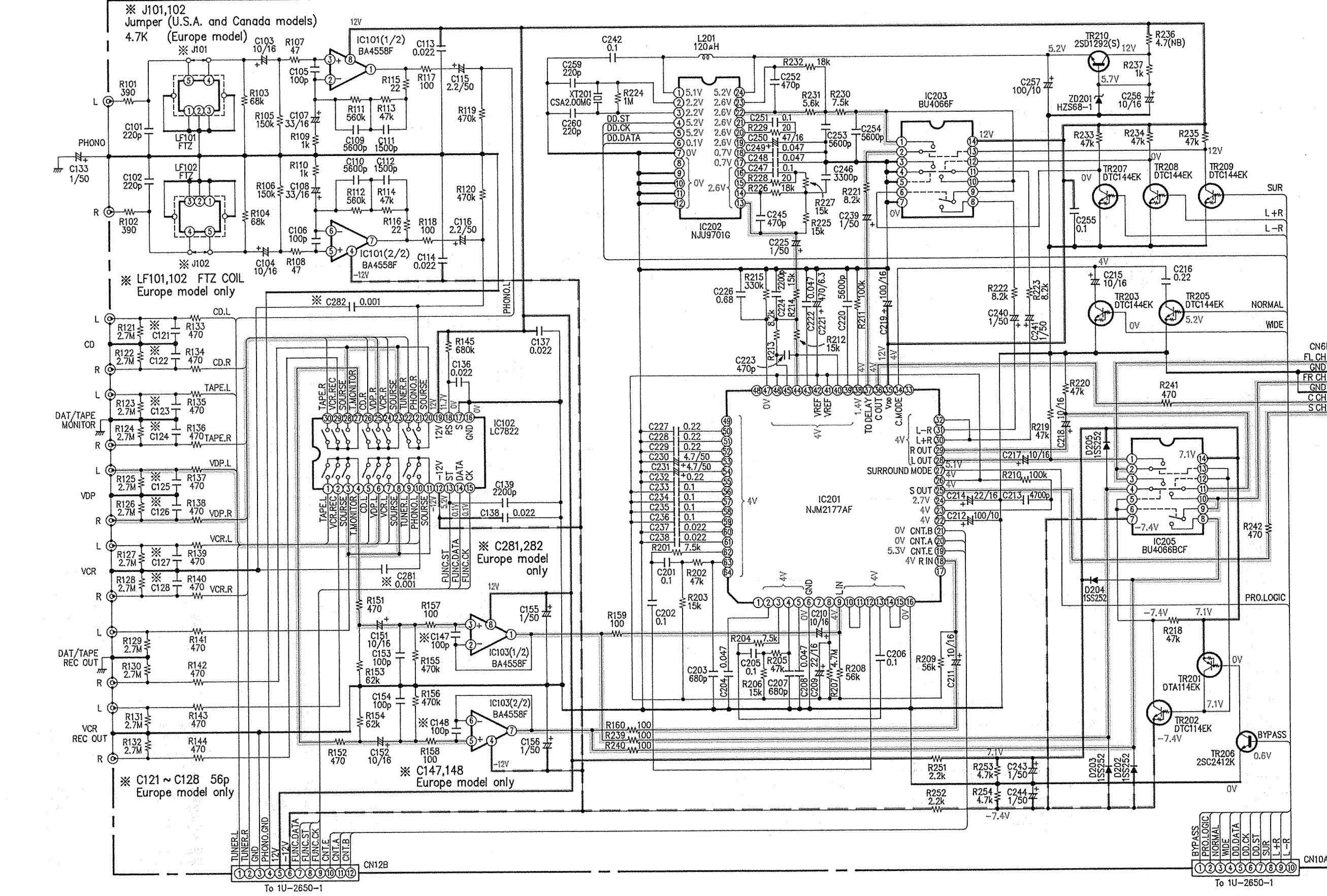

1U-2652-2 VOLUME UNIT

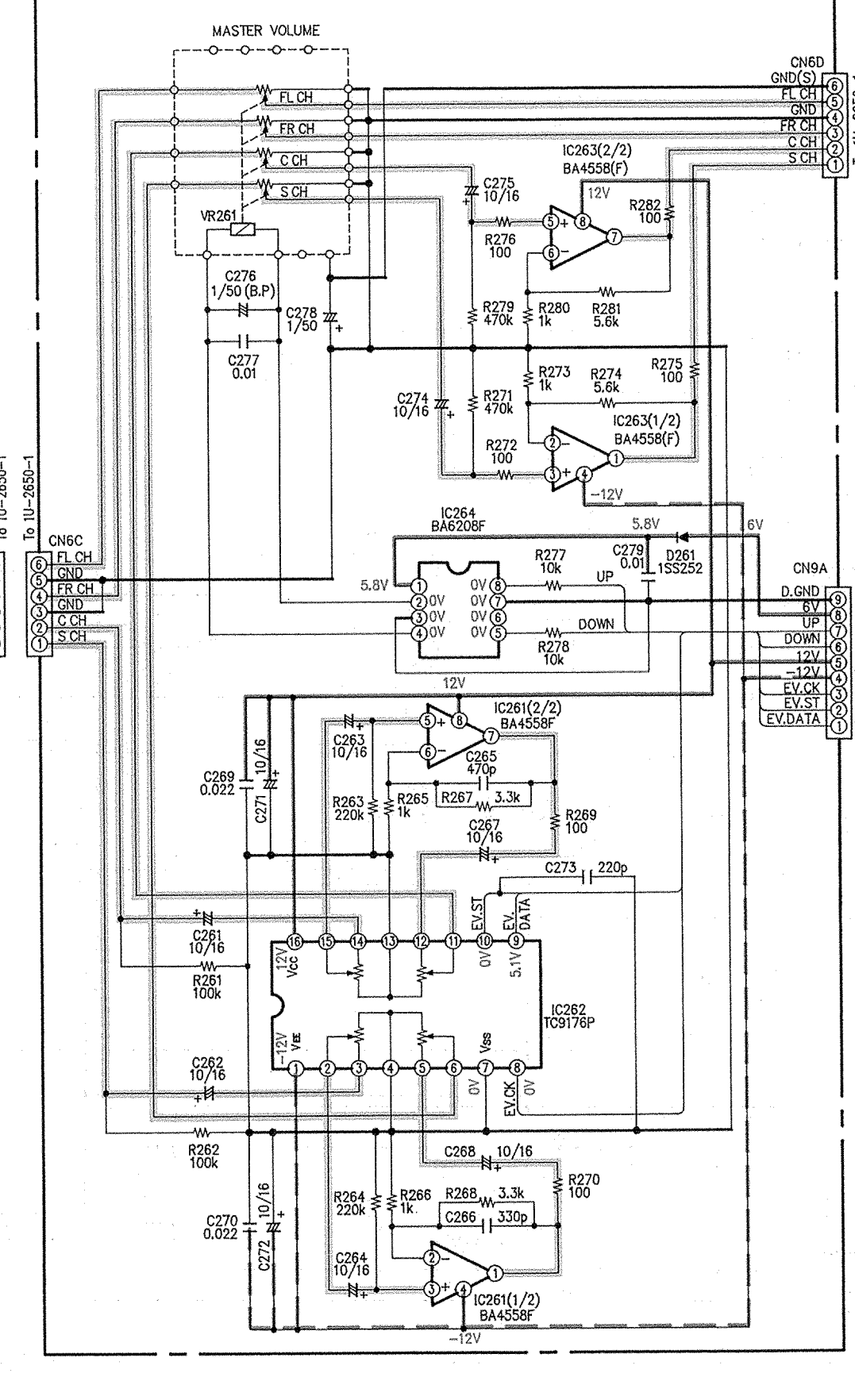

NOTES
 ALL RESISTANCE VALUES IN OHM. k=1,000 OHM, M=1,000,000 OHM
 ALL CAPACITANCE VALUES IN MICRO FARAD. P=MICRO-MICRO FARAD
 EACH VOLTAGE AND CURRENT ARE MEASURED AT NO SIGNAL INPUT CONDITION.
 CIRCUIT AND PARTS ARE SUBJECT TO CHANGE WITHOUT PRIOR NOTICE.

WARNING:
 Parts marked with this symbol have critical characteristics. Use ONLY replacement parts recommended by the manufacturer.

CAUTION:
 Before returning the unit to the customer, make sure you make either (1) a leakage current check or (2) a line to chassis resistance check. If the leakage current exceeds 0.5 millamps, or if the resistance from chassis to either side of the power cord is less than 240 kohms, the unit is defective.

WARNING:
 DO NOT return the unit to the customer until the problem is located and corrected.



1 2 3 4 5 6 7 8 9 10 11 12 13 14 15

U.S.A and Canada model

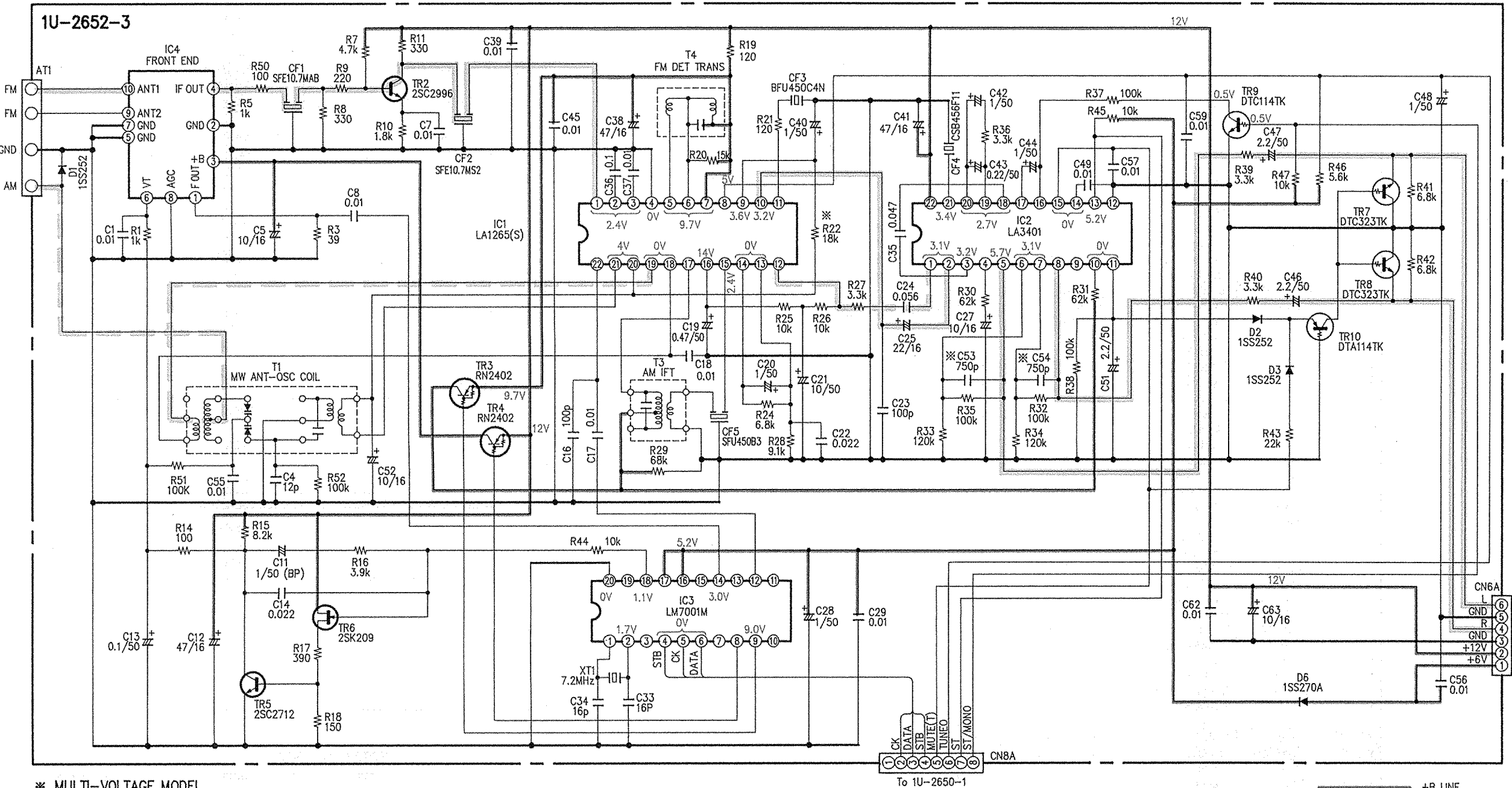

* MULTI-VOLTAGE MODEL
 C53,54 510p
 R22 39k

— +B LINE
 FM SIGNAL LINE
 AM SIGNAL LINE

WARNING:
 Parts marked with this symbol have critical characteristics. Use ONLY replacement parts recommended by the manufacturer.

CAUTION:
 Before returning the unit to the customer, make sure you make either (1) a leakage current check or (2) a line to chassis resistance check. If the leakage current exceeds 0.5 millamps, or if the resistance from chassis to either side of the power cord is less than 240 kohms, the unit is defective.

WARNING:
 DO NOT return the unit to the customer until the problem is located and corrected.

Europe model

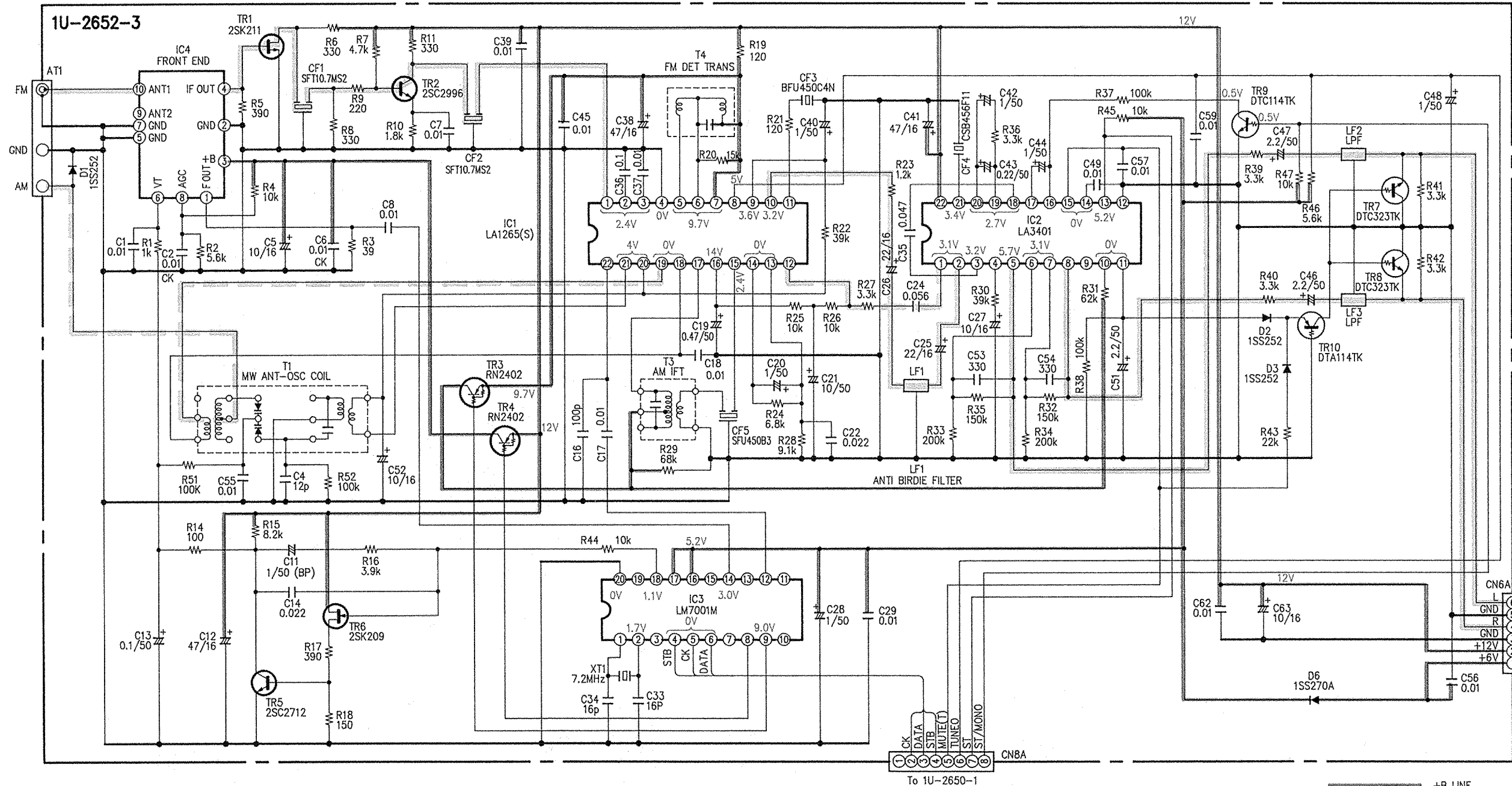

* MULTI-VOLTAGE MODEL
 C53,54 510p
 R22 39k

— +B LINE
 FM SIGNAL LINE
 AM SIGNAL LINE

NOTES
 ALL RESISTANCE VALUES IN OHM. k=1,000 OHM, M=1,000,000 OHM
 ALL CAPACITANCE VALUES IN MICRO FARAD. P=MICRO-MICRO FARAD
 EACH VOLTAGE AND CURRENT ARE MEASURED AT NO SIGNAL INPUT CONDITION.
 CIRCUIT AND PARTS ARE SUBJECT TO CHANGE WITHOUT PRIOR NOTICE.

EXPLODED VIEW OF CHASSIS AND CABINET

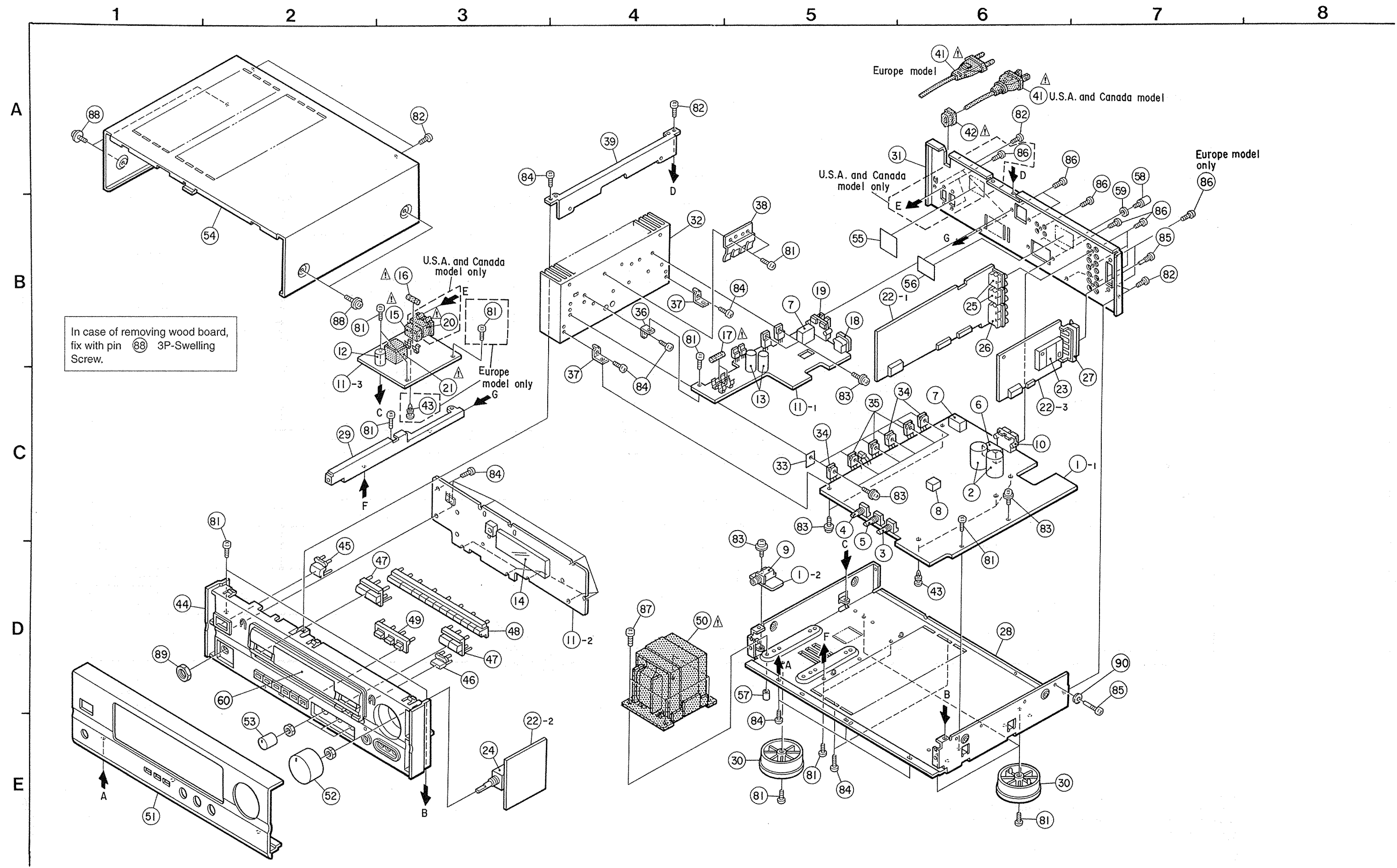

EXPLODED VIEW PARTS LIST

Ref. No.	Part No.	Part Name	Remarks	Q'ty
1	Note	Main Amp. Unit Ass'y		1 ^S
1-1	—	Main Amp. Unit		(1)
2	254 4349 717	Chemicon 5600µF/56V	C353,354	2
3	211 0798 103	Variable Resistor 100kohm	Balance(VR451)	1
4	211 0797 117	Variable Resistor 30kohm	Bass (VR452)	1
5	211 0797 104	Variable Resistor 5kohm	Treble (VR453)	1
6	214 9003 005	Relay	RL481	1
7	214 0167 005	Relay(G5Z-2A)	RL480,501	2
8	214 0162 000	Relay(A12W-K)	RL482	1
9	204 8354 004	Headphone Jack		1
10	205 0846 005	6P Push Terminal		1
11	Note	Rear Amp. Unit Ass'y		1 ^S
11-1	—	Rear Amp. Unit		(1)
11-2	—	VFD Unit		(1)
11-3	—	Power Supply Unit		(1)
12	254 4256 790	Chemicon 2200µF/25V	C555	1
13	254 4259 713	Chemicon 3300µF/35V	C517,518	2
14	393 4131 000	FLD(FIP14PM8) Ass'y	FL701	1
15	214 0170 005	Relay(TV-8)	RL551	1
16	Note	Fuse A	F001	1
17	Note	Fuse A	F003,004	2
18	204 8442 000	4P Pin Jack(S-GND)		1
19	205 0592 003	4P Push Terminal		1
20	Note	AC Outlet(2P)		1
21	Note	Power Trans(Mini)		1
22	Note	Surround Unit Ass'y		1 ^S
22-1	—	Surround Unit		(1)
22-2	—	Volume Unit		(1)
22-3	—	Tuner Unit		(1)
23	Note	Front End	IC004	1
24	211 0802 002	Variable Resistor 100kohm	VR261	1
25	204 8313 003	4P Pin Jack(S-GND)		2
26	204 8346 009	6P Pin Jack(S-GND)		1
27	Note	Ant. Terminal		1
28	411 1267 301	Main Chassis		1
29	412 3751 106	Center Bracket		1
30	104 0194 108	Foot Ass'y		4
31	Note	Rear Panel		1
32	417 0492 104	Power Radiator		1
33	415 0234 007	Insulating Sheet		6
34	271 0237 006	Transistor 2SA1490(OP/Y)(Z)	TR321,322,411	3
35	273 0386 005	Transistor 2SC3854(OP/Y)(Z)	TR317,318,410	3
36	412 3766 007	L Bracket		1
37	412 3767 006	P.W.B Bracket		2
38	412 3470 102	Spring Plate		1
39	412 3752 008	Radiator Bracket		1
40	—	—		—
41	Note	AC Cord with plug		1
42	445 0056 008	Cord Bush		1
43	Note	Card Spacer(L=12)		4
44	146 1465 649	Inner Panel		1
45	113 1636 106	Push Knob(P)		1
46	113 1637 008	Push Knob		1
47	113 1638 104	Function Knob		2
48	113 1639 006	Pre-set Knob		1
49	113 1640 105	Tact Knob		1
50	Note	Power Trans		1
51	144 2321 139	Front Panel		1
52	112 0737 003	Volume Knob		1
53	112 0739 001	Knob(Round)		3
54	102 0543 009	Top Cover		1
55	Note	Caution Label(A)		1
56	Note	Caution Label(B)		1
57	462 0094 007	Screw Tube		1

EXPLODED VIEW PARTS LIST

Ref. No.	Part No.	Part Name	Remarks	Q'ty
58	205 0071 016	Terminal Ass'y		1
59	477 0018 001	Washer (P-87)		1
60	143 0867 003	Window		1
61	—	—		—
62	—	—		—
63	—	—		—
SCREWS				
81	Note	Tapping Screw(S)3x8	Black	16
82	473 7015 018	Tapping Screw(S)3x8	Black	7
83	473 8007 009	Cup Screw 3x12		12
84	473 7501 001	Tapping Screw(P)3x10		19
85	Note	Earth Screw		2
86	477 0064 107	Fixing Screw		10
87	473 7004 029	Tapping Screw(S)4x10	Black	4
88	477 0263 005	3P Swelling Screw		4
89	475 6124 003	Nut M 12		1
90	475 2003 034	Spring Washer φ3	BKNI	1
PACKING & ACCESSORIES				
101	504 0162 000	Stylen Paper	for AC cord	1
102	504 0162 013	Stylen Paper	for Set	1
103	505 0272 003	Cup Screw 3x12		1
104	503 1113 204	Cushion		2
105	GEN 2599	Envelope Sub Ass'y		1 ^S
105-1	505 8006 019	Envelope		(1)
105-2	Note	Inst. Manual		(1)
105-3	399 0221 006	Remote Control	RC-169	(1)
105-4	—	Battery		(1)
105-5	231 0922 009	Loop Antenna		(1)
105-6	Note	FM Ant. Ass'y		(1)
105-7	Note	DAI Warranty Home		(1)
105-7	Note	DCI Warranty Home		(1)
106	501 1738 007	Carton Case		1
107	Note	CSA Label		1
108	—	—		—

ADDENDUM PARTS LIST

Ref. No.	Part Name	Q'ty	Part No.		
			U.S.A. model	CANADA model	EUROPE model
1	Main Unit Ass'y	1 ^S	1U-2650	1U-2650	1U-2650 B
11	Rear Amp. Unit Ass'y	1 ^S	1U-2651	1U-2651	1U-2651 B
16	Fuse A(F001)	1	206 1046 001 6.3A UL20mm	206 1046 001 6.3A UL20mm	206 1015 032 2.5A
17	Fuse A(F003,004)	2	206 1046 027 5 A	206 1046 027 5 A	—
20	AC Outlet(2P)	1	203 3941 008	203 3941 008	—
21	Power Trans(Mini)	1	233 6073 000	233 6073 000	233 6058 012
22	Surround Unit Ass'y	1 ^S	1U-2652	1U-2652	1U-2652 B
23	Front End(IC104)	1	216 0064 007	216 0064 007	216 0065 006
27	Ant. Terminal	1	205 0505 003	205 0505 003	205 0776 007
31	Rear Panel	1	105 1100 301	105 1100 301	105 1100 314
41	AC Cord with plug	1	206 2050 009	206 2050 009	206 2063 009
43	Card Spacer(L=12)	1	412 2814 057 (3)	412 2814 057 (3)	412 2814 057 (4)
50	Power Trans	1	233 6072 001	233 6072 001	233 6086 000
55	Caution Label(A)	1	513 2209 004	513 2209 004	—
56	Caution Label(B)	1	513 2210 006	513 2210 006	—
SCREWS					
81	Tapping Screw(S) 3x8	1	473 7002 018 (15)	473 7002 018 (15)	473 7002 018 (16)
85	Earth Screw	1	477 0276 018 (2)	477 0276 018 (2)	477 0276 018 (1)
PACKING & ACCESSORIES (Not included EXPLODED VIEW.)					
105-2	Inst. Manual	1	511 2550 003	511 2550 003	511 2589 003
105-6	FM Ant. Ass'y	1	—	511 2577 002	—
105-7	DAI Warranty Home	1	395 0019 025	395 0019 025	395 0021 000
105-7	DCI Warranty Home	1	515 0623 109	—	—
106	CSA Label	1	—	515 0627 105	—
			—	LL-6559 2	—

NOTE FOR PARTS LIST

- Part indicated with the mark "●" are not always in stock and possibly to take a long period of time for supplying, or in some case supplying of part may be refused.
- When ordering of part, clearly indicate "1" and "1" (l) to avoid mis-supplying.
- Ordering part without stating its part number can not be supplied.
- Part indicated with the mark "★" is not illustrated in the exploded view.

WARNING:
Parts marked with this symbol ⚠ have critical characteristics.
Use ONLY replacement parts recommended by the manufacturer.

REMOTE CONTROL (RC-169)

SCHMATIC DIAGRAM

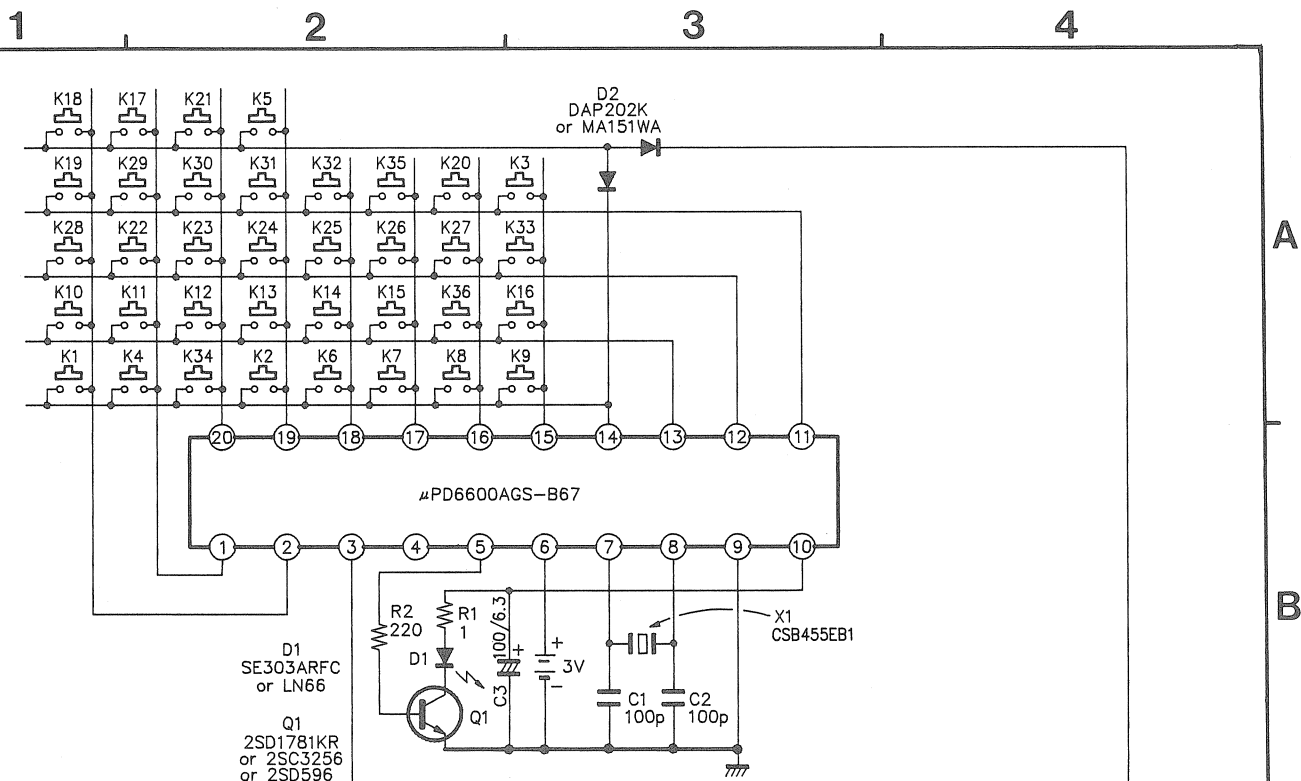

SPECIFICATIONS

- 1. When each Key is pressed double transmission is not performed. When one side is released from double pressed state, transmit code on unreleased side.

NOTES

ALL RESISTANCE VALUES IN OHM. k=1,000 OHM, M=1,000,000 OHM
 ALL CAPACITANCE VALUES IN MICRO FARAD. P=MICRO-MICRO FARAD
 EACH VOLTAGE AND CURRENT ARE MEASURED AT NO SIGNAL INPUT CONDITION.
 CIRCUIT AND PARTS ARE SUBJECT TO CHANGE WITHOUT PRIOR NOTICE.

REMOTE CONTROL UNIT ASS'Y

PARTS LIST OF EXPLODED VIEW

Ref. No.	Part No.	Part Name	Remarks	Q'ty	Ref. No.	Part No.	Part Name	Remarks	Q'ty
SEMICONDUCTORS GROUP					1	—	Case Top Ass'y		1
IC1	—	μPD6600AGSB67	μ-Com		2	—	Panel		1
Q1	—	Transistor 2SD1781KR Transistor 2SC3256 Transistor 2SD596			3	—	Switch Rubber		1
D1	—	LED SE303ARF-C LED LN66	Infrared Infrared		4	—	Case Bottom Ass'y		1
D2	276 0559 909 or 276 0438 907	Diode DAP202K Diode MA151WA			5	—	Cover Battery		1
RESISTORS GROUP					6	—	Tapping Screw		2
R1	241 2407 901	Carbon Resistor 1ohm, 1/4W	RD14B2E010J		7	—	Filter		1
R2	241 2397 901	Carbon Resistor 220ohm 1/4W	RD14B2E221J		8	—	Spring Coil		1
CAPACITORS GROUP					9	—	Spring Coil		1
C1,C2	257 0004 961	Chip Ceramic 100pF/50V	CC73SL1H101J		10	—	Poly Cover		1
C3	254 4213 034	Electrolytic 100μF/6.3V	CE04W0J101M		11	—	P.W.B. Unit Ass'y		1 ^S
OTHER GROUP									
X1	—	(P.W. Board) Ceramic Resonator	CSB455EB	(1) 1					

CORDS TABLE

KEY No.	System address					Custom code						Extension		Mask	Judgment	Remarks
	C1	C2	C3	C4	C5	C6	C7	C8	C9	C10	C11	C12	C13	C14	K	
K1	0	0	1	0	0	1	1	1	0	1	0	1	0	0	0	◀ PLAY (REV)
K2	0	0	0	1	0	0	0	1	1	1	0	1	0	0	0	PLAY ▶
K3	0	1	0	0	0	0	1	1	0	1	1	1	1	0	0	CENTER ▼
K4	0	0	1	1	0	0	0	1	1	1	0	1	0	0	0	PLAY ▶
K5	0	0	1	0	0	1	1	0	0	1	0	1	0	0	0	A/B
K6	0	0	1	0	0	0	1	1	1	1	0	1	0	0	0	■ STOP
K7	0	0	0	1	0	1	1	0	1	0	1	1	0	0	0	DISC SKIP
K8	0	0	0	1	0	0	1	1	1	1	0	1	0	0	0	■ STOP
K9	0	0	1	0	0	0	1	0	1	1	0	1	0	0	0	FF ▶▶
K10	0	0	0	1	0	1	0	0	1	1	0	1	0	0	0	◀◀
K11	0	0	0	1	0	0	0	0	1	1	0	1	0	0	0	▶▶
K12	0	1	0	0	0	1	0	1	0	0	0	1	1	0	0	TUNER
K13	0	1	0	0	0	1	0	1	1	0	0	1	1	0	0	VCR
K14	0	1	0	0	0	0	1	0	1	0	0	1	1	0	0	VDP/DBS
K15	0	1	0	0	0	0	1	0	0	1	0	1	1	0	0	DAT/TAPE MONITOR
K16	0	1	0	0	0	1	1	0	0	0	0	1	1	0	0	PHONO
K17	0	0	1	0	0	1	1	0	1	1	0	1	0	0	0	◀◀ REW
K18	0	0	1	1	0	0	1	1	0	1	0	1	1	0	0	PRESET ▲
K19	0	0	1	1	0	1	0	1	0	1	0	1	1	0	0	PRESET ▼
K20	0	1	0	0	0	0	1	0	0	1	1	1	1	0	0	MASTER VOL. ▼
K21	0	1	0	0	0	0	0	1	0	1	1	1	1	0	0	REAR ▼
K22	0	1	0	0	0	1	0	0	1	0	1	1	1	0	0	DELAY ▲
K23	0	1	0	0	0	0	1	0	1	0	1	1	1	0	0	T. TONE
K24	0	1	0	0	0	0	1	1	0	0	1	1	1	0	0	SURR. MODE
K25	0	1	0	0	0	0	0	0	1	0	1	1	1	0	0	DELAY ▼
K26	0	0	1	1	0	1	0	0	1	0	1	0	1	0	0	MEMORY
K27	0	0	1	1	0	0	1	0	1	0	1	0	1	0	0	1
K28	0	1	0	0	0	1	1	1	0	0	1	1	1	0	0	BYPASS
K29	0	1	0	0	0	0	0	0	0	1	1	1	1	0	0	MUTING
K30	0	1	0	0	0	1	0	1	0	1	1	1	1	0	0	CENTER ▲
K31	0	1	0	0	0	1	1	0	0	1	1	1	1	0	0	REAR ▲
K32	0	1	0	0	0	1	0	0	0	1	1	1	1	0	0	MASTER VOL. ▲
K33	0	0	1	1	0	1	1	0	1	0	1	0	1	0	0	2
K34	0	0	0	1	0	1	0	1	1	1	0	1	0	0	0	PAUSE
K35	0	1	0	0	0	1	0	0	0	0	0	1	1	0	0	POWER
K36	0	1	0	0	0	0	0	1	0	0	0	1	1	0	0	CD

NOTE FOR PARTS LIST

- Part indicated with the mark "◎" are not always in stock and possibly to take a long period of time for supplying, or in some case supplying of part may be refused.
- When ordering of part, clearly indicate "1" and "I" (i) to avoid mis-supplying.
- Ordering part without stating its part number can not be supplied.
- Part indicated with the mark "★" is not illustrated in the exploded view.
- Not including Carbon Film ±5%, 1/6W, 1/4W Type in the P.W.Board parts list. (Refer to the Schematic Diagram for those parts.)

WARNING:

Parts marked with this symbol  have critical characteristics.
Use ONLY replacement parts recommended by the manufacturer.

DENON

NIPPON COLUMBIA CO., LTD.

14-14, AKASAKA 4-CHOME, MINATO-KU, TOKYO 107-11, JAPAN

Telephone: 03 (3584) 8111

Cable: NIPPON COLUMBIA TOKYO Telex: JAPANOLA J22591