

## SERVICE MANUAL

MODEL	JP	E3	E2	EK	EA	E1	E1C	E1K
<b>AVR-X2100W</b>	✓	✓	✓			✓	✓	
<b>AVR-S900W</b>		✓						

### INTEGRATED NETWORK AV RECEIVER

• For purposes of improvement, specifications and design are subject to change without notice.

• Please use this service manual with referring to the operating instructions without fail.

• Some illustrations using in this service manual are slightly different from the actual set.

# DENON

D&M Holdings Inc.

# CONTENTS

<b>ABOUT THIS MANUAL</b> .....	3	<b>TROUBLE SHOOTING</b> .....	80
What you can do with this manual.....	3	1. POWER.....	80
Using Adobe Reader (Windows version).....	4	2. Analog video.....	81
<b>SAFETY PRECAUTIONS</b> .....	6	3. HDMI/DVI.....	85
<b>NOTE FOR SCHEMATIC DIAGRAM</b> .....	7	4. AUDIO.....	87
<b>NOTE FOR PARTS LIST</b> .....	7	5. Network/Bluetooth/USB.....	90
<b>TECHNICAL SPECIFICATIONS for AVR-X2100W</b> .....	9	6. SMPS.....	95
<b>DIMENSION for AVR-X2100W</b> .....	9	<b>CLOCK FLOW &amp; WAVE FORM IN DIGITAL BLOCK</b> .....	97
<b>TECHNICAL SPECIFICATIONS for AVR-S900W</b> .....	10	<b>LEVEL DIAGRAM</b> .....	98
<b>DIMENSION for AVR-S900W</b> .....	10	<b>BLOCK DIAGRAM</b> .....	104
<b>Precautions During Service</b> .....	11	<b>POWER DIAGRAM</b> .....	105
Initializing This Unit.....	11	<b>WIRING DIAGRAM</b> .....	106
Service Jigs.....	11	<b>PRINTED WIRING BOARDS</b> .....	107
<b>DISASSEMBLY</b> .....	12	<b>SCHEMATIC DIAGRAMS (1/30)</b> .....	113
1. FRONT PANEL ASSY.....	14	01-HDMI SW1.....	113
2. RADIATOR ASSY.....	15	02-HDMI SW2.....	114
3. HDMI PCB.....	16	03-NET_PHY.....	115
4. VIDEO PCB.....	17	04-BlueTooth.....	116
5. MAIN PCB.....	17	05-CPU_LEVEL_CHG.....	117
6. SMPS PCB.....	18	06-DIGITAL_CNT.....	118
7. TRANS POWER.....	18	07-CPU.....	119
<b>SPECIAL MODE</b> .....	19	08-Sub_CPU.....	120
Special Mode Configuration Buttons (for AVR-X2100W).....	19	09-FRONT_HDMI.....	121
Special Mode Configuration Buttons (for AVR-S900W).....	20	10-DSP.....	122
1. Version Display Mode.....	21	11-ADV8003.....	123
2. PANEL / REMOTE LOCK Selection Mode.....	25	12-ADV8003_DDR.....	124
3. Selection Modes for Service-related Operations.....	26	13-D.SUPPLY.....	125
DIAGNOSTIC PATH DIAGRAM.....	30	14-HDMI_TX.....	126
4. Remote ID Setup Mode.....	54	15-DIR_A.PLD.....	127
5. Protection Pass Mode.....	55	16-V.PLD.....	128
6. CX870 / CY920 Reboot mode.....	55	17-MAIN_DAC.....	129
7. CX870 / CY920 Initialization mode.....	56	18-ADV7850.....	130
<b>JIG FOR SERVICING</b> .....	57	19-CX870JUNCTION.....	131
<b>Procedure after Replacing the Microprocessor, etc.</b> .....	60	20-INPUT.....	132
<b>Firmware Update Procedure</b> .....	60	21-VIDEO_ZONE2.....	133
1. Updating by USB.....	60	22-VIDEO_FCNT.....	134
2. Updating by DPMS.....	69	23-VIDEO_RC5.....	135
<b>ADJUSTMENT</b> .....	76	24-AMP1.....	136
<b>SURROUND MODES AND PARAMETERS</b> .....	77	25-AMP2.....	137
		26-MAIN_SPK.....	138
		27-MAIN_TUNER_REG.....	139
		28-MAIN_RS232-CNT.....	140
		29-FRONT.....	141
		30-SMPS.....	142
		<b>EXPLODED VIEW</b> .....	143
		<b>PACKING VIEW</b> .....	145
		<b>SEMICONDUCTORS</b> .....	146
		1. IC's.....	146
		2. FL DISPLAY.....	165

# ABOUT THIS MANUAL

Read the following information before using the service manual.

## What you can do with this manual

### Search for a Ref. No. (phrase) (Ctrl+Shift+F)

You can use the search function in Acrobat Reader to search for a Ref. No. in schematic diagrams, printed wiring circuit diagrams, block diagrams, and parts lists.

1. Press **Ctrl+Shift+F** on the keyboard.
- The Search window appears.

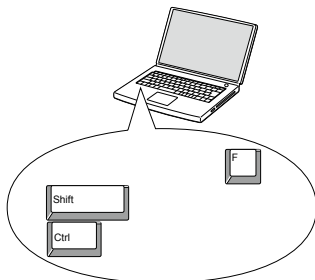

2. Enter the Ref. No. you want to search for in the Search window, and then click the **Search** button.
- A list of search results appears.

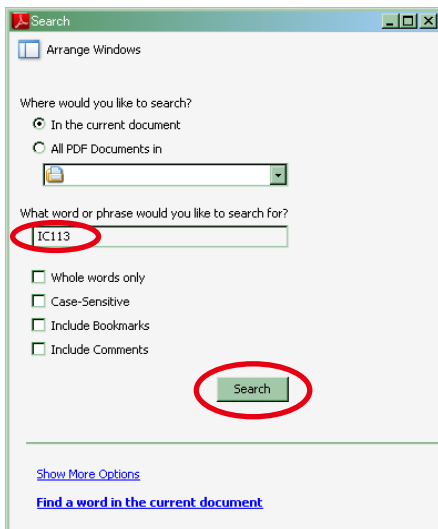

3. Click an item on the list.
- The screen jumps to the page for that item, and the search phrase is displayed.

### Jump to the target of a schematic diagram connector

- Click the Ref. No. of the target connector in the red box around a schematic diagram connector.
- The screen jumps to the target connector.

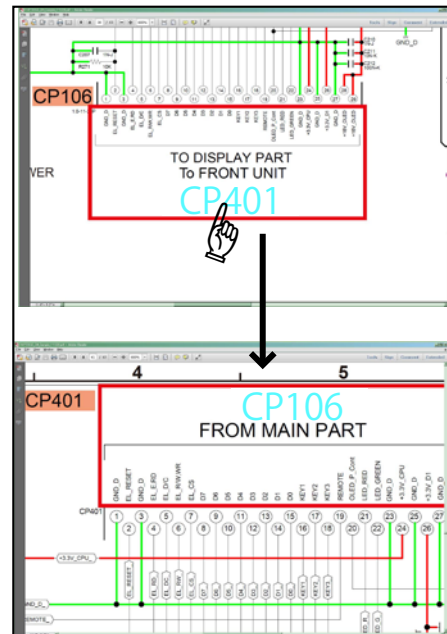

- Page magnification stays the same as before the jump.

## Using Adobe Reader (Windows version)

### Add notes to this data (Sign)

The Sign function lets you add notes to the data in this manual.

Save the file once you have finished adding notes.

#### [Example using Adobe Reader X]

On the "**View**" menu, click "**Sign**".

- The Sign pane appears.

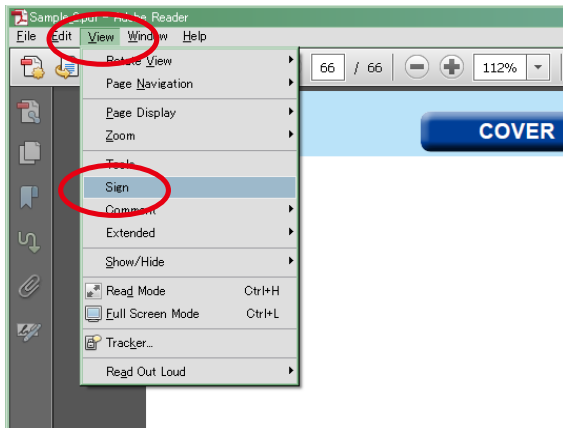

#### [Example using Adobe Reader 9]

On the "**Document**" menu, click "**Sign**".

### Magnify schematic / printed circuit board diagrams - 1

#### (Ctrl+Space, mouse operation)

Press **Ctrl+Space** on the keyboard and drag the mouse to select the area you want to view.

- The selected area is magnified.

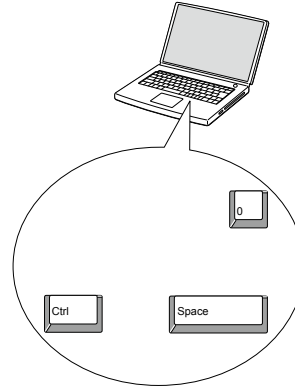

- When you want to move the area shown, hold down **Space** and drag the mouse.
- When you want to show a full page view, press **Ctrl+0** on the keyboard.

### Print a magnified part of the manual

The Properties dialog box and functions will vary depending on your printer.

1. Drag the mouse to magnify the part you want to print.
2. On the "**File**" menu, click "**Print**".
3. Configure the following settings in the Print dialog box.

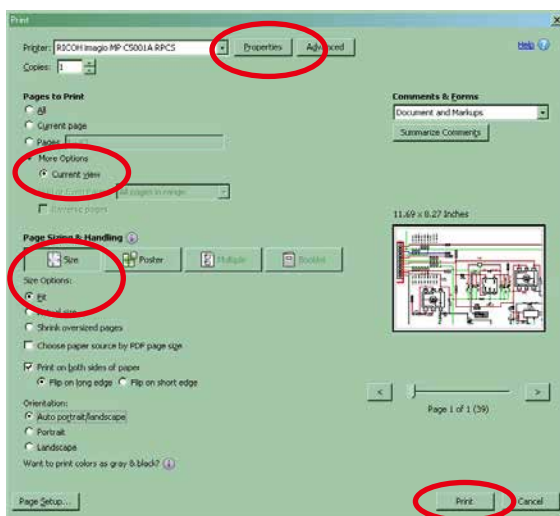

4. Click the **Print** button to start printing.

#### • **Properties**

Click this button and check that the printer is set to a suitable paper size.

#### • **Page to print**

Select the following checkbox.

**"More Options" : "Current View"**

#### • **Page Sizing & Handling**

Select the following checkbox.

**"Size" / "Size Options" : "Fit"**



## Magnify schematic / printed circuit board diagrams - 2

### (Pan & Zoom function)

The Pan & Zoom function lets you see which part of a magnified diagram is being shown in a separate window.

#### [Example using Adobe Reader X]

On the "View" menu, point to "Zoom", and then click "Pan & Zoom".

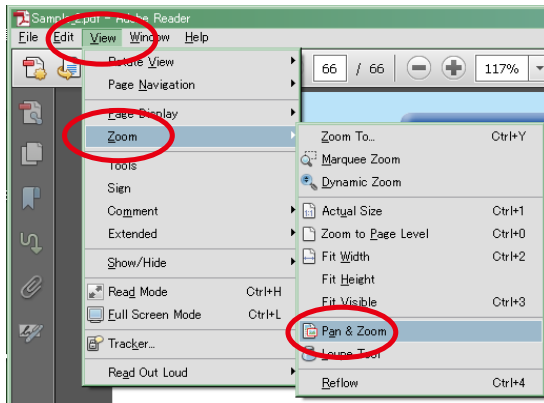

- The Pan & Zoom window appears on the screen.

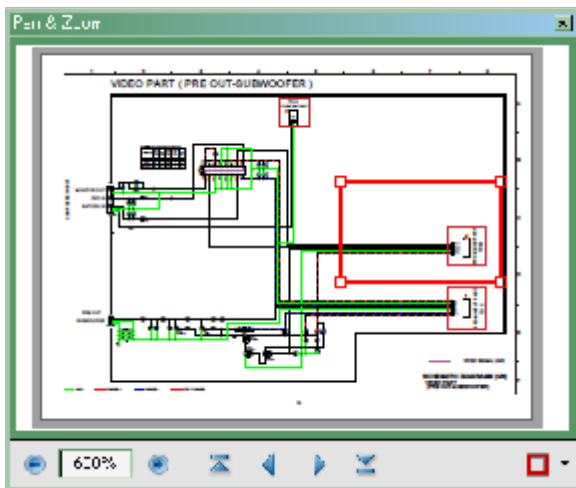

#### [Example using Adobe Reader 9]

On the "Tools" menu, point to "Select & Zoom", and then click "Pan & Zoom Window".

## Magnify schematic / printed circuit board diagrams - 3

### (Loupe Tool function)

The Loupe Tool function lets you magnify a specific part of a diagram in a separate window.

#### [Example using Adobe Reader X]

On the "View" menu, point to "Zoom", and then click "Loupe Tool".

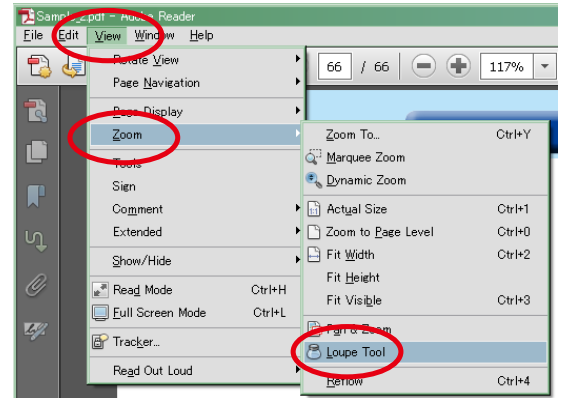

- The Loupe Tool window appears on the screen.

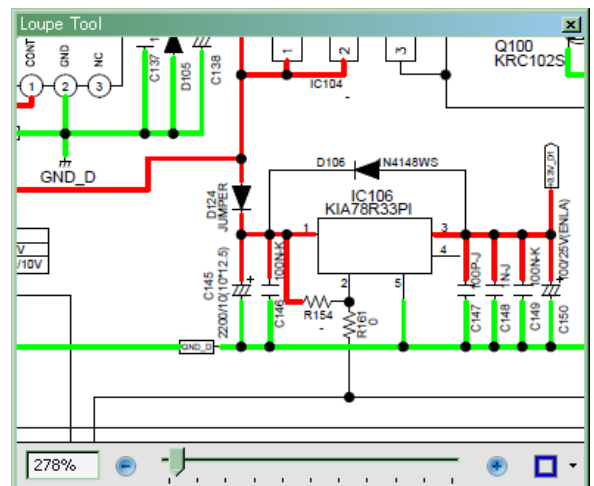

#### [Example using Adobe Reader 9]

On the "Tools" menu, point to "Select & Zoom", and then click "Loupe Tool Window".

## SAFETY PRECAUTIONS

The following items should be checked for continued protection of the customer and the service technician.

### leakage current check

Before returning the set to the customer, be sure to carry out either (1) a leakage current check or (2) a line to chassis resistance check. If the leakage current exceeds 0.5 milliamps, or if the resistance from chassis to either side of the power cord is less than 460 kohms, the set is defective.

Be sure to test for leakage current with the AC plug in both polarities, in addition, when the set's power is in each state (on, off and standby mode), if applicable.

### **CAUTION** Please heed the following cautions and instructions during servicing and inspection.

#### ⊙ Heed the cautions!

Cautions which are delicate in particular for servicing are labeled on the cabinets, the parts and the chassis, etc. Be sure to heed these cautions and the cautions described in the handling instructions.

#### ⊙ Cautions concerning electric shock!

- (1) An AC voltage is impressed on this set, so if you touch internal metal parts when the set is energized, you may get an electric shock. Avoid getting an electric shock, by using an isolating transformer and wearing gloves when servicing while the set is energized, or by unplugging the power cord when replacing parts, for example.
- (2) There are high voltage parts inside. Handle with extra care when the set is energized.

#### ⊙ Caution concerning disassembly and assembly!

Through great care is taken when parts were manufactured from sheet metal, there may be burrs on the edges of parts. The burrs could cause injury if fingers are moved across them in some rare cases. Wear gloves to protect your hands.

#### ⊙ Use only designated parts!

The set's parts have specific safety properties (fire resistance, voltage resistance, etc.). Be sure to use parts which have the same properties for replacement. The burrs have the same properties. In particular, for the important safety parts that are indicated by the ⚠ mark on schematic diagrams and parts lists, be sure to use the designated parts.

#### ⊙ Be sure to mount parts and arrange the wires as they were originally placed!

For safety reasons, some parts use tapes, tubes or other insulating materials, and some parts are mounted away from the surface of printed circuit boards. Care is also taken with the positions of the wires by arranging them and using clamps to keep them away from heating and high voltage parts, so be sure to set everything back as it was originally placed.

#### ⊙ Make a safety check after servicing!

Check that all screws, parts and wires removed or disconnected when servicing have been put back in their original positions, check that no serviced parts have deteriorate the area around. Then make an insulation check on the external metal connectors and between the blades of the power plug, and otherwise check that safety is ensured.

(Insulation check procedure)

Unplug the power cord from the power outlet, disconnect the antenna, plugs, etc., and on the power. Using a 500V insulation resistance tester, check that the insulation resistance value between the inplug and the externally exposed metal parts (antenna terminal, headphones terminal, input terminal, etc.) is 1MΩ or greater. If it is less, the set must be inspected and repaired.

### **CAUTION** Concerning important safety parts

Many of the electric and the structural parts used in the set have special safety properties. In most cases these properties are difficult to distinguish by sight, and the use of replacement parts with higher ratings (rated power and withstand voltage) does not necessarily guarantee that safety performance will be preserved. Parts with safety properties are indicated as shown below on the wiring diagrams and the parts list in this service manual. Be sure to replace them with the parts which have the designated part number.

- (1) Schematic diagrams.....Indicated by the ⚠ mark.
- (2) Parts lists.....Indicated by the ⚠ mark.

The use of parts other than the designated parts could cause electric shocks, fires or other dangerous situations.

## NOTE FOR SCHEMATIC DIAGRAM

### WARNING:

Parts indicated by the  $\triangle$  mark have critical characteristics. Use ONLY replacement parts recommended by the manufacturer.

### CAUTION:

Before returning the set to the customer, be sure to carry out either (1) a leakage current check or (2) a line to chassis resistance check. If the leakage current exceeds 0.5 milliamps, or if the resistance from chassis to either side of the power cord is less than 460 kohms, the set is defective.

### WARNING:

DO NOT return the set to the customer unless the problem is identified and remedied.

### NOTICE:

ALL RESISTANCE VALUES IN OHM. k=1,000 OHM / M=1,000,000 OHM

ALL CAPACITANCE VALUES ARE EXPRESSED IN MICRO FARAD, UNLESS OTHERWISE INDICATED. P INDICATES MICRO-MICRO FARAD. EACH VOLTAGE AND CURRENT ARE MEASURED AT NO SIGNAL INPUT CONDITION. CIRCUIT AND PARTS ARE SUBJECT TO CHANGE WITHOUT PRIOR NOTICE.

## NOTE FOR PARTS LIST

1. Parts indicated by "nsp" on this table cannot be supplied.
2. When ordering a part, make a clear distinction between "1" and "1" (i) to avoid mis-supplying.
3. A part ordered without specifying its part number can not be supplied.
4. Part indicated by "★" mark is not illustrated in the exploded view.

**WARNING:** Parts indicated by the  $\triangle$  mark have critical characteristics. Use ONLY replacement parts recommended by the manufacturer.

## INSTRUCTIONS FOR HANDLING SEMI-CONDUCTORS AND OPTICAL UNIT

Electrostatic breakdown of the semi-conductors or optical pickup may occur due to a potential difference caused by electrostatic charge during unpacking or repair work.

### 1. Ground for Human Body

Be sure to wear a grounding band (1 M $\Omega$ ) that is properly grounded to remove any static electricity that may be charged on the body.

### 2. Ground for Workbench

Be sure to place a conductive sheet or copper plate with proper grounding (1 M $\Omega$ ) on the workbench or other surface, where the semi-conductors are to be placed. Because the static electricity charge on clothing will not escape through the body grounding band, be careful to avoid contacting semi-conductors with your clothing

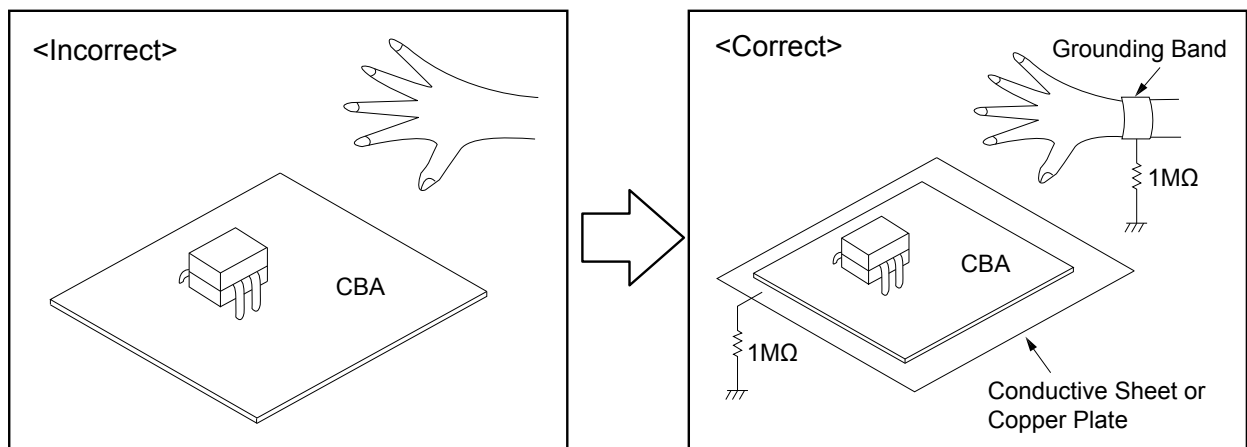



# TECHNICAL SPECIFICATIONS FOR AVR-X2100W

## Audio section

### Power amplifier

#### Rated output :

##### Front :

95W+95W(8Ω, 20Hz - 20kHz with 0.08% T.H.D.)  
125W+125W(6Ω, 1kHz with 0.7% T.H.D.)

##### Center :

95W(8Ω, 20Hz - 20kHz with 0.08% T.H.D.)  
125W(6Ω, 1 kHz with 0.7 % T.H.D.)

##### Surround :

95W+95W(8Ω, 20 Hz - 20 kHz with 0.08% T.H.D.)  
125W+125W(6Ω, 1 kHz with 0.7 % T.H.D.)

##### Surround back:

95W+95W(8Ω, 20 Hz - 20 kHz with 0.08% T.H.D.)  
125W+125W(6Ω, 1 kHz with 0.7 % T.H.D.)

Output connectors : 4 - 16Ω

## Analog section

**Input sensitivity/Input impedance :** 200 mV/47 kΩ

**Frequency response :** 10 Hz - 100 kHz — +1, -3 dB(Direct mode)

**S/N :** 100 dB(IHF-A weighted, Direct mode)

## Video section

**Input sensitivity/Input impedance :** Y signal — 1 Vp-p, 75 Ω  
PB / CB signal — 0.7 Vp-p, 75 Ω  
PR / CR signal — 0.7 Vp-p, 75 Ω

**Frequency response :** 5 Hz - 60 MHz — 0, -3 dB

## Tuner section

### FM

**Reception frequency range :** FM 87.5 MHz - 107.9 MHz(for E3)  
FM 87.5 MHz - 108.0 MHz(for E2,E1, E1C)  
FM 76.0 MHz - 90.0 MHz(for JP)  
AM 520 kHz - 1710 kHz(for E3)  
AM 522 kHz - 1611 kHz(for E2,E1, E1C)  
AM 522 kHz - 1629 kHz(for JP)

**Effective sensitivity :** FM 1.2μV(12.8dBf)  
AM 18 μV

**50 dB sensitivity :** MONO — 2.8 μV (20.2 dBf)

**S/N:** MONO — 70 dB (IHF-A weighted, Direct mode)  
STEREO — 67 dB (IHF-A weighted, Direct mode)

**Distortion :** MONO — 0.7 % (1 kHz)  
STEREO — 1.0 % (1 kHz)

## Wireless LAN section

### Network type

(wireless LAN standard): Conforming to Wi-Fi®\*1

**Security :** WEP 64 bit, WEP 128 bit  
WPA/WPA2-PSK (AES)  
WPA/WPA2-PSK (TKIP)

**Radio frequency :** 2.4 GHz

**No. of channels :** 1 - 11 ch (for E3)  
1 - 13 ch (for E2, E1, E1C, JP)

\*1 The Wi-Fi® CERTIFIED Logo and the Wi-Fi CERTIFIED On-Product Logo are registered trademarks of the Wi-Fi Alliance.

## Bluetooth section

**Communications system :** Bluetooth Version 2.1 + EDR  
(Enhanced Data Rate)

**Transmission power :** Maximum 2.5 mW (Class 2)

**Maximum communication range :** Approx. 32.8 ft/10 m 2 in line of sight

**Frequency band :** 2.4 GHz band

**Modulation scheme :** FHSS (Frequency-Hopping Spread Spectrum)

**Supported profiles :** A2DP 1.2 (Advanced Audio Distribution Profile)  
AVRCP 1.4 (Audio Video Remote Control Profile)

**Corresponding codec :** SBC, AAC

**Transmission range (A2DP) :** 20 Hz - 20,000 Hz

## General

**Power supply :** (for E3) : AC 120 V, 60 Hz  
(for E2/E1) : AC 230 V, 50 Hz / 60Hz  
(for E1C) : AC 220 V, 50 Hz  
(for JP) : AC 100V, 50/60Hz

**Power consumption :** 500W

**Power consumption in standby mode :** 0.1W

**Power consumption in CEC standby mode :** 0.5W

**Power consumption in network standby mode :** 2.7W

For purposes of improvement, specifications and design are subject to change without notice.

# DIMENSION FOR AVR-X2100W

Unit : Unit : in. (mm) Weight : 21 lb 6 oz (9.7 kg)

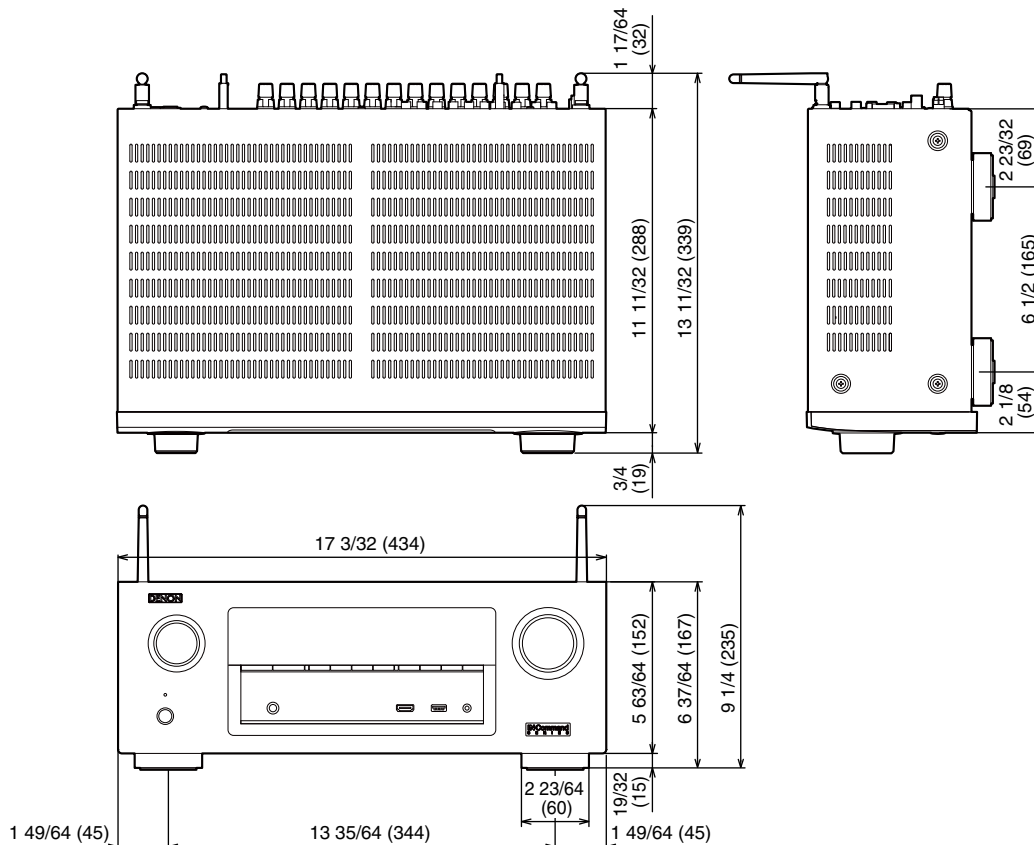

# TECHNICAL SPECIFICATIONS FOR AVR-S900W

## Audio section

### Power amplifier

#### Rated output :

**Front :**  
90W+90W(8Ω, 20Hz - 20kHz with 0.08% T.H.D.)  
125W+125W(6Ω, 1kHz with 0.7% T.H.D.)

#### Center :

90W(8Ω, 20Hz - 20kHz with 0.08% T.H.D.)  
125W(6Ω, 1 kHz with 0.7% T.H.D.)

#### Surround :

90W+90W(8Ω, 20 Hz - 20 kHz with 0.08% T.H.D.)  
125W+125W(6Ω, 1 kHz with 0.7% T.H.D.)

#### Surround back:

90W+90W(8Ω, 20 Hz - 20 kHz with 0.08% T.H.D.)  
125W+125W(6Ω, 1 kHz with 0.7% T.H.D.)

Output connectors : 4 - 16Ω

## Analog section

**Input sensitivity/Input impedance :** 200 mV/47 kΩ

**Frequency response :** 10 Hz - 100 kHz — +1, -3 dB(Direct mode)

**S/N :** 100 dB(IHF-A weighted, Direct mode)

## Video section

**Input sensitivity/Input impedance :** Y signal — 1 Vp-p, 75 Ω  
PB / CB signal — 0.7 Vp-p, 75 Ω  
PR / CR signal — 0.7 Vp-p, 75 Ω

**Frequency response :** 5 Hz - 60 MHz — 0, -3 dB

## Tuner section

### FM

**Reception frequency range :** FM 87.5 MHz - 107.9 MHz  
AM 520 kHz - 1710 kHz

**Effective sensitivity :** FM 1.2μV(12.8dBf)  
AM 18 μV

**50 dB sensitivity :** MONO — 2.8 μV (20.2 dBf)

**S/N:** MONO — 70 dB (IHF-A weighted, Direct mode)  
STEREO — 67 dB (IHF-A weighted, Direct mode)

**Distortion :** MONO — 0.7% (1 kHz)  
STEREO — 1.0% (1 kHz)

## Wireless LAN section

### Network type

(wireless LAN standard): Conforming to Wi-Fi®\*1

**Security :** WEP 64 bit, WEP 128 bit  
WPA/WPA2-PSK (AES)  
WPA/WPA2-PSK (TKIP)

**Radio frequency :** 2.4 GHz

**No. of channels :** 1 - 11 ch

\*1 The Wi-Fi® CERTIFIED Logo and the Wi-Fi CERTIFIED On-Product Logo are registered trademarks of the Wi-Fi Alliance.

## Bluetooth section

**Communications system :** Bluetooth Version 2.1 + EDR  
(Enhanced Data Rate)

**Transmission power :** Maximum 2.5 mW (Class 2)

**Maximum communication range :** Approx. 32.8 ft/10 m 2 in line of sight

**Frequency band :** 2.4 GHz band

**Modulation scheme :** FHSS (Frequency-Hopping Spread Spectrum)

**Supported profiles :** A2DP 1.2 (Advanced Audio Distribution Profile)  
AVRCP 1.4 (Audio Video Remote Control Profile)

**Corresponding codec :** SBC, AAC

**Transmission range (A2DP) :** 20 Hz - 20,000 Hz

## General

**Power supply :** (for E3) : AC 120 V, 60 Hz

**Power consumption :** 460W

**Power consumption in standby mode :** 0.1W

**Power consumption in CEC standby mode :** 0.5W

**Power consumption in network standby mode :** 2.7W

For purposes of improvement, specifications and design are subject to change without notice.

# DIMENSION FOR AVR-S900W

Unit : Unit : in. (mm) Weight : 21 lb 6 oz (9.7 kg)

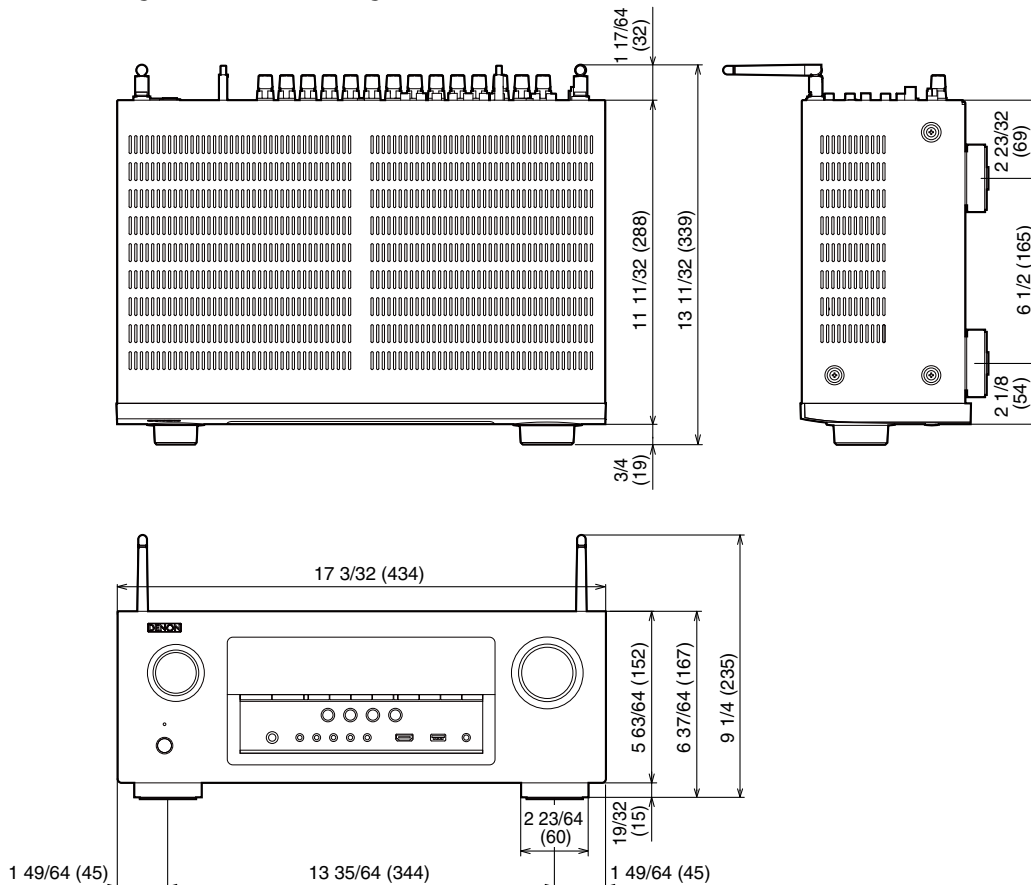

# PRECAUTIONS DURING SERVICE

## Initializing This Unit

Initialize this unit if you have replaced the microcomputer, one of the parts around the microcomputer, or the digital PCB.

1. Press the power button to turn off the power.
2. AVR-X2100W  
Hold down buttons "ZONE2 SOURCE" and "DIMMER" at the same time and press the power button to turn on the power.  
AVR-S900W  
Hold down buttons TUNER PRESET CH + and "TUNE -" at the same time and press the power button to turn on the power.
3. Release the buttons after confirming that the display flashes in intervals of approximately 1 second.  
\* The unit is initialized.

**NOTE :** • If the status in step 3 does not occur, start again from step 1.  
• Initializing the device restores settings configured by the user to the factory settings. Take note of your settings beforehand and reconfigure them after initialization.

AVR-X2100W

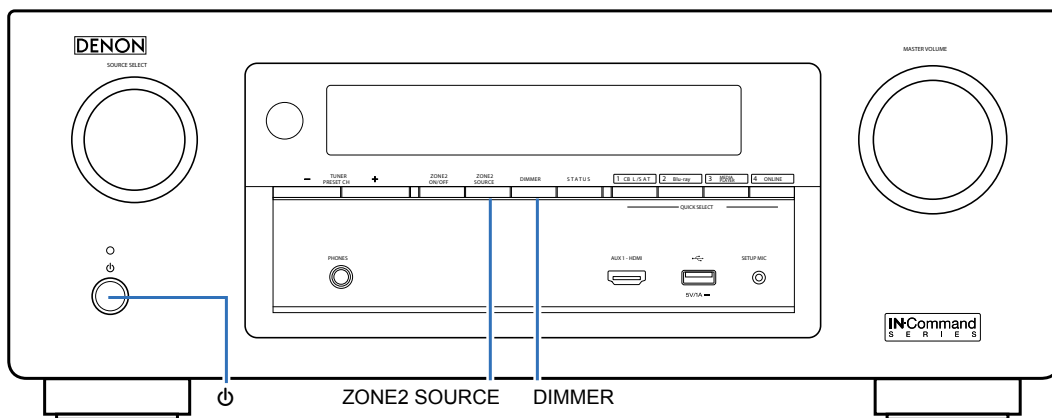

AVR-S900W 

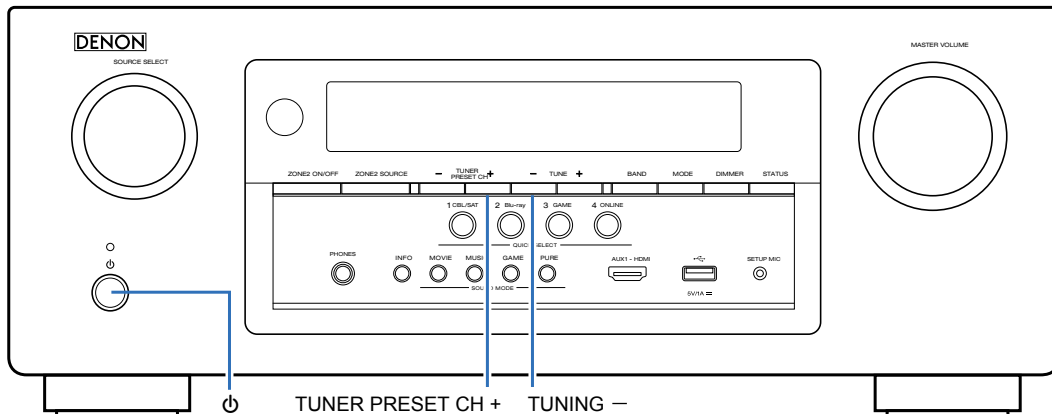

## Service Jigs

The following jigs (extension cable kit) are used when repairing the PCBs.  
Order the jigs from your dealer if necessary.

8U- 110084S : EXTENSION UNIT KIT : 1 Set  
(See [57 page](#))

# DISASSEMBLY

- Remove each part in the order of the arrows below.
- Reassemble removed parts in the reverse order.
- Read "**Precautions During Work**" before reassembling removed parts.
- If wire bundles are removed or moved during adjustment or part replacement, reshape the wires after completing the work. Failure to shape the wires correctly may cause problems such as noise.

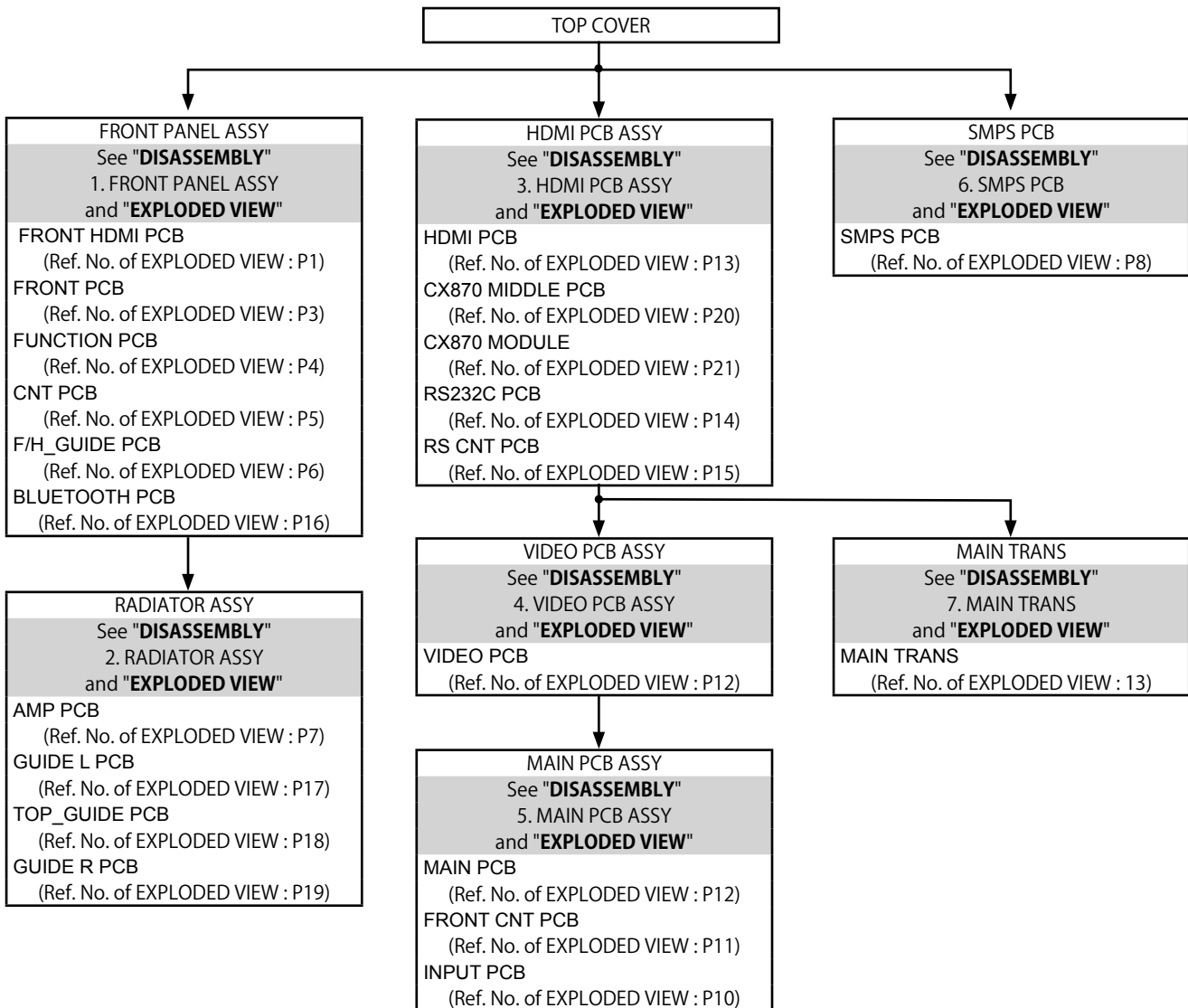



## Explanatory Photos for DISASSEMBLY

- The angles from which the photos are taken are shown by "Photo angle: A, B, C, D".
- See the diagram below about the shooting direction of each photograph.
- Photographs with no shooting direction indicated were taken from the top of the unit.
- The photograph is AVR-X2100WE3 model.

### The viewpoint of each photograph

(Shooting direction:X)[View from the top]

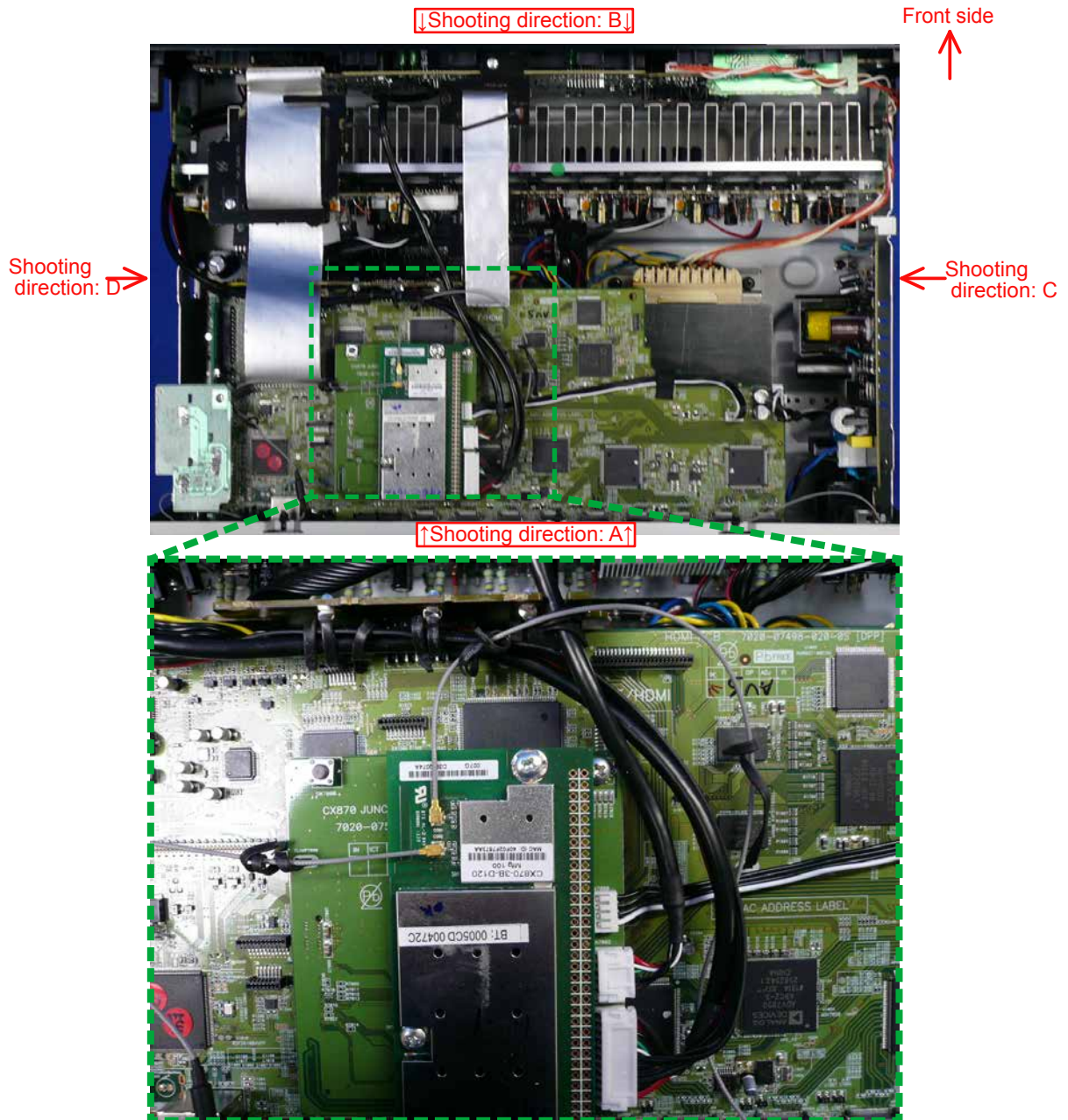

# 1. FRONT PANEL ASSY

Proceeding: **TOP COVER** → **FRONT PANEL ASSY**

(1) Remove the screws.

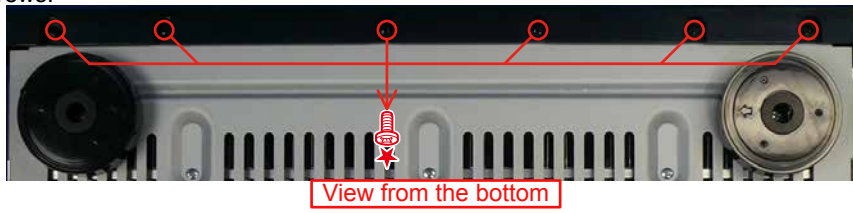

(2) Cut the wire clamp, then remove the connector wires and FFC. Remove the screws.

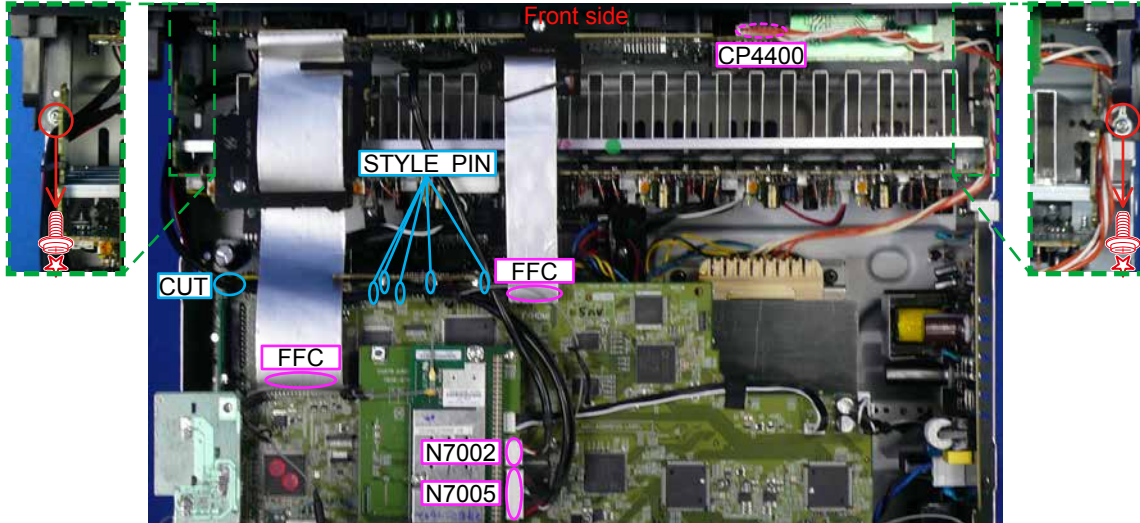

## 2. RADIATOR ASSY

Proceeding: **TOP COVER** → **FRONT PANEL ASSY** → **RADIATOR ASSY**

(1) Remove the screws.

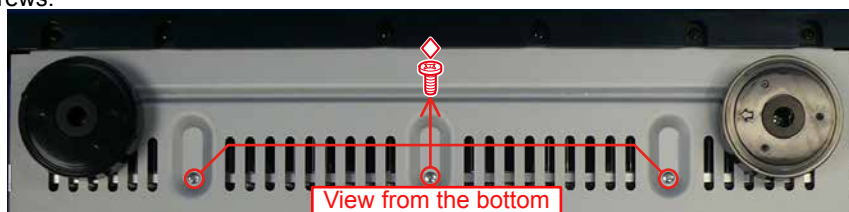

(2) Remove the STYLE PIN. Remove the screws.

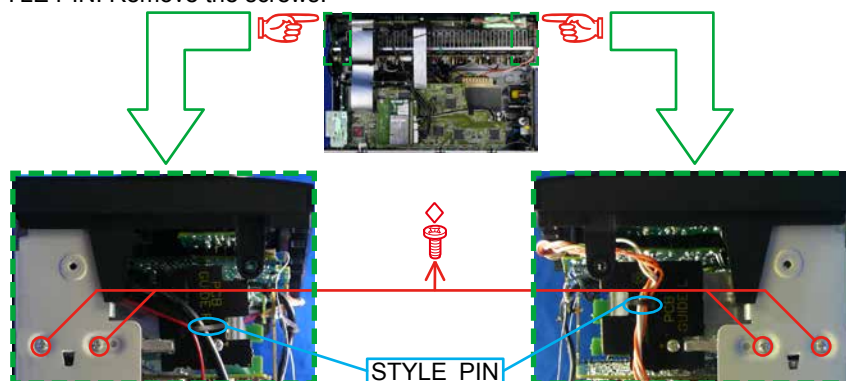

(3) Remove the connector wire.

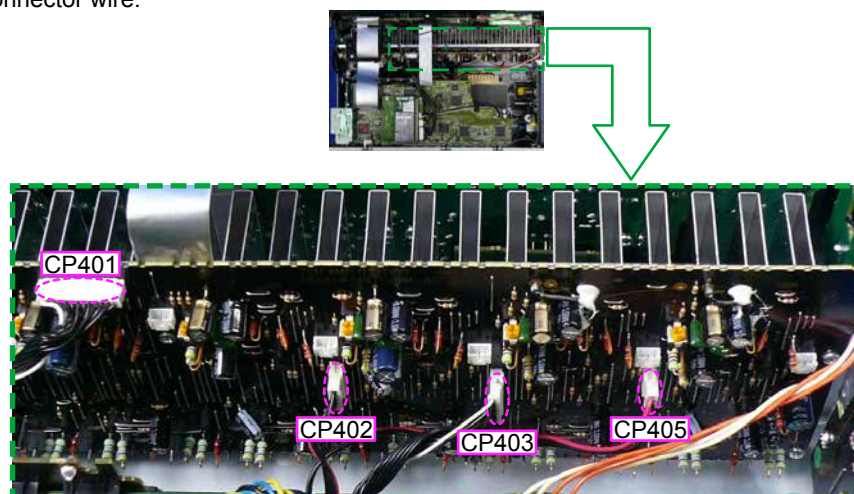



### 3. HDMI PCB

Proceeding: **TOP COVER** → **BACK CHASSIS** → **HDMI PCB**

(1) Remove the screws.



(2) Cut the wire clamp, then remove the connector wires and FFC.

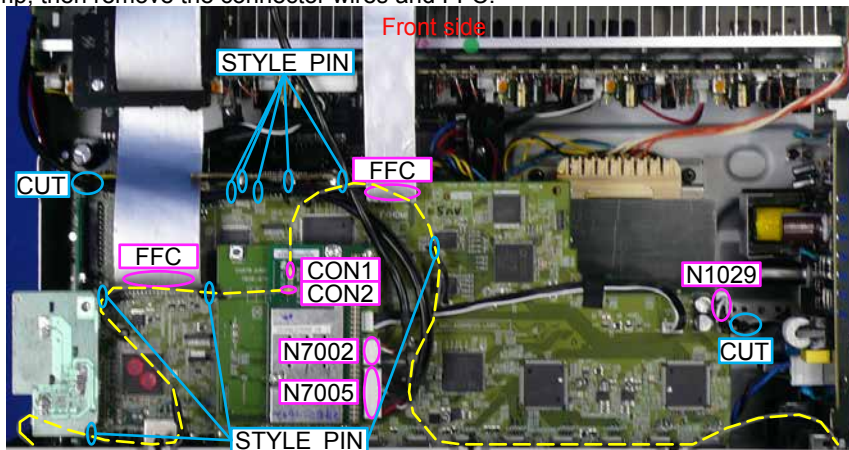

(3) Remove the connector wire.

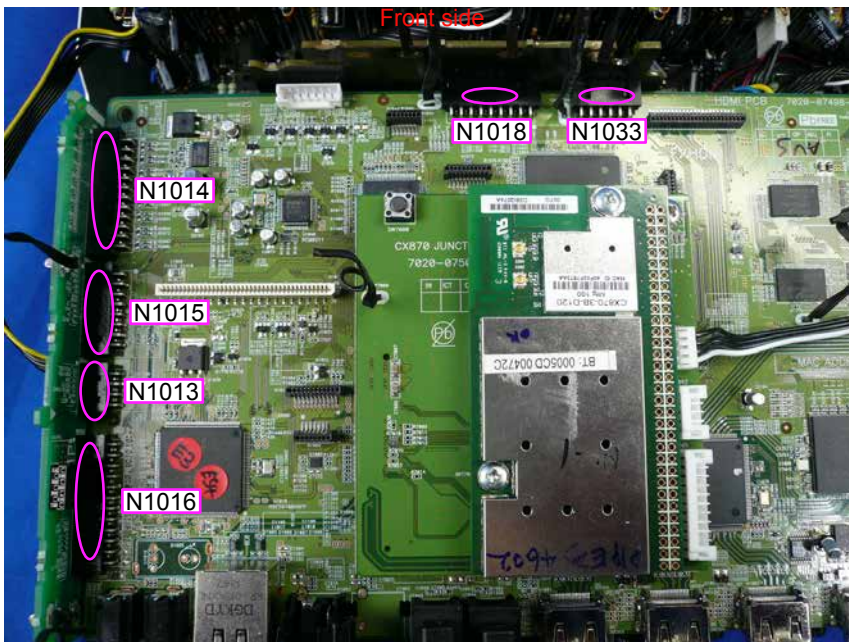

#### 4. VIDEO PCB

Proceeding: **TOP COVER** → **BACK CHASSIS** → **HDMI PCB** → **VIDEO PCB**

(1) Remove the connector wire.

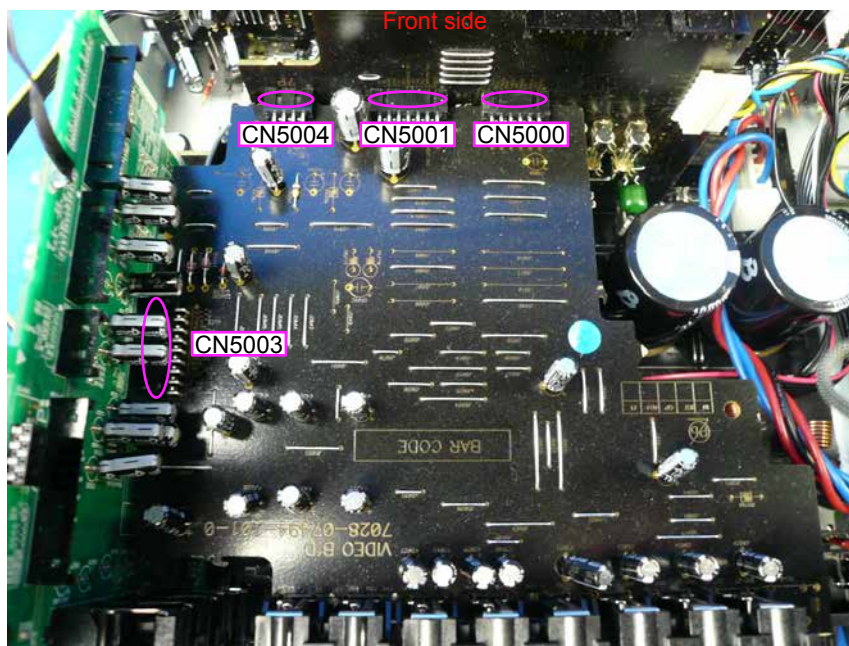

#### 5. MAIN PCB

Proceeding: **TOP COVER** → **BACK CHASSIS** → **HDMI PCB** → **VIDEO PCB** → **MAIN PCB**

(1) Remove the screws.

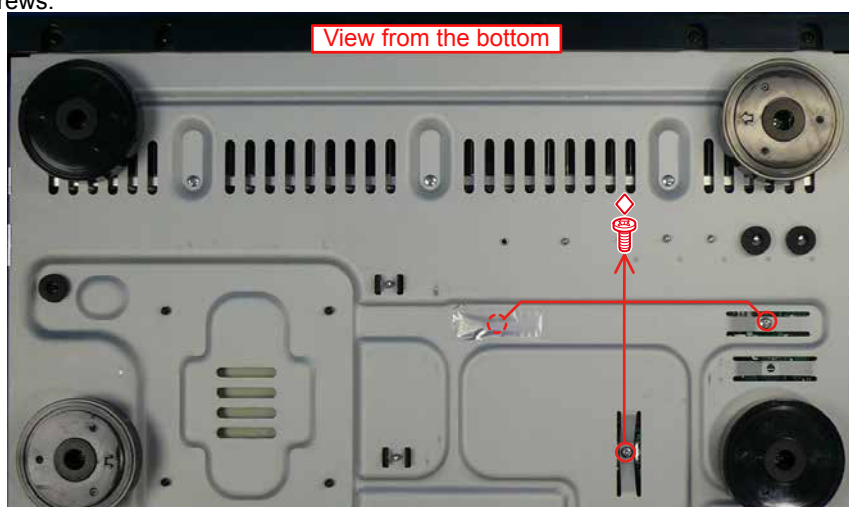



(2) Remove the connector wire.

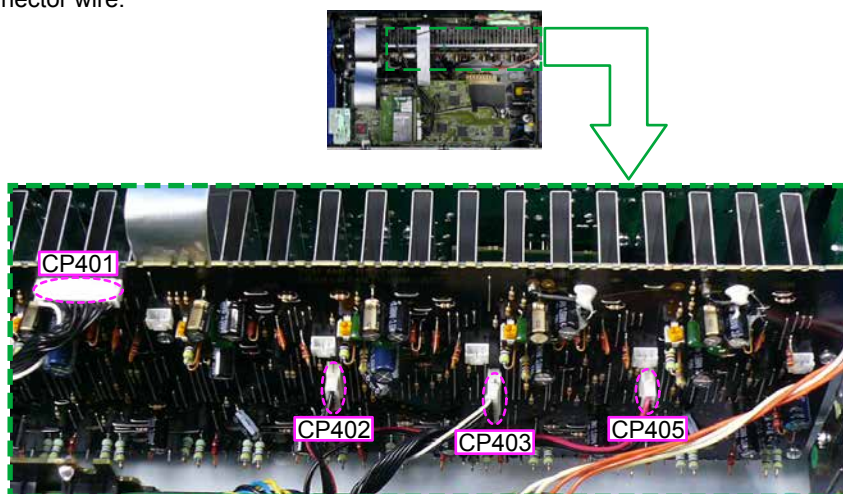

(3) Remove the connector wire. Remove the screws.

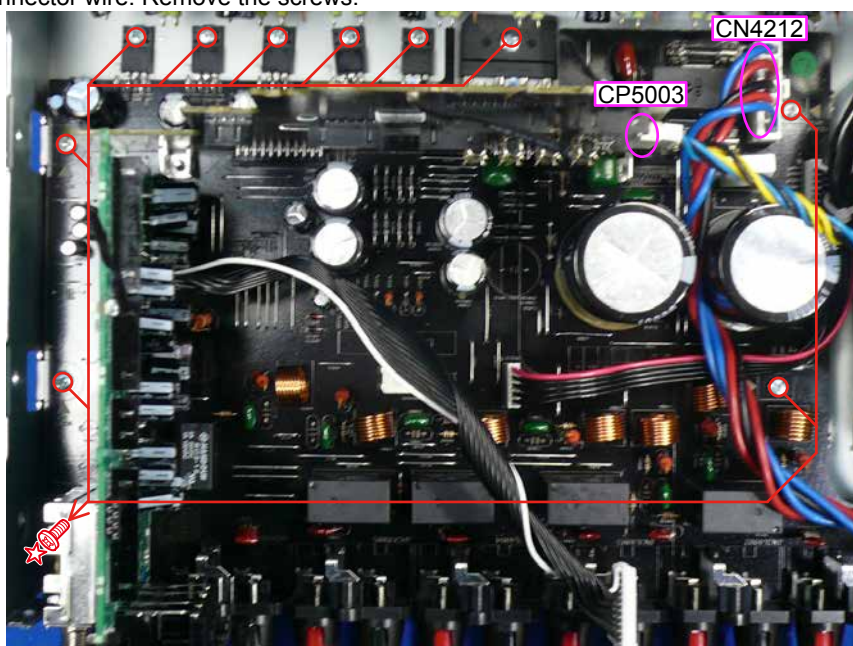

## 6. SMPS PCB

Proceeding : **TOP COVER** → **BACK CHASSIS** → **SMPS PCB**

(1) Remove the connector wire. Remove the screws.



## 7. TRANS POWER

Proceeding : **TOP COVER** → **BACK CHASSIS** → **HDMI PCB** → **TRANS POWER**

See "EXPLODED VIEW" for instructions on how to remove each PCB of the "TRANS POWER".

# SPECIAL MODE

## Special Mode Configuration Buttons (for AVR-X2100W)

- ※ No. 1 - 13 : Hold down buttons A, B and C at the same time and press the power button to turn on the power.
- ※ No. 14 : Press the A and B buttons simultaneously while inserting the AC plug to turn the power on.

No.	Mode	Button A	Button B	Button C	Contents
1	Version Display (u-COM / DSP Error Display)	DIMMER	STATUS	-	Displays the version of firmware such as the main firmware or DSP, etc. Errors that have occurred are displayed. (See 21 page)
2	Protection History Display Mode	ZONE2 SOURCE	DIMMER	STATUS	Displays the protection occurrence history. (See 50 page)
3	Check the Video/Audio pass Mode	↑	↑	↑	This is a special mode for service confirmation used during repair work to simplify the confirmation work for the Audio channel/video channel. (See 28 page)
4	Remote ID Setup Mode	↑	↑	↑	If there are multiple DENON AV receivers in the same area, this mode stops the other AV receivers from being operated concurrently with this device. (See 54 page)
5	TUNER step	↑	↑	↑	Enables reception STEP of the ANALOG TUNER to be changed. (See 53 page)
6	Operation INFO	↑	↑	↑	Displays the total operating time of the set, number of times the power was switched on, and number of occurrences of each protection. (See 52 page)
7	User Initialization mode (Settings for the Installer Setup are not initialized.)	TUNER PRESET CH -	TUNER PRESET CH +	-	Initializes backup data. (Settings for the Installer Setup are not initialized.)
8	Factory Initialization mode (Initialization includes settings for the Installer Setup.)	ZONE2 SOURCE	DIMMER	-	Initializes backup data. (Initialization includes settings for the Installer Setup.)
9	Mode for preventing remote control acceptance	TUNER PRESET CH +	ZONE2 SOURCE	-	Start this unit in the PANEL/REMOTE LOCK selection mode so that PANEL LOCK and Remote Lock can be selected as ON or OFF. (See 25 page)
10	PANEL LOCK mode (with Volume)	↑	↑	-	This function prevents reception of all keys/encoders (including VOLUME) other than the power supply button on the Front Panel.
11	PANEL LOCK mode (without Volume)	↑	↑	-	This function prevents reception of all keys/encoders other than the power supply button and VOLUME encoder on the Front Panel.
12	Panel Lock Release	↑	↑	-	Function for Releasing the PANEL LOCK
13	Protection pass mode	TUNER PRESET CH +	ZONE2 SOURCE	STATUS	Enables the power to be turned on when protection detection is in the stopped state. (See 55 page)
14	Forced USB All Device Write Mode	TUNER PRESET CH +	STATUS	-	Mode used when this unit cannot be recovered. Forcibly switches this unit to USB update mode. (See 62 page)

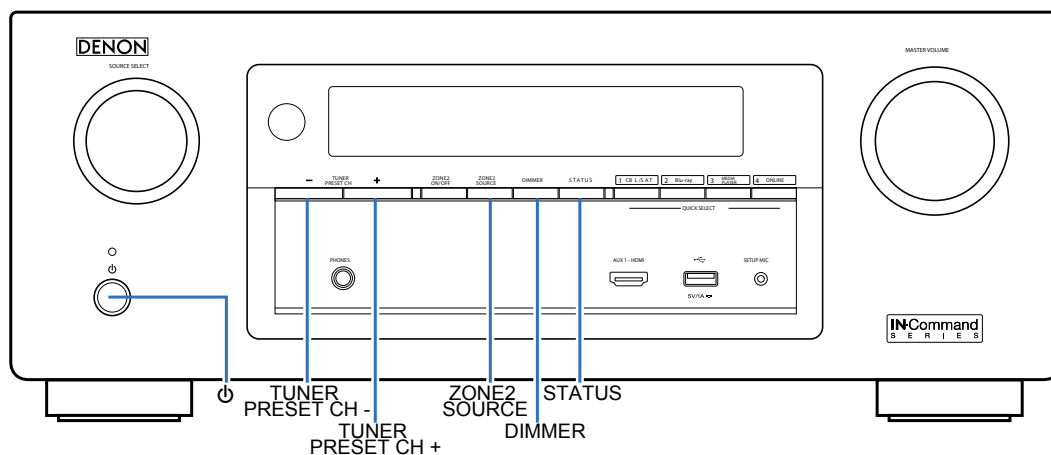

## Special Mode Configuration Buttons (for AVR-S900W)

- ※ No. 1 - 13 : Hold down buttons A, B and C at the same time and press the power button to turn on the power.
- ※ No. 14 : Press the A and B buttons simultaneously while inserting the AC plug to turn the power on.

No.	Mode	Button A	Button B	Button C	Contents
1	Version Display (u-COM / DSP Error Display)	DIMMER	STATUS	-	Displays the version of firmware such as the main firmware or DSP, etc. Errors that have occurred are displayed. (See <a href="#">21 page</a> )
2	Protection History Display Mode	TUNER PRESET CH +	TUNE -	TUNE +	Displays the protection occurrence history. (See <a href="#">50 page</a> )
3	Check the Video/Audio pass Mode	↑	↑	↑	This is a special mode for service confirmation used during repair work to simplify the confirmation work for the Audio channel/video channel. (See <a href="#">28 page</a> )
4	Remote ID Setup Mode	↑	↑	↑	If there are multiple DENON AV receivers in the same area, this mode stops the other AV receivers from being operated concurrently with this device. (See <a href="#">54 page</a> )
5	TUNER step	↑	↑	↑	Enables reception STEP of the ANALOG TUNER to be changed. (See <a href="#">53 page</a> )
6	Operation INFO	↑	↑	↑	Displays the total operating time of the set, number of times the power was switched on, and number of occurrences of each protection. (See <a href="#">52 page</a> )
7	User Initialization mode (Settings for the Installer Setup are not initialized.)	TUNER PRESET CH -	TUNER PRESET CH +	-	Initializes backup data. (Settings for the Installer Setup are not initialized.)
8	Factory Initialization mode (Initialization includes settings for the Installer Setup.)	TUNER PRESET CH +	TUNE -	-	Initializes backup data. (Initialization includes settings for the Installer Setup.)
9	Mode for preventing remote control acceptance	ZONE2 SOURCE	TUNER PRESET CH +	-	Start this unit in the PANEL/REMOTE LOCK selection mode so that PANEL LOCK and Remote Lock can be selected as ON or OFF. (See <a href="#">25 page</a> )
10	PANEL LOCK mode (with Volume)	↑	↑	-	This function prevents reception of all keys/encoders (including VOLUME) other than the power supply button on the Front Panel.
11	PANEL LOCK mode (without Volume)	↑	↑	-	This function prevents reception of all keys/encoders other than the power supply button and VOLUME encoder on the Front Panel.
12	Panel Lock Release	↑	↑	-	Function for Releasing the PANEL LOCK
13	Protection pass mode	ZONE2 SOURCE	TUNER PRESET CH +	TUNE +	Enables the power to be turned on when protection detection is in the stopped state. (See <a href="#">55 page</a> )
14	Forced USB All Device Write Mode	TUNE +	ZONE2 SOURCE	-	Mode used when this unit cannot be recovered. Forcibly switches this unit to USB update mode. (See <a href="#">62 page</a> )

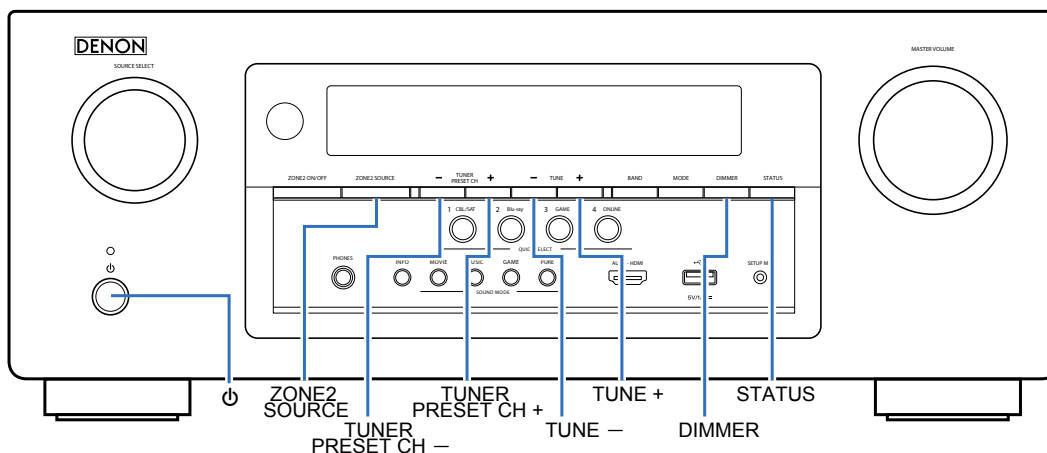



# 1. Version Display Mode

## 1.1. Actions

Version information is displayed when the device is started in this mode.

## 1.2. Starting up

Hold down buttons "DIMMER" and "STATUS" at the same time and press the power button to turn on the power. Press the "STATUS" button after this to show the information in section 1.3 on the display.

※ A version list is also displayed on GUIs while the version appears on the display.

## 1.3. Display Order

Error information(See "1.4. Error display") → ① Model destination information → ② Firmware Package Version → ③ Main  $\mu$ -com → ④ Main 1st Boot Loader → ⑤ DSP ROM → ⑥ Audio PLD → ⑦ Video PLD → ⑧ GUI SFLASH → ⑨ Ethernet 1st Boot Loader, Hardware ID → ⑩ Ethernet 2nd Boot Loader, Rhapsody Flag → ⑪ Ethernet IMAGE → ⑫ Ethernet MAC ADDRESS information → ⑬ BT MAC Address information

① Model destination information :

FLD	A	U	R	-	S	9	0	0	W		E	3			*
FLD	A	U	R	-	X	2	1	0	0	W		E	3		*
FLD	A	U	R	-	X	2	1	0	0	W		E	2		*
FLD	A	U	R	-	X	2	1	0	0	W		E	1		*
FLD	A	U	R	-	X	2	1	0	0	W		E	1	C	*
FLD	A	U	R	-	X	2	1	0	0	W		J	P		*

② Firmware Package Version :

FLD	P	a	c	k	a	g	e				:	*	*	*	*
-----	---	---	---	---	---	---	---	--	--	--	---	---	---	---	---

③ Main  $\mu$ -com Version :

FLD		M	a	i	n		:	*	*	*	*	#	#	#	#	*
-----	--	---	---	---	---	--	---	---	---	---	---	---	---	---	---	---

\* : Main version, # : Sub version

④ Main 1st Boot Loader :

FLD		M	a	i	n		F	B	L		:	*	*	.	*	*
-----	--	---	---	---	---	--	---	---	---	--	---	---	---	---	---	---

⑤ DSP ROM :

FLD		D	S	P							:	*	*	.	*	*
-----	--	---	---	---	--	--	--	--	--	--	---	---	---	---	---	---

⑥ Audio PLD :

FLD		A	u	d	i	o		P	L	D	:	*	*	.	*	*
-----	--	---	---	---	---	---	--	---	---	---	---	---	---	---	---	---

⑦ Video PLD

FLD		V	i	d	e	o		P	L	D	:	*	*	.	*	*
-----	--	---	---	---	---	---	--	---	---	---	---	---	---	---	---	---

⑧ GUI SFLASH :

FLD		G	U	I			:	Q	Q	\$	\	*	*	*	*
-----	--	---	---	---	--	--	---	---	---	----	---	---	---	---	---

Q : Model code, \$ : Brand code, \ : Region code, \* : version

⑨ Ethernet 1st Boot Loader, Hardware ID :

FLD	E	t	h	e	r	n	e	t	F	B	L			
-----	---	---	---	---	---	---	---	---	---	---	---	--	--	--

↓  
Press the "STATUS" button.

FLD	*	*	*	*	*	*	-	b	d					
-----	---	---	---	---	---	---	---	---	---	--	--	--	--	--

⑩ Ethernet 2nd Boot Loader, Rhapsody Flag :

FLD	E	t	h	e	r	n	e	t	S	B	L			
-----	---	---	---	---	---	---	---	---	---	---	---	--	--	--

↓  
Press the "STATUS" button.

FLD	B	*	*	*	*	*	*	*	*	*	*	*	*	-	0	A
-----	---	---	---	---	---	---	---	---	---	---	---	---	---	---	---	---

⑪ Ethernet IMAGE :

FLD	E	t	h	e	r	n	e	t	I	M	G			
-----	---	---	---	---	---	---	---	---	---	---	---	--	--	--

↓  
Press the "STATUS" button.

FLD	I	*	*	*	*	*	*	*	*	*	*	*	*	*		
-----	---	---	---	---	---	---	---	---	---	---	---	---	---	---	--	--

⑫ Ethernet MAC ADDRESS information :

FLD	*	N	E	T		M	A	C		A	d	d	r	e	s	s
-----	---	---	---	---	--	---	---	---	--	---	---	---	---	---	---	---

↓  
Press the "STATUS" button.

FLD	*	*	*	*	*	*	-	*	*	*	*	*	*		
-----	---	---	---	---	---	---	---	---	---	---	---	---	---	--	--

⑬ BT MAC ADDRESS information :

FLD	*	B	T		M	A	C		A	d	d	r	e	s	s
-----	---	---	---	--	---	---	---	--	---	---	---	---	---	---	---

↓  
Press the "STATUS" button.

FLD	*	*	*	*	*	*	-	*	*	*	*	*	*		
-----	---	---	---	---	---	---	---	---	---	---	---	---	---	--	--

## 1.4. Error display

See the table below for descriptions of displayed errors and countermeasures for these.

Display order is ①,②,③,④.

Condition	States	Display	TROUBLE SHOOTING																																																							
① Firm Check NG	The model name, brand name and region information written in the firmware are compared to the region settings in the PCB. This error is displayed if the information does not match.  "▲" or "▼" is displayed as the first character if the firmware is not correct (see right section of table).	<table border="1"> <tr><td>F</td><td>I</td><td>R</td><td>M</td><td>E</td><td>R</td><td>R</td><td>O</td><td>R</td><td></td><td></td></tr> <tr><td> </td><td>M</td><td>a</td><td>i</td><td>n</td><td> </td><td> </td><td> </td><td> </td><td> </td><td> </td></tr> <tr><td> </td><td>D</td><td>S</td><td>P</td><td> </td><td> </td><td> </td><td> </td><td> </td><td> </td><td> </td></tr> <tr><td> </td><td>A</td><td>u</td><td>d</td><td>i</td><td>o</td><td> </td><td>P</td><td>L</td><td>D</td><td> </td></tr> <tr><td> </td><td>G</td><td>U</td><td>I</td><td> </td><td> </td><td> </td><td> </td><td> </td><td> </td><td> </td></tr> </table>	F	I	R	M	E	R	R	O	R				M	a	i	n								D	S	P									A	u	d	i	o		P	L	D			G	U	I								<ul style="list-style-type: none"> <li>•Check the resistor for setting region(R1428 / R1431, HDMIPCB).</li> <li>•Write the firmware for the correct region.</li> </ul>
F	I	R	M	E	R	R	O	R																																																		
	M	a	i	n																																																						
	D	S	P																																																							
	A	u	d	i	o		P	L	D																																																	
	G	U	I																																																							
② SUB $\mu$ -COM NG	There is not a reply from SUB $\mu$ -COM.	<table border="1"> <tr><td>S</td><td>U</td><td>B</td><td>E</td><td>R</td><td>R</td><td>O</td><td>R</td><td>0</td><td>1</td><td></td></tr> </table>	S	U	B	E	R	R	O	R	0	1		<ul style="list-style-type: none"> <li>•Check the SUB(U1020) and surrounding circuits.</li> </ul>																																												
S	U	B	E	R	R	O	R	0	1																																																	
③ IP SCALER NG	An error occurs in Loopback Test of the DDR memory to perform at initial setting of i/p Scaler(ADV8003).	<table border="1"> <tr><td>I</td><td>P</td><td>S</td><td>C</td><td>A</td><td>L</td><td>E</td><td>R</td><td>E</td><td>R</td><td>R</td><td>0</td><td>1</td></tr> </table>	I	P	S	C	A	L	E	R	E	R	R	0	1	<ul style="list-style-type: none"> <li>•Check the circuits around the IP SCALER (U1026, HDMI PCB) and DDR2 (U1028/1029).</li> <li>If there appear to be no problems, U1026 or U1028/1029 is faulty.</li> </ul>																																										
	I	P	S	C	A	L	E	R	E	R	R	0	1																																													
In initial setting of i/p Scaler ( ADV8003 ) , there is not the reply of the Loopback Test result of the DDR memory .	<table border="1"> <tr><td>I</td><td>P</td><td>S</td><td>C</td><td>A</td><td>L</td><td>E</td><td>R</td><td>E</td><td>R</td><td>R</td><td>0</td><td>2</td></tr> </table>	I	P	S	C	A	L	E	R	E	R	R	0	2																																												
I	P	S	C	A	L	E	R	E	R	R	0	2																																														
④ GUI Serial Flash NG	When it is different from Version of the Main CPU which Version of GUI Serial Flash supports . (ADV8003)	<table border="1"> <tr><td>G</td><td>U</td><td>I</td><td>V</td><td>E</td><td>R</td><td>.</td><td>E</td><td>R</td><td>R</td><td>O</td><td>R</td></tr> </table>	G	U	I	V	E	R	.	E	R	R	O	R	<ul style="list-style-type: none"> <li>•Check the firmware version.</li> </ul>																																											
G	U	I	V	E	R	.	E	R	R	O	R																																															
⑤ DIR NG	This error is displayed if there is no response from the DIR.	<table border="1"> <tr><td>D</td><td>I</td><td>R</td><td>E</td><td>R</td><td>R</td><td>O</td><td>R</td><td>0</td><td>1</td><td></td></tr> </table>	D	I	R	E	R	R	O	R	0	1		<ul style="list-style-type: none"> <li>•Check the DIR (U1040, HDMI PCB) and surrounding circuits.</li> </ul>																																												
D	I	R	E	R	R	O	R	0	1																																																	
⑥ DSP NG	The DSP FLAG0 port does not enter "Hi" status even after executing a DSP reset during a DSP code boot.	<table border="1"> <tr><td>D</td><td>S</td><td>P</td><td>E</td><td>R</td><td>R</td><td>O</td><td>R</td><td>0</td><td>1</td><td></td></tr> </table>	D	S	P	E	R	R	O	R	0	1		<ul style="list-style-type: none"> <li>•Check the DSP (U1024, HDMI PCB) and surrounding circuits.</li> </ul>																																												
	D	S	P	E	R	R	O	R	0	1																																																
	The DSP FLAG0 port does not enter "Hi" status before issuing a DSP command.	<table border="1"> <tr><td>D</td><td>S</td><td>P</td><td>E</td><td>R</td><td>R</td><td>O</td><td>R</td><td>0</td><td>2</td><td></td></tr> </table>	D	S	P	E	R	R	O	R	0	2																																														
	D	S	P	E	R	R	O	R	0	2																																																
	ACK="Hi" does not occur during DSP data reading, even when WRITE="Lo".	<table border="1"> <tr><td>D</td><td>S</td><td>P</td><td>E</td><td>R</td><td>R</td><td>O</td><td>R</td><td>0</td><td>3</td><td></td></tr> </table>	D	S	P	E	R	R	O	R	0	3																																														
	D	S	P	E	R	R	O	R	0	3																																																
ACK="Lo" does not occur during DSP data reading, even when REQ="Lo".	<table border="1"> <tr><td>D</td><td>S</td><td>P</td><td>E</td><td>R</td><td>R</td><td>O</td><td>R</td><td>0</td><td>4</td><td></td></tr> </table>	D	S	P	E	R	R	O	R	0	4																																															
D	S	P	E	R	R	O	R	0	4																																																	
ACK="Hi" does not occur during DSP data writing, even when WRITE="Hi".	<table border="1"> <tr><td>D</td><td>S</td><td>P</td><td>E</td><td>R</td><td>R</td><td>O</td><td>R</td><td>0</td><td>5</td><td></td></tr> </table>	D	S	P	E	R	R	O	R	0	5																																															
D	S	P	E	R	R	O	R	0	5																																																	
ACK="Lo" does not occur during DSP data writing, even when REQ="Lo".	<table border="1"> <tr><td>D</td><td>S</td><td>P</td><td>E</td><td>R</td><td>R</td><td>O</td><td>R</td><td>0</td><td>6</td><td></td></tr> </table>	D	S	P	E	R	R	O	R	0	6																																															
D	S	P	E	R	R	O	R	0	6																																																	
⑦ EEPROM NG	An error occurred in a checksum of the EEPROM(** is a block address number).	<table border="1"> <tr><td>E</td><td>2</td><td>P</td><td>R</td><td>O</td><td>M</td><td>E</td><td>R</td><td>R</td><td>*</td><td>*</td><td>*</td></tr> </table>	E	2	P	R	O	M	E	R	R	*	*	*																																												
E	2	P	R	O	M	E	R	R	*	*	*																																															

## 1.5. Version Display in the Setup Menu

Follow the steps below to display the firmware information.

- (1) Press the "SETUP" button on the remote control.
- (2) Select "General - Information - Firmware".

The version information is displayed as a 12-digit number as shown in the screenshot below.



GUI Image

This 12-digit number comprises part of the version number of each device and module. These version numbers correspond to the 12-digit number as shown below.

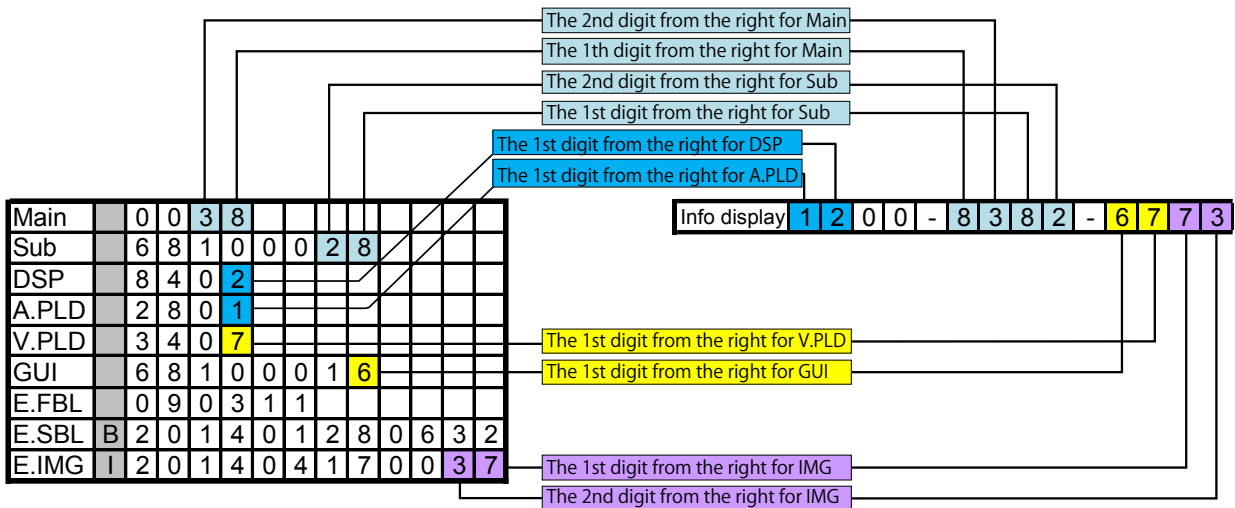

※ The firmware version numbers and this 12-digit version information are written in the Service Information.

## 2. PANEL / REMOTE LOCK Selection Mode

### 2.1. Actions

Turn the PANEL LOCK and REMOTE LOCK modes on and off.

### 2.2. Starting up

Hold down buttons "TUNER PRESET CH+" and "ZONE2 SOURCE" at the same time and press the power button to turn on the power.

Select the mode using the button "TUNER PRESET CH+", and press the button "STATUS" to commit the selection.

### 2.3. Displaying and Selecting Each Mode

The information shown on the display changes each time the button "TUNER PRESET CH+" is pressed.

Press the button "STATUS" to set the currently displayed mode and restart the device.

The On/Off setting for each mode is shown by an asterisk "※".

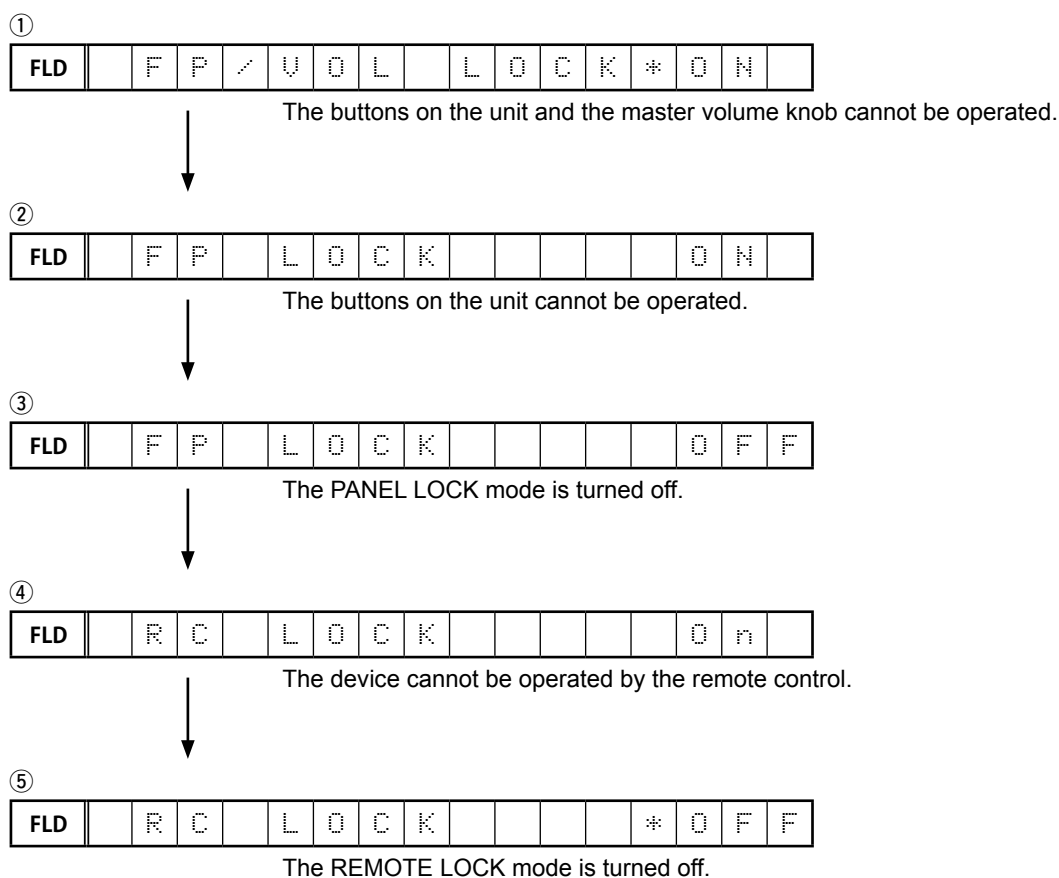

### 3. Selection Modes for Service-related Operations

#### 3.1. Actions

Select diagnostic mode (service path check mode), protection history display mode, or 232C standby clear mode.

#### 3.2. Starting up

AVR-X2100W

Hold down buttons "ZONE2 SOURCE", "DIMMER" and "STATUS" at the same time and press the power button to turn on the power.

AVR-S900W

Hold down buttons "TUNER PRESET CH+", "TUNE -" and "TUNE +" at the same time and press the power button to turn on the power.

Select the mode using the button "TUNER PRESET CH+", and press the button "STATUS" to commit the selection.

#### 3.3. Displaying and Selecting Each Mode

The information shown on the display changes each time the button "TUNER PRESET CH+" is pressed.

Press the button "STATUS" to set the currently displayed mode and restart the device.

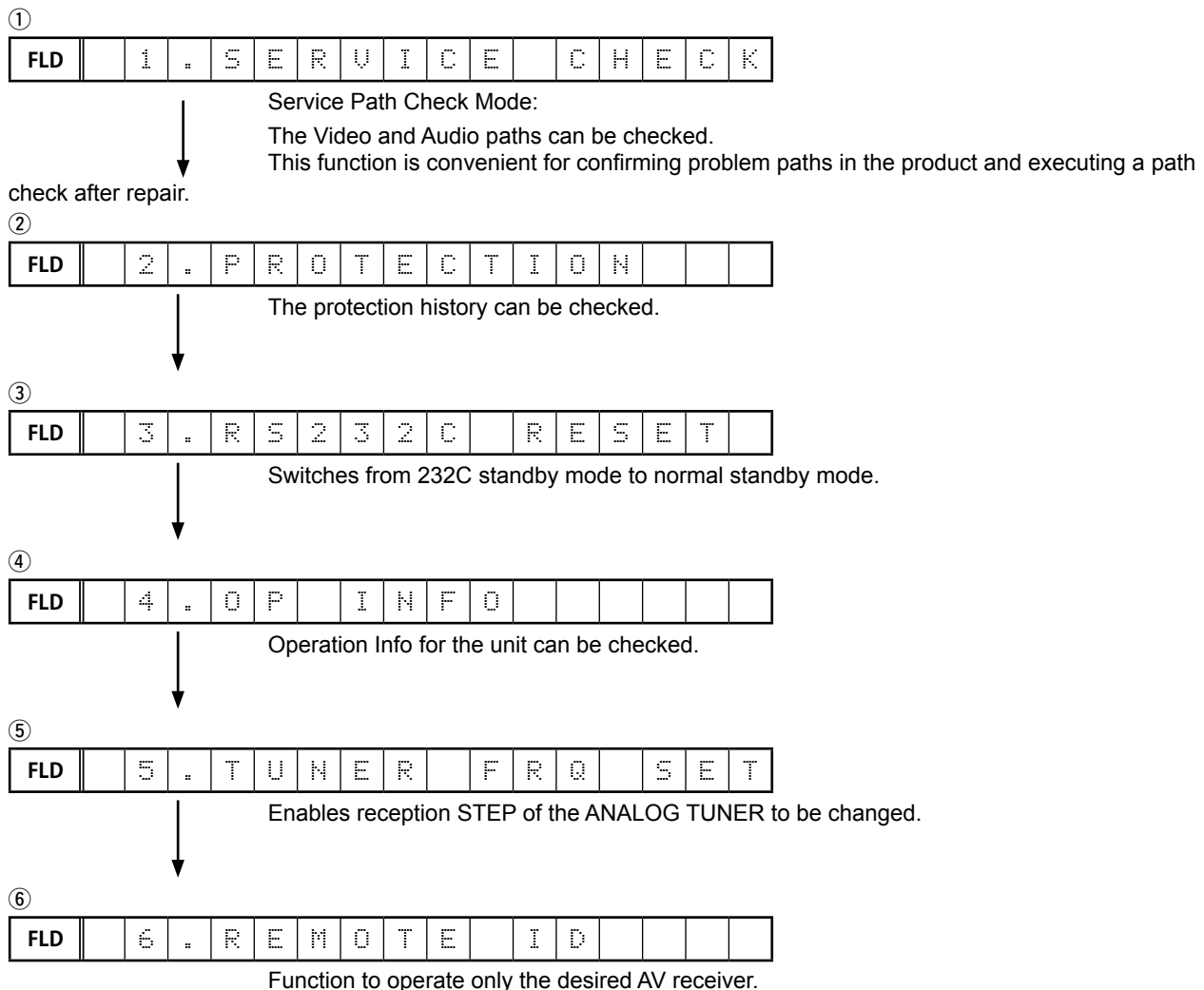

#### 3.3. Canceling the mode

Press the power button to turn off the power.



### 3.4. DIAGNOSTIC MODE (Service Path Check Mode)

#### 3.4.1. Actions

This function is convenient for confirming problem paths in the product and executing a path check after repair.

The Video and Audio paths can be checked.

The backup data is not rewritten.

#### 3.4.2. Starting up

AVR-X2100W

Hold down buttons "ZONE2 SOURCE", "DIMMER" and "STATUS" at the same time and press the power button to turn on the power.

AVR-S900W

Hold down buttons "TUNER PRESET CH +", "TUNE -" and "TUNE +" at the same time and press the power button to turn on the power.

Select the mode using the button "TUNER PRESET CH+", and press the button "STATUS" to commit the selection.

Select "1. SERVICE CHECK" and press the "STATUS" button to start the diagnostic mode.

The "TUNED", "STEREO" and "RDS" segments are lit in this mode.

#### 3.4.3. Canceling diagnostic mode

Press the power button to turn off the power.

#### 3.4.4. Selecting items

Press ① button to switch between video items and audio items.

Press button ② or ③ to select the previous or next item.

Actions	The unit			Remote control unit		
	① Audio ⇄ Video	② PREVIOUS	③ NEXT	① Audio ⇄ Video	② PREVIOUS	③ NEXT
Button	DIMMER	QUICK SELECT 1	QUICK SELECT 2	SLEEP	CURSOR LEFT	CURSOR RIGHT

#### 3.4.5. Video system confirmation items

fig. XX: See the block diagram of the fig.XXth.

Paths confirmation item	Display	Settings	Contents of confirmation Remarks
1 Video Convert (Analog or HDMI ⇒ HDMI)  <b>fig.01</b>	U02:V.CONVERT	Input Source : CBL/SAT Video Convert(IP Scaler) : ON, All sources IP Scaler : "Analog & HDMI", All sources Resolution : "Auto", All sources MAIN ZONE ON ZONE2 OFF	<ul style="list-style-type: none"> <li>• Check of CVBS input ⇒ IP Scaler ⇒ HDMI output.</li> <li>• Check of Component input ⇒ IP Scaler ⇒ HDMI output.</li> <li>• Check of HDMI input ⇒ IP Scaler ⇒ HDMI output.</li> <li>• Check of ETHERNET input ⇒ IP Scaler ⇒ HDMI output. (※ The input source can be switched to any source except CBL/SAT.)</li> </ul>
2 HDMI pass (MAIN ZONE)  <b>fig.02</b>	U03:HDMI PASS	Input Source : CBL/SAT Source of Video Convert(IP Scaler) : OFF, All sources MAIN ZONE ON ZONE2 OFF	<ul style="list-style-type: none"> <li>• Check of HDMI input (MAIN Function) ⇒ HDMI output (MAIN) (※ The input source can be switched to any source except CBL/SAT.)</li> </ul>
3 HDMI CEC  <b>fig.03</b>	U04:HDMI CEC	Input Source : CBL/SAT HDMI Control : ON MAIN ZONE ON ZONE2 OFF	<ul style="list-style-type: none"> <li>• When the power supply of a TV is put in the standby mode, make sure that the power supply of this unit is also put in the standby mode.</li> <li>• The ARC path can also be checked (check this using the TV input source). (※ The input source can be switched to any source except CBL/SAT.)</li> </ul>
4 HDMI Audio (Audio: AVR)  <b>fig.04a</b> <b>fig.04b</b>	U05:H.AUDIO-AVR	Input Source : CBL/SAT HDMI Control : OFF HDMI Audio : AVR ( if checking the audio output from AVR )	<ul style="list-style-type: none"> <li>• Check of HDMI input(PCM , DolbyDigital , DTS) ⇒ Speaker output.</li> <li>• Check of HDMI input(HD audio) ⇒ Speaker output. (※ The input source can be switched to any source except CBL/SAT.)</li> </ul>
5 HDMI Audio (Audio: TV)  <b>fig.05</b>	U06:H.AUDIO-TV	HDMI Audio : TV ( if checking the audio output from TV )	<ul style="list-style-type: none"> <li>• Check of HDMI input(PCM , DolbyDigital , DTS) ⇒ HDMI output (audio output from connected TV) (※ The input source can be switched to any source except CBL/SAT.)</li> </ul>
6 GUI  <b>fig.06</b>	U07:GUI MENU ON	Input Source : CBL/SAT Video Convert(IP Scaler) : ON, All sources IP Scaler : "Analog & HDMI", All sources Resolution : "AUTO", All sources Setup Menu ON MAIN ZONE ON ZONE2 OFF	<ul style="list-style-type: none"> <li>• Check of GUI display ⇒ HDMI output. (※ The input source can be switched to any source except CBL/SAT.)</li> </ul>



### 3.4.6. Audio system confirmation items

fig. XX: See the block diagram of the fig.XXth.

Paths confirmation item		Display	Settings	Contents of confirmation Remarks
1	Analog ( pass ) <b>fig.07</b>	A01:ANALOG PASS	Input Source : CBL/SAT Input Mode : ANALOG fixed Sound mode : DIRECT Amp assign : Surround Back MAIN ZONE : ON ZONE2 : OFF	• Check the audio output. • Check of Analog input ⇒ Speaker output. Front L/R (※ The input source can be switched to any source except CBL/SAT.)
2	DIGITAL (MAIN) <b>fig.08a</b> <b>fig.08b</b>	A02: DIGITAL	Input Source : CBL/SAT Input Mode : DIGITAL fixed Sound mode : MULTI CH STEREO Amp assign : Surround Back Speaker Config all Speaker=Small / SW=Yes(2ch) MAIN ZONE ON ZONE2 OFF	• Check the audio output. • Check of Digital input ⇒ Speaker output. Front L/R, Center, Surround L/R, Surround Back L/R • Check of Digital(PCM) input ⇒ Preout output. Front L/R, Center, Surround L/R, Surround Back L/R, Subwoofer (※ The input source can be switched to any source except CBL/SAT.)
3	DIGITAL (ZONE2) <b>fig.09a</b> <b>fig.09b</b>	A03: DIGITAL-Z2	Input Source : NETWORK Input Mode : Auto Sound mode : STEREO Amp assign : ZONE2 MAIN ZONE : ON ZONE2 : ON	• Check the audio output. • Digital(PCM) input ⇒ Speaker output Surround Back (ZONE2) L/R • Digital(PCM) input ⇒ Preout output ZONE2 L/R
4	HDMI <b>fig.10a</b> <b>fig.10b</b>	A05: HDMI	Input Source : CBL/SAT Input Mode : HDMI fixed Sound mode : STEREO Amp assign : Surround Back MAIN ZONE : ON ZONE2 : OFF	• Check the audio output. • HDMI input ⇒ Speaker output. Front L/R (※ The input source can be switched to any source except CBL/SAT.)
5	Analog AD (MAIN) <b>fig.11a</b> <b>fig.11b</b>	A06: AD	Input Source : CBL/SAT Input Mode : Analog fixed Sound mode : MULTI CH STEREO Vol -20dB Amp assign : Surround Back Speaker Config all Speaker=Small / SW=Yes(2ch) MAIN ZONE : ON ZONE2 : OFF	• Check the audio output. • Check of Analog input ⇒ Speaker output. Front L/R, Center, Surround L/R, Surround Back L/R • Check of Analog input ⇒ Pre OUT. Front L/R, Center, Surround L/R, Surround Back L/R, Subwoofer (※ The input source can be switched to any source except CBL/SAT.) (※ Volume -20dB is the value when Relative settings are used. The value is 60 when Absolute settings are used)
6	Analog Amp Assign (Amp Assign: ZONE2) <b>fig.12</b>	A07: ASSIGN-Z2	Input Source : CBL/SAT Input Mode : Auto Sound mode : STEREO Z2 Source : Source Vol -20dB Amp assign : ZONE2 MAIN ZONE : ON ZONE2 : ON	• Check the audio output. • Check of Analog input ⇒ Speaker output. Surround Back(ZONE2) L/R • Check of Analog input ⇒ Pre OUT. ZONE2 L/R (※ The input source can be switched to any source except CBL/SAT.) (※ Volume -20dB is the value when Relative settings are used. The value is 60 when Absolute settings are used)
7	Analog Amp Assign (Amp Assign: Bi-Amp) AVR-X2100W Only <b>fig.13</b>	A11: ASSIGN-BIAMP	Input Source : CBL/SAT Input Mode : Auto Sound mode : MULTI CH STEREO Amp assign : Bi-Amp MAIN ZONE ON ZONE2 OFF	• Check the audio output. • Check of Analog input ⇒ Speaker output. Surround Back L/R (※ The input source can be switched to any source except CBL/SAT.) (※ Volume -20dB is the value when Relative settings are used. The value is 60 when Absolute settings are used)
8	Front Height <b>fig.14a</b> <b>fig.14b</b>	A14: FRONT HEIGHT	Input Source : CBL/SAT Input Mode : Auto Sound mode : MULTI CH STEREO Vol -20dB Amp assign : Front Height MAIN ZONE ON ZONE2 OFF	• Check the audio output. • Check of Analog input ⇒ Speaker output. Surround Back L/R (※ The input source can be switched to any source except CBL/SAT.) • Check of PREOUT output. (※ Volume -20dB is the value when Relative settings are used. The value is 60 when Absolute settings are used)

DIAGNOSTIC PATH DIAGRAM

fig.01

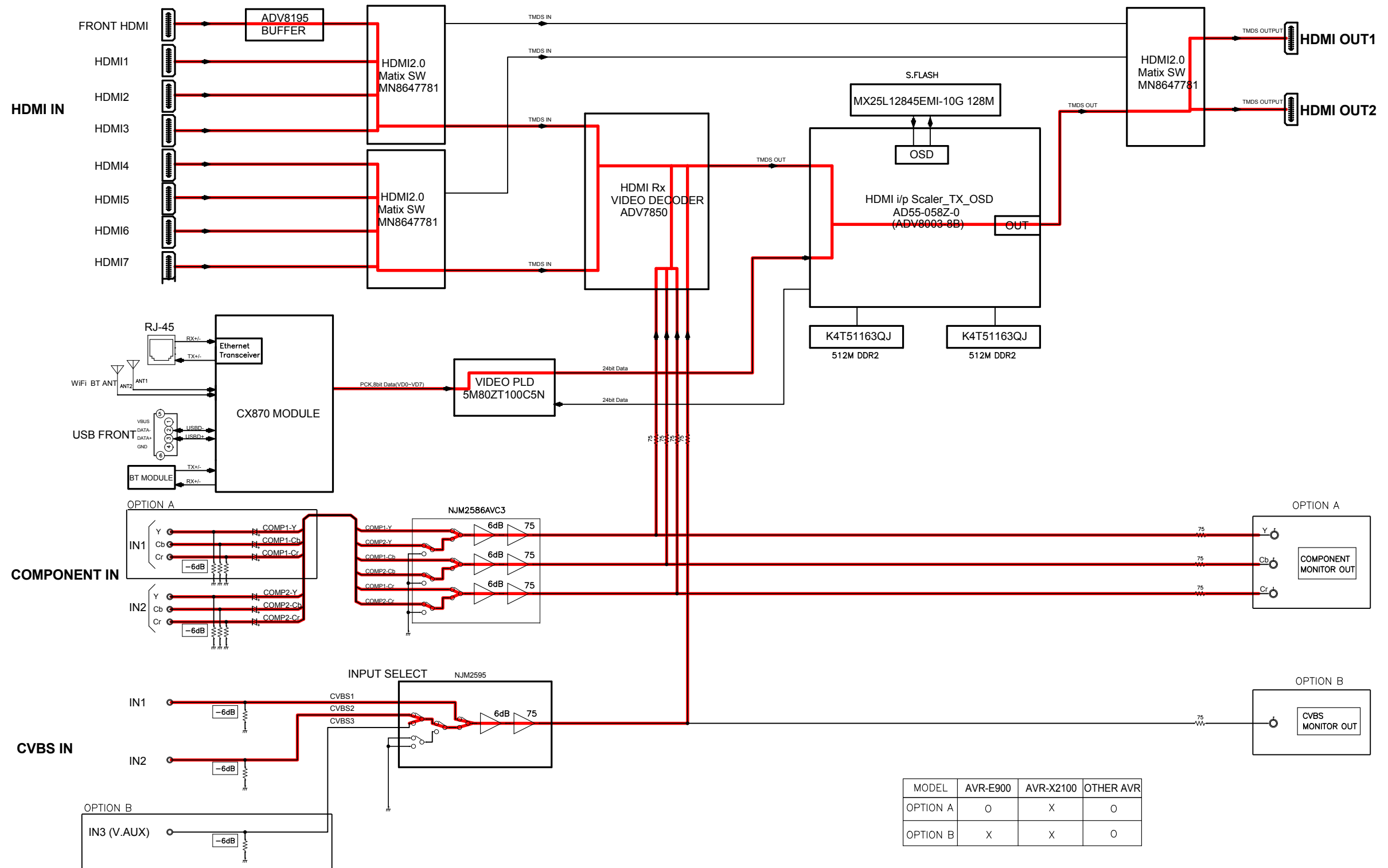

fig.02

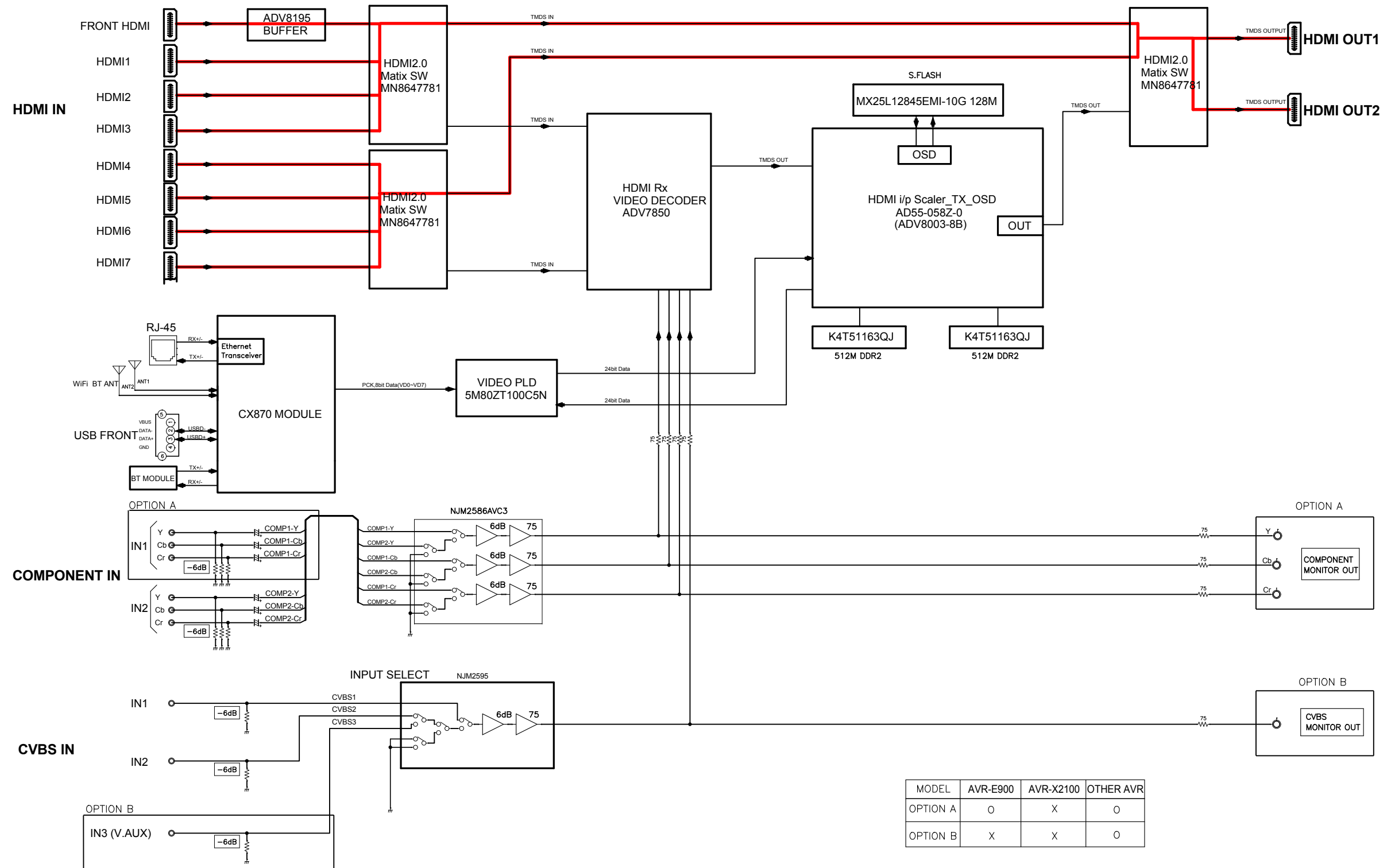
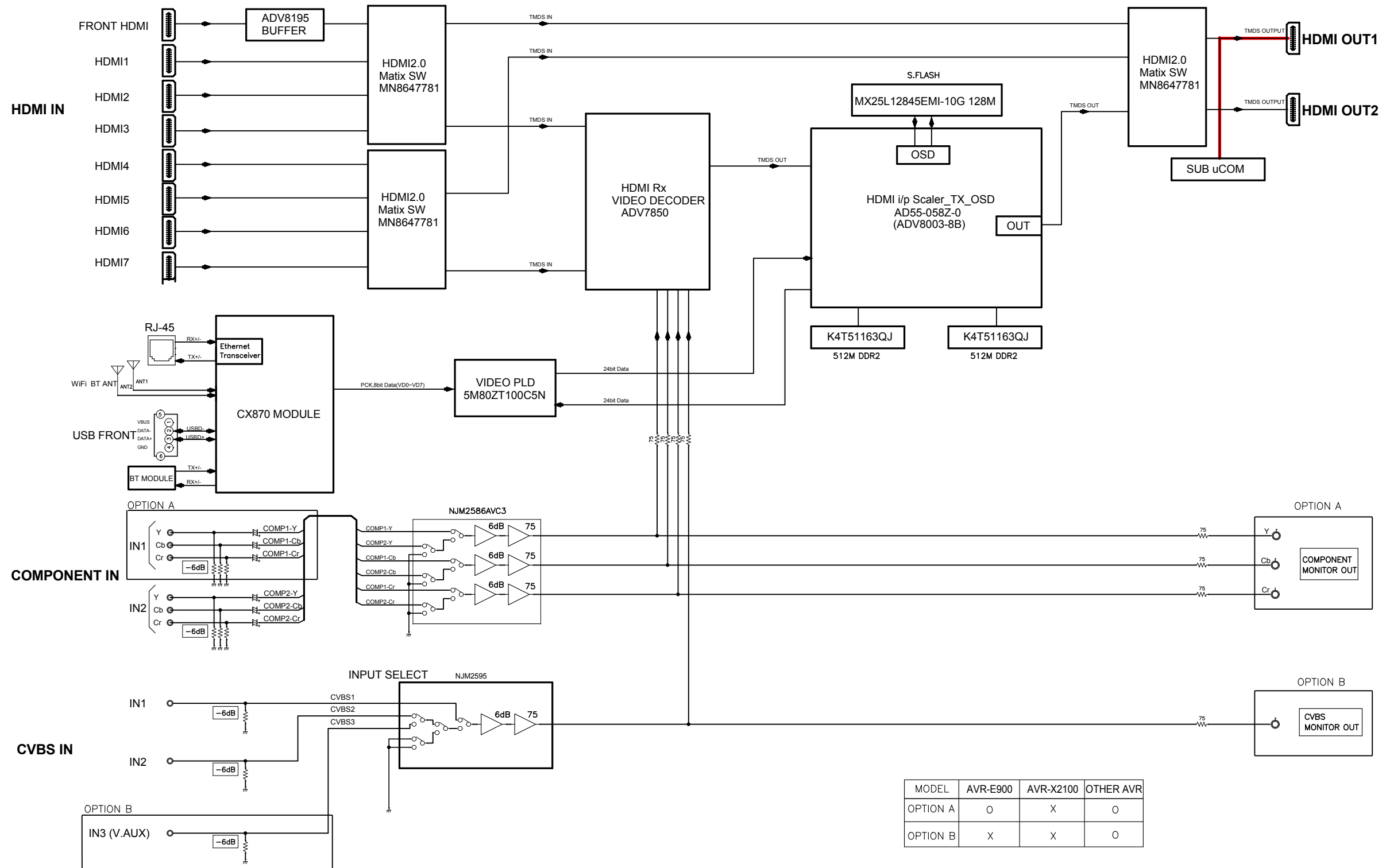

fig.03



MODEL	AVR-E900	AVR-X2100	OTHER AVR
OPTION A	0	X	0
OPTION B	X	X	0

fig.04a

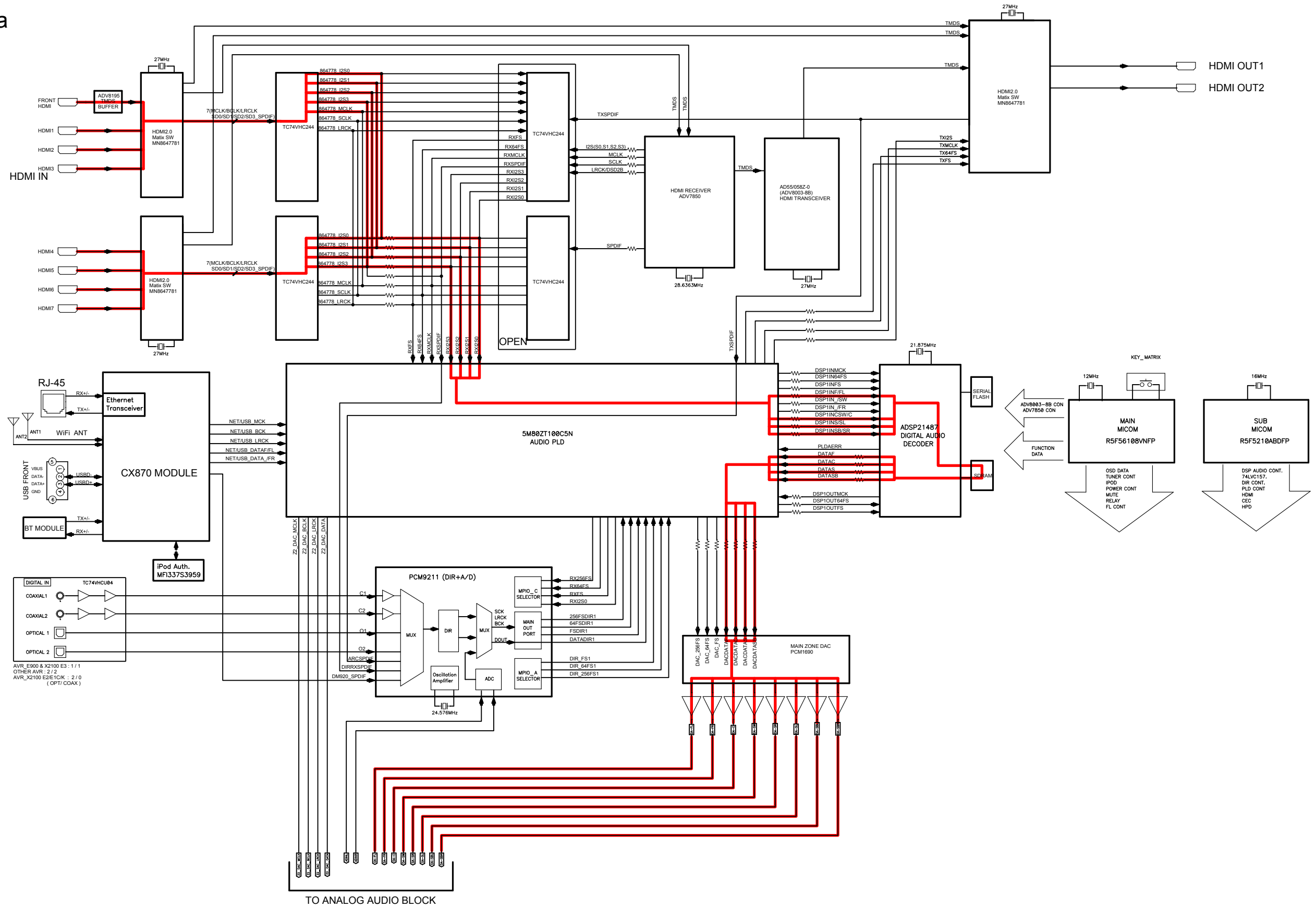

fig.04b

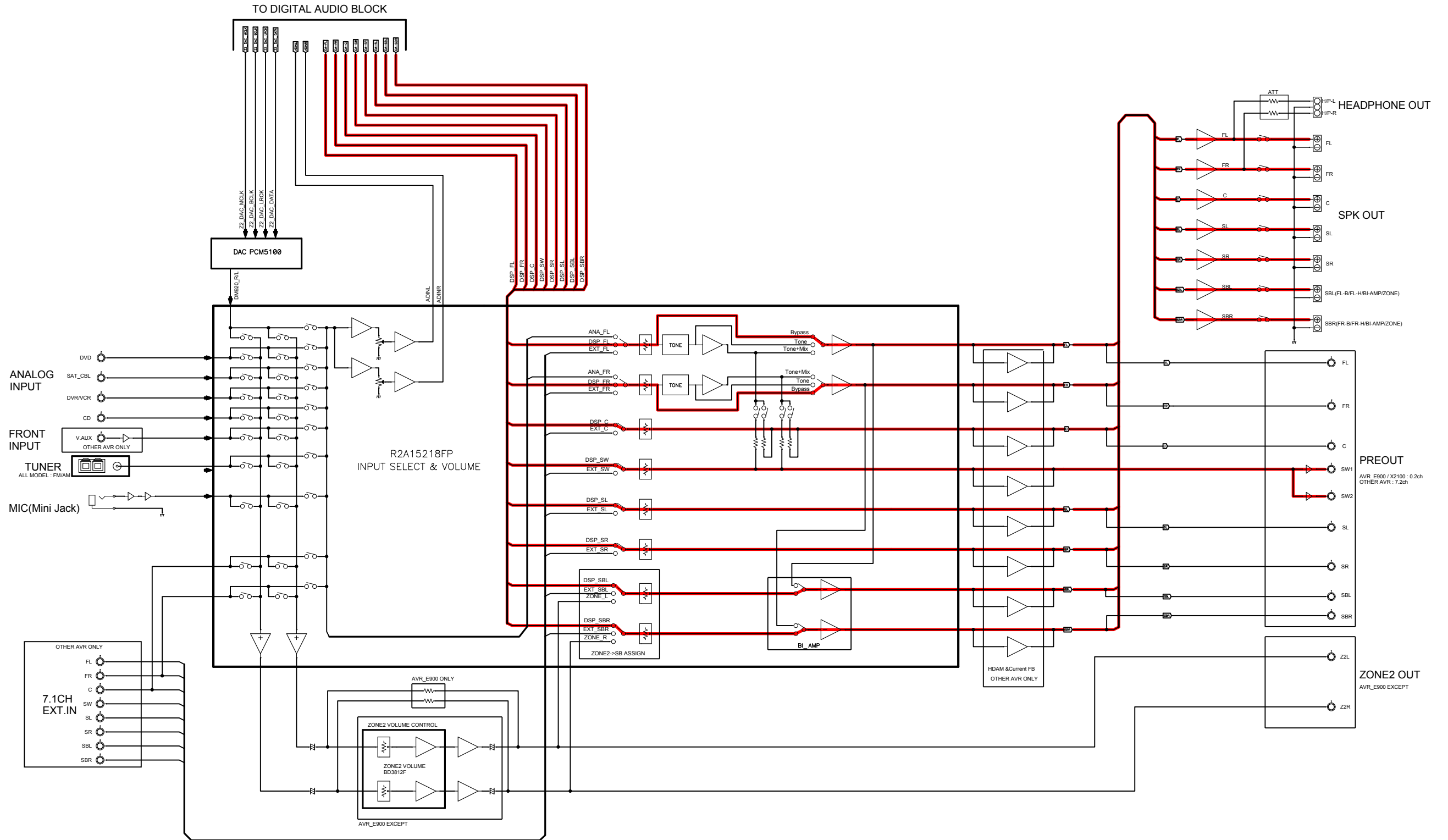

fig.05

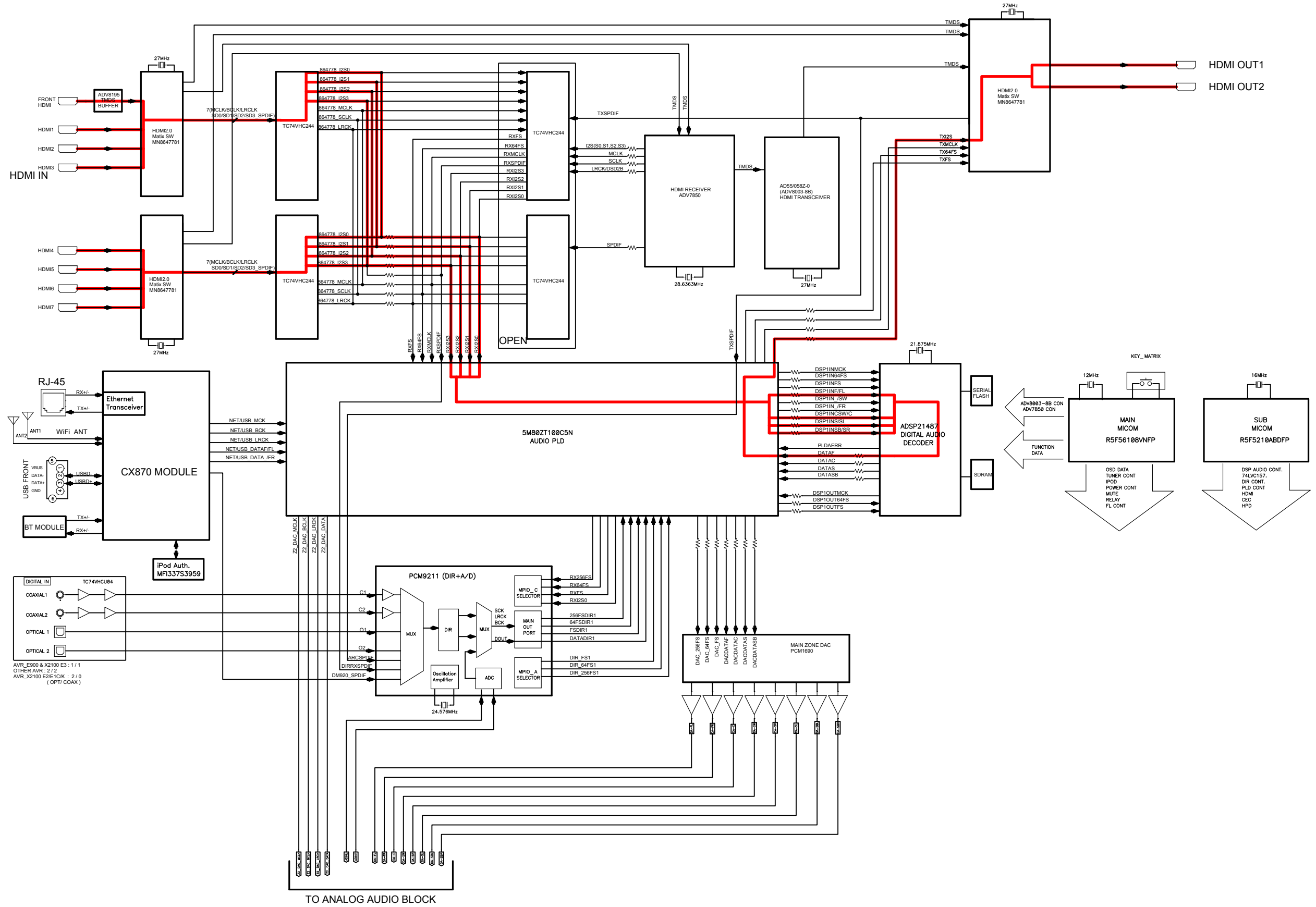

fig.06

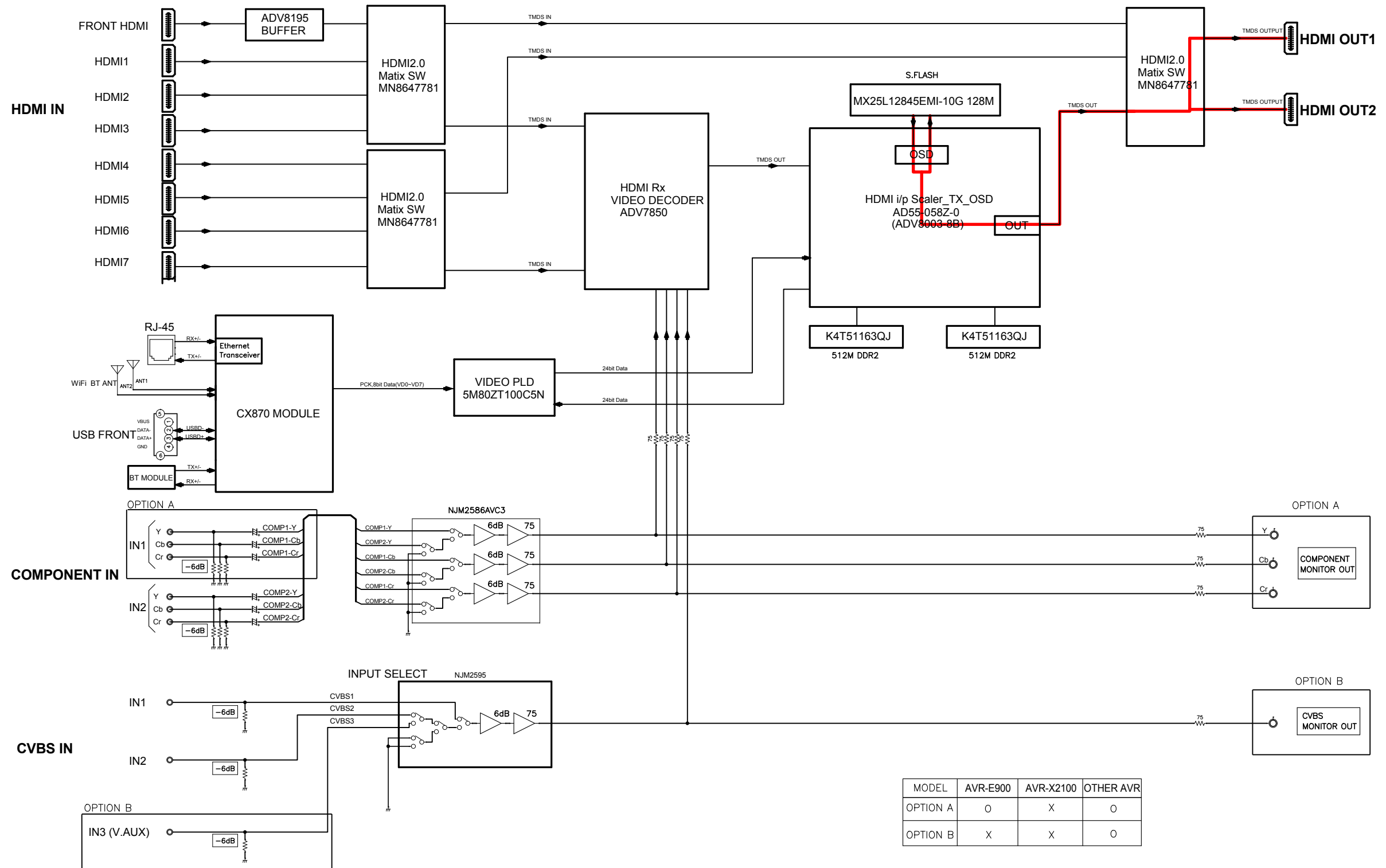



fig.07

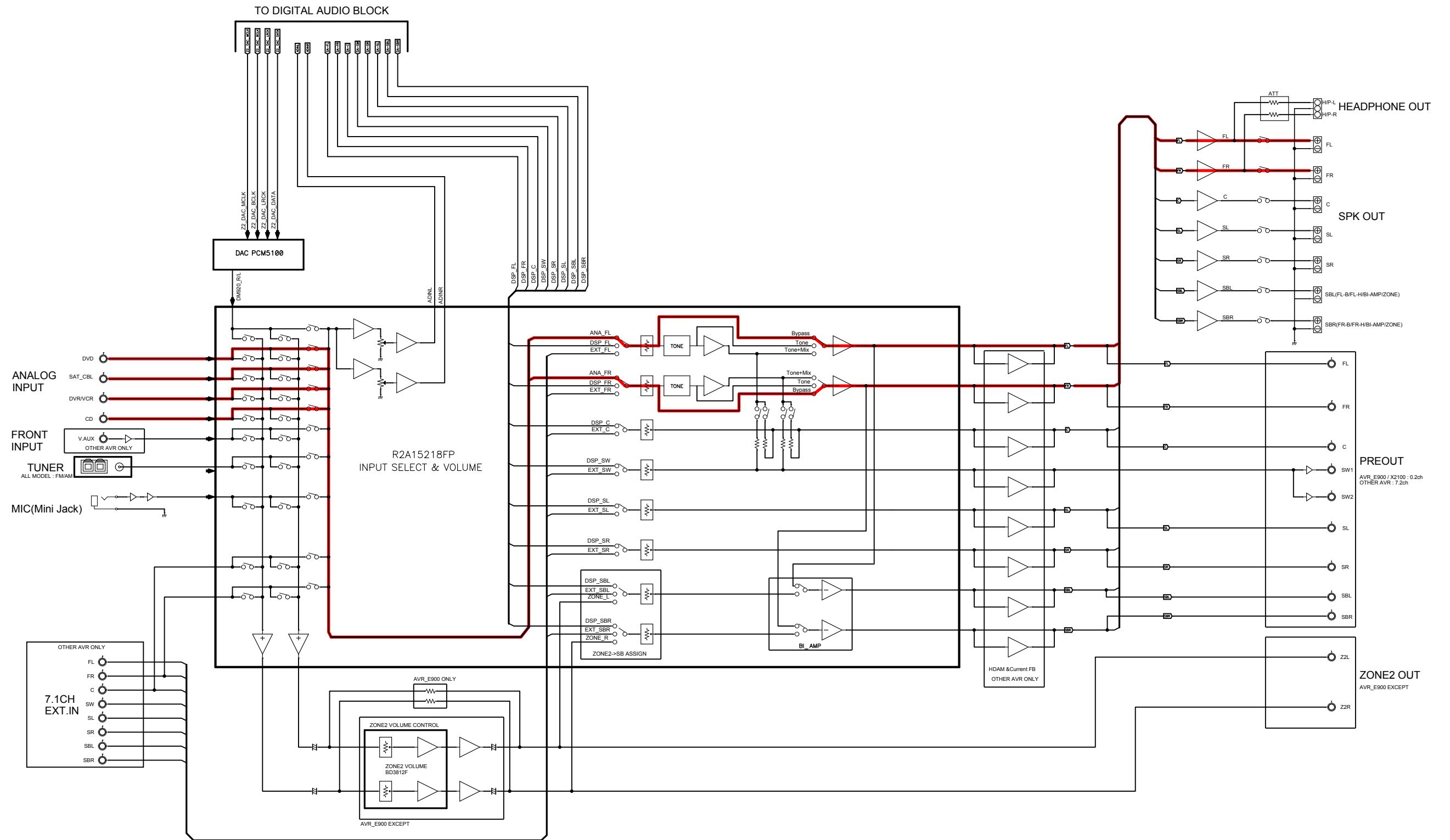

fig.08a

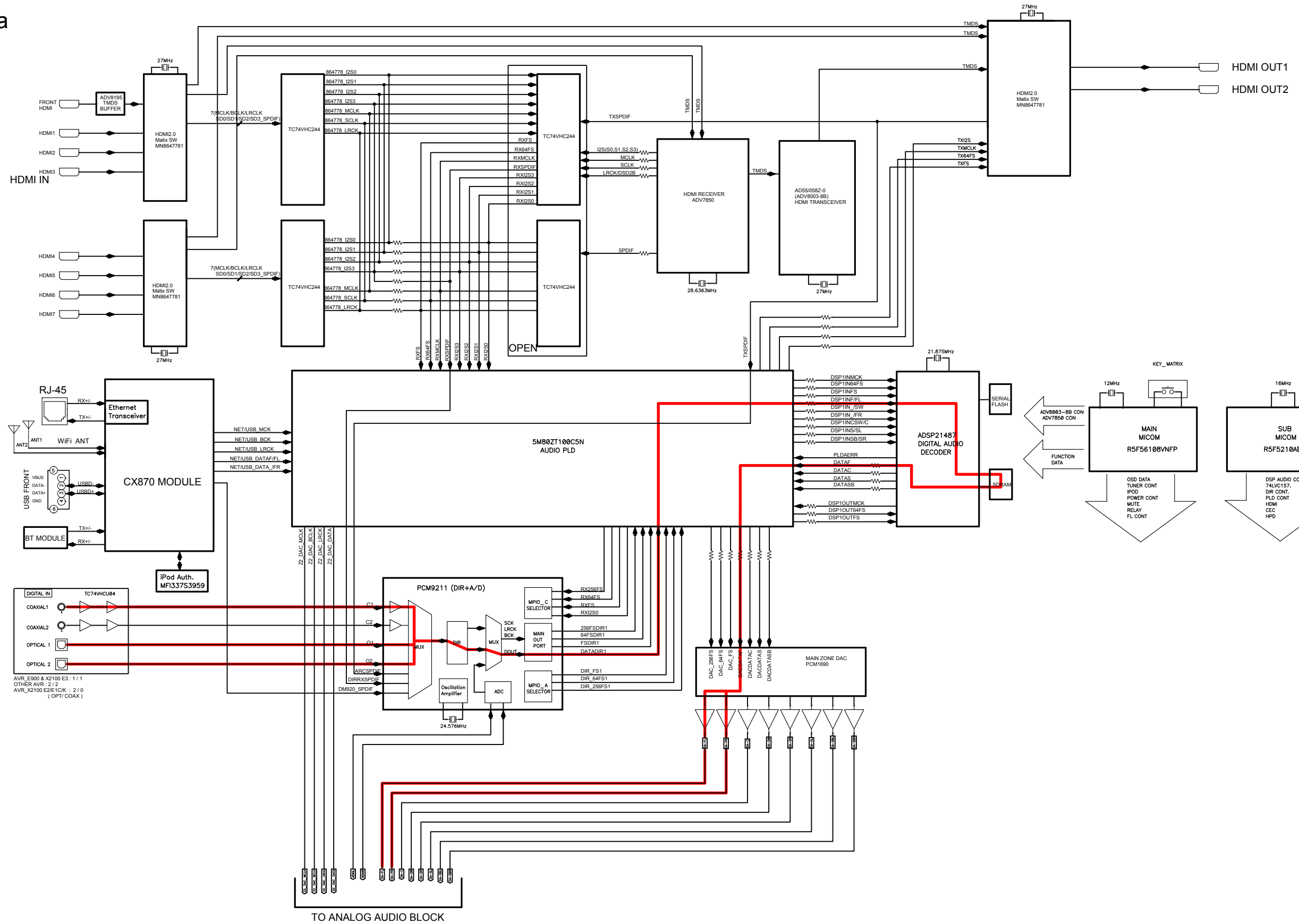

fig.08b

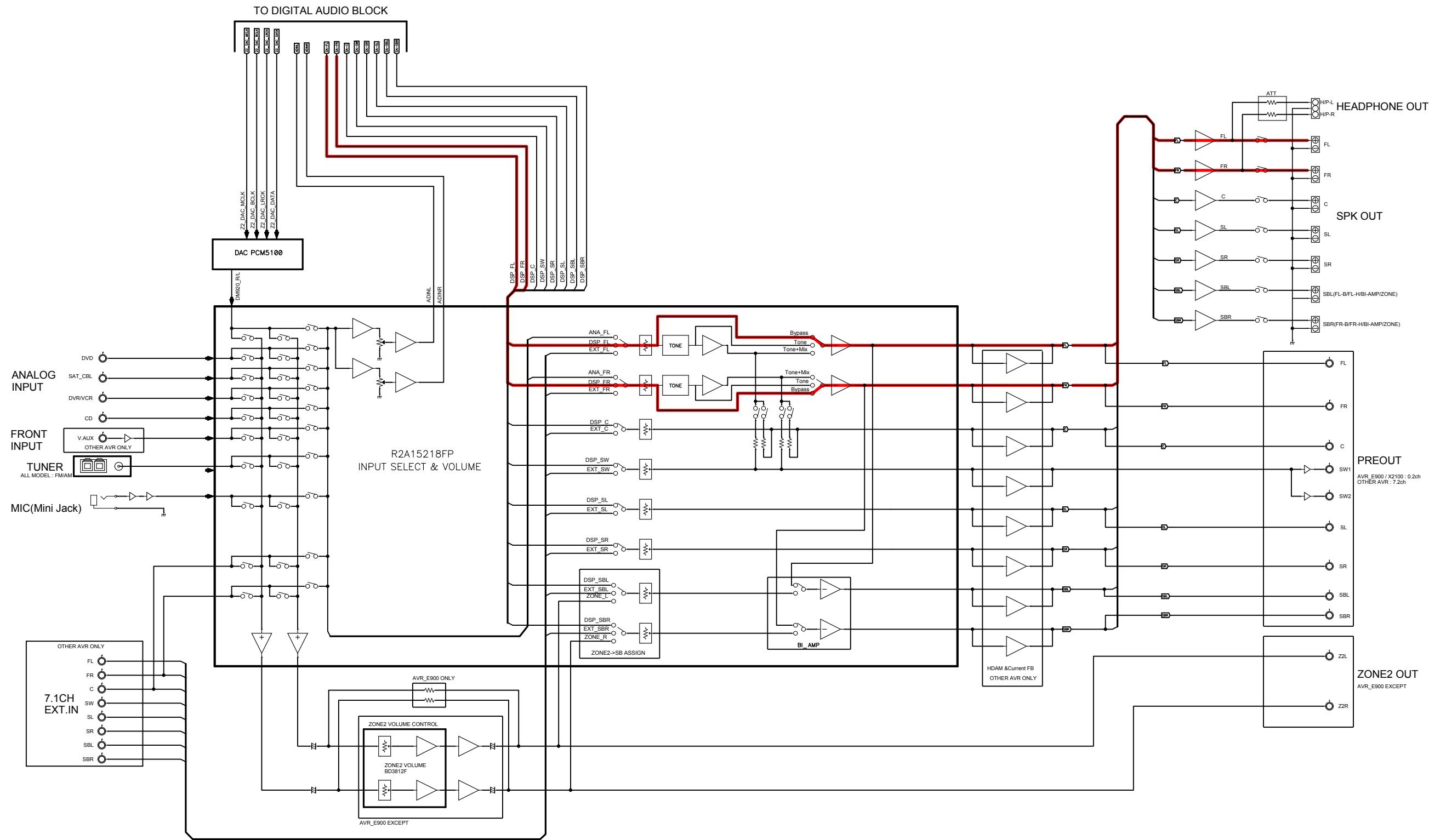

fig.09a

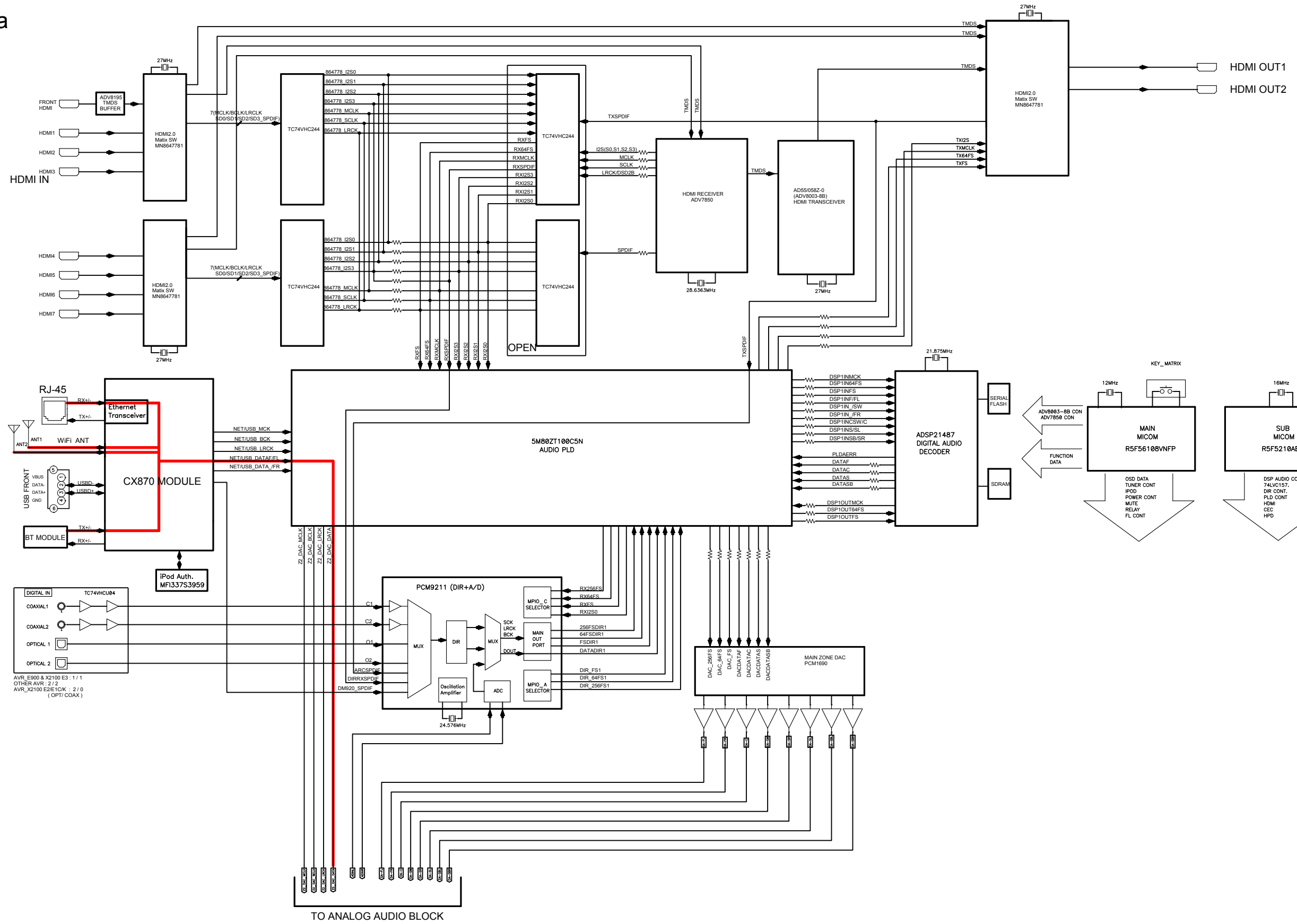

fig.09b

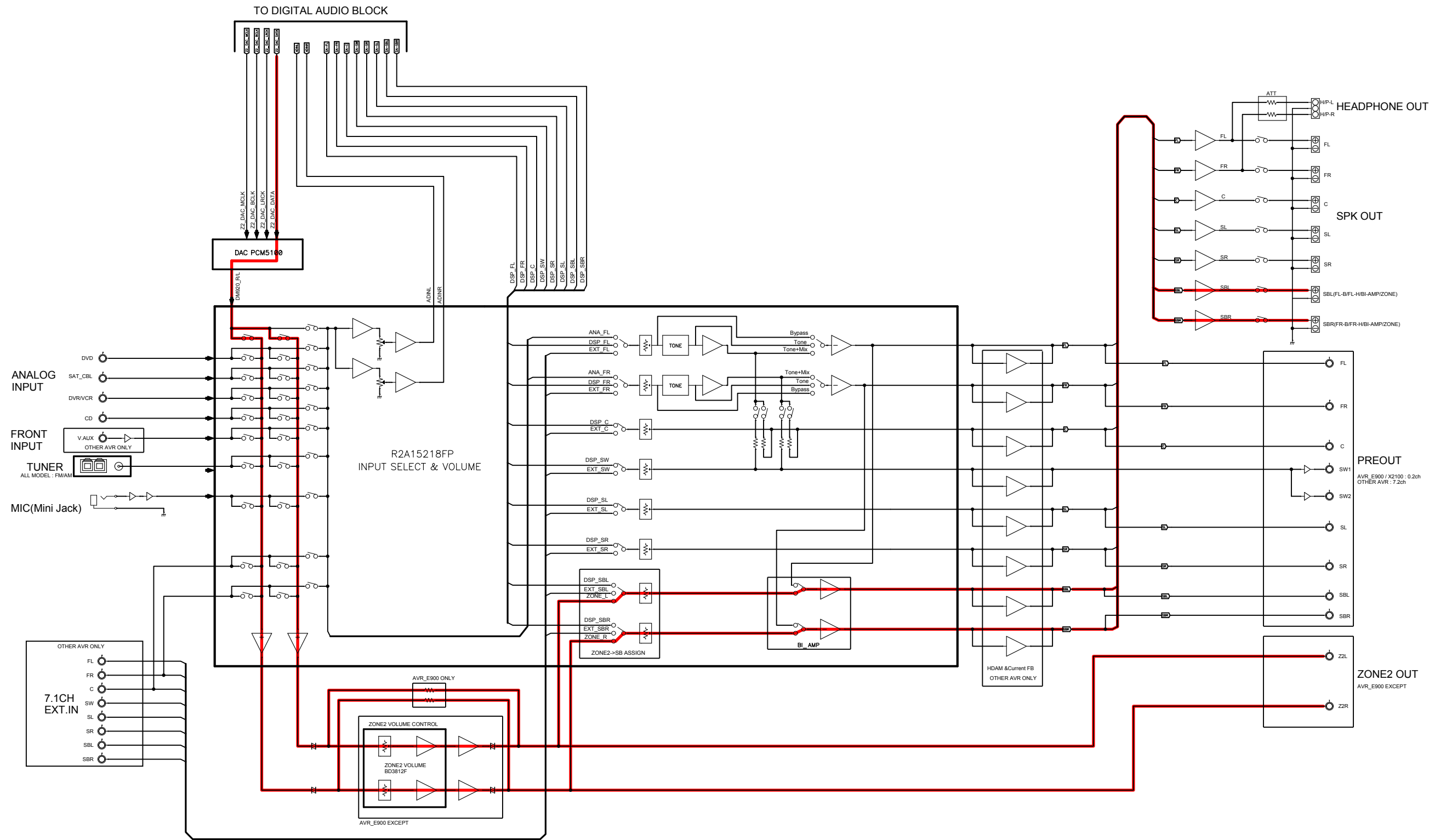

fig.10a

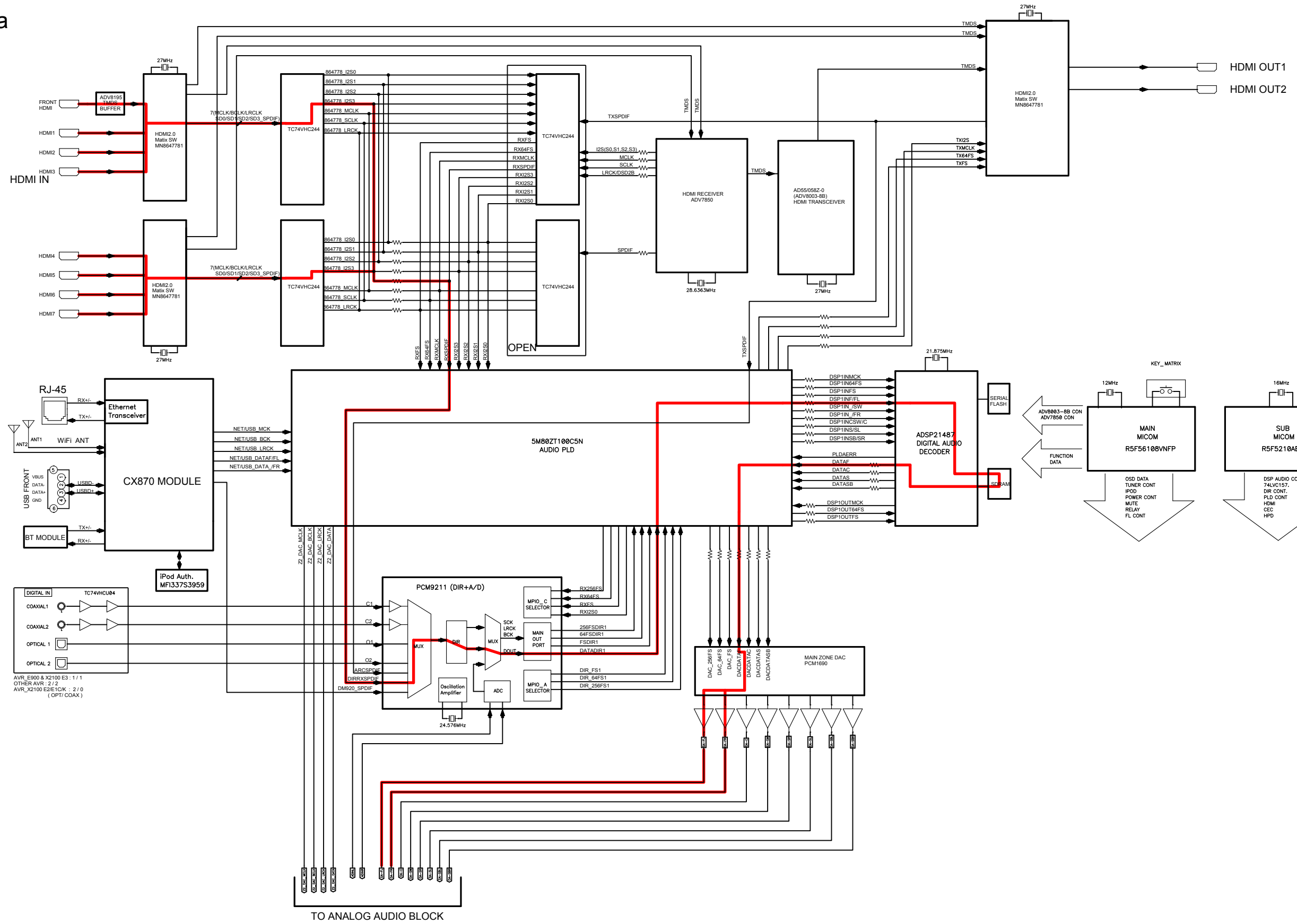

fig.10b

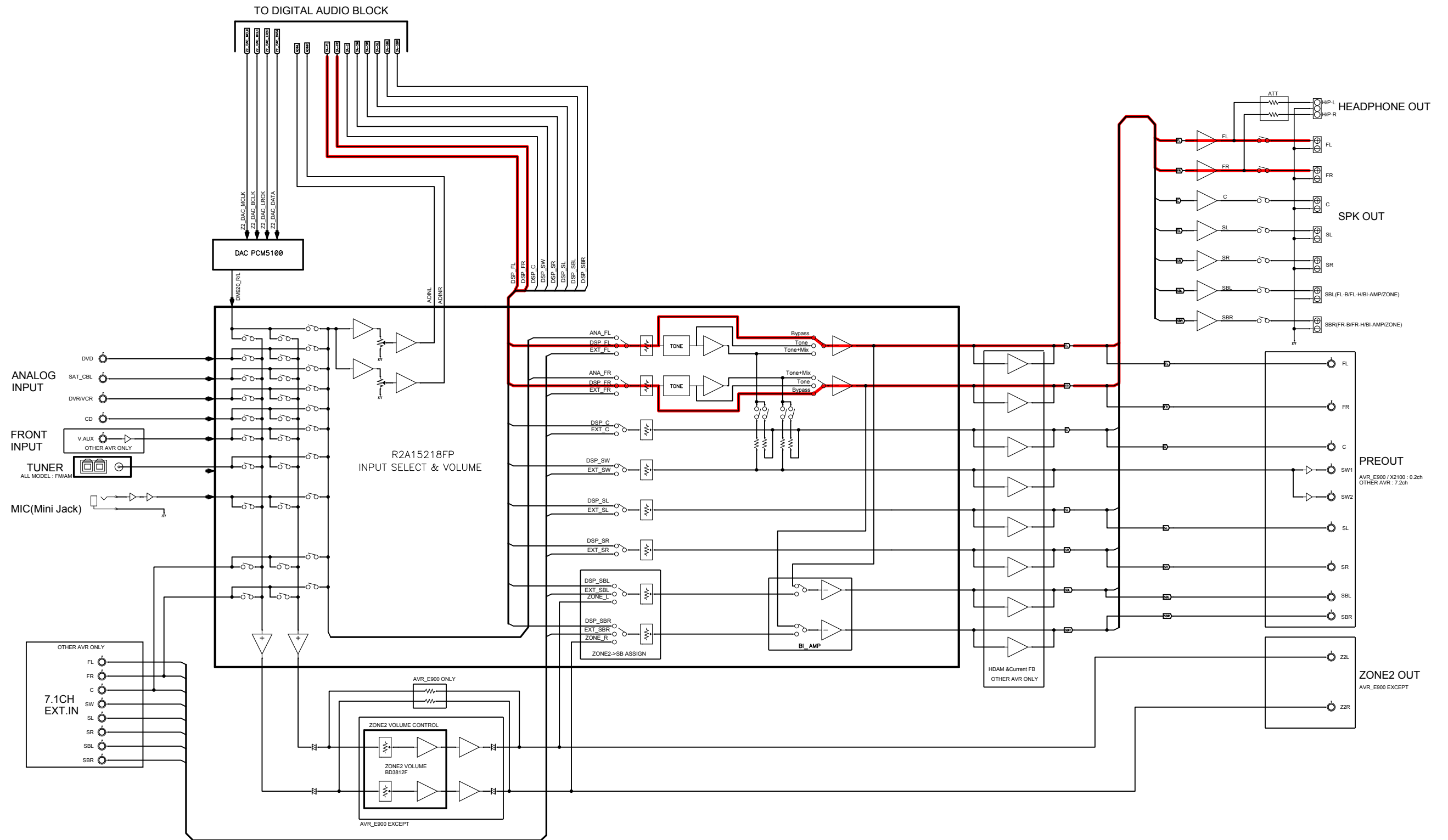

fig.11a

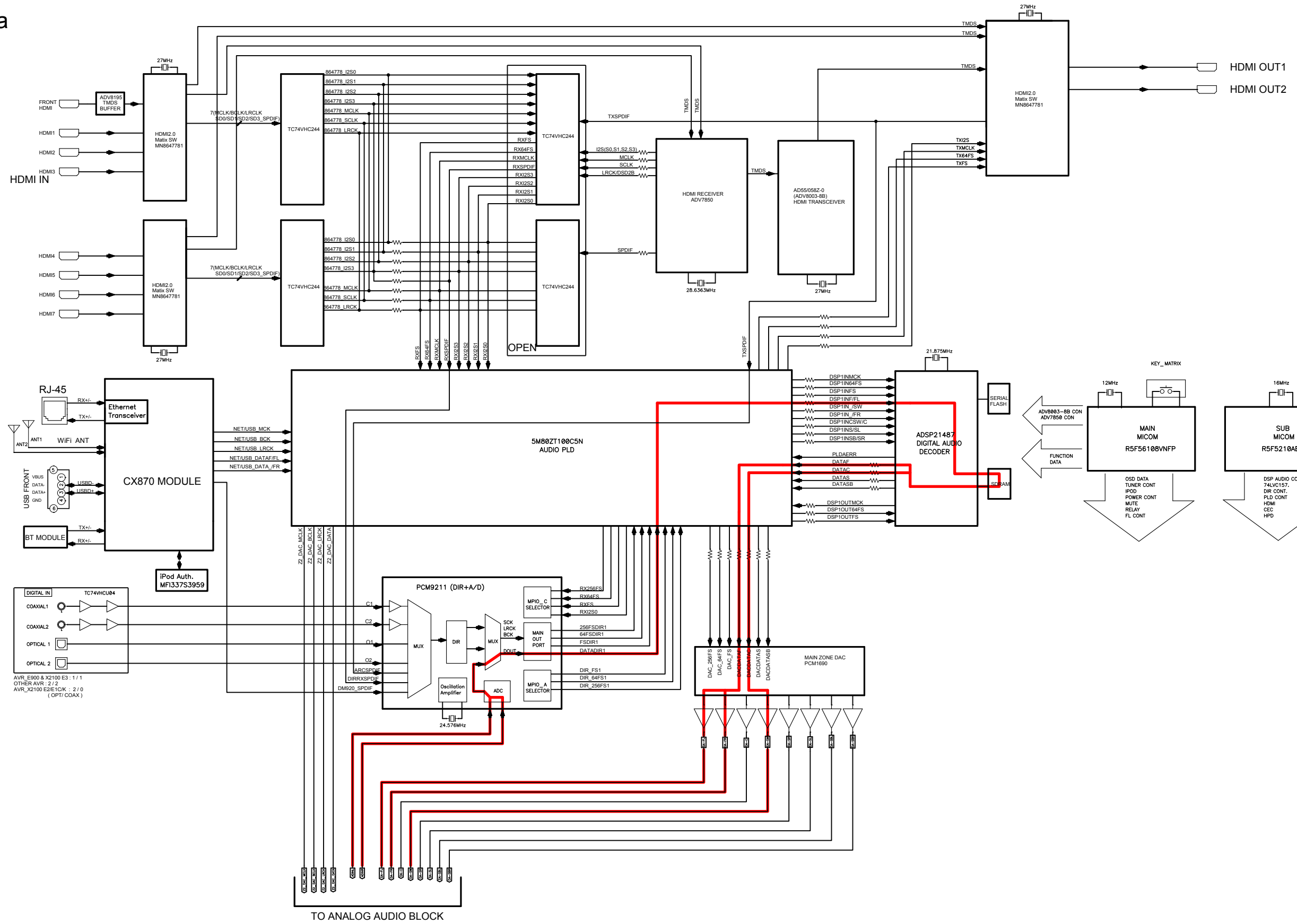



fig.11b

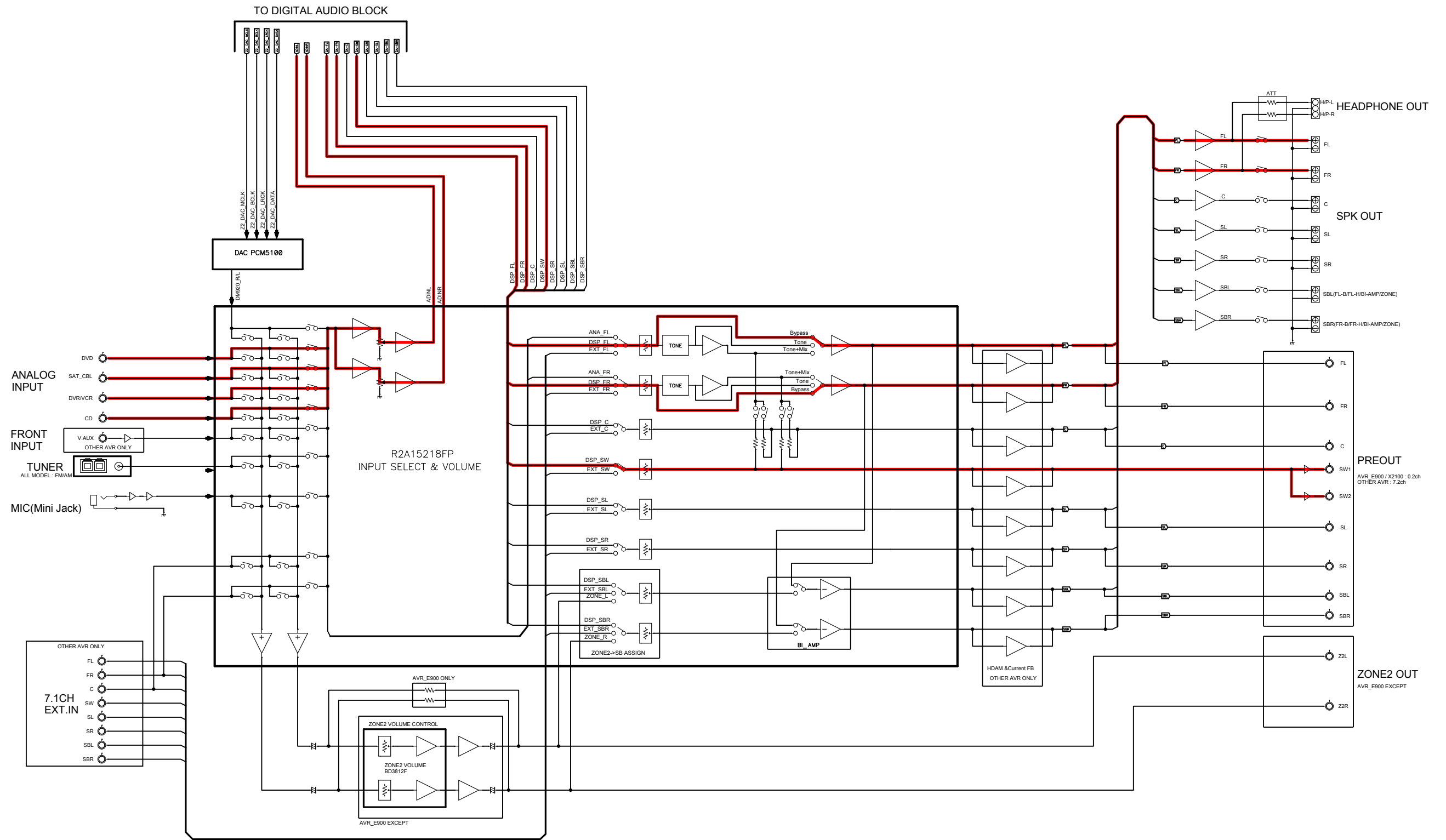

fig.12

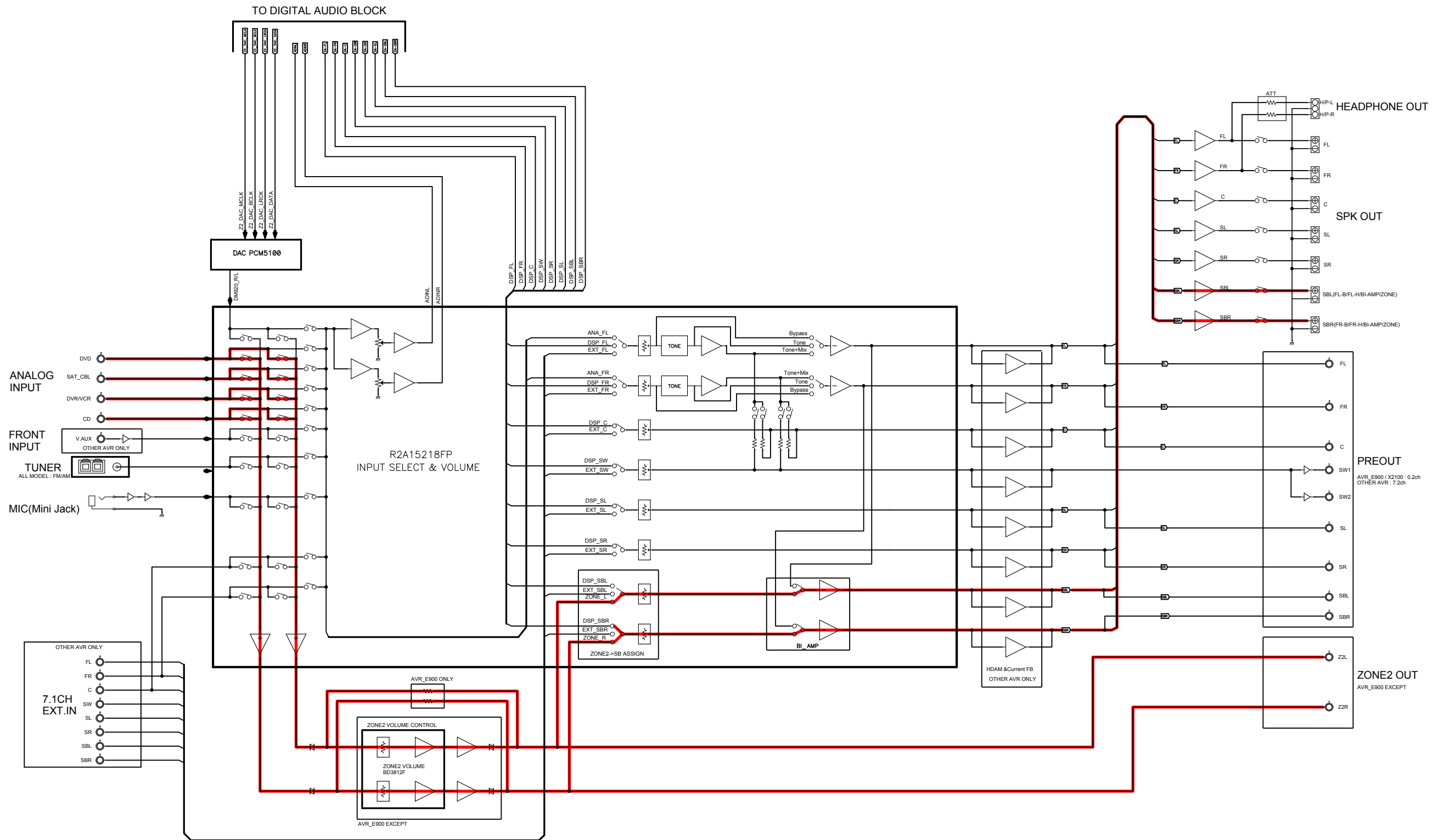

fig.13

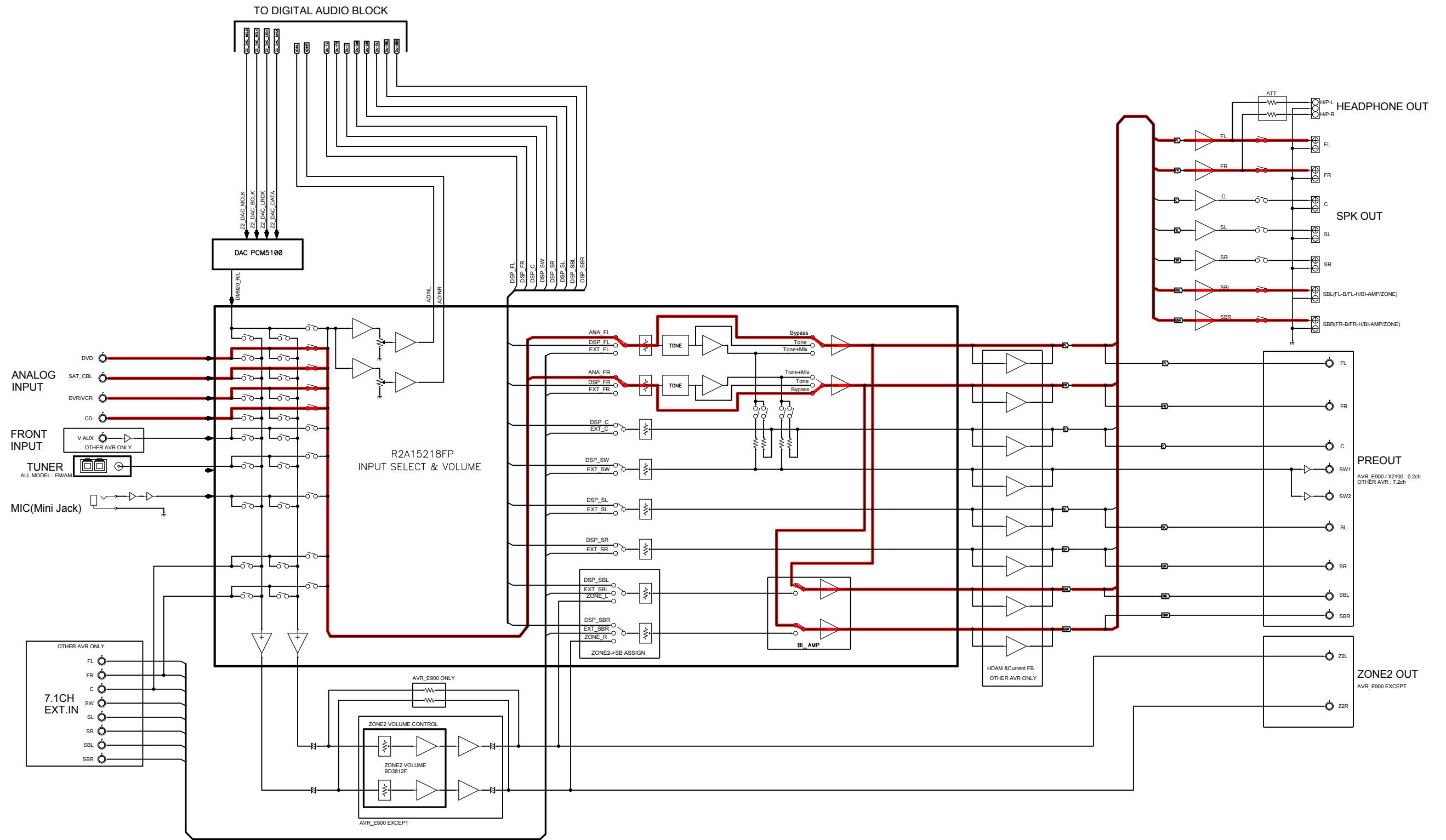

fig.14a

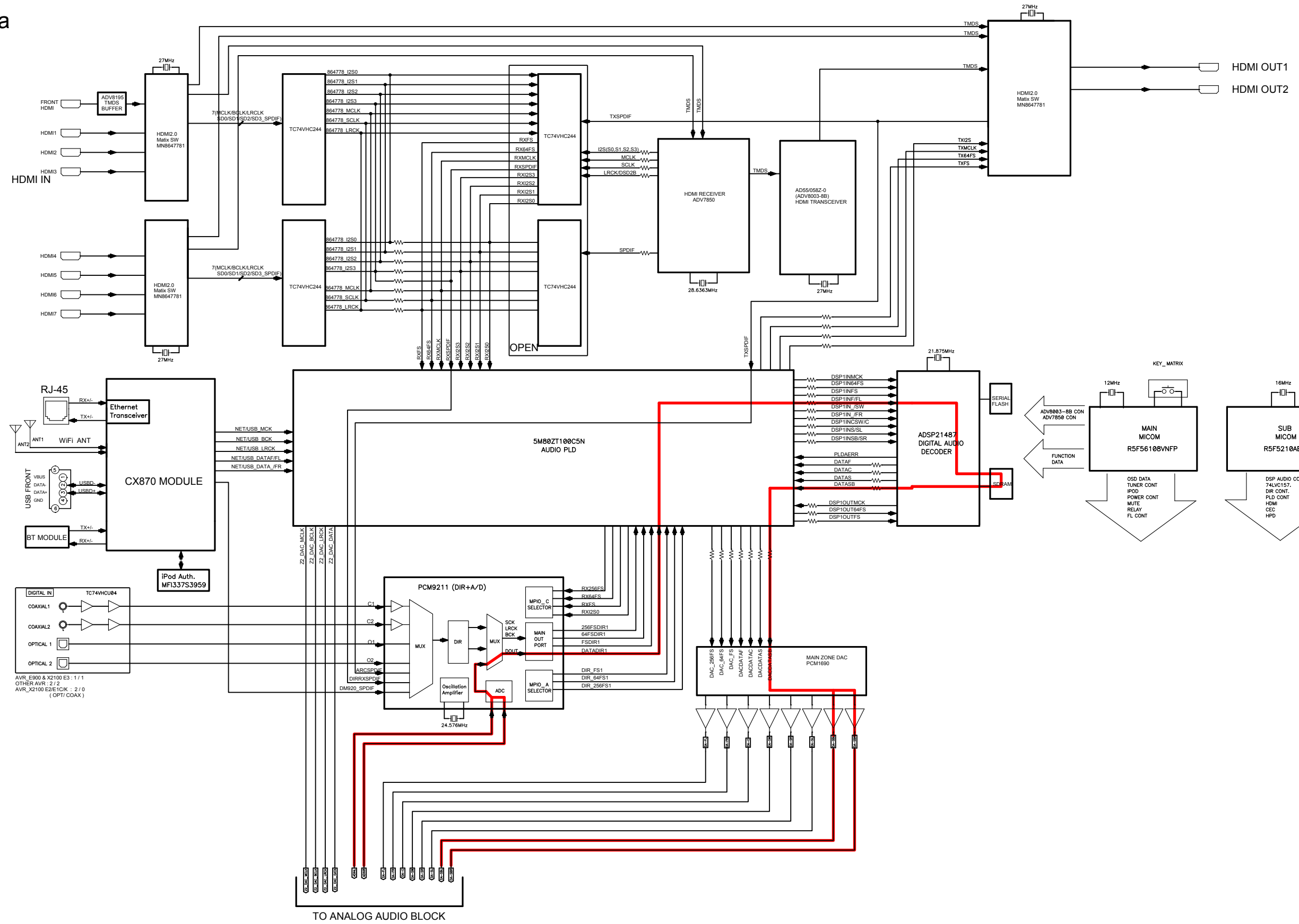
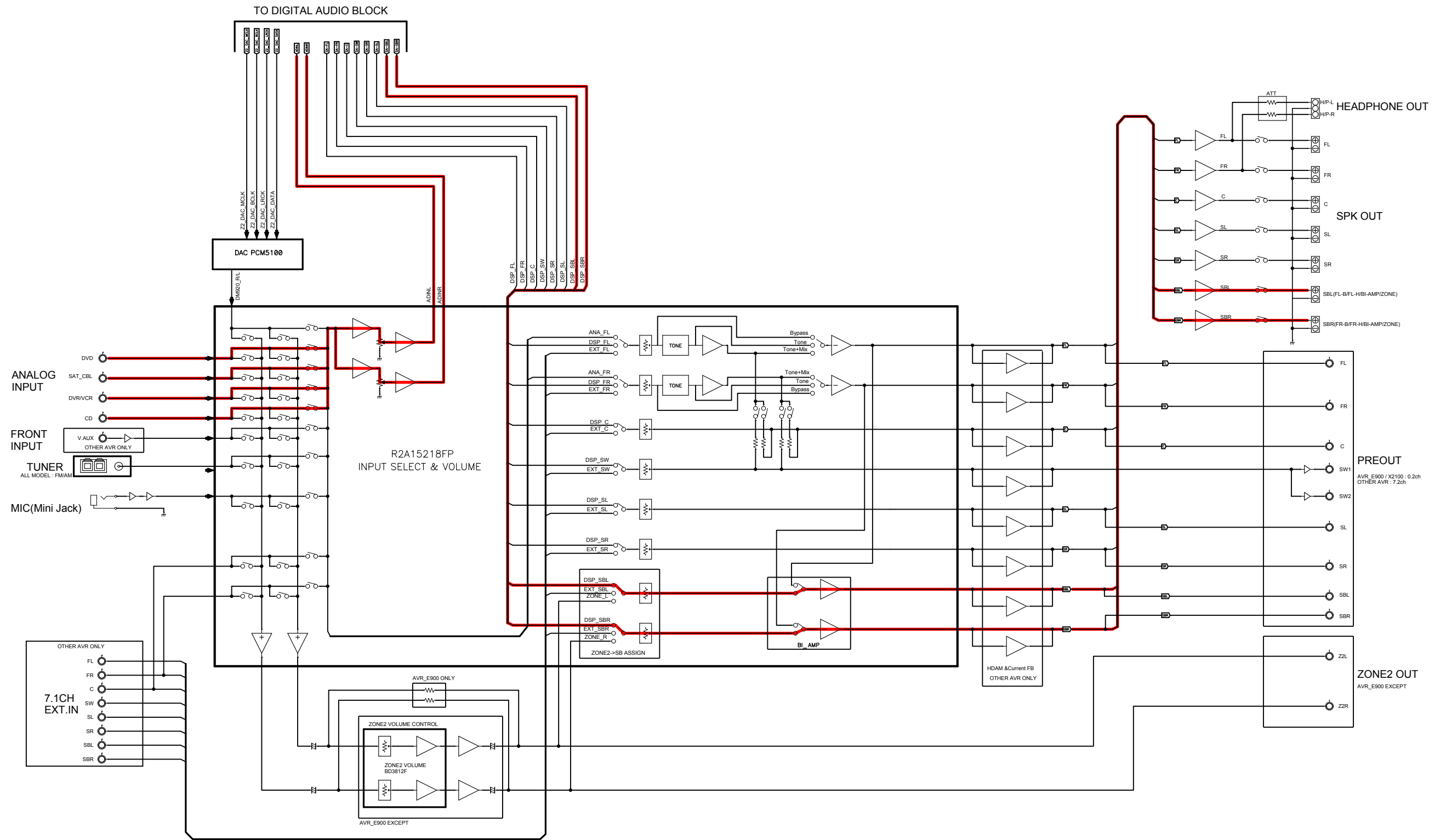

fig.14b



### 3.5. Protection History Display Mode

#### 3.5.1. Actions

This mode records and displays an event in which the THERMAL, ASO or DC protection was activated. If protections have been activated multiple times, the latest protection operation is recorded.

#### 3.5.2. Starting up

AVR-X2100W

·Hold down buttons "ZONE2 SOURCE", "DIMMER" and "STATUS" at the same time and press the power button to turn on the power.

AVR-S900W

·Hold down buttons "TUNER PRESET CH+", "TUNE -" and "PRESET +" at the same time and press the power button to turn on the power.

Select the "2. PROTECTION" using the button "TUNER PRESET CH+ / -", and press the button "STATUS" to commit the selection.

#### 3.5.3. Protection information and displays

·Press the "STATUS" button in Protection History Display Mode.

·The protection history can be checked.

(1) If no protections have occurred.

FLD	N	O		P	R	O	T	E	C	T							
-----	---	---	--	---	---	---	---	---	---	---	--	--	--	--	--	--	--

(2) ASO / DC (if the last protection was ASO / DC)

FLD	P	R	T	:	A	S	O	/	D	C							
-----	---	---	---	---	---	---	---	---	---	---	--	--	--	--	--	--	--

**Cause:** A short circuit occurred between the speaker terminals, or speakers with an impedance outside the rating were connected.

Abnormal DC output from the power amp.

**Note:** Short circuits in speaker terminals or speakers can be identified.

If the power is turned on during this abnormality, protection is activated after around 6 seconds and the power is turned off.

(4) THERMAL (if the last protection was THERMAL(A) or THERMAL(B) or THERMAL(E))

FLD	P	R	T	:	T	H	E	R	M	A	L		A				
-----	---	---	---	---	---	---	---	---	---	---	---	--	---	--	--	--	--

FLD	P	R	T	:	T	H	E	R	M	A	L		B				
-----	---	---	---	---	---	---	---	---	---	---	---	--	---	--	--	--	--

FLD	P	R	T	:	T	H	E	R	M	A	L		E				
-----	---	---	---	---	---	---	---	---	---	---	---	--	---	--	--	--	--

**Cause:** Abnormal heat sink temperature.

If the power is turned on during this abnormality, protection is activated after around 2 minutes and the power is turned off.

(4) Case of CURRENT (when the last protection incident was CURRENT protection)

FLD	:	C	U	R	R	E	N	T									
-----	---	---	---	---	---	---	---	---	--	--	--	--	--	--	--	--	--

**Caution :** These protections may also be activated due to causes such as disconnection of connectors or operations around the microcomputer.

After viewing the above protection history, press the button "STATUS" to return to the normal display.

### 3.5.4. Clearing the Protection History

There are two ways to clear the protection history.

- (1) Start Protection History Display Mode. Press the button "**STATUS**" to display the protection history. Press and hold the button "**DIMMER**" for 3 seconds.

FLD	P	R	T	:	D	C										
-----	---	---	---	---	---	---	--	--	--	--	--	--	--	--	--	--

↓  
Press and hold the button "**DIMMER**" for 3 seconds.

FLD	P	R	T	:	C	L	E	A	R							
-----	---	---	---	---	---	---	---	---	---	--	--	--	--	--	--	--

↓  
The above is displayed and the protection history is cleared.

FLD	N	O		P	R	O	T	E	C	T						
-----	---	---	--	---	---	---	---	---	---	---	--	--	--	--	--	--

- (2) Initialize this unit. ( "See "**Initializing This Unit**"[11 page](#) )

※ Use the method in **3.5.3.(1)** if you do not want to erase your settings from this unit.

### Warning Displays by POWER LED

If the power is turned off while a protection is detected, the POWER LED (red) flashes in the following ways as a warning according to the protection status.

- (1) ASO/DC protection: Flashes in 0.5-second cycles (0.25 seconds lit, 0.25 seconds unlit)
- (2) THERMAL (A/B) protection: Flashes in 2-second cycles (1 second lit, 1 second unlit)

## 3.6. 232C Standby Clear Mode (AVR-X2100E3 only)

### 3.6.1. Actions

#### 232C Standby Clear Mode :

Switches from 232C standby mode to normal standby mode.

#### Starting up

Press the "**STATUS**" button during the following display to switch to normal standby mode.

FLD		3	.	R	S	2	3	2	C		R	E	S	E	T	
-----	--	---	---	---	---	---	---	---	---	--	---	---	---	---	---	--



### 3.6. Operation Info Mode

#### 3.6.1. Actions

This mode displays the accumulated operating time, power on count and each protection count.

#### 3.6.2. Starting up

AVR-X2100W

·Hold down buttons "ZONE2 SOURCE", "DIMMER" and "STATUS" at the same time and press the power button to turn on the power.

AVR-S900W

·Hold down buttons "TUNER PRESET CH+", "TUNE -" and "PRESET +" at the same time and press the power button to turn on the power.

Select the "4. OP INFO" using the button "TUNER PRESET CH+ / -", and press the button "STATUS" to commit the selection.

#### 3.6.3. Operations

Press the "STATUS" button after starting this device in Operation Info mode. The following information is displayed in the following order.

(a) Accumulated operating time

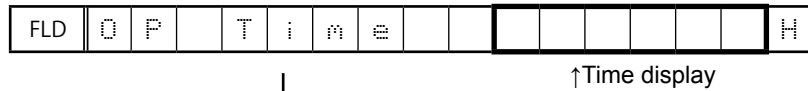

↓  
"STATUS"

(b) Power on count

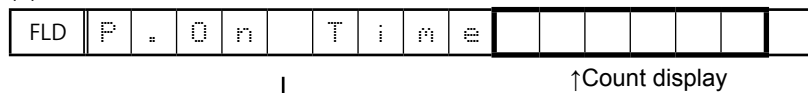

↓  
"STATUS"

(c) DC / ASO Protection count

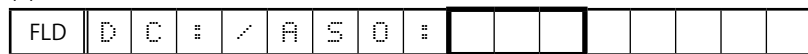

↓  
"STATUS"

(d) Thermal Protection count

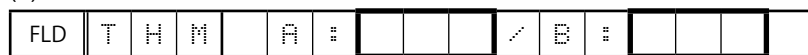

↓  
"STATUS"

(e) Thermal Protection count

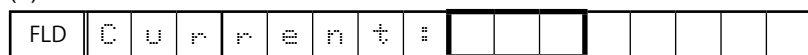

↓  
"STATUS"

(Returns to normal display)

### 3.7. TUNER STEP mode (AVR-X2100WE2/E3 only)

#### 3.3.1. Actions

This is a special mode for enabling reception STEP of the ANALOG TUNER to be changed.

#### 3.7.2. Starting up

AVR-X2100W

·Hold down buttons "ZONE2 SOURCE", "DIMMER" and "STATUS" at the same time and press the power button to turn on the power.

AVR-S900W

·Hold down buttons "TUNER PRESET CH+", "TUNE -" and "PRESET +" at the same time and press the power button to turn on the power.

Select the "5. TUNER FRQ SER" using the button "TUNER PRESET CH+ / -", and press the button "STATUS" to commit the selection.

#### 3.7.3. Displays

Start this unit in TUNER STEP mode, select using button "TUNER PRESET CH+/-" and enter using button "STATUS". The following information is displayed in the following order.

(a) AM9kHz/FM50kHz selected

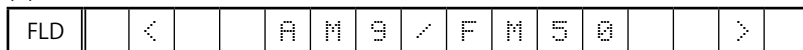

(b) AM10KHz/FM200kHz selected

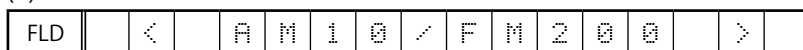

- (C) Press the power button to turn off the power.
- (D) Press the power button to turn on the power.

## 4. Remote ID Setup Mode

### 4.1. Actions

This function allows only the desired AV receiver to be operated if multiple DENON AV receivers are used in the same room.

### 4.2. Starting up

AVR-X2100W

·Hold down buttons "ZONE2 SOURCE", "DIMMER" and "STATUS" at the same time and press the power button to turn on the power.

AVR-S900W

·Hold down buttons "TUNER PRESET CH+", "TUNE -" and "TUNE +" at the same time and press the power button to turn on the power.

Select the "6. REMOTE ID" using the button "TUNER PRESET CH+ / -", and press the button "STATUS" to commit the selection.

### 4.3. Operations

(1) When Remote ID Setup mode is started, the following is displayed.

FLD				R	E	M	O	T	E		I	D		?		
-----	--	--	--	---	---	---	---	---	---	--	---	---	--	---	--	--

(2) Press the "QUICK SELECT 1 - 4" button that corresponds to the number you want to set.

Button	Display																
QUICK SELECT 1	<table border="1"><tr><td></td><td></td><td></td><td>R</td><td>E</td><td>M</td><td>O</td><td>T</td><td>E</td><td></td><td>I</td><td>D</td><td></td><td>1</td><td></td><td></td></tr></table>				R	E	M	O	T	E		I	D		1		
			R	E	M	O	T	E		I	D		1				
QUICK SELECT 2	<table border="1"><tr><td></td><td></td><td></td><td>R</td><td>E</td><td>M</td><td>O</td><td>T</td><td>E</td><td></td><td>I</td><td>D</td><td></td><td>2</td><td></td><td></td></tr></table>				R	E	M	O	T	E		I	D		2		
			R	E	M	O	T	E		I	D		2				
QUICK SELECT 3	<table border="1"><tr><td></td><td></td><td></td><td>R</td><td>E</td><td>M</td><td>O</td><td>T</td><td>E</td><td></td><td>I</td><td>D</td><td></td><td>3</td><td></td><td></td></tr></table>				R	E	M	O	T	E		I	D		3		
			R	E	M	O	T	E		I	D		3				
QUICK SELECT 4	<table border="1"><tr><td></td><td></td><td></td><td>R</td><td>E</td><td>M</td><td>O</td><td>T</td><td>E</td><td></td><td>I</td><td>D</td><td></td><td>4</td><td></td><td></td></tr></table>				R	E	M	O	T	E		I	D		4		
			R	E	M	O	T	E		I	D		4				

(3) Press the power button to turn off the power.

(4) Press the power button to turn on the power.

※ Only "QUICK SELECT 1 - 4" and the POWER button on the unit can be used in Remote ID Setup Mode.

※ The remote ID of the remote control supplied with this unit cannot be changed. ⚠⚠

⚠⚠

#### NOTE:

If the ID of the unit and remote control do not match, "AVAMP\*" appears on the display of the unit when the remote control is used (\*: own remote control ID).

## 5. Protection Pass Mode

### 5.1. Actions

- This mode allows the power to be turned on without activating protections.
- This is the same as normal power-on, except that protections are not activated.

### 5.2. Operations

AVR-X2100W

- Hold down buttons "TUNER PRESET CH +", "ZONE2 SOURCE" and "STATUS" at the same time and press the power button to turn on the power.

AVR-S900W

- Hold down buttons "ZONE2 SOURCE", "TUNER PRESET CH +" and "TUNE +" at the same time and press the power button to turn on the power.

The device returns to the normal display after the following is displayed.

FLD	P	r	o	t	e	c	t	i	o	n	P	a	s	s
-----	---	---	---	---	---	---	---	---	---	---	---	---	---	---

This is displayed for 5 seconds before returning to the normal display.

## 6. CX870 / CY920 Reboot mode

### 6.1. Actions

- The CX870 / CY920 is restarted after CX870 / CY920 hangup.
- The CX870 / CY920 can be restarted even in the network standby setting ("Setup menu" – "Network" – "Network" – "Always On").

### 6.2. Operations

1. Turn on the button "MAIN ZONE" and set NETWORK as the input source.
2. Hold down buttons "TUNER PRESET CH +" and "TUNER PRESET CH -" for at least 3 seconds while the power is on.
3. FL display during CX870 / CY920 reboot

FLD	N	e	t	w	o	r	k	R	e	s	t	a	r	t
-----	---	---	---	---	---	---	---	---	---	---	---	---	---	---

4. Returns to the normal display.

#### NOTE:

- The CX870 / CY920 Reboot operation is not accepted again for one minute after executing the reboot.
- Reception is prohibited during update, save and load.

## 7. CX870 / CY920 Initialization mode

### 7.1. Actions

The following items are initialized.

- (1) Favorites
- (2) Quick Select
- (3) Presets
- (4) Internet Radio Recently Played
- (5) Flickr contacts
- (6) User ID
- (7) Resume Playback station

### 7.2. Operations

AVR-X2100W

·Hold down buttons "**ZONE2 SOURCE**" and "**DIMMER**" for at least 3 seconds while the power is on.

AVR-S900W

·Hold down buttons "**TUNER PRESET CH +**" and "**TUNE -**" for at least 3 seconds while the power is on.

Initializing Display

FLD	I	n	i	t	i	a	l	i	z	i	n	g				
FLD	I	n	i	t	i	a	l	i	z	i	n	g	.			
FLD	I	n	i	t	i	a	l	i	z	i	n	g	.	.		
FLD	I	n	i	t	i	a	l	i	z	i	n	g	.	.	.	

Complete Display

FLD				C	o	m	p	l	e	t	e	d				
-----	--	--	--	---	---	---	---	---	---	---	---	---	--	--	--	--

This is displayed for 5 seconds before returning to the normal display.

Failed Display

FLD					F	a	i	l	e	d						
-----	--	--	--	--	---	---	---	---	---	---	--	--	--	--	--	--

# JIG FOR SERVICING

The following jigs (extension cable kit) are used when repairing the PCBs.  
 Order the jigs from your dealer if necessary.

**CAUTION : Incorrect connections may cause malfunction.**

- Connection of Jig for HDMI PCB**

**-Items to Be Prepared-**

- 8U- 110084S : EXTENSION UNIT KIT : 1 Set
- 8U- 110136S : EXTENSION UNIT KIT : 1 Set
- Insulation sheet (Not supplied) : 2 sheet
- Ground lead (Not supplied) : 2 pc

**-Procedures-**

(1) Remove the screws.



(2) Remove the connector PCB.

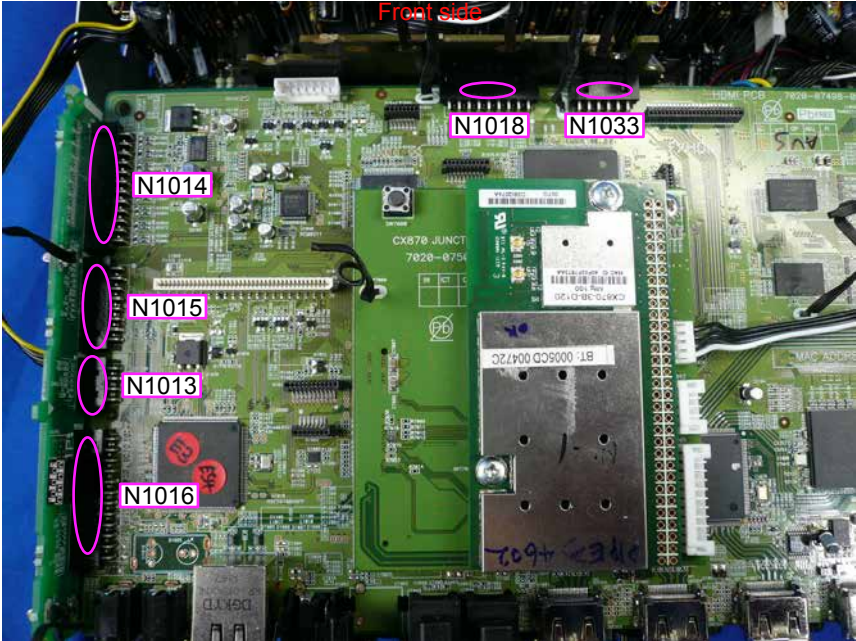

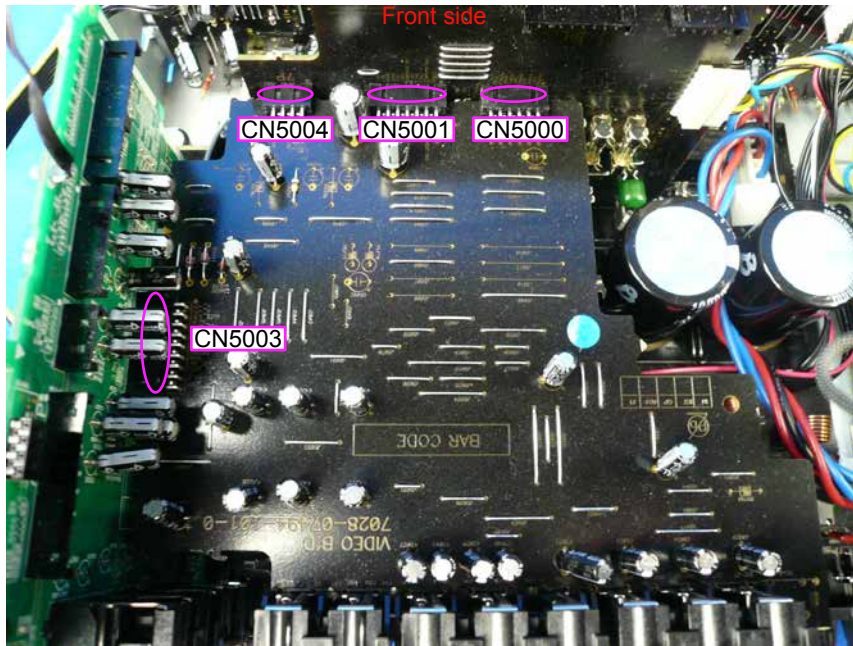

- (3) Remove the HDMI PCB from the chassis and turn it over.  
Place an insulation sheet larger than the PCB underneath the HDMI PCB.  
※ Connect the earth of the PCB to the chassis using an earth wire, etc.

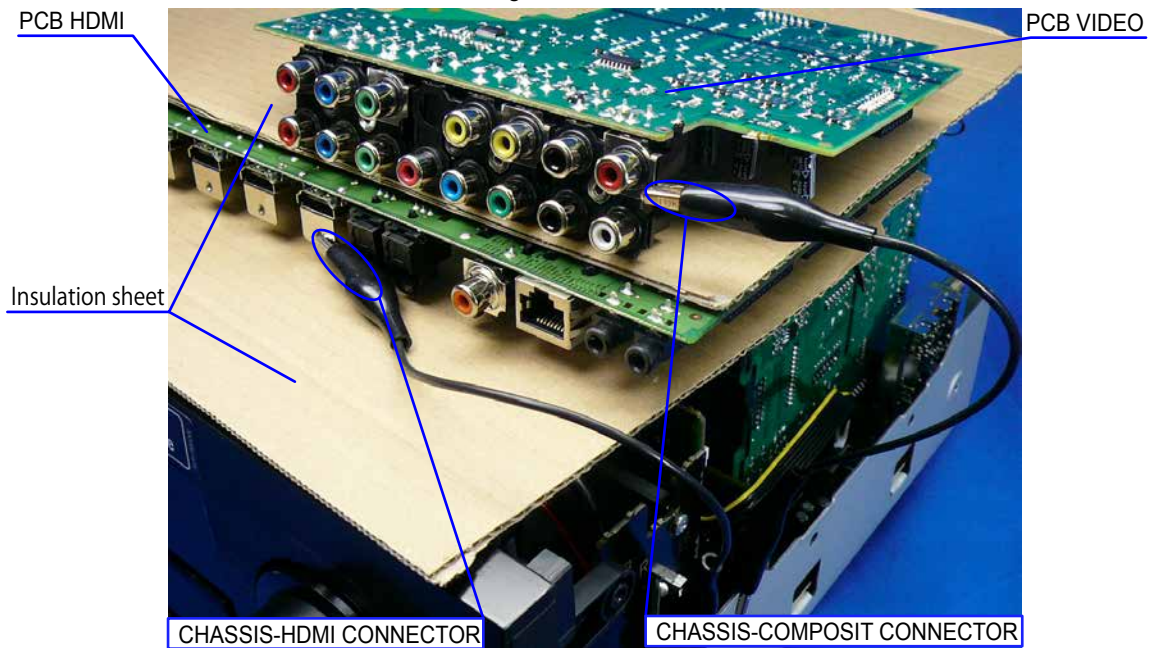



(4) Connect the expansion cables.

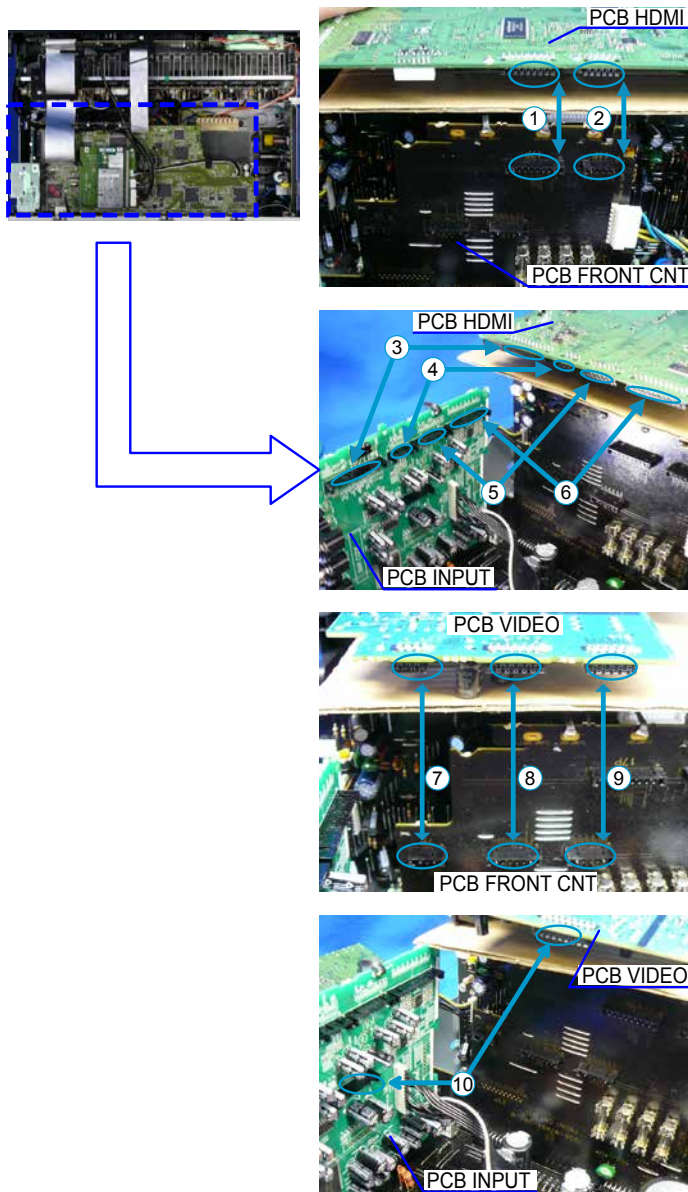

Connection table of Board to Board

No.	Pin	Ref. No.	PCB		Ref. No.	PCB
①	17pin	CP3404	FRONT CNT	↔	N1018	HDMI
②	11pin	CP3401	FRONT CNT	↔	N1033	HDMI
③	23pin	CP4200	INPUT	↔	N1016	HDMI
④	7pin	CP4203	INPUT	↔	N1013	HDMI
⑤	15pin	CP4205	INPUT	↔	N1015	HDMI
⑥	23pin	CP4201	INPUT	↔	CN1014	HDMI
⑦	7pin	CP5004	FRONT CNT	↔	CN5004	VIDEO
⑧	13pin	CP5001	FRONT CNT	↔	CN5001	VIDEO
⑨	11pin	CP5000	FRONT CNT	↔	CN5000	VIDEO
⑩	17pin	CP4204	INPUT	↔	CN5003	VIDEO



# PROCEDURE AFTER REPLACING THE MICROPROCESSOR, ETC.

The procedure after replacing the u-COM (microprocessor), flash ROM, etc. is as follows.

PCB Name	Ref. No.	Description	Procedure after Replacement	Remark
HDMI	U1018	R5F56108VNFP 32BIT	B	SOFTWARE: Main
HDMI	U1020	R5F5210ABDFP	B	SOFTWARE: Sub
HDMI	U1025	MX25L1606EM2I-12G 16M	B	SOFTWARE: DSP ROM
HDMI	U1027	MX25L12835FMI-10G 128M	B	SOFTWARE: GUI ROM
HDMI	U1041	5M80ZT100C5N TQFP100	B	SOFTWARE: AUDIO PLD
HDMI	U1045	5M80ZT100C5N TQFP100	B	SOFTWARE: VIDEO PLD

Procedure after Replacement

- A** : The software has been written. The software is not written at the time of replacement.
- B** : The software has been written. The software may need to be rewritten by version updates. Check the version.
- C** : The software has not been written. The software needs to be written after replacement.  
See "**Firmware Update Procedure**" for information on writing the software.
- D** : The software has been written. Be sure to rewrite with the latest software for your service region.  
See "**Firmware Update Procedure**" for information on writing the software.

## FIRMWARE UPDATE PROCEDURE

### 1. Updating by USB

The latest firmware can be downloaded to a USB memory for updates.

#### 1.1. Connecting to the USB Memory

(1) Preparation

- USB format: Prepare a USB memory formatted in FAT16 or FAT32.
- Do not run the USB memory through a hub.
- Do not connect a computer to the USB port of this unit using a USB cable.
- Do not use an extension cable when connecting the USB unit.

#### 1.2. Unzip Download File

Unzip the downloaded file on your computer.

**AVR-XXXXXXX**      **USB\_AVR-XXXXXXX\_XXXXXXXXXXXX-XXXX.zip**

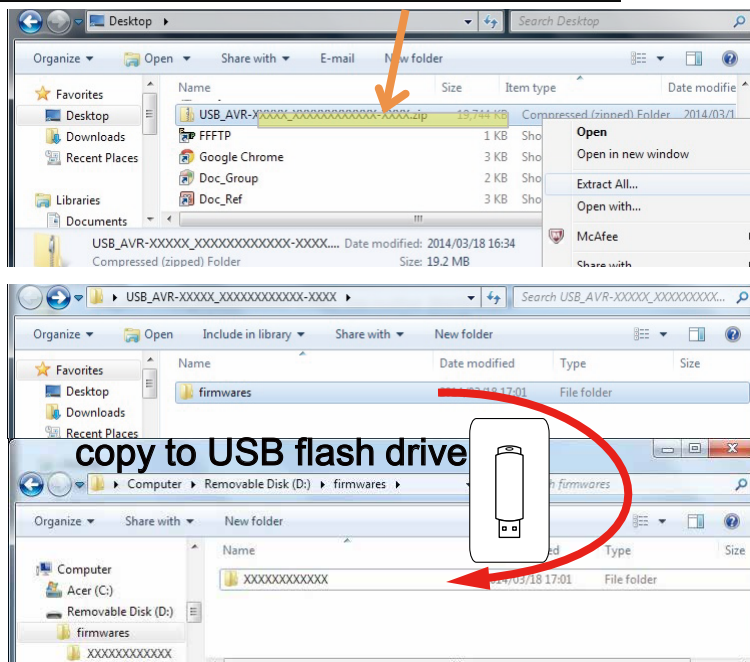

You can find "**firmwares**" folder after unzipped.

Copy that folder to USB flash drive.

You have to put "**firmwares**" folder on root directly on USB flash drive(memory).

### 1.3. File structure on USB Memory

Copy the update files to the USB memory with the following structure:

USB memory root

Model Name	Model Area	Product ID
AVR-X2100WE3	North America (E3)	000100680100
AVR-X2100WE2/E1	Europe (E2) / Asia (E1)	000100680200
AVR-X2100WE1C	China (E1C)	000100680500
AVR-X2100WK	Japan (JP)	000100680400
AVR-S900WE3	North America (E3)	000100680700

+ firmwares

- + 000100XXXXXX
  - + APLD.bin
  - + DSP.bin
  - + enc\_update.xml
  - + GUI.bin
  - + IMG.bcd
  - + MAIN.bin
  - + SBL.bcd
  - + SUB.bin
  - + VPLD.bin

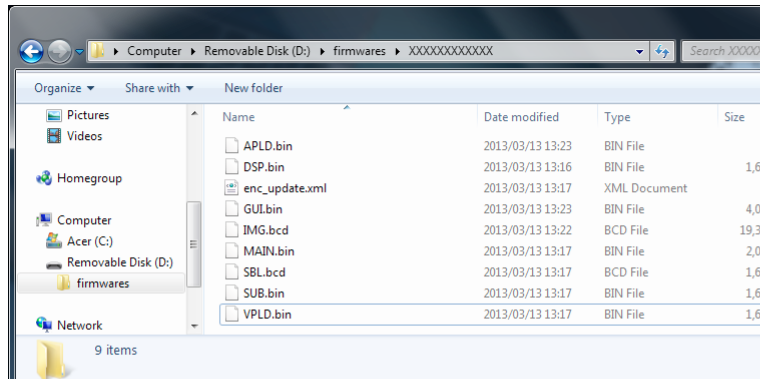

### 1.4. Insert the USB memory in the USB port.

NOTE : Remove the LAN cable from this unit when performing updates.

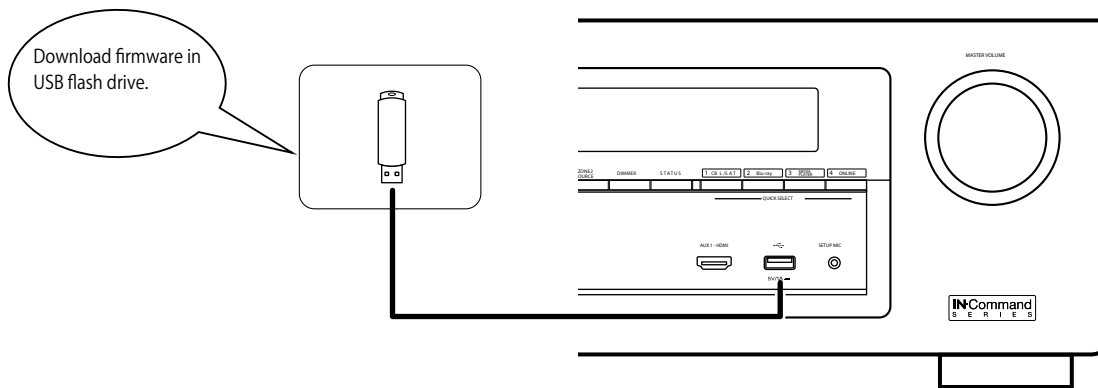

### 1.5. Start the update.

AVR-X2100W

·Hold down buttons "TUNER PRESET CH +" and "STATUS" at the same time and press the power button to turn on the power.

AVR-S900W

·Hold down buttons "ZONE2 SOURCE" and "TUNE +" at the same time and press the power button to turn on the power.

### 1.6. Display during USB update

The following message appears on the display after around 30 seconds

Display

FLD	U	S	B		U	P	d	a	t	e		S	t	a	r	t
-----	---	---	---	--	---	---	---	---	---	---	--	---	---	---	---	---

### 1.7. Press the "ENTER" key on the remote control unit or this unit.

Then start Firmware Update.

Display

FLD	U	P	d	a	t	e	F	i	l	e	C	h	e	c	k	
-----	---	---	---	---	---	---	---	---	---	---	---	---	---	---	---	--

### 1.8. The firmware update finishes.

The following message appears on the display:

Display

FLD	U	P	d	a	t	e		C	o	m	p	l	e	t	e	
-----	---	---	---	---	---	---	--	---	---	---	---	---	---	---	---	--

#### --- Precautions for Updates ---

- Never remove the USB memory before the update is finished.
  - Never turn off the power before an update is completed.
  - It takes around 1 hour to complete the update.
- Once an update is started, normal operations cannot be performed until it is completed. The GUI menu settings and image adjustment settings of this unit may be initialized. Take note of your settings beforehand and reconfigure them after the update.

### 1.9 Forced USB All Device Write Mode

#### 1.9.1. Actions

Mode used when this unit cannot be recovered.  
Forcibly switches this unit to USB update mode.

#### 1.9.2. Operations

AVR-X2100W

Press the "TUNER PRESET CH +" and "STATUS" buttons simultaneously while inserting the AC plug to turn the power on.

AVR-S900W

Press the "ZONE2 SOURCE" and "TUNE +" buttons simultaneously while inserting the AC plug to turn the power on.

#### 1.9.2. The firmware update finishes.

The update after the restart, all devices will be updated.

## 1.10.About the error code

See the table below for error codes and details of faults when the firmware is updated through USB memory.

Error Code	Details of Error code	Display	Coping strategies
01	Unable to detect USB.	ConnectionFailed01	Disconnect and connect the USB memory.
02	No FirmwareFile in USB.	FilesNotFound02	Make sure that the FirmwareFile is in the USB memory.
03	FirmwareFile in USB for unsupported Model name/area.	NotMatchFirmware03	Check the supported Model name/area for the FirmwareFile.
04	Failed to obtain individual Firmware information.	ConnectionFailed06	Start the USB Update again.
05	TimeOut while obtaining individual Firmware information.	ConnectionFailed07	Start the USB Update again.
06	Failed to obtain entire Firmware information.	ConnectionFailed04	Start the USB Update again.
07	TimeOut while obtaining entire Firmware information.	ConnectionFailed05	Start the USB Update again.
08	Error notification received while requesting FirmwareInfo.	ConnectionFailed08	This unit automatically retries several times. Wait until the FL display stops. If the FL display stops at the Error display, press and hold the "Power operation" button for five seconds.
09	TimeOut while obtaining Firmware information.	ConnectionFailed09	This unit automatically retries several times. Wait until the FL display stops. If the FL display stops at the Error display, press and hold the "Power operation" button for five seconds.
0A	Unable to detect USB for FirmwareDownload.	ConnectionFailed0A	Disconnect and connect the USB memory.
0B	No FirmwareFile for Firmware-Download.	FilesNotFound0B	Disconnect and connect the USB memory.
0D	Received value with invalid PackageVersion.	ConnectionFailed0D	This unit automatically retries several times. Wait until the FL display stops. If the FL display stops at the Error display, press and hold the "Power operation" button for five seconds.
10	No UpdatePacket received from CX870 (TimeOut).	UpdatingFailed10	This unit automatically retries several times. Wait until the FL display stops. If the FL display stops at the Error display, press and hold the "Power operation" button for five seconds.
11	Abnormal data in UpdatePacket received from CX870 (FormatError).	UpdatingFailed11	This unit automatically retries several times. Wait until the FL display stops. If the FL display stops at the Error display, press and hold the "Power operation" button for five seconds.
12	Abnormal data in UpdatePacket received from CX870 (Checksum-Error).	UpdatingFailed12	This unit automatically retries several times. Wait until the FL display stops. If the FL display stops at the Error display, press and hold the "Power operation" button for five seconds.

Error Code	Details of Error code	Display	Coping strategies
13	BlockErase failed before rewriting Main.	Erasing failed 13	This unit automatically retries several times. Wait until the FL display stops. If the FL display stops at the Error display, press and hold the "Power operation" button for five seconds.
14	BlockWrite failed while rewriting Main.	Updating failed 14	This unit automatically retries several times. Wait until the FL display stops. If the FL display stops at the Error display, press and hold the "Power operation" button for five seconds.
15	Error in Verify after rewriting Main (ChecksumError).	Update check failed 15	This unit automatically retries several times. Wait until the FL display stops. If the FL display stops at the Error display, press and hold the "Power operation" button for five seconds.
20	Unable to detect USB after SBLMode.	Connection failed 20	Disconnect and connect the USB memory.
21	No FirmwareFile in USB after SBLMode.	File not found 21	Disconnect and connect the USB memory.
22	FirmwareFile in USB after SBLMode for unsupported Model name/area.	Not match firm 22	Check the supported Model name/area for the FirmwareFile.
23	Failed to obtain entire Firmware information after SBLMode.	Connection failed 23	Disconnect and connect the USB memory.
24	TimeOut while obtaining entire Firmware information after SBLMode.	Connection failed 24	This unit automatically retries several times. Wait until the FL display stops. If the FL display stops at the Error display, press and hold the "Power operation" button for five seconds.
25	Failed to transit to SBLMode.	Connection failed 25	This unit automatically retries several times. Wait until the FL display stops. If the FL display stops at the Error display, press and hold the "Power operation" button for five seconds.
26	TimeOut in Download (writing to SDRAM) for FirmwareDownload.	Download failed 26	This unit automatically retries several times. Wait until the FL display stops. If the FL display stops at the Error display, press and hold the "Power operation" button for five seconds.
27	Failed to write to EEPROM after SBLMode.	Connection failed 27	This unit automatically retries several times. Wait until the FL display stops. If the FL display stops at the Error display, press and hold the "Power operation" button for five seconds.
36	Unable to detect USB.	Connection failed 36	This unit automatically retries several times. Wait until the FL display stops. If the FL display stops at the Error display, press and hold the "Power operation" button for five seconds.
37	No FirmwareFile in USB.	File not found 37	This unit automatically retries several times. Wait until the FL display stops. If the FL display stops at the Error display, press and hold the "Power operation" button for five seconds.
38	FirmwareFile in USB for unsupported Model name/area.	Not match firm 38	This unit automatically retries several times. Wait until the FL display stops. If the FL display stops at the Error display, press and hold the "Power operation" button for five seconds.

Error Code	Details of Error code	Display	Coping strategies
39	TimeOut in USBCheck.	ConnectionFail139	This unit automatically retries several times. Wait until the FL display stops. If the FL display stops at the Error display, press and hold the "Power operation" button for five seconds.
3A	Unable to detect USB for FirmwareDownload.	ConnectionFail13A	This unit automatically retries several times. Wait until the FL display stops. If the FL display stops at the Error display, press and hold the "Power operation" button for five seconds.
3B	No FirmwareFile for Firmware-Download.	FileNotFound3B	This unit automatically retries several times. Wait until the FL display stops. If the FL display stops at the Error display, press and hold the "Power operation" button for five seconds.
3F	Failed to transit to SBLMode.	ConnectionFail13F	This unit automatically retries several times. Wait until the FL display stops. If the FL display stops at the Error display, press and hold the "Power operation" button for five seconds.
50	Unable to detect USB.	ConnectionFail50	This unit automatically retries several times. Wait until the FL display stops. If the FL display stops at the Error display, press and hold the "Power operation" button for five seconds.
51	No FirmwareFile in USB.	FileNotFound51	This unit automatically retries several times. Wait until the FL display stops. If the FL display stops at the Error display, press and hold the "Power operation" button for five seconds.
52	FirmwareFile in USB for unsupported Model name/area.	NotMatchFW52	This unit automatically retries several times. Wait until the FL display stops. If the FL display stops at the Error display, press and hold the "Power operation" button for five seconds.
54	Error notification received while requesting FirmwareInfo.	UpdatingFail54	This unit automatically retries several times. Wait until the FL display stops. If the FL display stops at the Error display, press and hold the "Power operation" button for five seconds.
55	TimeOut while obtaining Firmware information.	UpdatingFail55	This unit automatically retries several times. Wait until the FL display stops. If the FL display stops at the Error display, press and hold the "Power operation" button for five seconds.
56	Unable to detect USB for FirmwareDownload.	ConnectionFail56	This unit automatically retries several times. Wait until the FL display stops. If the FL display stops at the Error display, press and hold the "Power operation" button for five seconds.
57	No FirmwareFile for Firmware-Download.	FileNotFound57	This unit automatically retries several times. Wait until the FL display stops. If the FL display stops at the Error display, press and hold the "Power operation" button for five seconds.
5A	Invalid DeviceID in response or no response from Sub for C command.	ConnectionFail5A	This unit automatically retries several times. Wait until the FL display stops. If the FL display stops at the Error display, press and hold the "Power operation" button for five seconds.
5B	NACK received in response or no response from Sub for L command.	UpdatingFail5B	This unit automatically retries several times. Wait until the FL display stops. If the FL display stops at the Error display, press and hold the "Power operation" button for five seconds.
5C	No UpdatePacket received from CX870 (TimeOut).	UpdatingFail5C	This unit automatically retries several times. Wait until the FL display stops. If the FL display stops at the Error display, press and hold the "Power operation" button for five seconds.

Error Code	Details of Error code	Display	Coping strategies
5D	Abnormal data in UpdatePacket received from CX870 (FormatError).	Update: n/a fail 5D	This unit automatically retries several times. Wait until the FL display stops. If the FL display stops at the Error display, press and hold the "Power operation" button for five seconds.
5E	Abnormal data in UpdatePacket received from CX870 (Checksum-Error).	Update: n/a fail 5E	This unit automatically retries several times. Wait until the FL display stops. If the FL display stops at the Error display, press and hold the "Power operation" button for five seconds.
5F	Abnormal data in UpdatePacket received from CX870 (Data-Length/DataNo).	Update: n/a fail 5F	This unit automatically retries several times. Wait until the FL display stops. If the FL display stops at the Error display, press and hold the "Power operation" button for five seconds.
60	NACK received in response or no response from Sub for P command.	Update: n/a fail 60	This unit automatically retries several times. Wait until the FL display stops. If the FL display stops at the Error display, press and hold the "Power operation" button for five seconds.
61	Mismatched CheckSum in response or no response from Sub for I command.	Update: n/a fail 61	This unit automatically retries several times. Wait until the FL display stops. If the FL display stops at the Error display, press and hold the "Power operation" button for five seconds.
62	Failed to start up Sub in PowerOn sequence during Update.	Update: n/a fail 62	This unit automatically retries several times. Wait until the FL display stops. If the FL display stops at the Error display, press and hold the "Power operation" button for five seconds.
63	Failed to transit to Application-Mode.	Update: n/a fail 63	This unit automatically retries several times. Wait until the FL display stops. If the FL display stops at the Error display, press and hold the "Power operation" button for five seconds.
64	Failed to transit to BootLoader-Mode.	Update: n/a fail 64	This unit automatically retries several times. Wait until the FL display stops. If the FL display stops at the Error display, press and hold the "Power operation" button for five seconds.
80	WriteEnableLatchBit not set in Read after issuing WREN command.	Update: n/a fail 80	This unit automatically retries several times. Wait until the FL display stops. If the FL display stops at the Error display, press and hold the "Power operation" button for five seconds.
81	BlockErase failed in Read after issuing BE command.	Update: n/a fail 81	This unit automatically retries several times. Wait until the FL display stops. If the FL display stops at the Error display, press and hold the "Power operation" button for five seconds.
82	No UpdatePacket received from CX870 (Timeout).	Update: n/a fail 82	This unit automatically retries several times. Wait until the FL display stops. If the FL display stops at the Error display, press and hold the "Power operation" button for five seconds.
83	Abnormal data in UpdatePacket received from CX870 (FormatError).	Update: n/a fail 83	This unit automatically retries several times. Wait until the FL display stops. If the FL display stops at the Error display, press and hold the "Power operation" button for five seconds.
84	Abnormal data in UpdatePacket received from CX870 (Checksum-Error).	Update: n/a fail 84	This unit automatically retries several times. Wait until the FL display stops. If the FL display stops at the Error display, press and hold the "Power operation" button for five seconds.
85	Abnormal data in UpdatePacket received from CX870 (Data-Length/DataNo).	Update: n/a fail 85	This unit automatically retries several times. Wait until the FL display stops. If the FL display stops at the Error display, press and hold the "Power operation" button for five seconds.

Error Code	Details of Error code	Display	Coping strategies
86	Mismatched CheckSum in CheckSum comparison after rewriting.	UpdateIno Fail 86	This unit automatically retries several times. Wait until the FL display stops. If the FL display stops at the Error display, press and hold the "Power operation" button for five seconds.
A2	Unable to detect USB.	Connection Fail A2	This unit automatically retries several times. Wait until the FL display stops. If the FL display stops at the Error display, press and hold the "Power operation" button for five seconds.
A3	No FirmwareFile in USB.	File Not Found A3	This unit automatically retries several times. Wait until the FL display stops. If the FL display stops at the Error display, press and hold the "Power operation" button for five seconds.
A4	FirmwareFile in USB for unsupported Model name/area.	Not Match Firm A4	This unit automatically retries several times. Wait until the FL display stops. If the FL display stops at the Error display, press and hold the "Power operation" button for five seconds.
A6	Error notification received while requesting FirmwareInfo.	UpdateIno Fail A6	This unit automatically retries several times. Wait until the FL display stops. If the FL display stops at the Error display, press and hold the "Power operation" button for five seconds.
A7	TimeOut while obtaining Firmware information.	UpdateIno Fail A7	This unit automatically retries several times. Wait until the FL display stops. If the FL display stops at the Error display, press and hold the "Power operation" button for five seconds.
AE	Unable to detect USB for FirmwareDownload.	Connection Fail AE	This unit automatically retries several times. Wait until the FL display stops. If the FL display stops at the Error display, press and hold the "Power operation" button for five seconds.
AF	No FirmwareFile for FirmwareDownload.	File Not Found AF	This unit automatically retries several times. Wait until the FL display stops. If the FL display stops at the Error display, press and hold the "Power operation" button for five seconds.
B1	TimeOut in Download (writing to SDRAM) for FirmwareDownload.	Download Fail B1	This unit automatically retries several times. Wait until the FL display stops. If the FL display stops at the Error display, press and hold the "Power operation" button for five seconds.
B2	Error notification received after rewriting CX870 Firm.	UpdateIno Fail B2	This unit automatically retries several times. Wait until the FL display stops. If the FL display stops at the Error display, press and hold the "Power operation" button for five seconds.
B3	Error in FirmwareUpdate (Time-Out).	UpdateIno Fail B3	This unit automatically retries several times. Wait until the FL display stops. If the FL display stops at the Error display, press and hold the "Power operation" button for five seconds.
B4	Failed to transit to BootLoader-Mode.	UpdateIno Fail B4	This unit automatically retries several times. Wait until the FL display stops. If the FL display stops at the Error display, press and hold the "Power operation" button for five seconds.
B5	Failed to transit to Application-Mode.	UpdateIno Fail B5	This unit automatically retries several times. Wait until the FL display stops. If the FL display stops at the Error display, press and hold the "Power operation" button for five seconds.

**---Check the firmware version after updating.---**

After updating the firmware, check the version. See "1. Version Display Mode" (21 page).



## 1.11. Device display during firmware update

Display of target device during firmware update.

Target device	Display	Error code when an error occurs
Main CPU	Main :***Z     ***min	08 - 0B 10 - 15 20 - 27 36 - 3B 3F
Sub	Sub :***Z     ***min	50 - 52 54 - 58 5A - 64
Audio PLD	APLD :***Z     ***min	50 - 52 54 - 58 5A - 64
VIDEO PLD	VPLD :***Z     ***min	50 - 52 54 - 58 5A - 64
DSP	DSP :***Z     ***min	50 - 52 54 - 58 5A - 64
GUI Serial Flash	GUI :***Z     ***min	50 - 52 54 - 58 5A 62 - 64 80 - 86
CX870 Boot Loader	ESBL :***Z     ***min	A0 - A4 A6 - A7 AE - B5
CX870 Image	EIMG :***Z     ***min	A0 - A4 A6 - A7 AE - B5
CX870 Image (Emergency Mode)	Update retry	-

### Checking the Firmware Version After an Update

After updating the firmware, check the version. See "1. Version Display Mode" (21 page).

## 2. Updating by DPMS

Download the latest firmware from the internet and update the firmware.

### 2.1. Network Connection

#### (1) System Requirements

- A broadband internet connection
- Modem
- Router
- Ethernet cable (CAT-5 or greater recommended)

#### (2) Settings

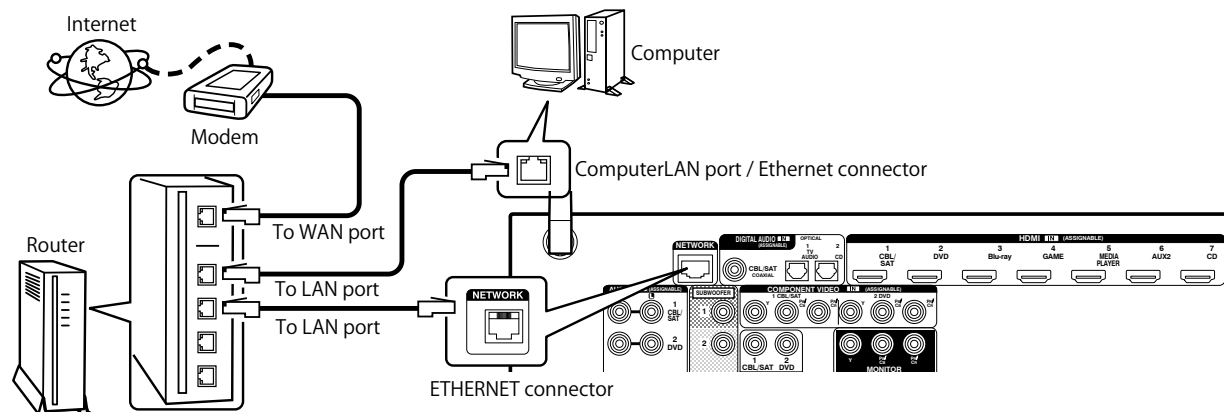

### 2.2. Check and update the firmware

Check whether new firmware is available. It is also possible to check approximately how long the update will take.

- (1) Press the button **"SETUP"** on the remote control to display the GUI menu.
- (2) Press the cursor button to select **"General"** → **"Firmware"** → **"Update"** → **"Check Update"**.
- (3) Press the button **"ENTER"**.
  - The latest firmware version uploaded to our website is displayed.
  - Proceed to (4) if new firmware is available on our website.
  - If the latest firmware is already installed, press the button **"SETUP"** to exit the menu.
- (4) Select **"Start"** using the cursor buttons and then press **"ENTER"**.
  - The power display lights in red and the GUI screen display disappears during the update. The remaining time of the update is shown on the display of the unit.
  - The normal status resumes after the update is completed.

#### --- Precautions for Updates ---

- The environment and settings must allow connection to broadband Internet for updates.
- Never turn off the power before an update is completed.
- It takes around 1 hour to complete the update.

Once an update is started, normal operations cannot be performed until it is completed.

The GUI menu settings and image adjustment settings of this unit may be initialized.

Take note of your settings beforehand and reconfigure them after the update.

### 2.3. About the error code

See the following table for details on the error code, details of the error code, display and coping strategies when updating the firmware from DPMS. (DPMS:Denon Product Management Server).

Error Code	Details of Error code	Display	Coping strategies
01	Failed to log in to DPMS.	Login failed 01	Initialize the unit and try updating again. Update in an environment where there is a small network load.
02	Line etc. is congested when logging in to DPMS.	Server is busy 02	Update in an environment where there is a small network load.
03	Connection to DPMS failed.	ConnectionFailed 03	Check the network connection. Update in an environment where there is a small network load.
04	Firmware file data was requested but error message was received.	ConnectionFailed 04	Check the network connection. Update in an environment where there is a small network load.
05	Firmware file data was requested but it timed out.	ConnectionFailed 05	Check the network connection. Update in an environment where there is a small network load.
06	Firmware file data was requested but error message was received.	ConnectionFailed 06	Check the network connection. Update in an environment where there is a small network load.
07	All firmware file information was requested but a timeout occurred.	ConnectionFailed 07	Check the network connection. Update in an environment where there is a small network load.
08	Main CPU firmware file information was requested but error message was received.	ConnectionFailed 08	Check the network connection. Update in an environment where there is a small network load.
09	Main CPU firmware file information was requested but error message was received.	ConnectionFailed 09	Check the network connection. Update in an environment where there is a small network load.
0A	Error (NG) message was received when firmware of Main CPU was downloaded.	Download failed 0A	Check the network connection. Update in an environment where there is a small network load.
0B	Error (line congestion) message was received when firmware of Main CPU was downloaded.	Download failed 0B	Check the network connection. Update in an environment where there is a small network load.
0C	Error (connection failure) message was received when firmware of Main CPU was downloaded.	Download failed 0C	Check the network connection. Update in an environment where there is a small network load.
0D	Received an invalid package version.	Download failed 0D	Check the network connection. Update in an environment where there is a small network load.
0E	Connection to DPMS failed. (Cannot get NTP)	ConnectionFailed 0E	Check the network connection. Update in an environment where there is a small network load.
10	Main CPU failed to receive firmware for rewriting sent from CX870 (when timed out).	Updating failed 10	Turn on the power again. Update will start automatically.

Error Code	Details of Error code	Display	Coping strategies
11	Main CPU failed to receive firmware for rewriting sent from CX870 (when an error occurred).	U p d a t i n g f a i l 1 1	Turn on the power again. Update will start automatically.
12	Firmware for rewriting sent from CX870 received by the Main CPU contained corrupt data (when the Check Sum error occurred).	U p d a t i n g f a i l 1 1 2	Turn on the power again. Update will start automatically.
13	The erasing of block data failed before Main CPU was rewritten.	E r a s e f a i l 1 3	Turn on the power again. Update will start automatically.
14	The rewriting of block data failed when Main CPU was rewritten.	U p d a t i n g f a i l 1 1 4	Turn on the power again. Update will start automatically.
15	Data was found to be corrupt during verification after the Main CPU was rewritten.	U p d a t e C h e c k i n g 1 5	Turn on the power again. Update will start automatically.
20	Failed to acquire the IP address before CX870 rewrite (Boot Loader Mode). (Auto IP)	C o n n e c t i o n F a i l 1 2 0	Check the network connection. Update in an environment where there is a small network load.
21	Failed to acquire the IP address before CX870 rewrite (Boot Loader Mode). (when timed out)	C o n n e c t i o n F a i l 1 2 1	Check the network connection. Update in an environment where there is a small network load.
22	Failed to log in to DPMS.	L o g i n f a i l e d 2 2	Initialize the unit and try updating again. Update in an environment where there is a small network load.
23	Line etc. is congested when logging in to DPMS.	S e r v e r i s b u s y 2 3	Update in an environment where there is a small network load.
24	Connection to DPMS failed.	C o n n e c t i o n F a i l 1 2 4	Check the network connection. Update in an environment where there is a small network load.
25	Failed to change the CX870 mode.	C o n n e c t i o n F a i l 1 2 5	Initialize the unit and try updating again.
26	Timeout occurred obtaining data when downloading the Main CPU firmware. Received an invalid package version. Received an invalid package version.	D o w n l o a d f a i l 2 6	Check the network connection. Update in an environment where there is a small network load.
27	Failed to change the CX870 mode.	D o w n l o a d f a i l 2 7	Initialize the unit and try updating again.
36	Log in to DPMS failed when rewriting the Main CPU.	L o g i n f a i l e d 3 6	Update in an environment where there is a small network load.
37	Unit logs in to DPMS but the line etc. is congested when rewriting the Main CPU.	S e r v e r i s b u s y 3 7	Update in an environment where there is a small network load.
38	Connect to DPMS failed when rewriting the Main CPU.	C o n n e c t i o n F a i l 1 3 8	Check the network connection. Update in an environment where there is a small network load.

Error Code	Details of Error code	Display	Coping strategies
39	Connection to DPMS has timed out when rewriting the Main CPU.	ConnectionFailed39	Check the network connection. Update in an environment where there is a small network load.
3A	Error (NG) notification was received when downloading firmware for rewriting the Main CPU.	DownloadFailed3A	Turn on the power again. Update will start automatically. Update in an environment where there is a small network load.
3B	Error notification (line congestion) was received when downloading firmware for rewriting the Main CPU.	DownloadFailed3B	Turn on the power again. Update will start automatically. Update in an environment where there is a small network load.
3C	Error notification (connection failure) was received when downloading firmware for rewriting the Main CPU.	DownloadFailed3C	Turn on the power again. Update will start automatically. Update in an environment where there is a small network load.
3D	Failed to acquire the IP address (Auto IP) before CX870 rewrite (Boot Loader Mode).	ConnectionFailed3D	Check the network connection. Update in an environment where there is a small network load.
3E	Failed to acquire the IP address before CX870 rewrite (Boot Loader Mode) (timed out).	ConnectionFailed3E	Check the network connection. Update in an environment where there is a small network load.
50	Log in to DPMS failed when rewriting the DSP, PLD etc. firmware.	LoginFailed50	Update in an environment where there is a small network load.
51	Unit logs in to DPMS to rewrite the DSP, PLD etc. firmware, but the line etc. is congested.	ServerIsBusy51	Update in an environment where there is a small network load.
52	Connect to DPMS failed when rewriting the DSP, PLD etc. firmware.	ConnectionFailed52	Check the network connection. Update in an environment where there is a small network load.
54	Unit logs in to DPMS to rewrite the DSP, PLD etc. firmware, but error was received as firmware information.	UpdateInfoFailed54	Turn on the power again. Update will start automatically. Update in an environment where there is a small network load.
55	Unit logs in to DPMS to rewrite the DSP, PLD etc. firmware, but logged into DPMS and requested firmware data information but a timeout occurred.	UpdateInfoFailed55	Turn on the power again. Update will start automatically. Update in an environment where there is a small network load.
56	Unit logs in to DPMS to rewrite the DSP, DLP etc. firmware, but failed to download the firmware.	DownloadFailed56	Turn on the power again. Update will start automatically. Update in an environment where there is a small network load.
57	Unit logs in to DPMS to rewrite the DSP, DLP etc. firmware, but download firmware error was received (line congestion).	DownloadFailed57	Turn on the power again. Update will start automatically. Update in an environment where there is a small network load.
58	Unit logs in to DPMS to rewrite the DSP, DLP etc. firmware, but download firmware error was received (connection failure).	DownloadFailed58	Turn on the power again. Update will start automatically. Update in an environment where there is a small network load.
5A	NACK was received when "C" command was sent to DSP, PLD etc.	ConnectionFailed5A	Turn on the power again. Update will start automatically.
5B	NACK was received when "L" command was sent to DSP, PLD etc.	UpdateInfoFailed5B	Turn on the power again. Update will start automatically.

Error Code	Details of Error code	Display	Coping strategies
5C	DSP, PLD etc. failed to receive the firmware for rewriting sent from CX870 (when timed out).	U p d a t e i n s u c c e s s f u l 5 C	Turn on the power again. Update will start automatically.
5D	DSP, PLD etc. failed to receive the firmware for rewriting sent from CX870 (when an error occurred).	U p d a t e i n s u c c e s s f u l 5 D	Turn on the power again. Update will start automatically.
5E	DSP, PLD etc. receive the corrupted firmware data for rewriting sent from CX870 (when the Check Sum error occurred).	U p d a t e i n s u c c e s s f u l 5 E	Turn on the power again. Update will start automatically.
5F	DSP, PLD etc. receive the corrupted firmware data for rewriting sent from CX870 (invalid data was received).	U p d a t e i n s u c c e s s f u l 5 F	Turn on the power again. Update will start automatically.
60	NACK was received when "P" command was sent to DSP, PLD etc.	U p d a t e i n s u c c e s s f u l 6 0	Turn on the power again. Update will start automatically.
61	NACK was received when "I" command was sent to DSP, PLD etc.	U p d a t e i n s u c c e s s f u l 6 1	Turn on the power again. Update will start automatically.
80	Failed to obtain flash information before erasing the flash.	U p d a t e i n s u c c e s s f u l 8 0	Turn on the power again. Update will start automatically.
81	Failed to erase the data before rewriting the flash.	U p d a t e i n s u c c e s s f u l 8 1	Turn on the power again. Update will start automatically.
82	Failed to receive the serial flash firmware for rewriting sent from CX870 (when timed out).	U p d a t e i n s u c c e s s f u l 8 2	Turn on the power again. Update will start automatically.
83	Failed to receive the serial flash firmware for rewriting sent from CX870 (when an error occurred).	U p d a t e i n s u c c e s s f u l 8 3	Turn on the power again. Update will start automatically.
84	Failed to receive the serial flash firmware for rewriting sent from CX870 (when the Check Sum error occurred).	U p d a t e i n s u c c e s s f u l 8 4	Turn on the power again. Update will start automatically.
85	Failed to receive the the serial flash firmware for rewriting sent from CX870 (invalid data was received).	U p d a t e i n s u c c e s s f u l 8 5	Turn on the power again. Update will start automatically.
86	Data was found to be corrupt during verification after the flash was rewritten.	U p d a t e i n s u c c e s s f u l 8 6	Turn on the power again. Update will start automatically.
A0	Failed to acquire the IP address (AutoIP) before CX870 rewrite (Application Mode).	C o n n e c t i o n s f e w i l a 0	Check the network connection. Update in an environment where there is a small network load.
A1	Failed to acquire the IP address before CX870 rewrite (Application Mode) (whern timed out).	C o n n e c t i o n s f e w i l a 1	Check the network connection. Update in an environment where there is a small network load.
A2	Unauthorized login DPMS access notification was received when rewriting the CX870 related firmware (Application Mode).	L o g i n f a i l e d A 2	Check the network connection. Update in an environment where there is a small network load.

Error Code	Details of Error code	Display	Coping strategies
A3	Notified that the access to the DPMS is congested line, when rewriting the CX870 system (Application Mode).	S E R V E R I S B U S Y A 3	Check the network connection. Update in an environment where there is a small network load.
A4	Notified that the access to the DPMS connection is failed, when rewriting the CX870 system (Application Mode).	C O N N E C T I O N F A I L A 4	Check the network connection. Update in an environment where there is a small network load.
A6	Logged into DPMS and error was received as firmware information, when rewriting the CX870 system (Application Mode).	U P D A T I N G F A I L A 6	Turn on the power again. Update will start automatically. Update in an environment where there is a small network load.
A7	Logged into DPMS and requested firmware data information but a timeout occurred when when rewriting the CX870 system (Application Mode).	U P D A T I N G F A I L A 7	Turn on the power again. Update will start automatically. Update in an environment where there is a small network load.
AE	Error notification was received when downloading firmware for rewriting the CX870 system (when failed to download).	D O W N L O A D F A I L A E	Turn on the power again. Update will start automatically. Update in an environment where there is a small network load.
AF	Error notification was received when downloading firmware for rewriting the CX870 system (Boot Loader Mode) (line congestion).	D O W N L O A D F A I L A F	Turn on the power again. Update will start automatically. Update in an environment where there is a small network load.
B0	Error notification was received when downloading firmware for rewriting the CX870 system (Boot Loader Mode) (When a connection failed).	D O W N L O A D F A I L B 0	Turn on the power again. Update will start automatically. Update in an environment where there is a small network load.
B1	Firmware downloading error notification was received (Timeout failure).	D O W N L O A D F A I L B 1	Turn on the power again. Update will start automatically. Update in an environment where there is a small network load.
B2	Error notification was received when rewriting the CX870 system firmware.	D O W N L O A D F A I L B 2	Turn on the power again. Update will start automatically. Update in an environment where there is a small network load.
B3	Notification is failed to rewriting the firmware (Timeout failure).	U P D A T I N G F A I L B 3	Turn on the power again. Update will start automatically. Update in an environment where there is a small network load.
B4	Failed to change the CX870 system mode. (Boot Loader Mode)	U P D A T I N G F A I L B 4	Initialize the unit and try updating again.
B5	Failed to change the CX870 system mode. (Application Mode)	U P D A T I N G F A I L B 5	Initialize the unit and try updating again.

**Device display during firmware update**  
 Display of target device during firmware update.

Target device	Display	Error code when an error occurs
Main	Main:***%    ***min	08 - 0C 10 - 15 22 - 24 36 - 3E
Sub	Sub:***%    ***min	50 - 52 54 - 58 5A - 64
Audio PLD	APLD:***%    ***min	50 - 52 54 - 58 5A - 61
VIDEO PLD	VPLD:***%    ***min	50 - 52 54 - 58 5A - 64
DSP	DSP:***%    ***min	50 - 52 54 - 58 5A - 61
GUI Serial Flash	GUI:***%    ***min	50 - 52 54 - 58 5A - 61 80 - 86
CX870 Boot Loader	ESBL:***%    ***min	A0 - A4 A6 - A7 AE - B5
CX870 Image	EIMG:***%    ***min	A0 - A4 A6 - A7 AE - B5
CX870 Image (Emergency Mode)	Update retry	-

**Checking the Firmware Version After an Update**

After updating the firmware, check the version.

See "1. Version Display Mode" ( [21 page](#) ).



# ADJUSTMENT

## Adjusting Idling Current

### 1. Preparation

- (1) Prepare a DV voltmeter.
- (2) Place the unit in normal usage conditions, away from highly ventilated areas such as next to an air conditioning machine or electric fan.  
The set requires an ambient temperature of 15°C to 30°C and standard humidity.
- (3) Settings of This Unit
  - POWER (Power source switch) STANDBY
  - SPEAKER (Speaker terminal) No load( Do not connect equipment such as speakers or dummy resistors. )

### 2. Adjustment Procedure

- (1) Remove the top cover and turn VR401, VR402, VR403, VR404, VR405, VR406 and VR407 of the 7CH AMP UNIT as far anticlockwise(↺) as possible.
- (2) Connect the DC Voltmeter test points.  
FRONT-Lch : TP401  
FRONT-Rch : TP402  
CENTER ch : TP403  
SURROUND-Lch : TP404  
SURROUND-Rch : TP405  
SURROUND-BACK Lch : TP406  
SURROUND-BACK Rch : TP407
- (3) Connect the power cord to an outlet. Next, press the power button to turn on the power.
- (4) Set this unit as follows.  
MASTER VOLUME : "---" anticlockwise (↺ min.)  
SPEAKER (Speaker terminal) : No load  
( Do not connect equipment such as speakers or dummy resistors. )  
MODE : MCH STEREO  
FUNCTION : DVD
- (5) Turn VR401 clockwise (↻) and adjust the voltage of the test point to "**6.0mV ± 0.5mV DC**" within 2 minutes.
- (6) 10 minutes after the preliminary adjustment, turn VR401 and set the voltage as "**8.0mV ± 0.5mV DC**".
- (7) Adjust the variable resistance of each channel using the same method.



AMP UNIT

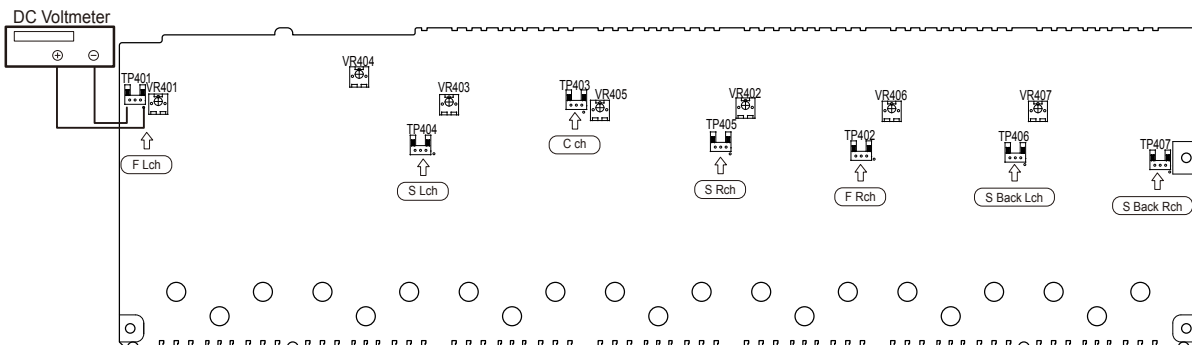

# SURROUND MODES AND PARAMETERS

## Sound modes and channel output

- This indicates the audio output channels or surround parameters that can be set.
- ⊙ This indicates the audio output channels. The output channels depend on the settings of "Speaker Config." (☞ p. 183).

Sound mode (☞ p. 115)	Channel output					
	Front L/R	Center	Surround L/R	Surround back L/R	Front height L/R	Subwoofer
Direct/Pure Direct (2-channel)	○					⊙*3
Direct/Pure Direct (Multi-channel)	○	⊙	⊙	⊙*1	⊙*1	⊙
Stereo	○					⊙
Multi Ch In	○	⊙	⊙	⊙*1		⊙
Dolby Pro Logic IIz	○	⊙	⊙		⊙	⊙
Dolby Pro Logic IIx	○	⊙	⊙	⊙		⊙
Dolby Pro Logic II	○	⊙	⊙			⊙
DTS Neo:6	○	⊙	⊙	⊙		⊙
Dolby Digital	○	⊙	⊙		⊙*2	⊙
Dolby Digital Plus	○	⊙	⊙	⊙*1	⊙*1	⊙
Dolby TrueHD	○	⊙	⊙	⊙*1	⊙*1	⊙
DTS Surround	○	⊙	⊙	⊙	⊙*2	⊙
DTS 96/24	○	⊙	⊙	⊙	⊙*2	⊙
DTS-HD	○	⊙	⊙	⊙*1	⊙*1	⊙
DTS Express	○	⊙	⊙	⊙	⊙*2	⊙
Multi Ch Stereo	○	⊙	⊙	⊙	⊙	⊙
Rock Arena	○	⊙	⊙	⊙	⊙	⊙
Jazz Club	○	⊙	⊙	⊙	⊙	⊙
Mono Movie	○	⊙	⊙	⊙	⊙	⊙
Video Game	○	⊙	⊙	⊙	⊙	⊙
Matrix	○	⊙	⊙	⊙	⊙	⊙
Virtual	○					⊙

- \*1 A signal for each channel contained in an input signal is output as audio.
- \*2 Audio is output when the set sound mode name contains "+PLIIz".
- \*3 Audio is output when "Subwoofer Mode" in the menu is set to "LFE+Main". (☞ p. 188)

## Sound modes and surround parameters

Sound mode (☞ p. 115)	Surround Parameter (☞ p. 146)									
	Dialog Level Adjust (☞ p. 145)	Subwoofer Level Adjust (☞ p. 145)	Cinema EQ (☞ p. 146)	Loudness Management *1 (☞ p. 146)	Dynamic Compression *2 (☞ p. 147)	Low Frequency Effects *3 (☞ p. 147)	Delay Time (☞ p. 148)	Effect Level (☞ p. 148)	Room Size (☞ p. 149)	Height Gain *4 (☞ p. 149)
Direct/Pure Direct (2-channel) *5		○*6		○	○					
Direct/Pure Direct (Multi-channel) *5	○	○		○	○					
Stereo		○		○	○	○				
Multi Ch In	○	○	○			○				○
Dolby Pro Logic IIz	○	○	○	○	○					○
Dolby Pro Logic IIx	○	○	○	○	○					
Dolby Pro Logic II	○	○	○	○	○					
DTS Neo:6	○	○	○	○	○					
Dolby Digital	○	○	○		○	○				○
Dolby Digital Plus	○	○	○		○	○				○
Dolby TrueHD	○	○	○	○	○	○				○
DTS Surround	○	○	○		○	○				○
DTS 96/24	○	○	○			○				○
DTS-HD	○	○	○			○				○
DTS Express	○	○	○			○				○
Multi Ch Stereo	○	○	○	○	○	○				
Rock Arena	○	○		○	○	○	○	○		
Jazz Club	○	○		○	○	○		○	○	
Mono Movie	○	○		○	○	○		○	○	
Video Game	○	○		○	○	○		○	○	
Matrix	○	○		○	○	○				
Virtual		○		○	○	○	○			

\*1 - \*6 : "Sound modes and surround parameters" (☞ p. 240)

Sound mode (☞ p. 115)	Surround Parameter (☞ p. 146)				Tone Control *7 (☞ p. 111)	Audyssey (☞ p. 152)			Restorer *10 (☞ p. 150)
	Pro LogicII/IIX Music mode only			Neo: 6 Music modes only		MultEQ® XT *8 (☞ p. 152)	Dynamic EQ *9 (☞ p. 153)	Dynamic Volume *9 (☞ p. 154)	
	Panorama (☞ p. 147)	Dimension (☞ p. 148)	Center Width (☞ p. 148)	Center Image (☞ p. 147)					
Direct/Pure Direct (2-channel) *5									
Direct/Pure Direct (Multi-channel) *5									
Stereo						<input type="radio"/>	<input type="radio"/>	<input type="radio"/>	<input type="radio"/>
Multi Ch In					<input type="radio"/>	<input type="radio"/>	<input type="radio"/>	<input type="radio"/>	<input type="radio"/>
Dolby Pro Logic IIz					<input type="radio"/>	<input type="radio"/>	<input type="radio"/>	<input type="radio"/>	<input type="radio"/>
Dolby Pro Logic IIX	<input type="radio"/>	<input type="radio"/>	<input type="radio"/>		<input type="radio"/>	<input type="radio"/>	<input type="radio"/>	<input type="radio"/>	<input type="radio"/>
Dolby Pro Logic II	<input type="radio"/>	<input type="radio"/>	<input type="radio"/>		<input type="radio"/>	<input type="radio"/>	<input type="radio"/>	<input type="radio"/>	<input type="radio"/>
DTS Neo:6				<input type="radio"/>	<input type="radio"/>	<input type="radio"/>	<input type="radio"/>	<input type="radio"/>	<input type="radio"/>
Dolby Digital					<input type="radio"/>	<input type="radio"/>	<input type="radio"/>	<input type="radio"/>	<input type="radio"/>
Dolby Digital Plus					<input type="radio"/>	<input type="radio"/>	<input type="radio"/>	<input type="radio"/>	<input type="radio"/>
Dolby TrueHD					<input type="radio"/>	<input type="radio"/>	<input type="radio"/>	<input type="radio"/>	<input type="radio"/>
DTS Surround					<input type="radio"/>	<input type="radio"/>	<input type="radio"/>	<input type="radio"/>	<input type="radio"/>
DTS 96/24					<input type="radio"/>	<input type="radio"/>	<input type="radio"/>	<input type="radio"/>	<input type="radio"/>
DTS-HD					<input type="radio"/>	<input type="radio"/>	<input type="radio"/>	<input type="radio"/>	<input type="radio"/>
DTS Express					<input type="radio"/>	<input type="radio"/>	<input type="radio"/>	<input type="radio"/>	<input type="radio"/>
Multi Ch Stereo					<input type="radio"/>	<input type="radio"/>	<input type="radio"/>	<input type="radio"/>	<input type="radio"/>
Rock Arena					<input type="radio"/> *11	<input type="radio"/>	<input type="radio"/>	<input type="radio"/>	<input type="radio"/>
Jazz Club					<input type="radio"/>	<input type="radio"/>	<input type="radio"/>	<input type="radio"/>	<input type="radio"/>
Mono Movie					<input type="radio"/>	<input type="radio"/>	<input type="radio"/>	<input type="radio"/>	<input type="radio"/>
Video Game					<input type="radio"/>	<input type="radio"/>	<input type="radio"/>	<input type="radio"/>	<input type="radio"/>
Matrix					<input type="radio"/>	<input type="radio"/>	<input type="radio"/>	<input type="radio"/>	<input type="radio"/>
Virtual					<input type="radio"/>	<input type="radio"/>	<input type="radio"/>	<input type="radio"/>	<input type="radio"/>

\*5, \*7 - \*11: "Sound modes and surround parameters" (☞ p. 240)

- \*1 This item can be selected when a Dolby TrueHD signal is played.
- \*2 This item can be selected when Dolby TrueHD, Dolby Digital or DTS signal is played.
- \*3 This item can be selected when a Dolby Digital or DTS signal or DVD-Audio is played.
- \*4 This setting is available when the set sound mode name contains "+PLIIz".
- \*5 During playback in Pure Direct mode, the surround parameters are the same as in Direct mode.
- \*6 This setting is available when "Subwoofer Mode" in the menu is set to "LFE+Main". (☞ p. 188)
- \*7 This item cannot be set when "Dynamic EQ" is set to "On". (☞ p. 153)
- \*8 This item cannot be set when Audyssey® Setup (Speaker Calibration) has not been performed.
- \*9 This item cannot be set when "MultEQ® XT" is set to "Off". (☞ p. 152)
- \*10 This item can be set when the input signal is analog, PCM 48 kHz or 44.1 kHz.
- \*11 In this sound mode, bass is +6 dB, and treble is +4 dB. (Default)

# Types of input signals, and corresponding sound modes

- This indicates the default sound mode.
- This indicates the selectable sound mode.

Sound mode (☞ p. 115)	NOTE	2-channel signal				Multi-channel signal							
		Analog /PCM	Dolby Digital (+/HD)/DTS (-HD)	PCM Multi	DTS-HD	DTS Express	DTS ES DSCRT 6.1	DTS ES MTRIX 6.1	DTS	Dolby TrueHD	Dolby Digital Plus	Dolby Digital EX	Dolby Digital
<b>DTS Surround</b>													
DTS-HD Mstr					●*6								
DTS-HD Hi Res					●*7								
DTS ES Dscrt6.1	*1						●						
DTS ES Mtr6.1	*1							●					
DTS Surround									●				
DTS 96/24									●				
DTS (-HD) + PLIIx	*1*2				○	○			○				
DTS (-HD) + PLIIz	*3				○	○	○	○	○				
DTS Express						●							
DTS Neo:6	*4	○	○										
<b>Dolby Surround</b>													
Dolby TrueHD										●			
Dolby Digital+											●		
Dolby Digital EX	*1											○	○
Dolby (D+) (HD) + EX	*1									○	○		
Dolby Digital												●	●
Dolby (D) (D+) (HD) + PLIIx	*1*2									○	○	○	○
Dolby (D) (D+) (HD) + PLIIz	*3									○	○	○	○
Dolby Pro Logic II/IIx	*5	○	○										
Dolby Pro Logic IIz	*3	○	○										

\*1 - \*8 : "Types of input signals, and corresponding sound modes" (☞ p. 243)

Sound mode (☞ p. 115)	NOTE	2-channel signal				Multi-channel signal							
		Analog /PCM	Dolby Digital (+/HD)/DTS (-HD)	PCM Multi	DTS-HD	DTS Express	DTS ES DSCRT 6.1	DTS ES MTRIX 6.1	DTS	Dolby TrueHD	Dolby Digital Plus	Dolby Digital EX	Dolby Digital
<b>Multi Ch In</b>													
Multi Ch In				●									
Multi Ch In + Dolby EX	*1			○									
Multi Ch In + PLIIx	*1*2			○									
Multi Ch In + PLIIz	*3			○									
Multi Ch In 7.1	*1			●*10									
<b>Direct</b>													
Direct		○*9	○	○	○	○	○	○	○	○	○	○	○
<b>Pure Direct</b>													
Pure Direct		○	○	○	○	○	○	○	○	○	○	○	○
<b>Original sound mode</b>													
Multi Ch Stereo		○	○	○	○	○	○	○	○	○	○	○	○
Rock Arena		○	○	○	○	○	○	○	○	○	○	○	○
Jazz Club		○	○	○	○	○	○	○	○	○	○	○	○
Mono Movie		○	○	○	○	○	○	○	○	○	○	○	○
Video Game		○	○	○	○	○	○	○	○	○	○	○	○
Matrix		○	○	○	○	○	○	○	○	○	○	○	○
Virtual		○	○	○	○	○	○	○	○	○	○	○	○
<b>Stereo</b>													
Stereo		●	○	○	○	○	○	○	○	○	○	○	○

\*1 - \*3, \*9, \*10 : "Types of input signals, and corresponding sound modes" (☞ p. 243)

- \*1 This item can be selected when surround back speakers are used.
- \*2 The "Cinema" mode or "Music" mode can be selected. When using a single surround back speaker, the "Music" mode is used.
- \*3 This item can be selected when front height speakers are used.
- \*4 The "Cinema" mode or "Music" mode can be selected.
- \*5 The "Cinema" mode, "Music" mode or "Game" mode can be selected.
- \*6 This item can be selected when the input signal is DTS-HD Master Audio.
- \*7 This item can be selected when the input signal is DTS-HD Hi Resolution.
- \*8 This item can be selected when the input signal is DTS 96/24.
- \*9 The default sound mode for the AirPlay playback is Direct.
- \*10 This item can be selected when the input signals contain surround back signals.

# TROUBLE SHOOTING

## 1. POWER

### 1.1. The unit does not power on

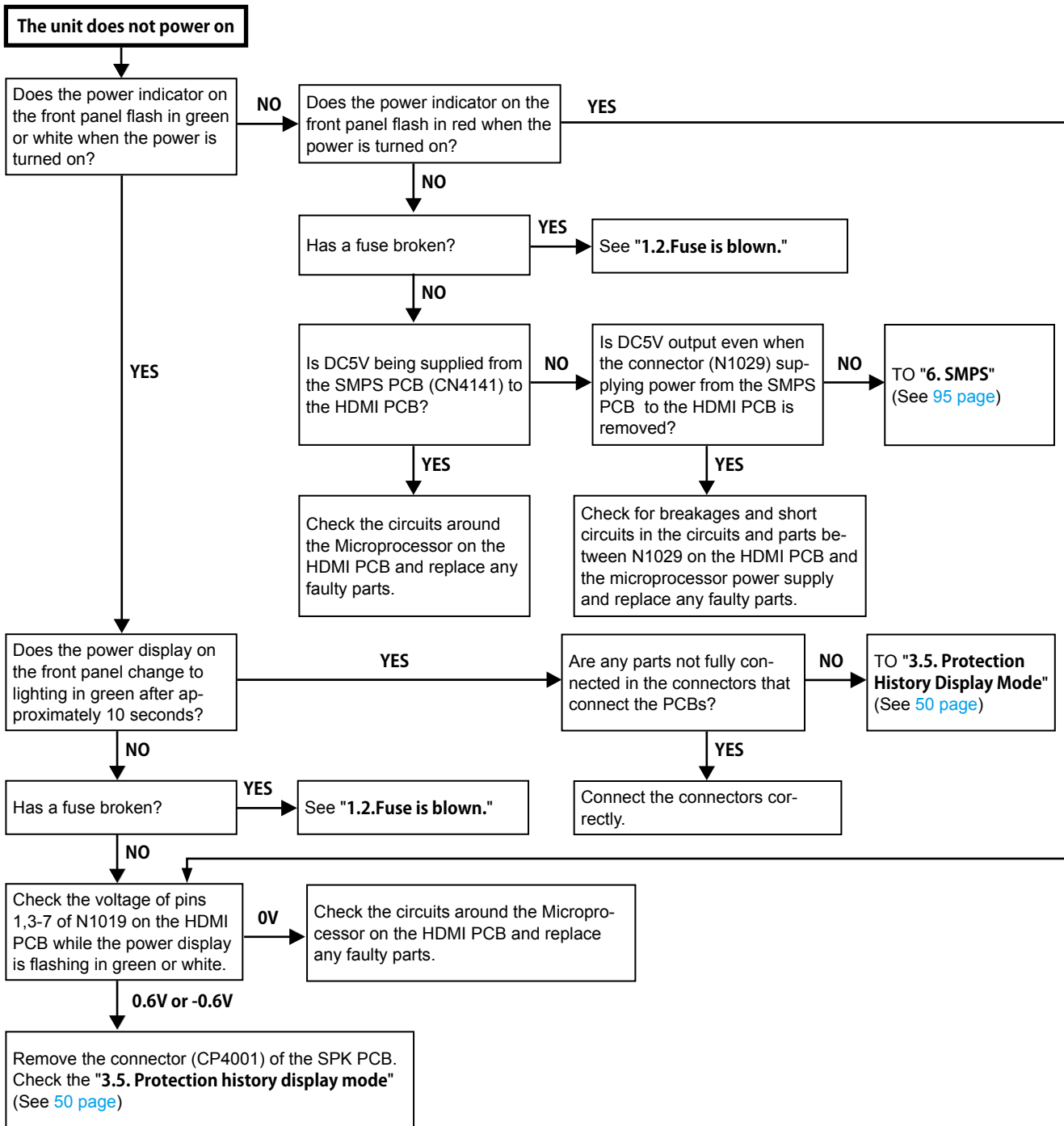

### 1.2. Fuse is blown

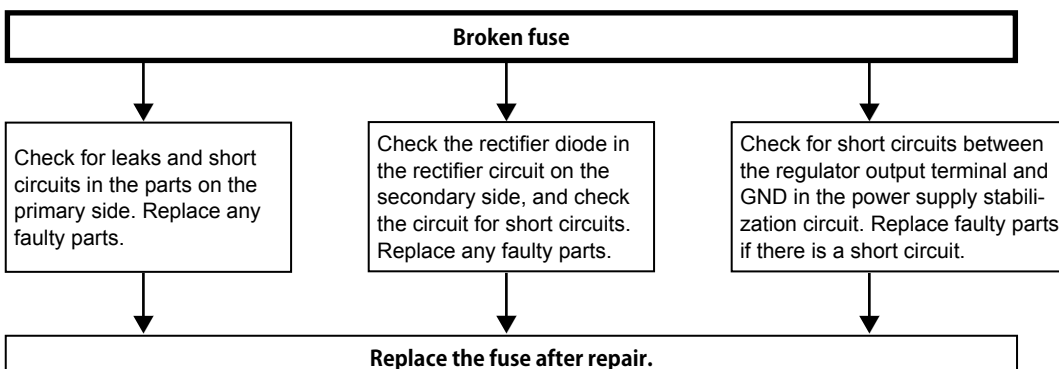

## 2. Analog video

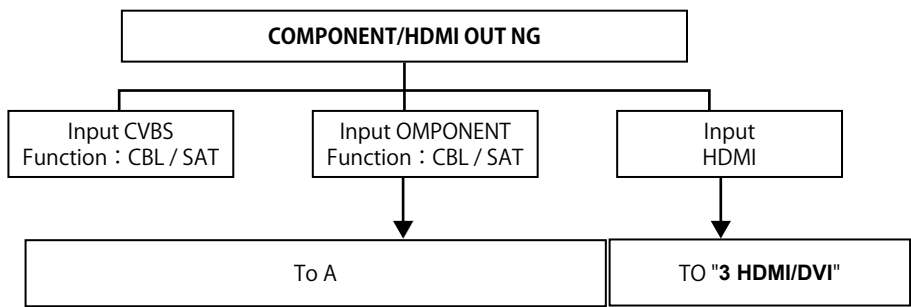

### <HDMI PCB> test point

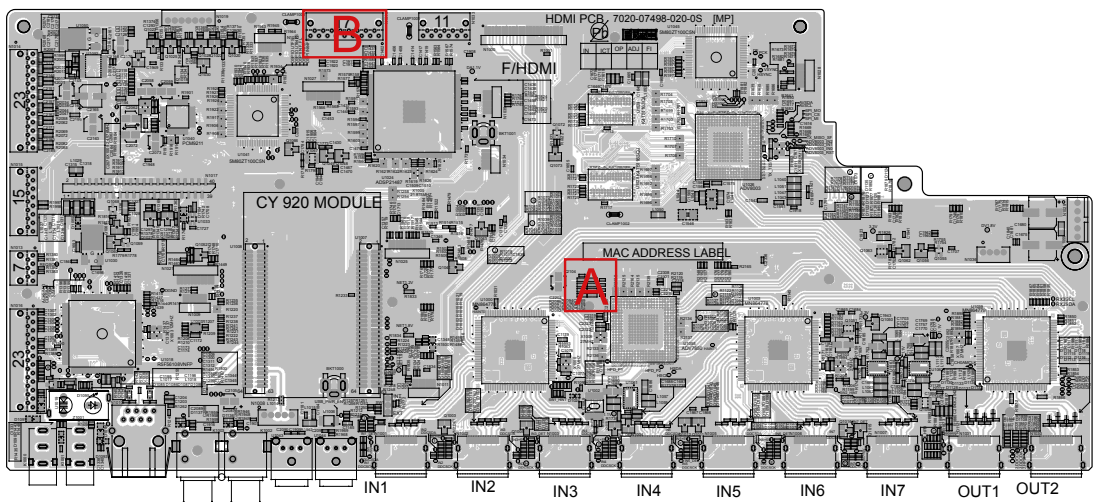

Detail A

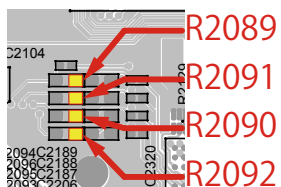

Detail B

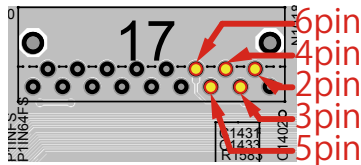

### <Video PCB> test point

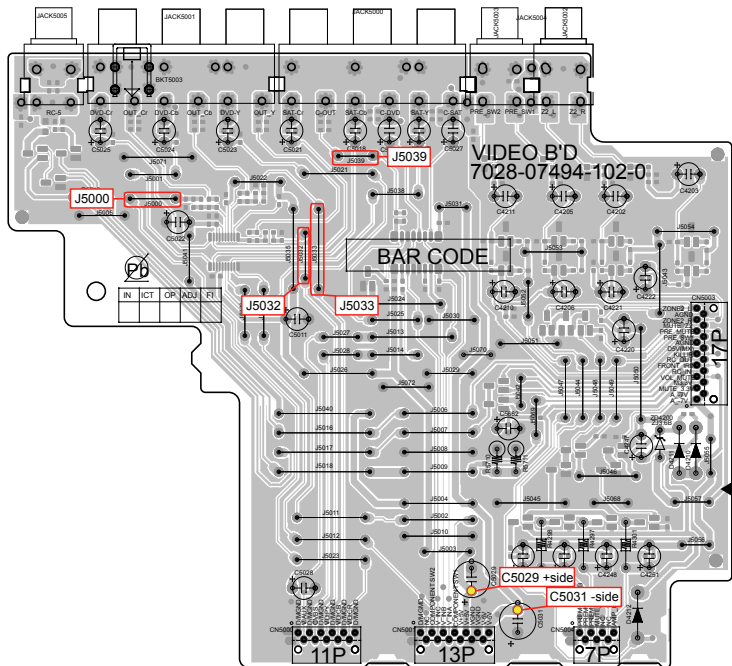

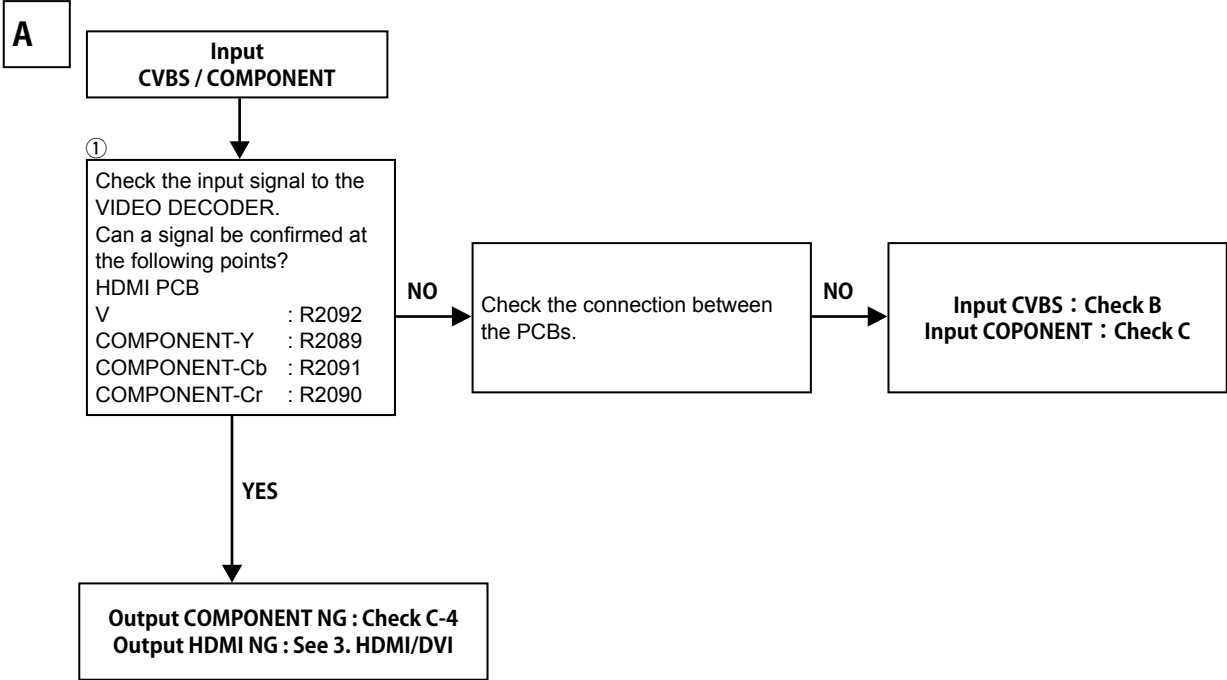

**B**

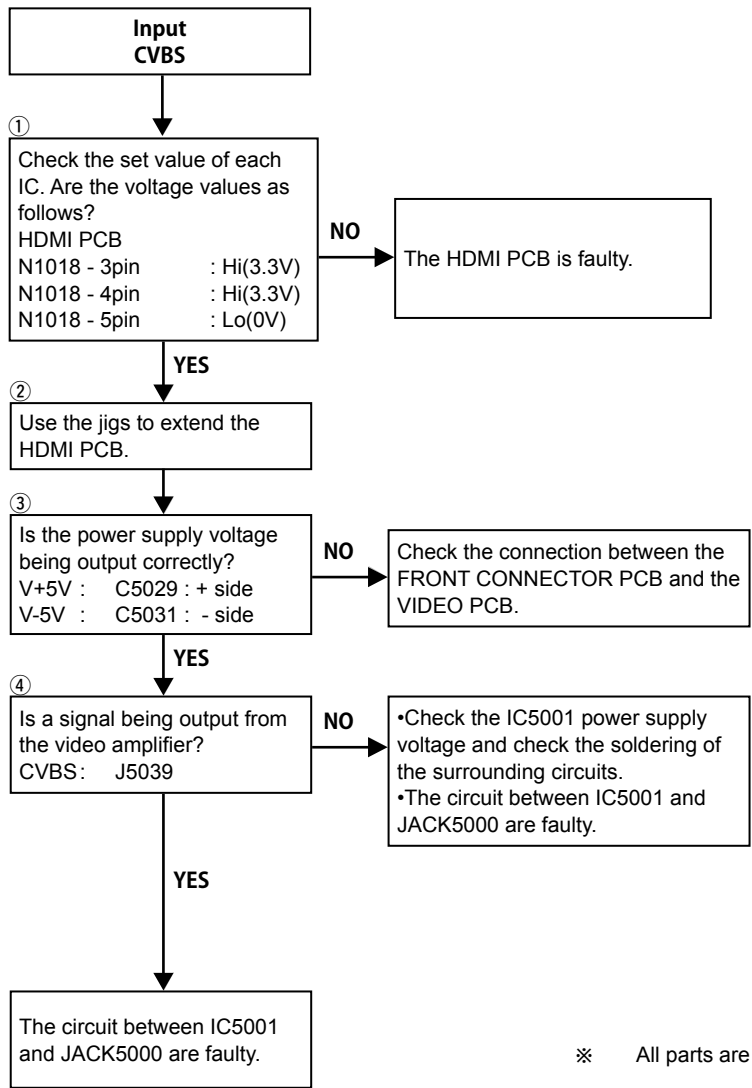

※ All parts are VIDEO PCB parts unless otherwise specified.



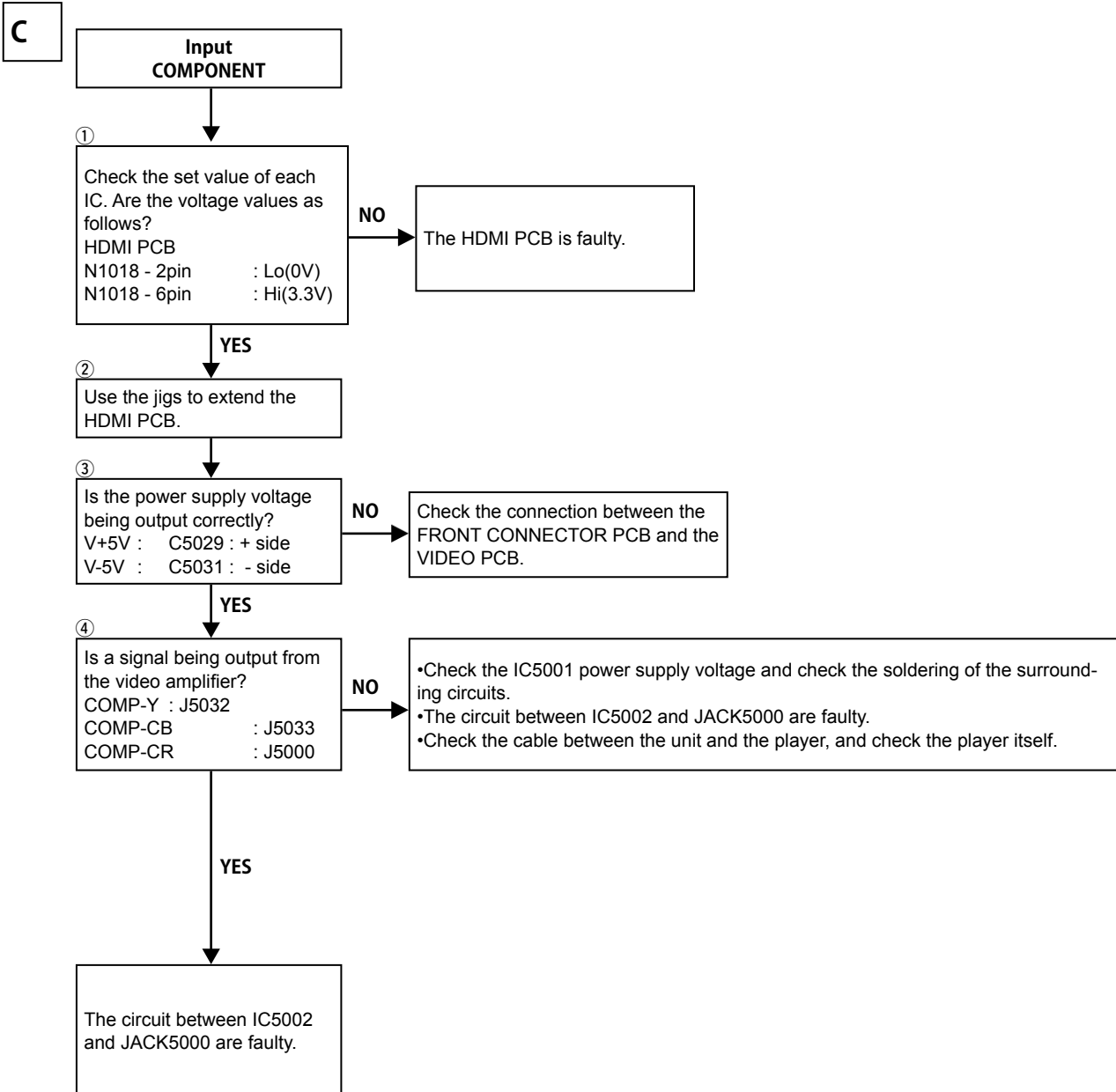

※ All parts are VIDEO PCB parts unless otherwise specified.

### 3. HDMI/DVI

#### 3.1. No picture or sound is output (HDMI to HDMI)

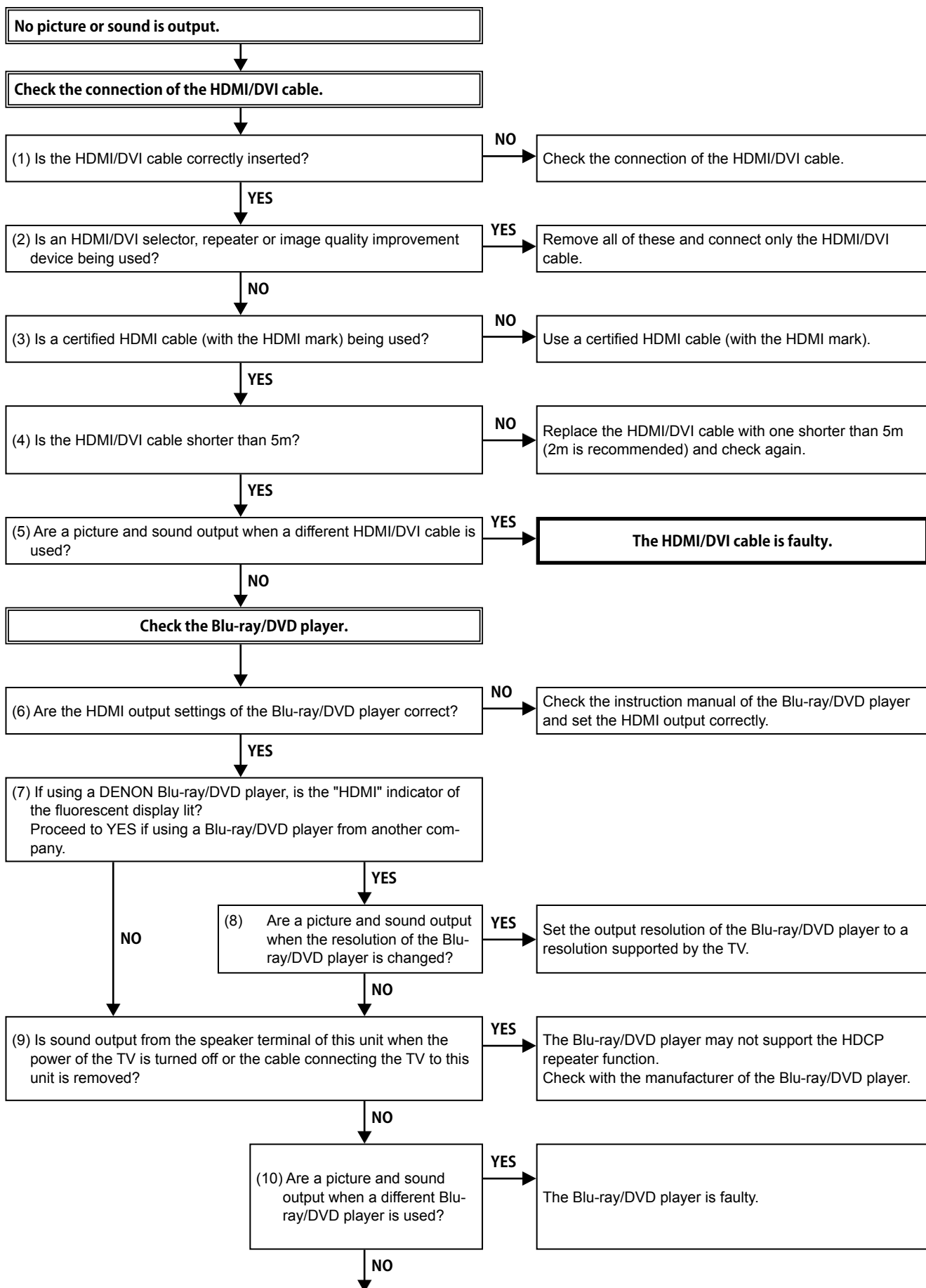

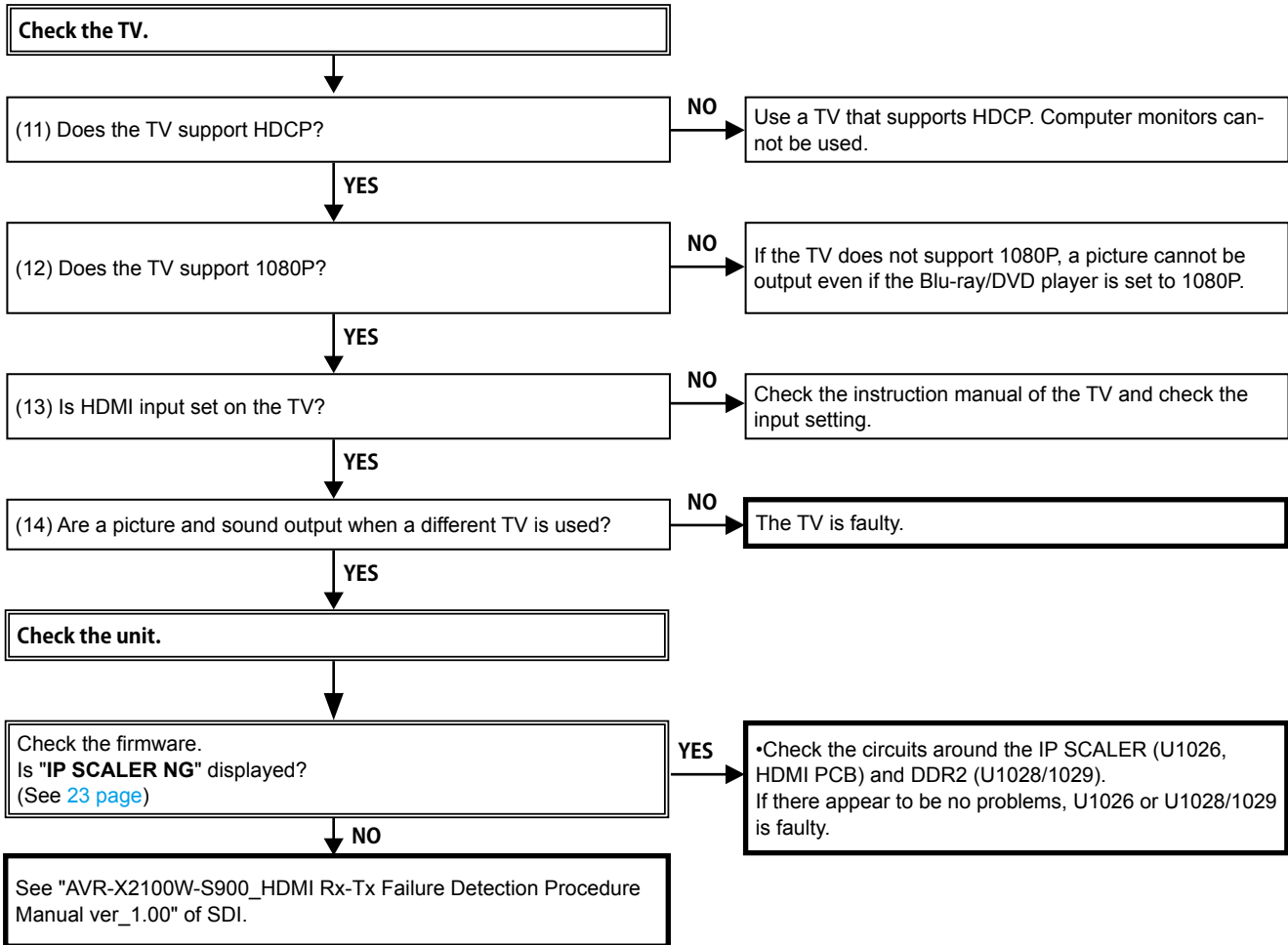

## 4. AUDIO

### 4.1. AUDIO CHECK

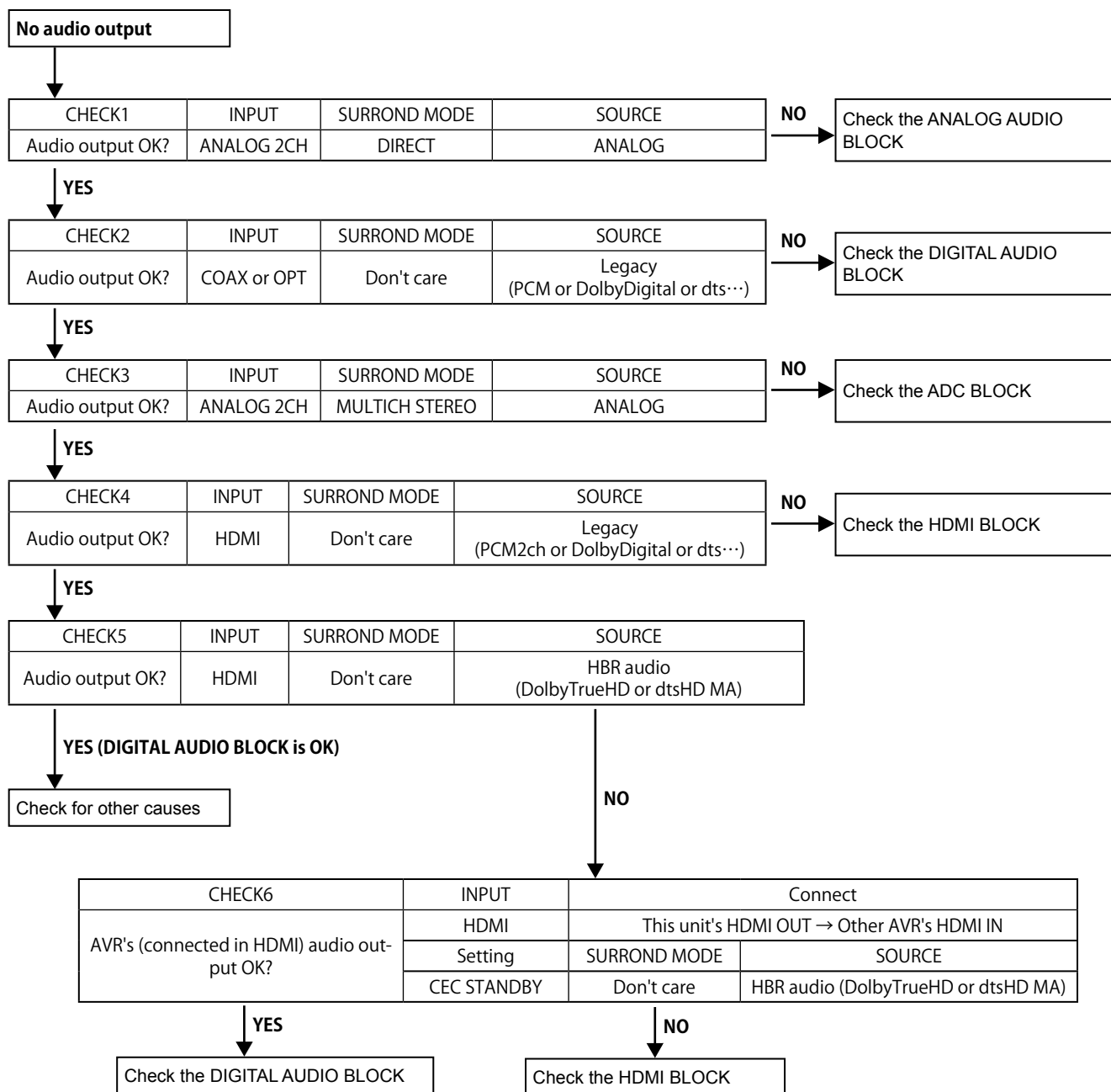

## 4.2. Power AMP (AMP PCB)

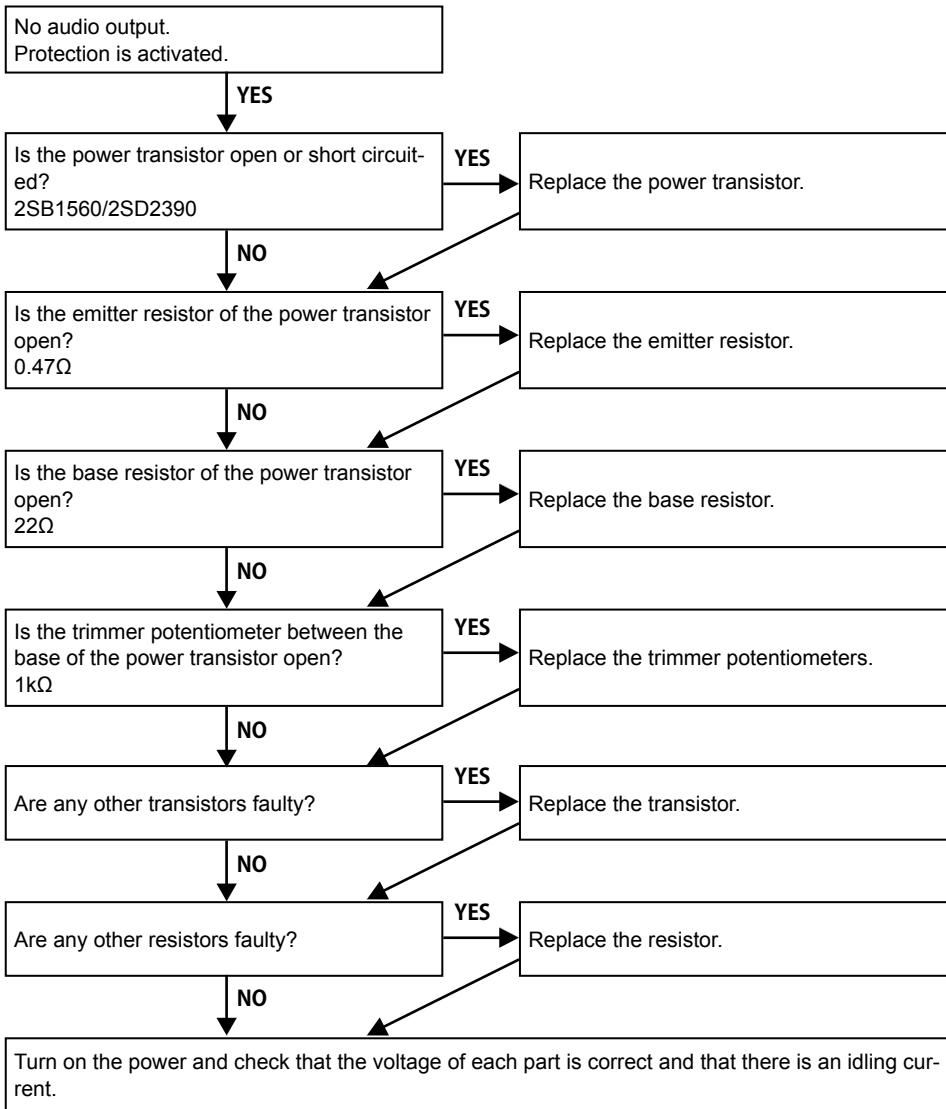

### 4.3. Analog audio

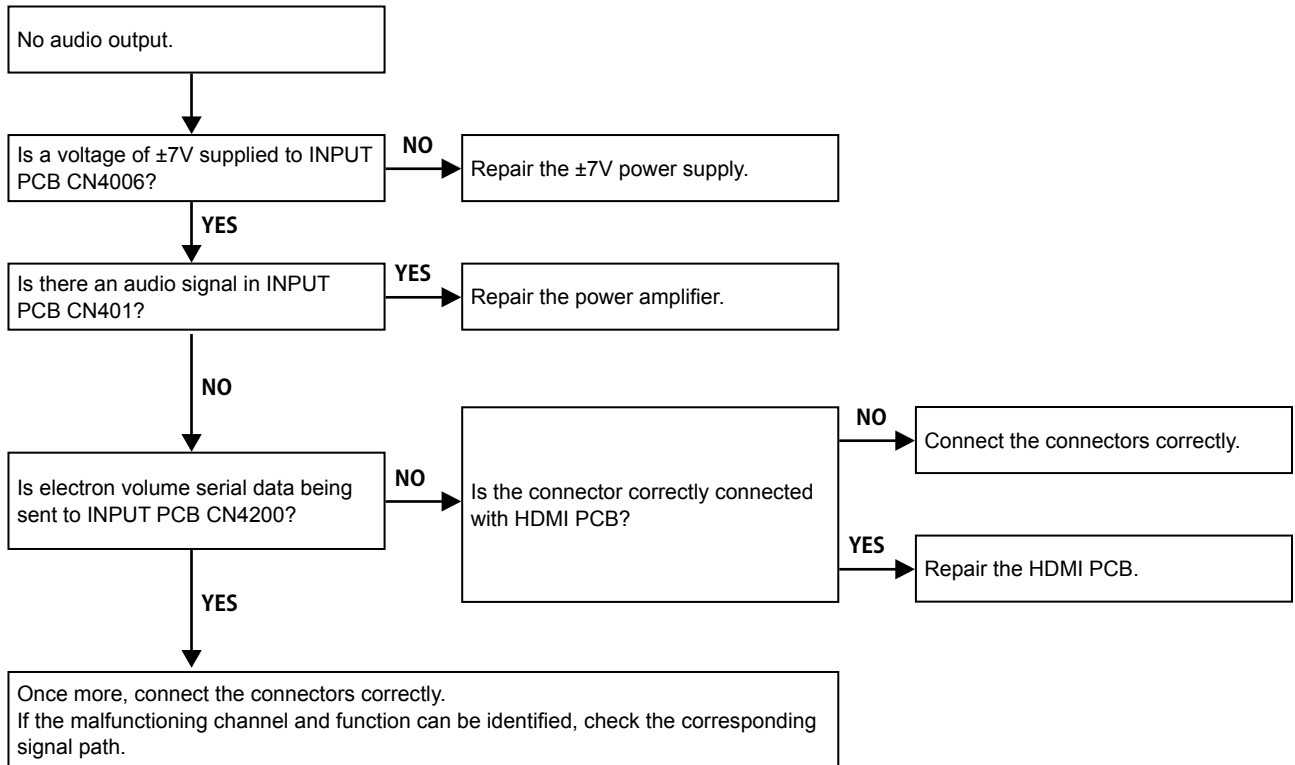

## 5. Network/Bluetooth/USB

### 5.1. Cannot connect to the network

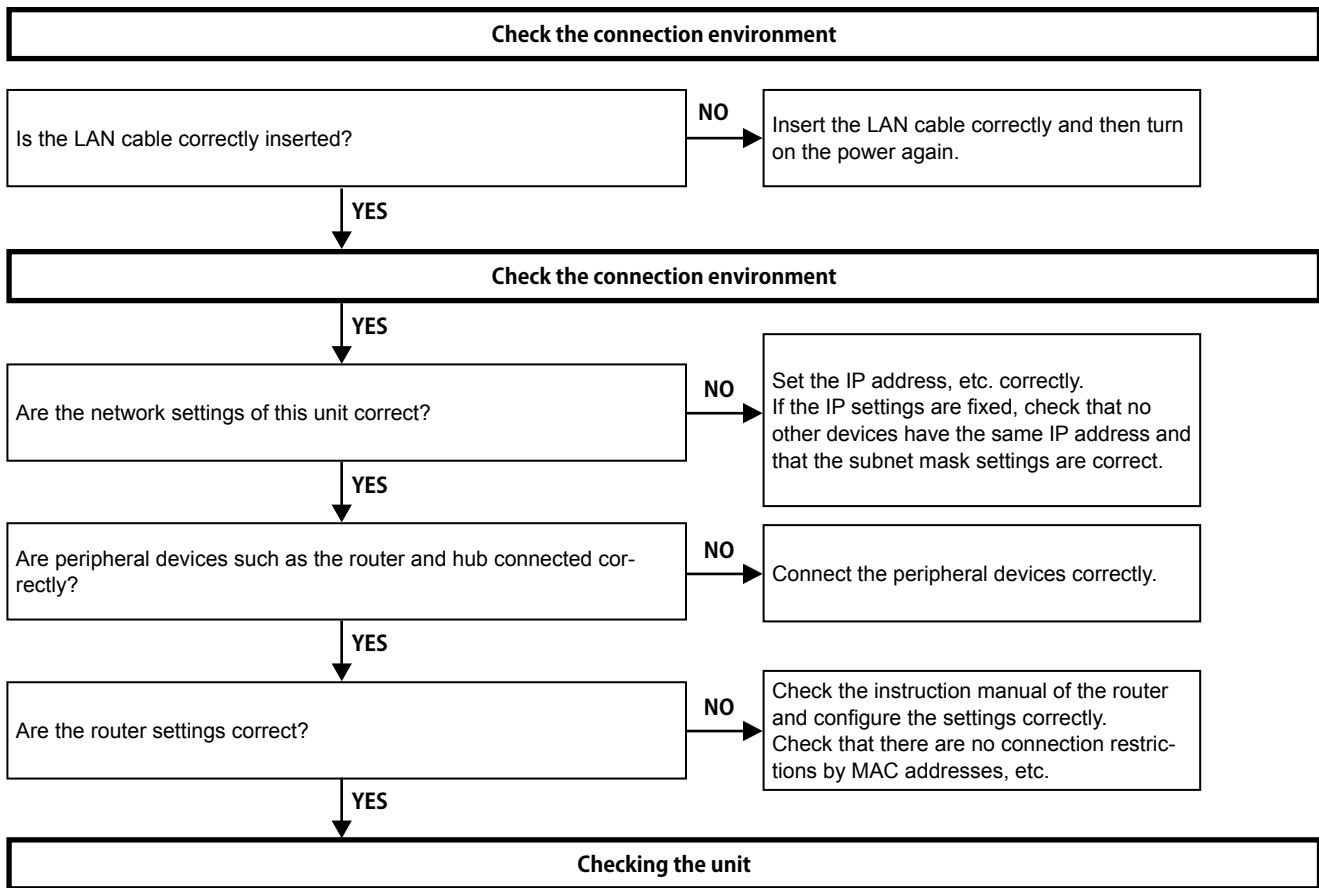

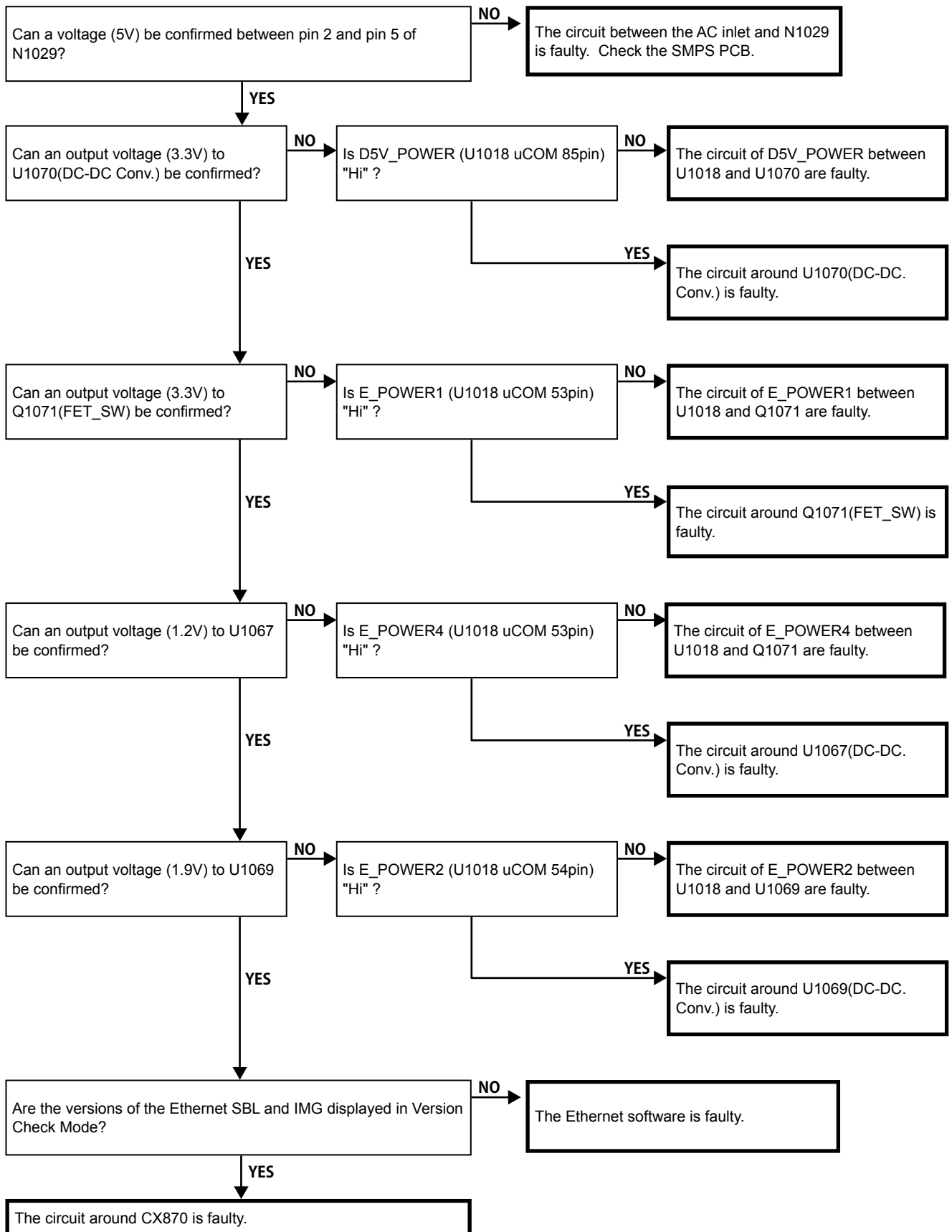



## 5.2. Cannot connect to the Bluetooth

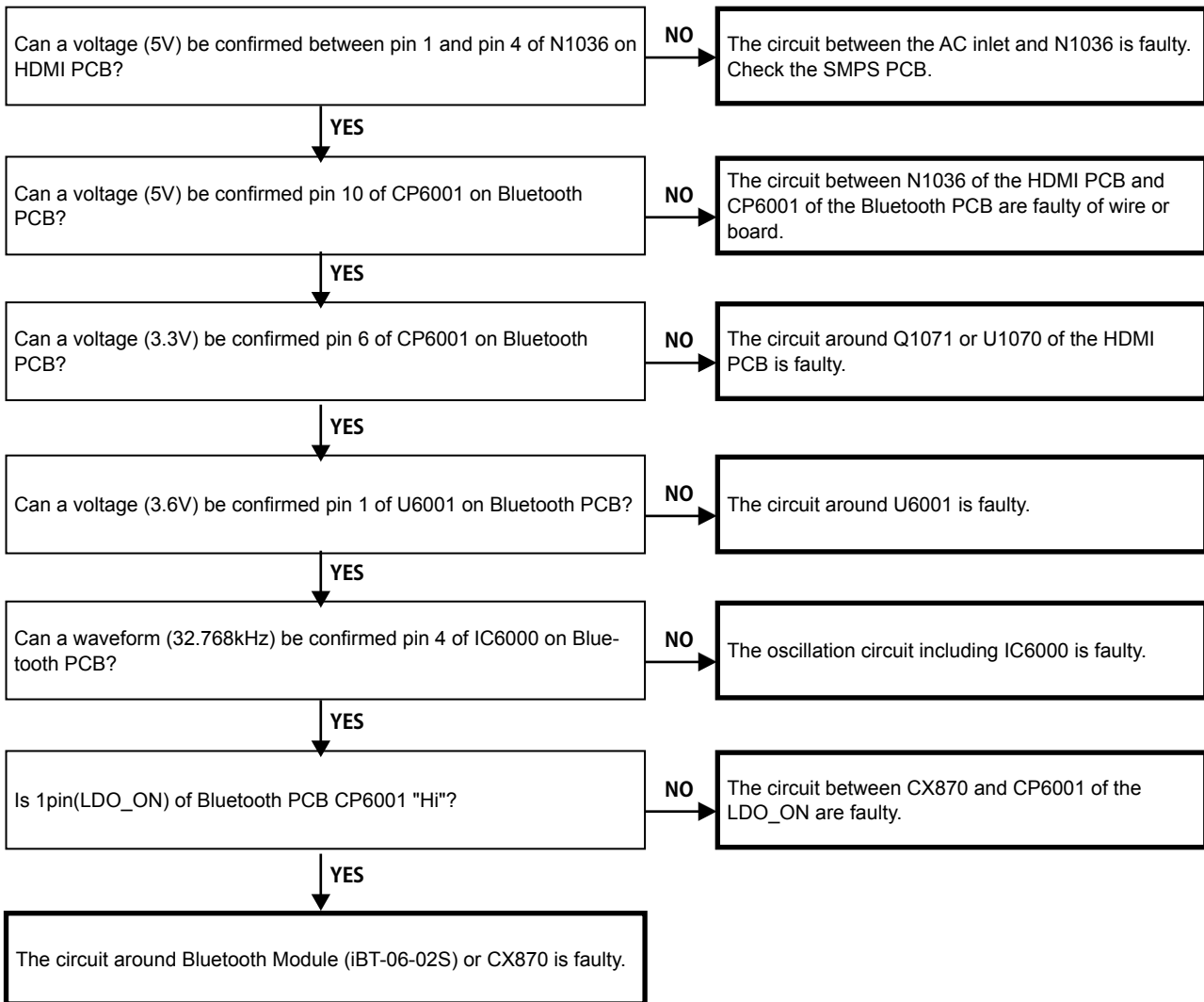

### 5.3. A connected USB device is not recognized.

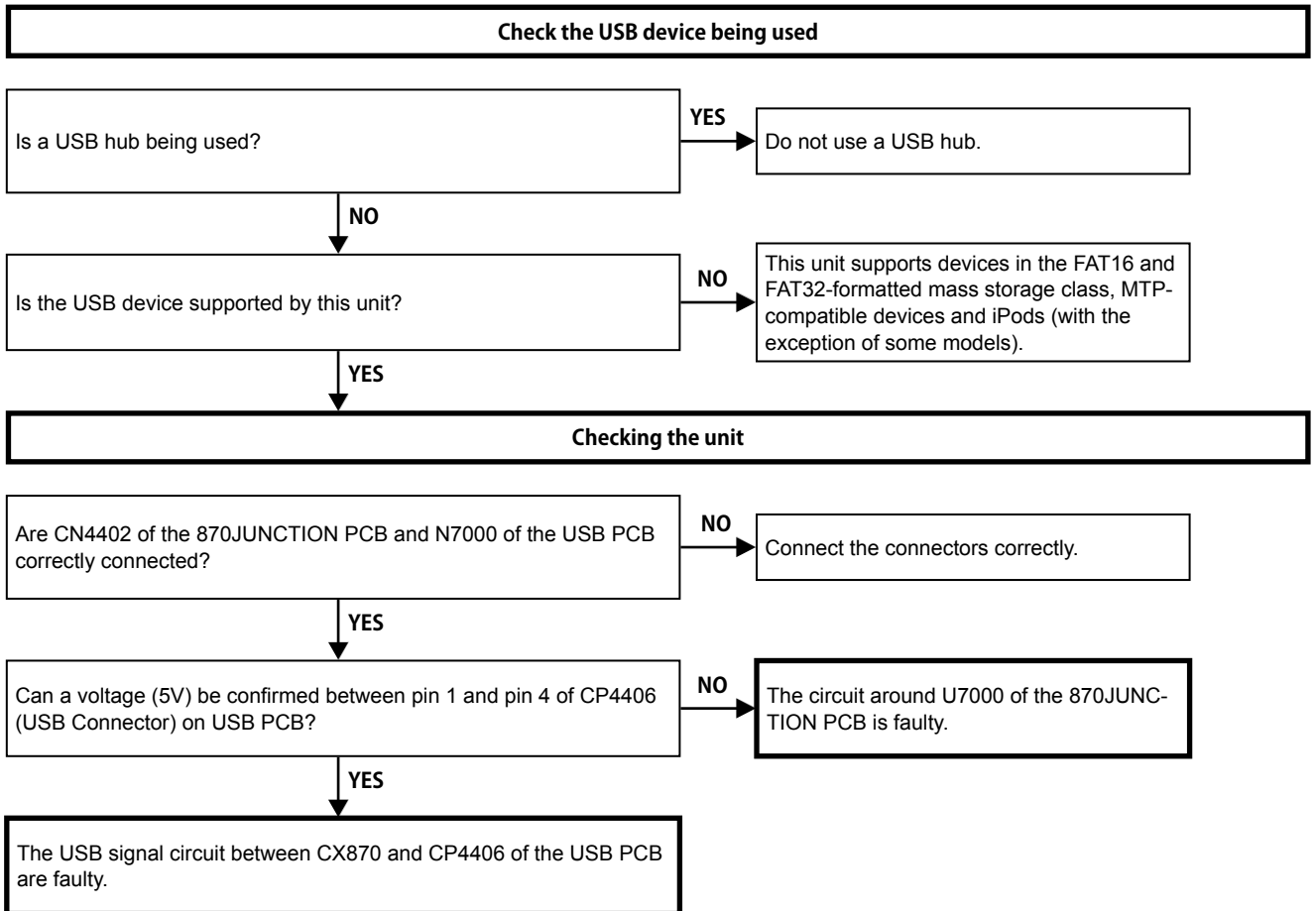

### 5.4. No picture or sound is output

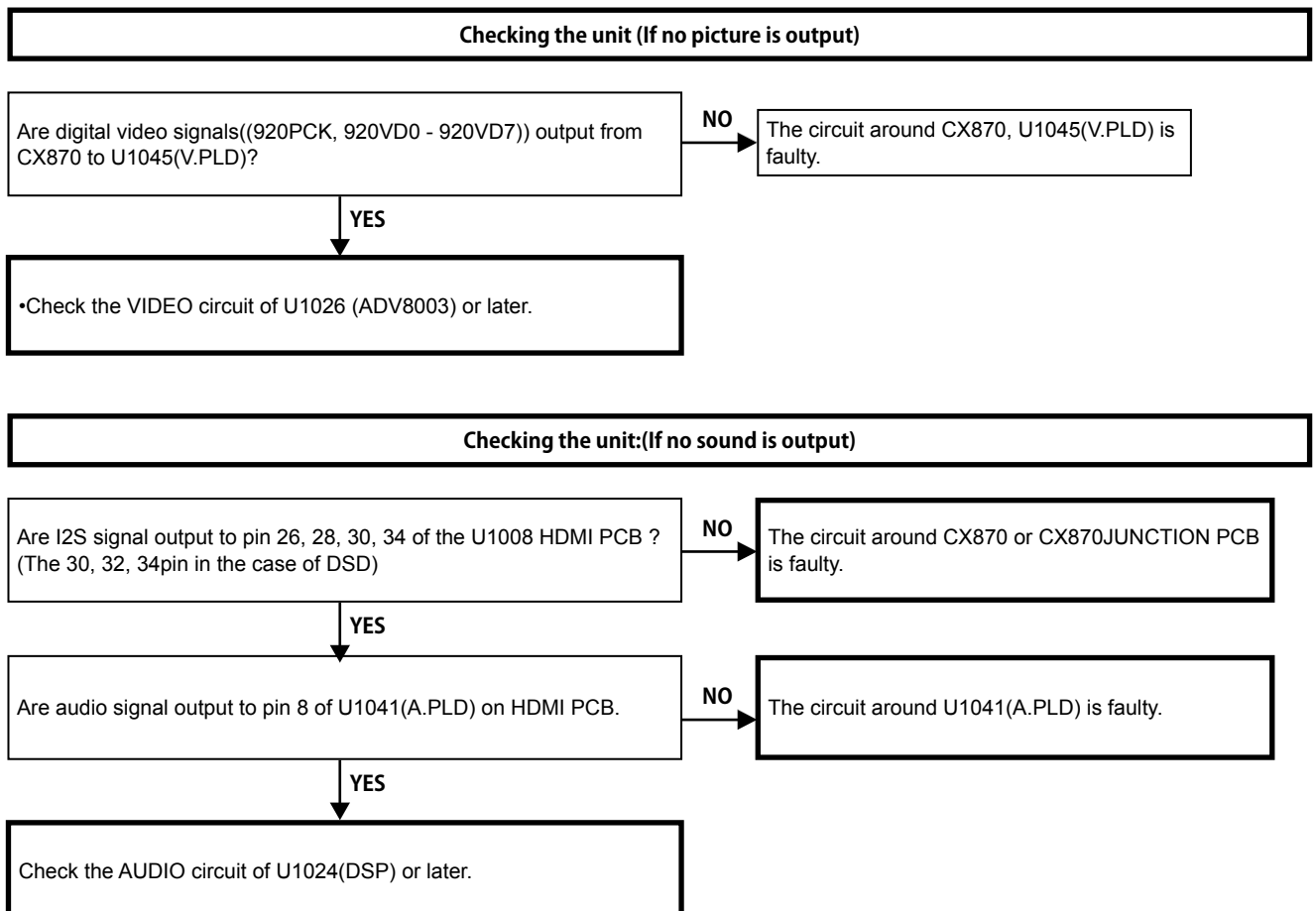

## HDMI test point

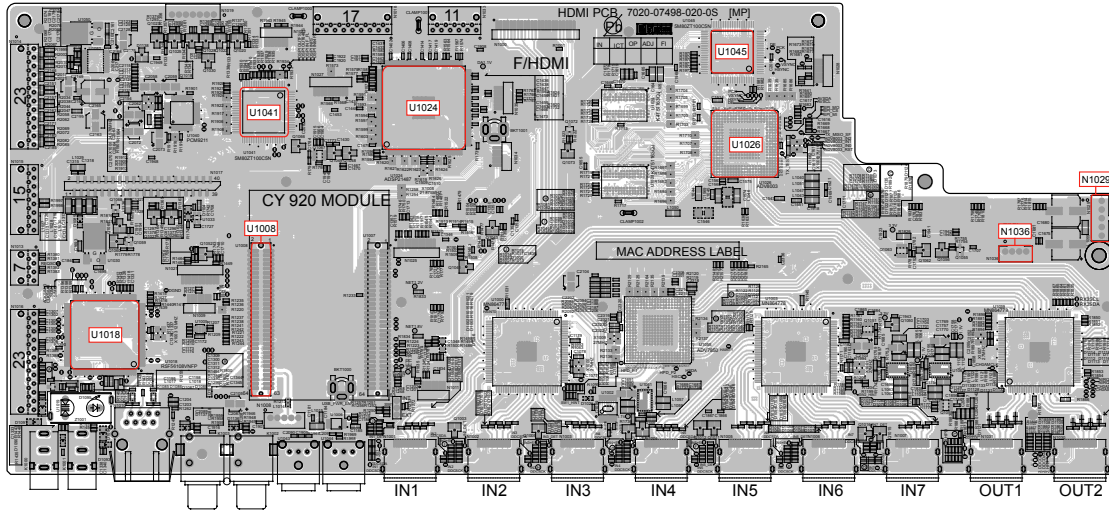

(A SIDE)

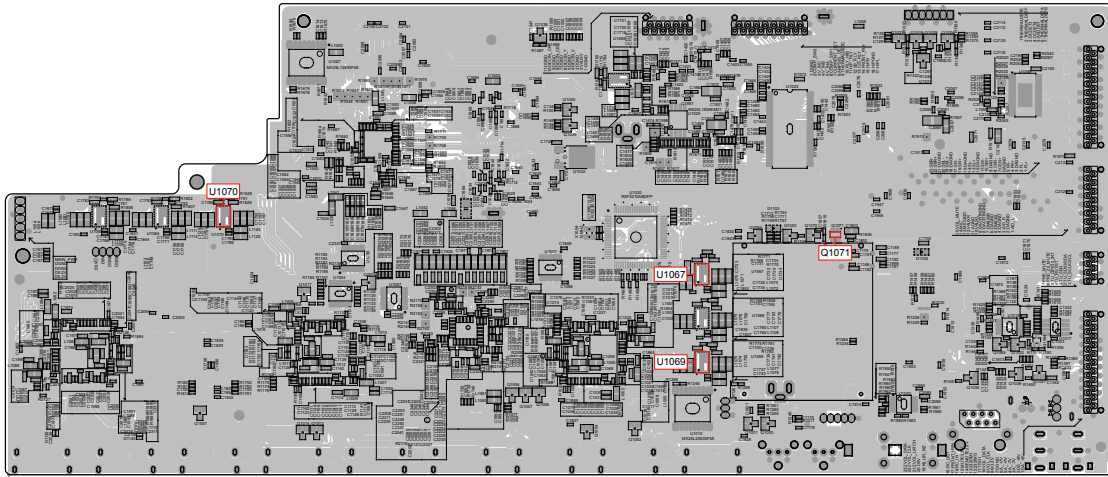

(B SIDE)

## CX870JUNCTION test point

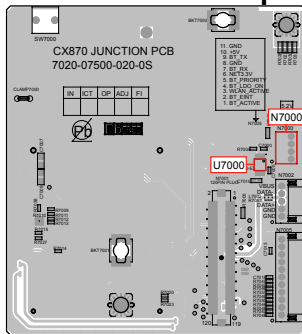

(A SIDE)

## USB test point

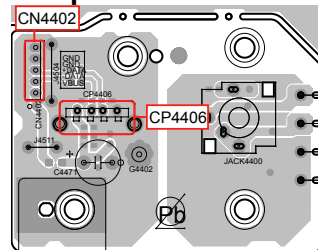

(A SIDE)

## Bluetooth test point

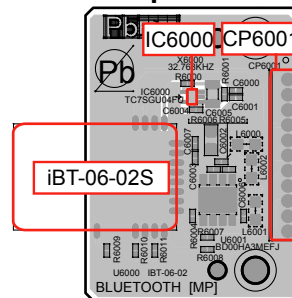

(A SIDE)

## 6. SMPS

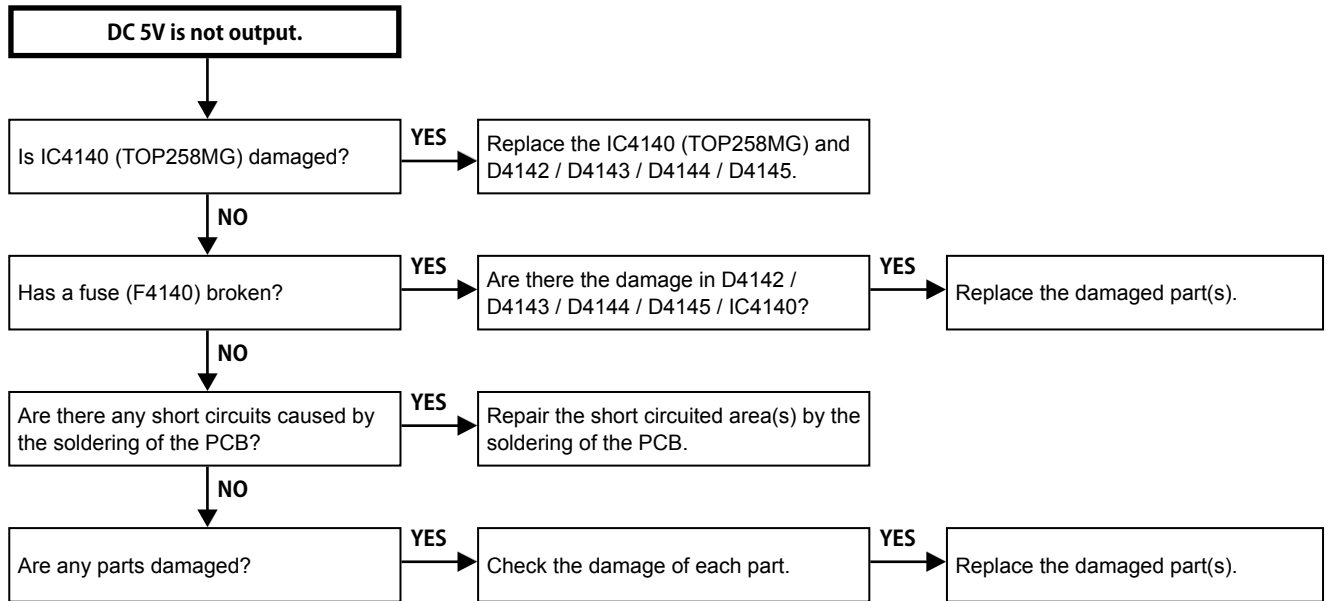

# Operation waveform for each part

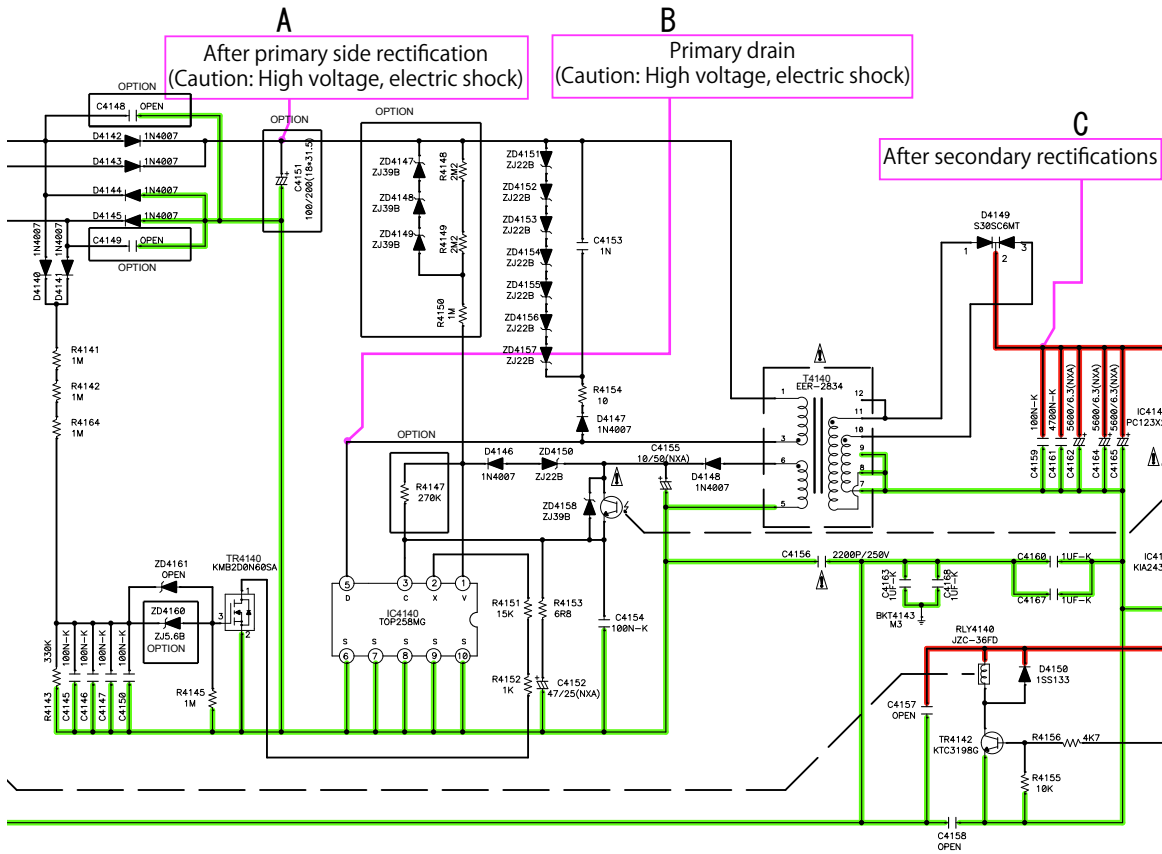

SMPS unit  
(Unloaded)

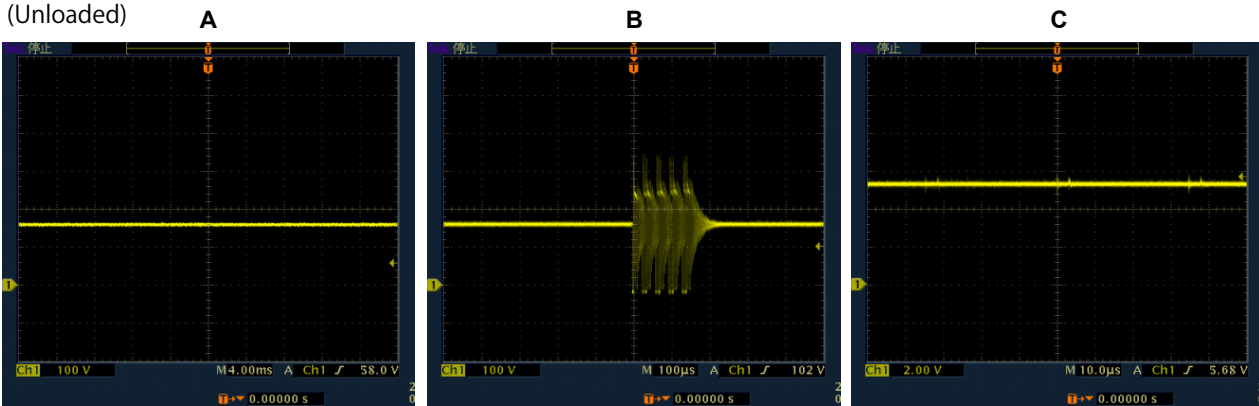

Set

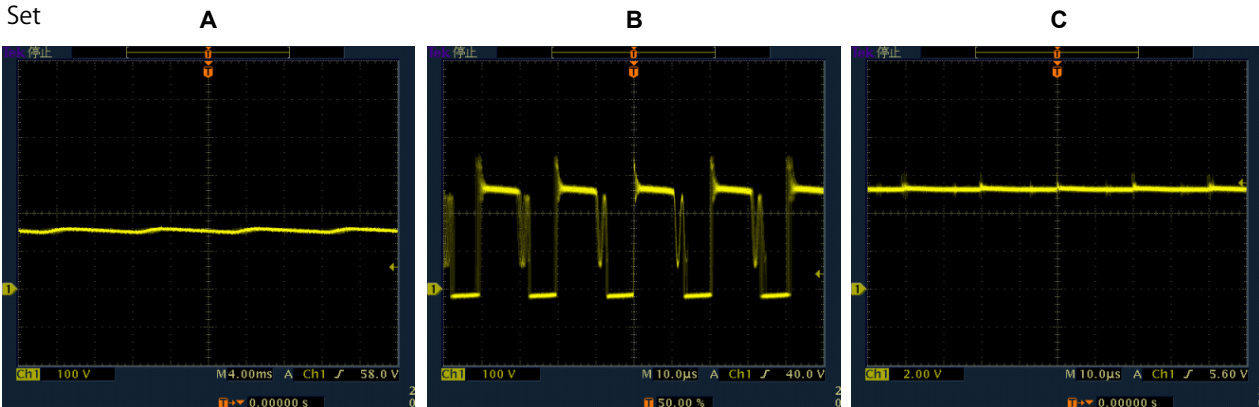

# CLOCK FLOW & WAVE FORM IN DIGITAL BLOCK

## WAVE FORM

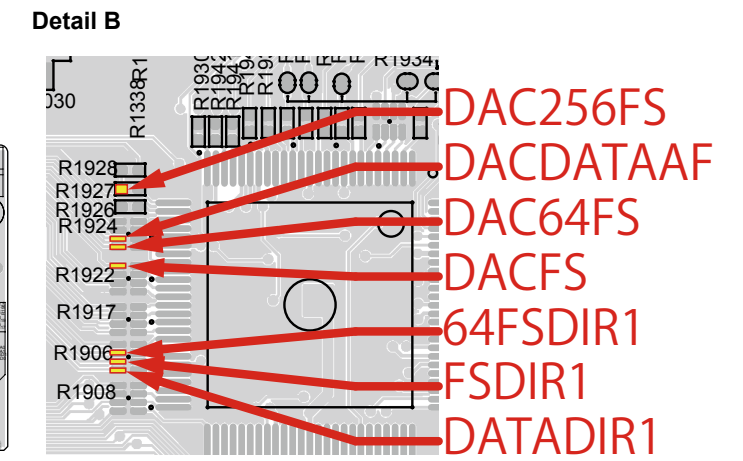
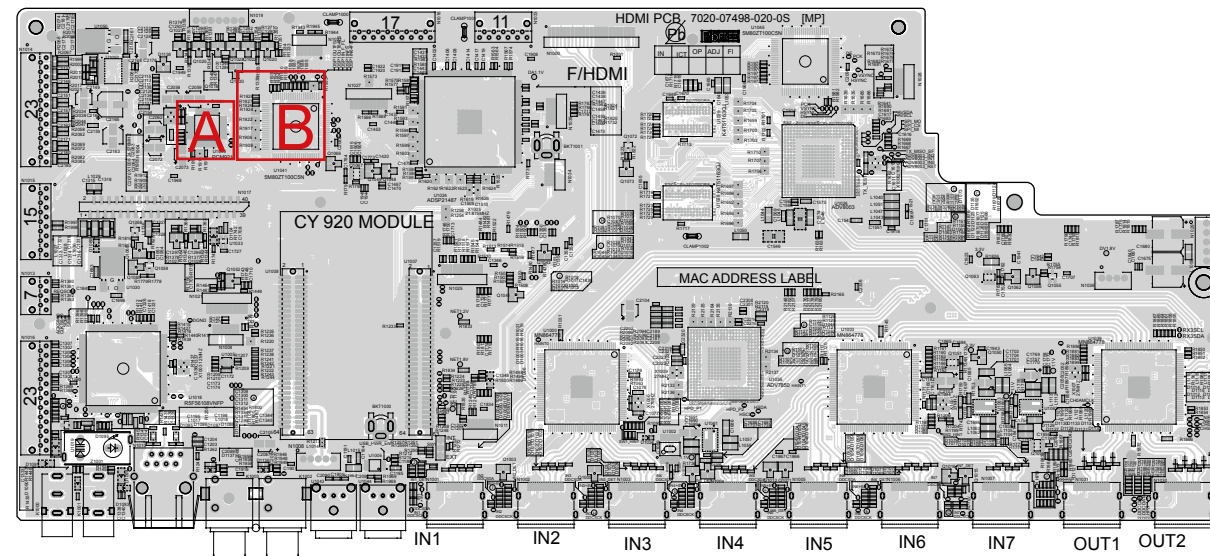
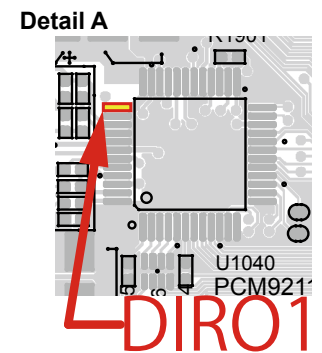
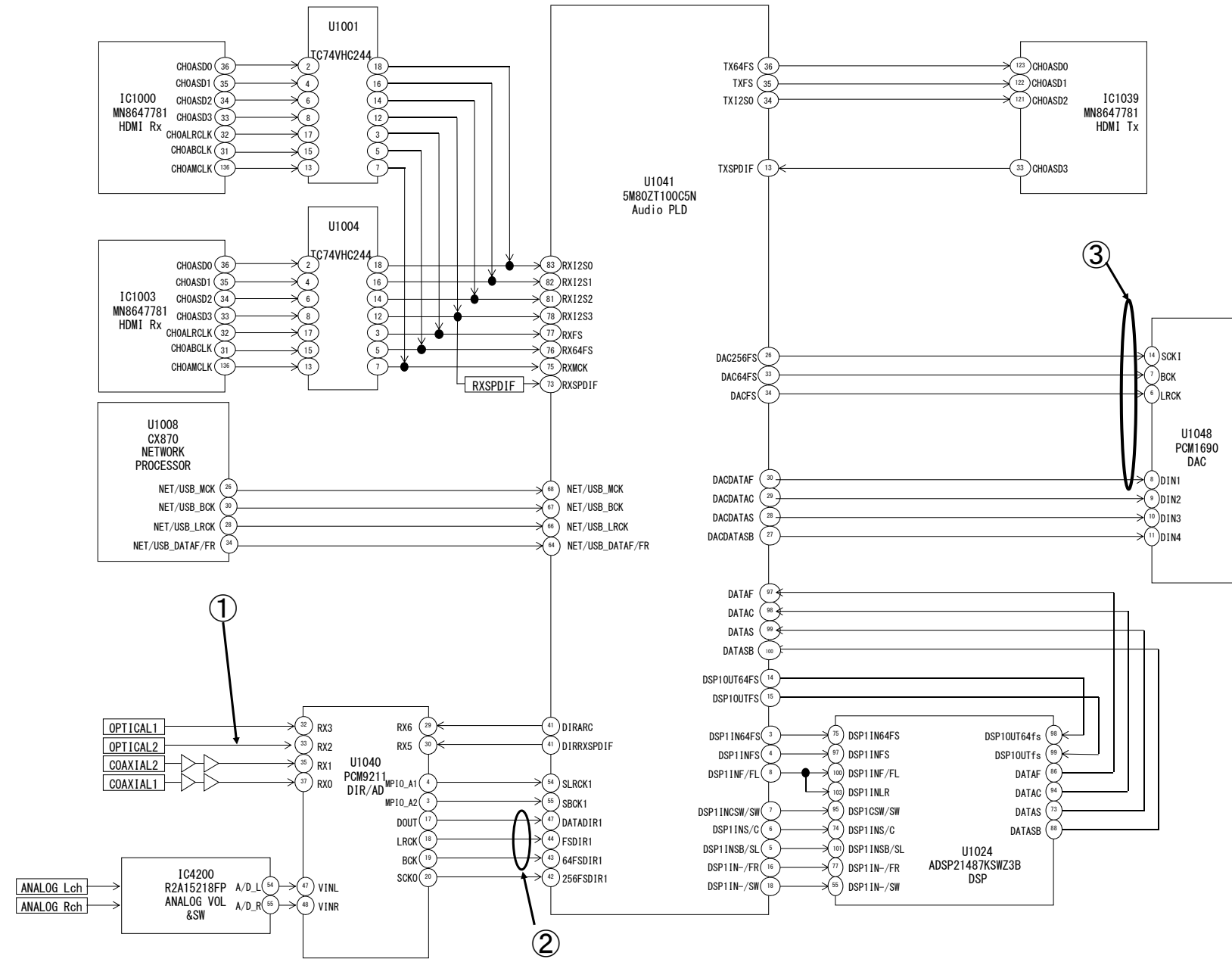
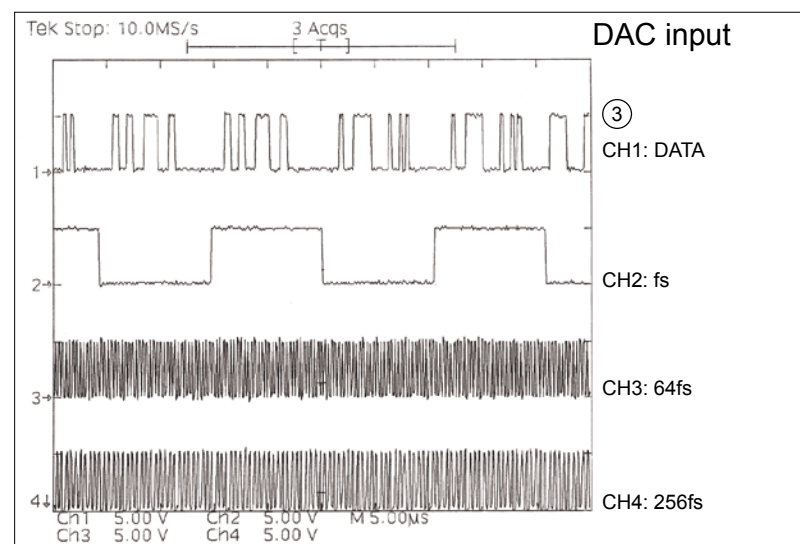
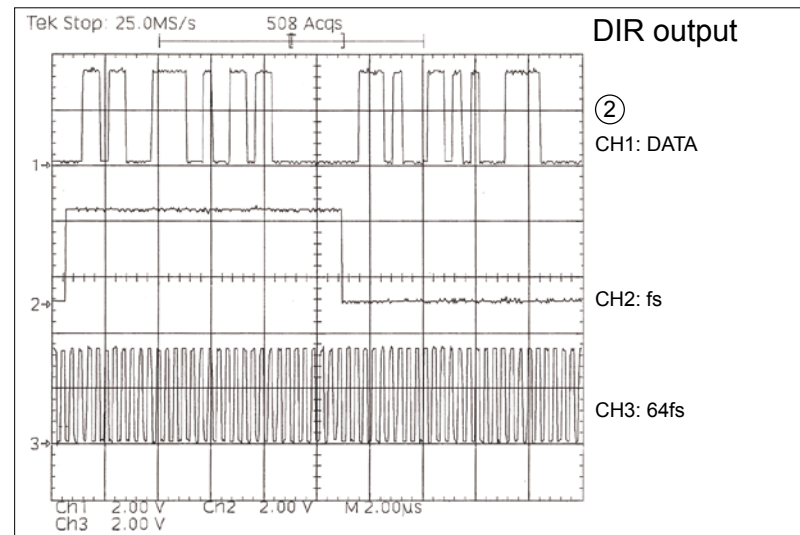
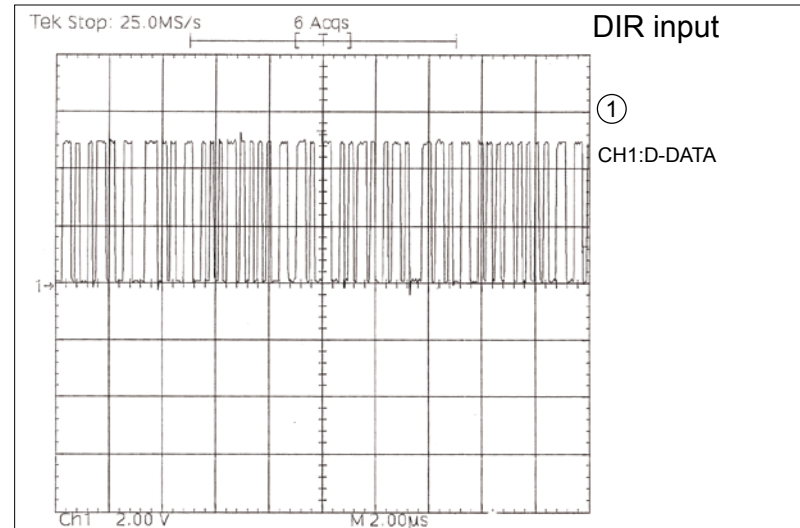

# LEVEL DIAGRAM

## AVR-S900/X2100W LEVEL DIAGRAM FRONT ch

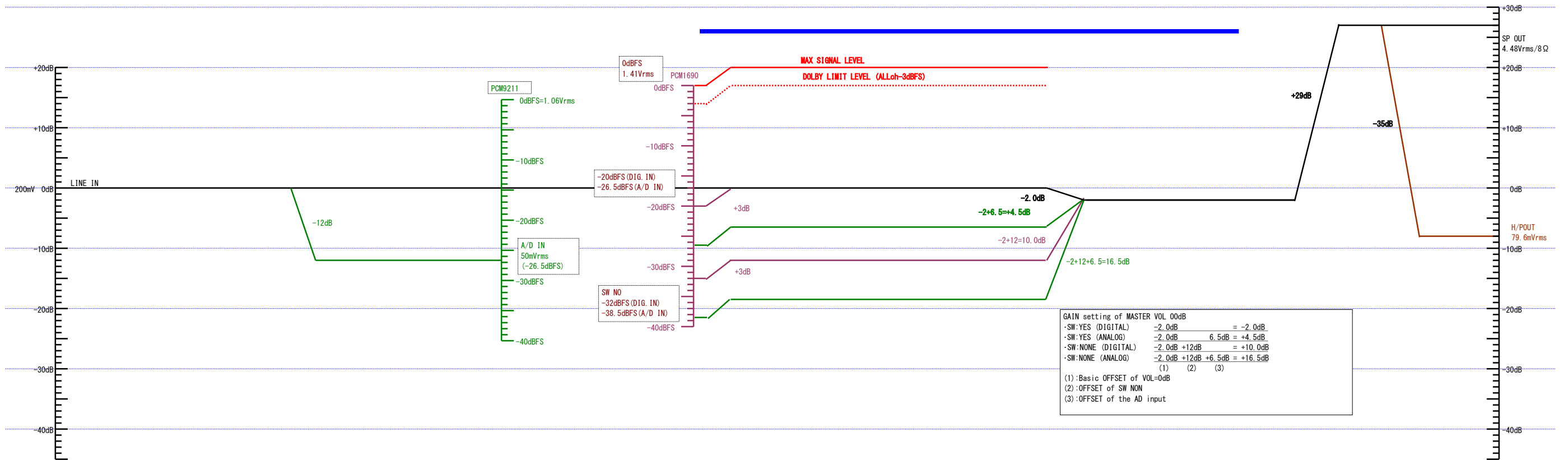
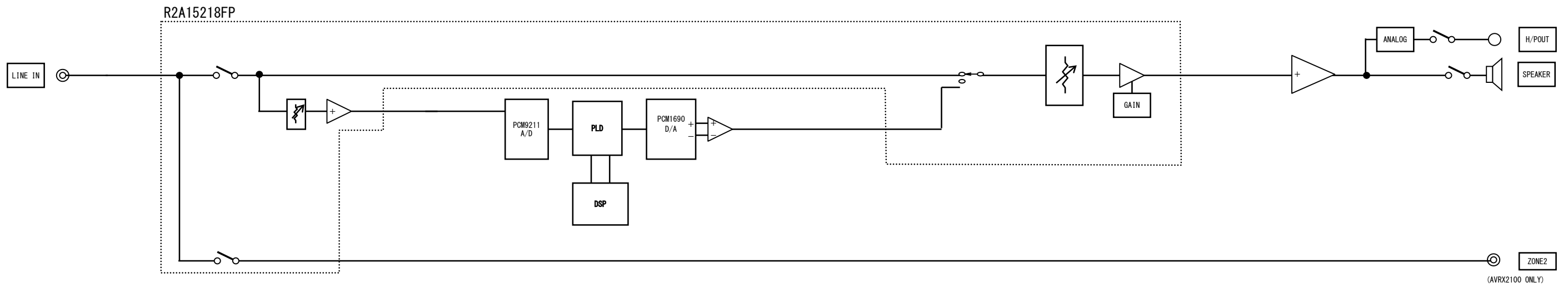



**AVR-S900/X2100W**  
**LEVEL DIAGRAM**  
**CENTER ch**

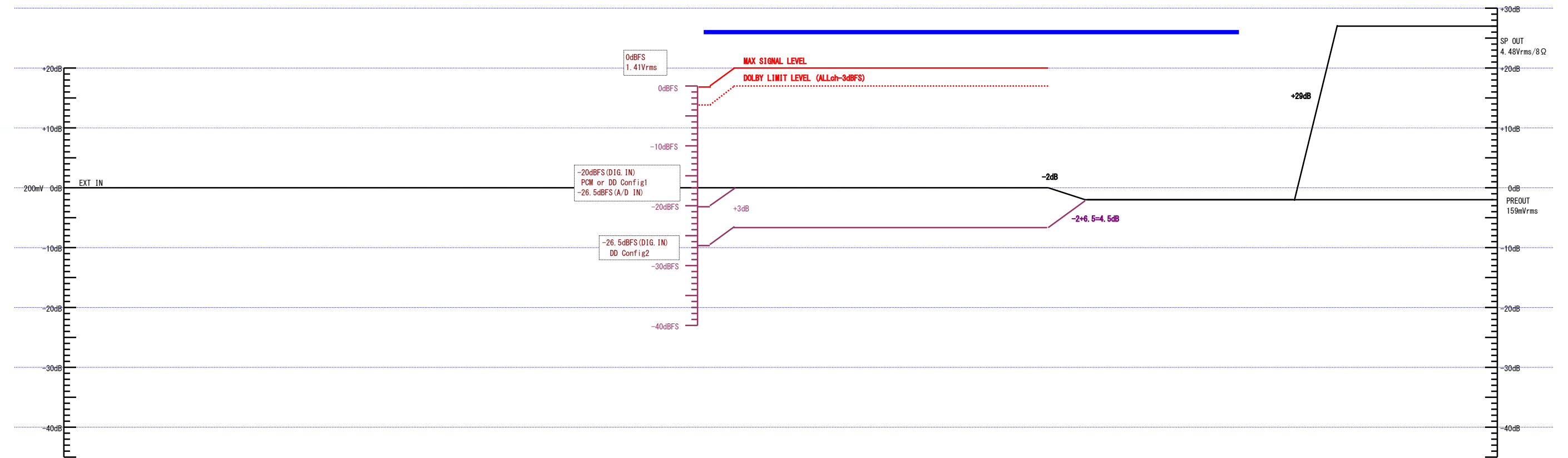
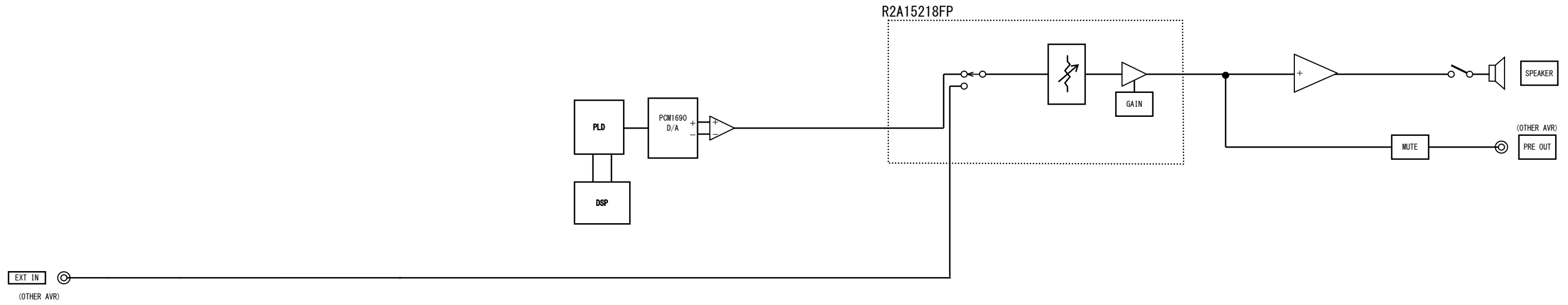



**AVR-S900/X2100W**  
**LEVEL DIAGRAM**  
**SUBWOOFER ch**

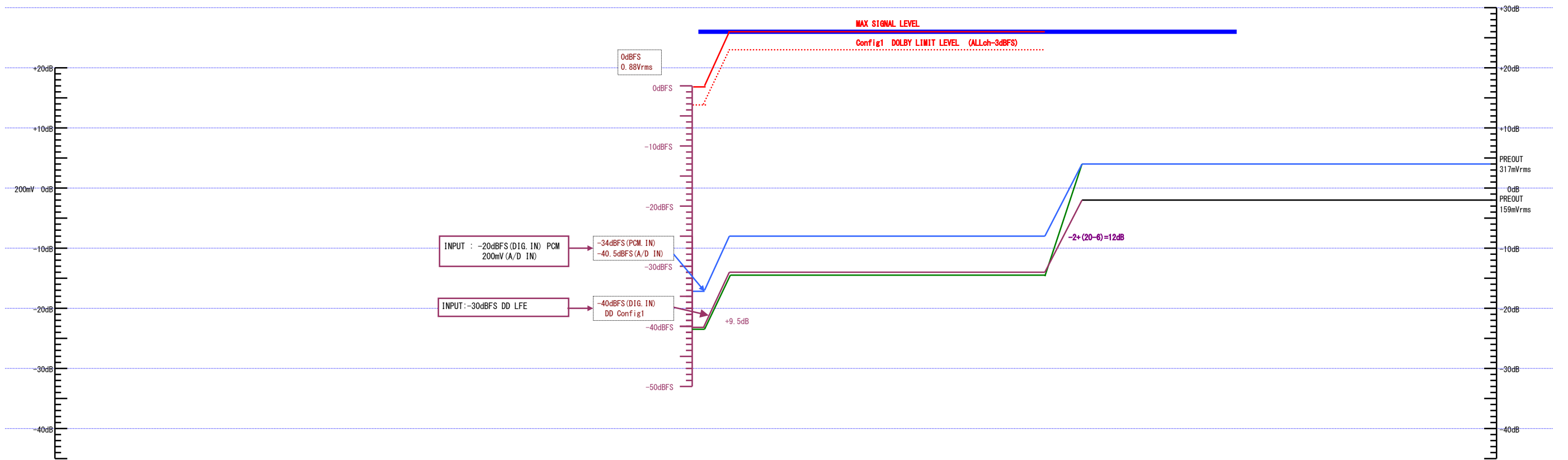
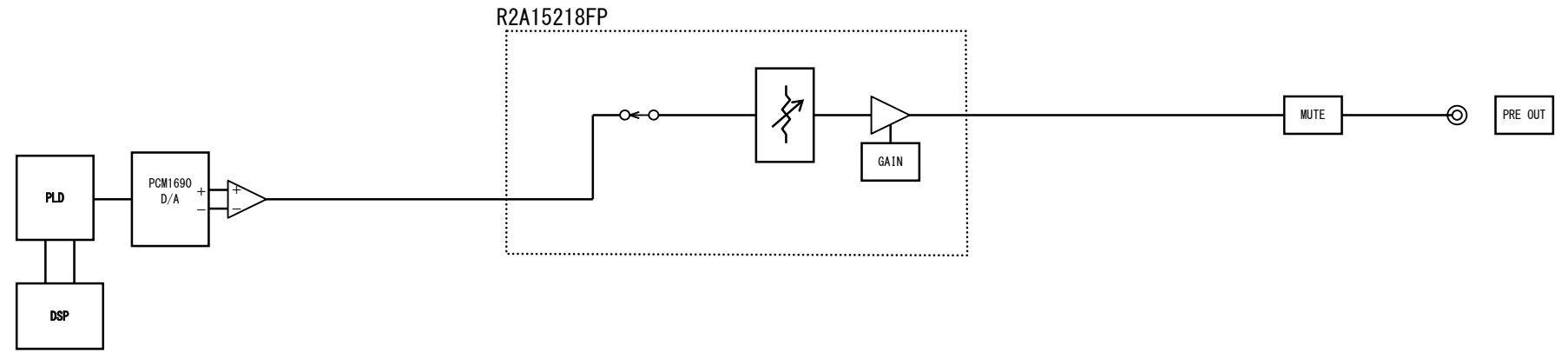

**AVR-S900/X2100W**  
**LEVEL DIAGRAM**  
**SURROUND ch**

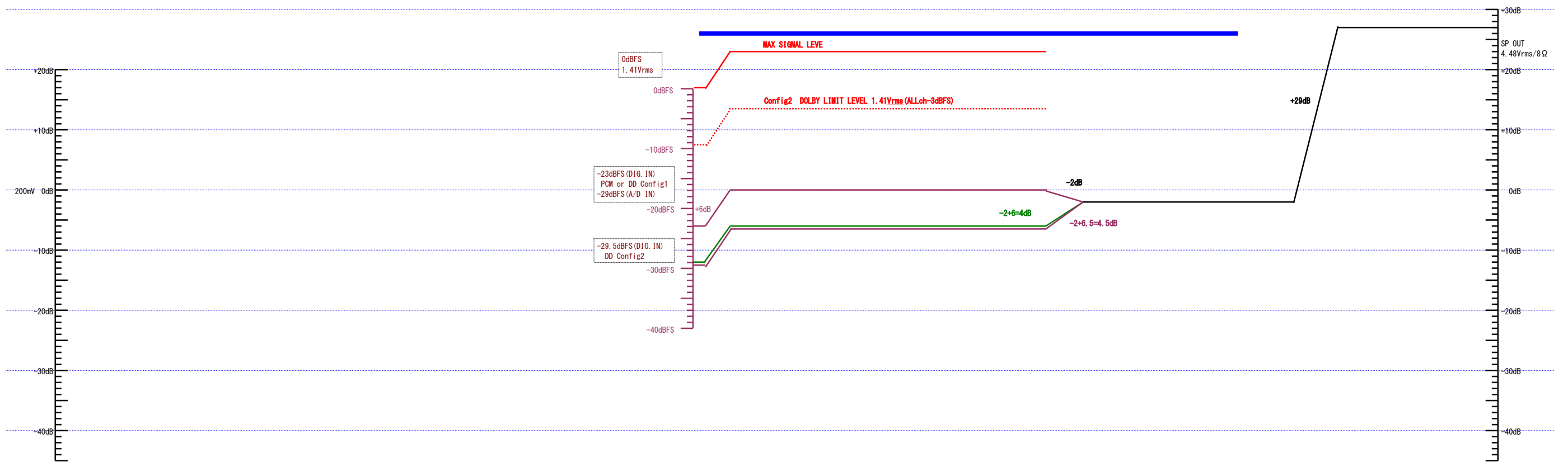
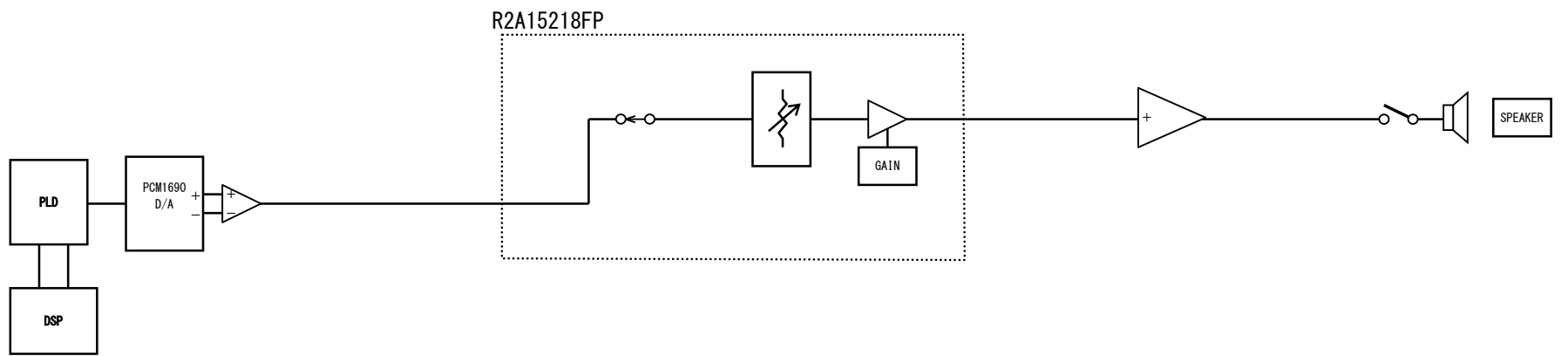

**AVR-S900/X2100W  
LEVEL DIAGRAM  
SURR.BACK ch**

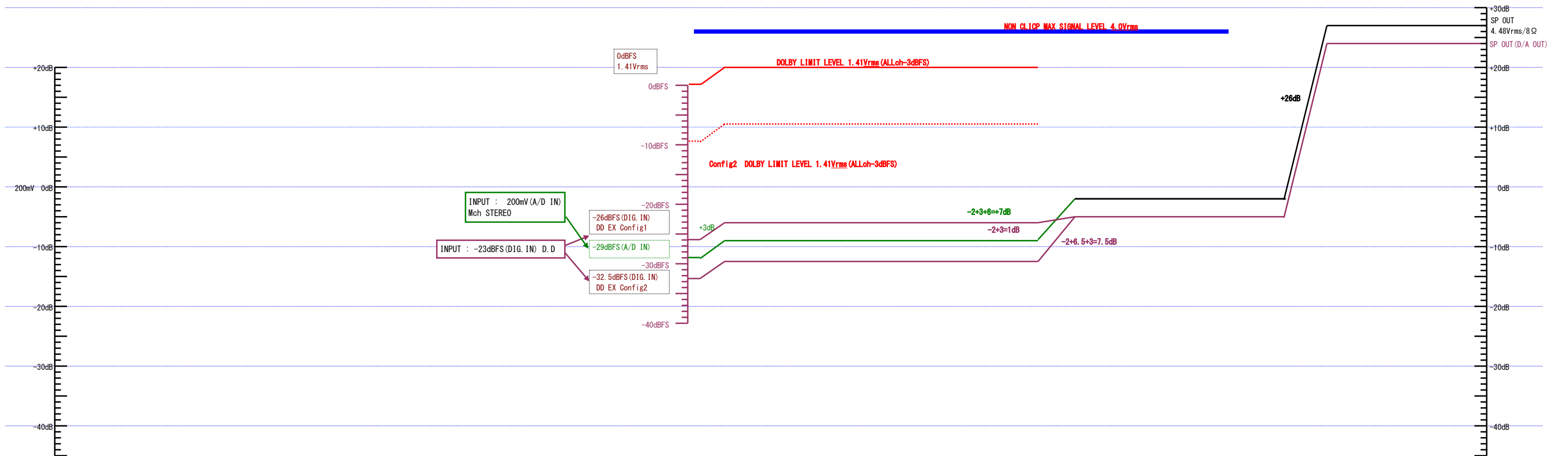
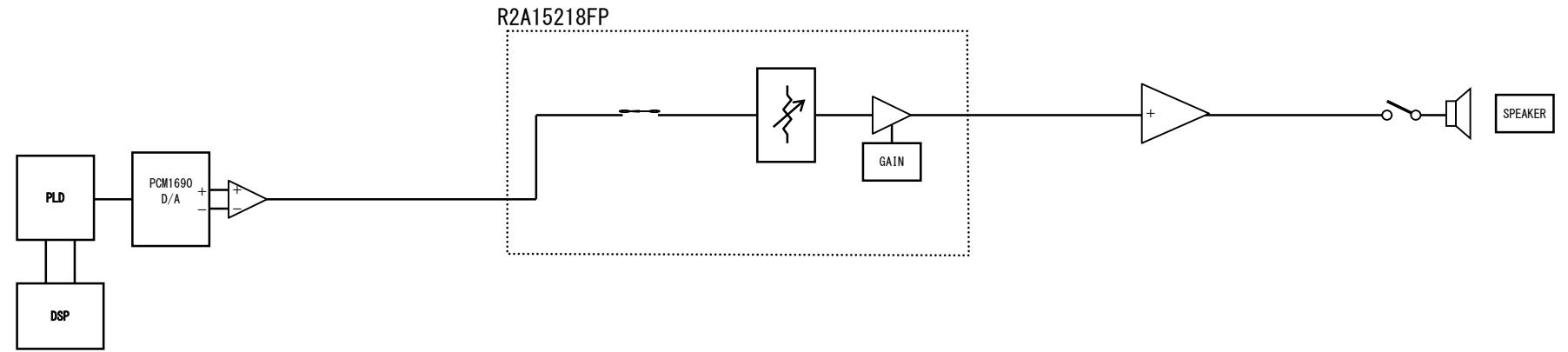

**AVR-S900/X2100W  
LEVEL DIAGRAM  
ZONE2**

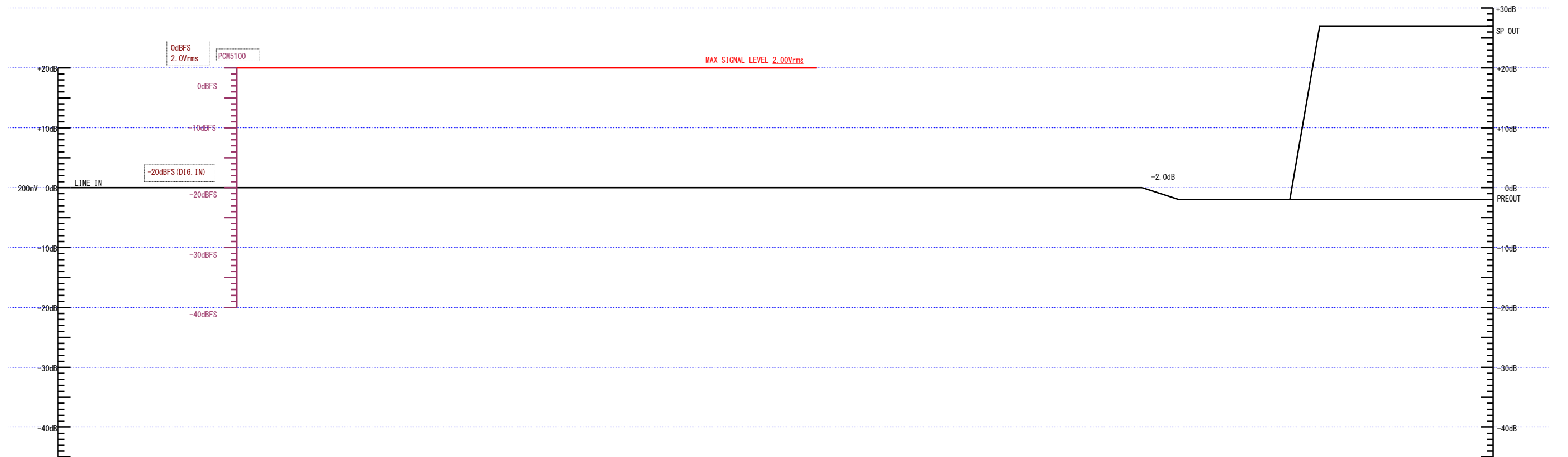
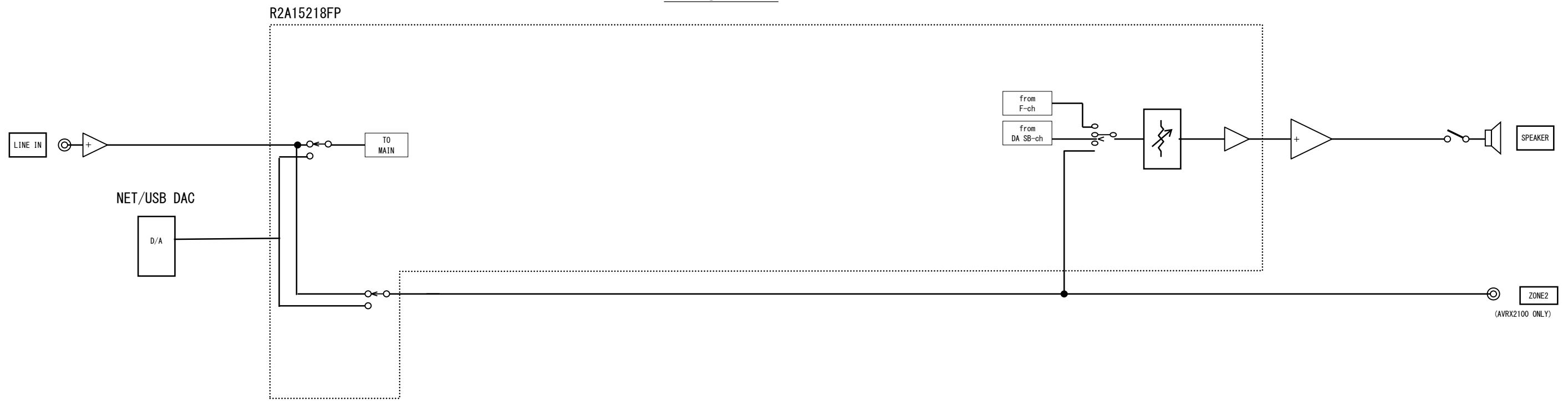

# BLOCK DIAGRAM

## AVR\_S900 / X2100 / OTHER AVR1 GND DIAGRAM

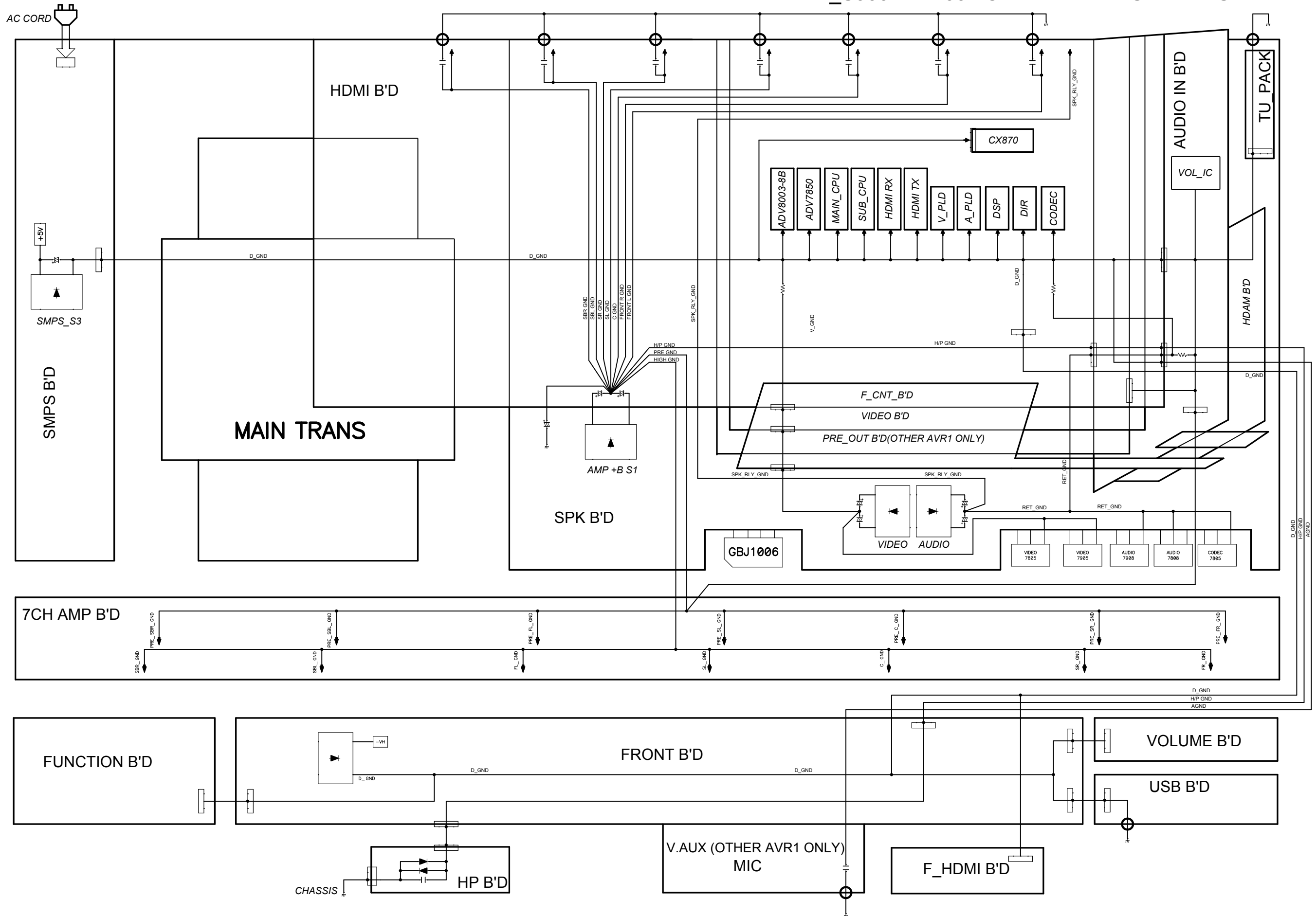

# POWER DIAGRAM

## AVR\_S900 / X2100 / OTHER AVR1 VCC DIAGRAM

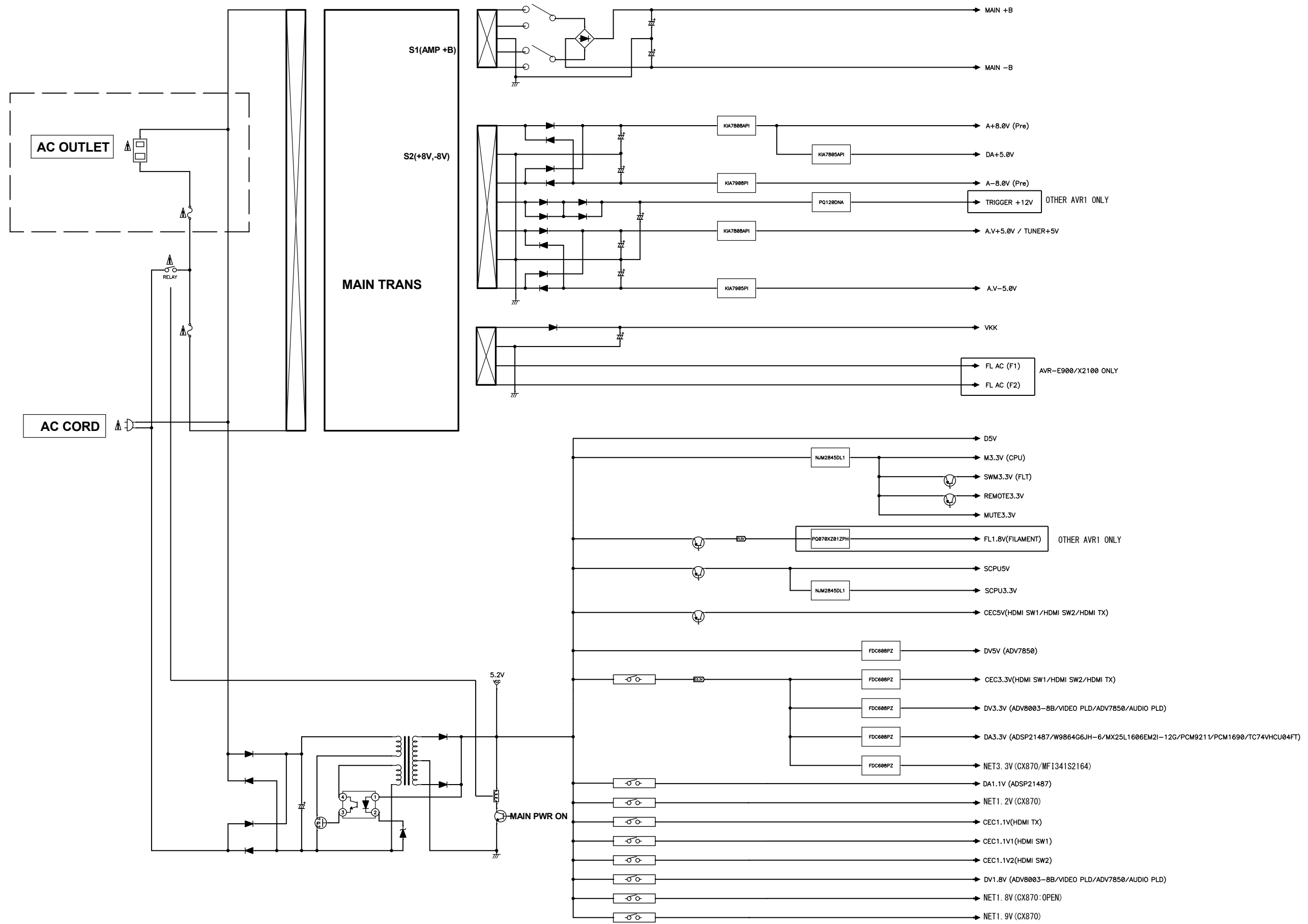

**WIRING DIAGRAM**

**AVR\_S900 / X2100 / OTHER AVR1 WIRE DIAGRAM**

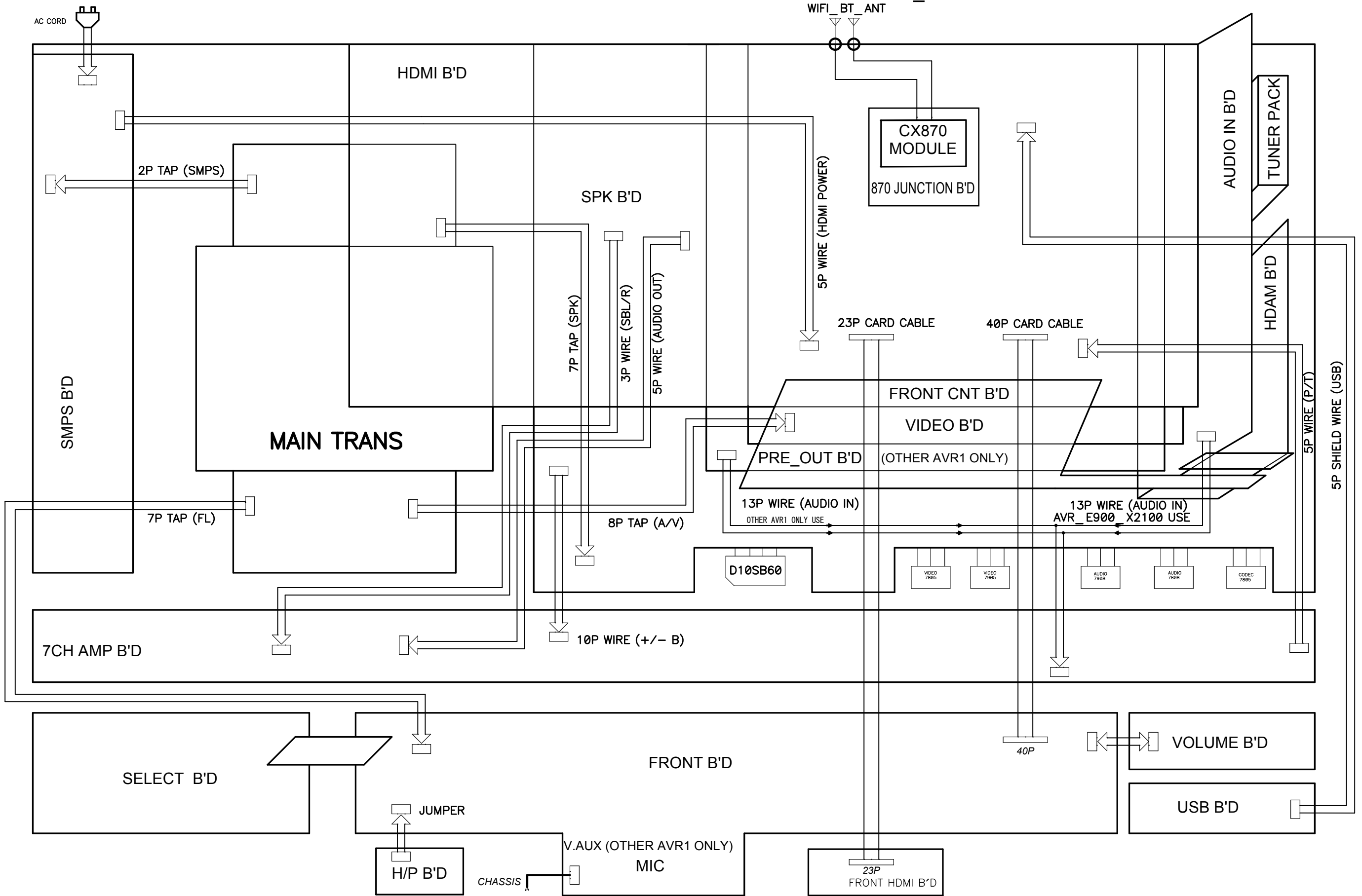

# PRINTED WIRING BOARDS

**Lead-free Solder**  
When soldering, use the Lead-free Solder (Sn-Ag-Cu).

**HDMI (A SIDE)**

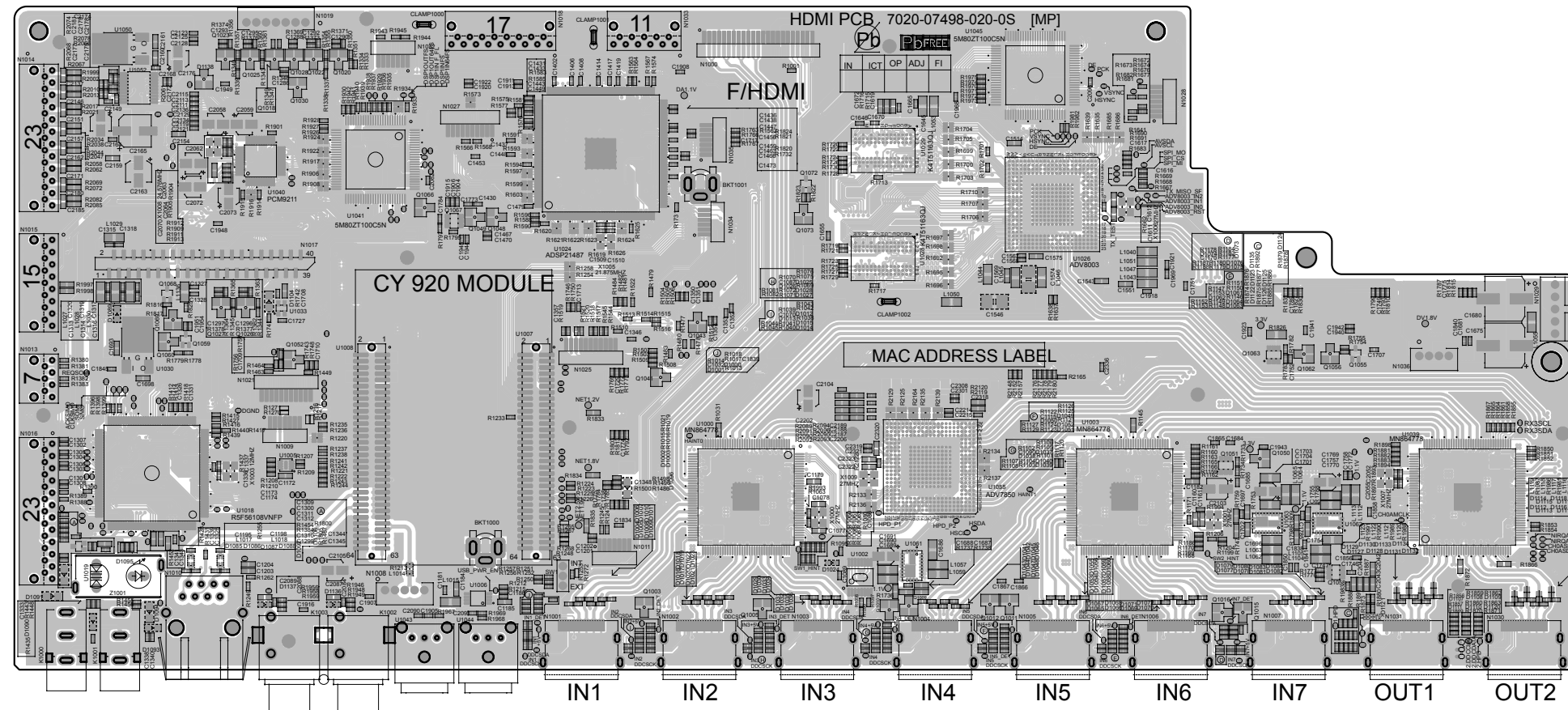

**FRONT HDMI (A SIDE)**

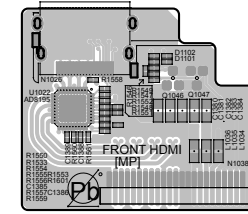

**FRONT HDMI (B SIDE)**

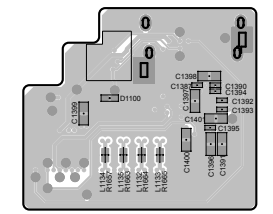

**BLUETOOTH (A SIDE)**

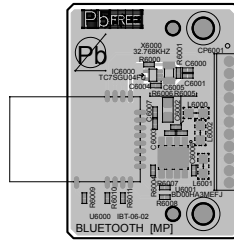

**BLUETOOTH (B SIDE)**

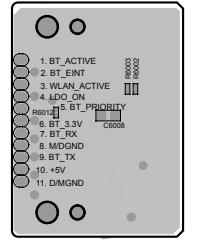

**CX870JUNCTION (A SIDE)**

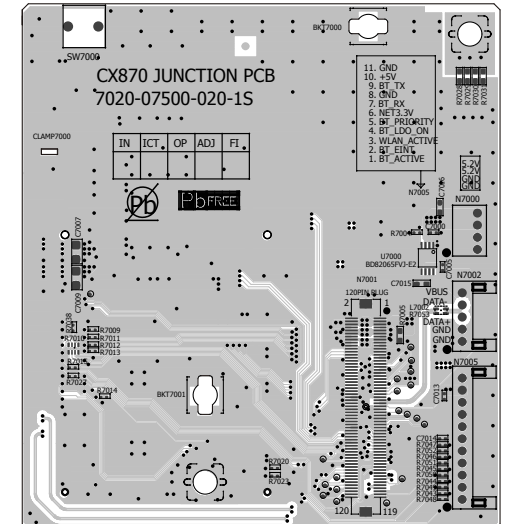

**CX870JUNCTION (B SIDE)**

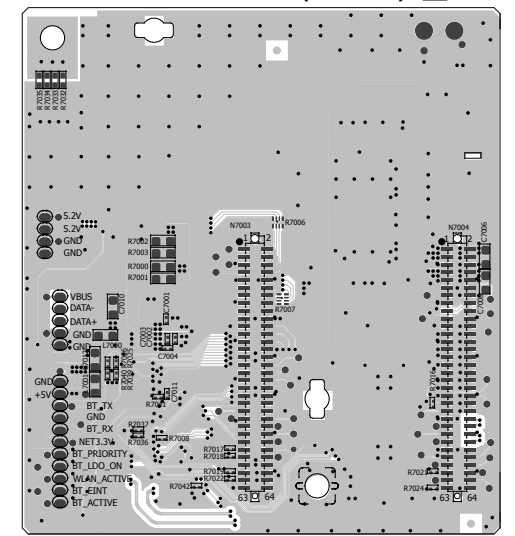



INPUT (A SIDE)

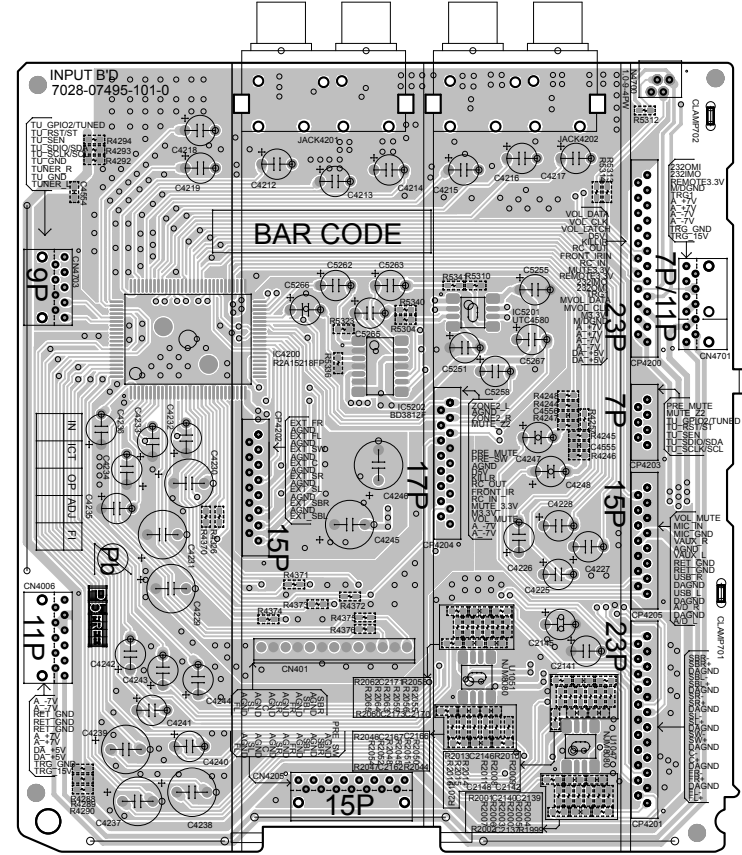

BAR CODE

VIDEO (A SIDE)

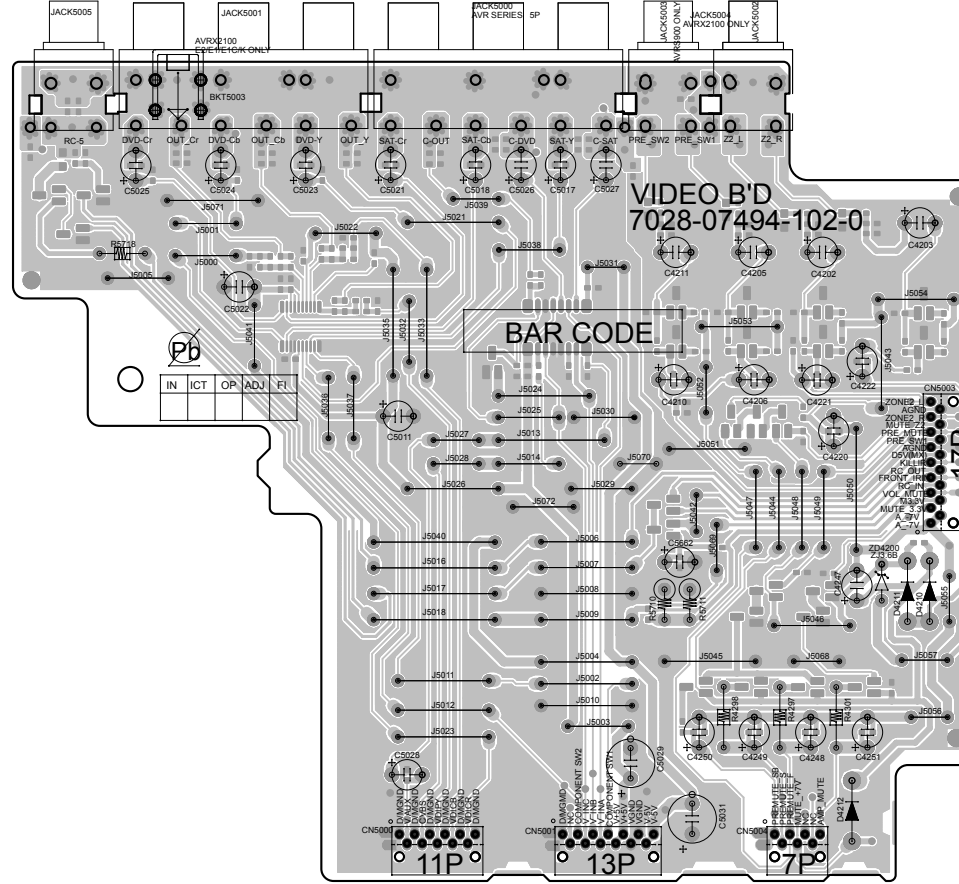

BAR CODE

VIDEO (B SIDE)

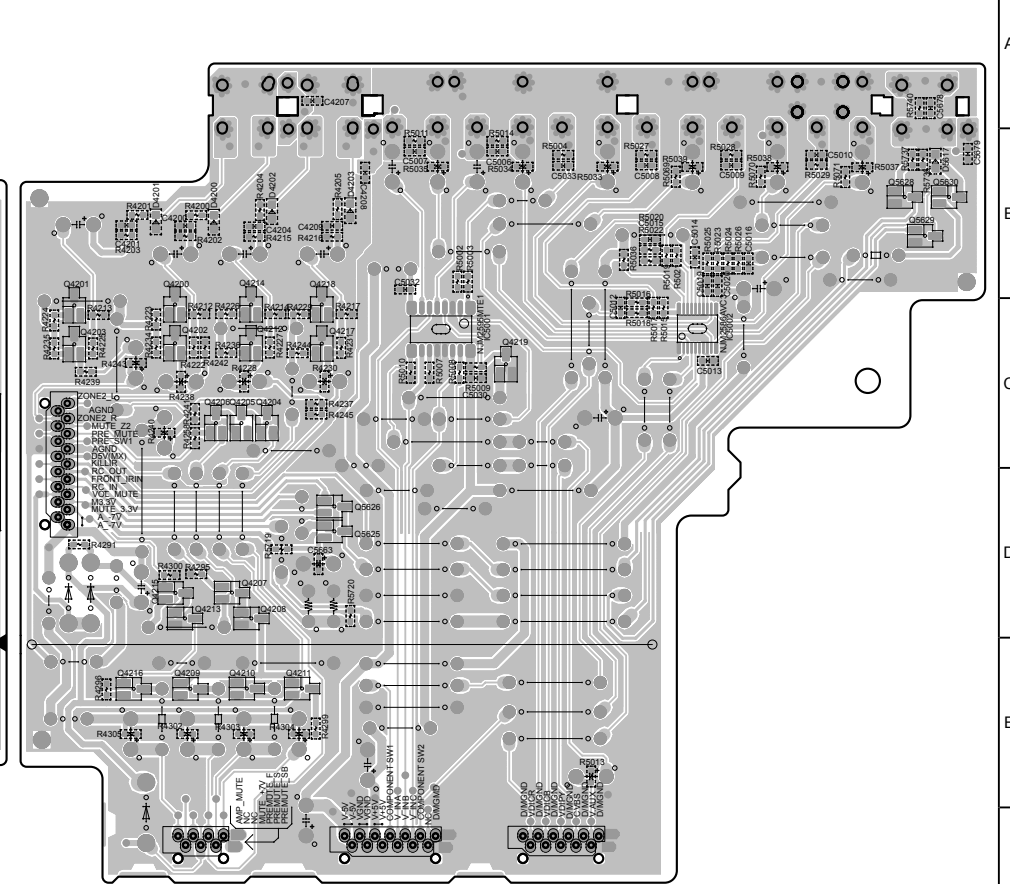

FRONT CONT (A SIDE)

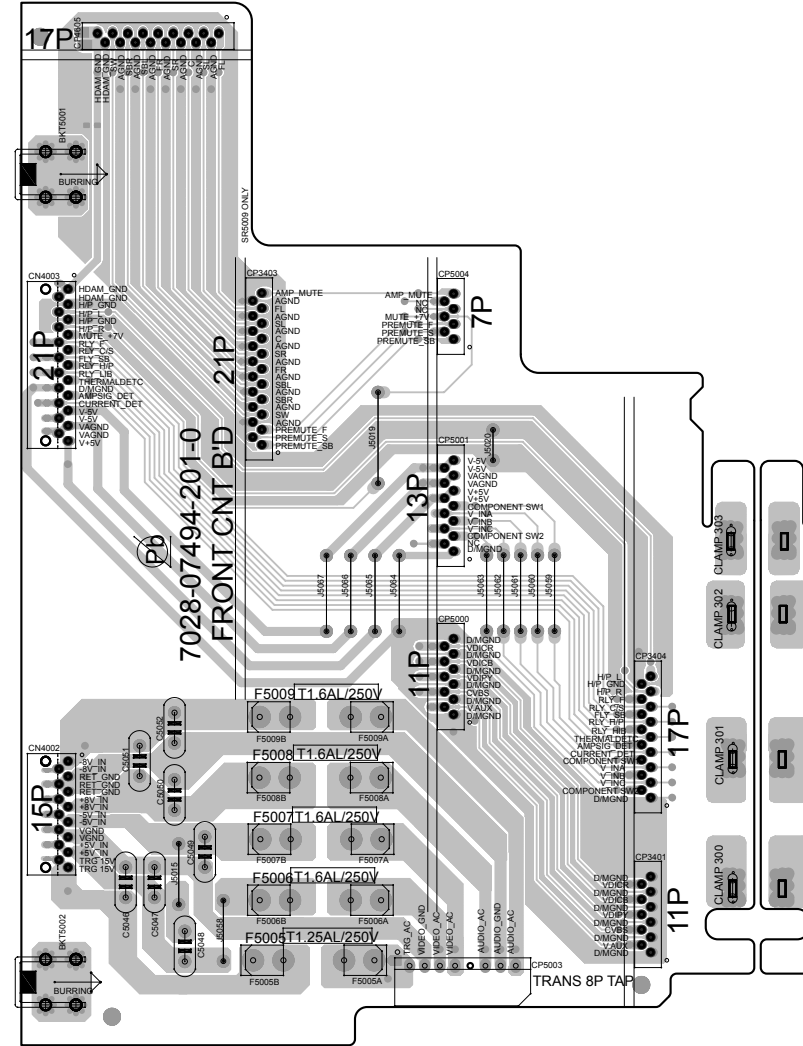

FRONT CNT B'D

FRONT CONT (B SIDE)

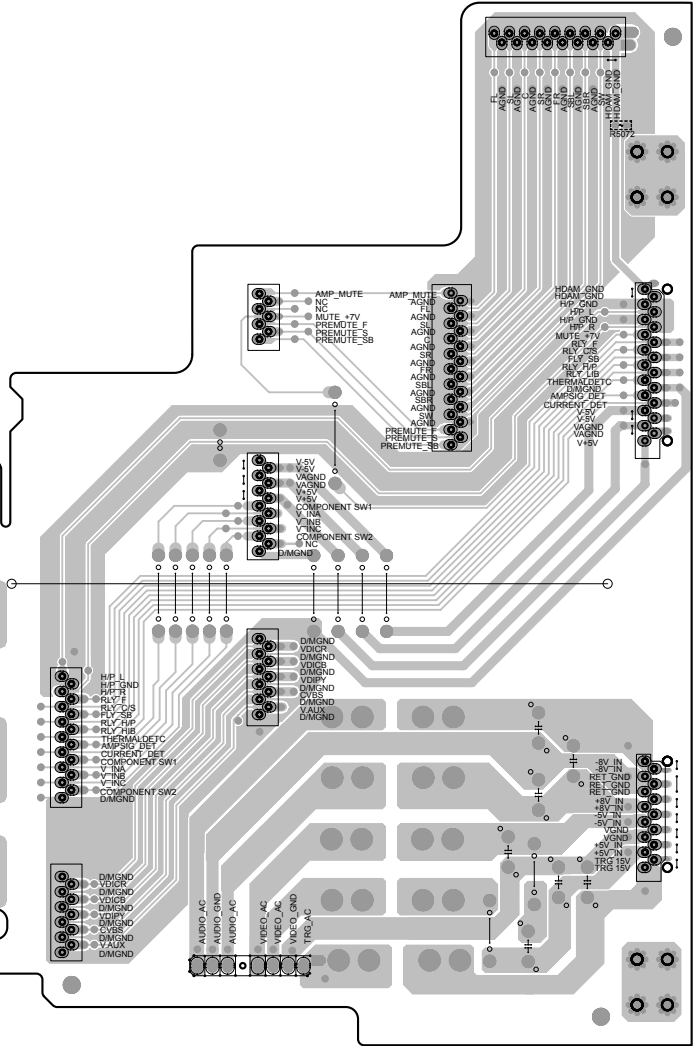

INPUT (B SIDE)

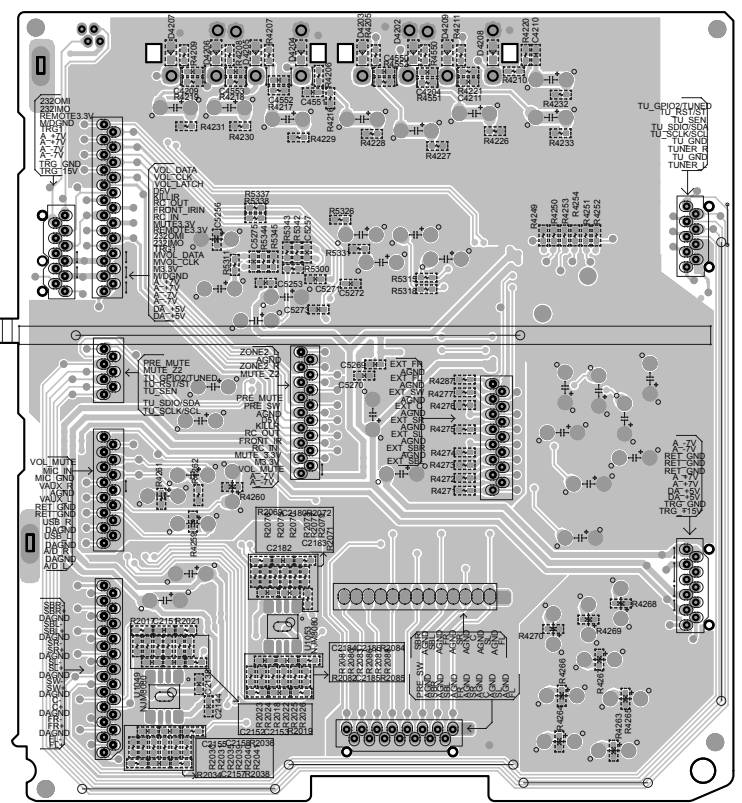

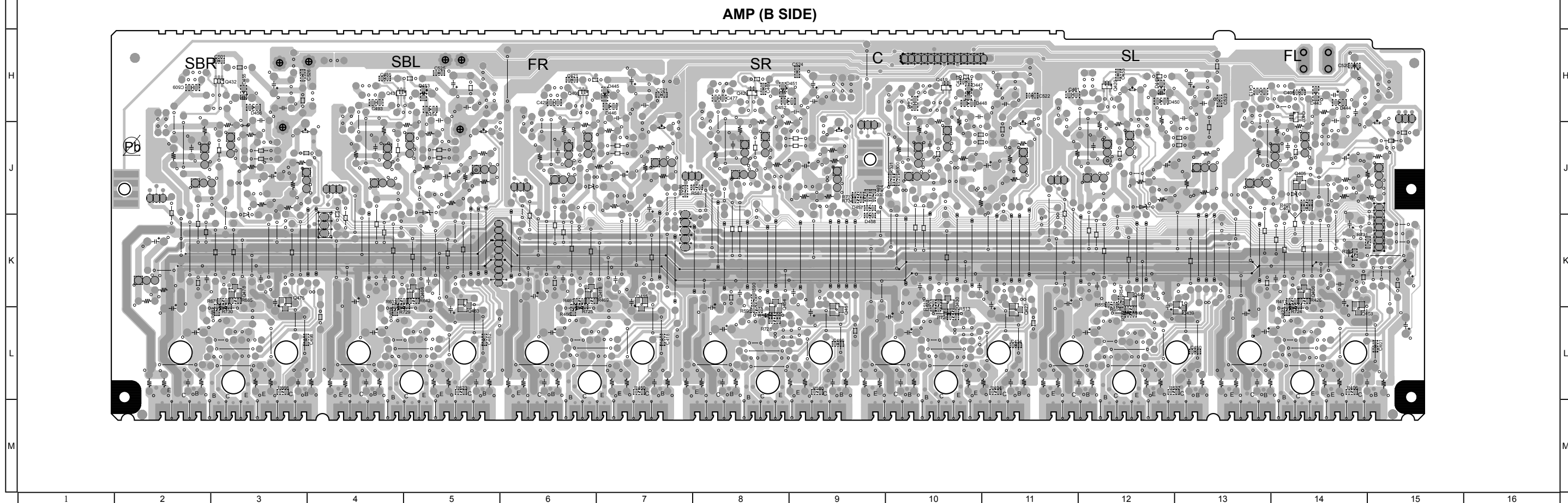
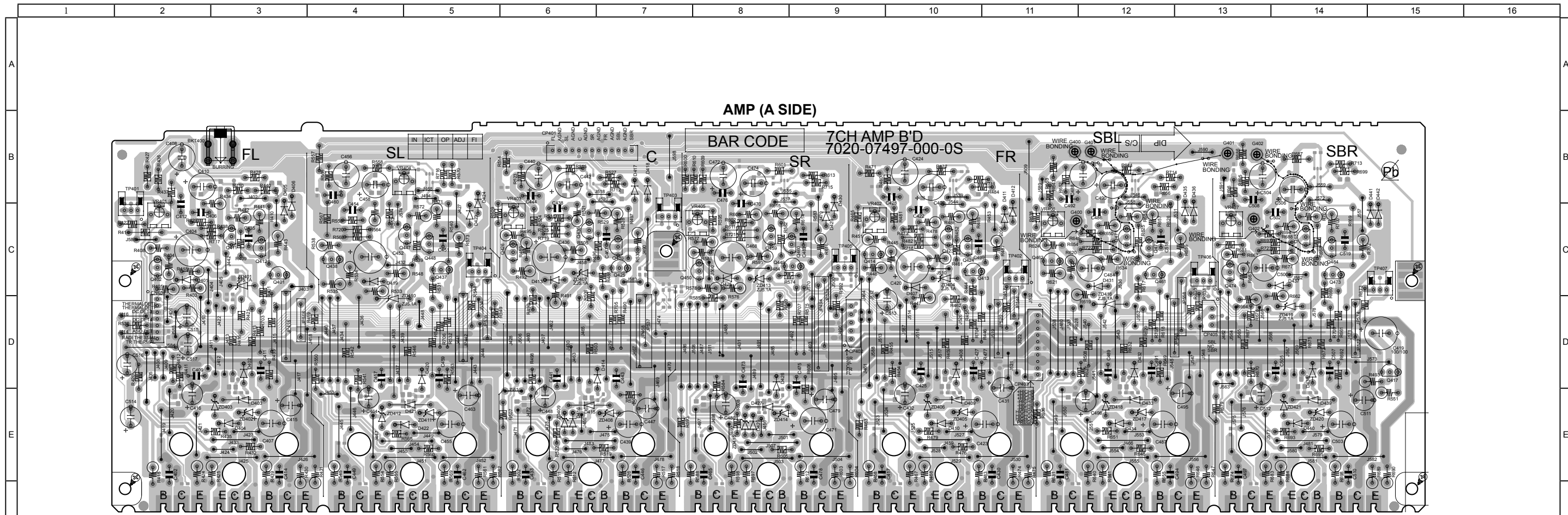

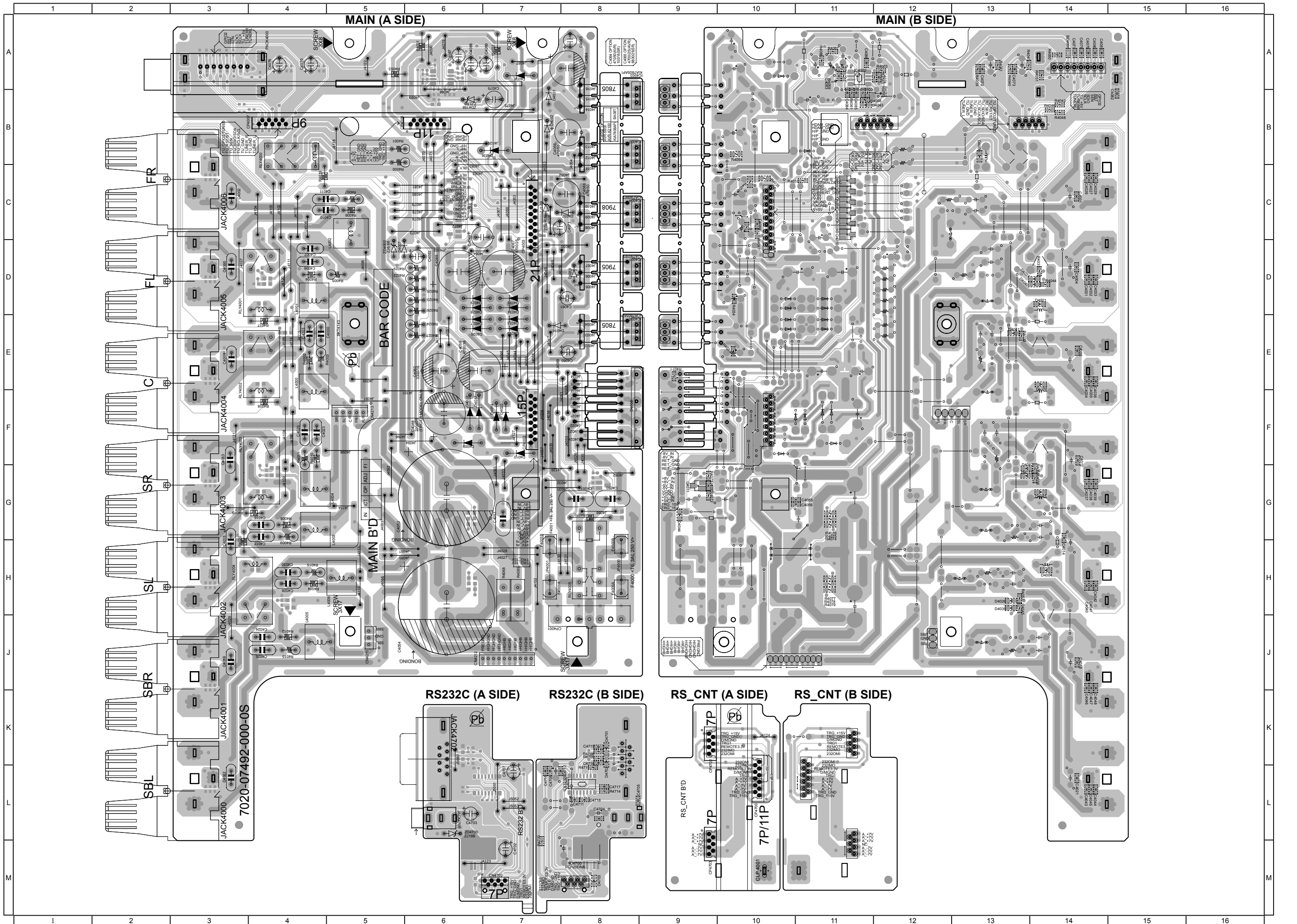

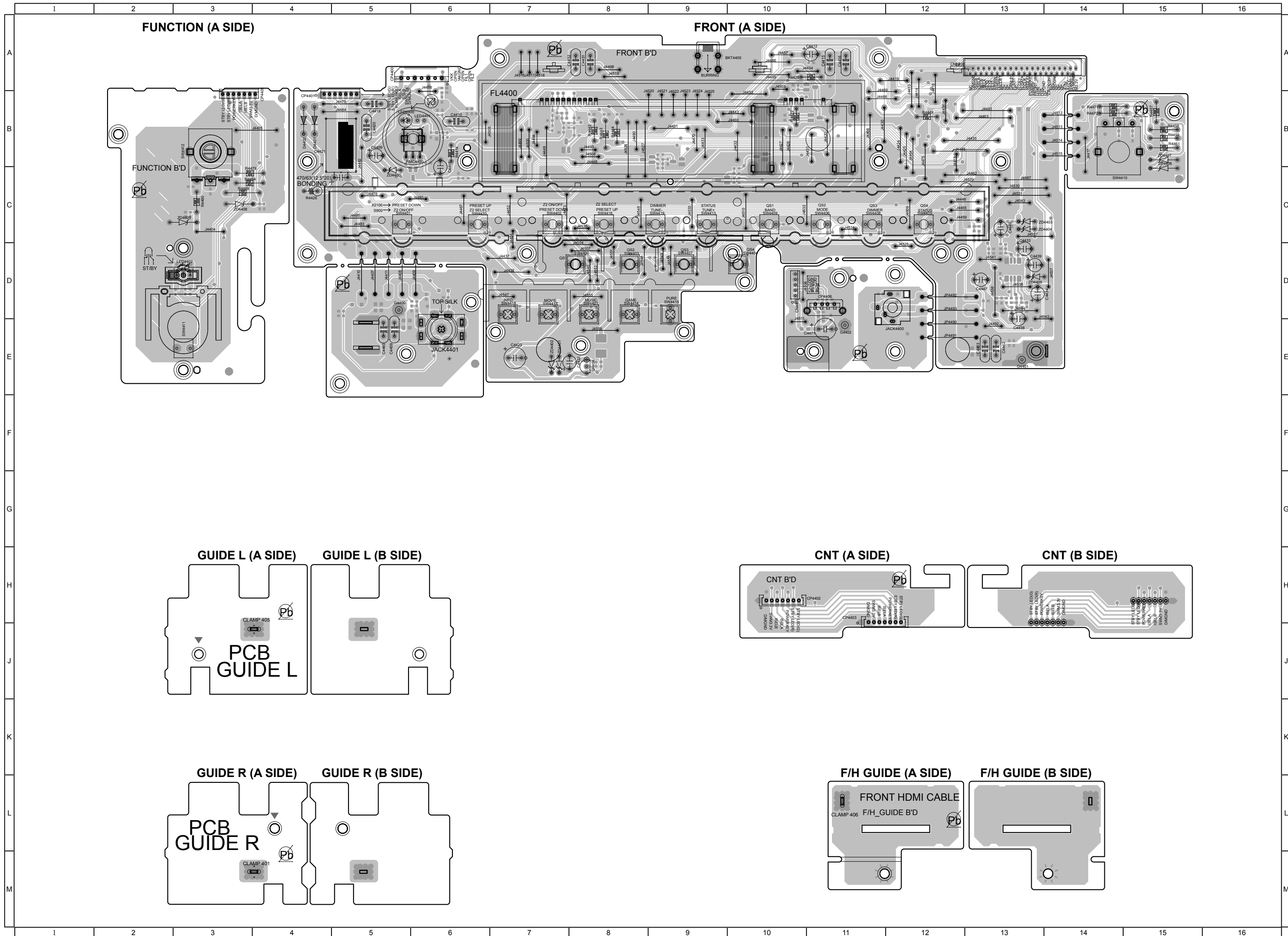

GUIDE L (A SIDE)

GUIDE L (B SIDE)

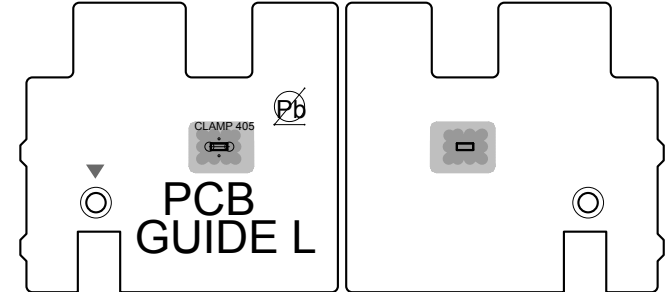

PCB GUIDE L

CNT (A SIDE)

CNT (B SIDE)

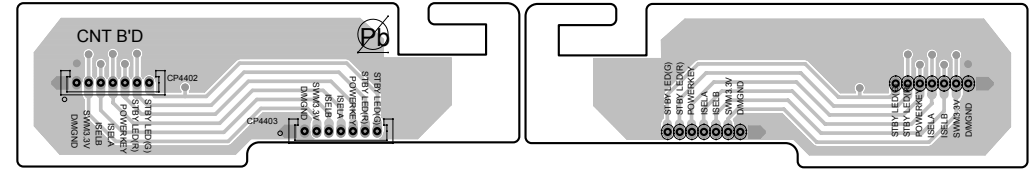

GUIDE R (A SIDE)

GUIDE R (B SIDE)

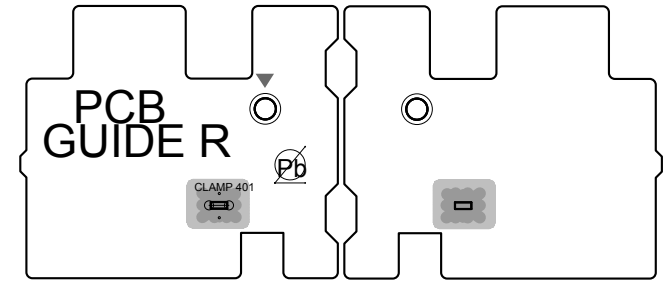

PCB GUIDE R

F/H GUIDE (A SIDE)

F/H GUIDE (B SIDE)

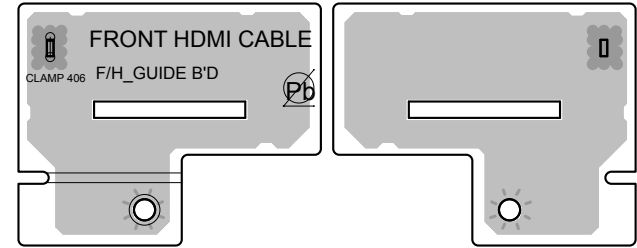



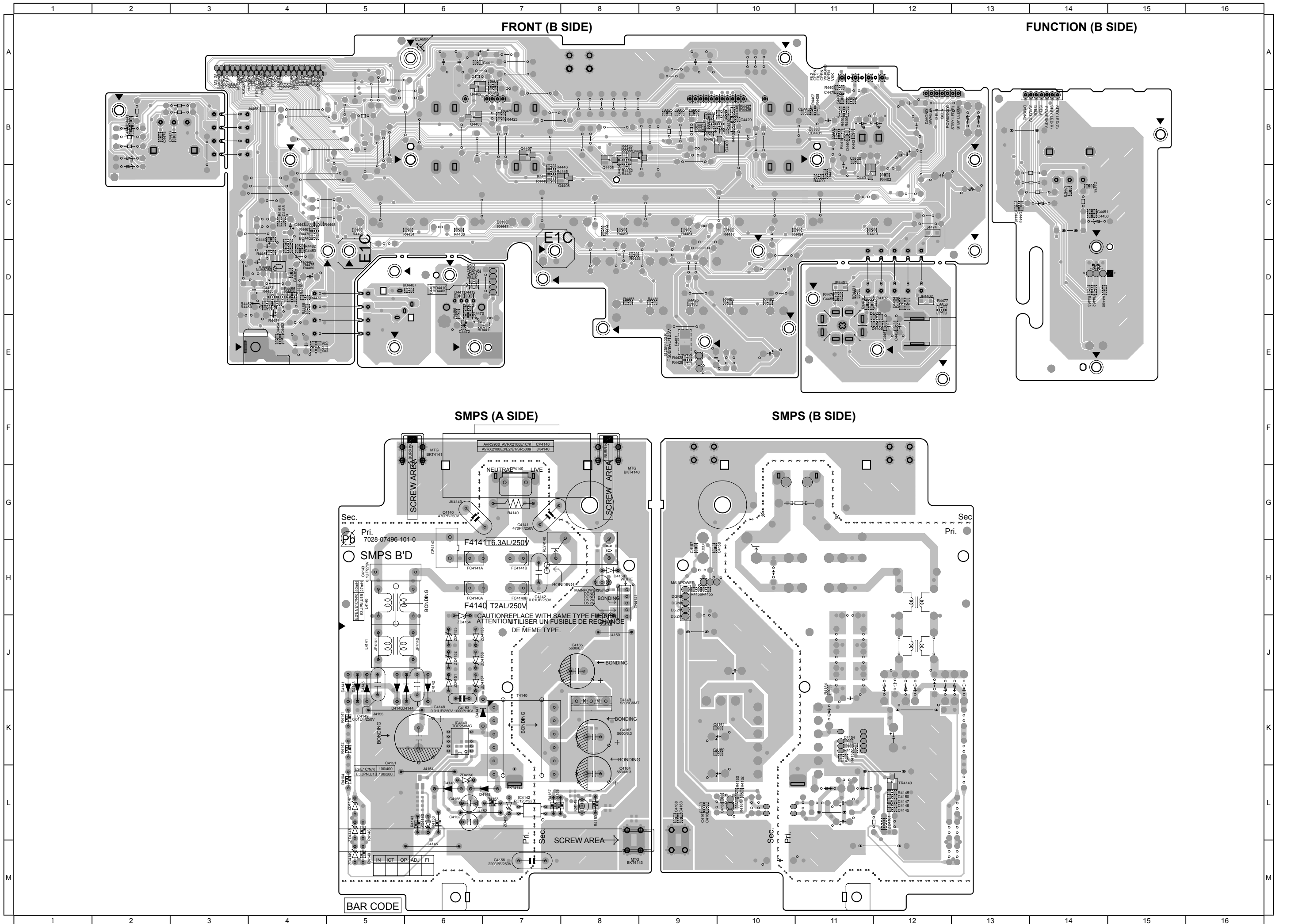

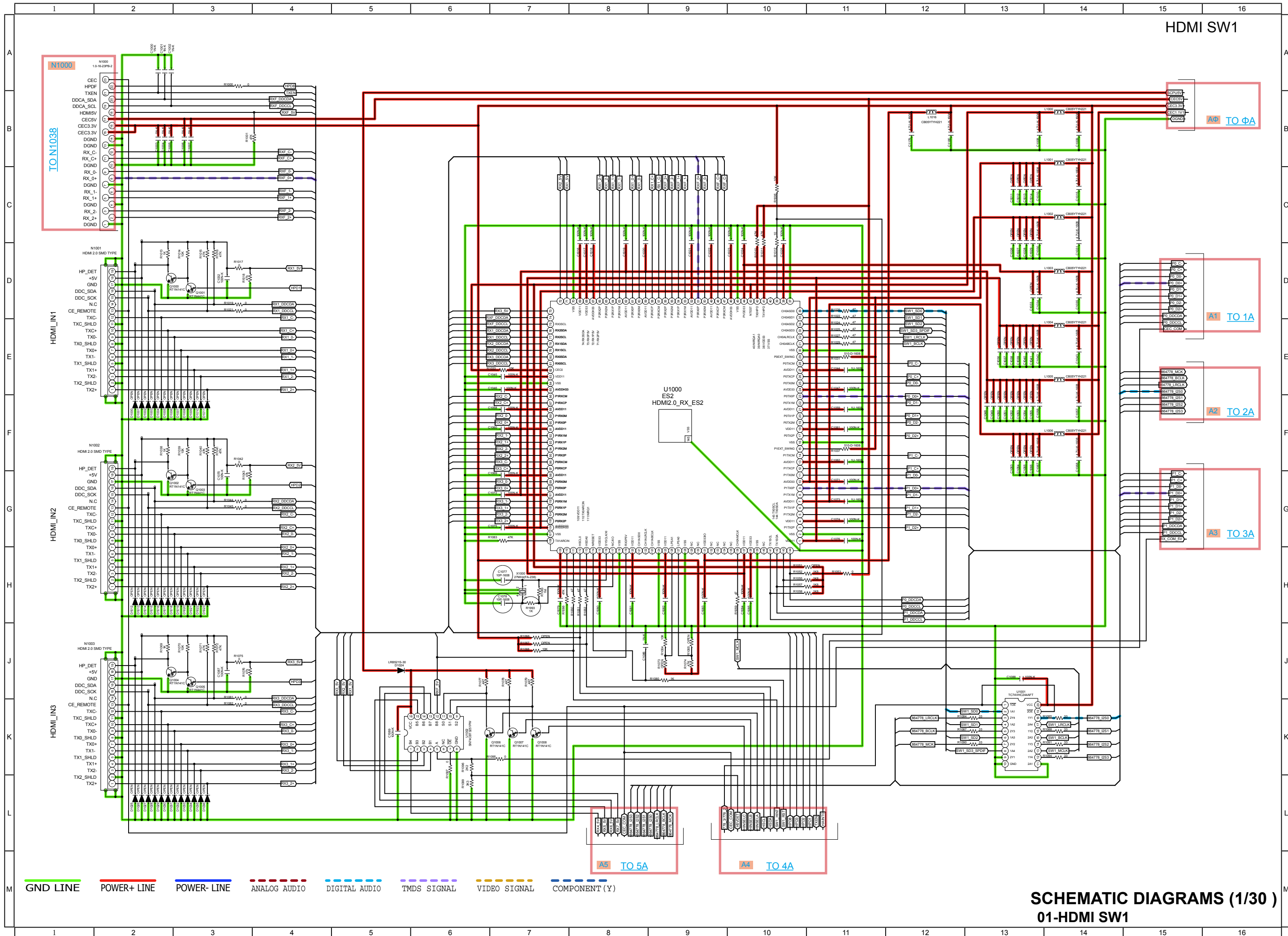

SCHEMATIC DIAGRAMS (1/30)  
01-HDMI SW1

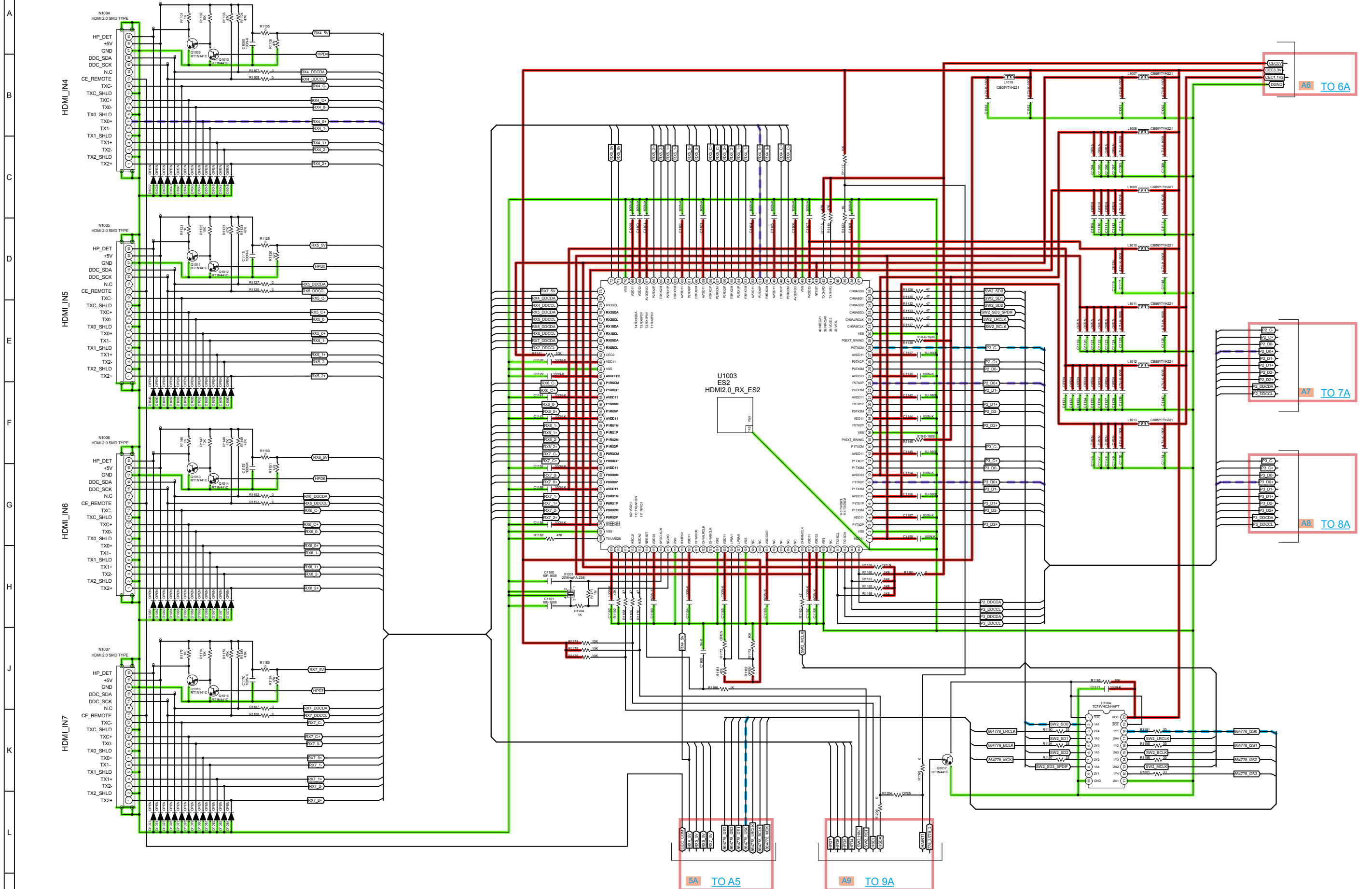

— GND LINE   
 — POWER+ LINE   
 — POWER- LINE   
 - - - ANALOG AUDIO   
 - - - DIGITAL AUDIO   
 - - - TMDS SIGNAL   
 - - - VIDEO SIGNAL   
 - - - COMPONENT (Y)

SCHEMATIC DIAGRAMS (2/30)  
02-HDMI SW2

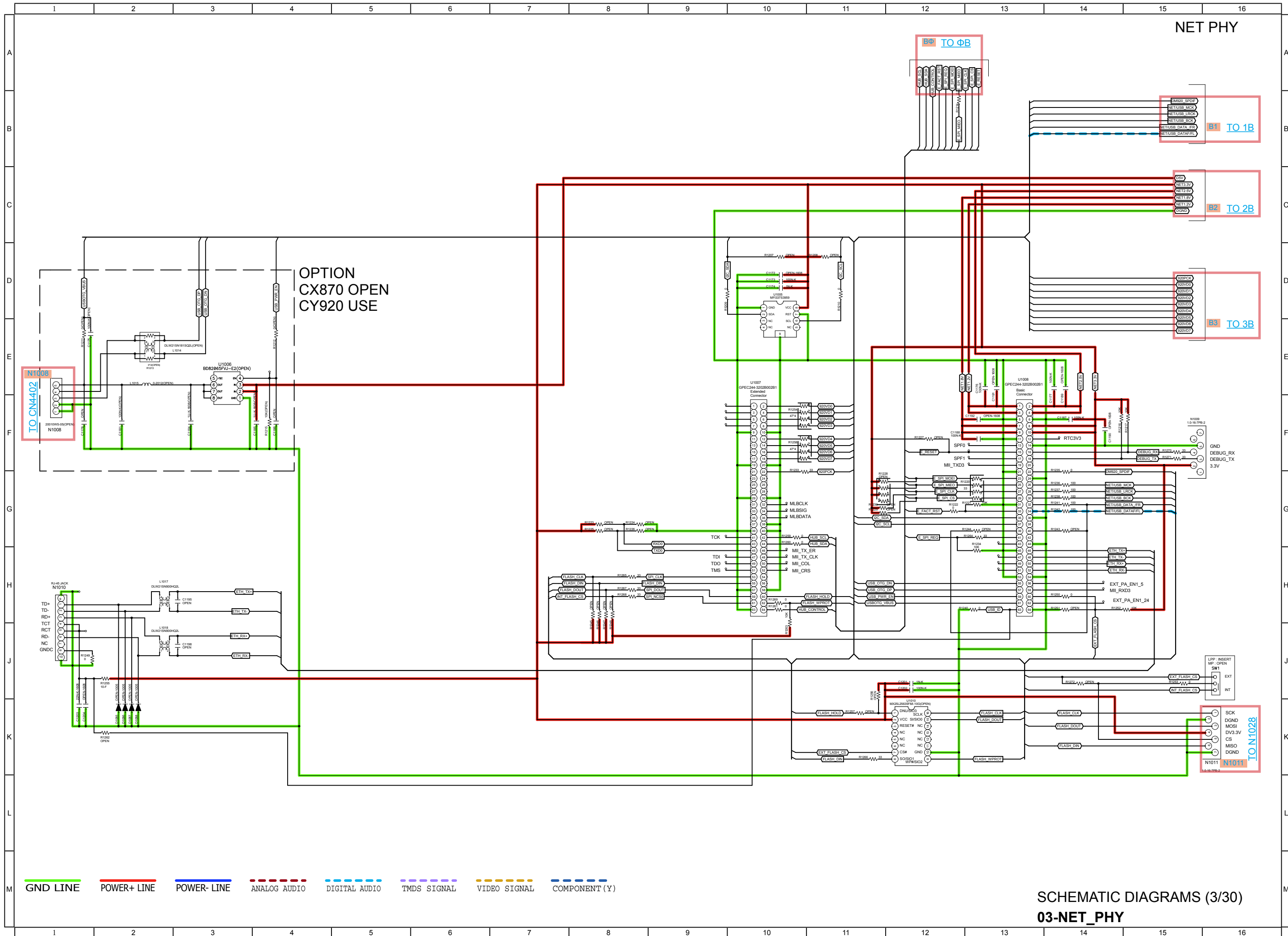

NET PHY

OPTION  
CX870 OPEN  
CY920 USE

SCHEMATIC DIAGRAMS (3/30)  
03-NET\_PHY



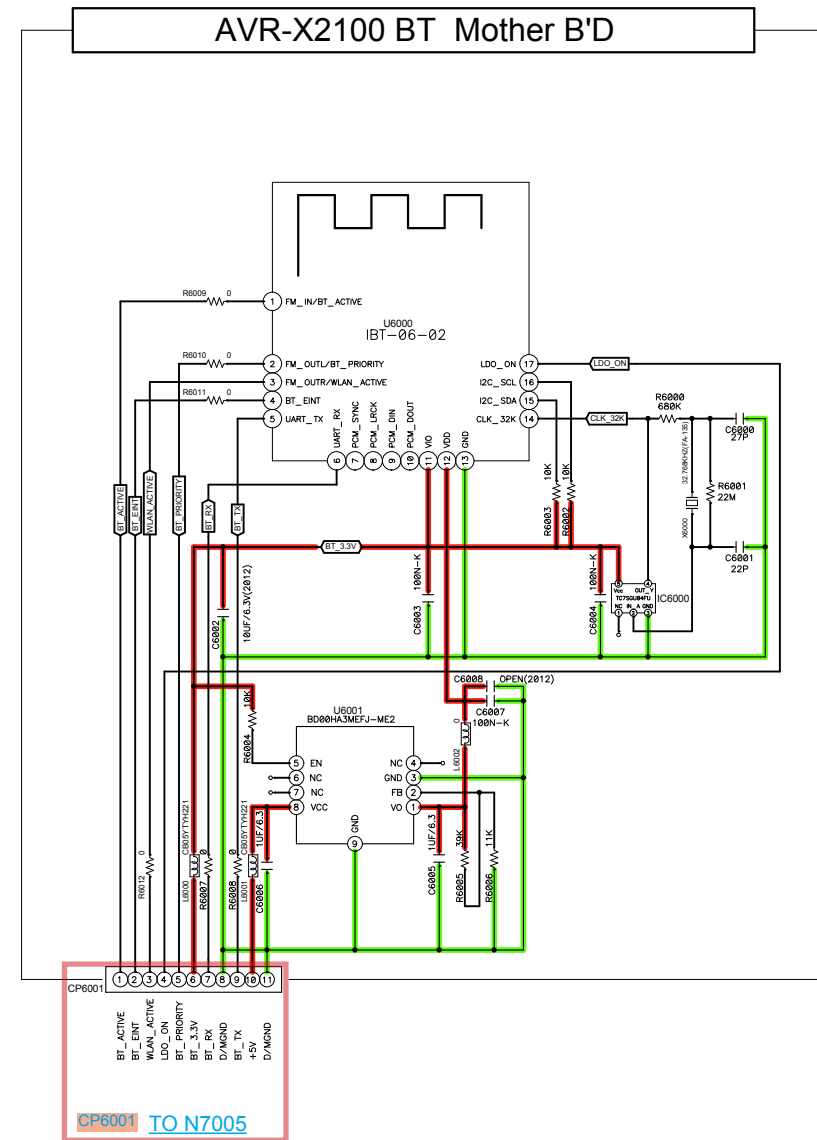

- GND LINE
- POWER+ LINE
- POWER- LINE
- - - ANALOG AUDIO
- - - DIGITAL AUDIO
- - - TMS SIGNAL
- - - VIDEO SIGNAL
- - - COMPONENT (Y)

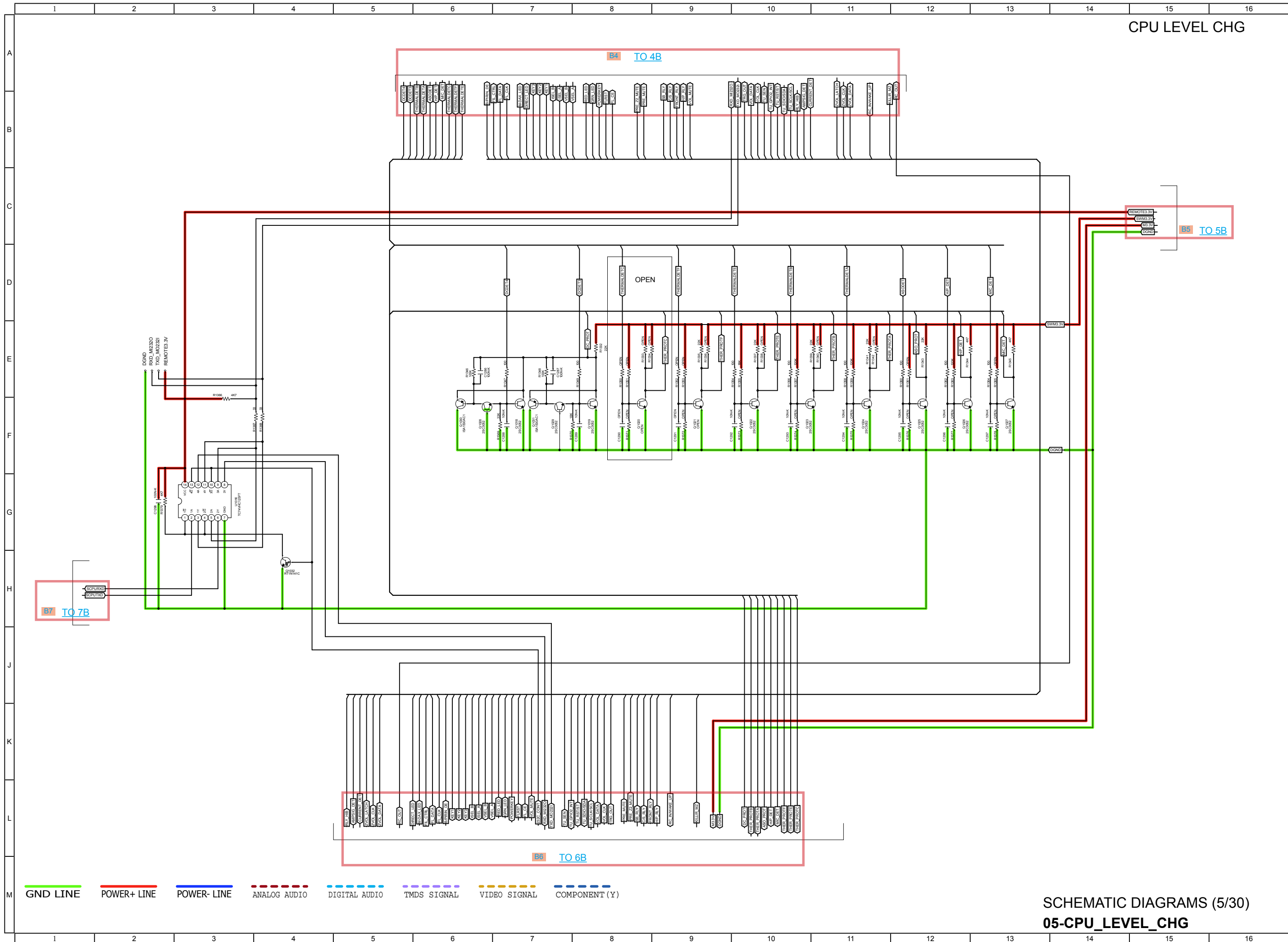

SCHEMATIC DIAGRAMS (5/30)  
05-CPU\_LEVEL\_CHG

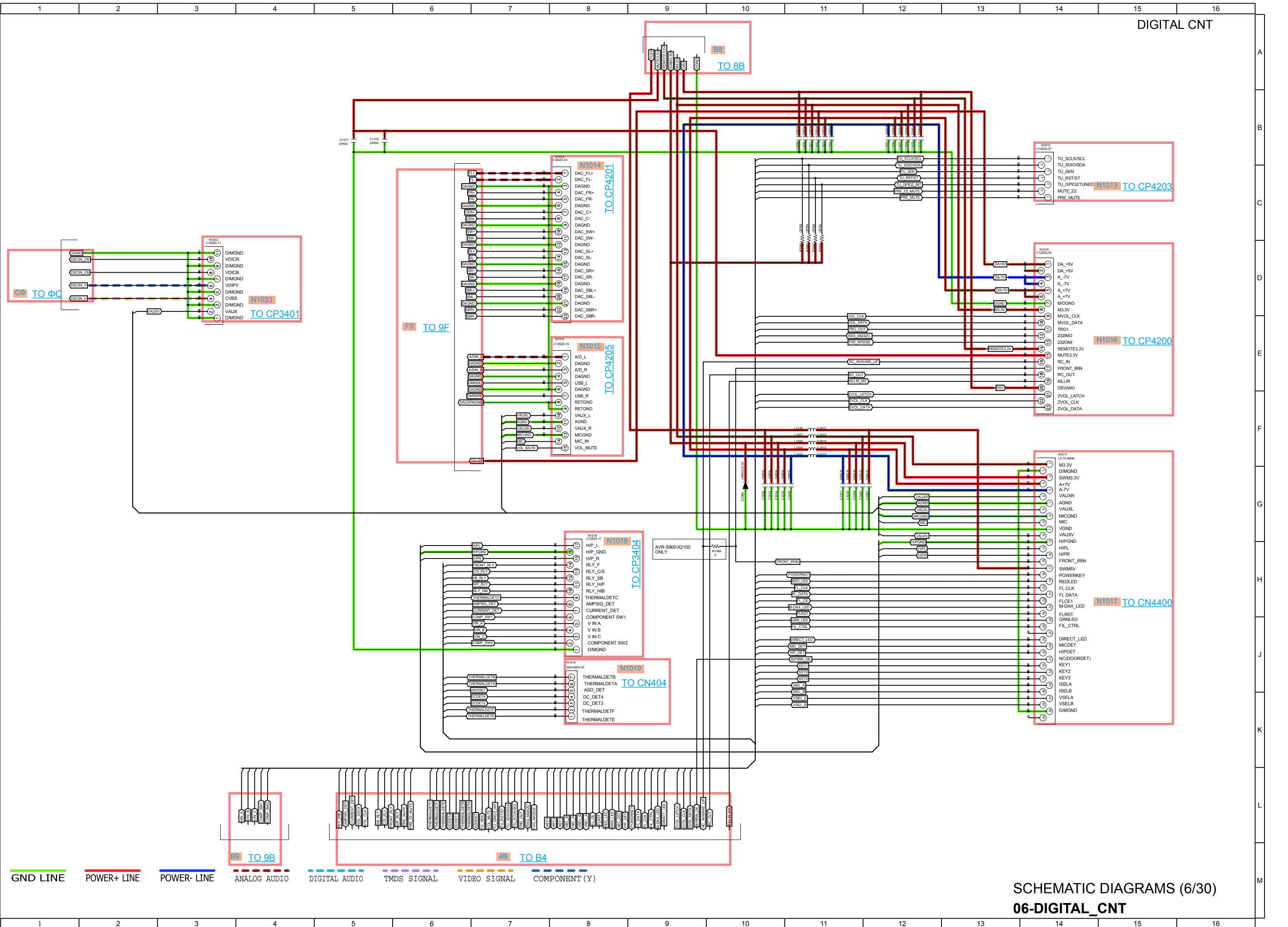

— GND LINE   
 — POWER+ LINE   
 — POWER- LINE   
 - - - ANALOG AUDIO   
 - - - DIGITAL AUDIO   
 - - - TMS SIGNAL   
 - - - VIDEO SIGNAL   
 - - - COMPONENT (Y)

SCHEMATIC DIAGRAMS (6/30)  
06-DIGITAL\_CNT

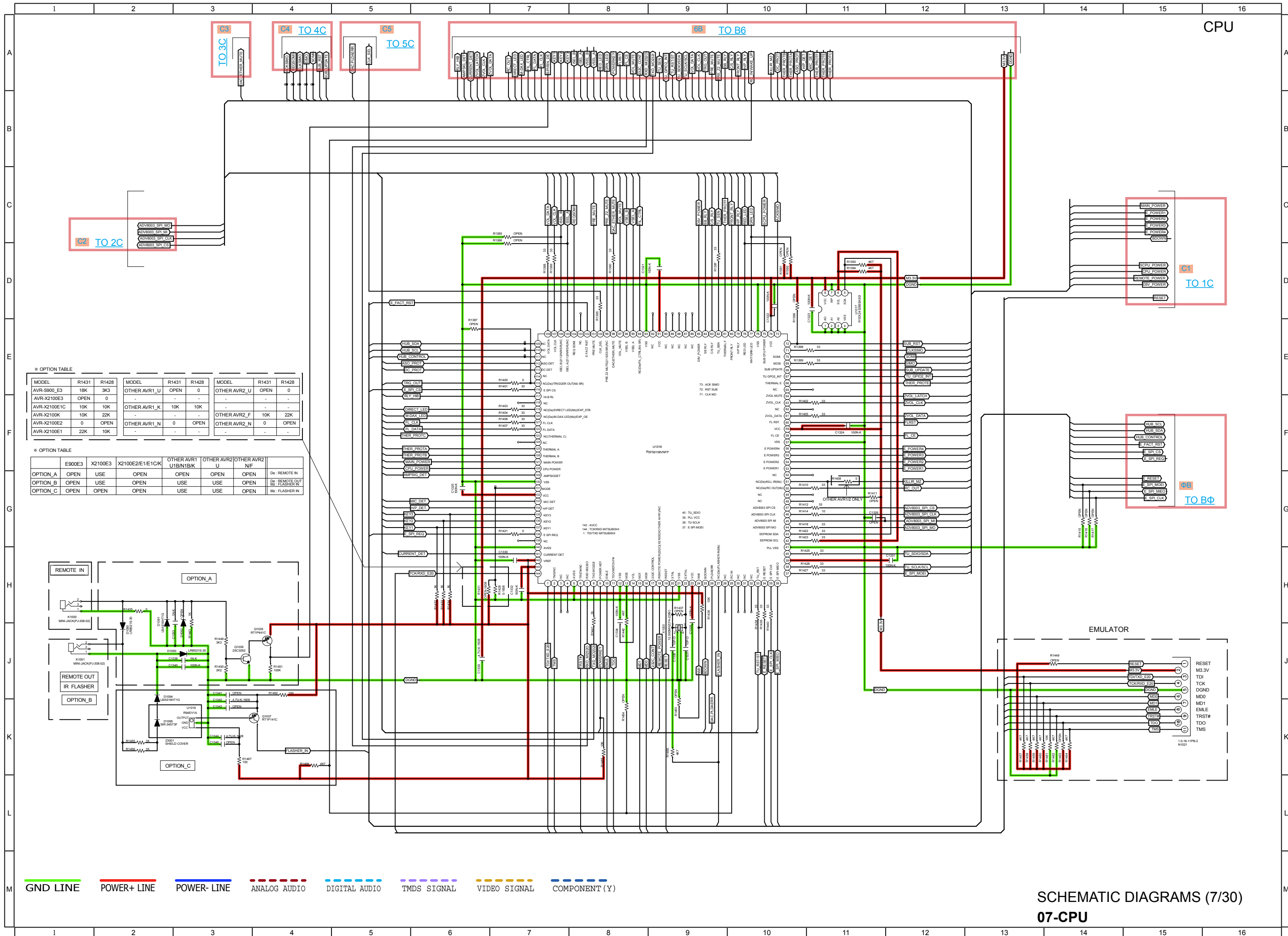

SCHEMATIC DIAGRAMS (7/30)  
07-CPU

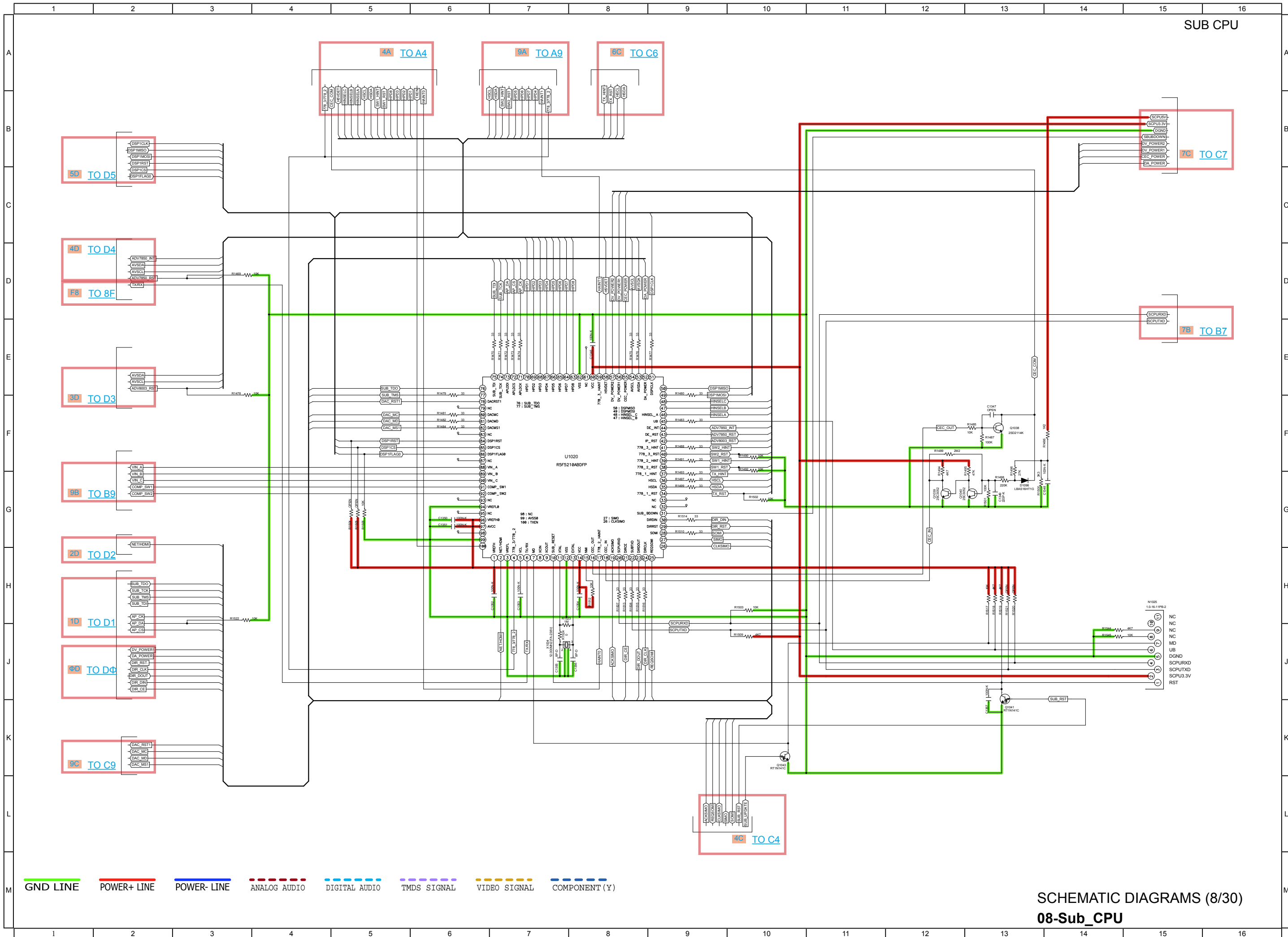

SUB CPU

SCHEMATIC DIAGRAMS (8/30)  
08-Sub\_CPU

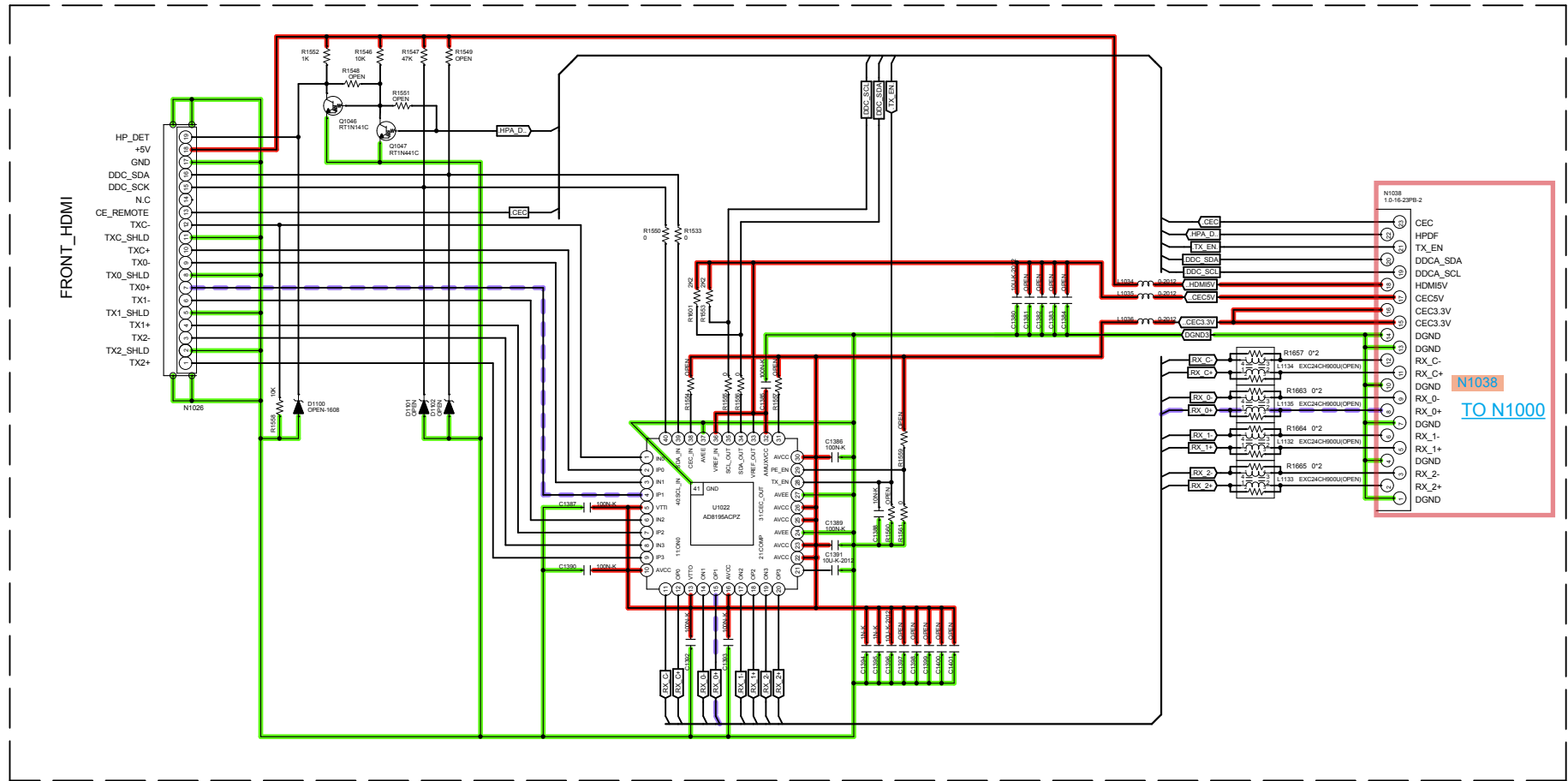

- GND LINE
- POWER+ LINE
- POWER- LINE
- ANALOG AUDIO
- DIGITAL AUDIO
- TMDS SIGNAL
- VIDEO SIGNAL
- COMPONENT (Y)

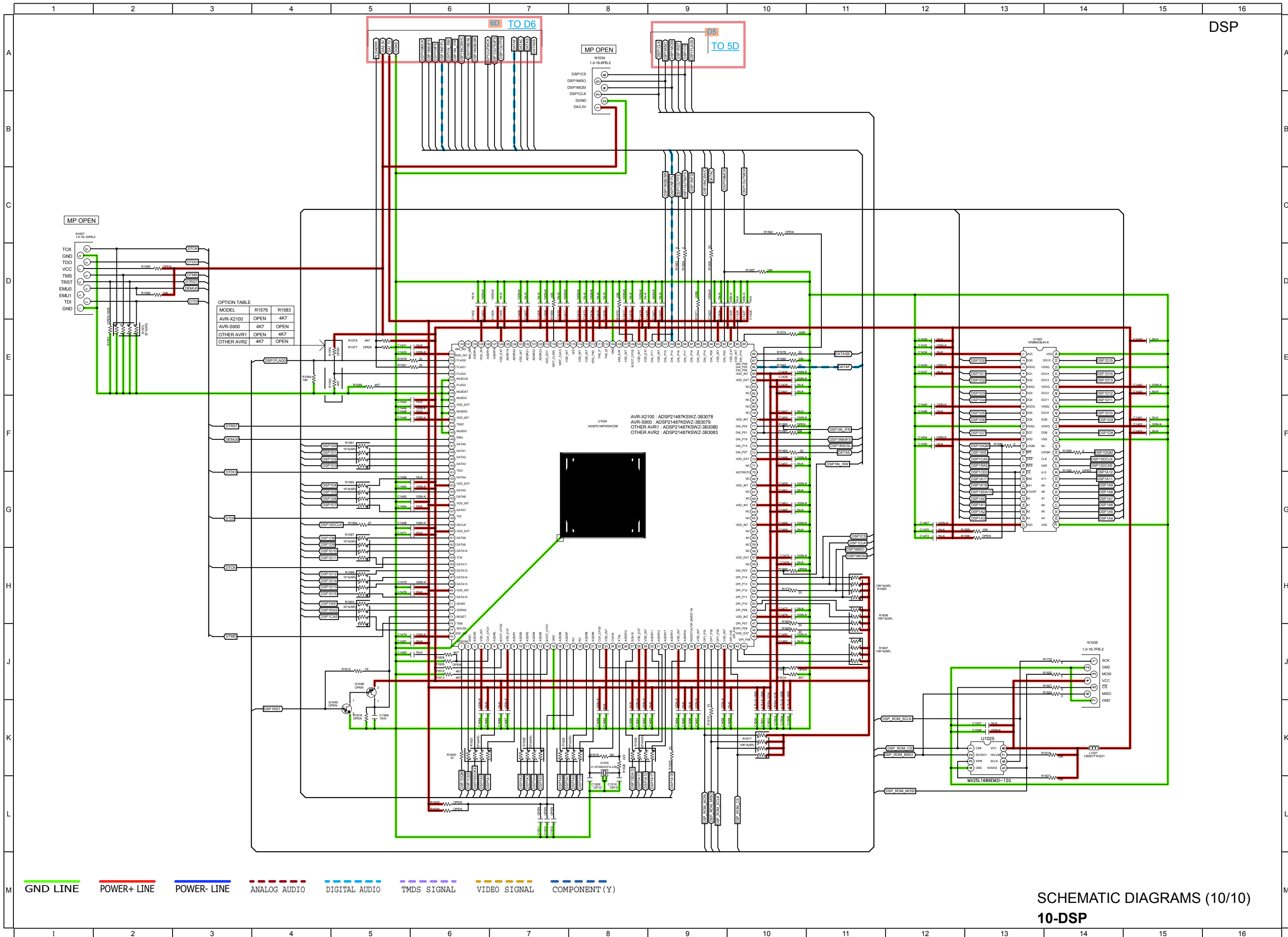

SCHEMATIC DIAGRAMS (10/10)  
**10-DSP**



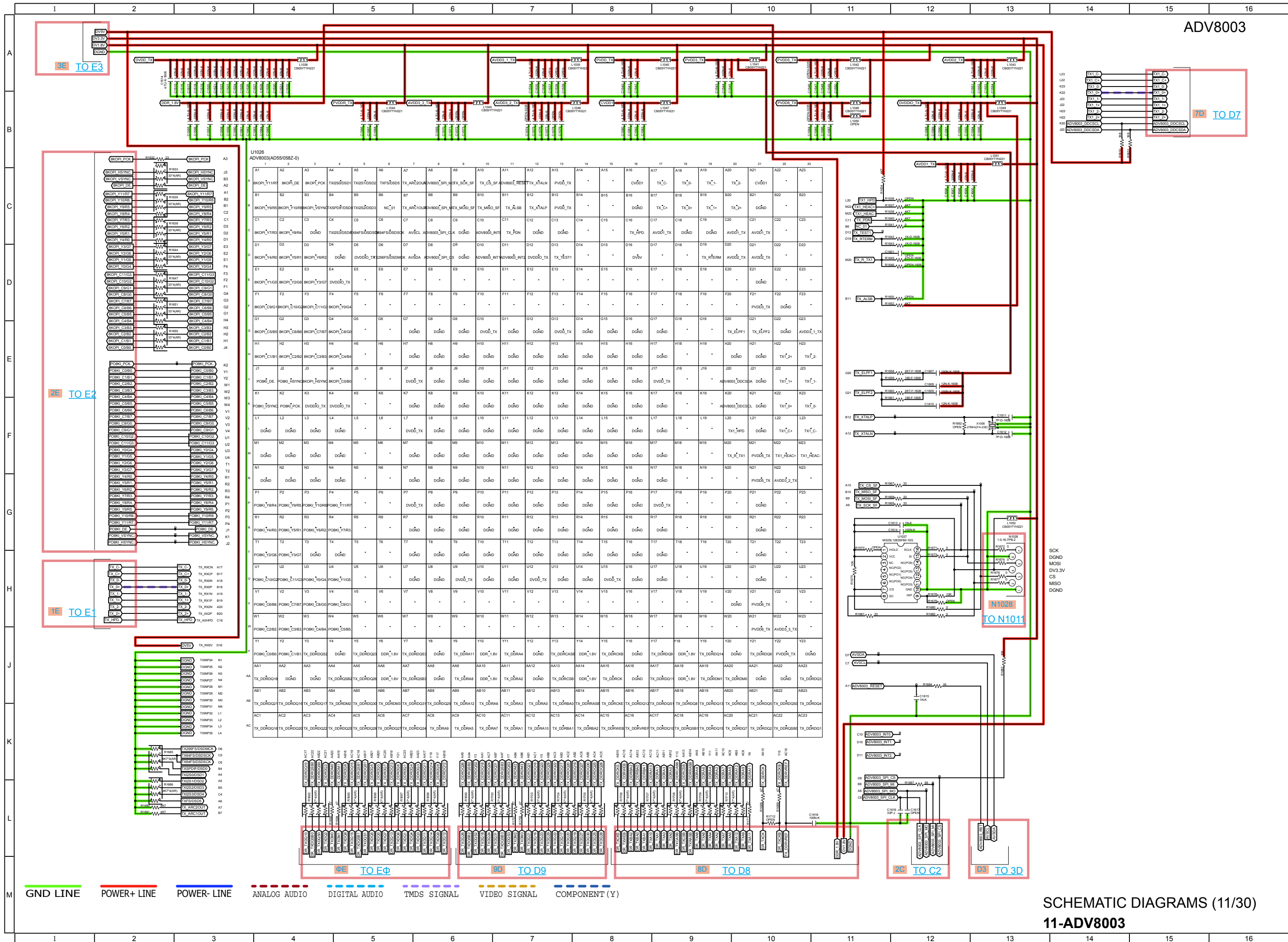

7D TO D7

2E TO E2

1E TO E1

N1028 TO N1011

9E TO E4

9D TO D9

8D TO D8

2C TO C2

D3 TO 3D

GND LINE POWER+ LINE POWER- LINE ANALOG AUDIO DIGITAL AUDIO TMDS SIGNAL VIDEO SIGNAL COMPONENT (Y)



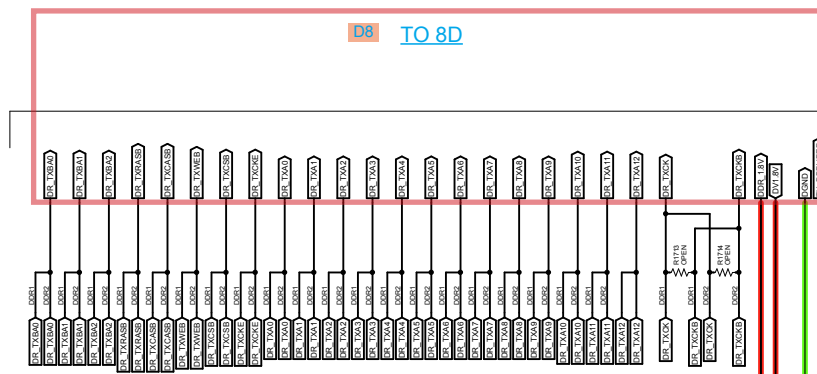
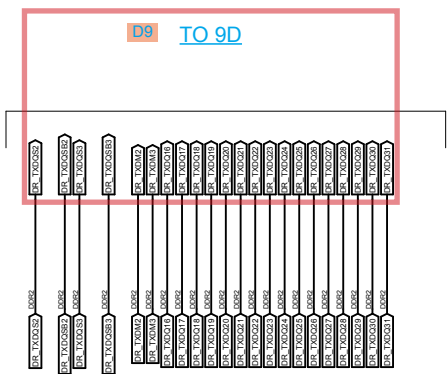
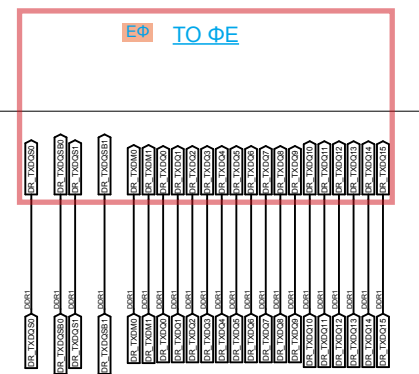

	1	2	3	4	5	6	7	8	9
A1	DDR_1_8V	DGND	DGND	DGND	DGND	DR_TXDQ25	DR_TXDQ26	DR_TXDQ27	DR_TXDQ28
B1	DR_TXDQ14	DGND	DR_TXDM1	DGND	DGND	DR_TXDQ29	DR_TXDQ30	DR_TXDQ31	DR_TXDQ32
C1	DDR_1_8V	DR_TXDQ6	DDR_1_8V	DGND	DGND	DR_TXDQ33	DR_TXDQ34	DR_TXDQ35	DR_TXDQ36
D1	DR_TXDQ12	DGND	DR_TXDQ11	DGND	DGND	DR_TXDQ37	DR_TXDQ38	DR_TXDQ39	DR_TXDQ40
E1	DDR_1_8V	DGND	DGND	DGND	DGND	DR_TXDQ41	DR_TXDQ42	DR_TXDQ43	DR_TXDQ44
F1	DR_TXDQ6	DGND	DR_TXDM0	DGND	DGND	DR_TXDQ45	DR_TXDQ46	DR_TXDQ47	DR_TXDQ48
G1	DDR_1_8V	DR_TXDQ1	DDR_1_8V	DGND	DGND	DR_TXDQ49	DR_TXDQ50	DR_TXDQ51	DR_TXDQ52
H1	DR_TXDQ4	DGND	DR_TXDQ3	DGND	DGND	DR_TXDQ53	DR_TXDQ54	DR_TXDQ55	DR_TXDQ56
J1	DDR_1_8V	TX_DDRVREF	DGND	DGND	DGND	DR_TXDQ57	DR_TXDQ58	DR_TXDQ59	DR_TXDQ60
K1	DR_TXCKE	DR_TXWEB	DGND	DGND	DGND	DR_TXDQ61	DR_TXDQ62	DR_TXDQ63	DR_TXDQ64
L1	DR_TXBA2	DR_TXBA0	DR_TXBA1	DGND	DGND	DR_TXDQ65	DR_TXDQ66	DR_TXDQ67	DR_TXDQ68
M1	DR_TXA10	DR_TXA1	DGND	DGND	DGND	DR_TXDQ69	DR_TXDQ70	DR_TXDQ71	DR_TXDQ72
N1	DGND	DR_TXA3	DR_TXA5	DGND	DGND	DR_TXDQ73	DR_TXDQ74	DR_TXDQ75	DR_TXDQ76
P1	DR_TXA7	DR_TXA9	DGND	DGND	DGND	DR_TXDQ77	DR_TXDQ78	DR_TXDQ79	DR_TXDQ80
R1	DDR_1_8V	DR_TXA12	DR_1_RFU1	DGND	DGND	DR_TXDQ81	DR_TXDQ82	DR_TXDQ83	DR_TXDQ84

	1	2	3	4	5	6	7	8	9
A1	DDR_1_8V	DGND	DGND	DGND	DGND	DR_TXDQ25	DR_TXDQ26	DR_TXDQ27	DR_TXDQ28
B1	DR_TXDQ30	DGND	DR_TXDM3	DGND	DGND	DR_TXDQ29	DR_TXDQ30	DR_TXDQ31	DR_TXDQ32
C1	DDR_1_8V	DR_TXDQ25	DDR_1_8V	DGND	DGND	DR_TXDQ33	DR_TXDQ34	DR_TXDQ35	DR_TXDQ36
D1	DR_TXDQ28	DGND	DR_TXDQ27	DGND	DGND	DR_TXDQ37	DR_TXDQ38	DR_TXDQ39	DR_TXDQ40
E1	DDR_1_8V	DGND	DGND	DGND	DGND	DR_TXDQ41	DR_TXDQ42	DR_TXDQ43	DR_TXDQ44
F1	DR_TXDQ22	DGND	DR_TXDM2	DGND	DGND	DR_TXDQ45	DR_TXDQ46	DR_TXDQ47	DR_TXDQ48
G1	DDR_1_8V	DR_TXDQ17	DDR_1_8V	DGND	DGND	DR_TXDQ49	DR_TXDQ50	DR_TXDQ51	DR_TXDQ52
H1	DR_TXDQ20	DGND	DR_TXDQ19	DGND	DGND	DR_TXDQ53	DR_TXDQ54	DR_TXDQ55	DR_TXDQ56
J1	DDR_1_8V	TX_DDRVREF	DGND	DGND	DGND	DR_TXDQ57	DR_TXDQ58	DR_TXDQ59	DR_TXDQ60
K1	DR_TXCKE	DR_TXWEB	DGND	DGND	DGND	DR_TXDQ61	DR_TXDQ62	DR_TXDQ63	DR_TXDQ64
L1	DR_TXBA2	DR_TXBA0	DR_TXBA1	DGND	DGND	DR_TXDQ65	DR_TXDQ66	DR_TXDQ67	DR_TXDQ68
M1	DR_TXA10	DR_TXA1	DGND	DGND	DGND	DR_TXDQ69	DR_TXDQ70	DR_TXDQ71	DR_TXDQ72
N1	DGND	DR_TXA3	DR_TXA5	DGND	DGND	DR_TXDQ73	DR_TXDQ74	DR_TXDQ75	DR_TXDQ76
P1	DR_TXA7	DR_TXA9	DGND	DGND	DGND	DR_TXDQ77	DR_TXDQ78	DR_TXDQ79	DR_TXDQ80
R1	DDR_1_8V	DR_TXA12	DR_2_RFU1	DGND	DGND	DR_2_RFU2	DR_2_RFU3	DR_2_RFU4	DR_2_RFU5

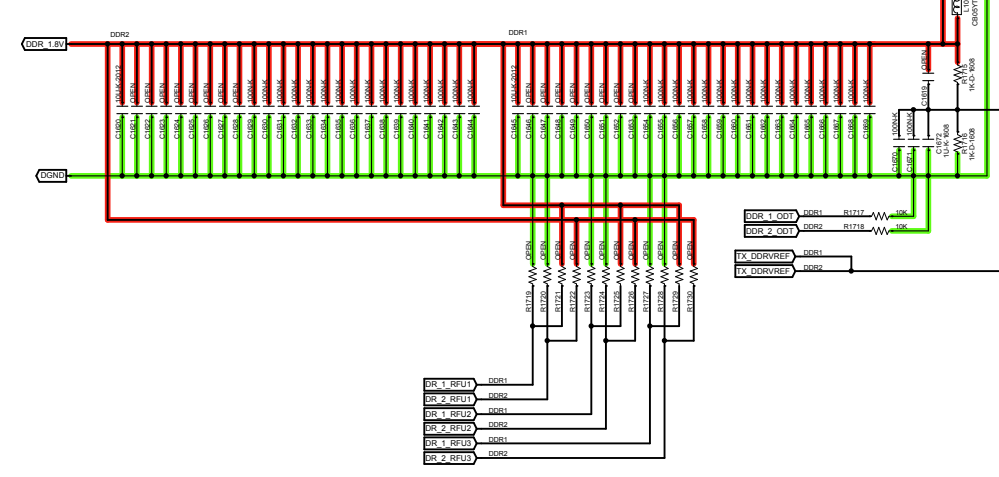

— GND LINE   
 — POWER+ LINE   
 — POWER- LINE   
 - - - ANALOG AUDIO   
 - - - DIGITAL AUDIO   
 - - - TMSD SIGNAL   
 - - - VIDEO SIGNAL   
 - - - COMPONENT (Y)

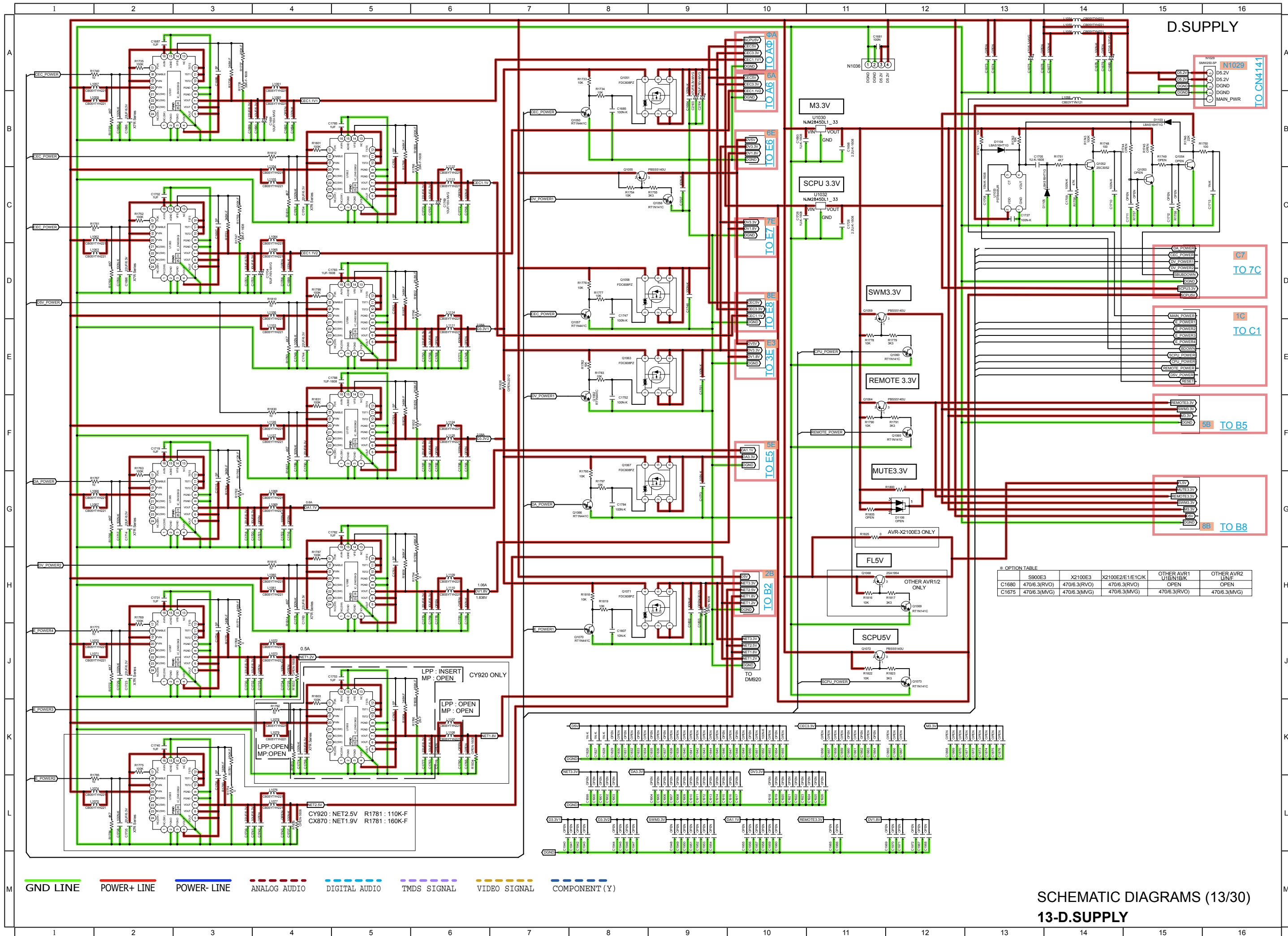

D.SUPPLY

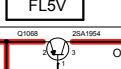
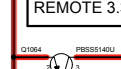
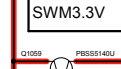
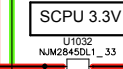
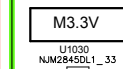
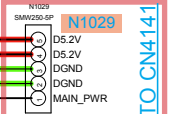

OPTION TABLE

	S90E3	X210E3	X2100E2/E1/E1C/K	OTHER AVR1 U1B/N1BK	OTHER AVR2 U1NF
C1680	470/6.3(RVO)	470/6.3(RVO)	470/6.3(RVO)	OPEN	OPEN
C1675	470/6.3(MVG)	470/6.3(MVG)	470/6.3(MVG)	470/6.3(RVO)	470/6.3(MVG)

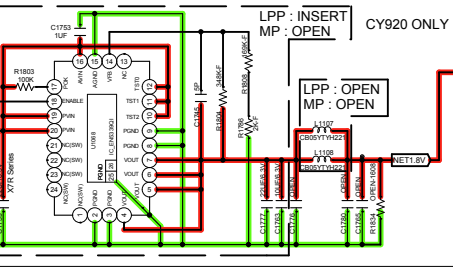

CY920 : NET2.5V R1781 : 110K-F  
CX870 : NET1.9V R1781 : 160K-F

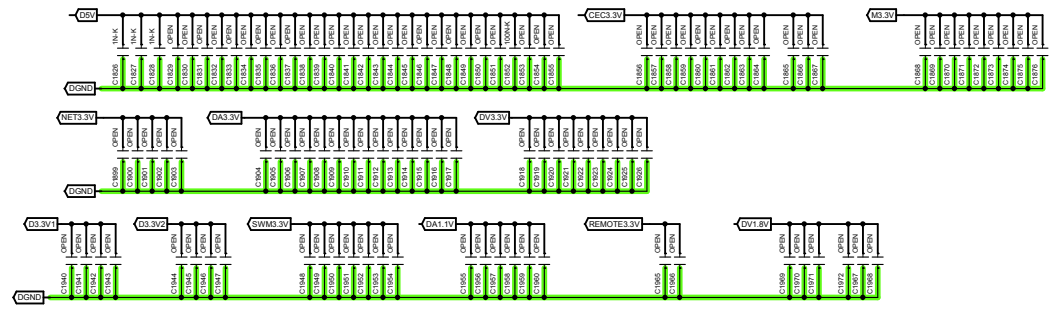

- GND LINE
- POWER+ LINE
- POWER- LINE
- - - ANALOG AUDIO
- - - DIGITAL AUDIO
- - - TMS SIGNAL
- - - VIDEO SIGNAL
- - - COMPONENT (Y)

SCHEMATIC DIAGRAMS (13/30)  
13-D.SUPPLY

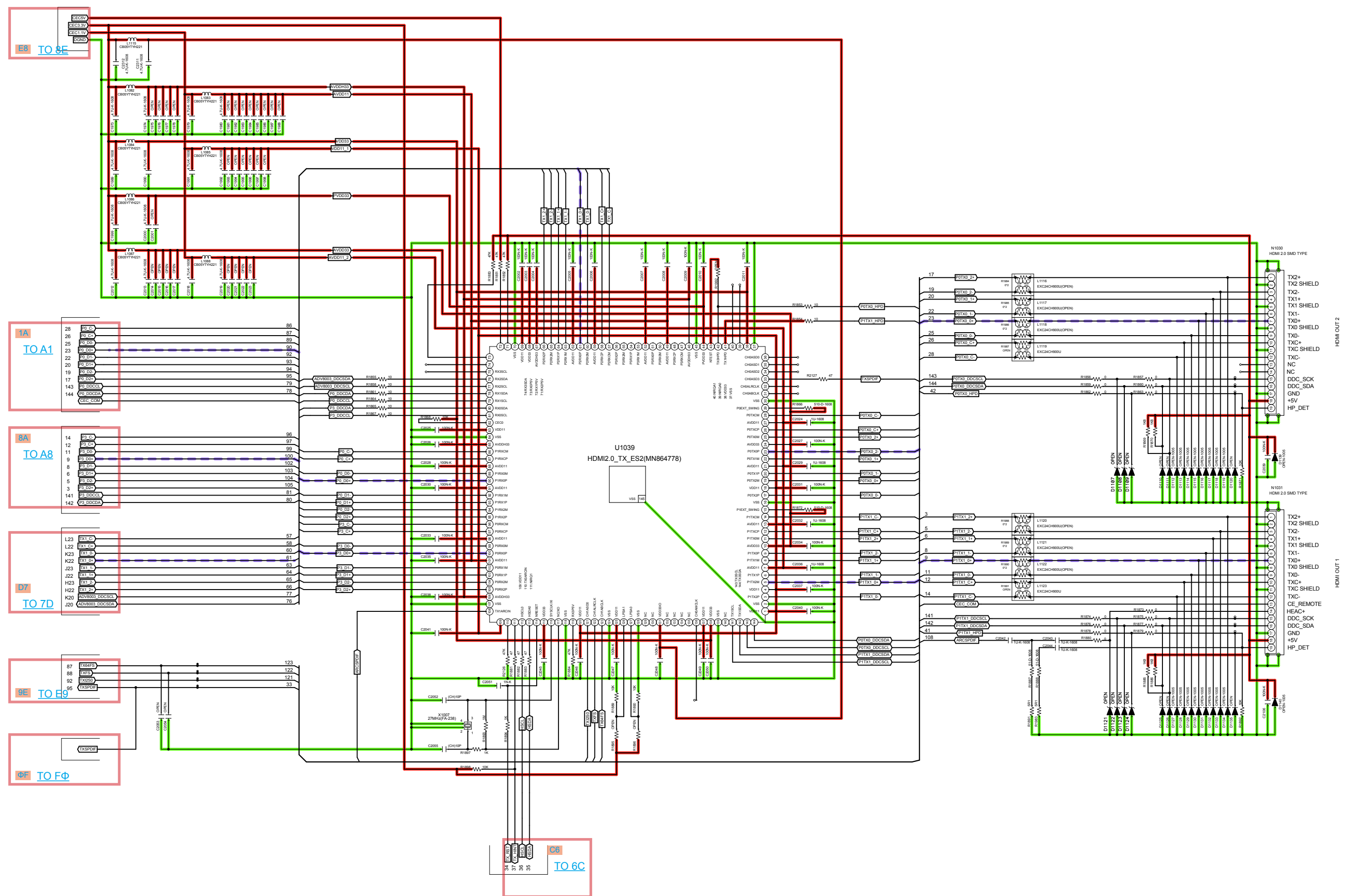

— GND LINE   
 — POWER+ LINE   
 — POWER- LINE   
 - - - ANALOG AUDIO   
 - - - DIGITAL AUDIO   
 - - - TMS SIGNAL   
 - - - VIDEO SIGNAL   
 - - - COMPONENT (Y)

\*FILTER COMPONENTS

VALUE	TYPE	TOLERANCE
R1907 680 Ω	METAL FILM OR CARBON	0 Ω ≤ 5%
C2065 0.068UF	FILM OR CERAMIC (CH OR COG)	≤ 5%
C2067 0.0047UF	FILM OR CERAMIC (CH OR COG)	≤ 5%

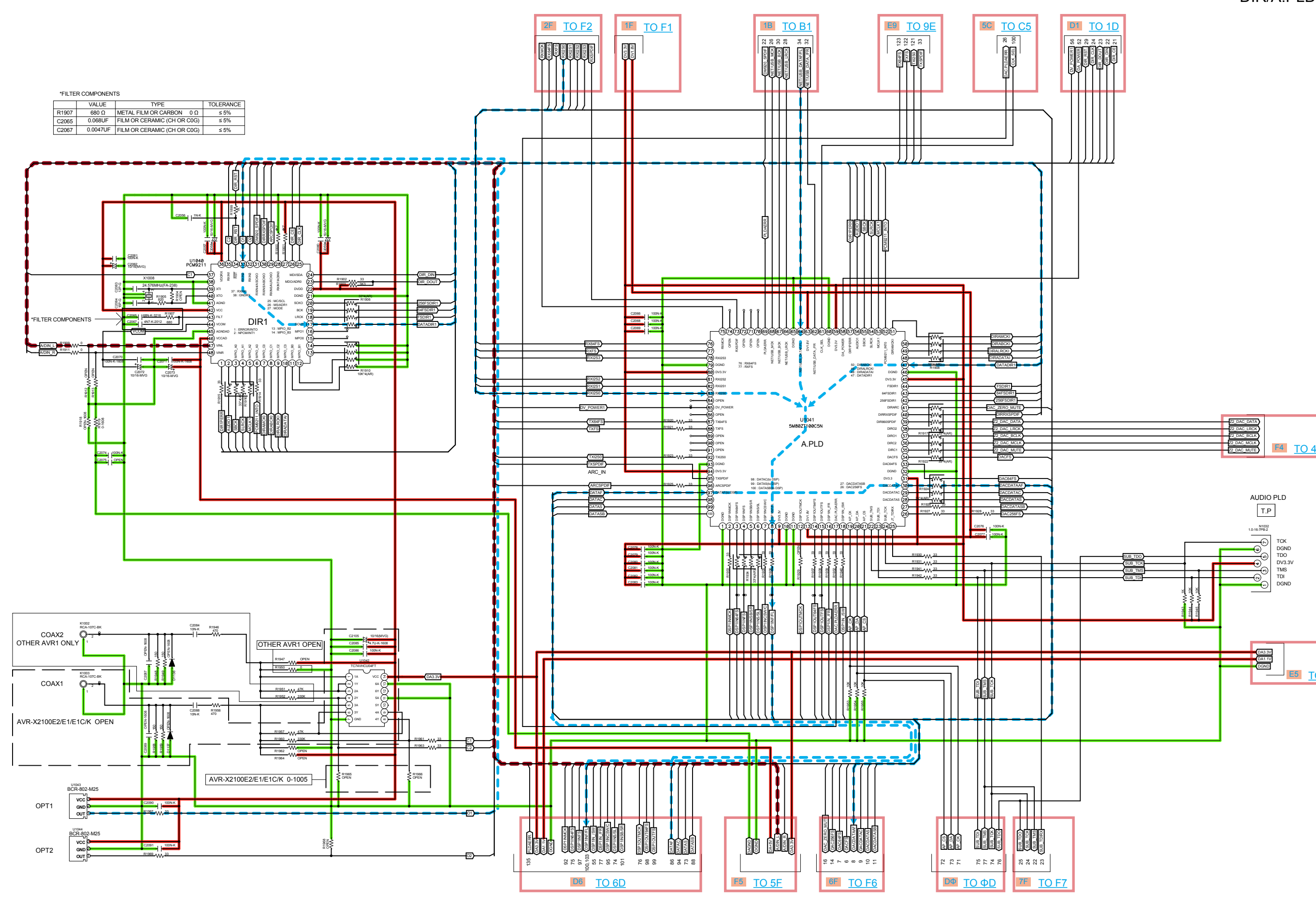

— GND LINE   
 — POWER+ LINE   
 — POWER- LINE   
 - - - ANALOG AUDIO   
 - - - DIGITAL AUDIO   
 - - - TMS SIGNAL   
 - - - VIDEO SIGNAL   
 - - - COMPONENT (Y)

SCHEMATIC DIAGRAMS (15/30)  
15-DIR\_A.PLD

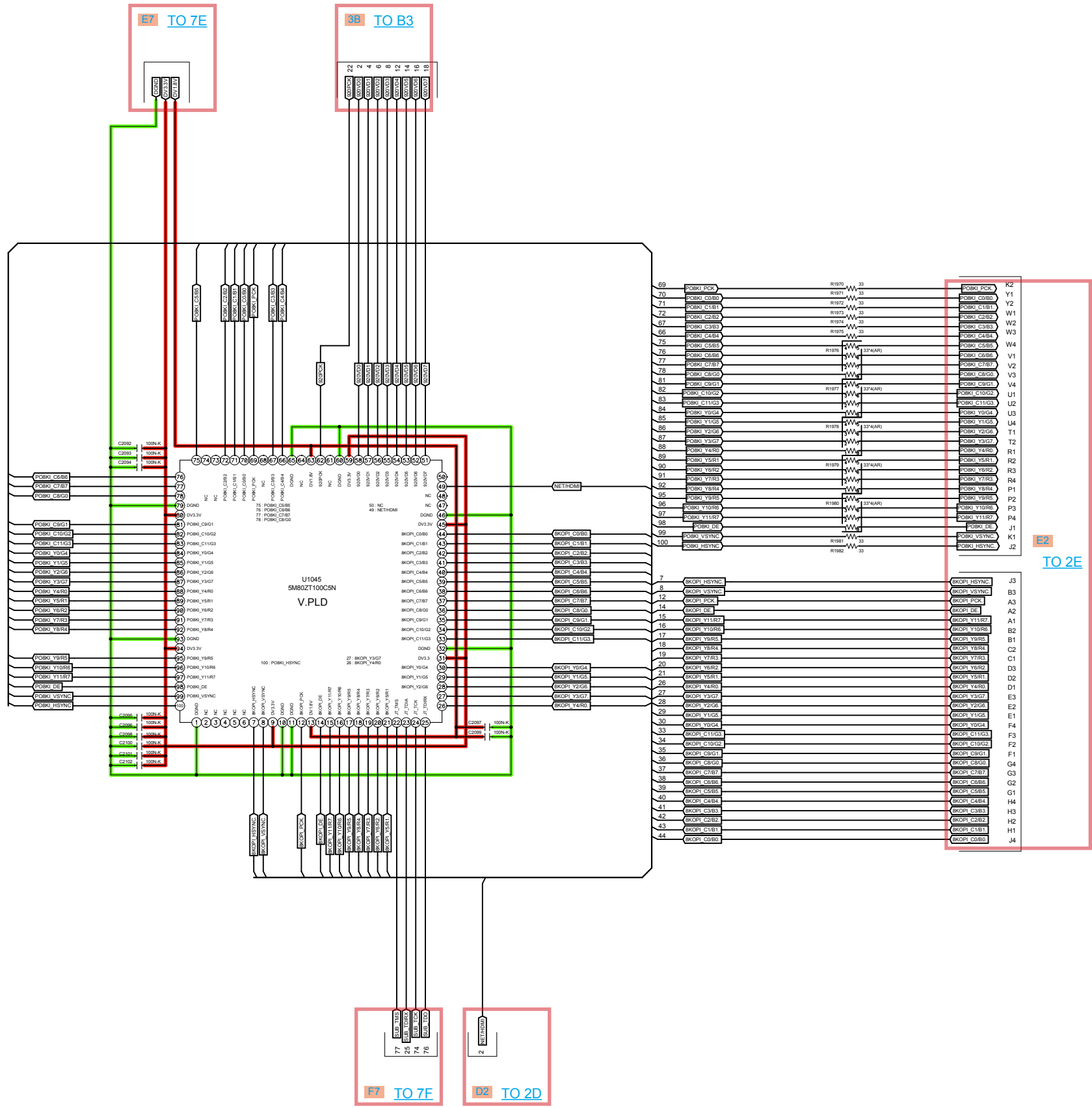

— GND LINE   
 — POWER+ LINE   
 — POWER- LINE   
 - - - ANALOG AUDIO   
 - - - DIGITAL AUDIO   
 - - - TMDS SIGNAL   
 - - - VIDEO SIGNAL   
 - - - COMPONENT (Y)



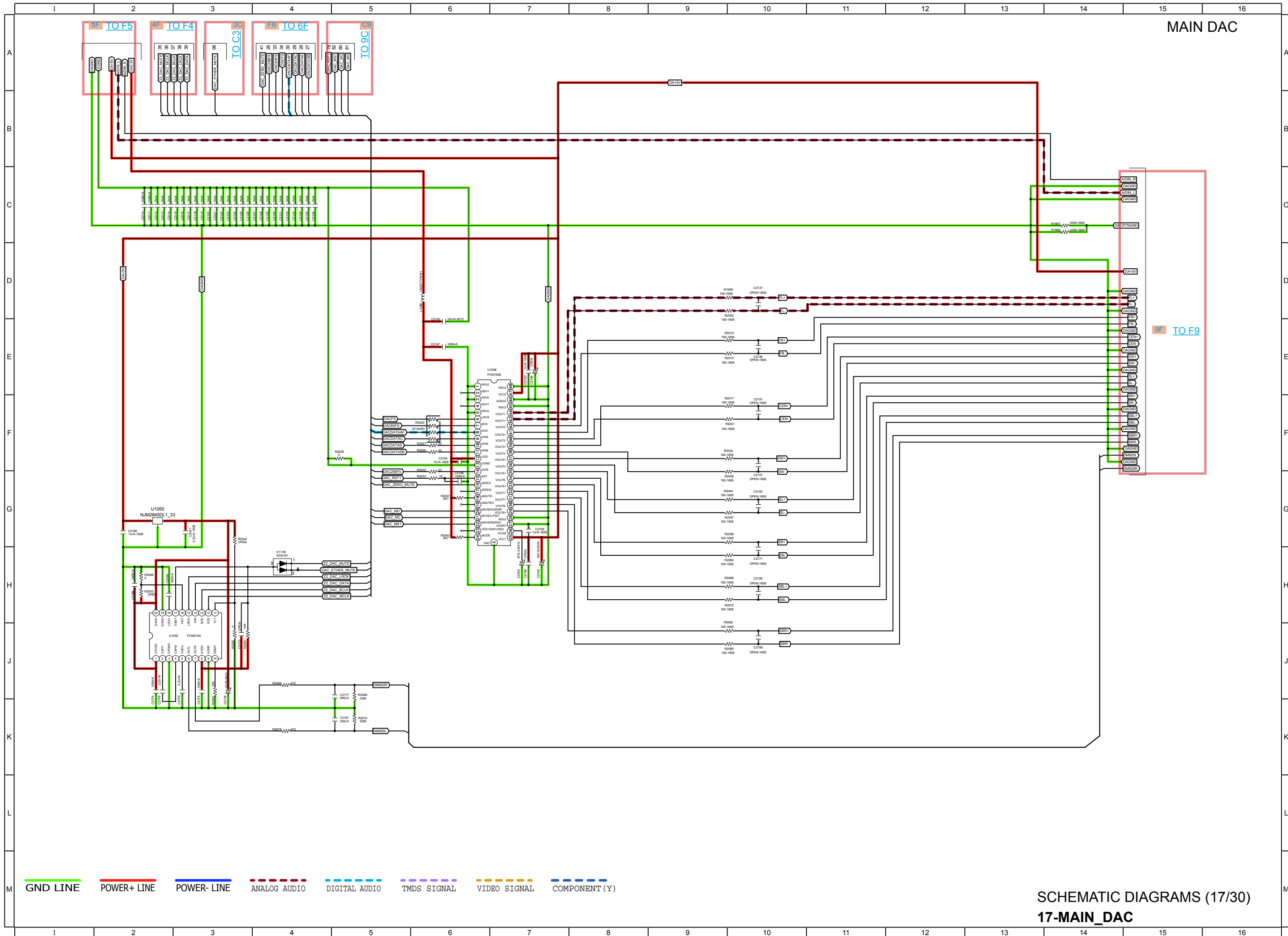

MAIN DAC

9F TO F9

— GND LINE   
 — POWER+ LINE   
 — POWER- LINE   
 - - - ANALOG AUDIO   
 - - - DIGITAL AUDIO   
 - - - TMD5 SIGNAL   
 - - - VIDEO SIGNAL   
 - - - COMPONENT (Y)

SCHEMATIC DIAGRAMS (17/30)  
17-MAIN\_DAC

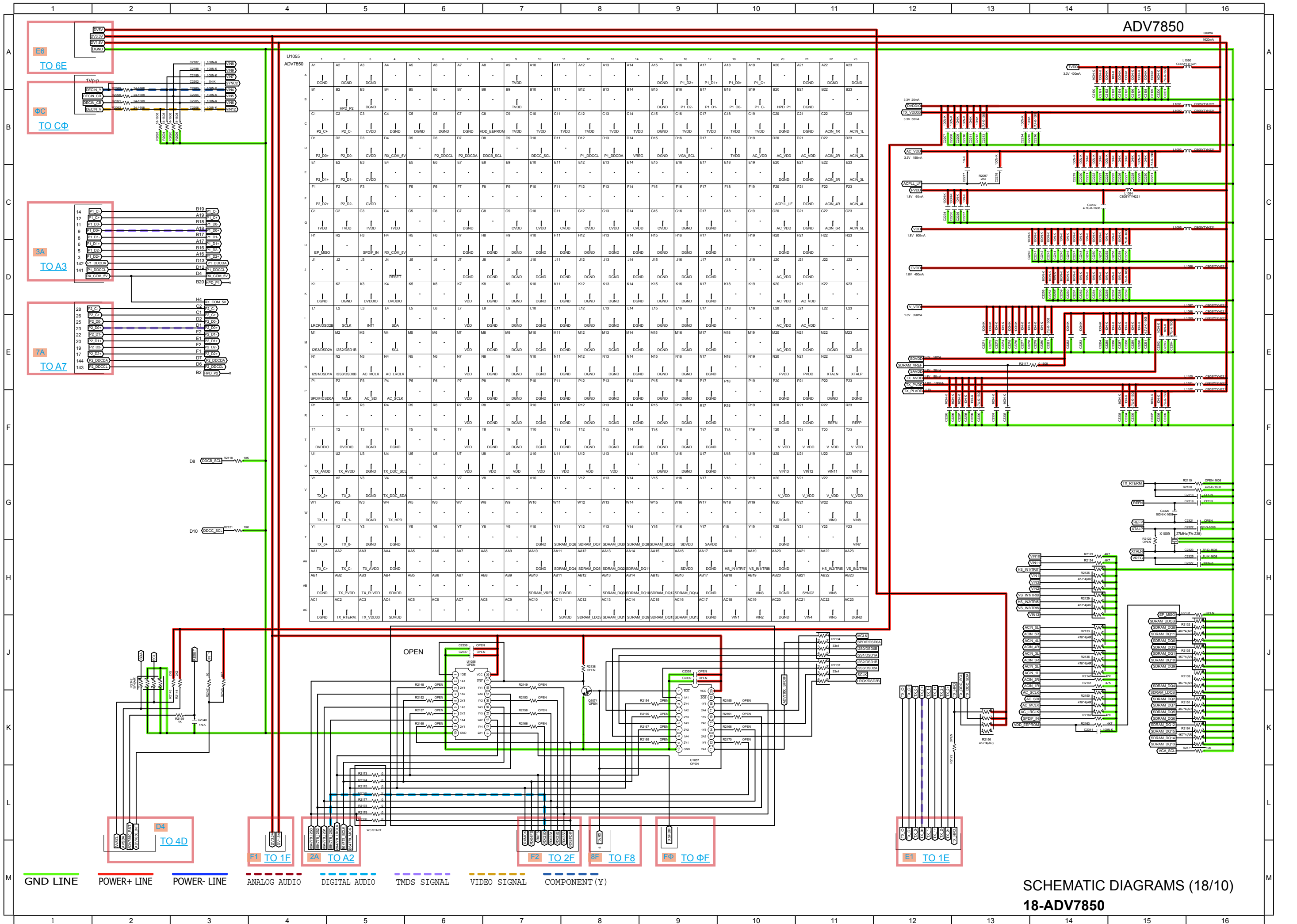

ADV7850

SCHEMATIC DIAGRAMS (18/10)  
18-ADV7850

# CX870 JUNCTION

## Ref.7000 -

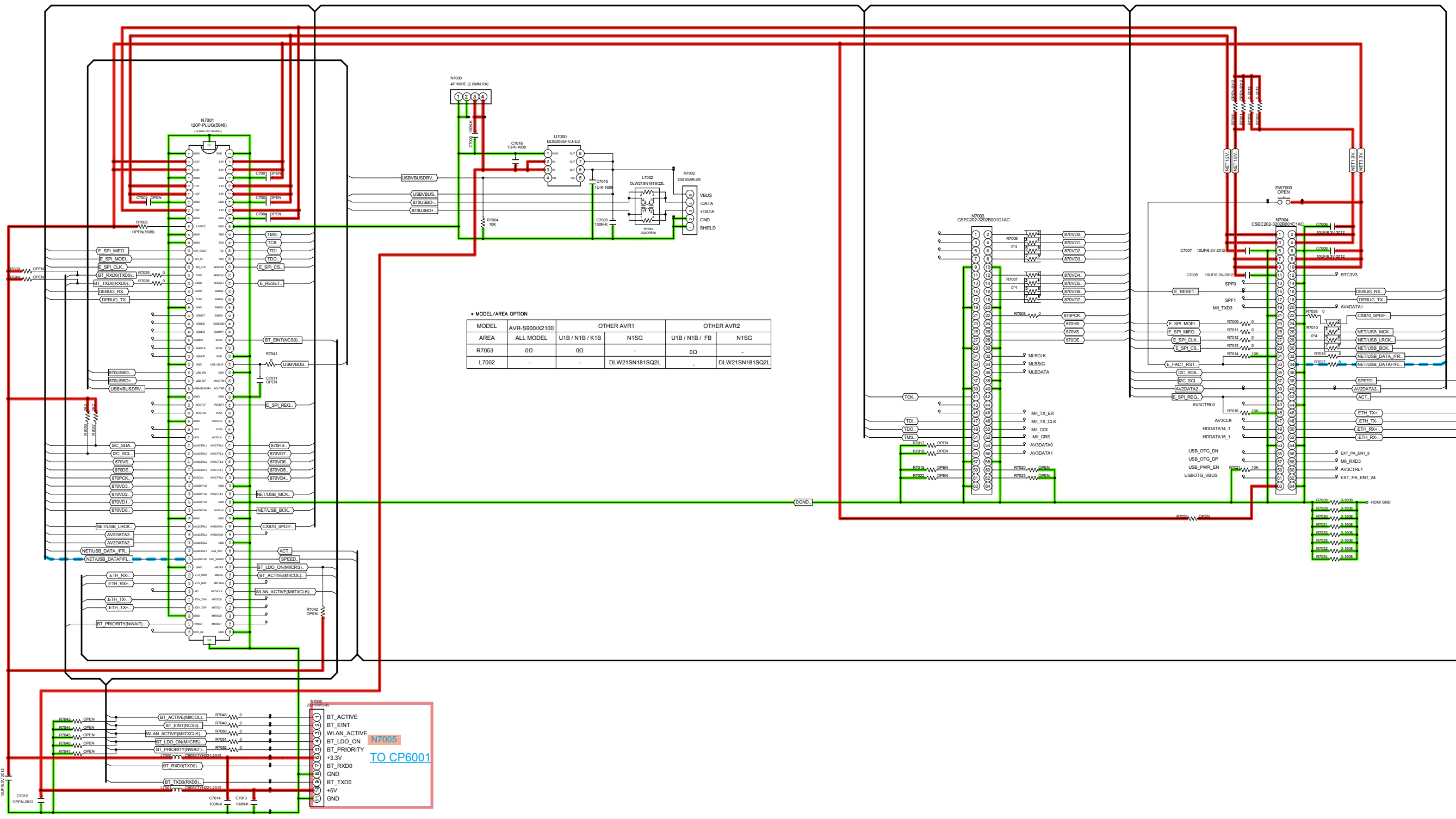

TO Bluetooth

N7005  
TO CP6001

- GND LINE
- POWER+ LINE
- POWER- LINE
- - - ANALOG AUDIO
- - - DIGITAL AUDIO
- - - TMDS SIGNAL
- - - VIDEO SIGNAL
- - - COMPONENT(Y)



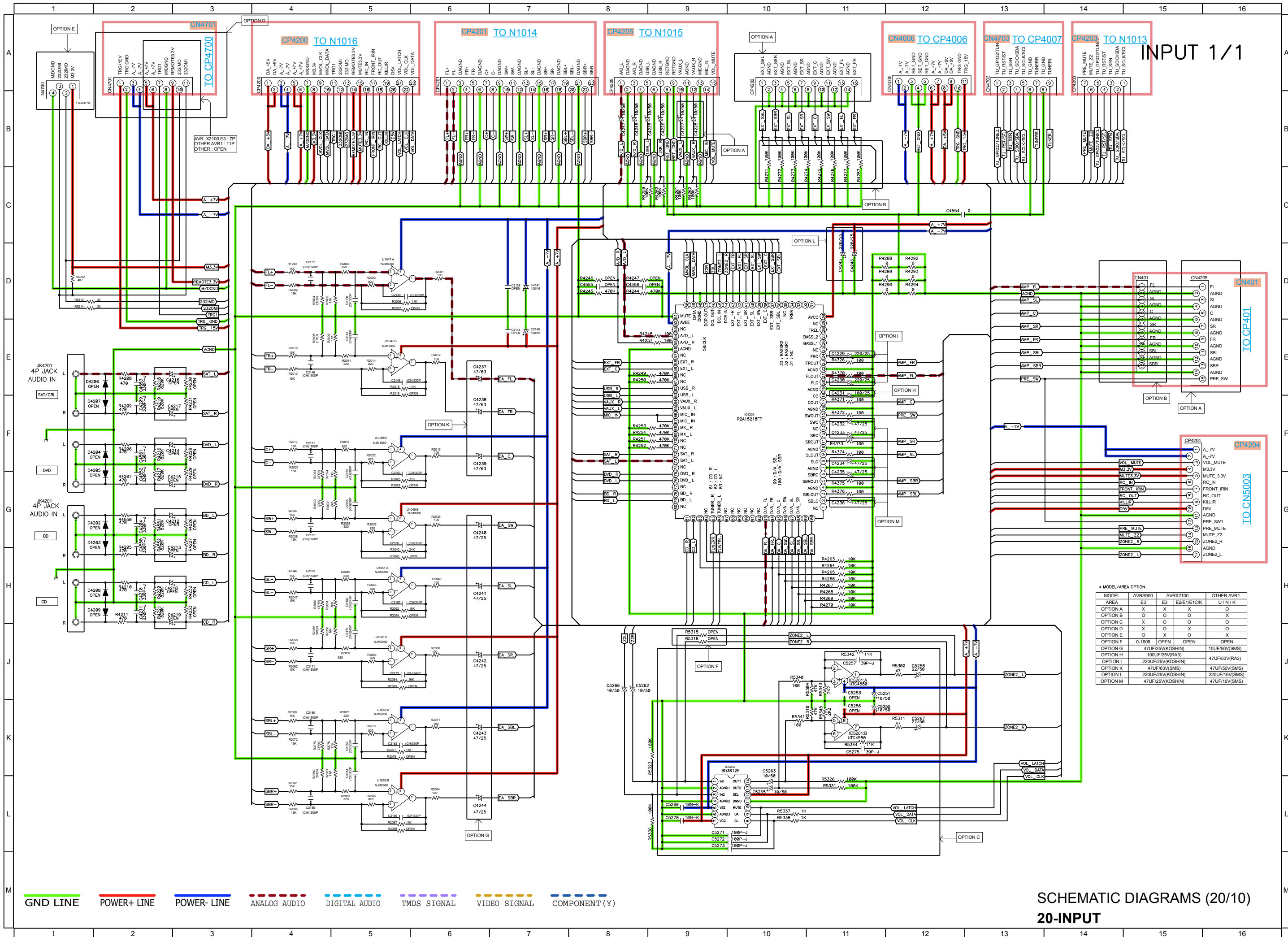

INPUT 1/1

• MODEL/AREA OPTION

MODEL	AVRS900	AVR2100	OTHER AVR1
AREA	E3	E3	E2/E1/E1CK
OPTION A	X	X	X
OPTION B	O	O	O
OPTION C	X	O	O
OPTION D	X	O	X
OPTION E	O	X	O
OPTION F	0-1608	OPEN	OPEN
OPTION G	47UF/25V(KOSHIN)	10UF/60V(SMS)	
OPTION H	100UF/25V(RA3)	47UF/63V(RA3)	
OPTION I	220UF/25V(KOSHIN)	47UF/63V(SMS)	
OPTION K	47UF/63V(SMS)	47UF/63V(SMS)	
OPTION L	220UF/25V(KOSHIN)	220UF/16V(SMS)	
OPTION M	47UF/25V(KOSHIN)	47UF/16V(SMS)	

— GND LINE   
 — POWER+ LINE   
 — POWER- LINE   
 - - - ANALOG AUDIO   
 - - - DIGITAL AUDIO   
 - - - TMS SIGNAL   
 - - - VIDEO SIGNAL   
 - - - COMPONENT (Y)

SCHEMATIC DIAGRAMS (20/10)  
20-INPUT

# VIDEO / ZONE2 PART

\*MODEL / AREA OPTION

MODEL	AVR-S900	AVR-X2100	OTHER AVR1
AREA	E3	E3	E2/E1/E1CJP
OPTION A	O	O	O
OPTION B	X	X	X
OPTION C	X	O	O
OPTION D	O	O	X
OPTION E	X	X	O
C4207	OPEN		10N(1608)
C4208	10N(1608)		OPEN

CVBS INPUT SW (NIM2595MTE1)

INPUT	OUT PUT	AVR_S900(X2100)	OTHER AVR1
SW1 SW2 SW3 SW4 SW5	MUTE	MUTE	
L L H H L	CBL/SAT	CBL/SAT	
H H L L H H	DVD	DVD	
H L H L H	VIN 2	NOT USED	V.AUX

COMPONENT INPUT SW (NIM2586AVC3)

INPUT	OUT PUT	AVR_S900(X2100)	OTHER AVR1
SW1 SW2	IN2	CBL/SAT	
H L	IN3	DVD	
H H			

MUTE(PS)

H	OFF
L	ON

JACK5003 2P JACK ZONE OUT

AVR_S900	PIN	USE	R_NO
AVR_S900	2P JACK	PRE_SW	JACK5003
AVR_X2100	4P JACK	PRE_SW	JACK5004
OTHER AVR1	2P JACK	ZONE2	JACK5002

JACK5002 2P JACK PRE\_SW

AVR_S900	PIN	USE	R_NO
AVR_S900	2P JACK	PRE_SW	JACK5003
AVR_X2100	4P JACK	PRE_SW	JACK5004
OTHER AVR1	2P JACK	ZONE2	JACK5002

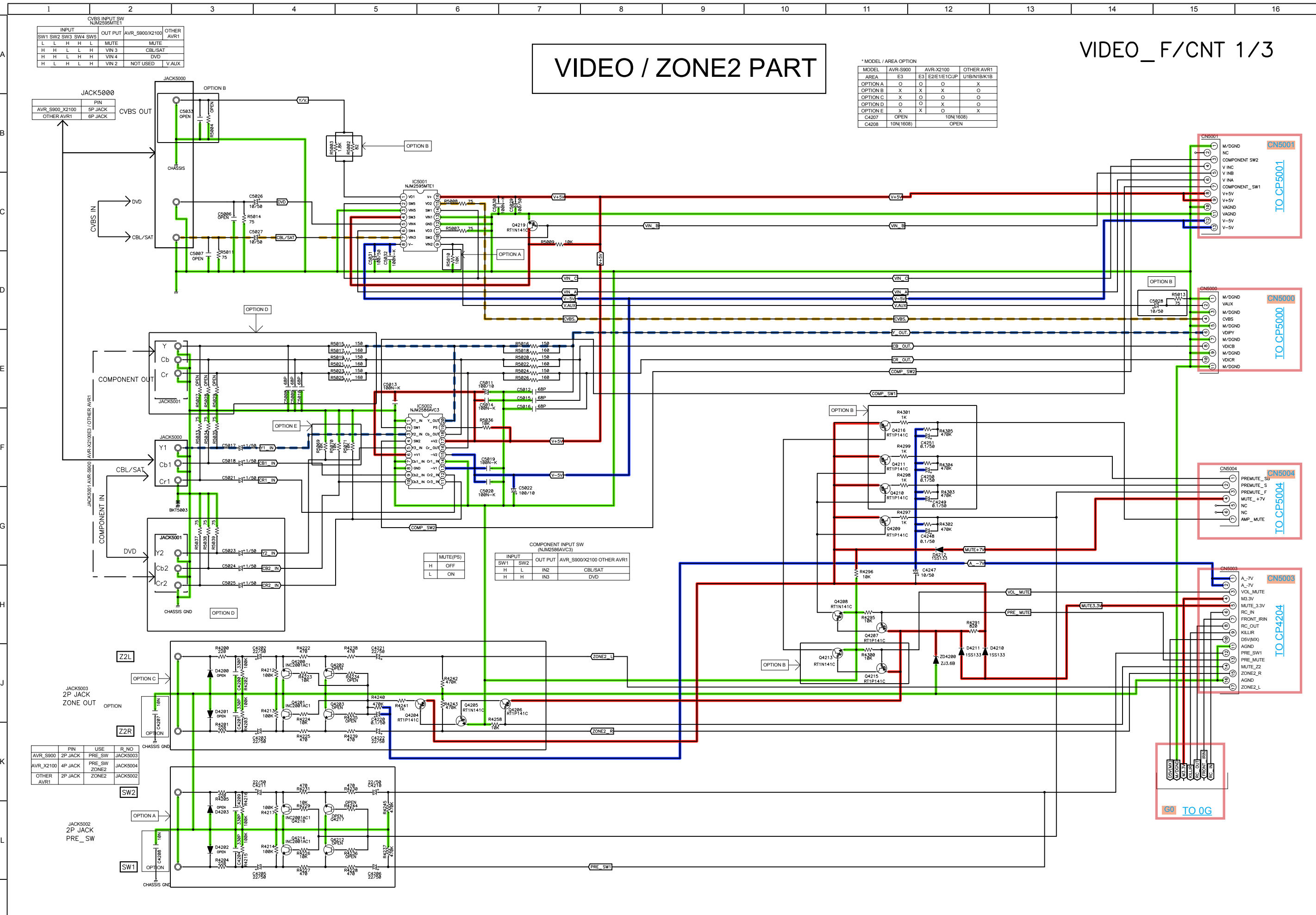

# FRONT\_CNT PART

FUSE	F5001,F5002,F5003,F5004	F5000
AVR-S900 X2100	T1.6A/250V	OPEN
OTHER AVR1	T1.25A/250V	T1.25A/250V

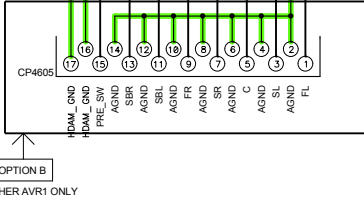
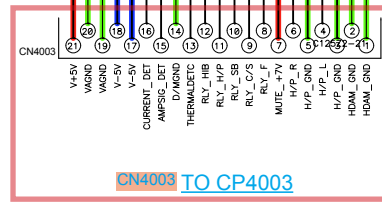
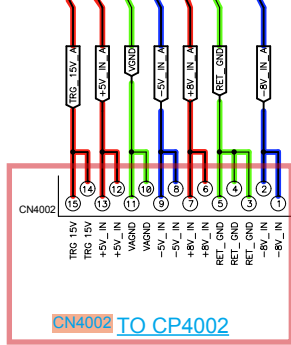
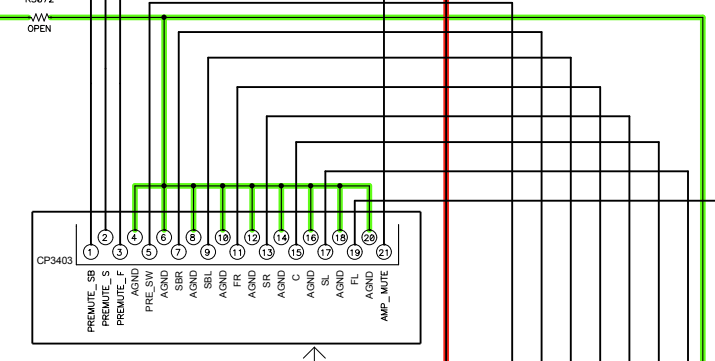
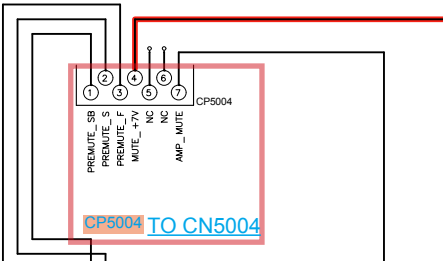
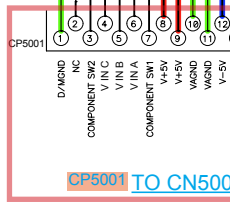
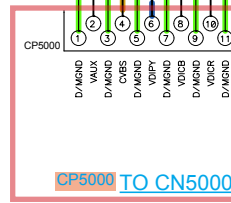
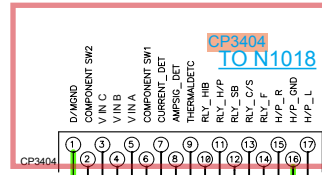
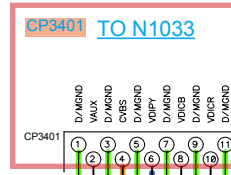
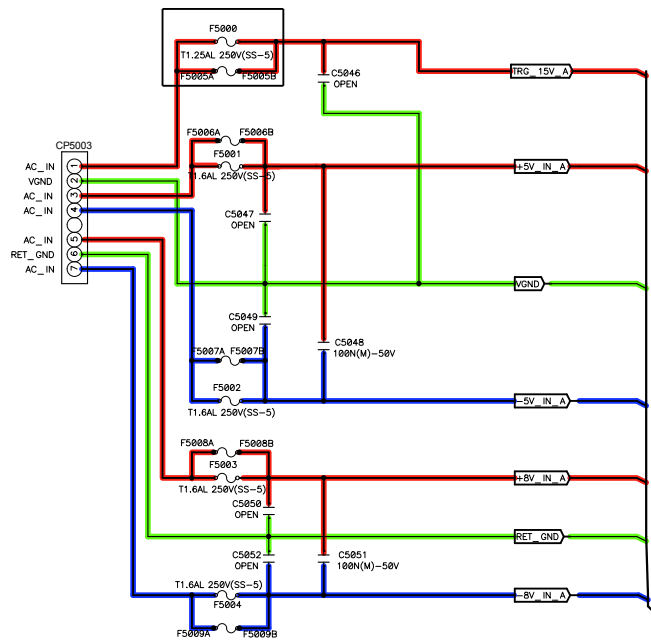

GND LINE    POWER+ LINE    POWER- LINE    ANALOG AUDIO    DIGITAL AUDIO    TMD5 SIGNAL    VIDEO SIGNAL    COMPONENT (Y)

RC-5 PART  
OTHER AVR1 ONLY

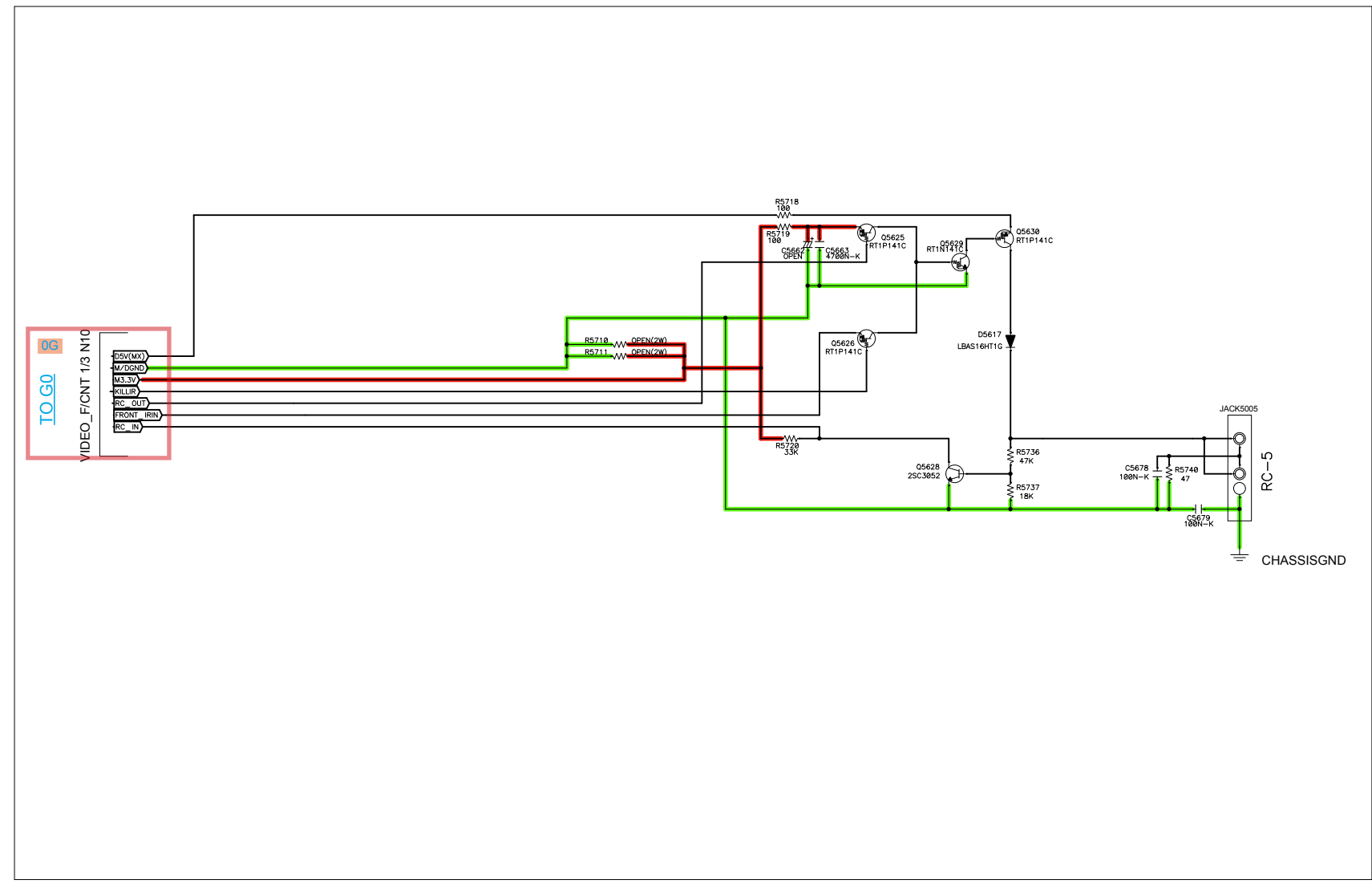

—— GND LINE   
 —— POWER+ LINE   
 —— POWER- LINE   
 - - - - ANALOG AUDIO   
 - - - - DIGITAL AUDIO   
 - - - - TMDS SIGNAL   
 - - - - VIDEO SIGNAL   
 - - - - COMPONENT (Y)

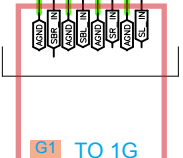
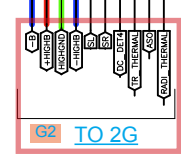
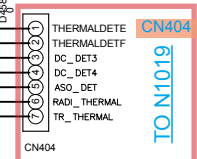
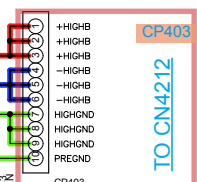
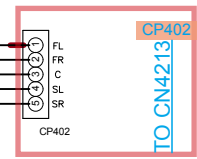
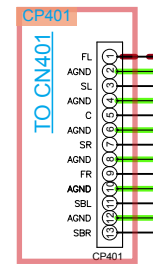
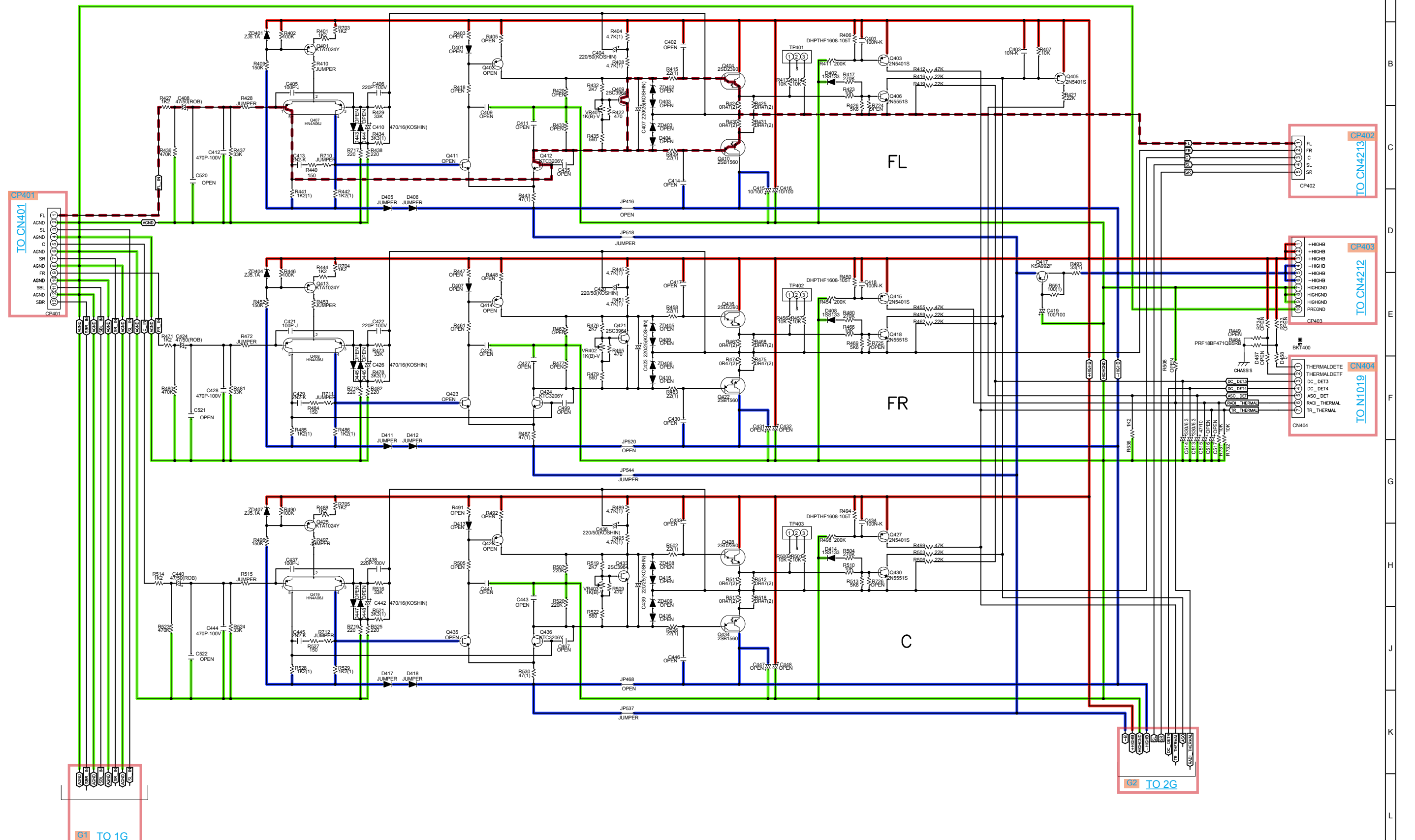

— GND LINE   
 — POWER+ LINE   
 — POWER- LINE   
 - - - ANALOG AUDIO   
 - - - DIGITAL AUDIO   
 - - - TMSD SIGNAL   
 - - - VIDEO SIGNAL   
 - - - COMPONENT (Y)



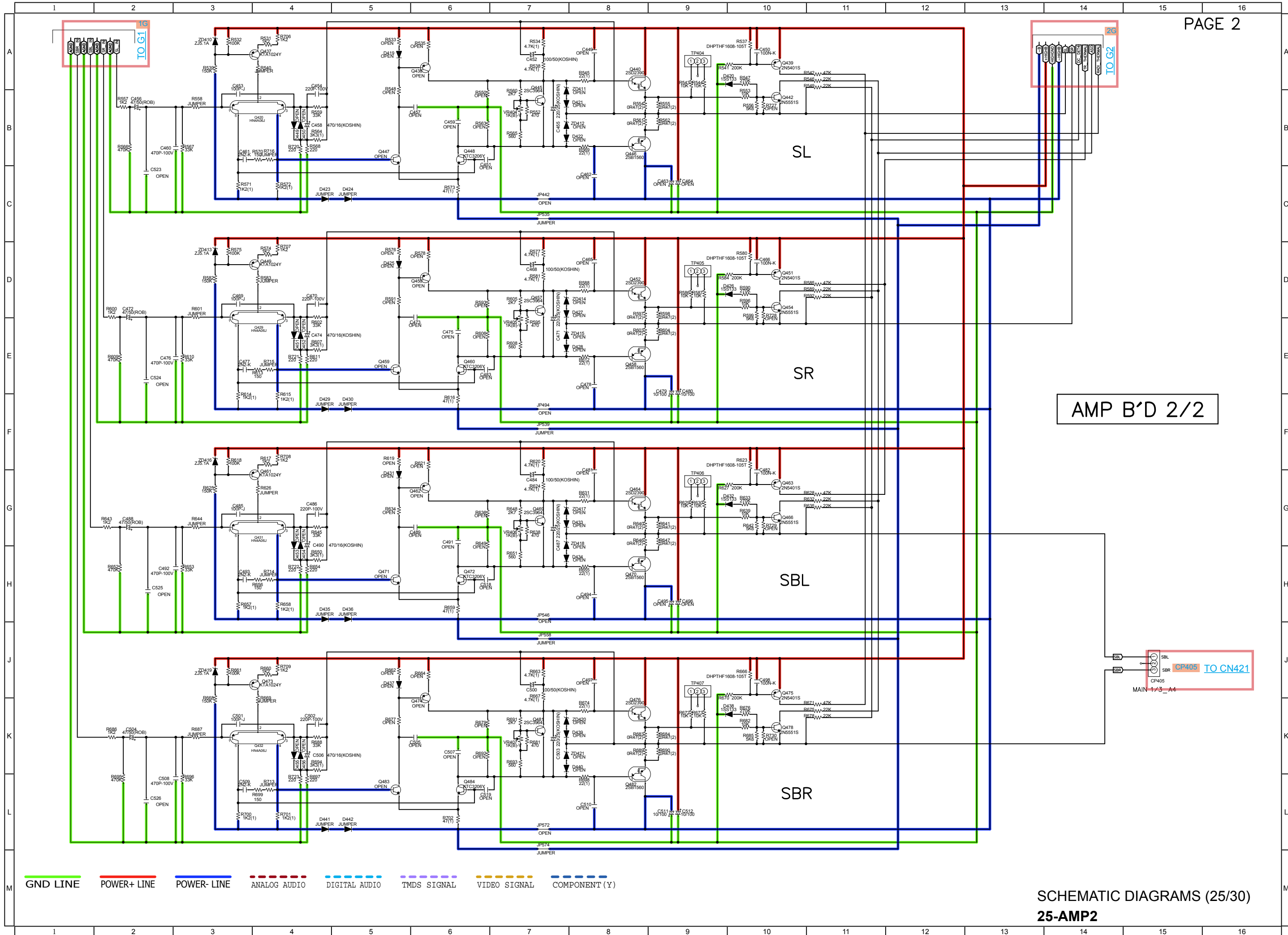

AMP B'D 2/2

CP405 TO CN421  
 MAIN-1/3-A4

— GND LINE   
 — POWER+ LINE   
 — POWER- LINE   
 - - - ANALOG AUDIO   
 - - - DIGITAL AUDIO   
 - - - TMDS SIGNAL   
 - - - VIDEO SIGNAL   
 - - - COMPONENT (Y)

SCHEMATIC DIAGRAMS (25/30)  
25-AMP2

# SPK PART

# MAIN 1/3

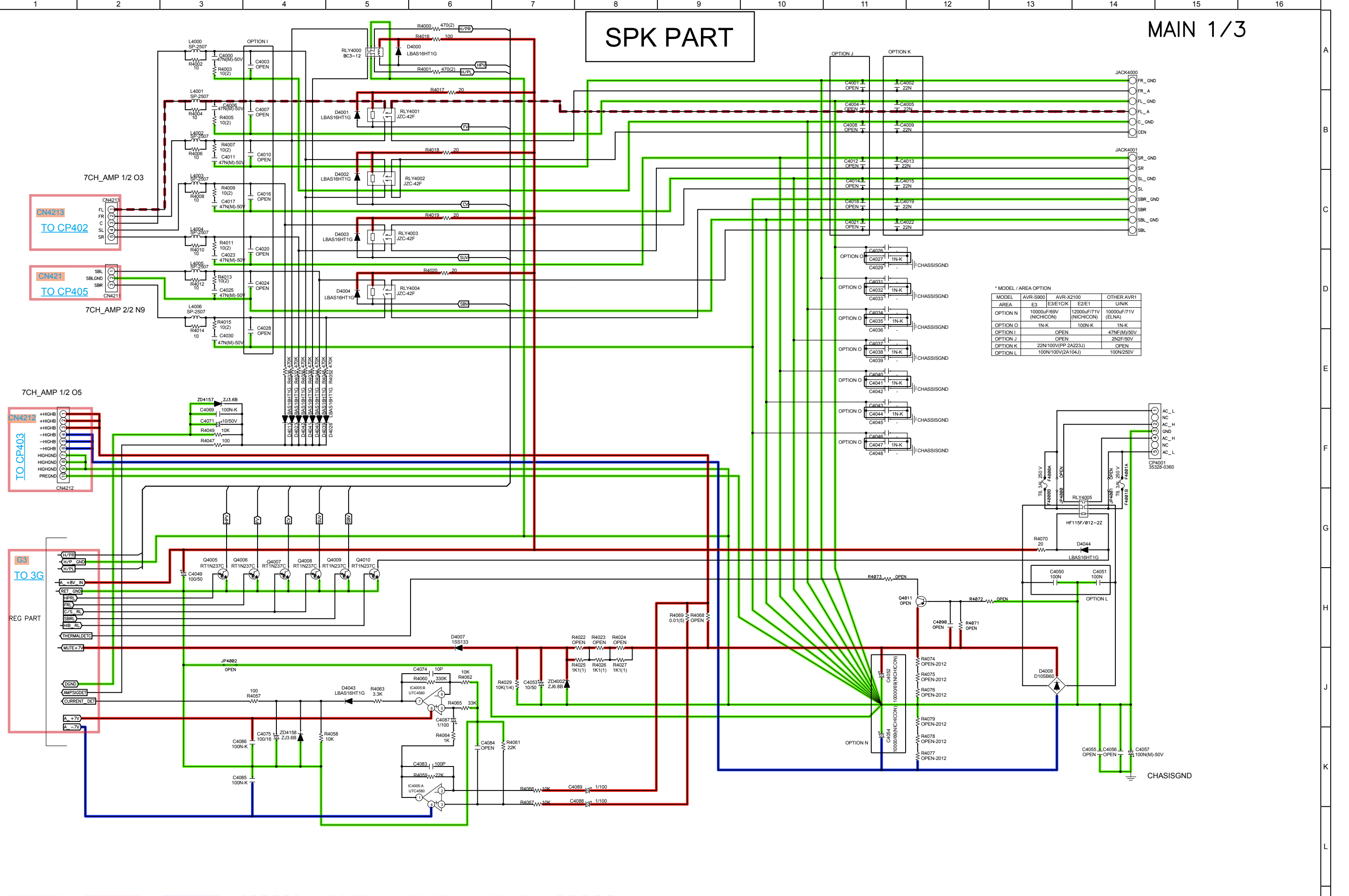

\* MODEL / AREA OPTION

MODEL	AVR-S800	AVR-X2100	OTHER AVR1
AREA	E3	E3/E10K	E2/E1
OPTION N	10000µF/85V (NICHICON)	12000µF/71V (NICHICON)	10000µF/71V (ELNA)
OPTION O	1N-K	100N-K	1N-K
OPTION I	OPEN		47NF(M)/50V
OPTION J	OPEN		2N2F/50V
OPTION K	22N/100V(PP 2A223J)		OPEN
OPTION L	100N/100V(2A104J)		100N/250V

- GND LINE
- POWER+ LINE
- POWER- LINE
- - - ANALOG AUDIO
- - - DIGITAL AUDIO
- - - TMS SIGNAL
- - - VIDEO SIGNAL
- - - COMPONENT (Y)

SCHEMATIC DIAGRAMS (26/10)  
26-MAIN\_SPK

TUNER / REG PART

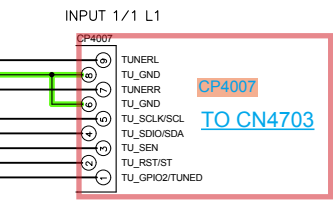
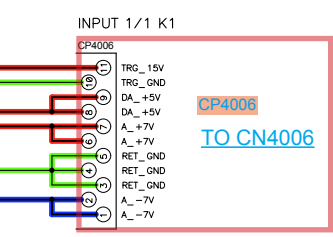
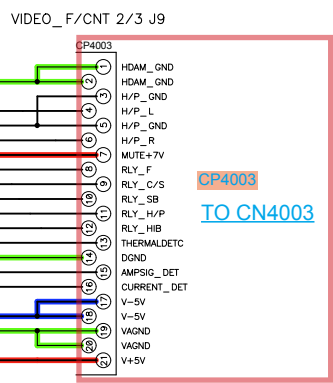
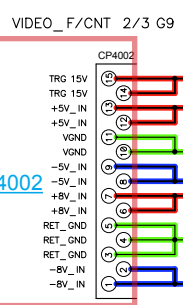
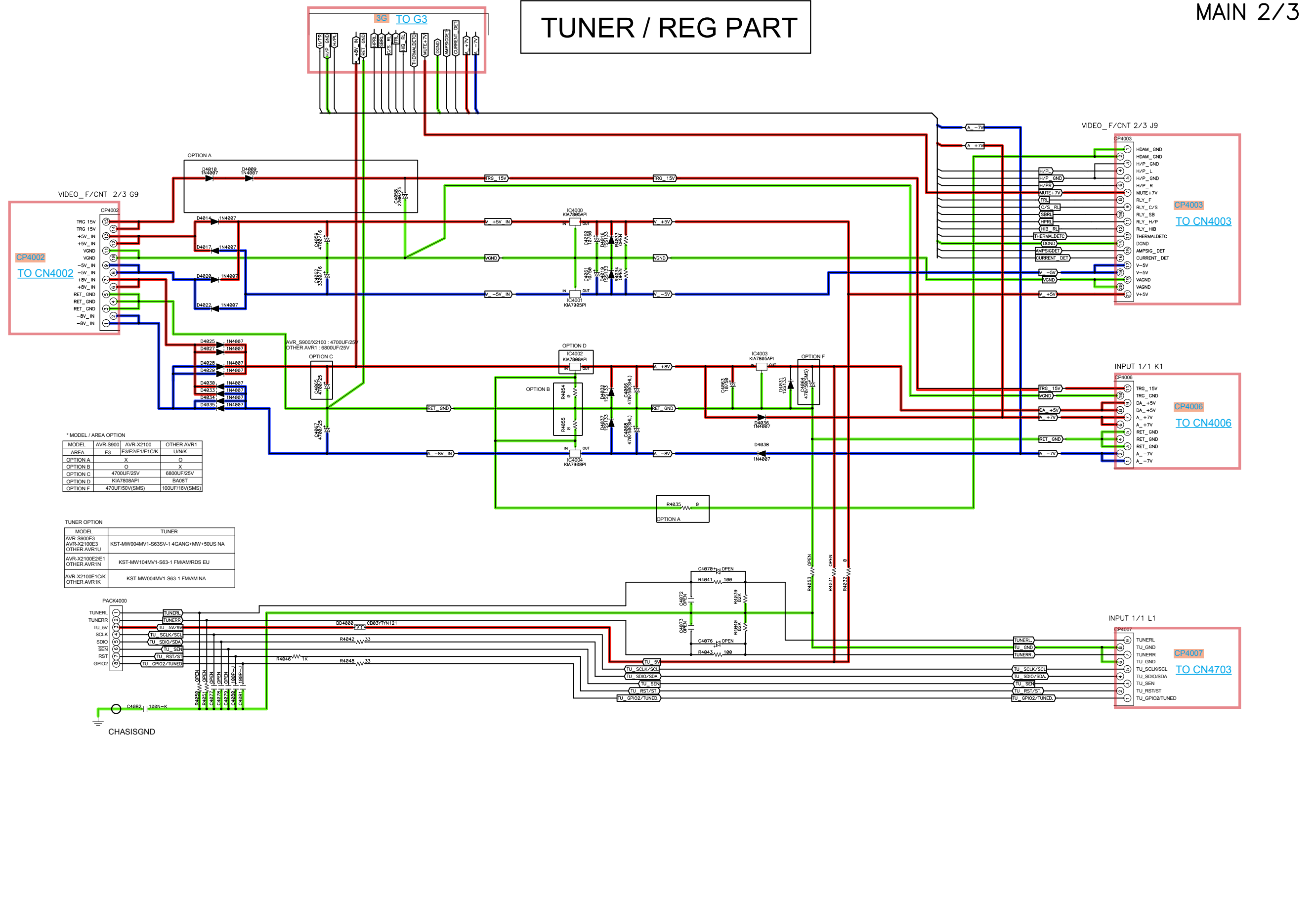

\* MODEL / AREA OPTION

MODEL	AVR-S900	AVR-X2100	OTHER AVR1
AREA	E3	E3E2/E1E1C1K	UN1K
OPTION A		X	O
OPTION B		O	X
OPTION C		4700UF/25V	6800UF/25V
OPTION D		KIA7808AP1	BA08T
OPTION F		470UF/50V(SMS)	100UF/16V(SMS)

TUNER OPTION

MODEL	TUNER
AVR-S900E3	
AVR-X2100E3	KST-MW004M1-563S-1 4GANG+MW+50US NA
OTHER AVR1U	
AVR-X2100E2/E1	KST-MW104M1-563-1 FMAM/RDS EU
OTHER AVR1N	
AVR-X2100E1C1K	KST-MW004M1-563-1 FMAM NA
OTHER AVR1K	

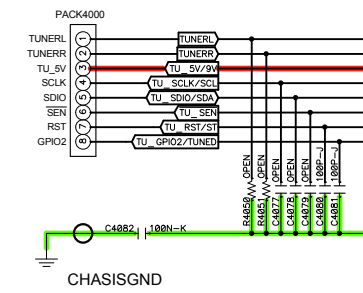

GND LINE    POWER+ LINE    POWER- LINE    ANALOG AUDIO    DIGITAL AUDIO    TMDS SIGNAL    VIDEO SIGNAL    COMPONENT (Y)



**RS\_CNT PART  
(AVR\_X2100E3 / OTHER AVR1 ONLY)**

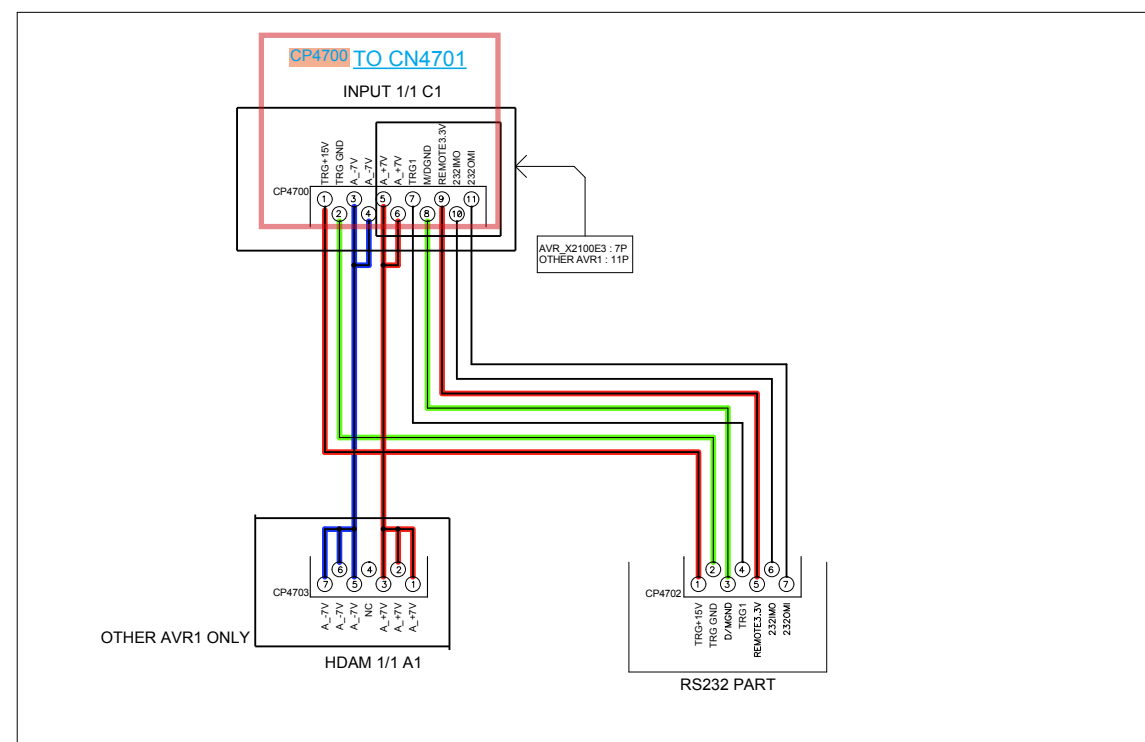

**RS232 PART  
(AVR\_X2100E3 / OTHER AVR1 ONLY)**

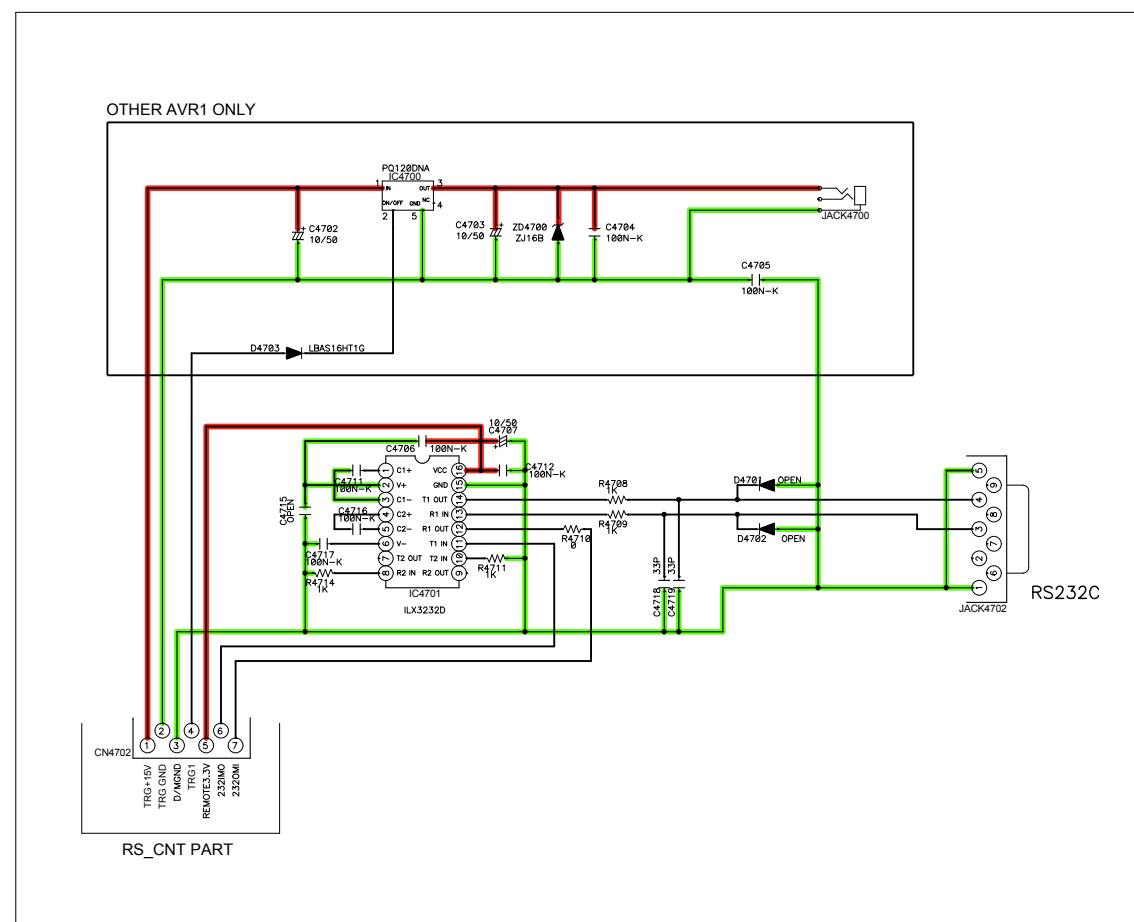

— GND LINE   
 — POWER+ LINE   
 — POWER- LINE   
 - - - ANALOG AUDIO   
 - - - DIGITAL AUDIO   
 - - - TMDS SIGNAL   
 - - - VIDEO SIGNAL   
 - - - COMPONENT (Y)

# AVR\_S900\_X2100\_FRONT

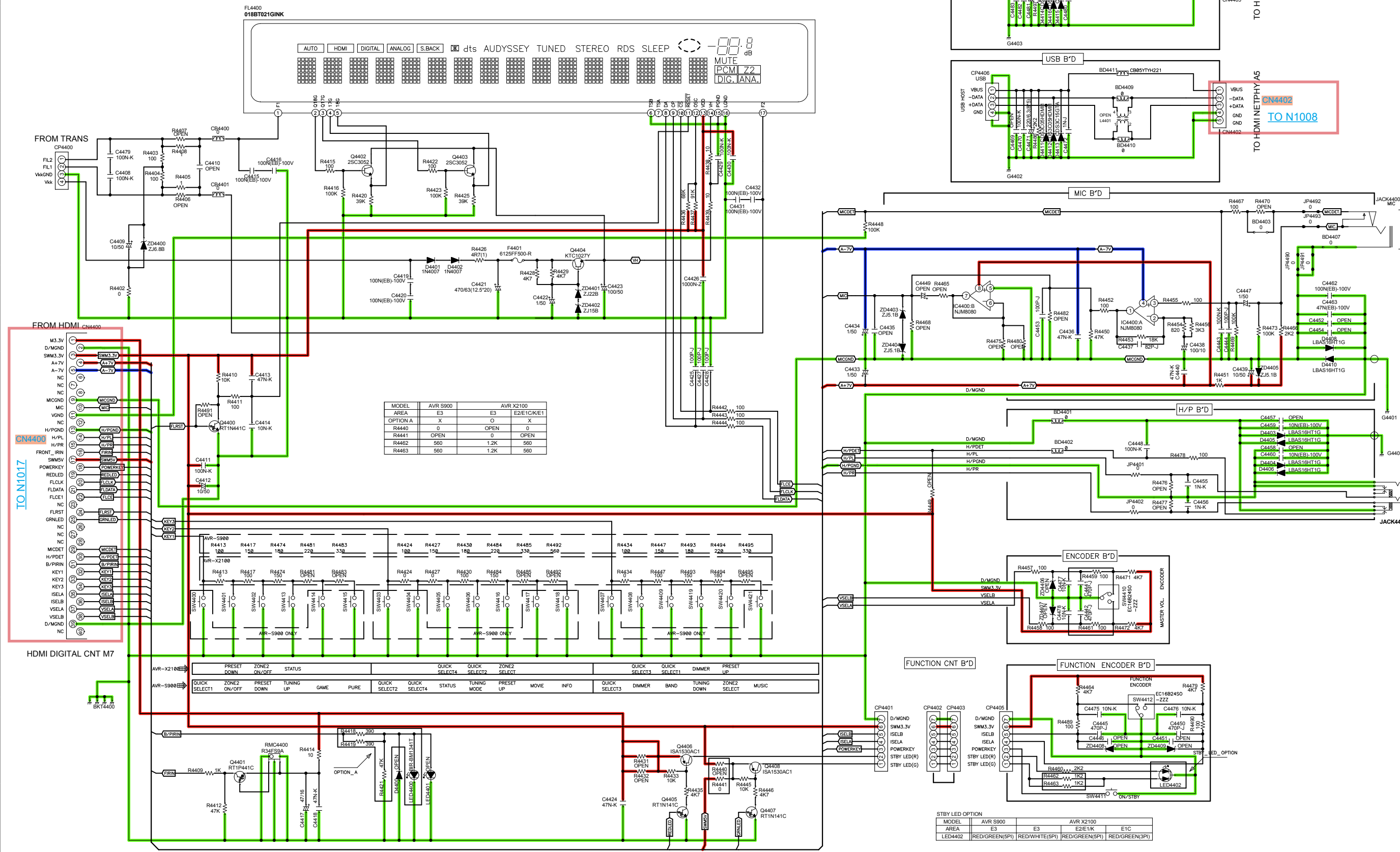

MODEL	AVR S900	AVR X2100
AREA	E3	E3
OPTION A	X	O
R4440	0	OPEN
R4441	OPEN	0
R4462	560	1.2K
R4463	560	1.2K

MODEL	AVR S900	AVR X2100	AVR X2100
AREA	E3	E3	E2/E1C/KE1
OPTION A	X	O	X
R4440	0	OPEN	0
R4441	OPEN	0	OPEN
R4462	560	1.2K	560
R4463	560	1.2K	560

STBY LED OPTION

MODEL	AVR S900	AVR X2100
AREA	E3	E3
LED4402	RED/GREEN(5P)	RED/WHITE(5P)
		RED/GREEN(5P)
		RED/GREEN(3P)

— GND LINE   
 — POWER+ LINE   
 — POWER- LINE   
 - - - ANALOG AUDIO   
 - - - DIGITAL AUDIO   
 - - - TMDS SIGNAL   
 - - - VIDEO SIGNAL   
 - - - COMPONENT (Y)

**SCHEMATIC DIAGRAMS (29/30)**  
**29-FRONT**

# AVR-S900/X2100 & OTHER AVR1 SMPS B'D

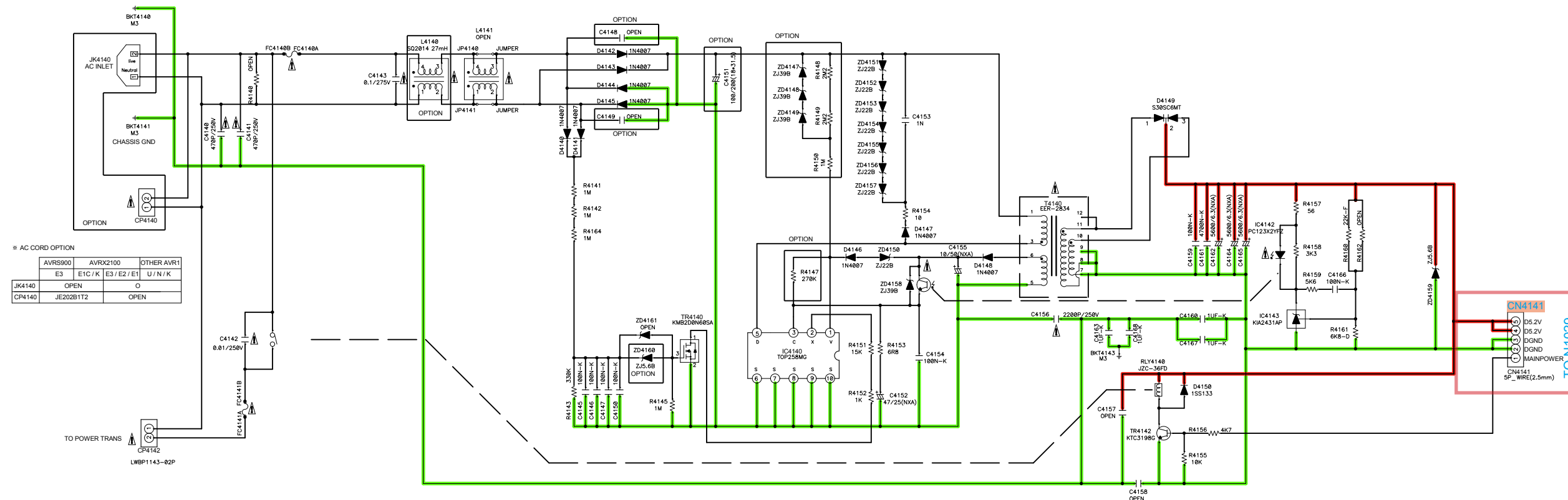

※ AC CORD OPTION

	AVRS900	AVRX2100	OTHER AVR1
JK4140	E3	E1C / K	E3 / E2 / E1
CP4140	OPEN	O	U / N / K
CP4140	JE202B1T2	OPEN	OPEN

※ FUSE OPTION

	E3		K(JP)		E1C, E2, E1	
	F4140	F4141	F4140	F4141	F4140	F4141
AVR_X2100	2A	6.3A	2A	6.3A	1.6A	3.15A
AVR_S900	2A	6.3A	X	X	X	X

※ OPTION TABLE

	ZD4160	ZD4147	ZD4148	ZD4149	R4148	R4149	R4150	R4147	C4148	C4149	L4140	C4151
E3, U	ZJ5.6B	ZJ39B	ZJ39B	ZJ39B	2M2 (5)	2M2 (5)	1M (5)	270K	OPEN	OPEN	SQ2014 27mH	100/200
E2,E1,E1C / NK	ZJ16B	OPEN	OPEN	OPEN	OPEN	OPEN	OPEN	56K	0.01	0.01	SQ2014 50mH	100/400
K(JP)	ZJ5.1B	ZJ39B	ZJ39B	ZJ39B	2M2 (5)	2M2 (5)	1M (5)	270K	OPEN	OPEN	SQ2014 27mH	100/200

※ FUSE OPTION

	U1B		N1SG, N1B, K1B	
	F4140	F4141	F4140	F4141
OTHER AVR1	2A	6.3A	1.6A	3.15A

△ INDICATES SAFETY CRITICAL COMPONENTS.  
TO REDUCE THE RISK OF ELECTRIC SHOCK, LEAKAGE CURRENT OR RESISTANCE MEASUREMENTS SHALL BE CARRIED OUT ( EXPOSED PARTS ARE ACCEPTABLY INSULATED FROM THE SUPPLY CIRCUIT ) BEFORE THE APPLIANCE RETURNED TO THE CUSTOMER.

— GND LINE   
 — POWER+ LINE   
 — POWER- LINE   
 - - - ANALOG AUDIO   
 - - - DIGITAL AUDIO   
 - - - TMDS SIGNAL   
 - - - VIDEO SIGNAL   
 - - - COMPONENT (Y)

# EXPLODED VIEW

Please see the last chapter for the part list.

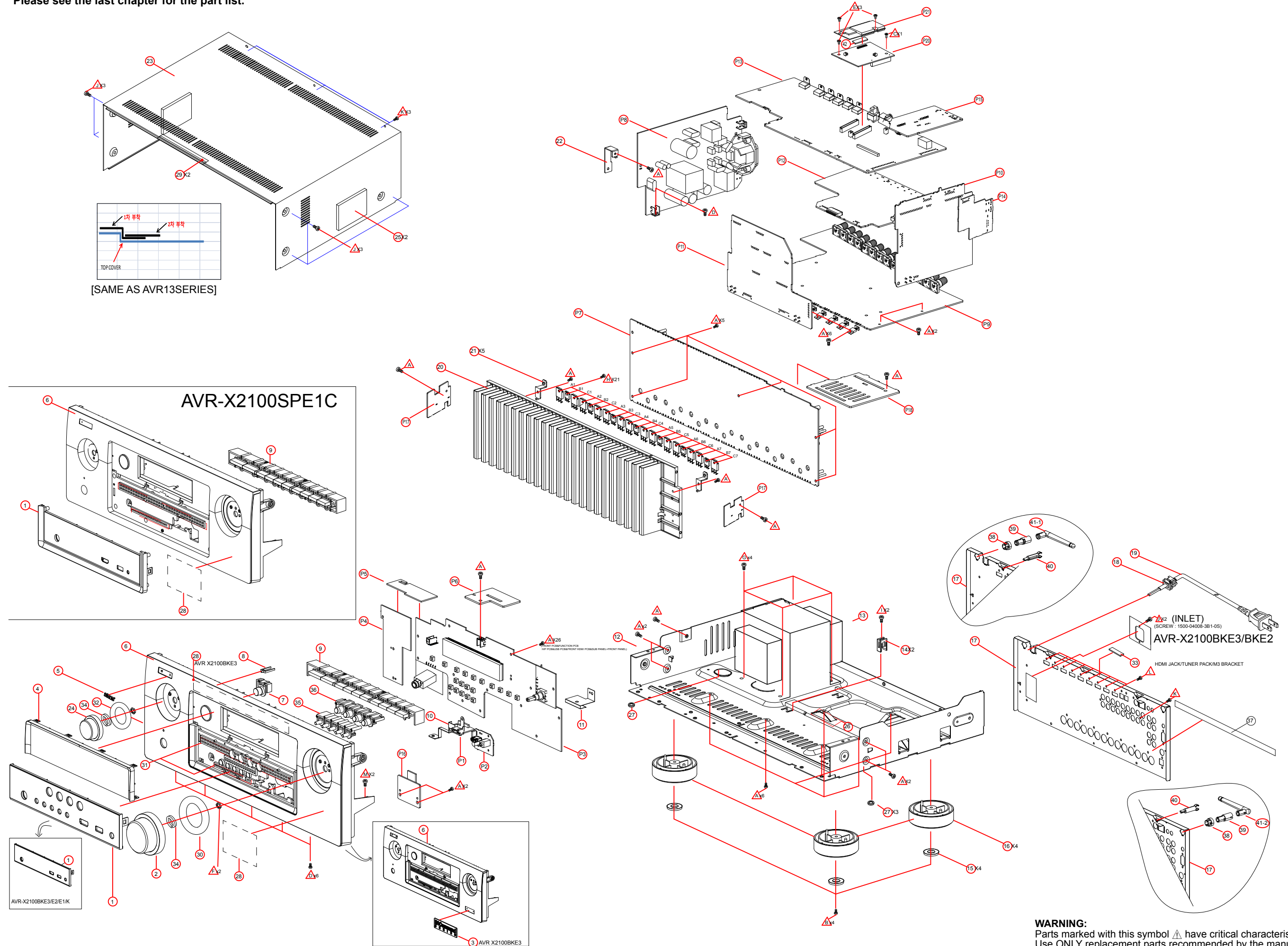

**WARNING:**  
Parts marked with this symbol have critical characteristics.  
Use **ONLY** replacement parts recommended by the manufacturer.



# PACKING VIEW

Please see the last chapter for the part list.

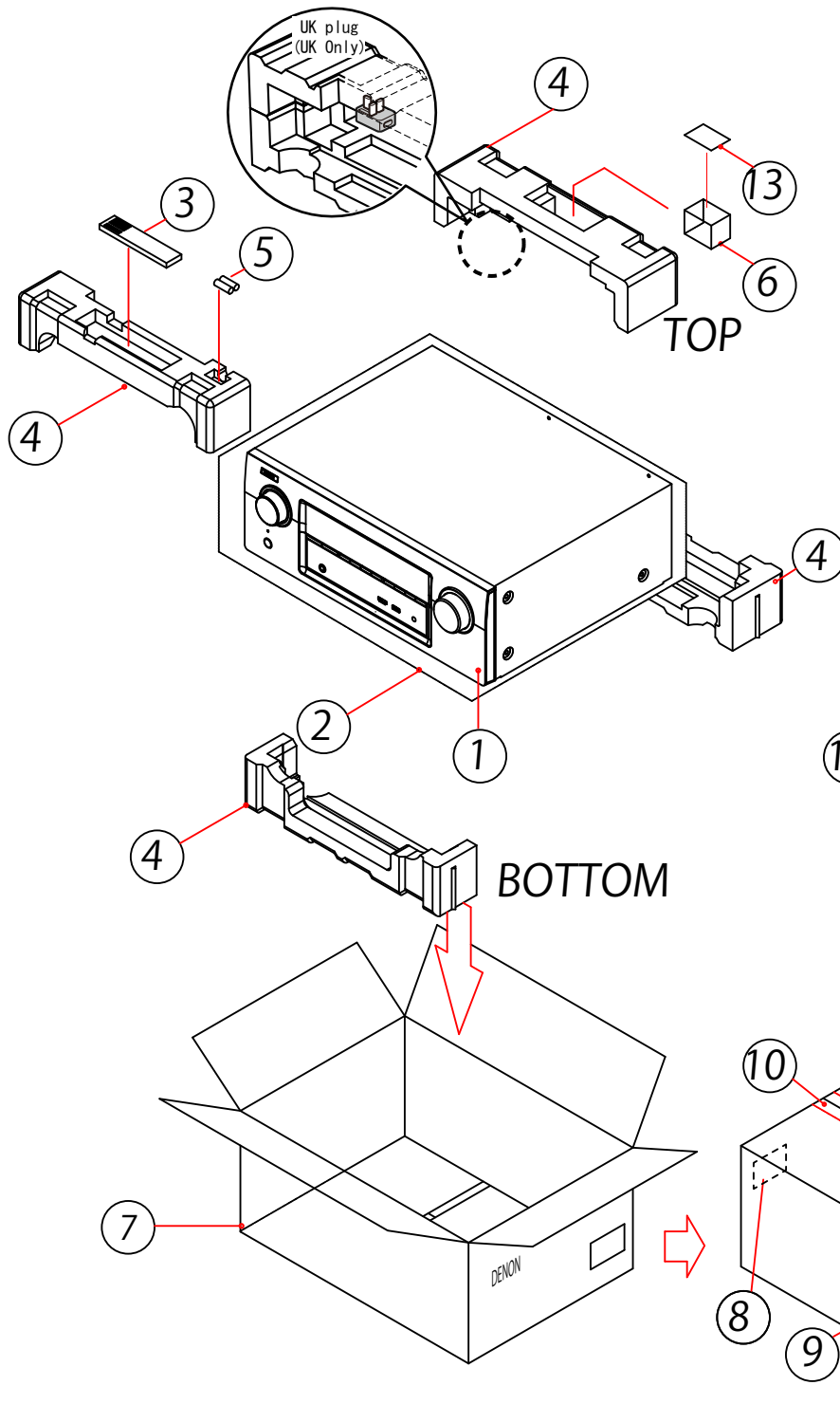

**\*MANUAL POLYBAG ASSY\***

POLYBAG CODE: 6337-04006-201-0S

**ZIPPER BAG (A4size)**

- Notes on RADIO ( ALL )
- SAFETY INST. ( ALL )
- S.S.LIST (JP Only)
- WARRANTY ( E3 Only )
- INSERTION SHEET ( AVR-X2100WE3 Only )
- SPK WIRE LABEL ( ALL )
- FM ANTENNA ( ALL )
- AM ANTENNA ( ALL )
- ANTENNA ISORATOR ( EIC Only )
- CARD PASS ( EIC Only )

---

POLYBAG CODE: 6330-21071-900-0S

**ZIPPER BAG (A5size)**

- INST. MANUAL(CD) ( ALL )
- QUICK START GUIDE ( ALL )
- ※Getting started

* POLY BAG PACKING STYLE	SPEAKER TERMINAL BUSHING	* BOX BOTTOM TAPING
<p>14</p>	<p>15</p>	<p>10</p>

# SEMICONDUCTORS

Only major semiconductors are shown, general semiconductors etc. are omitted to list.  
The semiconductor which described a detailed drawing in a schematic diagram are omitted to list.

## 1. IC's

### R5F56108VNFP (HDMI : U1018)

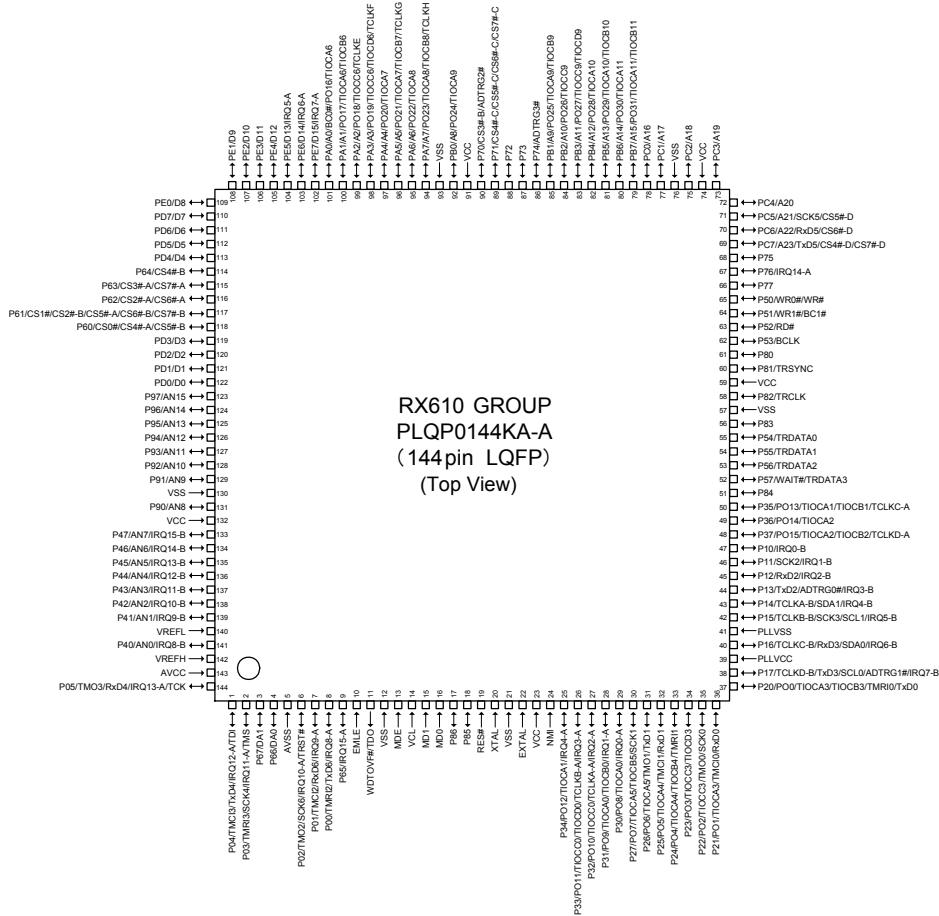

### R5F56108VNFP Terminal Functions

Pin	Pin Name	Symbol	I/O	Pu/Pd	STBY	STOP	CEC STBY	Function
1	P04/IRQ12-A/TMC13/TxD4/TDI	NC	I/O/I	M3VPu	-/-/I	-/-/I	I	Unused
2	P03/IRQ11-A/TMRI3/SCK4/TMS	NC	I/I	M3VPu	-/I	-/I	I	Unused
3	P67/DA1	NC	O		L	L	L	NC
4	P66/DA0	NC	O		L	L	L	NC
5	AVSS	AVSS	-		-	-	-	GND
6	P02/IRQ10-A/TMO2/SCK6/TRST#	NC	I/I	Pd	I/I	I/I	I	Unused
7	P01/IRQ9-A/TMC12/RxD6	RXD MI2320	I	Pd	I	I	I	Data received from the external pin(AMX)/Use for firmware upgrading by DFW.
8	P00/IRQ8-A/TMRI2/TxD6	TXD MO2321	O		L	L	L	Data transfer to external pin(AMX)/Use for firmware upgrading by DFW.
9	P65/IRQ15-A	POWER KEY	I	M3VPu	I	I	I	POWER KEY (Waiting Mode cancel, interrupt port)
10	EMLE	NC	I	Pd	-	-	-	Unused
11	WDTOVF#/TDO	NC	O/O		-	-	-	Unused
12	VSS	VSS	I		-	-	-	GND
13	MDE	NC	I	Pd	-	-	-	Unused
14	VCL	VCL	I		-	-	-	Smoothing capacitor connection pin
15	MD1	NC	I	M3VPu	-	-	-	Unused
16	MD0	NC	I	M3VPu	-	-	-	Unused
17	P86	232C ONTROL (SUB LOG MODE)	O		L	L	L	SUB LOG MODE 232C course switching control

Pin	Pin Name	Symbol	I/O	Pu/Pd	STBY	STOP	CEC STBY	Function
18	P85	REMOTE POWER(232C) (X2100W(NA))/ NC(S900W/ X2100W(EU/CH/AP/ JP))	O		L	L	L	232C POWER SUPPLY (REMOTE 3.3V) control pin.(ON: H)
19	RES#	RESET	I		-	-	-	Reset input (reset: L)
20	XTAL	XTAL	I		-	-	-	Oscillator connection
21	VSS	VSS	-		-	-	-	GND
22	EXTAL	EXTAL	-		-	-	-	Oscillator connection
23	VCC	VCC	-		-	-	-	+3.3V
24	NMI	NMI	I	M3VPu	-	-	-	Unused
25	P34/IRQ4-A/PO12/ TIOCA1	BDOWN	I		I	I	I	Power failure detection pin(Power failure:L)
26	P33/IRQ3-A/PO11/ TIOCC0/TIOCD0/ TCLKB-A	DAC.PLD ERR	I		L	L	L	PLD ERROR detection pin
27	P32/IRQ2-A/PO10/ TIOCC0/TCLKA-A	NC	O/I		L/I	L/I	L/I	NC
28	P31/IRQ1-A/PO9/ TIOCA0/TIOCB0	NC	O		L	L	L	NC
29	P30/IRQ0-A/PO8/ TIOCA0	RC IN	I		I	I	I	Remote control signal input pin
30	P27/PO7/TIOCA5/ TIOCB5/SCK1	NC	O		L	L	L	NC
31	P26/PO6/TIOCA5/ TMO1/TxD1	NC	O		L	L	L	NC
32	P25/PO5/TIOCA4/ TMC11/RxD1	NC	O		L	L	L	NC
33	P24/PO4/TIOCA4/ TIOCB4/TMR1	TU RST	O	SW3VPu	L	L	L	TUNER RESET pin
34	P23/PO3/TIOCC3/ TIOCD3	E RESET	O(ODR)	N3VPu	L	L	L	ETHERNET RESET control pin
35	P22/PO2/TIOCC3/ TMO0/SCK0	E SPI CLK	O	N3VPu	L	L	L	ETHERNET communication control pin
36	P21/PO1/TIOCA3/ TMC10/RxD0	E SPI MIEO	I	N3VPu	I	L	I	ETHERNET communication control pin
37	P20/PO0/TIOCA3/ TIOCB3/TMR10/TxD0	E SPI MOEI	O	N3VPu	L	L	L	ETHERNET communication control pin
38	P17/IRQ7-B/TCLKD-B/ TxD3/SCL0/ADTRG1#	TU SCLK	I_O		L	L	L	TUNER control pin
39	PLLVCC	PLLVCC	-		-	-	-	+3.3V
40	P16/IRQ6-B/TCLKC-B/ RxD3/SDA0	TU SDIO	I_O		L	L	L	TUNER control pin
41	PLLVSS	PLLVSS	-		-	-	-	GND
42	P15/IRQ5-B/TCLKB-B/ SCK3/SCL1	EEPROM SCL	O	M3VPu	I	I	I	EEPROM control pin
43	P14/IRQ4-B/TCLKA-B/ SDA1	EEPROM SDA	I_O	M3VPu	I	I	I	EEPROM control pin
44	P13/IRQ3-B/TxD2/ ADTRG0#	ADV8003 SPI MO	O		L	L	L	OSD control pin
45	P12/IRQ2-B/RxD2	ADV8003 SPI MI	I		L	L	L	OSD control pin
46	P11/IRQ1-B/SCK2	ADV8003 SPI CLK	O		L	L	L	OSD control pin
47	P10/IRQ0-B	ADV8003 SPI CS	O		L	L	L	OSD control pin
48	P37/PO15/TIOCA2/ TIOCB2/TCLKD-A	NC	O		L	L	L	NC
49	P36/PO14/TIOCA2	NC	O		L	L	L	NC
50	P35/PO13/TIOCA1/ TIOCB1/TCLKC-A	NC	O		L/H	L/L	L/H	NC
51	P84	NC	O		L	L	L	NC
52	P57/WAIT#/TRDATA3	NC	O		L	L	L	NC
53	P56/TRDATA2	E POWER1	O		L	L	L	ETHERNET POWER SUPPLY (NET3.3V) control pin
54	P55/TRDATA1	E POWER2	O		L	L	L	ETHERNET POWER SUPPLY (NET2.5V) control pin
55	P54/TRDATA0	E POWER3	O		L	L	L	ETHERNET POWER SUPPLY (NET1.8V) control pin
56	P83	E POWER4	O		L	L	L	ETHERNET POWER SUPPLY (NET1.2V) control pin
57	VSS	VSS	-		-	-	-	GND



Pin	Pin Name	Symbol	I/O	Pu/Pd	STBY	STOP	CEC STBY	Function
58	P82/TRCLK	FL CE	O		L	L	L	VFD control pin
59	VCC	VCC	-		-	-	-	+3.3V
60	P81/TRSYNC	FL RST	O		L	L	L	VFD control pin
61	P80	ZVOL DATA(X2100W)/ NC(S900W)	O		L	L	L	ZONE VOLUME control pin
62	BCLK/P53(input)	NC	O		L	L	L	NC
63	P52/RD#	ZVOL CLK(X2100W)/ NC(S900W)	O		L	L	L	ZONE VOLUME control pin
64	P51/WR1#/BC1#	ZVOL MUTE(X2100W)/ NC(S900W)	O		L	L	L	ZONE VOLUME control pin
65	P50/WR0#/WR#	NC	O		L	L	L	NC
66	P77	THERMAL E	I	SW3VPu	I	L	I	HEAT PROTECT-E detection pin
67	P76/IRQ14-A	TU GPO2_INT	I		L	L	L	TUNER control pin
68	P75	SUB UPDATE	O		L	L	L	SUB UPDATE mode control(DPMS/DFW WRITTER)."L". SUB Program mode "H", then SUB RST.
69	PC7/A23/CS4#-D/ CS7#-D/TxD5	MOSI	O		L	L	L	MAIN-SUB ucom communication control pin
70	PC6/A22/CS6#-D/ Rx D5	SOMI	I		I	L	I	MAIN-SUB ucom communication control pin
71	PC5/A21/CS5#-D/ SCK5	CLK MO	O		L	L	L	MAIN-SUB ucom communication control pin
72	PC4/A20	RST SUB	O		L	L	L	MAIN-SUB ucom communication control pin
73	PC3/A19	ACK SIMO	O		L	L	L	MAIN-SUB ucom communication control pin
74	VCC	VCC	-		-	-	-	+3.3V
75	PC2/A18	SUB CPU POWER	O		L	L	L	SUB CPU POWER SUPPLY control pin (POWER ON : H)
76	VSS	VSS	-		-	-	-	GND
77	PC1/A17	WHITE LED(X2100W(NA))/ GREEN LED(S900W/ X2100W(EU/CH/JP))	O		L	L	L	POWER LED control pin(ON:H)
78	PC0/A16	RED LED	O		L/H	L	H	POWER/STANDBY LED control pin (ON:H)
79	PB7/A15/PO31/ TIOCA11/TIOCB11	H/P RL	O		L	L	L	HEADPHONE RLY control pin
80	PB6/A14/PO30/ TIOCA11	FRONT RL	O		L	L	L	SPEAKER RELAY control pin
81	PB5/A13/PO29/ TIOCA10/TIOCB10	NC(THERMAL F RESERVE)	I	SW3VPu	I	L	I	NC(THERMAL F RESERVE)
82	PB4/A12/PO28/ TIOCA10	TU SEN	O		L	L	L	TUNER control pin
83	PB3/A11/PO27/ TIOCC9/TIOCD9	C/S RL	O		L	L	L	SPEAKER RELAY control pin
84	PB2/A10/PO26/ TIOCC9	SB RL	O		L	L	L	SPEAKER RELAY control pin
85	PB1/A9/PO25/ TIOCA9/TIOCB9	D5V POWER	O		L	L	H	DIGITAL POWER SUPPLY (D5V) control pin (ON:H)
86	P74/ADTRG3#	NC	O		L	L	L	NC
87	P73	NC	O		L	L	L	NC
88	P72	NC	O		L	L	L	NC
89	P71/CS4#-C/CS5#-C/ CS6#-C/CS7#-C	NC	O		L	L	L	NC
90	P70/CS3#-B/ ADTRG2#	NC	O		L	L	L	NC
91	VCC	VCC	-		-	-	-	+3.3V
92	PB0/A8/PO24/TIOCA9	NC	O		L	L	L	NC
93	VSS	VSS	-		-	-	-	GND
94	PA7/A7/PO23/ TIOCA8/TIOCB8/ TCLKH	NC	O		L	L	L	NC
95	PA6/A6/PO22/TIOCA8	VSELA	I		I	I	I	Master Volume rotation detection pin(Rotary encoder)
96	PA5/A5/PO21/ TIOCA7/TIOCB7/ TCLKG	VSEL B	I		I	I	I	Master Volume rotation detection pin(Rotary encoder)
97	PA4/A4/PO20/TIOCA7	NC	O		L	L	L	NC

Pin	Pin Name	Symbol	I/O	Pu/Pd	STBY	STOP	CEC STBY	Function
98	PA3/A3/PO19/ TIOCC6/TIOCD6/ TCLKF	DAC(ETHER) MUTE	O		L	L	L	DAC (ETHER) MUTE control pin (MUTE ON="L")
99	PA2/A2/PO18/ TIOCC6/TCLKE	PRE Z2 MUTE(x2100W)/ NC(S900W)	O		L	L	L	Z2 PRE OUT MUTE control pin
100	PA1/A1/PO17/ TIOCA6/TIOCB6	CLK MUTE	O		L	L	L	A.PLD MUTE control pin (MUTE Active="H")
101	PA0/A0/BC0#/PO16/ TIOCA6	PRE MUTE	O		L	L	L	PRE OUT MUTE control pin
102	PE7/IRQ7-A/D15	E FACT RST	O	Pd	L	L	L	ETHERNET communication control pin(Factory Reset)
103	PE6/IRQ6-A/D14	NC	O		L	L	L	NC
104	PE5/IRQ5-A/D13	REQ SOMI	I		I	L	I	MAIN-SUB ucom communication control pin
105	PE4/D12	ISEL A	I		I	I	I	Input Selector rotation detection pin(Rotary encoder)
106	PE3/D11	ISEL B	I		I	I	I	Input Selector rotation detection pin(Rotary encoder)
107	PE2/D10	VOL CLK1	O		L	L	L	FUNCTION / VOLUME control pin (R2A15218)
108	PE1/D9	VOL DATA	O		L	L	L	FUNCTION / VOLUME control pin (R2A15218)
109	PE0/D8	NC	O		L	L	L	NC
110	PD7/D7	NC	O		L	L	L	NC
111	PD6/D6	NC	O		L	L	L	NC
112	PD5/D5	ASO DET	I	SW3VPu	I	I	I	ASO PROTECT detection pin
113	PD4/D4	DC DET	I	SW3VPu	I	I	I	DC PROTECT detection pin
114	P64/CS4#-B	NC	O		L	L	L	NC
115	P63/CS3#-A/CS7#-A	NC	O		L	L	L	NC
116	P62/CS2#-A/CS6#-A	E SPI CS	O	N3VPu	L	L	L	ETHERNET communication control pin
117	P61/CS1#/CS2#-B/ CS5#-A/CS6#-B/ CS7#-B	Hi-B RL	O		L	L	L	HIGH B RELAY control pin
118	P60/CS0#/CS4#-A/ CS5#-B	NC	O		L	L	L	NC
119	PD3/D3	NC	O		L	L	L	NC
120	PD2/D2	NC	O		L	L	L	NC
121	PD1/D1	FL CLK	O		L	L	L	VFD control pin
122	PD0/D0	FL DATA	O		L	L	L	VFD control pin
123	P97/AN15	NC(THERMAL C RESERVE)	O		I	L	I	NC(THERMAL C RESERVE)
124	P96/AN14	NC(THERMAL D RESERVE)	O		I	L	I	NC(THERMAL D RESERVE)
125	P95/AN13	THERMAL A	I	SW3VPu	I	L	I	HEAT PROTECT-A detection pin
126	P94/AN12	THERMAL B	I	SW3VPu	I	L	I	HEAT PROTECT-B detection pin
127	P93/AN11	MAIN POWER	O		L	L	L	MAIN POWER control pin
128	P92/AN10	CPU POWER	O		L	L	L	CPU INTERFACE POWER SUPPLY (SWM3.3V & SWM5V) control pin (POWER ON: H , CEC ON STANDBY: H)
129	P91/AN9	AMPSIGDET	I		I	L	I	AMP SIGNAL detection pin
130	VSS	VSS	-		-	-	-	GND
131	P90/AN8	MODE	I		I	I	I	Destination detection pin
132	VCC	VCC	-		-	-	-	+3.3V
133	P47/IRQ15-B/AN7	MIC DET	I		I	I	I	MIC detection detection pin
134	P46/IRQ14-B/AN6	H/P DET	I		I	I	I	Headphone detection detection pin
135	P45/IRQ13-B/AN5	KEY3	I	M3VPu	I	I	I	Button input 3
136	P44/IRQ12-B/AN4	KEY2	I	M3VPu	I	I	I	Button input 2
137	P43/IRQ11-B/AN3	KEY1	I	M3VPu	I	I	I	Button input 1
138	P42/IRQ10-B/AN2	E SPI REQ	I	Pd	I	L	I	ETHERNET communication control pin
139	P41/IRQ9-B/AN1	NC	O		L	L	L	NC
140	AVSS	AVSS	-		-	-	-	GND
141	P40/IRQ8-B/AN0	CURRENT DET	I		I	L	I	AMP CURRENT detection pin
142	VREF	VREF	-		-	-	-	Reference voltage (+3.3V) input pin for A/D port
143	AVCC	AVCC	-		-	-	-	+3.3V
144	P05/IRQ13-A/TMO3/ RxD4/TCK	NC	I/I/I	M3VPu	-/I	-/I	I	Unused

## R5F5210ABDFP (HDMI : U1020)

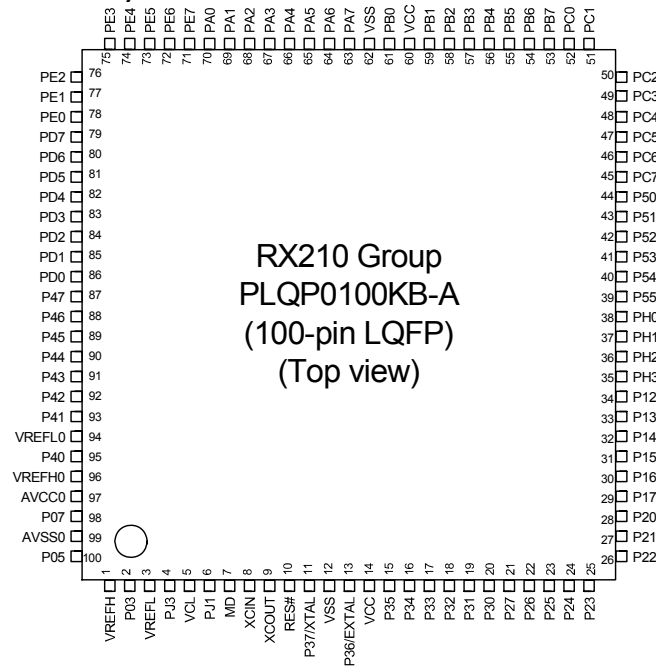

RX210 Group  
PLQP0100KB-A  
(100-pin LQFP)  
(Top view)

## R5F5210ABDFP Terminal Functions

Pin	Symbol	Pin Name	I/O	Pu/Pd	LvCnv	STBY	CEC STBY	Function
1	VREFH	VREFH	-	-	-	-	-	+3.3V
2	P03/DA0	NET/HDMI	O	C	-	Z	L	VPLD control pin (H:NET/WiFi/USB/BT,L:HDMI)
3	VREFL	VREFL	-	-	-	-	-	GND
4	PJ3	778_3/778_2	O	C	-	Z	-	Audio data Bus control pin (HDMI input) (H:MN8647781_3,L:MN8647781_2)
5	VCL	VCL	I	-	-	-	-	Smoothing capacitor connection pin
6	PJ1	TX/RX	O	C	-	Z	-	NC
7	MD	MD	I	-	SCPU 3VPu	-	-	Single-chip/Micro-processor mode switching (Normal single-chip : L, Rewrite boot program start : H input set)
8	XCIN	XCIN	I	-	-	-	-	NC
9	XCOUT	XCOUT	O	-	-	-	-	NC
10	RES#	SUB_RESET	I	-	SCPU 3VPu	Z	-	Reset input
11	XTAL/P37	XTAL	O	-	-	-	-	Oscillator connection
12	VSS	VSS	-	-	-	-	-	GND
13	EXTAL/P36	EXTAL	I	-	-	-	-	Oscillator connection
14	VCC	VCC	-	-	-	-	-	+3.3V
15	P35/NMI(input)	NMI	I	-	SCPU 3VPu	-	-	NC
16	P34/SCK6/IRQ4	CEC_OUT	O	C	-	Z	-	CEC-D signal output pin
17	P33/RXD6/SSCL6/IRQ3-DS	778_2_HAINT	I	-	-	Z	-	HDMI MN8647781(RX) Audio INT input pin
18	P32/TXD6/SSDA6/IRQ2-DS	CEC_IN	I	-	SCPU 3VPu	Z	-	CEC-D signal input pin
19	P31/IRQ1-DS	ACKSIMO	I	-	-	Z	-	MAIN-SUB ucom communication control pin
20	P30/RXD1/SSCL1/IRQ0DS	SCPURXD	I	-	Pd	Z	-	Data reception input from the external
21	P27/SCK1	DIRCE	O	C	-	Z	L	DIR control pin(PCM9211)
22	P26/TXD1/SSDA1	SCPUTXD	O	C	SCPU 3VPu	Z	-	Data transmission output to external
23	P25	DIRDOUT	I	-	DA 3.3Pu	Z	-	DIR control pin(PCM9211)
24	P24	DIRCLK	O	C	-	Z	L	DIR control pin(PCM9211)
25	P23	REQSOMI	O	C	-	Z	-	MAIN-SUB ucom communication control pin
26	P22/SCK0	CLKSIMO	I	-	-	Z	-	MAIN-SUB ucom communication control pin
27	P21/RXD0/SSCL0	SIMO	I	-	-	Z	-	MAIN-SUB ucom communication control pin
28	P20/TXD0/SSDA0	SOMI	O	C	-	Z	-	MAIN-SUB ucom communication control pin
29	P17/SCK1/IRQ7	DIRRST	O	C	-	O/L	L	DIR control pin(PCM9211)
30	P16/TXD1/SSDA1/IRQ6	DIRDIN	O	C	-	Z	L	DIR control pin(PCM9211)
31	P15/RXD1/SSCL1/IRQ5	SUB_BDOWN	I	-	-	Z	-	Power failure detect(Power failure:L)
32	P14/IRQ4	NC	O	C	-	Z	-	NC
33	P13/SDA/IRQ3	NC	O	C	-	Z	-	NC

Pin	Symbol	Pin Name	I/O	Pu/Pd	LvCnv	STBY	CEC STBY	Function
34	P12/SCL/IRQ2	778_1_RST	O	C	Pd	Z	※	HDMI MN8647781(TX) RESET control pin
35	PH3	HSDA	I/O	C	CEC 3VPu	O/L	L	HDMI I2C- MN8647781
36	PH2/IRQ1	HSCL	I/O	C	CEC 3VPu	O/L	L	HDMI I2C- MN8647781
37	PH1/IRQ0	778_1_HINT	I	-	-	Z	-	HDMI MN8647781(TX) HDMI INT input pin
38	PH0	778_2_RST	O	C	Pd	Z	※	HDMI MN8647781(RX) RESET control pin
39	P55	778_2_HINT	I	-	-	Z	-	HDMI MN8647781(RX) HDMI INT input pin
40	P54	778_3_RST	O	C	Pd	Z	※	HDMI MN8647781(RX) RESET control pin
41	BCLK/P53	778_3_HINT	I	-	-	Z	-	HDMI MN8647781(RX) HDMI INT input pin
42	P52	IP_RST	O	C	Pd	Z	L	HDMI ADV8003 RESET control pin
43	P51	DE_RST	O	C	Pd	Z	L	HDMI ADV7850 RESET control pin
44	P50	DE_INT	I	-	-	Z	-	HDMI ADV7850 HDMI INT input pin
45	PC7/TXD8/SSDA8	UB	I	-	Pd	Z	-	Unused
46	PC6/RXD8/SSCL8	HINSELA	O	C	-	Z	-	TC74VHC4051AFT control pin. (Control the detection of HDMI 5V INPUT for CEC STANDBY. )
47	PC5/SCK8	HINSELB	O	C	-	Z	-	TC74VHC4051AFT control pin. (Control the detection of HDMI 5V INPUT for CEC STANDBY. )
48	PC4/SCK5	HINSELC	O	C	-	Z	-	TC74VHC4051AFT control pin. (Control the detection of HDMI 5V INPUT for CEC STANDBY. )
49	PC3/TXD5/SSDA5	DSPMOSI	O	C	DA3 VPu	Z	L	DSP control pin (ADSP21487KSWZ-3B)
50	PC2/RXD5/SSCL5	DSPMISO	I	-	DA3 VPu	Z	-	DSP control pin (ADSP21487KSWZ-3B)
51	PC1/SCK5	DSPICLK	O	C	DA3 VPu	Z	L	DSP control pin (ADSP21487KSWZ-3B)
52	PC0	DA_POWER	O	C	-	Z	L	DIGITAL AUDIO POWER SUPPLY (DA3.3V & DA1.1V) control pin.(ON:H)
53	PB7/TXD9/SSDA9	AVSDA	I/O	C	DV3 VPu	O/L	L	VIDEO I2C- ADV8003/ADV7850
54	PB6/RXD9/SSCL9	AVSCL	I/O	C	DV3 VPu	O/L	L	VIDEO I2C- ADV8003/ADV7850
55	PB5/SCK9	CEC_POWER	O	C	-	Z	※	HDMI CEC POWER SUPPLY control pin (CEC5V,CEC3.3V,CEC1.8V)
56	PB4	DV_POWER1	O	C	-	Z	L	Digital VIDEO POWER SUPPLY control pin (DV5V,DV3.3V)
57	PB3/SCK8	DV_POWER2	O	C	-	Z	-	Digital VIDEO POWER SUPPLY control pin (DV1.8V)
58	PB2	H5VDET	I	-	-	Z	-	HDMI INPUT 5V (for EDID / HOT PLUG) detection pin
59	PB1/TXD6/SSDA6/IRQ4-DS	778_3_HAINT	I	-	-	Z	-	HDMI MN8647781(RX) Audio INT input pin
60	VCC	VCC	-	-	-	-	-	+3.3V
61	PB0/RXD6/SSCL6	NC	O	C	-	Z	-	NC
62	VSS	VSS	-	-	-	-	-	GND
63	PA7	HPD8	O	C	-	Z	L	HPD8 output pin
64	PA6	HPD7	O	C	-	Z	L	HPD7 output pin
65	PA5	HPD6	O	C	-	Z	L	HPD6 output pin
66	PA4/TXD5/SSDA5/IRQ5-DS	HPD5	O	C	-	Z	L	HPD5 output pin
67	PA3/RXD5/SSCL5/IRQ6-DS	HPD4	O	C	-	Z	L	HPD4 output pin
68	PA2/RXD5/SSCL5	HPD3	O	C	-	Z	L	HPD3 output pin
69	PA1/SCK5	HPD2	O	C	-	Z	L	HPD2 output pin
70	PA0	HPD1	O	C	-	Z	L	HPD1 output pin
71	PE7/IRQ7/AN015	APLDCK	O	C	-	Z	L	A.PLD control pin
72	PE6/IRQ6/AN014	APLDCS	O	C	-	O/L	L	A.PLD control pin
73	PE5/IRQ5/AN013	APLDDI	O	C	-	Z	L	A.PLD control pin
74	PE4/AN012	SUB_TCK	O	C	Pd	Z	L	A.PLD/V.PLD rewriting pin(JTAG)
75	PE3/AN011	SUB_TDI	O	C	DA 3.3Pu	Z	L	A.PLD/V.PLD rewriting pin(JTAG)
76	PE2/RXD12/SSCL12/IRQ7-DS/AN010	SUB_TDO	I	-	-	Z	L	A.PLD/V.PLD rewriting pin(JTAG)
77	PE1/TXD12/SSDA12/AN009	SUB_TMS	O	C	DA 3.3Pu	Z	L	A.PLD/V.PLD rewriting pin(JTAG)
78	PE0/SCK12/AN008	DACRST1	O	C	-	Z	L	D/A converter control pin(PCM1690)
79	PD7/IRQ7	NC	O	C	-	Z	-	NC
80	PD6/IRQ6	DACMC	O	C	-	Z	L	D/A converter control pin(PCM1690)
81	PD5/IRQ5	DACMD	O	C	-	Z	L	D/A converter control pin(PCM1690)
82	PD4/IRQ4	DACMS1	O	C	-	Z	L	D/A converter control pin(PCM1690)
83	PD3/IRQ3	NC	O	C	-	Z	-	NC
84	PD2/IRQ2	DSP1RST	O	C	-	Z	L	DSP(ADSP21487KSWZ-3B) reset output pin (Reset : L)

Pin	Symbol	Pin Name	I/O	Pu/Pd	LvCnv	STBY	CEC STBY	Function
85	PD1/IRQ1	DSP1CS	O	C	DA 3VPu	Z	L	DSP control pin (ADSP21487KSWZ-3B)
86	PD0/IRQ0	DSP1FLAG0	I	-	Pd	Z	-	DSP control pin (ADSP21487KSWZ-3B)
87	P47/AN007	NC	O	C	-	Z	-	NC
88	P46/AN006	VIN A	O	C	-	Z	-	COMPOSITE VIDEO SELECT IC(NJM2595)
89	P45/AN005	VIN B	O	C	-	Z	-	COMPOSITE VIDEO SELECT IC(NJM2595)
90	P44/AN004	VIN C	O	C	-	Z	-	COMPOSITE VIDEO SELECT IC(NJM2595)
91	P43/AN003	COMP SW1	O	C		O/L	L	COMPONENT VIDEO SELECT IC(NJM2586)
92	P42/AN002	COMP SW2	O	C		O/L	L	COMPONENT VIDEO SELECT IC(NJM2586)
93	P41/AN001	NC	O	C	-	Z	-	NC
94	VREFL0	VREFL0	-	-	-	-	-	GND
95	P40/AN000	NC	O	C	-	Z	-	NC
96	VREFH0	VREFH0	-	-	-	-	-	+3.3V
97	AVCC0	AVCC	-	-	-	-	-	+3.3V
98	P07	NC	O	C	-	Z	-	NC
99	AVSS0	AVSS0	-	-	-	-	-	GND
100	P05	TXEN	O	C	-	Z	-	Front HDMI INPUT (AD8195) control pin

# AD8195ACPZ (HDMI : U1022)

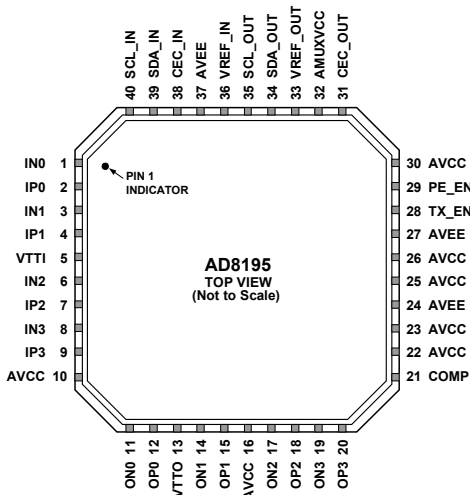

NOTES  
 1. THE AD8195 LFCSP HAS AN EXPOSED PAD ON THE UNDERSIDE OF THE PACKAGE THAT AIDS IN HEAT DISSIPATION. THE PAD MUST BE ELECTRICALLY CONNECTED TO THE AVEE SUPPLY PLANE IN ORDER TO MEET THERMAL SPECIFICATIONS.

07048403

## AD8195ACPZ Termini Function

Pin No.	Mnemonic	Type <sup>1</sup>	Description
1	IN0	HS I	High Speed Input Complement.
2	IP0	HS I	High Speed Input.
3	IN1	HS I	High Speed Input Complement.
4	IP1	HS I	High Speed Input.
5	VTTI	Power	Input Termination Supply. Nominally connected to AVCC.
6	IN2	HS I	High Speed Input Complement.
7	IP2	HS I	High Speed Input.
8	IN3	HS I	High Speed Input Complement.
9	IP3	HS I	High Speed Input.
10, 16, 22, 23, 25, 26, 30	AVCC	Power	Positive Analog Supply. 3.3 V nominal.
11	ON0	HS O	High Speed Output Complement.
12	OP0	HS O	High Speed Output.
13	VTTO	Power	Output Termination Supply. Nominally connected to AVCC.
14	ON1	HS O	High Speed Output Complement.
15	OP1	HS O	High Speed Output.
17	ON2	HS O	High Speed Output Complement.
18	OP2	HS O	High Speed Output.
19	ON3	HS O	High Speed Output Complement.
20	OP3	HS O	High Speed Output.
21	COMP	Control	Power-On Compensation Pin. Bypass to ground through a 10 μF capacitor.
24, 27, 37, Exposed Pad	AVEE	Power	Negative Analog Supply. 0 V nominal.
28	TX_EN	Control	High Speed Output Enable Parallel Interface.
29	PE_EN	Control	High Speed Preemphasis Enable Parallel Interface.
31	CEC_OUT	LS I/O	CEC Output Side.
32	AMUXVCC	Power	Positive Auxiliary Buffer Supply. 5 V nominal.

## AD8195ACPZ Block diagram

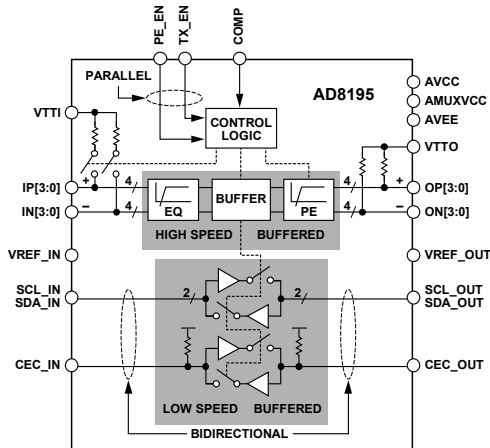

## PCM9211 (HDMI : U1040)

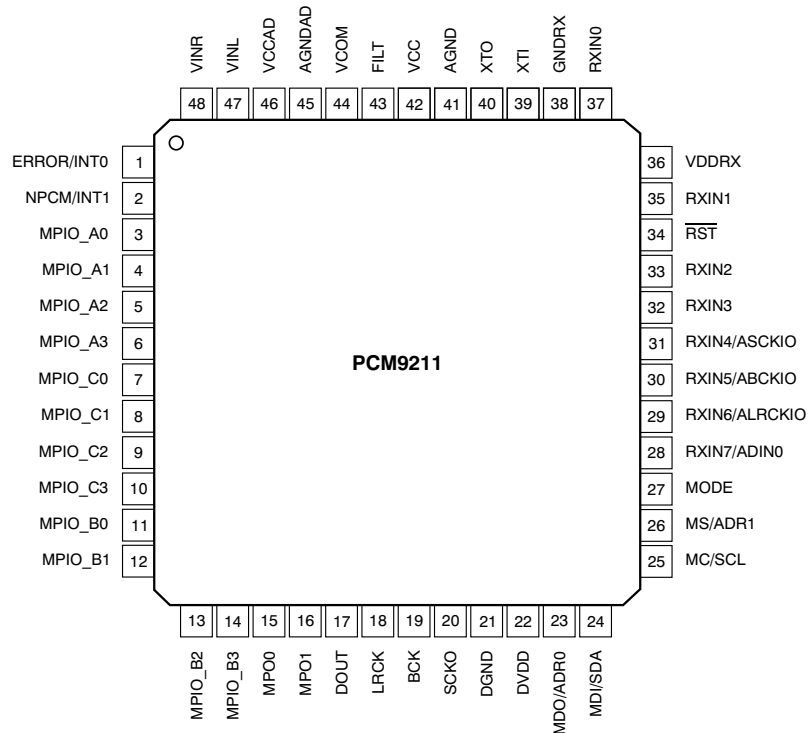

## PIN Functions

PIN				DESCRIPTION
NO.	NAME	I/O	5-V TOLERANT	
1	ERROR/INT0	O	No	DIR Error detection output / Interrupt0 output
2	NPCM/INT1	O	No	DIR Non-PCM detection output / Interrupt1 output
3	MPIO_A0	I/O	Yes	Multipurpose I/O, Group A(1)
4	MPIO_A1	I/O	Yes	Multipurpose I/O, Group A(1)
5	MPIO_A2	I/O	Yes	Multipurpose I/O, Group A(1)
6	MPIO_A3	I/O	Yes	Multipurpose I/O, Group A(1)
7	MPIO_C0	I/O	Yes	Multipurpose I/O, Group C(1)
8	MPIO_C1	I/O	Yes	Multipurpose I/O, Group C(1)
9	MPIO_C2	I/O	Yes	Multipurpose I/O, Group C(1)
10	MPIO_C3	I/O	Yes	Multipurpose I/O, Group C(1)
11	MPIO_B0	I/O	Yes	Multipurpose I/O, Group B(1)
12	MPIO_B1	I/O	Yes	Multipurpose I/O, Group B(1)
13	MPIO_B2	I/O	Yes	Multipurpose I/O, Group B(1)
14	MPIO_B3	I/O	Yes	Multipurpose I/O, Group B(1)
15	MPO0	O	No	Multipurpose output 0
16	MPO1	O	No	Multipurpose output 1
17	DOUT	O	No	Main output port, serial digital audio data output
18	LRCK	O	No	Main output port, LR clock output
19	BCK	O	No	Main output port, Bit clock output
20	SCKO	O	No	Main output port, System clock output
21	DGND	-	-	Ground, for digital
22	DVDD	-	-	Power supply, 3.3 V (typ.), for digital
23	MDO/ADR0	I/O	Yes	Software control I/F, SPI data output / I2C slave address setting0(2)
24	MDI/SDA	I/O	Yes	Software control I/F, SPI data input / I2C data input/output(2) (3)
25	MC/SCL	I	Yes	Software control I/F, SPI clock input / I2C clock input(2)
26	MS/ADR1	I	Yes	Software control I/F, SPI chip select / I2C slave address setting1(2)
27	MODE	I	No	Control mode setting, (see the Serial Control Mode section, Control Mode Pin Setting)
28	RXIN7/ADIN0	I	Yes	Biphase signal, input 7 / AUXIN0, serial audio data input(2)
29	RXIN6/ALRCKIO	I	Yes	Biphase signal, input 6 / AUXIN0, LR clock input(2)
30	RXIN5/ABCKIO	I	Yes	Biphase signal, input 5 / AUXIN0, bit clock input(2)
31	RXIN4/ASCKIO	I	Yes	Biphase signal, input 4 / AUXIN0, system clock input(2)
32	RXIN3	I	Yes	Biphase signal, input 3(2)
33	RXIN2	I	Yes	Biphase signal, input 2(2)

PIN				DESCRIPTION
NO.	NAME	I/O	5-V TOLERANT	
34	RST	I	Yes	Reset Input, active low(2) (4)
35	RXIN1	I	Yes	Biphase signal, input 1, built-in coaxial amplifier
36	VDDR_X	–	–	Power supply, 3.3 V (typ.), for RXIN0 and RXIN1.
37	RXIN0	I	Yes	Biphase signal, input 0, built-in coaxial amplifier
38	GND_R_X	–	–	Ground, for RXIN
39	XTI	I	No	Oscillation circuit input for crystal resonator or external XTI clock source input(5)
40	XTO	O	No	Oscillation circuit output for crystal resonator
41	AGND	–	–	Ground, for PLL analog
42	VCC	–	–	Power supply, 3.3 V (typ.), for PLL analog
43	FILT	O	No	External PLL loop filter connection terminal; must connect recommended filter
44	VCOM	O	No	ADC common voltage output; must connect external decoupling capacitor
45	AGNDAD	–	–	Ground, for ADC analog
46	VCCAD	–	–	Power supply, 5.0 V (typ.), for ADC analog
47	VINL	I	No	ADC analog voltage input, left channel
48	VINR	I	No	ADC analog voltage input, right channel

- (1) Schmitt trigger input
- (2) Schmitt trigger input
- (3) Open-drain configuration in I2C mode
- (4) Onboard pull-down resistor (50 k $\Omega$ , typical)
- (5) CMOS Schmitt trigger input

**PCM9211 BLOCK DIAGRAM**

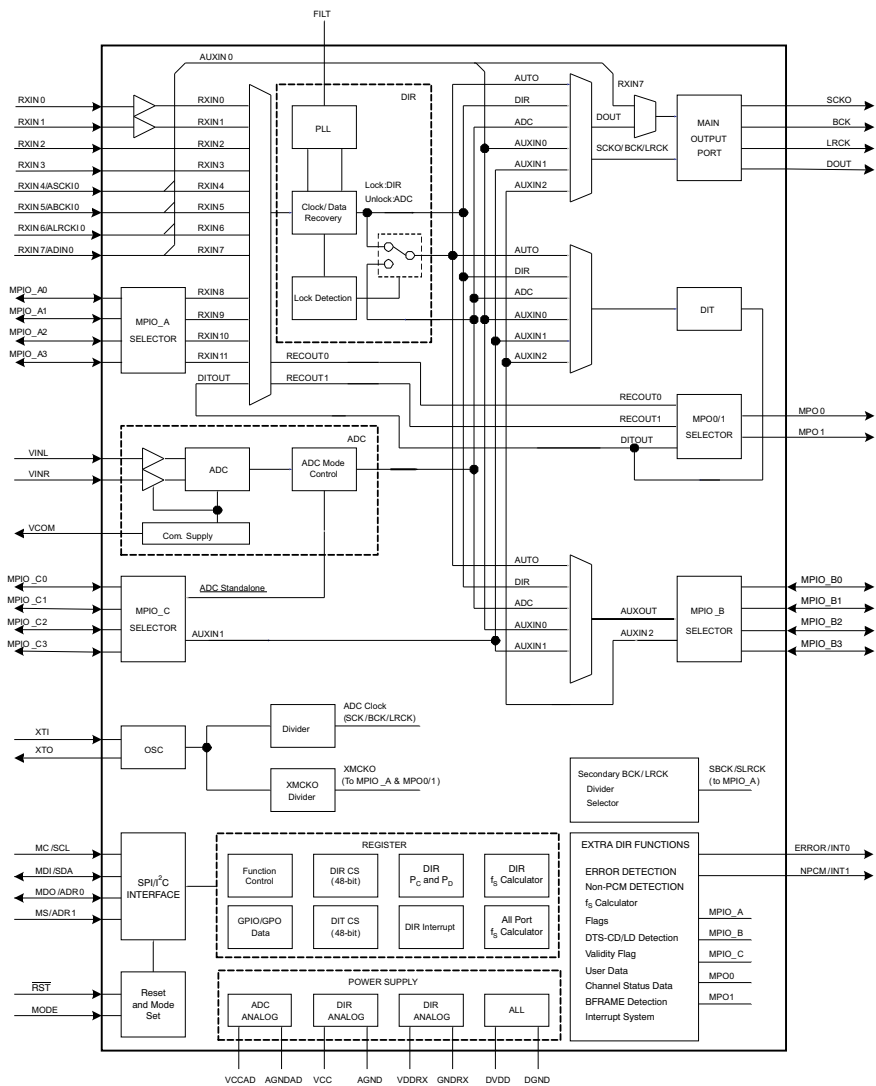



## ADSP21487KSWZ3B (HDMI : U1024)

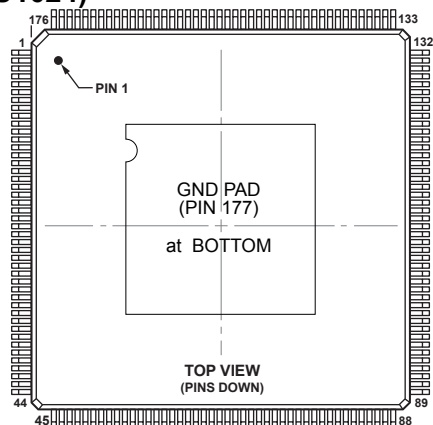

## ADSP21487KSWZ3B Terminal Function

Pin Name	Pin No.	Pin Name	Pin No.	Pin Name	Pin No.	Pin Name	Pin No.
SDDQM	1	V <sub>DD_EXT</sub>	45	DAI_P10	89	V <sub>DD_INT</sub>	133
MS0	2	DPI_P08	46	V <sub>DD_INT</sub>	90	FLAG0	134
SDCKE	3	DPI_P07	47	V <sub>DD_EXT</sub>	91	FLAG1	135
V <sub>DD_INT</sub>	4	V <sub>DD_INT</sub>	48	DAI_P20	92	FLAG2	136
CLK_CFG1	5	DPI_P09	49	V <sub>DD_INT</sub>	93	NC	137
ADDR0	6	DPI_P10	50	DAI_P08	94	FLAG3	138
BOOT_CFG0	7	DPI_P11	51	DAI_P14	95	NC	139
V <sub>DD_EXT</sub>	8	DPI_P12	52	DAI_P04	96	NC	140
ADDR1	9	DPI_P13	53	DAI_P18	97	V <sub>DD_EXT</sub>	141
ADDR2	10	DPI_P14	54	DAI_P17	98	NC	142
ADDR3	11	DAI_P03	55	DAI_P16	99	V <sub>DD_INT</sub>	143
ADDR4	12	NC	56	DAI_P12	100	TRST	144
ADDR5	13	V <sub>DD_EXT</sub>	57	DAI_P15	101	NC	145
BOOT_CFG1	14	NC	58	V <sub>DD_INT</sub>	102	EMU	146
GND	15	NC	59	DAI_P11	103	DATA0	147
ADDR6	16	NC	60	V <sub>DD_EXT</sub>	104	DATA1	148
ADDR7	17	NC	61	V <sub>DD_INT</sub>	105	DATA2	149
NC	18	V <sub>DD_INT</sub>	62	BOOT_CFG2	106	DATA3	150
NC	19	NC	63	V <sub>DD_INT</sub>	107	TDO	151
ADDR8	20	NC	64	AMI_ACK	108	DATA4	152
ADDR9	21	V <sub>DD_INT</sub>	65	GND	109	V <sub>DD_EXT</sub>	153
CLK_CFG0	22	NC	66	THD_M	110	DATA5	154
V <sub>DD_INT</sub>	23	NC	67	THD_P	111	DATA6	155
CLKIN	24	V <sub>DD_INT</sub>	68	V <sub>DD_THD</sub>	112	V <sub>DD_INT</sub>	156
XTAL	25	NC	69	V <sub>DD_INT</sub>	113	DATA7	157
ADDR10	26	WDRSTO	70	V <sub>DD_INT</sub>	114	TDI	158
SDA10	27	NC	71	MST	115	SDCLK	159
V <sub>DD_EXT</sub>	28	V <sub>DD_EXT</sub>	72	V <sub>DD_INT</sub>	116	V <sub>DD_EXT</sub>	160
V <sub>DD_INT</sub>	29	DAI_P07	73	WDT_CLKO	117	DATA8	161
ADDR11	30	DAI_P13	74	WDT_CLKIN	118	DATA9	162
ADDR12	31	DAI_P19	75	V <sub>DD_EXT</sub>	119	DATA10	163
ADDR17	32	DAI_P01	76	ADDR23	120	TCK	164
ADDR13	33	DAI_P02	77	ADDR22	121	DATA11	165
V <sub>DD_INT</sub>	34	V <sub>DD_INT</sub>	78	ADDR21	122	DATA12	166
ADDR18	35	NC	79	V <sub>DD_INT</sub>	123	DATA14	167
RESETOUT/RUNRSTIN	36	NC	80	ADDR20	124	DATA13	168
V <sub>DD_INT</sub>	37	NC	81	ADDR19	125	V <sub>DD_INT</sub>	169
DPI_P01	38	NC	82	V <sub>DD_EXT</sub>	126	DATA15	170
DPI_P02	39	NC	83	ADDR16	127	SDWE	171
DPI_P03	40	V <sub>DD_EXT</sub>	84	ADDR15	128	SDRAS	172
V <sub>DD_INT</sub>	41	V <sub>DD_INT</sub>	85	V <sub>DD_INT</sub>	129	RESET	173
DPI_P05	42	DAI_P06	86	ADDR14	130	TMS	174
DPI_P04	43	DAI_P05	87	AMI_WR	131	SDCAS	175
DPI_P06	44	DAI_P09	88	AMI_RD	132	V <sub>DD_INT</sub>	176
						GND	177*

\* at BOTTOM

## W9864G6JH-6 (HDMI : U1023)

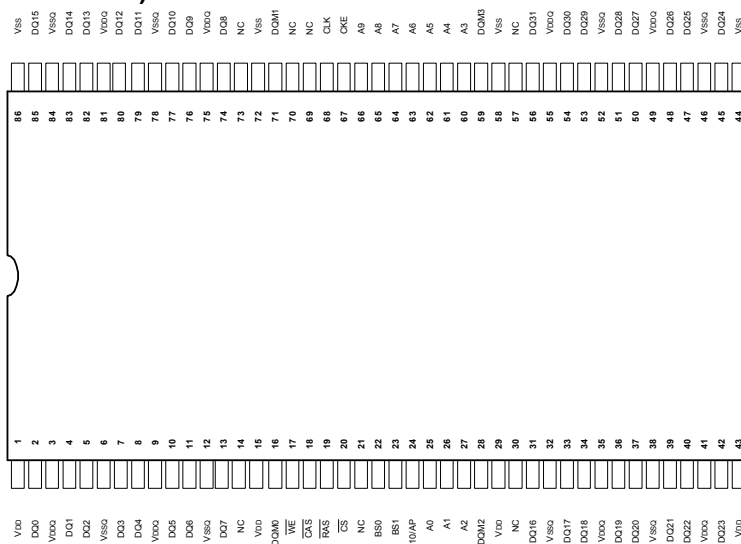

## W9864G6JH-6 Pin description

PIN NUMBER	PIN NAME	FUNCTION	DESCRIPTION
24, 25, 26, 27, 60, 61, 62, 63, 64, 65, 66	A0–A10	Address	Multiplexed pins for row and column address. Row address: A0–A10. Column address: A0–A7. A10 is sampled during a precharge command to determine if all banks are to be precharged or bank selected by BS0, BS1.
22, 23	BS0, BS1	Bank Select	Select bank to activate during row address latch time, or bank to read/write during address latch time.
2, 4, 5, 7, 8, 10, 11, 13, 31, 33, 34, 36, 37, 39, 40, 42, 45, 47, 48, 50, 51, 53, 54, 56, 74, 76, 77, 79, 80, 82, 83, 85	DQ0–DQ31	Data Input/ Output	Multiplexed pins for data output and input.
20	$\overline{\text{CS}}$	Chip Select	Disable or enable the command decoder. When command decoder is disabled, new command is ignored and previous operation continues.
19	$\overline{\text{RAS}}$	Row Address Strobe	Command input. When sampled at the rising edge of the clock $\overline{\text{RAS}}$ , $\overline{\text{CAS}}$ and $\overline{\text{WE}}$ define the operation to be executed.
18	$\overline{\text{CAS}}$	Column Address Strobe	Referred to $\overline{\text{RAS}}$
17	$\overline{\text{WE}}$	Write Enable	Referred to $\overline{\text{RAS}}$
16, 28, 59, 71	DQM0–DQM3	Input/Output Mask	The output buffer is placed at Hi-Z (with latency of 2) when DQM is sampled high in read cycle. In write cycle, sampling DQM high will block the write operation with zero latency.
68	CLK	Clock Inputs	System clock used to sample inputs on the rising edge of clock.
67	CKE	Clock Enable	CKE controls the clock activation and deactivation. When CKE is low, Power Down mode, Suspend mode, or Self Refresh mode is entered.
1, 15, 29, 43	VDD	Power	Power for input buffers and logic circuit inside DRAM.
44, 58, 72, 86	VSS	Ground	Ground for input buffers and logic circuit inside DRAM.
3, 9, 35, 41, 49, 55, 75, 81	VDDQ	Power for I/O Buffer	Separated power from VDD, to improve DQ noise immunity.
6, 12, 32, 38, 46, 52, 78, 84	VSSQ	Ground for I/O Buffer	Separated ground from VSS, to improve DQ noise immunity.
14, 21, 30, 57, 69, 70, 73	NC	No Connection	No connection.

# W9864G6JH-6 Block diagram

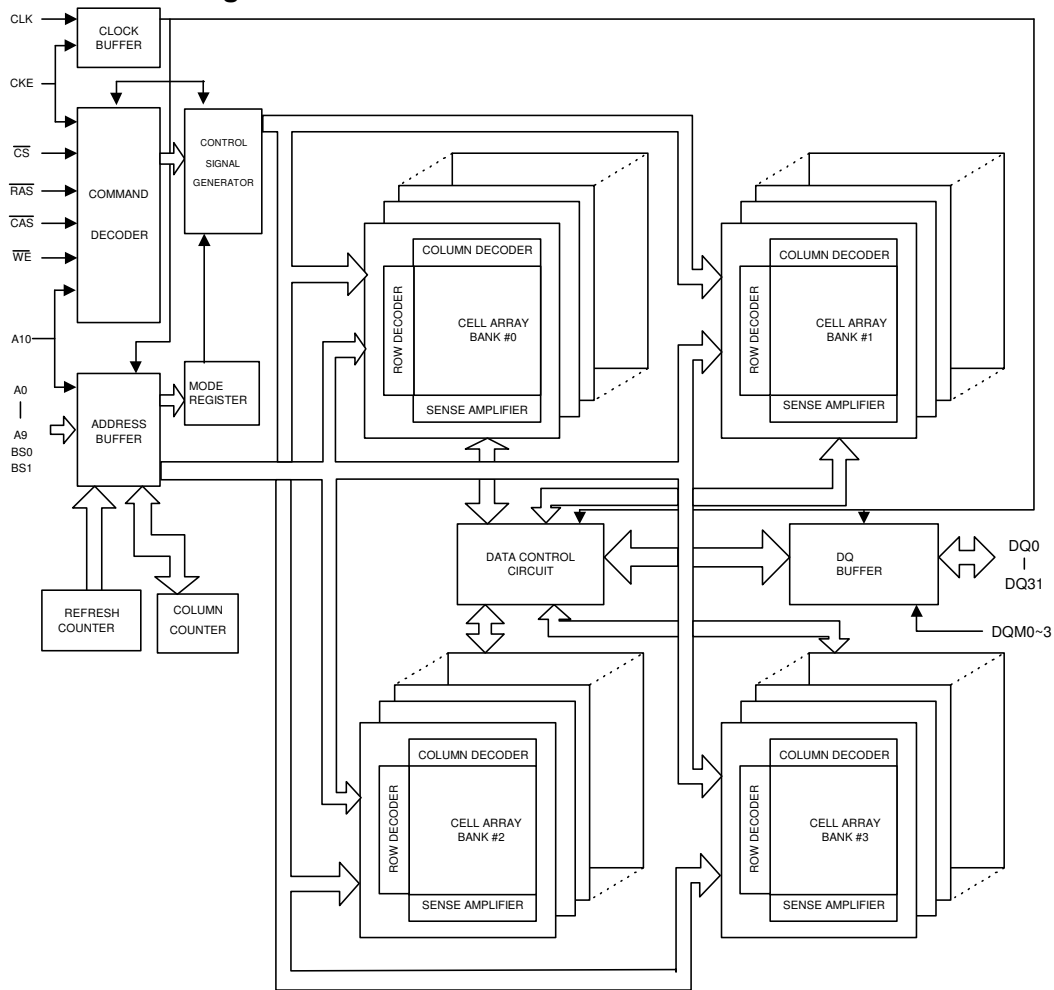

## PCM1690 (HDMI : U1048)

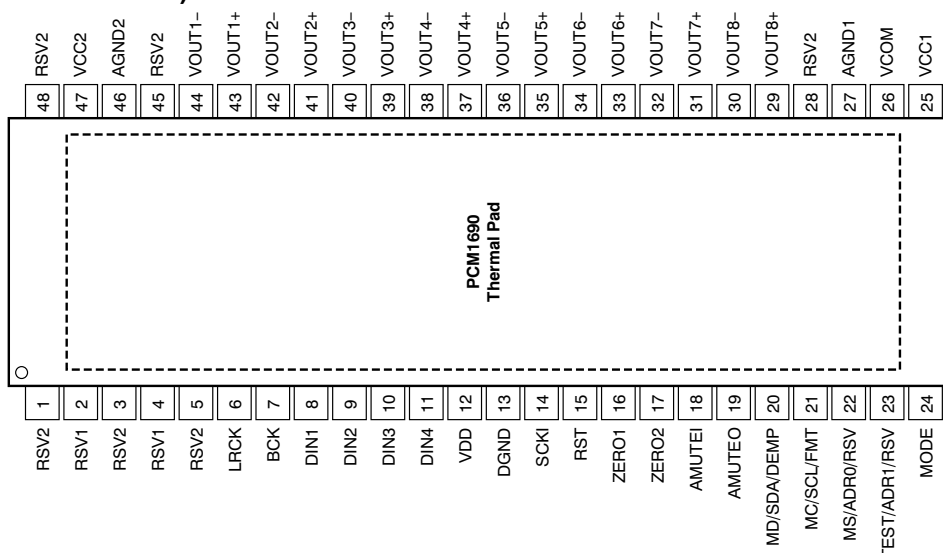

## PCM1690 Pin Function

TERMINAL NAME	PIN	I/O	PULL-DOWN	5-V TOLERANT	DESCRIPTION
RSV2	1	—	—	—	Reserved, tied to analog ground
RSV1	2	—	—	—	Reserved, left open
RSV2	3	—	—	—	Reserved, tied to analog ground
RSV1	4	—	—	—	Reserved, left open
RSV2	5	—	—	—	Reserved, tied to analog ground
LRCK	6	I	Yes	No	Audio data word clock input
BCK	7	I	Yes	No	Audio data bit clock input
DIN1	8	I	No	No	Audio data input for DAC1 and DAC2
DIN2	9	I	No	No	Audio data input for DAC3 and DAC4
DIN3	10	I	No	No	Audio data input for DAC5 and DAC6
DIN4	11	I	No	No	Audio data input for DAC7 and DAC8
VDD	12	—	—	—	Digital power supply, +3.3 V
DGND	13	—	—	—	Digital ground
SCKI	14	I	No	Yes	System clock input
RST	15	I	Yes	Yes	Reset and power-down control input with active low
ZERO1	16	O	No	No	Zero detect flag output 1
ZERO2	17	O	No	No	Zero detect flag output 2
AMUTEI	18	I	No	Yes	Analog mute control input with active low
AMUTEO	19	O	No	Yes	Analog mute status output(1) with active low
MD/SDA/DEMP	20	I/O	No	Yes	Input data for SPI, data for I2C(1), de-emphasis control for hardware control mode
MC/SCL/FMT	21	I	No	Yes	Clock for SPI, clock for I2C, format select for hardware control mode
MS/ADR0/RSV	22	I	Yes	Yes	Chip Select for SPI, address select 0 for I2C, reserve (set low) for hardware control mode
TEST/ADR1/RSV	23	I/O	No	Yes	Test (factory use, left open) for SPI, address select 1 for I2C, reserve (set low) for hardware control mode
MODE	24	I	No	No	Control port mode selection. Tied to VDD: SPI, left open: H/W mode, tied to DGND: I2C
VCC1	25	—	—	—	Analog power supply 1, +5 V
VCOM	26	—	—	—	Voltage common decoupling
AGND1	27	—	—	—	Analog ground 1
RSV2	28	—	—	—	Reserved, tied to analog ground
VOUT8+	29	O	No	No	Positive analog output from DAC8
VOUT8-	30	O	No	No	Negative analog output from DAC8
VOUT7+	31	O	No	No	Positive analog output from DAC7
VOUT7-	32	O	No	No	Negative analog output from DAC7
VOUT6+	33	O	No	No	Positive analog output from DAC6
VOUT6-	34	O	No	No	Negative analog output from DAC6
VOUT5+	35	O	No	No	Positive analog output from DAC5
VOUT5-	36	O	No	No	Negative analog output from DAC5
VOUT4+	37	O	No	No	Positive analog output from DAC4
VOUT4-	38	O	No	No	Negative analog output from DAC4
VOUT3+	39	O	No	No	Positive analog output from DAC3
VOUT3-	40	O	No	No	Negative analog output from DAC3
VOUT2+	41	O	No	No	Positive analog output from DAC2
VOUT2-	42	O	No	No	Negative analog output from DAC2

TERMINAL		I/O	PULL-DOWN	5-V TOLERANT	DESCRIPTION
NAME	PIN				
VOUT1+	43	O	No	No	Positive analog output from DAC1
VOUT1-	44	O	No	No	Negative analog output from DAC1
RSV2	45	—	—	—	Reserved, tied to analog ground
AGND2	46	—	—	—	Analog ground 2
VCC2	47	—	—	—	Analog power supply 2, +5 V
RSV2	48	—	—	—	Reserved, tied to analog ground

(1) Open-drain configuration in out mode.

## PCM1690 FUNCTIONAL BLOCK DIAGRAM

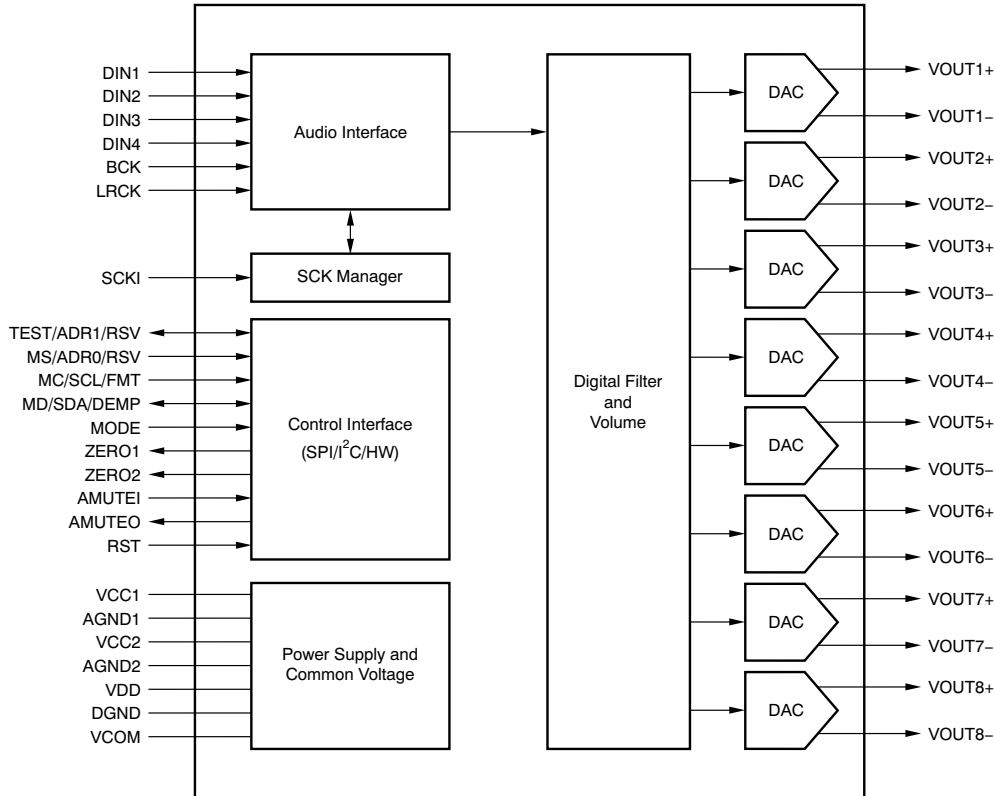

# PCM5100 (HDMI:U1052)

**PCM510X (top view)**

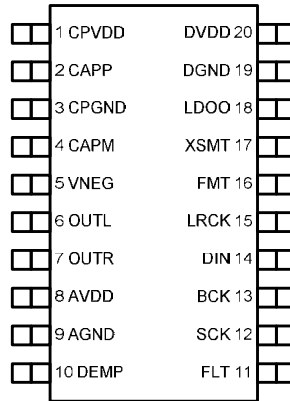
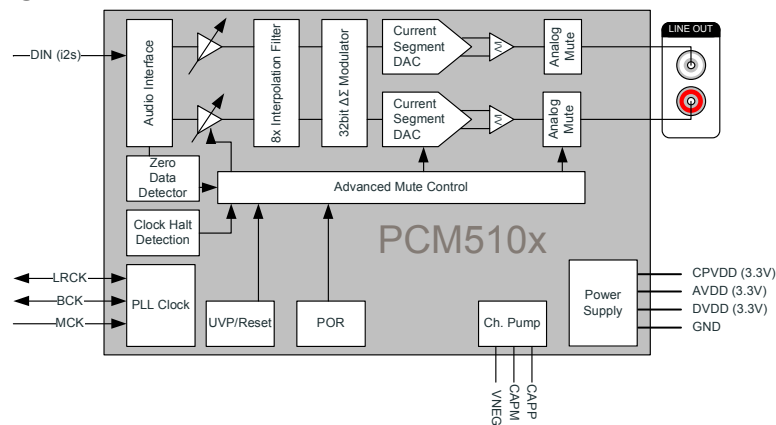

**Table 2. TERMINAL FUNCTIONS, PCM510x**

TERMINAL		I/O	DESCRIPTION
NAME	NO.		
CPVDD	1	-	Charge pump power supply, 3.3V
CAPP	2	O	Charge pump flying capacitor terminal for positive rail
CPGND	3	-	Charge pump ground
CAPM	4	O	Charge pump flying capacitor terminal for negative rail
VNEG	5	O	Negative charge pump rail terminal for decoupling, -3.3V
OUTL	6	O	Analog output from DAC left channel
OUTR	7	O	Analog output from DAC right channel
AVDD	8	-	Analog power supply, 3.3V
AGND	9	-	Analog ground
DEMP	10	I	De-emphasis control for 44.1kHz sampling rate <sup>(1)</sup> : Off (Low) / On (High)
FLT	11	I	Filter select : Normal latency (Low) / Low latency (High)
SCK	12	I	System clock input
BCK	13	I	Audio data bit clock input
DIN	14	I	Audio data input
LRCK	15	I	Audio data word clock input
FMT	16	I	Audio format selection : I <sup>2</sup> S (Low) / Left justified (High)
XSMT	17	I	Soft mute control : Soft mute (Low) / soft un-mute (High)
LDOO	18	-	Internal logic supply rail terminal for decoupling
DGND	19	-	Digital ground
DVDD	20	-	Digital power supply, 3.3V

(1) Failsafe LVCMOS Schmitt trigger input

## PCM5100 Block Diagram



**Figure 1. PCM510x Functional Block Diagram**

R2A15218FP (INPUT : IC4200)

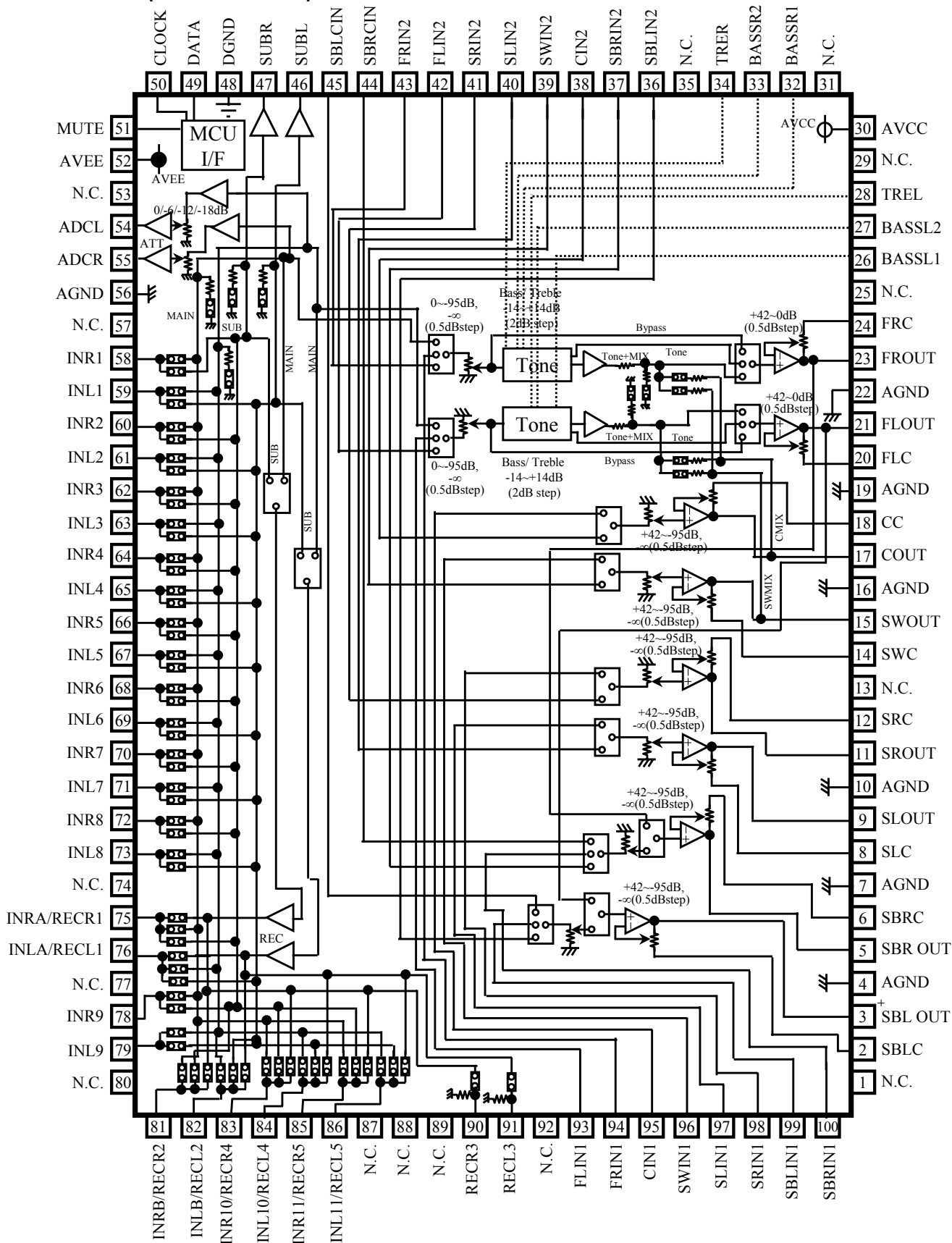

## R2A15218FP Pin Function

PIN No.	Name	Function
23,21, 17,15, 11,9, 5,3	FROUT,FLOUT, COUT,SWOUT, SROUT, SLOUT, SBROUT,SBLOUT	Output pin of FL/FR/C/SW/SL/SR/SBL/SBR channel
24,20, 18,14, 12,8, 6,2	FRC,FLC, CC,SWC, SRC,SLC, SBRC,SBLC	Connects capacitor for reducing click noise of L/R/C/SW/SL/SR/SBL/SBR channel volume
4,7,10,16, 19,22,56	AGND	Analog ground of internal circuit
28,34	TREL, TRER	Frequency characteristic setting pin of L/R channel tone control (Treble)
26,27, 32,33	BASSL1,BASSL2 BASSR1,BASSR2	Frequency characteristic setting pin of L/R channel tone control (Bass)
30	AVCC	Positive power supply to internal circuit
43,42, 41,40, 39,38, 37,36	FRIN2, FLIN2, SRN2,SLIN2, SWIN2,CIN2, SBRIN2,SBLIN2	Input pin of L/R/C/SW/SL/SR/SBL/SBR channel (Multi IN 1/2)
93,94, 95,96, 97,98, 99,100	FLIN1, FRIN1, CIN1,SWIN1, SLIN1,SRIN1, SBLIN1,SBRIN1	
48	DGND	Digital ground of internal circuit
49	DATA	Input pin of control data
50	CLOCK	Input pin of control clock
52	AVEE	Negative power supply to internal circuit
59,61,63, 65,67,69, 71,73,79	INL1,INL2, INL3, INL4,INL5,INL6, INL7,INL8,INL9	Input pin of L/R channel (Input Selector)
58,60,62, 64,66,68, 70,72,78	INR1,INR2, INR3, INR4,INR5,INR6, INR7,INR8,INR9	
51	MUTE	Outside Mute Control PIN
44,45	SBRCIN,SBLCIN	Input pin for SBL/SBR channel Volume
46,47	SUBL,SUBR	Output pin for L/R channel SUB Output
54,55	ADCL, ADCR	Output pin for L/R channel ADC
90,91	RECR3,RECL3	Output pin for L/R channel REC Output
75,76, 81,82, 83,84, 85,86	INRA/RECR1,INLA/RECL1, INRB/RECR2,INLB/RECL2, INR10/RECR4,INL10/RECL4, INR11/RECR5,INL11/RECL5	Input pin of L/R channel (Input Selector)/ Output pin for L/R channel REC Output
1,13,25,29,31, 35,53, 57,74,77,80, 87,88,89,92	N.C.	No Connected PIN



**BD3812F (INPUT:IC5202)**

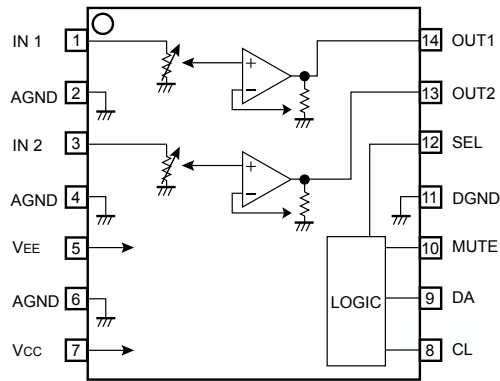

**NJM2595MTE1 (VIDEO:IC5001)**

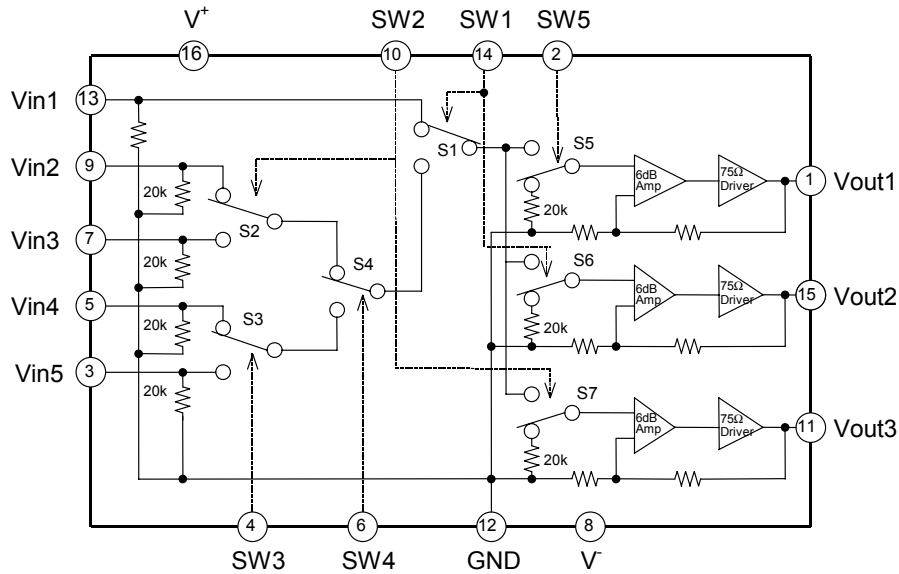

**NJM2586AVC3(VIDEO:IC5002)**

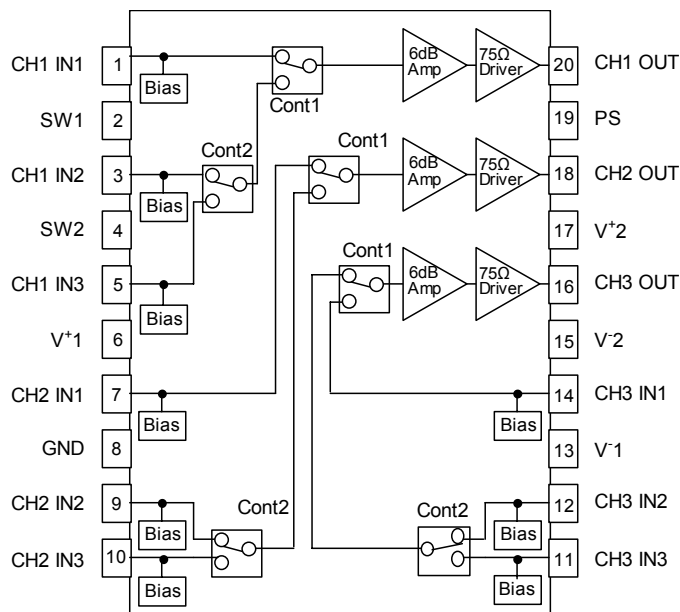

**SSOP20-C3**



# ANODE CONNECTION

	1G	2G	3G	4G	5G	6G	7G	8G	9G	10G	11G	12G	13G	14G	15G	16G	17G	18G
																	(AD3)	(AD4)
D0	1-1	1-1	1-1	1-1	1-1	1-1	1-1	1-1	1-1	1-1	1-1	1-1	1-1	1-1	1-1	1-1	S9	-
D1	2-1	2-1	2-1	2-1	2-1	2-1	2-1	2-1	2-1	2-1	2-1	2-1	2-1	2-1	2-1	2-1	3d	-
D2	3-1	3-1	3-1	3-1	3-1	3-1	3-1	3-1	3-1	3-1	3-1	3-1	3-1	3-1	3-1	3-1	2d	-
D3	4-1	4-1	4-1	4-1	4-1	4-1	4-1	4-1	4-1	4-1	4-1	4-1	4-1	4-1	4-1	4-1	3e	-
D4	5-1	5-1	5-1	5-1	5-1	5-1	5-1	5-1	5-1	5-1	5-1	5-1	5-1	5-1	5-1	5-1	2e	-
D5	1-2	1-2	1-2	1-2	1-2	1-2	1-2	1-2	1-2	1-2	1-2	1-2	1-2	1-2	1-2	1-2	3c	-
D6	2-2	2-2	2-2	2-2	2-2	2-2	2-2	2-2	2-2	2-2	2-2	2-2	2-2	2-2	2-2	2-2	2c	-
D7	3-2	3-2	3-2	3-2	3-2	3-2	3-2	3-2	3-2	3-2	3-2	3-2	3-2	3-2	3-2	3-2	3g	-
D8	4-2	4-2	4-2	4-2	4-2	4-2	4-2	4-2	4-2	4-2	4-2	4-2	4-2	4-2	4-2	4-2	2g	-
D9	5-2	5-2	5-2	5-2	5-2	5-2	5-2	5-2	5-2	5-2	5-2	5-2	5-2	5-2	5-2	5-2	3f	-
D10	1-3	1-3	1-3	1-3	1-3	1-3	1-3	1-3	1-3	1-3	1-3	1-3	1-3	1-3	1-3	1-3	2f	-
D11	2-3	2-3	2-3	2-3	2-3	2-3	2-3	2-3	2-3	2-3	2-3	2-3	2-3	2-3	2-3	2-3	3b	-
D12	3-3	3-3	3-3	3-3	3-3	3-3	3-3	3-3	3-3	3-3	3-3	3-3	3-3	3-3	3-3	3-3	2b	-
D13	4-3	4-3	4-3	4-3	4-3	4-3	4-3	4-3	4-3	4-3	4-3	4-3	4-3	4-3	4-3	4-3	3a	-
D14	5-3	5-3	5-3	5-3	5-3	5-3	5-3	5-3	5-3	5-3	5-3	5-3	5-3	5-3	5-3	5-3	2a	-
D15	1-4	1-4	1-4	1-4	1-4	1-4	1-4	1-4	1-4	1-4	1-4	1-4	1-4	1-4	1-4	1-4	Dp	-
D16	2-4	2-4	2-4	2-4	2-4	2-4	2-4	2-4	2-4	2-4	2-4	2-4	2-4	2-4	2-4	2-4	dB	-
D17	3-4	3-4	3-4	3-4	3-4	3-4	3-4	3-4	3-4	3-4	3-4	3-4	3-4	3-4	3-4	3-4	1d	-
D18	4-4	4-4	4-4	4-4	4-4	4-4	4-4	4-4	4-4	4-4	4-4	4-4	4-4	4-4	4-4	4-4	1e	-
D19	5-4	5-4	5-4	5-4	5-4	5-4	5-4	5-4	5-4	5-4	5-4	5-4	5-4	5-4	5-4	5-4	1c	-
D20	1-5	1-5	1-5	1-5	1-5	1-5	1-5	1-5	1-5	1-5	1-5	1-5	1-5	1-5	1-5	1-5	1g	-
D21	2-5	2-5	2-5	2-5	2-5	2-5	2-5	2-5	2-5	2-5	2-5	2-5	2-5	2-5	2-5	2-5	1f	-
D22	3-5	3-5	3-5	3-5	3-5	3-5	3-5	3-5	3-5	3-5	3-5	3-5	3-5	3-5	3-5	3-5	1b	-
D23	4-5	4-5	4-5	4-5	4-5	4-5	4-5	4-5	4-5	4-5	4-5	4-5	4-5	4-5	4-5	4-5	1a	AUTO
D24	5-5	5-5	5-5	5-5	5-5	5-5	5-5	5-5	5-5	5-5	5-5	5-5	5-5	5-5	5-5	5-5	S1	HDMI
D25	1-6	1-6	1-6	1-6	1-6	1-6	1-6	1-6	1-6	1-6	1-6	1-6	1-6	1-6	1-6	1-6	S2	DUAL
D26	2-6	2-6	2-6	2-6	2-6	2-6	2-6	2-6	2-6	2-6	2-6	2-6	2-6	2-6	2-6	2-6	S3	ANAL
D27	3-6	3-6	3-6	3-6	3-6	3-6	3-6	3-6	3-6	3-6	3-6	3-6	3-6	3-6	3-6	3-6	S4	S.BACK
D28	4-6	4-6	4-6	4-6	4-6	4-6	4-6	4-6	4-6	4-6	4-6	4-6	4-6	4-6	4-6	4-6	S5	DC
D29	5-6	5-6	5-6	5-6	5-6	5-6	5-6	5-6	5-6	5-6	5-6	5-6	5-6	5-6	5-6	5-6	S6	dB
D30	1-7	1-7	1-7	1-7	1-7	1-7	1-7	1-7	1-7	1-7	1-7	1-7	1-7	1-7	1-7	1-7	S7	AUDYBSSY
D31	2-7	2-7	2-7	2-7	2-7	2-7	2-7	2-7	2-7	2-7	2-7	2-7	2-7	2-7	2-7	2-7	S8	TUNED
D32	3-7	3-7	3-7	3-7	3-7	3-7	3-7	3-7	3-7	3-7	3-7	3-7	3-7	3-7	3-7	3-7	MUTE	STEREO
D33	4-7	4-7	4-7	4-7	4-7	4-7	4-7	4-7	4-7	4-7	4-7	4-7	4-7	4-7	4-7	4-7	PCM	RDS
D34	5-7	5-7	5-7	5-7	5-7	5-7	5-7	5-7	5-7	5-7	5-7	5-7	5-7	5-7	5-7	5-7	Z2	SLEEP
AD1	-	-	-	-	-	-	-	-	-	-	-	-	-	-	-	-	DIG	-
AD2	-	-	-	-	-	-	-	-	-	-	-	-	-	-	-	-	ANA	-

MAIN PCB ASS'Y

※Parts indicated by "nsp" on this table cannot be supplied.

※The parts listed below are only for maintenance. Therefore they might differ from the parts used in the unit in appearances or dimensions.

NOTE:The symbols in the column Remarks indicate the following destinations.

E3 : U.S.A. & Canada model E2 : Europe model E1C : China model E1 : Asia model K : Japan model

BK : Black model SP : Silver gold model

REF No.	Part No.	Part Name	Remarks	Q'ty	New	Ver
<b>SEMICONDUCTORS GROUP</b>						
D4000-4004	963201500170D	LBAS16HT1G FAST SWITCHING SOD-323	K005041480230S	5		
D4007	00D2760401905	1SS133-DO34-AXIAL LRC	K000013300040S	1		
D4008	963203500300D	DIODE BRIDGE D10SB60 600V/10A STRAIGHT TYPE	K047100600220S	1		
D4013	963201500170D	LBAS16HT1G FAST SWITCHING SOD-323	K005041480230S	1		
D4014	963201500160D	1N4007 52REEL 1000V 1A	K000400700220S	1		
D4016	00D2760401905	1SS133-DO34-AXIAL LRC	K000013300040S	1		
D4017	963201500160D	1N4007 52REEL 1000V 1A	K000400700220S	1		
D4019	00D2760401905	1SS133-DO34-AXIAL LRC	K000013300040S	1		
D4020	963201500160D	1N4007 52REEL 1000V 1A	K000400700220S	1		
D4022	963201500160D	1N4007 52REEL 1000V 1A	K000400700220S	1		
D4023	963201500170D	LBAS16HT1G FAST SWITCHING SOD-323	K005041480230S	1		
D4025	963201500160D	1N4007 52REEL 1000V 1A	K000400700220S	1		
D4026	963201500170D	LBAS16HT1G FAST SWITCHING SOD-323	K005041480230S	1		
D4027-4030	963201500160D	1N4007 52REEL 1000V 1A	K000400700220S	4		
D4031-4032	00D2760401905	1SS133-DO34-AXIAL LRC	K000013300040S	2		
D4033-4036	963201500160D	1N4007 52REEL 1000V 1A	K000400700220S	4		
D4037	00D2760401905	1SS133-DO34-AXIAL LRC	K000013300040S	1		
D4038	963201500160D	1N4007 52REEL 1000V 1A	K000400700220S	1		
D4039-4044	963201500170D	LBAS16HT1G FAST SWITCHING SOD-323	K005041480230S	6		
IC4000	00D2631100005	KIA7805API,20W-TO220IS MOLD	J126780500110S	1		
IC4001	00D2631099006	KIA7905PI,20W-TO220IS MOLD	J126790500070S	1		
IC4002	00D2631100050	KIA7808API,20W-TO220IS	J126780800050S	1		
IC4003	00D2631100005	KIA7805API,20W-TO220IS MOLD	J126780500110S	1		
IC4004	00D2631251006	KIA7908PI,20W-TO220IS	J126790800060S	1		
IC4005	963232100400S	UTC4580E SOP8 DUAL OP AMP	J121458001010S	1		
IC4701	236810090504S	ILX3232D 3V3 RS232 INTERFACE TRANSCEIVER SOP16	J046329020020S	1		
Q4005-4010	963214500310S	RT1N237C 0.2W/SC-59 ISAHAYA	J522102371210S	6	*	
ZD4002	963202500330D	ZJ6.8B-0.5W/5MA-52MM SEMTECH	K06006R844522S	1		
ZD4157,4158	963202500290D	ZJ3.6B-0.5W/5MA-52MM SEMTECH	K06003R644522S	2		
<b>RESISTOR GROUP</b>						
R4000,4001	963125010110S	470-J,2W-R.REEL	C060047166060S	2		
R4002	nsp	10-J,1/5W-52RE-AX	C00001006P520S	1		
R4003	963125010100S	10-J 2W, R-REEL	C060010066050S	1		
R4004	nsp	10-J,1/5W-52RE-AX	C00001006P520S	1		
R4005	963125010100S	10-J 2W, R-REEL	C060010066050S	1		
R4006	nsp	10-J,1/5W-52RE-AX	C00001006P520S	1		
R4007	963125010100S	10-J 2W, R-REEL	C060010066050S	1		
R4008	nsp	10-J,1/5W-52RE-AX	C00001006P520S	1		
R4009	963125010100S	10-J 2W, R-REEL	C060010066050S	1		
R4010	nsp	10-J,1/5W-52RE-AX	C00001006P520S	1		
R4011	963125010100S	10-J 2W, R-REEL	C060010066050S	1		
R4012	nsp	10-J,1/5W-52RE-AX	C00001006P520S	1		
R4013	963125010100S	10-J 2W, R-REEL	C060010066050S	1		
R4014	nsp	10-J,1/5W-52RE-AX	C00001006P520S	1		
R4015	963125010100S	10-J 2W, R-REEL	C060010066050S	1		
R4016	nsp	100-J,1/5W-52RE-AX	C00001018P520S	1		
R4017-4020	nsp	20-J,1/5W-52RE-AX	C00002006P520S	4		
R4025-4027	963125500070D	1.1K-J,1W-R.REEL	C060011265050S	3		
R4029	nsp	10K-J,1/4W-R.REEL	C060103063050S	1		
R4032	nsp	JUMPER (0.6/52MM)	L045084006040S	1		
R4036-4038	nsp	470K-J,1/16W-1608REEL	C20004746M160S	3		
R4039,4040	nsp	82K-J,1/16W-1608REEL	C20008236M160S	2		
R4041	nsp	100-J,1/16W-1608REEL	C20001016M160S	1		
R4042	nsp	33-J,1/16W-1608REEL	C20003306M160S	1		
R4043	nsp	100-J,1/16W-1608REEL	C20001016M160S	1		
R4044,4045	nsp	470K-J,1/16W-1608REEL	C20004746M160S	2		
R4046	nsp	1K-J,1/16W-1608REEL	C20001026M160S	1		
R4047	nsp	100-J,1/16W-1608REEL	C20001016M160S	1		
R4048	nsp	33-J,1/16W-1608REEL	C20003306M160S	1		
R4049	nsp	10K-J,1/16W-1608REEL	C20001036M160S	1		
R4052	nsp	470K-J,1/16W-1608REEL	C20004746M160S	1		
R4054,4055	nsp	0-J,1/10W-2012REEL	C200000060200S	2		
R4056	nsp	470K-J,1/16W-1608REEL	C20004746M160S	1		
R4057	nsp	100-J,1/16W-1608REEL	C20001016M160S	1		
R4058	nsp	10K-J,1/16W-1608REEL	C20001036M160S	1		
R4059	nsp	22K-J,1/16W-1608REEL	C20002236M160S	1		
R4060	nsp	330K-J,1/16W-1608REEL	C2000336M160S	1		
R4061	nsp	22K-J,1/16W-1608REEL	C20002236M160S	1		
R4062	nsp	10K-J,1/16W-1608REEL	C20001036M160S	1		
R4063	nsp	3.3K-J,1/16W-1608REEL	C20003326M160S	1		
R4064	nsp	1K-J,1/16W-1608REEL	C20001026M160S	1		
R4065	nsp	33K-J,1/16W-1608REEL	C2000336M160S	1		
R4066,4067	nsp	10K-J,1/16W-1608REEL	C20001036M160S	2		
R4069	963129501010S	0.01-J/5W W14*H18 9MM PITCH	C144R01069000S	1	*	
R4070	nsp	20-J,1/5W-52RE-AX	C00002006P520S	1		
R4708,4709	nsp	1K-J,1/16W-1608REEL	C20001026M160S	2		
R4710	nsp	0-J,1/16W-1608REEL	C20000006M160S	1		
R4711	nsp	1K-J,1/16W-1608REEL	C20001026M160S	1		
R4714	nsp	1K-J,1/16W-1608REEL	C20001026M160S	1		
<b>CAPACITORS GROUP</b>						
C4000	nsp	MI-0.047UF-J/50V-5RE	D020473167050S	1		
C4002	963133501560S	ST-0.022UF-J/100V-5RE MANUAL	D02122306C050S	1		
C4005	963133501560S	ST-0.022UF-J/100V-5RE MANUAL	D02122306C050S	1		
C4006	nsp	MI-0.047UF-J/50V-5RE	D020473167050S	1		
C4009	963133501560S	ST-0.022UF-J/100V-5RE MANUAL	D02122306C050S	1		
C4011	nsp	MI-0.047UF-J/50V-5RE	D020473167050S	1		
C4013	963133501560S	ST-0.022UF-J/100V-5RE MANUAL	D02122306C050S	1		
C4015	963133501560S	ST-0.022UF-J/100V-5RE MANUAL	D02122306C050S	1		
C4017	nsp	MI-0.047UF-J/50V-5RE	D020473167050S	1		
C4019	963133501560S	ST-0.022UF-J/100V-5RE MANUAL	D02122306C050S	1		
C4022	963133501560S	ST-0.022UF-J/100V-5RE MANUAL	D02122306C050S	1		
C4023	nsp	MI-0.047UF-J/50V-5RE	D020473167050S	1		
C4025	nsp	MI-0.047UF-J/50V-5RE	D020473167050S	1		
C4027	nsp	X7R)1000PF-K/50V-1608REEL	D011102777160S	1		

REF No.	Part No.	Part Name	Remarks	Q'ty	New	Ver
C4027	nsp	C.CERAMIC CHIP HIK // X7R)0.1UF-K/50V-1608REEL	E2/E1	D011104577160S	1	
C4030	nsp	MI-0.047UF-J/50V-5RE		D020473167050S	1	
C4032	nsp	X7R)1000PF-K/50V-1608REEL	E3/E1C/K	D011102777160S	1	
C4032	nsp	C.CERAMIC CHIP HIK // X7R)0.1UF-K/50V-1608REEL	E2/E1	D011104577160S	1	
C4035	nsp	X7R)1000PF-K/50V-1608REEL	E3/E1C/K	D011102777160S	1	
C4035	nsp	C.CERAMIC CHIP HIK // X7R)0.1UF-K/50V-1608REEL	E2/E1	D011104577160S	1	
C4038	nsp	X7R)1000PF-K/50V-1608REEL	E3/E1C/K	D011102777160S	1	
C4038	nsp	C.CERAMIC CHIP HIK // X7R)0.1UF-K/50V-1608REEL	E2/E1	D011104577160S	1	
C4041	nsp	X7R)1000PF-K/50V-1608REEL	E3/E1C/K	D011102777160S	1	
C4041	nsp	C.CERAMIC CHIP HIK // X7R)0.1UF-K/50V-1608REEL	E2/E1	D011104577160S	1	
C4044	nsp	X7R)1000PF-K/50V-1608REEL	E3/E1C/K	D011102777160S	1	
C4044	nsp	C.CERAMIC CHIP HIK // X7R)0.1UF-K/50V-1608REEL	E2/E1	D011104577160S	1	
C4047	nsp	X7R)1000PF-K/50V-1608REEL	E3/E1C/K	D011102777160S	1	
C4047	nsp	C.CERAMIC CHIP HIK // X7R)0.1UF-K/50V-1608REEL	E2/E1	D011104577160S	1	
C4049	00D2544574922	100UF-M/50V,8*11.5-5RE.SMS SY		D040101087060S	1	
C4050,4051	963133501570S	ST-0.1UF-J/100V-5RE MANUAL		D02110406C050S	2	
C4052	963133502010S	10000UF-M/69V,35*45 DL LKSF2103MESBZT NICHICON	E3/E1C/K	D04010308Z560S	1	*
C4052	963134010180S	C.ELECT GE 85C // 12000UF-M/71V,35*60	E2/E1	D040123089550S	1	
C4053	00D2544573981	10UF-M/50V,5*11-5RE.SMS SY		D040100087070S	1	
C4054	963133502010S	10000UF-M/69V,35*45 DL LKSF2103MESBZT NICHICON	E3/E1C/K	D04010308Z560S	1	*
C4054	963134010180S	C.ELECT GE 85C // 12000UF-M/71V,35*60	E2/E1	D040123089550S	1	
C4057	963134502400S	MI-0.1UF-J/50V-5RE		D020104167050S	1	
C4059	963134011290S	4700UF-M/16V,16*25-L.BLK SMS 5.0MC SY		D040472083020S	1	
C4060,4061	00D2544573981	10UF-M/50V,5*11-5RE.SMS SY		D040100087070S	2	
C4062	00D9630217002	3300UF-M/16V,12.5*25L.BLK SHL 5.0MC SY		D040322083010S	1	
C4063	00D2544573981	10UF-M/50V,5*11-5RE.SMS SY		D040100087070S	1	
C4064	963134502380S	470UF-M/50V,12.5*20L BULK 5.0MC SMS SY		D040471087010S	1	
C4065	90M-OA000500R	4700UF-M/25V(MHA),16*25 P=7.5 L.BLK		D040472084240S	1	
C4066	963134502390S	470UF-M/50V,10*20 BULK SHL SY		D040471087040S	1	
C4067	90M-OA000500R	4700UF-M/25V(MHA),16*25 P=7.5 L.BLK		D040472084240S	1	
C4068	963134502390S	470UF-M/50V,10*20 BULK SHL SY		D040471087040S	1	
C4069	nsp	X7R)0.1UF-K/50V-1608REEL		D011104577160S	1	
C4071	00D2544573981	10UF-M/50V,5*11-5RE.SMS SY		D040100087070S	1	
C4074	nsp	COG10PF-J/50V-1608REEL		D010100167161S	1	
C4075	00D9630333203	100UF-M/16V,5*11-5RE.SHL SY		D040101083090S	1	
C4080,4081	nsp	COG100PF-J/50V-1608REEL		D010101167160S	2	
C4082	nsp	X7R)0.1UF-K/50V-1608REEL		D011104577160S	1	
C4083	nsp	COG100PF-J/50V-1608REEL		D010101167160S	1	
C4085,4086	nsp	X7R)0.1UF-K/50V-1608REEL		D011104577160S	2	
C4087-4089	00D9609010625	1UF-M/100V,5*11-5RE.SMS SY		D040010086060S	3	
C4706	nsp	X7R)0.1UF-K/50V-1608REEL		D011104577160S	1	
C4707	00D2544573981	10UF-M/50V,5*11-5RE.SMS SY		D040100087070S	1	
C4711,4712	nsp	X7R)0.1UF-K/50V-1608REEL		D011104577160S	2	
C4716,4717	nsp	X7R)0.1UF-K/50V-1608REEL		D011104577160S	2	
C4718,4719	nsp	COG)33PF-J/50V-1608REEL		D010330167160S	2	
<b>OTHER PARTS GROUP</b>						
BD4000	nsp	CB03YTYN121-1608REEL		D340160891210S	1	
BKT4143	nsp	AVR1611BKE3 SECC t1.0+Sn plating /PCB MTG		4010214876000S	1	
CLP4001	nsp	HMX9800(ON)(HAITAI) (W=2.6,L=50)WIRE(SOLDER)		4330000120000S	1	
CN4211	nsp	260MM/3P 5264-03=CKM2509HV-03 RD1569#20 105C		L000261030110S	1	
CN4212	nsp	120MM/10P 20010HS-10=CKM2002HV-10 WH1007#26		L002121102620S	1	
CN4213	nsp	220MM/5P 5264-05=CKM2509HV-05 RD1569#20 105C		L000221050070S	1	
CN4702	nsp	C125Z2-07 7P BtoB SOCKET(FEMALE) P=1.25MM		L109012520740S	1	
CP4001	nsp	LWB1143-07P 7.92MM HEADER,VER,7CKT		L108011430710S	1	
CP4002	nsp	C125Z1-15 15P BtoB HEADER(MALE) P=1.25MM		L109012511540S	1	
CP4003	nsp	C125Z1-21 21P BtoB HEADER(MALE) P=1.25MM		L109012512140S	1	
CP4006	nsp	C125Z1-11 11P BtoB HEADER(MALE) P=1.25MM		L109012511140S	1	
CP4007	nsp	C125Z1-09 9P BtoB HEADER(MALE) P=1.25MM		L109012510940S	1	
CP4700	nsp	C125Z1-07 7P BtoB HEADER(MALE) P=1.25MM		L109012510740S	1	
CP4702	nsp	C125Z1-07 7P BtoB HEADER(MALE) P=1.25MM		L109012510740S	1	
! F4000	963652010520S	T6.3A/250V-IVBSUCPCcUR S506		N751506301160S	1	
F4000A	nsp	PI5.2-REEL		G645000050010S	1	
F4000B	nsp	PI5.2-REEL		G645000050010S	1	
! F4001	963652010520S	T6.3A/250V-IVBSUCPCcUR S506		N751506301160S	1	
F4001A	nsp	PI5.2-REEL		G645000050010S	1	
F4001B	nsp	PI5.2-REEL		G645000050010S	1	
JACK4000-4006	963646100520S	SJ2003S-A006-00A200B(RD,BK) BINDING	E3	G6112003SA00JS	7	
JACK4000-4006	963643102840S	TER,BOARD SCREW 2P // JB207-F02R3BY-A(RD,BK)	E2/E1/E1C	G611207F02RAYS	7	*
JACK4702	00D2051305008	9P FEMALE D-SUB DS03-09 ADD SCREW(4.8*11.8)BLACK		L10309009030S	1	
L4000-4006	nsp	SP-2507 1.0 PI*2UEW TURNS=7T SPRING COIL		D330900001330S	7	
PACK4000	963189100860D	KST-MW004MV1-S63SV-1 4GANG+MW+50US NA	E3	E903004103630S	1	*
PACK4000	963189100870D	TUNER_FM/AM // KST-MW104MV1-S63G FM/AM/RDS EU	E2/E1	E903104102630S	1	*
PACK4000	963189100850D	TUNER_FM/AM // KST-MW004MV1-S63-1 FM/AM NA	E1C/K	E903004101630S	1	*
RLY4000	00D9630218409	BC3-12 24V 2A 2회로 2점접(SMALL SIGNAL)		G680240202030S	1	
RLY4001-4004	963682100280D	JZC-42F/012-2HST 24.4*12.8*24.8mm		G680060103010S	4	
RLY4005	963682100510S	HF115F/012-2ZS4B		G680060083010S	1	*

FRONT PCB ASS'Y

※Parts indicated by "nsp" on this table cannot be supplied.

※The parts listed below are only for maintenance. Therefore they might differ from the parts used in the unit in appearances or dimensions.

NOTE: The symbols in the column Remarks indicate the following destinations.

E3 : U.S.A. & Canada model E2 : Europe model E1C : China model E1 : Asia model K : Japan model

BK : Black model SP : Silver gold model

REF No.	Part No.	Part Name	Remarks	Q'ty	New	Ver
<b>SEMICONDUCTORS GROUP</b>						
D4401,4402	963201500160D	1N4007 52REEL 1000V 1A				
D4403-4406	963201500170D	LBAS16HT1G FAST SWITCHING SOD-323				
D4408	963201500170D	LBAS16HT1G FAST SWITCHING SOD-323				
D4410	963201500170D	LBAS16HT1G FAST SWITCHING SOD-323				
D4411,4412	963209003510S	CDS3C05HDMI1 CERADIODE ESD FOR HDMI 1608REEL				
D4413	963209500020S	CDS3C15GTA 1608REEL CERADIODE ESD B72500D0150A060				
D4414	963209003510S	CDS3C05HDMI1 CERADIODE ESD FOR HDMI 1608REEL				
D4415	963209500020S	CDS3C15GTA 1608REEL CERADIODE ESD B72500D0150A060				
D4416	963209003510S	CDS3C05HDMI1 CERADIODE ESD FOR HDMI 1608REEL				
IC4400	963232100390S	NJM8080G SOP8 DUAL OP AMP				
Q4400	943216500050S	RT1N441C 0.2W/SC-59 ISAHAYA				
Q4401	943215500030S	RT1P441C 0.2W/SC-59 ISAHAYA				
Q4402,4403	943214500020S	2SC3052 0.15W/SC-59 REEL ISAHAYA				
Q4404	00D963022670S	KTC1027Y,1W/TO92L-REEL				
Q4405	943216500020S	RT1N141C 0.2W/SC-59 ISAHAYA				
Q4406	963212500030S	ISA1530AC1 0.2W/SC-59 ISAHAYA				
Q4407	943216500020S	RT1N141C 0.2W/SC-59 ISAHAYA				
Q4408	963212500030S	ISA1530AC1 0.2W/SC-59 ISAHAYA				
ZD4400	963202500330D	ZJ6.8B-0.5W/5MA-52MM SEMTECH				
ZD4401	963202500350D	ZJ22B-0.5W/5MA-52MM SEMTECH				
ZD4402	963202500340D	ZJ15B-0.5W/5MA-52MM SEMTECH				
ZD4403-4405	963202500310D	ZJ5.1B-0.5W/5MA-52MM SEMTECH				
<b>RESISTOR GROUP</b>						
R4402	nsp	0-J,1/16W-1608REEL				
R4403,4404	nsp	100-J,1/16W-1608REEL				
R4405	nsp	1-J,1/16W-1608REEL				
R4408	nsp	1-J,1/16W-1608REEL				
R4409	nsp	1K-J,1/16W-1608REEL				
R4410	nsp	10K-J,1/16W-1608REEL				
R4411	nsp	100-J,1/16W-1608REEL				
R4412	nsp	47K-J,1/16W-1608REEL				
R4413	nsp	0-J,1/16W-1608REEL	X2100			
R4413	nsp	100-J,1/16W-1608REEL	S900			
R4414	nsp	10-J,1/5W-52RE-AX				
R4415	nsp	100-J,1/16W-1608REEL				
R4416	nsp	100K-J,1/16W-1608REEL				
R4417	nsp	100-J,1/16W-1608REEL	X2100			
R4417	nsp	150-J,1/16W-1608REEL	S900			
R4418,4419	nsp	390-J,1/16W-1608REEL	X2100E3			
R4420	nsp	39K-J,1/5W-52RE-AX				
R4421	nsp	47K-J,1/16W-1608REEL	X2100E3			
R4422	nsp	100-J,1/5W-52RE-AX				
R4423	nsp	100K-J,1/16W-1608REEL				
R4424	nsp	0-J,1/16W-1608REEL	X2100			
R4424	nsp	100-J,1/16W-1608REEL	S900			
R4425	nsp	39K-J,1/16W-1608REEL				
R4426	00D9639006272	RSD-R1-1WJ-4.7 3*9 P=5MM SMALL R.REEL				
R4427	nsp	0-J,1/16W-1608REEL	X2100			
R4427	nsp	150-J,1/16W-1608REEL	S900			
R4428,4429	nsp	4.7K-J,1/16W-1608REEL				
R4430	nsp	100-J,1/16W-1608REEL	X2100			
R4430	nsp	180-J,1/16W-1608REEL	S900			
R4433	nsp	10K-J,1/16W-1608REEL				
R4434	nsp	0-J,1/16W-1608REEL	X2100			
R4434	nsp	100-J,1/16W-1608REEL	S900			
R4435	nsp	4.7K-J,1/16W-1608REEL				
R4436	nsp	68K-J,1/16W-1608REEL				
R4437	nsp	91K-J,1/16W-1608REEL				
R4438,4439	nsp	10-J,1/16W-1608REEL				
R4440	nsp	0-J,1/16W-1608REEL	E2/E1/E1C/K/S900			
R4441	nsp	0-J,1/16W-1608REEL	X2100E3			
R4442-4444	nsp	100-J,1/5W-52RE-AX				
R4445	nsp	10K-J,1/16W-1608REEL				
R4446	nsp	4.7K-J,1/16W-1608REEL				
R4447	nsp	100-J,1/16W-1608REEL	X2100			
R4447	nsp	150-J,1/16W-1608REEL	S900			
R4448	nsp	100K-J,1/16W-1608REEL				
R4450	nsp	47K-J,1/16W-1608REEL				
R4451	nsp	1K-J,1/16W-1608REEL				
R4452	nsp	100-J,1/16W-1608REEL				
R4453	nsp	18K-J,1/16W-1608REEL				
R4454	nsp	820-J,1/16W-1608REEL				
R4455	nsp	100-J,1/16W-1608REEL				
R4456	nsp	3.3K-J,1/16W-1608REEL				
R4457-4459	nsp	100-J,1/5W-52RE-AX				
R4460	nsp	2.2K-J,1/16W-1608REEL				
R4461	nsp	100-J,1/5W-52RE-AX				
R4462,4463	nsp	1.2K-J,1/16W-1608REEL	X2100E3			
R4462,4463	nsp	R.CHIP THICK // 560-J,1/16W-1608REEL	E2/E1/E1C/K/S900			
R4464	nsp	4.7K-J,1/5W-52RE-AX				
R4466	nsp	2.2K-J,1/16W-1608REEL				
R4467	nsp	100-J,1/16W-1608REEL				
R4469	nsp	100K-J,1/16W-1608REEL				
R4471,4472	nsp	4.7K-J,1/5W-52RE-AX				
R4473	nsp	100K-J,1/16W-1608REEL				
R4474	nsp	150-J,1/16W-1608REEL	X2100			
R4474	nsp	180-J,1/16W-1608REEL	S900			
R4478	nsp	100-J,1/16W-1608REEL				
R4479	nsp	4.7K-J,1/5W-52RE-AX				
R4481	nsp	220-J,1/16W-1608REEL	S900			
R4483	nsp	R.CHIP THICK // 330-J,1/16W-1608REEL	S900			
R4484	nsp	150-J,1/16W-1608REEL	X2100			
R4484	nsp	220-J,1/16W-1608REEL	S900			
R4485	nsp	R.CHIP THICK // 330-J,1/16W-1608REEL	S900			

REF No.	Part No.	Part Name	Remarks	Q'ty	New	Ver
R4486	nsp	2.2K-J,1/16W-1608REEL		C20002226M160S	1	
R4489,4490	nsp	100-J,1/5W-52RE-AX		C00001016P520S	2	
R4492	nsp	R,CHIP THICK // 560-J,1/16W-1608REEL	S900	C20005616M160S	1	
R4493	nsp	150-J,1/16W-1608REEL	X2100	C20001516M160S	1	
R4493	nsp	180-J,1/16W-1608REEL	S900	C20001816M160S	1	
R4494	nsp	180-J,1/16W-1608REEL	X2100	C20001816M160S	1	
R4494	nsp	220-J,1/16W-1608REEL	S900	C20002216M160S	1	
R4495	nsp	R,CHIP THICK // 330-J,1/16W-1608REEL	S900	C20003316M160S	1	
R4497	nsp	2.2K-J,1/16W-1608REEL		C20002226M160S	1	
<b>CAPACITORS GROUP</b>						
C4408	nsp	X7R)0.1UF-K/50V-1608REEL		D011104577160S	1	
C4409	00D2544573981	10UF-M/50V,5*11-5RE.SMS SY		D040100087070S	1	
C4411	nsp	X7R)0.1UF-K/50V-1608REEL		D011104577160S	1	
C4412	00D2544573981	10UF-M/50V,5*11-5RE.SMS SY		D040100087070S	1	
C4413	nsp	X7R)0.047UF-K/25V-1608REEL		D011473774161S	1	
C4414	nsp	X7R)0.01UF-K/50V-1608REEL		D011103777160S	1	
C4415,4416	nsp	ST-0.1UF-J/100V-5RE PEFAM104J100 PEF TYPE		D02010406C060S	2	
C4417	963134502370S	47UF-M/16V,5*11-5RE.SMS SY		D040470083080S	1	
C4418	nsp	X7R)0.047UF-K/25V-1608REEL		D011473774161S	1	
C4419,4420	nsp	ST-0.1UF-J/100V-5RE PEFAM104J100 PEF TYPE		D02010406C060S	2	
C4421	00D9630157900	470UF-M/63V,12.5*20 BULK- SHL SY		D040471088010S	1	
C4422	00D9630293602	1UF-M/50V,5*11-5RE.SMS SY (Pb Free)		D040010087150S	1	
C4423	00D2544574922	100UF-M/50V,8*11.5-5RE.SMS SY		D040101087060S	1	
C4424	nsp	X7R)0.047UF-K/25V-1608REEL		D011473774161S	1	
C4425	nsp	COG100PF-J/50V-1608REEL		D010101167160S	1	
C4426	nsp	Y5V1UF-Z/50V-1608REEL		D011105597160S	1	
C4427,4428	nsp	COG100PF-J/50V-1608REEL		D010101167160S	2	
C4429,4430	nsp	X7R)0.1UF-K/50V-1608REEL		D011104577160S	2	
C4431,4432	nsp	ST-0.1UF-J/100V-5RE PEFAM104J100 PEF TYPE		D02010406C060S	2	
C4433,4434	00D9630293602	1UF-M/50V,5*11-5RE.SMS SY (Pb Free)		D040010087150S	2	
C4436	nsp	X7R)0.047UF-K/25V-1608REEL		D011473774161S	1	
C4437	nsp	COG82PF-J/50V-1608REEL		D010820167160S	1	
C4438	00D9630293709	100UF-M/10V,5*11-5RE.SMS SY		D040101082070S	1	
C4439	00D2544573981	10UF-M/50V,5*11-5RE.SMS SY		D040100087070S	1	
C4440	nsp	X7R)0.047UF-K/25V-1608REEL		D011473774161S	1	
C4441,4442	nsp	COG470PF-J/50V-1608REEL		D010471167160S	2	
C4443	nsp	X7R)0.1UF-K/50V-1608REEL		D011104577160S	1	
C4444	nsp	COG100PF-J/50V-1608REEL		D010101167160S	1	
C4445	nsp	COG470PF-J/50V-1608REEL		D010471167160S	1	
C4447	00D9630293602	1UF-M/50V,5*11-5RE.SMS SY (Pb Free)		D040010087150S	1	
C4448	nsp	X7R)0.1UF-K/50V-1608REEL		D011104577160S	1	
C4450	nsp	COG470PF-J/50V-1608REEL		D010471167160S	1	
C4453	nsp	COG100PF-J/50V-1608REEL		D010101167160S	1	
C4455,4456	nsp	X7R)1000PF-K/50V-1608REEL		D011102777160S	2	
C4459,4460	nsp	ST-0.01UF-J/100V-5RE PEFAM103J100 PEF TYPE		D02010306C060S	2	
C4462	nsp	ST-0.1UF-J/100V-5RE PEFAM104J100 PEF TYPE		D02010406C060S	1	
C4463	nsp	ST-0.047UF-J/100V-5RE		D02047306C060S	1	
C4470	nsp	X7R)0.1UF-K/50V-1608REEL		D011104577160S	1	
C4471	nsp	220UF-M/6.3V,8*5-5RE SRE SY		D040221081070S	1	
C4472	nsp	COG 0.001UF-J/50V-1608REEL		D010102167160S	1	
C4475-4478	nsp	X7R)0.01UF-K/50V-1608REEL		D011103777160S	4	
C4479	nsp	X7R)0.1UF-K/50V-1608REEL		D011104577160S	1	
C4480	nsp	COG 0.001UF-J/50V-1608REEL		D010102167160S	1	
C4481	nsp	220UF-M/6.3V,8*5-5RE SRE SY		D040221081070S	1	
C4482	nsp	X7R)0.1UF-K/50V-1608REEL		D011104577160S	1	
<b>OTHER PARTS GROUP</b>						
★	nsp	AVR2313CIBKE3(DENON) FLT		4018214916000	2	
★	nsp	SR5005U1BSPH 0.5T/FIP		4010214916000S	1	
★	nsp	AVR1913BKE3(DENON) TESA4970 25*10 A4/BRACKET FLT		1220211409000S	1	
BD4401-4403	nsp	0-J,1/16W-1608REEL		C20000006M160S	3	
BD4407	nsp	0-J,1/16W-1608REEL		C20000006M160S	1	
BD4409,4410	nsp	0-J,1/16W-1608REEL		C20000006M160S	2	
BD4411	nsp	CB05YTYH221-2012REEL		D340201292210S	1	
BD4413	nsp	CB05YTYH221-2012REEL		D340201292210S	1	
BKT4400	nsp	AVR133(HARMAN) BARRING HOLE SPT 0.8V/SCREW		4010210196100S	1	
CB4400,4401	nsp	0-J,1/16W-1608REEL		C20000006M160S	2	
CLAMP401	nsp	HMX9800(ON)(HAITAI) (W=2.6,L=50)WIRE(SOLDER)		4330000120000S	1	
CLAMP403	nsp	HMX9800(ON)(HAITAI) (W=2.6,L=50)WIRE(SOLDER)		4330000120000S	1	
CLAMP405,406	nsp	HMX9800(ON)(HAITAI) (W=2.6,L=50)WIRE(SOLDER)		4330000120000S	2	
CN4400	nsp	1.0-11S-40PW 40P AN DIP TOP CONTACT		L130100114050S	1	
CN4402,4403	nsp	330MM/5P CKM2002HV-05=20010HS-05 RD2725#24/28 SHLD		L002331050210S	2	
CP4400	nsp	YMAW025-07R DIP RA		L102025070010S	1	
CP4401	nsp	TUC-P07X-B1 BD-TO-BD 7P HOUSING ST (35237-07)		L101100030710S	1	
CP4402,4403	nsp	TUC-P07P-B1 BD-TO-BD 7P WAFER ST (35336-07)		L101100040710S	2	
CP4405	nsp	TUC-P07X-B1 BD-TO-BD 7P HOUSING ST (35237-07)		L101100030710S	1	
CP4406,4407	963643101610D	USB A F 180 DIP L=15.0		G480040000180S	2	
!	F4401	963652500020S	6125FF500-R 500mA FAST-ACTING SUBMINIATURE FUSE	G657612505030S	1	
	FL4400	943172100150S	018BT021GINK 129*25*6.1 GREEN /AVR1913	K530180210010S	1	
	G4400	nsp	160MM/1P 609A-BS-2=CKM9919T BK1617#22	8410161010190S	1	
	J4458	nsp	0-J,1/8W-3216REEL	C200000061300S	1	
	J4474	nsp	0-J,1/8W-3216REEL	C200000061300S	1	
	JACK4400	00D9630367802	EARPHONE JACK(PJ-354H-4)(MIC) BLACK	G401PJ354H40YS	1	
	JACK4401	963643101600D	PHONE (YUQIU) D6.5 9P NI PJ-621HA	G402PJ621HA0YS	1	
	JP4401,4402	nsp	0-J,1/8W-3216REEL	C200000061300S	2	
	LED4400	963262100300D	BIR-BM1341T 3PI INFRARED LED	K505134101040S	1	*
	LED4402	963263100960S	PVBWR-5A2M-CREDISEA 5PI WHITE/RED	K500059209010S	1	*
	LED4402	00D9630366108	LED,ROUND // BL-BJEGJ204-L 5PI RED/GREEN 5MM-REEL	E2/E1K/S900 K500052004010S	1	
	LED4402	963263100620D	LED,ROUND // BL-BUBGJ201G-L 3PI RED/GREEN	E1C K500032501150S	1	
	RMC4400	963262010290S	R34FS9A 38KHZ IR REMOCOON MODULE P=2.54MM H=15MM	E940349003810S	1	
	SW4400	00D9630095305	SW,TACT // SKHV10910D01 KB581/LG 160G	G180040500010S	1	
	SW4401,4402	00D9630095305	SKHV10910D01 KB581/LG 160G	G180040500010S	2	
	SW4403,4404	00D9630095305	SW,TACT // SKHV10910D01 KB581/LG 160G	G180040500010S	2	
	SW4405,4406	00D9630095305	SKHV10910D01 KB581/LG 160G	G180040500010S	2	
	SW4407	00D9630095305	SW,TACT // SKHV10910D01 KB581/LG 160G	G180040500010S	1	
	SW4408,4409	00D9630095305	SKHV10910D01 KB581/LG 160G	G180040500010S	2	
	SW4410	00D9630387408	EC16B24SO-ZZZ L=25MM CLICK=24 TORQUE=100-300	G121162400070S	1	
	SW4411	00D9630095305	SKHV10910D01 KB581/LG 160G	G180040500010S	1	
	SW4412	963667100170D	EC16B12SAAD4ZZZ	G121161200070S	1	*
	SW4413	00D9630095305	SKHV10910D01 KB581/LG 160G	G180040500010S	1	
	SW4414,4415	00D9630095305	SW,TACT // SKHV10910D01 KB581/LG 160G	G180040500010S	2	
	SW4416	00D9630095305	SKHV10910D01 KB581/LG 160G	G180040500010S	1	
	SW4417,4418	00D9630095305	SW,TACT // SKHV10910D01 KB581/LG 160G	G180040500010S	2	

REF No.	Part No.	Part Name	Remarks		Q'ty	New	Ver
SW4419,4420	00D9630095305	SKHV10910D01 KB581/LG 160G		G180040500010S	2		
SW4421	00D9630095305	SW,TACT // SKHV10910D01 KB581/LG 160G	S900	G180040500010S	1		



## VIDEO PCB ASS'Y

※Parts indicated by "nsp" on this table cannot be supplied.

※The parts listed below are only for maintenance. Therefore they might differ from the parts used in the unit in appearances or dimensions.

NOTE: The symbols in the column Remarks indicate the following destinations.

E3 : U.S.A. &amp; Canada model E2 : Europe model E1C : China model E1 : Asia model K : Japan model

BK : Black model SP : Silver gold model

REF No.	Part No.	Part Name	Remarks	Q'ty	New	Ver
<b>SEMICONDUCTORS GROUP</b>						
D4210-4212	00D2760401905	1SS133-DO34-AXIAL LRC		K000013300040S	3	
IC5001	963235100700S	NJM2595M-TE1 DMP16 5-INPUT 3-OUTPUT VIDEO SWITCH		J171259500010S	1	*
IC5002	963235100630S	NJM2586AVC3 VIDEO SWITCH SSOP20-C3		J171258600020S	1	
Q4200,4201	943214500030S	INC2001AC1 0.2W/SC-59 ISAHAYA	X2100	J522020011210S	2	
Q4204	943215500020S	RT1P141C 0.2W/SC-59 ISAHAYA	X2100	J520101411210S	1	
Q4205	943216500020S	RT1N141C 0.2W/SC-59 ISAHAYA	X2100	J522101411210S	1	
Q4206	943215500020S	RT1P141C 0.2W/SC-59 ISAHAYA	X2100	J520101411210S	1	
Q4207	943215500020S	RT1P141C 0.2W/SC-59 ISAHAYA		J520101411210S	1	
Q4208	943216500020S	RT1N141C 0.2W/SC-59 ISAHAYA		J522101411210S	1	
Q4209	943215500020S	RT1P141C 0.2W/SC-59 ISAHAYA		J520101411210S	1	
Q4214	943214500030S	INC2001AC1 0.2W/SC-59 ISAHAYA		J522020011210S	1	
Q4218	943214500030S	INC2001AC1 0.2W/SC-59 ISAHAYA		J522020011210S	1	
Q4219	943216500020S	RT1N141C 0.2W/SC-59 ISAHAYA		J522101411210S	1	
ZD4200	963202500290D	ZJ3.6B-0.5W/5MA-52MM SEMTECH		K06003R644522S	1	
<b>RESISTOR GROUP</b>						
R4200,4201	nsp	220-J,1/16W-1608REEL	X2100	C20002216M160S	2	
R4202,4203	nsp	100K-J,1/16W-1608REEL	X2100	C20001046M160S	2	
R4204,4205	nsp	220-J,1/16W-1608REEL		C20002216M160S	2	
R4212,4213	nsp	100K-J,1/16W-1608REEL	X2100	C20001046M160S	2	
R4214-4217	nsp	100K-J,1/16W-1608REEL		C20001046M160S	4	
R4222	nsp	470-J,1/16W-1608REEL	X2100	C20004716M160S	1	
R4223,4224	nsp	10K-J,1/16W-1608REEL	X2100	C20001036M160S	2	
R4225	nsp	470-J,1/16W-1608REEL	X2100	C20004716M160S	1	
R4226	nsp	10K-J,1/16W-1608REEL		C20001036M160S	1	
R4227,4228	nsp	470-J,1/16W-1608REEL		C20004716M160S	2	
R4229	nsp	10K-J,1/16W-1608REEL		C20001036M160S	1	
R4230,4231	nsp	470-J,1/16W-1608REEL		C20004716M160S	2	
R4237	nsp	470K-J,1/16W-1608REEL		C20004746M160S	1	
R4238,4239	nsp	470-J,1/16W-1608REEL	X2100	C20004716M160S	2	
R4240	nsp	470K-J,1/16W-1608REEL	X2100	C20004746M160S	1	
R4241	nsp	1K-J,1/16W-1608REEL	X2100	C20001026M160S	1	
R4242,4243	nsp	470K-J,1/16W-1608REEL	X2100	C20004746M160S	2	
R4245	nsp	470K-J,1/16W-1608REEL		C20004746M160S	1	
R4258	nsp	10K-J,1/16W-1608REEL	X2100	C20001036M160S	1	
R4291	nsp	820-J,1/16W-1608REEL		C20008216M160S	1	
R4295,4296	nsp	10K-J,1/16W-1608REEL		C20001036M160S	2	
R4297	nsp	1K-J,1/5W-52RE-AX		C00001026P520S	1	
R4302	nsp	470K-J,1/16W-1608REEL		C20004746M160S	1	
R5007,5008	nsp	75-J,1/16W-1608REEL		C20007506M160S	2	
R5009,5010	nsp	10K-J,1/16W-1608REEL		C20001036M160S	2	
R5011	nsp	75-J,1/16W-1608REEL		C20007506M160S	1	
R5014	nsp	75-J,1/16W-1608REEL		C20007506M160S	1	
R5015	nsp	150-J,1/16W-1608REEL	E3	C20001516M160S	1	
R5016	nsp	150-J,1/16W-1608REEL		C20001516M160S	1	
R5017	nsp	160-J,1/16W-1608REEL	E3	C20001616M160S	1	
R5018	nsp	160-J,1/16W-1608REEL		C20001616M160S	1	
R5019	nsp	150-J,1/16W-1608REEL	E3	C20001516M160S	1	
R5020	nsp	150-J,1/16W-1608REEL		C20001516M160S	1	
R5021	nsp	160-J,1/16W-1608REEL	E3	C20001616M160S	1	
R5022	nsp	160-J,1/16W-1608REEL		C20001616M160S	1	
R5023	nsp	150-J,1/16W-1608REEL	E3	C20001516M160S	1	
R5024	nsp	150-J,1/16W-1608REEL		C20001516M160S	1	
R5025	nsp	160-J,1/16W-1608REEL	E3	C20001616M160S	1	
R5026	nsp	160-J,1/16W-1608REEL		C20001616M160S	1	
R5033-5035	nsp	75-J,1/16W-1608REEL		C20007506M160S	3	
R5036	nsp	10K-J,1/16W-1608REEL		C20001036M160S	1	
R5037-5039	nsp	75-J,1/16W-1608REEL	E3	C20007506M160S	3	
R5069-R5071	nsp	10K-J,1/16W-1608REEL	E2/E1/E1C/K	C20001036M160S	3	
<b>CAPACITORS GROUP</b>						
C4200,4201	nsp	COG330PF-J/50V-1608REEL	X2100	D010331167160S	2	
C4202,4203	00D9630224503	22UF-M/50V,5*11-5RE.SMS SY	X2100	D040220087060S	2	
C4204	nsp	COG330PF-J/50V-1608REEL		D010331167160S	1	
C4205,4206	00D9630224503	22UF-M/50V,5*11-5RE.SMS SY		D040220087060S	2	
C4207	nsp	X7R)0.01UF-K/50V-1608REEL	X2100	D010103777160S	1	
C4208	nsp	X7R)0.01UF-K/50V-1608REEL	X2100	D010103777160S	1	
C4209	nsp	COG330PF-J/50V-1608REEL		D010331167160S	1	
C4210,4211	00D9630224503	22UF-M/50V,5*11-5RE.SMS SY		D040220087060S	2	
C4220	00D9630244606	0.1UF-M/50V,5*11-5RE.SMS SY (Pb Free)	X2100	D040R10087080S	1	
C4221,4222	00D9630224503	22UF-M/50V,5*11-5RE.SMS SY	X2100	D040220087060S	2	
C4247	00D2544573981	10UF-M/50V,5*11-5RE.SMS SY		D04010087070S	1	
C4248	00D9630244606	0.1UF-M/50V,5*11-5RE.SMS SY (Pb Free)		D040R10087080S	1	
C5008-5010	nsp	COG68PF-J/50V-1608REEL	E3	D010680167160S	3	
C5011	00D9630293709	100UF-M/10V,5*11-5RE.SMS SY		D040101082070S	1	
C5012	nsp	COG68PF-J/50V-1608REEL		D010680167160S	1	
C5013,5014	nsp	X7R)0.1UF-K/50V-1608REEL		D011104577160S	2	
C5015,5016	nsp	COG68PF-J/50V-1608REEL		D010680167160S	2	
C5017,5018	00D9630293602	1UF-M/50V,5*11-5RE.SMS SY (Pb Free)		D040010087150S	2	
C5019,5020	nsp	X7R)0.1UF-K/50V-1608REEL		D011104577160S	2	
C5021	00D9630293602	1UF-M/50V,5*11-5RE.SMS SY (Pb Free)		D040010087150S	1	
C5022	00D9630293709	100UF-M/10V,5*11-5RE.SMS SY		D040101082070S	1	
C5023-5025	00D9630293602	1UF-M/50V,5*11-5RE.SMS SY (Pb Free)	E3	D040010087150S	3	
C5026,5027	00D2544573981	10UF-M/50V,5*11-5RE.SMS SY		D04010087070S	2	
C5029	00D2544574922	100UF-M/50V,8*11.5-5RE.SMS SY		D040101087060S	1	
C5030	nsp	X7R)0.1UF-K/50V-1608REEL		D011104577160S	1	
C5031	00D2544574922	100UF-M/50V,8*11.5-5RE.SMS SY		D040101087060S	1	
C5032	nsp	X7R)0.1UF-K/50V-1608REEL		D011104577160S	1	
C5048	963134502400S	MI-0.1UF-J/50V-5RE		D020104167050S	1	
C5051	963134502400S	MI-0.1UF-J/50V-5RE		D020104167050S	1	
<b>OTHER PARTS GROUP</b>						
BKT5001,5002	nsp	AVR133(HARMAN) BARRING HOLE SPT E 0.8t/SCREW		4010210196100S	2	
BKT5003	nsp	BRACKET AVR133(HARMAN) BARRING HOLE SPT E 0.8t/SCREW	E2/E1/E1C/K	4010210196100S	1	
CLAMP300-302	nsp	HMX9800(ON)(HAITAI) (W=2.6,L=50)WIRE(SOLDER)		4330000120000S	3	
CN4002	nsp	C125Z2-15 15P BtoB SOCKET(FEMALE) P=1.25MM		L109012521540S	1	
CN4003	nsp	C125Z2-21 21P BtoB SOCKET(FEMALE) P=1.25MM		L109012522140S	1	

REF No.	Part No.	Part Name	Remarks	Q'ty	New	Ver
CN5000	nsp	C125Z2-11 11P BtoB SOCKET(FEMALE) P=1.25MM		L109012521140S	1	
CN5001	nsp	C125Z2-13 13P BtoB SOCKET(FEMALE) P=1.25MM		L109012521340S	1	
CN5003	nsp	C125Z2-17 17P BtoB SOCKET(FEMALE) P=1.25MM		L109012521740S	1	
CN5004	nsp	C125Z2-07 7P BtoB SOCKET(FEMALE) P=1.25MM		L109012520740S	1	
CP3401	nsp	C125Z1-11 11P BtoB HEADER(MALE) P=1.25MM		L109012511140S	1	
CP3404	nsp	C125Z1-17 17P BtoB HEADER(MALE) P=1.25MM		L109012511740S	1	
CP5000	nsp	C125Z1-11 11P BtoB HEADER(MALE) P=1.25MM		L109012511140S	1	
CP5001	nsp	C125Z1-13 13P BtoB HEADER(MALE) P=1.25MM		L109012511340S	1	
CP5003	nsp	YMAW025-08R DIP RA		L102025080010S	1	
CP5004	nsp	C125Z1-07 7P BtoB HEADER(MALE) P=1.25MM		L109012510740S	1	
!	F5006	963652010500S	T1.6A/250V-IVBSUCPCcUR S506	N751501601160S	1	
	F5006A	nsp	PI5.2-REEL	G645000050010S	1	
	F5006B	nsp	PI5.2-REEL	G645000050010S	1	
!	F5007	963652010500S	T1.6A/250V-IVBSUCPCcUR S506	N751501601160S	1	
	F5007A	nsp	PI5.2-REEL	G645000050010S	1	
	F5007B	nsp	PI5.2-REEL	G645000050010S	1	
!	F5008	963652010500S	T1.6A/250V-IVBSUCPCcUR S506	N751501601160S	1	
	F5008A	nsp	PI5.2-REEL	G645000050010S	1	
	F5008B	nsp	PI5.2-REEL	G645000050010S	1	
!	F5009	963652010500S	T1.6A/250V-IVBSUCPCcUR S506	N751501601160S	1	
	F5009A	nsp	PI5.2-REEL	G645000050010S	1	
	F5009B	nsp	PI5.2-REEL	G645000050010S	1	
JACK5000	963643102830S	RC003-F05R1BY-D(G,B,R,Y,Y)YUQIU		G603RC003F05YS	1	*
JACK5001	00D9630146306	RCA-603B-26(GN,BL,RD,GN,BL,RD)	E3	G603603B2600YS	1	
JACK5003	963643102810S	RCA-207AE-06(BK,BK)	S900	G601207AE060YS	1	*
JACK5004	963643102820S	RCA-405B0-02-25(WH,BK/RD,BK)	X2100	G602405B0225YS	1	*

## INPUT PCB ASS'Y

※Parts indicated by "nsp" on this table cannot be supplied.

※The parts listed below are only for maintenance. Therefore they might differ from the parts used in the unit in appearances or dimensions.

NOTE: The symbols in the column Remarks indicate the following destinations.

E3 : U.S.A. &amp; Canada model E2 : Europe model E1C : China model E1 : Asia model K : Japan model

BK : Black model SP : Silver gold model

REF No.	Part No.	Part Name	Remarks	Q'ty	New	Ver
<b>SEMICONDUCTORS GROUP</b>						
IC4200	96323900650S	R2A15218FP-U00R 8CH-VOL WITH 11 INPUT QFP100P		J084152180010S	1	
IC5201	963232100400S	UTC4580E SOP8 DUAL OP AMP	X2100	J121458001010S	1	
IC5202	00D2631193902	BD3812F-E2 2CH-VOL SOP14P	X2100	J084381200010S	1	
U1047	963232100390S	NJM8080G SOP8 DUAL OP AMP		J121808000010S	1	
U1049	963232100390S	NJM8080G SOP8 DUAL OP AMP		J121808000010S	1	
U1051	963232100390S	NJM8080G SOP8 DUAL OP AMP		J121808000010S	1	
U1053	963232100390S	NJM8080G SOP8 DUAL OP AMP		J121808000010S	1	
<b>RESISTOR GROUP</b>						
R1999	nsp	15K-J,1/16W-1608REEL		C20001536M160S	1	
R2000	nsp	820-J,1/16W-1608REEL		C20008216M160S	1	
R2001	nsp	100-J,1/16W-1608REEL		C20001016M160S	1	
R2002	nsp	15K-J,1/16W-1608REEL		C20001536M160S	1	
R2003	nsp	820-J,1/16W-1608REEL		C20008216M160S	1	
R2005,2006	nsp	11K-J,1/16W-1608REEL		C20001136M160S	2	
R2009	nsp	11K-J,1/16W-1608REEL		C20001136M160S	1	
R2010	nsp	15K-J,1/16W-1608REEL		C20001536M160S	1	
R2011	nsp	820-J,1/16W-1608REEL		C20008216M160S	1	
R2012	nsp	100-J,1/16W-1608REEL		C20001016M160S	1	
R2013	nsp	15K-J,1/16W-1608REEL		C20001536M160S	1	
R2014	nsp	820-J,1/16W-1608REEL		C20008216M160S	1	
R2015	nsp	11K-J,1/16W-1608REEL		C20001136M160S	1	
R2017	nsp	15K-J,1/16W-1608REEL		C20001536M160S	1	
R2018	nsp	820-J,1/16W-1608REEL		C20008216M160S	1	
R2019	nsp	100-J,1/16W-1608REEL		C20001016M160S	1	
R2021	nsp	15K-J,1/16W-1608REEL		C20001536M160S	1	
R2022	nsp	820-J,1/16W-1608REEL		C20008216M160S	1	
R2024,2025	nsp	11K-J,1/16W-1608REEL		C20001136M160S	2	
R2030	nsp	300K-J,1/16W-1608REEL		C20003046M160S	1	
R2031	nsp	24K-J,1/16W-1608REEL		C20002436M160S	1	
R2034	nsp	15K-J,1/16W-1608REEL		C20001536M160S	1	
R2035	nsp	820-J,1/16W-1608REEL		C20008216M160S	1	
R2036	nsp	100-J,1/16W-1608REEL		C20001016M160S	1	
R2038	nsp	15K-J,1/16W-1608REEL		C20001536M160S	1	
R2039	nsp	820-J,1/16W-1608REEL		C20008216M160S	1	
R2040	nsp	24K-J,1/16W-1608REEL		C20002436M160S	1	
R2041	nsp	300K-J,1/16W-1608REEL		C20003046M160S	1	
R2044	nsp	15K-J,1/16W-1608REEL		C20001536M160S	1	
R2045	nsp	820-J,1/16W-1608REEL		C20008216M160S	1	
R2046	nsp	100-J,1/16W-1608REEL		C20001016M160S	1	
R2047	nsp	15K-J,1/16W-1608REEL		C20001536M160S	1	
R2048	nsp	820-J,1/16W-1608REEL		C20008216M160S	1	
R2051,2052	nsp	16K-J,1/16W-1608REEL		C20001636M160S	2	
R2056	nsp	16K-J,1/16W-1608REEL		C20001636M160S	1	
R2058	nsp	15K-J,1/16W-1608REEL		C20001536M160S	1	
R2059	nsp	820-J,1/16W-1608REEL		C20008216M160S	1	
R2060	nsp	100-J,1/16W-1608REEL		C20001016M160S	1	
R2062	nsp	15K-J,1/16W-1608REEL		C20001536M160S	1	
R2063	nsp	820-J,1/16W-1608REEL		C20008216M160S	1	
R2064	nsp	16K-J,1/16W-1608REEL		C20001636M160S	1	
R2069	nsp	15K-J,1/16W-1608REEL		C20001536M160S	1	
R2070	nsp	820-J,1/16W-1608REEL		C20008216M160S	1	
R2071	nsp	100-J,1/16W-1608REEL		C20001016M160S	1	
R2072	nsp	15K-J,1/16W-1608REEL		C20001536M160S	1	
R2073	nsp	820-J,1/16W-1608REEL		C20008216M160S	1	
R2076,2077	nsp	11K-J,1/16W-1608REEL		C20001136M160S	2	
R2081	nsp	11K-J,1/16W-1608REEL		C20001136M160S	1	
R2082	nsp	15K-J,1/16W-1608REEL		C20001536M160S	1	
R2083	nsp	820-J,1/16W-1608REEL		C20008216M160S	1	
R2084	nsp	100-J,1/16W-1608REEL		C20001016M160S	1	
R2085	nsp	15K-J,1/16W-1608REEL		C20001536M160S	1	
R2086	nsp	820-J,1/16W-1608REEL		C20008216M160S	1	
R2087	nsp	11K-J,1/16W-1608REEL		C20001136M160S	1	
R4205-4211	nsp	470-J,1/16W-1608REEL		C20004716M160S	7	
R4216-4221	nsp	820K-J,1/16W-1608REEL		C20008246M160S	6	
R4244,4245	nsp	470K-J,1/16W-1608REEL		C20004746M160S	2	
R4248	nsp	100-J,1/16W-1608REEL		C20001016M160S	1	
R4249-4254	nsp	470K-J,1/16W-1608REEL		C20004746M160S	6	
R4257	nsp	100-J,1/16W-1608REEL		C20001016M160S	1	
R4259-4262	nsp	100K-J,1/16W-1608REEL		C20001046M160S	4	
R4263-4270	nsp	10K-J,1/16W-1608REEL		C20001036M160S	8	
R4271-4277	nsp	100K-J,1/16W-1608REEL		C20001046M160S	7	
R4287	nsp	100K-J,1/16W-1608REEL		C20001046M160S	1	
R4288-4290	nsp	0-J,1/16W-1608REEL		C20000006M160S	3	
R4292-4294	nsp	0-J,1/16W-1608REEL		C20000006M160S	3	
R4326	nsp	100-J,1/16W-1608REEL		C20001016M160S	1	
R4370-4376	nsp	100-J,1/16W-1608REEL		C20001016M160S	7	
R4550	nsp	470-J,1/16W-1608REEL		C20004716M160S	1	
R4551,4552	nsp	820K-J,1/16W-1608REEL		C20008246M160S	2	
R5300	nsp	47-J,1/16W-1608REEL	X2100	C20004706M160S	1	
R5304	nsp	47K-J,1/16W-1608REEL	X2100	C20004736M160S	1	
R5310	nsp	47K-J,1/16W-1608REEL	X2100	C20004736M160S	1	
R5311	nsp	47-J,1/16W-1608REEL	X2100	C20004706M160S	1	
R5312	nsp	4.7K-J,1/16W-1608REEL		C20004726M160S	1	
R5313,5314	nsp	33-J,1/16W-1608REEL		C20003306M160S	2	
R5315	nsp	0-J,1/16W-1608REEL	S900	C20000006M160S	1	
R5318	nsp	0-J,1/16W-1608REEL	S900	C20000006M160S	1	
R5323	nsp	100K-J,1/16W-1608REEL		C20001046M160S	1	
R5326	nsp	100K-J,1/16W-1608REEL	X2100	C20001046M160S	1	
R5331	nsp	100K-J,1/16W-1608REEL	X2100	C20001046M160S	1	
R5336	nsp	100K-J,1/16W-1608REEL		C20001046M160S	1	
R5337,5338	nsp	1K-J,1/16W-1608REEL	X2100	C20001026M160S	2	
R5340,5341	nsp	100-J,1/16W-1608REEL	X2100	C20001016M160S	2	
R5342	nsp	11K-J,1/16W-1608REEL	X2100	C20001136M160S	1	
R5343	nsp	2.2K-J,1/16W-1608REEL	X2100	C2000226M160S	1	

REF No.	Part No.	Part Name	Remarks	Q'ty	New	Ver
R5344	nsp	11K-J,1/16W-1608REEL	X2100	C20001136M160S	1	
R5345	nsp	2.2K-J,1/16W-1608REEL	X2100	C20002226M160S	1	
<b>CAPACITORS GROUP</b>						
C2137	00D257050910	CH)1500PF-J/50V-1608REEL GRM1882C1H152JA01D		D010152167165S	1	
C2139,2140	00D2570507976	CH)330PF-J/50V-1608REEL GRM1882C1H331JA01D		D010331167165S	2	
C2141	00D9630333203	100UF-M/16V,5*11-5RE,SHL SY		D040101083090S	1	
C2142	00D2570507976	CH)330PF-J/50V-1608REEL GRM1882C1H331JA01D		D010331167165S	1	
C2145	00D9630333203	100UF-M/16V,5*11-5RE,SHL SY		D040101083090S	1	
C2146	00D257050910	CH)1500PF-J/50V-1608REEL GRM1882C1H152JA01D		D010152167165S	1	
C2148	00D2570507976	CH)330PF-J/50V-1608REEL GRM1882C1H331JA01D		D010331167165S	1	
C2151	00D257050910	CH)1500PF-J/50V-1608REEL GRM1882C1H152JA01D		D010152167165S	1	
C2152,2153	00D2570507976	CH)330PF-J/50V-1608REEL GRM1882C1H331JA01D		D010331167165S	2	
C2155	00D2570507976	CH)330PF-J/50V-1608REEL GRM1882C1H331JA01D		D010331167165S	1	
C2157	00D257050910	CH)1500PF-J/50V-1608REEL GRM1882C1H152JA01D		D010152167165S	1	
C2158	00D2570507976	CH)330PF-J/50V-1608REEL GRM1882C1H331JA01D		D010331167165S	1	
C2162	00D257050910	CH)1500PF-J/50V-1608REEL GRM1882C1H152JA01D		D010152167165S	1	
C2166,2167	00D2570507947	CH)240PF-J/50V-1608REEL GRM1882C1H241JA01D		D010241167165S	2	
C2170	00D2570507947	CH)240PF-J/50V-1608REEL GRM1882C1H241JA01D		D010241167165S	1	
C2171	00D257050910	CH)1500PF-J/50V-1608REEL GRM1882C1H152JA01D		D010152167165S	1	
C2173	00D2570507947	CH)240PF-J/50V-1608REEL GRM1882C1H241JA01D		D010241167165S	1	
C2180	00D257050910	CH)1500PF-J/50V-1608REEL GRM1882C1H152JA01D		D010152167165S	1	
C2182-2184	00D2570507976	CH)330PF-J/50V-1608REEL GRM1882C1H331JA01D		D010331167165S	3	
C2185	00D257050910	CH)1500PF-J/50V-1608REEL GRM1882C1H152JA01D		D010152167165S	1	
C2186	00D2570507976	CH)330PF-J/50V-1608REEL GRM1882C1H331JA01D		D010331167165S	1	
C4204	nsp	COG330PF-J/50V-1608REEL		D010331167160S	1	
C4209-4211	nsp	COG330PF-J/50V-1608REEL		D010331167160S	3	
C4225,4226	00D2544573981	10UF-M/50V,5*11-5RE,SMS SY		D040100087070S	2	
C4229,4230	13405013040AS	220UF-M/25V,8*11.5 KR3-025V221MF115-T/A5.0S KOSHIN		D040221084550S	2	*
C4231	963134501900S	100UF-M/25V,6.3*11-5RE RA3-25V101MF3#8P-T2		D040101084210S	1	
C4232-4236	13405013240AS	47UF-M/25V,5*11 KR3-025V470MC110-T/A5.0S KOSHIN		D040470084550S	5	*
C4237-4239	963134502360S	47UF-M/63V,8*11.5-5RE,SMS-SY		D040470088060S	3	
C4240-4244	13405013240AS	47UF-M/25V,5*11 KR3-025V470MC110-T/A5.0S KOSHIN		D040470084550S	5	*
C4245,4246	13405013040AS	220UF-M/25V,8*11.5 KR3-025V221MF115-T/A5.0S KOSHIN		D040221084550S	2	*
C4247,4248	00D2544573981	10UF-M/50V,5*11-5RE,SMS SY		D040100087070S	2	
C4550-4553	nsp	COG330PF-J/50V-1608REEL		D010331167160S	4	
C4554	nsp	0-J,1/16W-1608REEL		C20000006M160S	1	
C5251	00D2544573981	10UF-M/50V,5*11-5RE,SMS SY	X2100	D040100087070S	1	
C5255	00D2544573981	10UF-M/50V,5*11-5RE,SMS SY	X2100	D040100087070S	1	
C5257	00D9630223902	COG39PF-J/50V-1608REEL	X2100	D010390167160S	1	
C5258	00D9630224503	22UF-M/50V,5*11-5RE,SMS SY	X2100	D040220087060S	1	
C5262	00D2544573981	10UF-M/50V,5*11-5RE,SMS SY		D040100087070S	1	
C5263	00D2544573981	10UF-M/50V,5*11-5RE,SMS SY	X2100	D040100087070S	1	
C5265	00D2544573981	10UF-M/50V,5*11-5RE,SMS SY	X2100	D040100087070S	1	
C5266	00D2544573981	10UF-M/50V,5*11-5RE,SMS SY		D040100087070S	1	
C5267	00D9630224503	22UF-M/50V,5*11-5RE,SMS SY	X2100	D040220087060S	1	
C5269,5270	nsp	X7R)0.01UF-K/50V-1608REEL	X2100	D010103777160S	2	
C5271-5273	nsp	COG100PF-J/50V-1608REEL	X2100	D010101167160S	3	
C5275	00D9630223902	COG39PF-J/50V-1608REEL	X2100	D010390167160S	1	
<b>OTHER PARTS GROUP</b>						
CLAMP701,702	nsp	HMX9800(ON)(HAITAI) (W=2.6,L=50)/WIRE(SOLDER)		4330000120000S	2	
CN4006	nsp	C125Z2-11 11P BtoB SOCKET(FEMALE) P=1.25MM		L109012521140S	1	
CN401	nsp	200MM/13P 20010HS-13-CKM2002HV-13 WH1007#26		L002201130010S	1	
CN4701	nsp	C125Z2-07 7P BtoB SOCKET(FEMALE) P=1.25MM	X2100E3	L109012520740S	1	
CN4703	nsp	C125Z2-09 9P BtoB SOCKET(FEMALE) P=1.25MM		L109012520940S	1	
CP4200,4201	nsp	C125Z1-23 23P BtoB HEADER(MALE) P=1.25MM		L109012512340S	2	
CP4203	nsp	C125Z1-07 7P BtoB HEADER(MALE) P=1.25MM		L109012510740S	1	
CP4204	nsp	C125Z1-17 17P BtoB HEADER(MALE) P=1.25MM		L109012511740S	1	
CP4205	nsp	C125Z1-15 15P BtoB HEADER(MALE) P=1.25MM		L109012511540S	1	
JACK4201,4202	00D9630132103	RCA-405B-04(WH,WH,RD,RD)-YUQIU		G602405B0400YS	2	
N4700	nsp	1.0-9-4PW 4P AN DIP TOP CONTACT	E2/E1/E1C/K/S900	L130100090450S	1	

## SMPS PCB ASS'Y

※Parts indicated by "nsp" on this table cannot be supplied.

※The parts listed below are only for maintenance. Therefore they might differ from the parts used in the unit in appearances or dimensions.

NOTE: The symbols in the column Remarks indicate the following destinations.

E3 : U.S.A. &amp; Canada model E2 : Europe model E1C : China model E1 : Asia model K : Japan model

BK : Black model SP : Silver gold model

REF No.	Part No.	Part Name	Remarks	Q'ty	New	Ver
<b>SEMICONDUCTORS GROUP</b>						
D4140-4148	963201500160D	1N4007 52REEL 1000V 1A		K000400700220S	9	
D4149	963204500210D	S30SC6MT 60V 30A TO-3P(MTO-3PT) SHINDENGEN		K120300600010S	1	
D4150	00D276040190S	1SS133-DO34-AXIAL LRC		K000013300040S	1	
!	IC4140	231010091708S	TOP258MG SDIP10 OFF-LINE POWER SUPPLY IC	J122258001010S	1	
!	IC4142	00D2623047008	PC123X2YFZ (DIP4P SHARP)	K614123000010S	1	
	IC4143	212050010508S	KIA2431AP,0.7W TO-92	J126243118010S	1	
TR4140	963222500150D	KMB2D0N60SA N-CH MOSFET 60V SOT23		J543206005510S	1	
TR4142	963213500170D	KTC3198G,0.6W/TO92-REEL		J5023198G0000S	1	
ZD4147-4149	963202500370D	ZJ39B-0.5W/5MA-52MM SEMTECH	E3/K	K06039R044522S	3	
ZD4150-4157	963202500350D	ZJ22B-0.5W/5MA-52MM SEMTECH		K06022R044522S	8	
ZD4158	963202500370D	ZJ39B-0.5W/5MA-52MM SEMTECH		K06039R044522S	1	
ZD4159	963202500320D	ZJ5.6B-0.5W/5MA-52MM SEMTECH		K06005R644522S	1	
ZD4160	963202500320D	ZJ5.6B-0.5W/5MA-52MM SEMTECH	E3	K06005R644522S	1	
ZD4160	963202500400S	ZJ16B-0.5W/5MA-52MM SEMTECH	E2/E1/E1C	K06016R044522S	1	
ZD4160	963202500310D	ZJ5.1B-0.5W/5MA-52MM SEMTECH	K	K06005R144522S	1	
<b>RESISTOR GROUP</b>						
R4141,4142	nsp	1M-J,1/5W-52RE-AX		C00001056P520S	2	
R4143	nsp	330K-J,1/5W-52RE-AX		C00003346P520S	1	
R4145	nsp	1M-J,1/16W-1608REEL		C20001056M160S	1	
R4147	nsp	270K-J,1/16W-1608REEL	E3/K	C20002746M160S	1	
R4147	nsp	56K-J,1/16W-1608REEL	E2/E1/E1C	C20005636M160S	1	
R4148,4149	nsp	2.2M-J,1/5W-52RE-AX	E3/K	C00002256P520S	2	
R4150	nsp	1M-J,1/5W-52RE-AX	E3/K	C00001056P520S	1	
R4151	nsp	15K-J,1/16W-1608REEL		C20001536M160S	1	
R4152	nsp	1K-J,1/16W-1608REEL		C20001026M160S	1	
R4153	nsp	6.8K-J,1/5W-52RE-AX		C0006R806P520S	1	
R4154	nsp	10-J,1/16W-1608REEL		C20001006M160S	1	
R4155	nsp	10K-J,1/16W-1608REEL		C20001036M160S	1	
R4156	nsp	4.7K-J,1/16W-1608REEL		C20004726M160S	1	
R4157	nsp	56-J,1/5W-52RE-AX		C00005606P520S	1	
R4158	nsp	3.3K-J,1/5W-52RE-AX		C00003326P520S	1	
R4159	nsp	5.6K-J,1/5W-52RE-AX		C00005626P520S	1	
R4160	nsp	22K-F,1/16W-1608REEL		C20002234M161S	1	
R4161	00D2472041967	6.8K-D,1/16W-1608REEL		C20006821M160S	1	
R4164	nsp	1M-J,1/5W-52RE-AX		C00001056P520S	1	
<b>CAPACITORS GROUP</b>						
!	C4140,4141	963134011730S	DE1B3KX471KB4BL01 AC250V BULK MURATA	D00847127H010S	2	
!	C4142	963132011940S	DE2F3KY103MB3BM02 AC250V BULK MURATA	D008103589010S	1	
!	C4143	nsp	0.1UF-K/275V BULK X2 MPX104K3ID2 P=15MM CARLI	D02110407H010S	1	
	C4145-4147	nsp	X7R)0.1UF-K/50V-1608REEL	D011104577160S	3	
!	C4148,4149	963132011940S	DE2F3KY103MB3BM02 AC250V BULK MURATA	E2/E1/E1C	D008103589010S	2
	C4150	nsp	X7R)0.1UF-K/50V-1608REEL	D011104577160S	1	
	C4151	943134501590S	100UF-M/200V,16*20 BULK NHA SY	E3/K	D04110108G000S	1
	C4152	963134010200S	100UF-M/400V,18*31.5 BULK NHA SY	E2/E1/E1C	D04110108K000S	1
	C4152	963134010210S	47UF-M/25V,5*11-5RE NXA SY		D041470084050S	1
	C4153	963132010120S	DEHR33A102KB2B		D00810207Q010S	1
	C4154	nsp	X7R)0.1UF-K/50V-1608REEL		D011104577160S	1
	C4155	963134010190S	10UF-M/50V,5*11-5RE NXA SY		D041100087050S	1
!	C4156	963132011930S	DE1E3KX222MB4BL01 AC250V BULK MURATA		D00822248H010S	1
	C4159	nsp	X7R)0.1UF-K/50V-1608REEL		D011104577160S	1
	C4160	nsp	X7R)1UF-K/10V-1608REEL		D011105772161S	1
	C4161	nsp	X7R)4.7UF-K/6.3V-1608REEL		D011475571160S	1
	C4162	963134010220S	5600UF-M/6.3V,12.5*35 NXA SY		D041562081001S	1
	C4163	nsp	X7R)1UF-K/10V-1608REEL		D011105772161S	1
	C4164,4165	963134010220S	5600UF-M/6.3V,12.5*35 NXA SY		D041562081001S	2
	C4166	nsp	X7R)0.1UF-K/50V-1608REEL		D011104577160S	1
	C4167,4168	nsp	X7R)1UF-K/10V-1608REEL		D011105772161S	2
<b>OTHER PARTS GROUP</b>						
	BKT4140	nsp	BRACKET AVR133(HARMAN) BARRING HOLE SPTE 0.8/SCREW	E1C/K/S900	4010210196100S	1
	BKT4141	nsp	AVR133(HARMAN) BARRING HOLE SPTE 0.8/SCREW		4010210196100S	1
	BKT4143	nsp	AVR3300(E3)(DENON) SPTE 0.8/SCREW		4010210196000S	1
	BKT4144	nsp	AVRE400BKE3(DENON) SPTE 0.3T /CASE		3070210596100S	1
	CN4141	nsp	150MM/5P SMH250-05=CKM2509HV-05 WH1007#22		L000151050220S	1
	CP4140	nsp	PLUG YW396-03AV 2P	E1C/K/S900	L108396030010S	1
!	CP4142	nsp	LWB1143-02P 7.92MM HEADER,VER,2CKT		L108011430210S	1
!	F4140	963652010510S	T2A/250V-IVBSUCPCcUR S506	E3/K	N751502001160S	1
!	F4140	963652010910S	T3.15A/250V-IVBSUCPCcUR S506	E2/E1/E1C	N751503151160S	1
!	F4141	963652010520S	T6.3A/250V-IVBSUCPCcUR S506		N751506301160S	1
	FC4140A	nsp	PI5.2-REEL		G645000050010S	1
	FC4140B,4141	nsp	PI5.2-REEL		G645000050010S	2
	FC4141B	nsp	PI5.2-REEL		G645000050010S	1
!	JK4140	963641011240S	AC0152PPA66 AC INLET 2P_REV1.0 CCC	X2100E3/E2/E1	G4300152P0001S	1
!	L4140	963111100420D	SQ2014 27mH VERTICAL TYPE LINE FILTER	E3/K	D320201405510S	1
!	L4140	963111100470S	SQ2014 50mH VERTICAL TYPE LINE FILTER	E2/E1/E1C	D320201405000S	1
!	RLY4140	963682100290D	JZC-36FD/005-HLT 23.8*9.5*24.5mm		G680060103030S	1
!	T4140	963102100360S	EER2834 SW TRANSFORMER GAP BONDING		E060283405530S	1

## 7CH\_AMP PCB ASS'Y

※Parts indicated by "nsp" on this table cannot be supplied.

※The parts listed below are only for maintenance. Therefore they might differ from the parts used in the unit in appearances or dimensions.

NOTE: The symbols in the column Remarks indicate the following destinations.

E3 : U.S.A. &amp; Canada model E2 : Europe model E1C : China model E1 : Asia model K : Japan model

BK : Black model SP : Silver gold model

REF No.	Part No.	Part Name	Remarks	Q'ty	New	Ver
<b>SEMICONDUCTORS GROUP</b>						
D402	00D2760401905	1SS133-DO34-AXIAL LRC		K000013300040S	1	
D408	00D2760401905	1SS133-DO34-AXIAL LRC		K000013300040S	1	
D414	00D2760401905	1SS133-DO34-AXIAL LRC		K000013300040S	1	
D420	00D2760401905	1SS133-DO34-AXIAL LRC		K000013300040S	1	
D426	00D2760401905	1SS133-DO34-AXIAL LRC		K000013300040S	1	
D432	00D2760401905	1SS133-DO34-AXIAL LRC		K000013300040S	1	
D438	00D2760401905	1SS133-DO34-AXIAL LRC		K000013300040S	1	
D458	nsp	0-J,1/16W-1608REEL		C2000006M160S	1	
Q401	00D2710314903	KTA1024Y,1W/TO92L-REEL		J5001024Y0050S	1	
Q403	00D2710318909	2N5401S 0.35W/SOT-23 REEL		J520254010010S	1	
Q405	00D2710318909	2N5401S 0.35W/SOT-23 REEL		J520254010010S	1	
Q406	00D2730479909	2N5551S 0.35W/SOT-23 REEL		J522255510010S	1	
Q407,408	21785000550AS	HN4A06J		J520040600210S	2	*
Q412	00D2730471907	KTC3206Y,1W/TO92L-REEL		J5023206Y0050S	1	
Q413	00D2710314903	KTA1024Y,1W/TO92L-REEL		J5001024Y0050S	1	
Q415	00D2710318909	2N5401S 0.35W/SOT-23 REEL		J520254010010S	1	
Q417	00D9600196205	KSA992F,0.5W/TO92-REEL		J5000992F0050S	1	
Q418	00D2730479909	2N5551S 0.35W/SOT-23 REEL		J522255510010S	1	
Q419,420	21785000550AS	HN4A06J		J520040600210S	2	*
Q424	00D2730471907	KTC3206Y,1W/TO92L-REEL		J5023206Y0050S	1	
Q425	00D2710314903	KTA1024Y,1W/TO92L-REEL		J5001024Y0050S	1	
Q427	00D2710318909	2N5401S 0.35W/SOT-23 REEL		J520254010010S	1	
Q429	21785000550AS	HN4A06J		J520040600210S	1	*
Q430	00D2730479909	2N5551S 0.35W/SOT-23 REEL		J522255510010S	1	
Q431,432	21785000550AS	HN4A06J		J520040600210S	2	*
Q436	00D2730471907	KTC3206Y,1W/TO92L-REEL		J5023206Y0050S	1	
Q437	00D2710314903	KTA1024Y,1W/TO92L-REEL		J5001024Y0050S	1	
Q439	00D2710318909	2N5401S 0.35W/SOT-23 REEL		J520254010010S	1	
Q442	00D2730479909	2N5551S 0.35W/SOT-23 REEL		J522255510010S	1	
Q448	00D2730471907	KTC3206Y,1W/TO92L-REEL		J5023206Y0050S	1	
Q449	00D2710314903	KTA1024Y,1W/TO92L-REEL		J5001024Y0050S	1	
Q451	00D2710318909	2N5401S 0.35W/SOT-23 REEL		J520254010010S	1	
Q454	00D2730479909	2N5551S 0.35W/SOT-23 REEL		J522255510010S	1	
Q460	00D2730471907	KTC3206Y,1W/TO92L-REEL		J5023206Y0050S	1	
Q461	00D2710314903	KTA1024Y,1W/TO92L-REEL		J5001024Y0050S	1	
Q463	00D2710318909	2N5401S 0.35W/SOT-23 REEL		J520254010010S	1	
Q466	00D2730479909	2N5551S 0.35W/SOT-23 REEL		J522255510010S	1	
Q472	00D2730471907	KTC3206Y,1W/TO92L-REEL		J5023206Y0050S	1	
Q473	00D2710314903	KTA1024Y,1W/TO92L-REEL		J5001024Y0050S	1	
Q475	00D2710318909	2N5401S 0.35W/SOT-23 REEL		J520254010010S	1	
Q478	00D2730479909	2N5551S 0.35W/SOT-23 REEL		J522255510010S	1	
Q484	00D2730471907	KTC3206Y,1W/TO92L-REEL		J5023206Y0050S	1	
ZD401	963202500300D	ZJ5.1A-0.5W/5MA-52MM SEMTECH		K06005R134522S	1	
ZD404	963202500300D	ZJ5.1A-0.5W/5MA-52MM SEMTECH		K06005R134522S	1	
ZD407	963202500300D	ZJ5.1A-0.5W/5MA-52MM SEMTECH		K06005R134522S	1	
ZD410	963202500300D	ZJ5.1A-0.5W/5MA-52MM SEMTECH		K06005R134522S	1	
ZD413	963202500300D	ZJ5.1A-0.5W/5MA-52MM SEMTECH		K06005R134522S	1	
ZD416	963202500300D	ZJ5.1A-0.5W/5MA-52MM SEMTECH		K06005R134522S	1	
ZD419	963202500300D	ZJ5.1A-0.5W/5MA-52MM SEMTECH		K06005R134522S	1	
<b>RESISTOR GROUP</b>						
R401	nsp	1.2K-J,1/5W-52RE-AX		C00001226P520S	1	
R402	nsp	100K-J,1/5W-52RE-AX		C00001046P520S	1	
R404	nsp	RSD-R0-1WJ-4.7K 3*9 P=5MM SMALL R.REEL		N113135647230S	1	
R406	963252100140D	DHPTFH1608 471P 105T SMD PTC THERMISTOR		F320471001050S	1	
R407	nsp	10K-J,1/16W-1608REEL		C20001036M160S	1	
R408	nsp	RSD-R0-1WJ-4.7K 3*9 P=5MM SMALL R.REEL		N113135647230S	1	
R409	nsp	150K-J,1/5W-52RE-AX		C00001546P520S	1	
R411	nsp	200K-J,1/5W-52RE-AX		C00002046P520S	1	
R412	963121006330M	47K-J,1/5W-52RE-AX		C00004736P520S	1	
R413,414	nsp	10K-J,1/5W-52RE-AX		C00001036P520S	2	
R415	963125012630S	22-J,1W-5REEL		C060022065050S	1	
R416	nsp	22K-J,1/5W-52RE-AX		C00002236P520S	1	
R417	nsp	270K-J,1/16W-1608REEL		C20002746M160S	1	
R419	nsp	22K-J,1/5W-52RE-AX		C00002236P520S	1	
R421	nsp	22K-J,1/5W-52RE-AX		C00002236P520S	1	
R422	nsp	470-J,1/5W-52RE-AX		C00004716P520S	1	
R423	nsp	10K-J,1/16W-1608REEL		C20001036M160S	1	
R424,425	00D9630345903	RSD-R1-2WJ-0.47 3.5*8.6 P=5MM SMALL R.REEL		N113136647820S	2	
R426	nsp	5.6K-J,1/16W-1608REEL		C20005626M160S	1	
R427	nsp	1.2K-J,1/5W-52RE-AX		C00001226P520S	1	
R429	nsp	33K-J,1/5W-52RE-AX		C00003336P520S	1	
R430,431	00D9630345903	RSD-R1-2WJ-0.47 3.5*8.6 P=5MM SMALL R.REEL		N113136647820S	2	
R432	nsp	2.7K-J,1/5W-52RE-AX		C00002726P520S	1	
R434	nsp	3.3K-J,1W-R.REEL		C060033265050S	1	
R435	nsp	560-J,1/5W-52RE-AX		C00005616P520S	1	
R436	nsp	470K-J,1/5W-52RE-AX		C00004746P520S	1	
R437	nsp	33K-J,1/5W-52RE-AX		C00003336P520S	1	
R438	nsp	220-J,1/5W-52RE-AX		C00002216P520S	1	
R439	963125012630S	22-J,1W-5REEL		C060022065050S	1	
R440	nsp	150-J,1/5W-52RE-AX		C00001516P520S	1	
R441,442	nsp	1.2K-J,1W-5REEL		C060012265050S	2	
R443	nsp	47-J,1W-R.REEL		C060047065060S	1	
R444	nsp	1.2K-J,1/5W-52RE-AX		C00001226P520S	1	
R445	nsp	RSD-R0-1WJ-4.7K 3*9 P=5MM SMALL R.REEL		N113135647230S	1	
R446	nsp	100K-J,1/5W-52RE-AX		C00001046P520S	1	
R450	963252100140D	DHPTFH1608 471P 105T SMD PTC THERMISTOR		F320471001050S	1	
R451	nsp	RSD-R0-1WJ-4.7K 3*9 P=5MM SMALL R.REEL		N113135647230S	1	
R452	nsp	150K-J,1/5W-52RE-AX		C00001546P520S	1	
R454	nsp	200K-J,1/5W-52RE-AX		C00002046P520S	1	
R455	963121006330M	47K-J,1/5W-52RE-AX		C00004736P520S	1	
R456,457	nsp	10K-J,1/5W-52RE-AX		C00001036P520S	2	
R458	963125012630S	22-J,1W-5REEL		C060022065050S	1	
R459	nsp	22K-J,1/5W-52RE-AX		C00002236P520S	1	
R460	nsp	270K-J,1/16W-1608REEL		C20002746M160S	1	

REF No.	Part No.	Part Name	Remarks	Q'ty	New	Ver
R462	nsp	22K-J,1/5W-52RE-AX	C00002236P520S	1		
R464	25231006544S	PTC PRF18BF471QB5RB SMD1608 75T	F320184710060S	1	*	
R465	nsp	470-J,1/5W-52RE-AX	C00004716P520S	1		
R466	nsp	10K-J,1/16W-1608REEL	C20001036M160S	1		
R467,468	00D9630345903	RSD-R1-2WJ-0.47 3.5*8.6 P=5MM SMALL R.REEL	N113136647820S	2		
R469	nsp	5.6K-J,1/16W-1608REEL	C20005626M160S	1		
R471	nsp	1.2K-J,1/5W-52RE-AX	C00001226P520S	1		
R473	nsp	33K-J,1/5W-52RE-AX	C00003336P520S	1		
R474,475	00D9630345903	RSD-R1-2WJ-0.47 3.5*8.6 P=5MM SMALL R.REEL	N113136647820S	2		
R476	nsp	2.7K-J,1/5W-52RE-AX	C00002726P520S	1		
R478	nsp	3.3K-J,1W-R.REEL	C060033265050S	1		
R479	nsp	560-J,1/5W-52RE-AX	C00005616P520S	1		
R480	nsp	470K-J,1/5W-52RE-AX	C00004746P520S	1		
R481	nsp	33K-J,1/5W-52RE-AX	C00003336P520S	1		
R482	nsp	220-J,1/5W-52RE-AX	C00002216P520S	1		
R483	963125012630S	22-J,1W-5REEL	C060022065050S	1		
R484	nsp	150-J,1/5W-52RE-AX	C00001516P520S	1		
R485,486	nsp	1.2K-J,1W-5REEL	C060012265050S	2		
R487	nsp	47-J,1W-R.REEL	C060047065060S	1		
R488	nsp	1.2K-J,1/5W-52RE-AX	C00001226P520S	1		
R489	nsp	RSD-R0-1WJ-4.7K 3*9 P=5MM SMALL R.REEL	N113135647230S	1		
R490	nsp	100K-J,1/5W-52RE-AX	C00001046P520S	1		
R493	00D9630337908	33-J,1W-R.REEL	C060033065050S	1		
R494	963252100140D	DHPH1608 471P 105T SMD PTC THERMISTOR	F320471001050S	1		
R495	nsp	RSD-R0-1WJ-4.7K 3*9 P=5MM SMALL R.REEL	N113135647230S	1		
R496	nsp	150K-J,1/5W-52RE-AX	C00001546P520S	1		
R498	nsp	200K-J,1/5W-52RE-AX	C00002046P520S	1		
R499	963121006330M	47K-J,1/5W-52RE-AX	C00004736P520S	1		
R500,501	nsp	10K-J,1/16W-1608REEL	C20001036M160S	2		
R502	963125012630S	22-J,1W-5REEL	C060022065050S	1		
R503	nsp	22K-J,1/5W-52RE-AX	C00002236P520S	1		
R504	nsp	270K-J,1/16W-1608REEL	C20002746M160S	1		
R506	nsp	22K-J,1/5W-52RE-AX	C00002236P520S	1		
R507	nsp	220K-J,1/5W-52RE-AX	C00002246P520S	1		
R509	nsp	470-J,1/5W-52RE-AX	C00004716P520S	1		
R510	nsp	10K-J,1/16W-1608REEL	C20001036M160S	1		
R511,512	00D9630345903	RSD-R1-2WJ-0.47 3.5*8.6 P=5MM SMALL R.REEL	N113136647820S	2		
R513	nsp	5.6K-J,1/16W-1608REEL	C20005626M160S	1		
R514	nsp	1.2K-J,1/5W-52RE-AX	C00001226P520S	1		
R516	nsp	33K-J,1/5W-52RE-AX	C00003336P520S	1		
R517,518	00D9630345903	RSD-R1-2WJ-0.47 3.5*8.6 P=5MM SMALL R.REEL	N113136647820S	2		
R519	nsp	2.7K-J,1/5W-52RE-AX	C00002726P520S	1		
R520	nsp	220K-J,1/5W-52RE-AX	C00002246P520S	1		
R521	nsp	3.3K-J,1W-R.REEL	C060033265050S	1		
R522	nsp	560-J,1/5W-52RE-AX	C00005616P520S	1		
R523	nsp	470K-J,1/5W-52RE-AX	C00004746P520S	1		
R524	nsp	33K-J,1/5W-52RE-AX	C00003336P520S	1		
R525	nsp	220-J,1/5W-52RE-AX	C00002216P520S	1		
R526	963125012630S	22-J,1W-5REEL	C060022065050S	1		
R527	nsp	150-J,1/5W-52RE-AX	C00001516P520S	1		
R528,529	nsp	1.2K-J,1W-5REEL	C060012265050S	2		
R530	nsp	47-J,1W-R.REEL	C060047065060S	1		
R531	nsp	1.2K-J,1/5W-52RE-AX	C00001226P520S	1		
R532	nsp	100K-J,1/5W-52RE-AX	C00001046P520S	1		
R534	nsp	RSD-R0-1WJ-4.7K 3*9 P=5MM SMALL R.REEL	N113135647230S	1		
R536	nsp	1.2K-J,1/5W-52RE-AX	C00001226P520S	1		
R537	963252100140D	DHPH1608 471P 105T SMD PTC THERMISTOR	F320471001050S	1		
R538	nsp	RSD-R0-1WJ-4.7K 3*9 P=5MM SMALL R.REEL	N113135647230S	1		
R539	nsp	150K-J,1/5W-52RE-AX	C00001546P520S	1		
R541	nsp	200K-J,1/5W-52RE-AX	C00002046P520S	1		
R542	963121006330M	47K-J,1/5W-52RE-AX	C00004736P520S	1		
R543,544	nsp	10K-J,1/5W-52RE-AX	C00001036P520S	2		
R545	963125012630S	22-J,1W-5REEL	C060022065050S	1		
R546	nsp	22K-J,1/5W-52RE-AX	C00002236P520S	1		
R547	nsp	270K-J,1/16W-1608REEL	C20002746M160S	1		
R549	nsp	22K-J,1/5W-52RE-AX	C00002236P520S	1		
R551	00D9639005639	100-J,1W-R.REEL	C060010165060S	1		
R552	nsp	470-J,1/5W-52RE-AX	C00004716P520S	1		
R553	nsp	10K-J,1/16W-1608REEL	C20001036M160S	1		
R554,555	00D9630345903	RSD-R1-2WJ-0.47 3.5*8.6 P=5MM SMALL R.REEL	N113136647820S	2		
R556	nsp	5.6K-J,1/16W-1608REEL	C20005626M160S	1		
R557	nsp	1.2K-J,1/5W-52RE-AX	C00001226P520S	1		
R559	nsp	33K-J,1/5W-52RE-AX	C00003336P520S	1		
R560	nsp	2.7K-J,1/5W-52RE-AX	C00002726P520S	1		
R561,562	00D9630345903	RSD-R1-2WJ-0.47 3.5*8.6 P=5MM SMALL R.REEL	N113136647820S	2		
R564	nsp	3.3K-J,1W-R.REEL	C060033265050S	1		
R565	nsp	560-J,1/5W-52RE-AX	C00005616P520S	1		
R566	nsp	470K-J,1/5W-52RE-AX	C00004746P520S	1		
R567	nsp	33K-J,1/5W-52RE-AX	C00003336P520S	1		
R568	nsp	220-J,1/5W-52RE-AX	C00002216P520S	1		
R569	963125012630S	22-J,1W-5REEL	C060022065050S	1		
R570	nsp	150-J,1/5W-52RE-AX	C00001516P520S	1		
R571,572	nsp	1.2K-J,1W-5REEL	C060012265050S	2		
R573	nsp	47-J,1W-R.REEL	C060047065060S	1		
R574	nsp	1.2K-J,1/5W-52RE-AX	C00001226P520S	1		
R575	nsp	100K-J,1/5W-52RE-AX	C00001046P520S	1		
R577	nsp	RSD-R0-1WJ-4.7K 3*9 P=5MM SMALL R.REEL	N113135647230S	1		
R580	963252100140D	DHPH1608 471P 105T SMD PTC THERMISTOR	F320471001050S	1		
R581	nsp	RSD-R0-1WJ-4.7K 3*9 P=5MM SMALL R.REEL	N113135647230S	1		
R582	nsp	150K-J,1/5W-52RE-AX	C00001546P520S	1		
R584	nsp	200K-J,1/5W-52RE-AX	C00002046P520S	1		
R585	963121006330M	47K-J,1/5W-52RE-AX	C00004736P520S	1		
R586,587	nsp	10K-J,1/16W-1608REEL	C20001036M160S	2		
R588	963125012630S	22-J,1W-5REEL	C060022065050S	1		
R589	nsp	22K-J,1/5W-52RE-AX	C00002236P520S	1		
R590	nsp	270K-J,1/16W-1608REEL	C20002746M160S	1		
R592	nsp	22K-J,1/5W-52RE-AX	C00002236P520S	1		
R595	nsp	470-J,1/5W-52RE-AX	C00004716P520S	1		
R596	nsp	10K-J,1/16W-1608REEL	C20001036M160S	1		
R597,598	00D9630345903	RSD-R1-2WJ-0.47 3.5*8.6 P=5MM SMALL R.REEL	N113136647820S	2		
R599	nsp	5.6K-J,1/16W-1608REEL	C20005626M160S	1		
R600	nsp	1.2K-J,1/5W-52RE-AX	C00001226P520S	1		

REF No.	Part No.	Part Name	Remarks	Q'ty	New	Ver
R602	nsp	33K-J,1/5W-52RE-AX		C00003336P520S	1	
R603.604	00D9630345903	RSD-R1-2WJ-0.47 3.5*8.6 P=5MM SMALL R.REEL		N113136647820S	2	
R605	nsp	2.7K-J,1/5W-52RE-AX		C00002726P520S	1	
R607	nsp	3.3K-J,1W-R.REEL		C060033265050S	1	
R608	nsp	560-J,1/5W-52RE-AX		C00005616P520S	1	
R609	nsp	470K-J,1/5W-52RE-AX		C00004746P520S	1	
R610	nsp	33K-J,1/5W-52RE-AX		C00003336P520S	1	
R611	nsp	220-J,1/5W-52RE-AX		C00002216P520S	1	
R612	963125012630S	22-J,1W-5REEL		C060022065050S	1	
R613	nsp	150-J,1/5W-52RE-AX		C00001516P520S	1	
R614.615	nsp	1.2K-J,1W-5REEL		C060012265050S	2	
R616	nsp	47-J,1W-R.REEL		C060047065060S	1	
R617	nsp	1.2K-J,1/5W-52RE-AX		C00001226P520S	1	
R618	nsp	100K-J,1/5W-52RE-AX		C00001046P520S	1	
R620	nsp	RSD-R0-1WJ-4.7K 3*9 P=5MM SMALL R.REEL		N113136647230S	1	
R623	963252100140D	DHPH1608 471P 105T SMD PTC THERMISTOR		F320471001050S	1	
R624	nsp	RSD-R0-1WJ-4.7K 3*9 P=5MM SMALL R.REEL		N113136647230S	1	
R625	nsp	150K-J,1/5W-52RE-AX		C00001546P520S	1	
R627	nsp	200K-J,1/5W-52RE-AX		C00002046P520S	1	
R628	963121006330M	47K-J,1/5W-52RE-AX		C00004736P520S	1	
R629.630	nsp	10K-J,1/5W-52RE-AX		C00001036P520S	2	
R631	963125012630S	22-J,1W-5REEL		C060022065050S	1	
R632	nsp	22K-J,1/5W-52RE-AX		C00002236P520S	1	
R633	nsp	270K-J,1/16W-1608REEL		C20002746M160S	1	
R635	nsp	22K-J,1/5W-52RE-AX		C00002236P520S	1	
R638	nsp	470-J,1/5W-52RE-AX		C00004716P520S	1	
R639	nsp	10K-J,1/16W-1608REEL		C20001036M160S	1	
R640.641	00D9630345903	RSD-R1-2WJ-0.47 3.5*8.6 P=5MM SMALL R.REEL		N113136647820S	2	
R642	nsp	5.6K-J,1/16W-1608REEL		C20005626M160S	1	
R643	nsp	1.2K-J,1/5W-52RE-AX		C00001226P520S	1	
R645	nsp	33K-J,1/5W-52RE-AX		C00003336P520S	1	
R646.647	00D9630345903	RSD-R1-2WJ-0.47 3.5*8.6 P=5MM SMALL R.REEL		N113136647820S	2	
R648	nsp	2.7K-J,1/5W-52RE-AX		C00002726P520S	1	
R650	nsp	3.3K-J,1W-R.REEL		C060033265050S	1	
R651	nsp	560-J,1/5W-52RE-AX		C00005616P520S	1	
R652	nsp	470K-J,1/5W-52RE-AX		C00004746P520S	1	
R653	nsp	33K-J,1/5W-52RE-AX		C00003336P520S	1	
R654	nsp	220-J,1/5W-52RE-AX		C00002216P520S	1	
R655	963125012630S	22-J,1W-5REEL		C060022065050S	1	
R656	nsp	150-J,1/5W-52RE-AX		C00001516P520S	1	
R657.658	nsp	1.2K-J,1W-5REEL		C060012265050S	2	
R659	nsp	47-J,1W-R.REEL		C060047065060S	1	
R660	nsp	1.2K-J,1/5W-52RE-AX		C00001226P520S	1	
R661	nsp	100K-J,1/5W-52RE-AX		C00001046P520S	1	
R663	nsp	RSD-R0-1WJ-4.7K 3*9 P=5MM SMALL R.REEL		N113136647230S	1	
R666	963252100140D	DHPH1608 471P 105T SMD PTC THERMISTOR		F320471001050S	1	
R667	nsp	RSD-R0-1WJ-4.7K 3*9 P=5MM SMALL R.REEL		N113136647230S	1	
R668	nsp	150K-J,1/5W-52RE-AX		C00001546P520S	1	
R670	nsp	200K-J,1/5W-52RE-AX		C00002046P520S	1	
R671	963121006330M	47K-J,1/5W-52RE-AX		C00004736P520S	1	
R672.673	nsp	10K-J,1/5W-52RE-AX		C00001036P520S	2	
R674	963125012630S	22-J,1W-5REEL		C060022065050S	1	
R675	nsp	22K-J,1/5W-52RE-AX		C00002236P520S	1	
R676	nsp	270K-J,1/16W-1608REEL		C20002746M160S	1	
R678	nsp	22K-J,1/5W-52RE-AX		C00002236P520S	1	
R681	nsp	470-J,1/5W-52RE-AX		C00004716P520S	1	
R682	nsp	10K-J,1/16W-1608REEL		C20001036M160S	1	
R683.684	00D9630345903	RSD-R1-2WJ-0.47 3.5*8.6 P=5MM SMALL R.REEL		N113136647820S	2	
R685	nsp	5.6K-J,1/16W-1608REEL		C20005626M160S	1	
R686	nsp	1.2K-J,1/5W-52RE-AX		C00001226P520S	1	
R688	nsp	33K-J,1/5W-52RE-AX		C00003336P520S	1	
R689.690	00D9630345903	RSD-R1-2WJ-0.47 3.5*8.6 P=5MM SMALL R.REEL		N113136647820S	2	
R691	nsp	2.7K-J,1/5W-52RE-AX		C00002726P520S	1	
R693	nsp	560-J,1/5W-52RE-AX		C00005616P520S	1	
R694	nsp	3.3K-J,1W-R.REEL		C060033265050S	1	
R695	nsp	470K-J,1/5W-52RE-AX		C00004746P520S	1	
R696	nsp	33K-J,1/5W-52RE-AX		C00003336P520S	1	
R697	nsp	220-J,1/5W-52RE-AX		C00002216P520S	1	
R698	963125012630S	22-J,1W-5REEL		C060022065050S	1	
R699	nsp	150-J,1/5W-52RE-AX		C00001516P520S	1	
R700.701	nsp	1.2K-J,1W-5REEL		C060012265050S	2	
R702	nsp	47-J,1W-R.REEL		C060047065060S	1	
R703-709	nsp	1.2K-J,1/5W-52RE-AX		C00001226P520S	7	
R717-723	nsp	220-J,1/5W-52RE-AX		C00002216P520S	7	
R731.732	nsp	10K-J,1/16W-1608REEL		C20001036M160S	2	
<b>CAPACITORS GROUP</b>						
C401	nsp	X7R)0.1UF-K/50V-1608REEL		D011104577160S	1	
C403	nsp	X7R)0.01UF-K/50V-1608REEL		D010103777160S	1	
C404	13405014740AS	220UF-M/50V,10*12.5 KR3-050V221MG125-T/A5.0 KOSHIN		D040221087150S	1	*
C405	nsp	COG100PF-J/50V-1608REEL		D010101167160S	1	
C406	963133501540S	ST-0.00022UF-J/100V-5RE		D02022106C050S	1	
C407	13405013040AS	220UF-M/25V,8*11.5 KR3-025V221MF115-T/A5.0S KOSHIN		D040221084550S	1	*
C408	00D2544583971	47UF-M/50V,8*11.5-5RE ROB-50V470MG3#9-T2		D040470087140S	1	
C410	963133502020S	470UF-M/16V,8*11.5 KR3-016V471MF115-T/A5.0S KOSHIN		D040471083550S	1	*
C412	963133501550S	ST-0.00047UF-J/100V-5RE (S&A)		D02047106C060S	1	
C413	nsp	X7R2200PF-K/50V-2012REEL		D011222777200S	1	
C415.416	00D9630234302	10UF-M/100V,6.3*11-5RE,SMS SY		D04010008C050S	2	
C418	nsp	X7R)0.1UF-K/50V-1608REEL		D011104577160S	1	
C419	00D963032400S	100UF-M/100V,10*16-S,BULK,MHA-SY		D04010108C240S	1	
C420	13405014740AS	220UF-M/50V,10*12.5 KR3-050V221MG125-T/A5.0 KOSHIN		D040221087150S	1	*
C421	nsp	COG100PF-J/50V-1608REEL		D010101167160S	1	
C422	963133501540S	ST-0.00022UF-J/100V-5RE		D02022106C050S	1	
C423	13405013040AS	220UF-M/25V,8*11.5 KR3-025V221MF115-T/A5.0S KOSHIN		D040221084550S	1	*
C424	00D2544583971	47UF-M/50V,8*11.5-5RE ROB-50V470MG3#9-T2		D040470087140S	1	
C426	963133502020S	470UF-M/16V,8*11.5 KR3-016V471MF115-T/A5.0S KOSHIN		D040471083550S	1	*
C428	963133501550S	ST-0.00047UF-J/100V-5RE (S&A)		D02047106C060S	1	
C429	nsp	X7R2200PF-K/50V-2012REEL		D011222777200S	1	
C434	nsp	X7R)0.1UF-K/50V-1608REEL		D011104577160S	1	
C436	13405014740AS	220UF-M/50V,10*12.5 KR3-050V221MG125-T/A5.0 KOSHIN		D040221087150S	1	*
C437	nsp	COG100PF-J/50V-1608REEL		D010101167160S	1	
C438	963133501540S	ST-0.00022UF-J/100V-5RE		D02022106C050S	1	
C439	13405013040AS	220UF-M/25V,8*11.5 KR3-025V221MF115-T/A5.0S KOSHIN		D040221084550S	1	*



REF No.	Part No.	Part Name	Remarks	Q'ty	New	Ver
C440	00D2544583971	47UF-M/50V,8*11.5-5RE ROB-50V470MG3#9-T2		D040470087140S	1	
C442	963133502020S	470UF-M/16V,8*11.5 KR3-016V471MF115-T/A5.0S KOSHIN		D040471083550S	1	*
C444	963133501550S	ST-0.00047UF-J/100V-5RE (S&A)		D02047106C060S	1	
C445	nsp	X7R2200PF-K/50V-2012REEL		D01122277200S	1	
C450	nsp	X7R)0.1UF-K/50V-1608REEL		D011104577160S	1	
C452	13405014440AS	100UF-M/50V,8*11.5 KR3-050V101MF115-T/A5.0S KOSHIN		D040101087550S	1	*
C453	nsp	COG100PF-J/50V-1608REEL		D010101167160S	1	
C454	963133501540S	ST-0.00022UF-J/100V-5RE		D02022106C050S	1	
C455	13405013040AS	220UF-M/25V,8*11.5 KR3-025V221MF115-T/A5.0S KOSHIN		D040221084550S	1	*
C456	00D2544583971	47UF-M/50V,8*11.5-5RE ROB-50V470MG3#9-T2		D040470087140S	1	
C458	963133502020S	470UF-M/16V,8*11.5 KR3-016V471MF115-T/A5.0S KOSHIN		D040471083550S	1	*
C460	963133501550S	ST-0.00047UF-J/100V-5RE (S&A)		D02047106C060S	1	
C461	nsp	X7R2200PF-K/50V-2012REEL		D01122277200S	1	
C466	nsp	X7R)0.1UF-K/50V-1608REEL		D011104577160S	1	
C468	13405014440AS	100UF-M/50V,8*11.5 KR3-050V101MF115-T/A5.0S KOSHIN		D040101087550S	1	*
C469	nsp	COG100PF-J/50V-1608REEL		D010101167160S	1	
C470	963133501540S	ST-0.00022UF-J/100V-5RE		D02022106C050S	1	
C471	13405013040AS	220UF-M/25V,8*11.5 KR3-025V221MF115-T/A5.0S KOSHIN		D040221084550S	1	*
C472	00D2544583971	47UF-M/50V,8*11.5-5RE ROB-50V470MG3#9-T2		D040470087140S	1	
C474	963133502020S	470UF-M/16V,8*11.5 KR3-016V471MF115-T/A5.0S KOSHIN		D040471083550S	1	*
C476	963133501550S	ST-0.00047UF-J/100V-5RE (S&A)		D02047106C060S	1	
C477	nsp	X7R2200PF-K/50V-2012REEL		D01122277200S	1	
C479,480	00D9630234302	10UF-M/100V,6.3*11-5RE,SMS SY		D04010008C050S	2	
C482	nsp	X7R)0.1UF-K/50V-1608REEL		D011104577160S	1	
C484	13405014440AS	100UF-M/50V,8*11.5 KR3-050V101MF115-T/A5.0S KOSHIN		D040101087550S	1	*
C485	nsp	COG100PF-J/50V-1608REEL		D010101167160S	1	
C486	963133501540S	ST-0.00022UF-J/100V-5RE		D02022106C050S	1	
C487	13405013040AS	220UF-M/25V,8*11.5 KR3-025V221MF115-T/A5.0S KOSHIN		D040221084550S	1	*
C488	00D2544583971	47UF-M/50V,8*11.5-5RE ROB-50V470MG3#9-T2		D040470087140S	1	
C490	963133502020S	470UF-M/16V,8*11.5 KR3-016V471MF115-T/A5.0S KOSHIN		D040471083550S	1	*
C492	963133501550S	ST-0.00047UF-J/100V-5RE (S&A)		D02047106C060S	1	
C493	nsp	X7R2200PF-K/50V-2012REEL		D01122277200S	1	
C498	nsp	X7R)0.1UF-K/50V-1608REEL		D011104577160S	1	
C500	13405014440AS	100UF-M/50V,8*11.5 KR3-050V101MF115-T/A5.0S KOSHIN		D040101087550S	1	*
C501	nsp	COG100PF-J/50V-1608REEL		D010101167160S	1	
C502	963133501540S	ST-0.00022UF-J/100V-5RE		D02022106C050S	1	
C503	13405013040AS	220UF-M/25V,8*11.5 KR3-025V221MF115-T/A5.0S KOSHIN		D040221084550S	1	*
C504	00D2544583971	47UF-M/50V,8*11.5-5RE ROB-50V470MG3#9-T2		D040470087140S	1	
C506	963133502020S	470UF-M/16V,8*11.5 KR3-016V471MF115-T/A5.0S KOSHIN		D040471083550S	1	*
C508	963133501550S	ST-0.00047UF-J/100V-5RE (S&A)		D02047106C060S	1	
C509	nsp	X7R2200PF-K/50V-2012REEL		D01122277200S	1	
C511,512	00D9630234302	10UF-M/100V,6.3*11-5RE,SMS SY		D04010008C050S	2	
C513,514	00D9630338402	330UF-M/6.3V,6.3*11-5RE,SMS SY		D040331081050S	2	
C515	00D9630324607	47UF-M/10V,5*11-5RE,SMS SY (Pb Free)		D040470082060S	1	
<b>OTHER PARTS GROUP</b>						
BKT400	nsp	AVR133(HARMAN) BURREING HOLE SPTE 0.8t/SCREW		4010210196100S	1	
CN404	nsp	160MM/7P 20010HS-07=CKM2002HV-07 YW1007#26		L002161070090S	1	
CP401	nsp	20010WS-13A00 DIP13P STRAIGHT		L101200101310S	1	
CP402	nsp	YMW025-05R DIP ST		L102025050020S	1	
CP403	nsp	20010WS-10A00 DIP10P STRAIGHT		L101200101010S	1	
CP405	nsp	YMW025-03R DIP ST		L102025030020S	1	
G400	nsp	70MM/1P CKM9919T*2 BK1007#20		L000700010150S	1	
G402	nsp	70MM/1P CKM9919T*2 BK1007#20		L000700010150S	1	
TP401-407	nsp	20010WR-03A00 DIP3P RIGHT ANGLE		L101200100320S	7	
VR401-407	963161012400S	EVN-DCAA03B13/REEL 1KB		C541102315000S	7	

## HDMI PCB ASS'Y

※Parts indicated by "nsp" on this table cannot be supplied.

※The parts listed below are only for maintenance. Therefore they might differ from the parts used in the unit in appearances or dimensions.

NOTE: The symbols in the column Remarks indicate the following destinations.

E3 : U.S.A. &amp; Canada model E2 : Europe model E1C : China model E1 : Asia model K : Japan model

BK : Black model SP : Silver gold model

REF No.	Part No.	Part Name	Remarks	Q'ty	New	Ver
<b>SEMICONDUCTORS GROUP</b>						
D1024	963204500220D	LRB521S-30T1G SOD523 SCHOTTKY BARRIER DIODE		K125521305230S	1	
D1089	963204500220D	LRB521S-30T1G SOD523 SCHOTTKY BARRIER DIODE		K125521305230S	1	
D1090	963204500220D	LRB521S-30T1G SOD523 SCHOTTKY BARRIER DIODE	X2100E3	K125521305230S	1	
D1091	963201500170D	LBAS16HT1G FAST SWITCHING SOD-323	X2100E3	K005041480230S	1	
D1093	963204500220D	LRB521S-30T1G SOD523 SCHOTTKY BARRIER DIODE	X2100E3	K125521305230S	1	
D1096	963201500170D	LBAS16HT1G FAST SWITCHING SOD-323		K005041480230S	1	
D1103-1105	963201500170D	LBAS16HT1G FAST SWITCHING SOD-323		K005041480230S	3	
D1138	00D2760739907	KDS181S(B)-THICK SOT-23		K005018100040S	1	
IC6000	963239101330S	TC7SGU04FU SSOP5-P-0.65A INVERTER(UNBUFFERED)		J040704000210S	1	*
Q1000	943216500020S	RT1N141C 0.2W/SC-59 ISAHAYA		J522101411210S	1	
Q1001	943216500050S	RT1N441C 0.2W/SC-59 ISAHAYA		J522104411210S	1	
Q1002	943216500020S	RT1N141C 0.2W/SC-59 ISAHAYA		J522101411210S	1	
Q1003	943216500050S	RT1N441C 0.2W/SC-59 ISAHAYA		J522104411210S	1	
Q1004	943216500020S	RT1N141C 0.2W/SC-59 ISAHAYA		J522101411210S	1	
Q1005	943216500050S	RT1N441C 0.2W/SC-59 ISAHAYA		J522104411210S	1	
Q1006-1009	943216500020S	RT1N141C 0.2W/SC-59 ISAHAYA		J522101411210S	4	
Q1010	943216500050S	RT1N441C 0.2W/SC-59 ISAHAYA		J522104411210S	1	
Q1011	943216500020S	RT1N141C 0.2W/SC-59 ISAHAYA		J522101411210S	1	
Q1012	943216500050S	RT1N441C 0.2W/SC-59 ISAHAYA		J522104411210S	1	
Q1013	943216500020S	RT1N141C 0.2W/SC-59 ISAHAYA		J522101411210S	1	
Q1014	943216500050S	RT1N441C 0.2W/SC-59 ISAHAYA		J522104411210S	1	
Q1015	943216500020S	RT1N141C 0.2W/SC-59 ISAHAYA		J522101411210S	1	
Q1016,1017	943216500050S	RT1N441C 0.2W/SC-59 ISAHAYA		J522104411210S	2	
Q1018,1019	943214500020S	2SC3052 0.15W/SC-59 REEL ISAHAYA		J522305200050S	2	
Q1022-1029	943214500020S	2SC3052 0.15W/SC-59 REEL ISAHAYA		J522305200050S	8	
Q1030,1031	963212500030S	ISA1530AC1 0.2W/SC-59 ISAHAYA		J520015301210S	2	
Q1032	943216500020S	RT1N141C 0.2W/SC-59 ISAHAYA		J522101411210S	1	
Q1035	943215500030S	RT1P441C 0.2W/SC-59 ISAHAYA	X2100E3	J520104411210S	1	
Q1036	943214500020S	2SC3052 0.15W/SC-59 REEL ISAHAYA	X2100E3	J522305200050S	1	
Q1038	963219002180S	2SD2114KT146W SMT3 SOT23-REEL		J5232114K0010S	1	
Q1039,1040	943214500020S	2SC3052 0.15W/SC-59 REEL ISAHAYA		J522305200050S	2	
Q1041	943216500020S	RT1N141C 0.2W/SC-59 ISAHAYA		J522101411210S	1	
Q1043	943216500020S	RT1N141C 0.2W/SC-59 ISAHAYA		J522101411210S	1	
Q1046	943216500020S	RT1N141C 0.2W/SC-59 ISAHAYA		J522101411210S	1	
Q1047	943216500050S	RT1N441C 0.2W/SC-59 ISAHAYA		J522104411210S	1	
Q1050	943216500050S	RT1N441C 0.2W/SC-59 ISAHAYA		J522104411210S	1	
Q1051	963219004200S	FDC608PZ P-CH 2.5V MOSFET SOT6		J543608000010S	1	
Q1052	943214500020S	2SC3052 0.15W/SC-59 REEL ISAHAYA		J522305200050S	1	
Q1055	963211500160D	PBSS5140U SOT323 40V LOW VCEsat PNP TR		J521051401010S	1	
Q1056	943216500020S	RT1N141C 0.2W/SC-59 ISAHAYA		J522101411210S	1	
Q1057	943216500050S	RT1N441C 0.2W/SC-59 ISAHAYA		J522104411210S	1	
Q1058	963219004200S	FDC608PZ P-CH 2.5V MOSFET SOT6		J543608000010S	1	
Q1059	963211500160D	PBSS5140U SOT323 40V LOW VCEsat PNP TR		J521051401010S	1	
Q1060	943216500020S	RT1N141C 0.2W/SC-59 ISAHAYA		J522101411210S	1	
Q1062	943216500050S	RT1N441C 0.2W/SC-59 ISAHAYA		J522104411210S	1	
Q1063	963219004200S	FDC608PZ P-CH 2.5V MOSFET SOT6		J543608000010S	1	
Q1064	963211500160D	PBSS5140U SOT323 40V LOW VCEsat PNP TR		J521051401010S	1	
Q1065	943216500020S	RT1N141C 0.2W/SC-59 ISAHAYA		J522101411210S	1	
Q1066	943216500050S	RT1N441C 0.2W/SC-59 ISAHAYA		J522104411210S	1	
Q1067	963219004200S	FDC608PZ P-CH 2.5V MOSFET SOT6		J543608000010S	1	
Q1070	943216500050S	RT1N441C 0.2W/SC-59 ISAHAYA		J522104411210S	1	
Q1071	963219004200S	FDC608PZ P-CH 2.5V MOSFET SOT6		J543608000010S	1	
Q1072	963211500160D	PBSS5140U SOT323 40V LOW VCEsat PNP TR		J521051401010S	1	
Q1073	943216500020S	RT1N141C 0.2W/SC-59 ISAHAYA		J522101411210S	1	
U1000	963236101810S	MN8647781 HDMI 2.0 HQFP144P		J04086477810S	1	*
U1001	00D2623436907	TC74VHC244FT OCTAL BUS BUFFER TSSOP20		J040742445530S	1	
U1002	963239101350S	SN74CBT3251PWR TSSOP16 FET MUX/DEMUX		J040743251030S	1	*
U1003	963236101810S	MN8647781 HDMI 2.0 HQFP144P		J04086477810S	1	*
U1004	00D2623436907	TC74VHC244FT OCTAL BUS BUFFER TSSOP20		J040742445530S	1	
U1005	23671011050AS	MFI337S3959 COPROCESSOR(IPOD) DENON SAGUB		J044337395910S	1	*
U1007,1008	963644101940S	PIN HEADER 1.27MM 64P GPEC244-3202 B002 B1 AD		L424244640200S	2	*
U1016	963239101340S	TC74VHC125F5T1-TBB TSSOP14P QUAD BUS BUFFER		J040741250200S	1	*
U1017	963239101320S	R1EX24128BSA01 128Kbit SERIAL SOP8 RENESAS		J000241282010S	1	*
U1018	-	R5F56108VNFPP 32BIT MICROCOMPUTER P-LQFP144 RENESAS		J020610005510S	1	
U1018 L	963243102070D	R5F56108VNFPP 32BIT	E3/E2/E1/K	895221000070	1	Ver.2
U1018 L	963243102080D	R5F56108VNFPP 32BIT	E1C	895221000060	1	Ver.2
U1020	-	R5F5210ABDFP (ROM768kB RAM96kB) P-LQFP100 RENESAS		J020552102010S	1	
L	963243102240S	R5F5210ABDFP		895221000080	1	
U1022	nsp	AD8195 HDMI/DVI BUFFER EQ LFCSP40		J040819505510S	1	
U1023	943246012690S	W9864G6JH-6 1M*4BANKS*16BIT(64MB) TSOP54		J001986466010S	1	*
U1024	963245100490S	ADSP21487KSWZ-3B3078 SHARC PROCESSOR LQFP176	X2100	J080214875610S	1	*
U1024	963245100500S	ADSP21487KSWZ-3B3079 SHARC PROCESSOR LQFP176	S900	J080214875620S	1	*
U1025	-	MX25L1606EM21-12G 16M CMOS SERIAL FLASH SOP8		J005251601210S	1	
U1025 L	963246100980S	MX25L1606EM21-12G 16M		895221000090	1	
U1026	23681016160AS	ADV8003KBCZ-8B (AD55/058Z-0)		J045800305010S	1	*
U1027	-	MX25L1283FMI-10G 128M SERIAL FLASH SOP16		J005251281060S	1	
U1027 L	963246100990S	MX25L1283FMI-10G 128M		8952210000100	1	
U1028,1029	963246101010S	A3R12E40CBF-8E 512Mb DDR2 SDRAM FBGA84		J001030124080S	2	*
U1030	943239010400S	NJM2845DL1-33 3.3V TO-252-3 LOW-DROP VOL REGULATOR		J126284533010S	1	
U1032	943239010400S	NJM2845DL1-33 3.3V TO-252-3 LOW-DROP VOL REGULATOR		J126284533010S	1	
U1033	943239100730S	PST8448UR SYSTEM RESET SC-82AB MITSUMI		J125844800010S	1	
U1039	963236101810S	MN8647781 HDMI 2.0 HQFP144P		J04086477810S	1	*
U1040	23681014050AS	PCM9211 TRANSCEIVER LQFP48		J046921100010S	1	
U1041	-	5M80ZT100C5N TQFP100		J003058010050S	1	
U1041 L	963239101390S	5M80ZT100C5N TQFP100		8952210000110	1	
U1042	00D2623077900	TC74VHC04FT HEX INVERTER TSSOP14	E3	J040740405580S	1	
U1043,1044	963239101100S	BCR-802-M25 25MBPS OPTICAL RECEIVER INTERFACE		E100802000250S	2	
U1045	-	5M80ZT100C5N TQFP100		J003058010050S	1	
U1045 L	963239101400S	5M80ZT100C5N TQFP100		8952210000120	1	
U1048	nsp	PCM1690 HTSSOP48		J042169000010S	1	
U1050	943239010400S	NJM2845DL1-33 3.3V TO-252-3 LOW-DROP VOL REGULATOR		J126284533010S	1	
U1052	943239100690S	PCM5100 TSSOP20 AUDIO STEREO DAC		J042510005510S	1	
U1055	963236101220D	ADV7850 HDMI 1.4A RECEIVER BGA425		J040785005510S	1	
U1061-1070	963239101370S	EN5339Q1 3A BUCK PWM DC-DC QFN24P		J048533900010S	10	*

REF No.	Part No.	Part Name	Remarks	Q'ty	New	Ver
U6000	943639101380D	iBT-06-02S BT MODULE CLASS2 V2.1+EDR HCI INTERFACE	E100070060020S	1	*	
U6001	963239101380S	BD00HA3MEFJ-ME2 HTSOP-J8 LDO REGULATOR 0.3A	J12600000030S	1	*	
<b>RESISTOR GROUP</b>						
R1000	nsp	0-J,1/16W-1005REEL	C20000006M101S	1		
R1001	nsp	47K-J,1/16W-1005REEL	C20004736M101S	1		
R1006	nsp	10K-J,1/16W-1005REEL	C20001036M111S	1		
R1010,1011	nsp	47K-J,1/16W-1005REEL	C20004736M101S	2		
R1012	nsp	10-J,1/16W-1005REEL	C20001006M101S	1		
R1013	nsp	1K-J,1/16W-1005REEL	C20001026M101S	1		
R1014	nsp	10K-J,1/16W-1005REEL	C20001036M111S	1		
R1015,1016	nsp	47K-J,1/16W-1005REEL	C20004736M101S	2		
R1017	nsp	0-J,1/16W-1005REEL	C20000006M101S	1		
R1018	nsp	47K-J,1/16W-1005REEL	C20004736M101S	1		
R1019	nsp	0-J,1/16W-1005REEL	C20000006M101S	1		
R1020	nsp	47-J,1/16W-1005REEL	C20004706M101S	1		
R1021	nsp	0-J,1/16W-1005REEL	C20000006M101S	1		
R1022	nsp	47-J,1/16W-1005REEL	C20004706M101S	1		
R1024,1025	nsp	47-J,1/16W-1005REEL	C20004706M101S	2		
R1027	nsp	47-J,1/16W-1005REEL	C20004706M101S	1		
R1029	nsp	47-J,1/16W-1005REEL	C20004706M101S	1		
R1031	nsp	510-D,1/16W-1608REEL	C20005111M161S	1		
R1033	nsp	10K-J,1/16W-1005REEL	C20001036M111S	1		
R1037	nsp	510-D,1/16W-1608REEL	C20005111M161S	1		
R1038	nsp	1K-J,1/16W-1005REEL	C20001026M101S	1		
R1039	nsp	10K-J,1/16W-1005REEL	C20001036M111S	1		
R1040,1041	nsp	47K-J,1/16W-1005REEL	C20004736M101S	2		
R1042	nsp	0-J,1/16W-1005REEL	C20000006M101S	1		
R1043	nsp	47K-J,1/16W-1005REEL	C20004736M101S	1		
R1044,1045	nsp	0-J,1/16W-1005REEL	C20000006M101S	2		
R1052	nsp	1.8K-J,1/16W-1005REEL	C20001826M101S	1		
R1053	nsp	0-J,1/16W-1005REEL	C20000006M101S	1		
R1055	nsp	1.8K-J,1/16W-1005REEL	C20001826M101S	1		
R1057,1058	nsp	1.8K-J,1/16W-1005REEL	C20001826M101S	2		
R1059-1062	nsp	47-J,1/16W-1005REEL	C20004706M101S	4		
R1063	nsp	1M-J,1/16W-1005REEL	C20001056M101S	1		
R1064	nsp	10K-J,1/16W-1005REEL	C20001036M111S	1		
R1068	nsp	10K-J,1/16W-1005REEL	C20001036M111S	1		
R1069	nsp	1K-J,1/16W-1005REEL	C20001026M101S	1		
R1070	nsp	10K-J,1/16W-1005REEL	C20001036M111S	1		
R1071,1072	nsp	47K-J,1/16W-1005REEL	C20004736M101S	2		
R1074	nsp	47K-J,1/16W-1005REEL	C20004736M101S	1		
R1075	nsp	0-J,1/16W-1005REEL	C20000006M101S	1		
R1076	nsp	47K-J,1/16W-1005REEL	C20004736M101S	1		
R1077-1079	nsp	4.7K-J,1/16W-1005REEL	C20004726M101S	3		
R1080	nsp	1K-J,1/16W-1005REEL	C20001026M101S	1		
R1081,1082	nsp	0-J,1/16W-1005REEL	C20000006M101S	2		
R1083	nsp	47K-J,1/16W-1005REEL	C20004736M101S	1		
R1084,1085	nsp	33-J,1/16W-1005REEL	C20003306M101S	2		
R1086	nsp	47K-J,1/16W-1005REEL	C20004736M101S	1		
R1087,1088	nsp	33-J,1/16W-1005REEL	C20003306M101S	2		
R1090,1091	nsp	33-J,1/16W-1005REEL	C20003306M101S	2		
R1094	nsp	33-J,1/16W-1005REEL	C20003306M101S	1		
R1095	nsp	0-J,1/16W-1005REEL	C20000006M101S	1		
R1096	nsp	2.2K-J,1/16W-1005REEL	C20002226M101S	1		
R1097	nsp	0-J,1/16W-1005REEL	C20000006M101S	1		
R1099	nsp	3.3K-J,1/16W-1005REEL	C20003326M101S	1		
R1101	nsp	1K-J,1/16W-1005REEL	C20001026M101S	1		
R1102	nsp	10K-J,1/16W-1005REEL	C20001036M111S	1		
R1103,1104	nsp	47K-J,1/16W-1005REEL	C20004736M101S	2		
R1105	nsp	0-J,1/16W-1005REEL	C20000006M101S	1		
R1106	nsp	47K-J,1/16W-1005REEL	C20004736M101S	1		
R1107,1108	nsp	0-J,1/16W-1005REEL	C20000006M101S	2		
R1117	nsp	10K-J,1/16W-1005REEL	C20001036M111S	1		
R1118,1119	nsp	47K-J,1/16W-1005REEL	C20004736M101S	2		
R1120	nsp	10-J,1/16W-1005REEL	C20001006M101S	1		
R1121	nsp	1K-J,1/16W-1005REEL	C20001026M101S	1		
R1122	nsp	10K-J,1/16W-1005REEL	C20001036M111S	1		
R1123,1124	nsp	47K-J,1/16W-1005REEL	C20004736M101S	2		
R1125	nsp	0-J,1/16W-1005REEL	C20000006M101S	1		
R1126	nsp	47K-J,1/16W-1005REEL	C20004736M101S	1		
R1127	nsp	0-J,1/16W-1005REEL	C20000006M101S	1		
R1128	nsp	47-J,1/16W-1005REEL	C20004706M101S	1		
R1129	nsp	0-J,1/16W-1005REEL	C20000006M101S	1		
R1130	nsp	47-J,1/16W-1005REEL	C20004706M101S	1		
R1132,1133	nsp	47-J,1/16W-1005REEL	C20004706M101S	2		
R1135	nsp	47-J,1/16W-1005REEL	C20004706M101S	1		
R1137	nsp	47-J,1/16W-1005REEL	C20004706M101S	1		
R1139	nsp	510-D,1/16W-1608REEL	C20005111M161S	1		
R1141	nsp	10K-J,1/16W-1005REEL	C20001036M111S	1		
R1145	nsp	510-D,1/16W-1608REEL	C20005111M161S	1		
R1146	nsp	1K-J,1/16W-1005REEL	C20001026M101S	1		
R1147	nsp	10K-J,1/16W-1005REEL	C20001036M111S	1		
R1148,1149	nsp	47K-J,1/16W-1005REEL	C20004736M101S	2		
R1150	nsp	0-J,1/16W-1005REEL	C20000006M101S	1		
R1151	nsp	47K-J,1/16W-1005REEL	C20004736M101S	1		
R1152,1153	nsp	0-J,1/16W-1005REEL	C20000006M101S	2		
R1160	nsp	1.8K-J,1/16W-1005REEL	C20001826M101S	1		
R1161	nsp	0-J,1/16W-1005REEL	C20000006M101S	1		
R1162	nsp	47-J,1/16W-1005REEL	C20004706M101S	1		
R1163	nsp	1.8K-J,1/16W-1005REEL	C20001826M101S	1		
R1165,1166	nsp	1.8K-J,1/16W-1005REEL	C20001826M101S	2		
R1168-1170	nsp	47-J,1/16W-1005REEL	C20004706M101S	3		
R1171	nsp	1M-J,1/16W-1005REEL	C20001056M101S	1		
R1173-1176	nsp	10K-J,1/16W-1005REEL	C20001036M111S	4		
R1177	nsp	1K-J,1/16W-1005REEL	C20001026M101S	1		
R1178	nsp	10K-J,1/16W-1005REEL	C20001036M111S	1		
R1179-1181	nsp	47K-J,1/16W-1005REEL	C20004736M101S	3		
R1183	nsp	0-J,1/16W-1005REEL	C20000006M101S	1		
R1184	nsp	47K-J,1/16W-1005REEL	C20004736M101S	1		
R1185	nsp	10K-J,1/16W-1005REEL	C20001036M111S	1		
R1186	nsp	1K-J,1/16W-1005REEL	C20001026M101S	1		
R1187,1188	nsp	0-J,1/16W-1005REEL	C20000006M101S	2		

REF No.	Part No.	Part Name	Remarks	Q'ty	New	Ver
R1189	nsp	47K-J,1/16W-1005REEL		C20004736M101S	1	
R1190,1191	nsp	33-J,1/16W-1005REEL		C20003306M101S	2	
R1192	nsp	47K-J,1/16W-1005REEL		C20004736M101S	1	
R1194,1195	nsp	33-J,1/16W-1005REEL		C20003306M101S	2	
R1197,1198	nsp	33-J,1/16W-1005REEL		C20003306M101S	2	
R1199	nsp	0-J,1/16W-1005REEL		C20000006M101S	1	
R1201	nsp	33-J,1/16W-1005REEL		C20003306M101S	1	
R1206	nsp	0-J,1/16W-1005REEL		C20000006M101S	1	
R1209,1210	nsp	0-J,1/16W-1005REEL		C20000006M101S	2	
R1216,1217	nsp	10K-J,1/16W-1005REEL		C20001036M111S	2	
R1220	nsp	33-J,1/16W SMD(1005)*4 WA04X		C180330042100S	1	
R1221	nsp	10K-J,1/16W-1005REEL		C20001036M111S	1	
R1222	nsp	0-J,1/16W-1005REEL		C20000006M101S	1	
R1233	nsp	47-J,1/16W-1005REEL		C20004706M101S	1	
R1234	nsp	10K-J,1/16W-1005REEL		C20001036M111S	1	
R1235	nsp	0-J,1/16W-1005REEL		C20000006M101S	1	
R1236-1238	nsp	100-J,1/16W-1005REEL		C20001016M101S	3	
R1239	nsp	33-J,1/16W SMD(1005)*4 WA04X		C180330042100S	1	
R1240	nsp	0-J,1/16W-1005REEL		C20000006M101S	1	
R1241,1242	nsp	100-J,1/16W-1005REEL		C20001016M101S	2	
R1249,1250	nsp	0-J,1/16W-1005REEL		C20000006M101S	2	
R1252	nsp	10K-J,1/16W-1005REEL		C20001036M111S	1	
R1253	nsp	0-J,1/16W-1005REEL		C20000006M101S	1	
R1254	nsp	47-J,1/16W SMD(1005)*4 WA04X		C180470042100S	1	
R1255	nsp	10-F,1/16W-1005REEL		C20001004M100S	1	
R1258	nsp	47-J,1/16W SMD(1005)*4 WA04X		C180470042100S	1	
R1259-1261	nsp	0-J,1/16W-1005REEL		C20000006M101S	3	
R1263	nsp	10K-J,1/16W-1005REEL		C20001036M111S	1	
R1264	nsp	33-J,1/16W-1005REEL		C20003306M101S	1	
R1332	nsp	22K-J,1/16W-1005REEL		C20002236M101S	1	
R1335	nsp	22K-J,1/16W-1005REEL		C20002236M101S	1	
R1337	nsp	22K-J,1/16W-1005REEL		C20002236M101S	1	
R1339	nsp	22K-J,1/16W-1005REEL		C20002236M101S	1	
R1341	nsp	22K-J,1/16W-1005REEL		C20002236M101S	1	
R1343	nsp	22K-J,1/16W-1005REEL		C20002236M101S	1	
R1344,1345	nsp	4.7K-J,1/16W-1005REEL		C20004726M101S	2	
R1346	nsp	100K-J,1/16W-1005REEL		C20001046M101S	1	
R1347	nsp	100-J,1/16W-1005REEL		C20001016M101S	1	
R1348	nsp	100K-J,1/16W-1005REEL		C20001046M101S	1	
R1349	nsp	100-J,1/16W-1005REEL		C20001016M101S	1	
R1354	nsp	100-J,1/16W-1005REEL		C20001016M101S	1	
R1355	nsp	18K-J,1/16W-1005REEL		C20001836M101S	1	
R1356	nsp	100-J,1/16W-1005REEL		C20001016M101S	1	
R1357	nsp	120K-J,1/16W-1005REEL		C20001246M101S	1	
R1358	nsp	100-J,1/16W-1005REEL		C20001016M101S	1	
R1359	nsp	120K-J,1/16W-1005REEL		C20001246M101S	1	
R1360	nsp	100-J,1/16W-1005REEL		C20001016M101S	1	
R1362	nsp	100-J,1/16W-1005REEL		C20001016M101S	1	
R1363	nsp	120K-J,1/16W-1005REEL		C20001246M101S	1	
R1364	nsp	100-J,1/16W-1005REEL		C20001016M101S	1	
R1366	nsp	4.7K-J,1/16W-1005REEL		C20004726M101S	1	
R1367,1368	nsp	33-J,1/16W-1005REEL		C20003306M101S	2	
R1369	nsp	33K-J,1/16W-1005REEL		C20003336M101S	1	
R1370	nsp	18K-J,1/16W-1005REEL		C20001836M101S	1	
R1379	nsp	4.7K-J,1/16W-1005REEL		C20004726M101S	1	
R1384	nsp	0-J,1/16W-1005REEL		C20000006M101S	1	
R1387-1390	nsp	33-J,1/16W-1005REEL		C20003306M101S	4	
R1393,1394	nsp	4.7K-J,1/16W-1005REEL		C20004726M101S	2	
R1395	nsp	33-J,1/16W-1005REEL		C20003306M101S	1	
R1398,1399	nsp	33-J,1/16W-1005REEL		C20003306M101S	2	
R1400	nsp	0-J,1/16W-1005REEL		C20000006M101S	1	
R1401-1407	nsp	33-J,1/16W-1005REEL		C20003306M101S	7	
R1410	nsp	33-J,1/16W-1005REEL		C20003306M101S	1	
R1412	nsp	33-J,1/16W-1005REEL		C20003306M101S	1	
R1414	nsp	10-J,1/16W-1005REEL		C20001006M101S	1	
R1418	nsp	33-J,1/16W-1005REEL		C20003306M101S	1	
R1421	nsp	0-J,1/16W-1005REEL		C20000006M101S	1	
R1422,1423	nsp	33-J,1/16W-1005REEL		C20003306M101S	2	
R1425-1427	nsp	33-J,1/16W-1005REEL		C20003306M101S	3	
R1428	nsp	0-J,1/16W-1608REEL	X2100E3	C20000006M160S	1	
R1428	nsp	10K-J,1/16W-1608REEL	E1/E1C	C20001036M160S	1	
R1428	nsp	22K-J,1/16W-1608REEL	K	C20002236M160S	1	
R1428	nsp	3.3K-J,1/16W-1608REEL	S900	C20003326M160S	1	
R1431	nsp	0-J,1/16W-1608REEL	E2	C20000006M160S	1	
R1431	nsp	22K-J,1/16W-1608REEL	E1	C20001036M160S	1	
R1431	nsp	10K-J,1/16W-1608REEL	E1C/K	C20001036M160S	1	
R1431	nsp	18K-J,1/16W-1608REEL	S900	C20001836M160S	1	
R1432-1434	nsp	1K-J,1/16W-1005REEL		C20001026M101S	3	
R1435	nsp	0-J,1/16W-1005REEL	X2100E3	C20000006M101S	1	
R1436	nsp	10K-J,1/16W-1005REEL		C20001036M111S	1	
R1438-1441	nsp	33-J,1/16W-1005REEL		C20003306M101S	4	
R1442	nsp	4.7K-J,1/16W-1005REEL		C20004726M101S	1	
R1443	nsp	1K-J,1/16W-1005REEL	X2100E3	C20001026M101S	1	
R1448	nsp	3.3K-J,1/16W-1005REEL	X2100E3	C20003326M101S	1	
R1450	nsp	2.2K-J,1/16W-1005REEL	X2100E3	C20002226M101S	1	
R1451	nsp	100K-J,1/16W-1005REEL	X2100E3	C20001046M101S	1	
R1457-1460	nsp	4.7K-J,1/16W-1005REEL		C20004726M101S	4	
R1461	nsp	10K-J,1/16W-1005REEL		C20001036M111S	1	
R1462	nsp	4.7K-J,1/16W-1005REEL		C20004726M101S	1	
R1464	nsp	4.7K-J,1/16W-1005REEL		C20004726M101S	1	
R1465	nsp	10K-J,1/16W-1005REEL		C20001036M111S	1	
R1466	nsp	4.7K-J,1/16W-1005REEL		C20004726M101S	1	
R1469	nsp	10K-J,1/16W-1005REEL		C20001036M111S	1	
R1470-1477	nsp	33-J,1/16W-1005REEL		C20003306M101S	8	
R1478	nsp	10K-J,1/16W-1005REEL		C20001036M111S	1	
R1479-1484	nsp	33-J,1/16W-1005REEL		C20003306M101S	6	
R1485	nsp	10K-J,1/16W-1005REEL		C20001036M111S	1	
R1486	nsp	1.2K-J,1/16W-1005REEL		C20001226M101S	1	
R1487	nsp	100K-J,1/16W-1005REEL		C20001046M101S	1	
R1488	nsp	33-J,1/16W-1005REEL		C20003306M101S	1	
R1489	nsp	2.2M-J,1/16W-1005REEL		C20002256M101S	1	
R1490	nsp	10K-J,1/16W-1005REEL		C20001036M111S	1	

REF No.	Part No.	Part Name	Remarks	Q'ty	New	Ver
R1491	nsp	33-J,1/16W-1005REEL		C20003306M101S	1	
R1492	nsp	10K-J,1/16W-1005REEL		C20001036M111S	1	
R1493	nsp	33-J,1/16W-1005REEL		C20003306M101S	1	
R1494	nsp	4.7K-J,1/16W-1005REEL		C20004726M101S	1	
R1495	nsp	47K-J,1/16W-1005REEL		C20004736M101S	1	
R1496	nsp	27K-J,1/16W-1005REEL		C20002736M101S	1	
R1497	nsp	33-J,1/16W-1005REEL		C20003306M101S	1	
R1498	nsp	220K-J,1/16W-1005REEL		C20002246M101S	1	
R1499	nsp	33-J,1/16W-1005REEL		C20003306M101S	1	
R1500	nsp	3.3K-J,1/16W-1005REEL		C20003326M101S	1	
R1501	nsp	100K-J,1/16W-1005REEL		C20001046M101S	1	
R1502,1503	nsp	10K-J,1/16W-1005REEL		C20001036M111S	2	
R1506	nsp	10K-J,1/16W-1005REEL		C20001036M111S	1	
R1507,1508	nsp	33-J,1/16W-1005REEL		C20003306M101S	2	
R1509	nsp	4.7K-J,1/16W-1005REEL		C20004726M101S	1	
R1510	nsp	33-J,1/16W-1005REEL		C20003306M101S	1	
R1512	nsp	10K-J,1/16W-1005REEL		C20001036M111S	1	
R1513-1516	nsp	33-J,1/16W-1005REEL		C20003306M101S	4	
R1517	nsp	10K-J,1/16W-1005REEL		C20001036M111S	1	
R1518,1519	nsp	4.7K-J,1/16W-1005REEL		C20004726M101S	2	
R1522	nsp	10K-J,1/16W-1005REEL		C20001036M111S	1	
R1523	nsp	1M-J,1/16W-1005REEL		C20001056M101S	1	
R1524	nsp	0-J,1/16W-1005REEL		C20000006M101S	1	
R1533	nsp	0-J,1/16W-1005REEL		C20000006M101S	1	
R1544	nsp	4.7K-J,1/16W-1005REEL		C20004726M101S	1	
R1545,1546	nsp	10K-J,1/16W-1005REEL		C20001036M111S	2	
R1547	nsp	47K-J,1/16W-1005REEL		C20004736M101S	1	
R1550	nsp	0-J,1/16W-1005REEL		C20000006M101S	1	
R1552	nsp	1K-J,1/16W-1005REEL		C20001026M101S	1	
R1553	nsp	2.2K-J,1/16W-1005REEL		C20002226M101S	1	
R1555,1556	nsp	0-J,1/16W-1005REEL		C20000006M101S	2	
R1558	nsp	10K-J,1/16W-1005REEL		C20001036M111S	1	
R1561	nsp	0-J,1/16W-1005REEL		C20000006M101S	1	
R1563,1564	nsp	0-J,1/16W-1005REEL		C20000006M101S	2	
R1565	nsp	33-J,1/16W-1005REEL		C20003306M101S	1	
R1567-1570	nsp	10K-J,1/16W-1005REEL		C20001036M111S	4	
R1571	nsp	100K-J,1/16W-1005REEL		C20001046M101S	1	
R1573	nsp	33-J,1/16W SMD(1005)*4 WA04X		C180330042100S	1	
R1574	nsp	100K-J,1/16W-1005REEL		C20001046M101S	1	
R1575	nsp	4.7K-J,1/16W-1005REEL		C20004726M101S	1	
R1576	nsp	4.7K-J,1/16W-1005REEL	S900	C20004726M101S	1	
R1578,1579	nsp	33-J,1/16W-1005REEL		C20003306M101S	2	
R1580	nsp	10K-J,1/16W-1005REEL		C20001036M111S	1	
R1581,1582	nsp	33-J,1/16W-1005REEL		C20003306M101S	2	
R1583	nsp	4.7K-J,1/16W-1005REEL	X2100	C20004726M101S	1	
R1584	nsp	10K-J,1/16W-1005REEL		C20001036M111S	1	
R1585	nsp	4.7K-J,1/16W-1005REEL		C20004726M101S	1	
R1587	nsp	10K-J,1/16W-1005REEL		C20001036M111S	1	
R1588	nsp	0-J,1/16W-1005REEL		C20000006M101S	1	
R1589	nsp	33-J,1/16W-1005REEL		C20003306M101S	1	
R1590	nsp	0-J,1/16W-1005REEL		C20000006M101S	1	
R1591	nsp	10-J,1/16W SMD(1005)*4 WA04X		C180100042100S	1	
R1593	nsp	10-J,1/16W SMD(1005)*4 WA04X		C180100042100S	1	
R1594	nsp	47-J,1/16W-1005REEL		C20004706M101S	1	
R1595	nsp	10K-J,1/16W-1005REEL		C20001036M111S	1	
R1597	nsp	10-J,1/16W SMD(1005)*4 WA04X		C180100042100S	1	
R1599	nsp	10-J,1/16W SMD(1005)*4 WA04X		C180100042100S	1	
R1600	nsp	10K-J*4,1/16W SMD(1005) WA04		C180103042100S	1	
R1601	nsp	2.2K-J,1/16W-1005REEL		C20002226M101S	1	
R1603	nsp	33-J,1/16W SMD(1005)*4 WA04X		C180330042100S	1	
R1604,1605	nsp	33-J,1/16W-1005REEL		C20003306M101S	2	
R1606,1607	nsp	10K-J*4,1/16W SMD(1005) WA04		C180103042100S	2	
R1608	nsp	4.7K-J,1/16W-1005REEL		C20004726M101S	1	
R1610	nsp	4.7K-J,1/16W-1005REEL		C20004726M101S	1	
R1612	nsp	1K-J,1/16W-1005REEL		C20001026M101S	1	
R1613,1614	nsp	4.7K-J,1/16W-1005REEL		C20004726M101S	2	
R1615	nsp	33-J,1/16W-1005REEL		C20003306M101S	1	
R1617	nsp	10K-J*4,1/16W SMD(1005) WA04		C180103042100S	1	
R1618	nsp	10K-J,1/16W-1005REEL		C20001036M111S	1	
R1619	nsp	1M-J,1/16W-1005REEL		C20001056M101S	1	
R1620	nsp	10-J,1/16W-1005REEL		C20001006M101S	1	
R1621-1624	nsp	33-J,1/16W SMD(1005)*4 WA04X		C180330042100S	4	
R1625	nsp	33-J,1/16W-1005REEL		C20003306M101S	1	
R1626	nsp	220-J,1/16W-1005REEL		C20002216M101S	1	
R1627	nsp	10K-J,1/16W-1005REEL		C20001036M111S	1	
R1630,1631	nsp	1.8K-J,1/16W-1005REEL		C20001826M101S	2	
R1632	nsp	33-J,1/16W-1005REEL		C20003306M101S	1	
R1633	nsp	33-J,1/16W SMD(1005)*4 WA04X		C180330042100S	1	
R1634	nsp	4.7K-J,1/16W-1005REEL		C20004726M101S	1	
R1635	nsp	33-J,1/16W SMD(1005)*4 WA04X		C180330042100S	1	
R1637,1638	nsp	4.7K-J,1/16W-1005REEL		C20004726M101S	2	
R1639	nsp	33-J,1/16W SMD(1005)*4 WA04X		C180330042100S	1	
R1640	nsp	4.7K-J,1/16W-1005REEL		C20004726M101S	1	
R1641	nsp	0-J,1/16W-1005REEL		C20000006M101S	1	
R1642,1643	nsp	1K-D,1/16W-1608REEL		C20001021M160S	2	
R1644	nsp	33-J,1/16W SMD(1005)*4 WA04X		C180330042100S	1	
R1645	nsp	470-D,1/16W-1608REEL		C20004711M160S	1	
R1647	nsp	33-J,1/16W SMD(1005)*4 WA04X		C180330042100S	1	
R1651	nsp	33-J,1/16W SMD(1005)*4 WA04X		C180330042100S	1	
R1652	nsp	4.7K-J,1/16W-1005REEL		C20004726M101S	1	
R1655	nsp	33-J,1/16W SMD(1005)*4 WA04X		C180330042100S	1	
R1657	nsp	0-J*2,1/16W SMD(1005) WA04Y		C180000022100S	1	
R1658	nsp	2.7K-F,1/16W-1608REEL		C20002724M161S	1	
R1659	nsp	180-F,1/16W-1608REEL		C20001814M161S	1	
R1660	nsp	2.7K-F,1/16W-1608REEL		C20002724M161S	1	
R1661	nsp	180-F,1/16W-1608REEL		C20001814M161S	1	
R1663-1665	nsp	0-J*2,1/16W SMD(1005) WA04Y		C180000022100S	3	
R1667-1669	nsp	33-J,1/16W-1005REEL		C20003306M101S	3	
R1671-1674	nsp	0-J,1/16W-1005REEL		C20000006M101S	4	
R1675	nsp	10K-J,1/16W-1005REEL		C20001036M111S	1	
R1676,1677	nsp	0-J,1/16W-1005REEL		C20000006M101S	2	
R1678	nsp	10K-J,1/16W-1005REEL		C20001036M111S	1	

REF No.	Part No.	Part Name	Remarks	Q'ty	New	Ver
R1680	nsp	0-J,1/16W-1005REEL		C2000006M101S	1	
R1681	nsp	33-J,1/16W-1005REEL		C20003306M101S	1	
R1682	nsp	0-J,1/16W-1005REEL		C2000006M101S	1	
R1683	nsp	10K-J,1/16W-1005REEL		C20001036M111S	1	
R1684	nsp	1K-J,1/16W-1005REEL		C20001026M101S	1	
R1685,1686	nsp	4.7K-J,1/16W SMD(1005)*4 WA04X		C180472042100S	2	
R1687	nsp	56-J,1/16W-1005REEL		C20005606M101S	1	
R1688,1689	nsp	47-J,1/16W-1005REEL		C20004706M101S	2	
R1690,1691	nsp	4.7K-J,1/16W-1005REEL		C20004726M101S	2	
R1692	nsp	47-J,1/16W SMD(1005)*4 WA04X		C180470042100S	1	
R1693,1694	nsp	47-J,1/16W-1005REEL		C20004706M101S	2	
R1695-1700	nsp	47-J,1/16W SMD(1005)*4 WA04X		C180470042100S	6	
R1701,1702	nsp	47-J,1/16W-1005REEL		C20004706M101S	2	
R1703-1710	nsp	47-J,1/16W SMD(1005)*4 WA04X		C180470042100S	8	
R1711	nsp	47-J,1/16W-1005REEL		C20004706M101S	1	
R1715,1716	nsp	1K-D,1/16W-1608REEL		C20001021M160S	2	
R1717,1718	nsp	10K-J,1/16W-1005REEL		C20001036M111S	2	
R1731	nsp	33-J,1/16W-1005REEL		C20003306M101S	1	
R1732	nsp	0-J,1/16W-1005REEL		C2000006M101S	1	
R1733,1734	nsp	10K-J,1/16W-1005REEL		C20001036M111S	2	
R1735	nsp	100K-J,1/16W-1005REEL		C20001046M101S	1	
R1736	nsp	348K-F,1/16W-1608REEL		C20034834M161S	1	
R1737	nsp	300K-F,1/16W-1608REEL		C20003044M160S	1	
R1738	nsp	39K-F,1/16W-1608REEL		C20003934M161S	1	
R1739	nsp	4.7K-J,1/16W-1005REEL		C20004726M101S	1	
R1740	nsp	10-J,1/16W-1005REEL		C20001006M101S	1	
R1741,1742	nsp	10K-J,1/16W-1005REEL		C20001036M111S	2	
R1743	nsp	100K-J,1/16W-1005REEL		C20001046M101S	1	
R1746	nsp	22K-J,1/16W-1005REEL		C20002236M101S	1	
R1747	nsp	39K-F,1/16W-1608REEL		C20003934M161S	1	
R1748	nsp	100-J,1/16W-1005REEL		C20001016M101S	1	
R1750	nsp	100-J,1/16W-1005REEL		C20001016M101S	1	
R1751	nsp	4.7K-J,1/16W-1005REEL		C20004726M101S	1	
R1752	nsp	100K-J,1/16W-1005REEL		C20001046M101S	1	
R1753	nsp	348K-F,1/16W-1608REEL		C20034834M161S	1	
R1754	nsp	10K-J,1/16W-1005REEL		C20001036M111S	1	
R1755	nsp	3.3K-J,1/16W-1005REEL		C20003326M101S	1	
R1756	nsp	47K-J,1/16W-1005REEL		C20004736M101S	1	
R1759	nsp	300K-F,1/16W-1608REEL		C20003044M160S	1	
R1760	nsp	4.7K-J,1/16W-1005REEL		C20004726M101S	1	
R1761	nsp	10-J,1/16W-1005REEL		C20001006M101S	1	
R1762	nsp	0-J,1/16W-1005REEL		C2000006M101S	1	
R1763	nsp	100K-J,1/16W-1005REEL		C20001046M101S	1	
R1764	nsp	348K-F,1/16W-1608REEL		C20034834M161S	1	
R1765	nsp	412K-F,1/16W-1608REEL		C20041234M161S	1	
R1766	nsp	4.7K-J,1/16W-1005REEL		C20004726M101S	1	
R1767	nsp	10-J,1/16W-1005REEL		C20001006M101S	1	
R1768	nsp	0-J,1/16W-1005REEL		C2000006M101S	1	
R1769	nsp	100K-J,1/16W-1005REEL		C20001046M101S	1	
R1770,1771	nsp	348K-F,1/16W-1608REEL		C20034834M161S	2	
R1772	nsp	4.7K-J,1/16W-1005REEL		C20004726M101S	1	
R1773	nsp	10-J,1/16W-1005REEL		C20001006M101S	1	
R1774	nsp	0-J,1/16W-1005REEL		C2000006M101S	1	
R1775	nsp	100K-J,1/16W-1005REEL		C20001046M101S	1	
R1776-1778	nsp	10K-J,1/16W-1005REEL		C20001036M111S	3	
R1779	nsp	3.3K-J,1/16W-1005REEL		C20003326M101S	1	
R1780	nsp	348K-F,1/16W-1608REEL		C20034834M161S	1	
R1781	nsp	160K-F,1/16W-1608REEL		C20001644M160S	1	
R1782,1783	nsp	10K-J,1/16W-1005REEL		C20001036M111S	2	
R1784	nsp	4.7K-J,1/16W-1005REEL		C20004726M101S	1	
R1785	nsp	10-J,1/16W-1005REEL		C20001006M101S	1	
R1786	nsp	2K-F,1/16W-1005REEL		C20002024M100S	1	
R1787	nsp	100K-J,1/16W-1005REEL		C20001046M101S	1	
R1788	nsp	348K-F,1/16W-1608REEL		C20034834M161S	1	
R1789	nsp	169K-F,1/16W-1608REEL		C20016934M161S	1	
R1790	nsp	10K-J,1/16W-1005REEL		C20001036M111S	1	
R1791	nsp	3.3K-J,1/16W-1005REEL		C20003326M101S	1	
R1793	nsp	4.7K-J,1/16W-1005REEL		C20004726M101S	1	
R1794	nsp	0-J,1/16W-1005REEL		C2000006M101S	1	
R1795	nsp	10K-J,1/16W-1005REEL		C20001036M111S	1	
R1796	nsp	0-J,1/16W-1005REEL		C2000006M101S	1	
R1797	nsp	10K-J,1/16W-1005REEL		C20001036M111S	1	
R1798	nsp	39K-F,1/16W-1608REEL		C20003934M161S	1	
R1799	nsp	100K-J,1/16W-1005REEL		C20001046M101S	1	
R1800	nsp	0-J,1/16W-1005REEL		C2000006M101S	1	
R1801	nsp	100K-J,1/16W-1005REEL		C20001046M101S	1	
R1802	nsp	76.8K-F,1/16W-1608REEL		C20076824M161S	1	
R1803	nsp	100K-J,1/16W-1005REEL		C20001046M101S	1	
R1804	nsp	348K-F,1/16W-1608REEL		C20034834M161S	1	
R1806,1807	nsp	348K-F,1/16W-1608REEL		C20034834M161S	2	
R1808	nsp	169K-F,1/16W-1608REEL		C20016934M161S	1	
R1809	nsp	300K-F,1/16W-1608REEL		C20003044M160S	1	
R1810	nsp	10-J,1/16W-1005REEL		C20001006M101S	1	
R1811	nsp	4.7K-J,1/16W-1005REEL		C20004726M101S	1	
R1812	nsp	10-J,1/16W-1005REEL		C20001006M101S	1	
R1813,1814	nsp	4.7K-J,1/16W-1005REEL		C20004726M101S	2	
R1815	nsp	10-J,1/16W-1005REEL		C20001006M101S	1	
R1818,1819	nsp	10K-J,1/16W-1005REEL		C20001036M111S	2	
R1820,1821	nsp	0-J,1/16W-1005REEL		C2000006M101S	2	
R1822	nsp	10K-J,1/16W-1005REEL		C20001036M111S	1	
R1823	nsp	3.3K-J,1/16W-1005REEL		C20003326M101S	1	
R1824	nsp	0-J,1/16W-1005REEL		C2000006M101S	1	
R1825	nsp	0-J,1/16W-1005REEL	X2100E3	C2000006M101S	1	
R1827	nsp	4.7K-J,1/16W-1005REEL		C20004726M101S	1	
R1828	nsp	348K-F,1/16W-1608REEL		C20034834M161S	1	
R1829	nsp	76.8K-F,1/16W-1608REEL		C20076824M161S	1	
R1830	nsp	10-J,1/16W-1005REEL		C20001006M101S	1	
R1831	nsp	100K-J,1/16W-1005REEL		C20001046M101S	1	
R1832	nsp	0-J,1/16W-1005REEL		C2000006M101S	1	
R1850-1852	nsp	47K-J,1/16W-1005REEL		C20004736M101S	3	
R1853-1855	nsp	10-J,1/16W-1005REEL		C20001006M101S	3	
R1856,1857	nsp	0-J,1/16W-1005REEL		C2000006M101S	2	

REF No.	Part No.	Part Name	Remarks	Q'ty	New	Ver
R1858	nsp	10-J,1/16W-1005REEL		C20001006M101S	1	
R1859,1860	nsp	0-J,1/16W-1005REEL		C20000006M101S	2	
R1861	nsp	10-J,1/16W-1005REEL		C20001006M101S	1	
R1862,1863	nsp	0-J,1/16W-1005REEL		C20000006M101S	2	
R1864,1865	nsp	10-J,1/16W-1005REEL		C20001006M101S	2	
R1866	nsp	510-D,1/16W-1608REEL		C20005111M161S	1	
R1867	nsp	10-J,1/16W-1005REEL		C20001006M101S	1	
R1868	nsp	10K-J,1/16W-1005REEL		C20001036M111S	1	
R1869,1870	nsp	1.8K-J,1/16W-1005REEL		C20001826M101S	2	
R1871	nsp	10K-J,1/16W-1005REEL		C20001036M111S	1	
R1872	nsp	510-D,1/16W-1608REEL		C20005111M161S	1	
R1873-1880	nsp	0-J,1/16W-1005REEL		C20000006M101S	8	
R1881-1883	nsp	47-J,1/16W-1005REEL		C20004706M101S	3	
R1884	nsp	47K-J,1/16W-1005REEL		C20004736M101S	1	
R1885,1886	nsp	1.8K-J,1/16W-1005REEL		C20001826M101S	2	
R1887,1888	nsp	51-D,1/16W-1608REEL		C20005101M160S	2	
R1889,1890	nsp	10K-J,1/16W-1005REEL		C20001036M111S	2	
R1891	nsp	5.1-J,1/16W-1005REEL		C20005R106M100S	1	
R1892	nsp	10K-J,1/16W-1005REEL		C20001036M111S	1	
R1893	nsp	1M-J,1/16W-1005REEL		C20001056M101S	1	
R1894	nsp	1K-J,1/16W-1005REEL		C20001026M101S	1	
R1897	nsp	1K-J,1/16W-1005REEL		C20001026M101S	1	
R1898	nsp	10K-J,1/16W-1005REEL		C20001036M111S	1	
R1899	nsp	1K-J,1/16W-1005REEL		C20001026M101S	1	
R1900,1901	nsp	4.7K-J,1/16W-1005REEL		C20004726M101S	2	
R1902	nsp	33-J,1/16W-1005REEL		C20003306M101S	1	
R1903	nsp	3.3K-J,1/16W-1005REEL		C20003326M101S	1	
R1905	nsp	820-J,1/16W-1005REEL		C20008216M101S	1	
R1906	nsp	33-J,1/16W SMD(1005)*4 WA04X		C180330042100S	1	
R1907	nsp	680-J,1/16W-1005REEL		C20006816M101S	1	
R1908	nsp	33-J,1/16W SMD(1005)*4 WA04X		C180330042100S	1	
R1909	nsp	0-J,1/16W-1005REEL		C20000006M101S	1	
R1910	nsp	10K-J*4 1/16W SMD(1005) WA04		C180103042100S	1	
R1911	nsp	0-J,1/16W-1005REEL		C20000006M101S	1	
R1914,1915	nsp	33-J,1/16W-1005REEL		C20003306M101S	2	
R1916,1917	nsp	33-J,1/16W SMD(1005)*4 WA04X		C180330042100S	2	
R1919	nsp	0-J,1/16W-1608REEL		C20000006M160S	1	
R1920,1921	nsp	33-J,1/16W-1005REEL		C20003306M101S	2	
R1922	nsp	33-J,1/16W SMD(1005)*4 WA04X		C180330042100S	1	
R1923	nsp	33-J,1/16W-1005REEL		C20003306M101S	1	
R1924	nsp	33-J,1/16W SMD(1005)*4 WA04X		C180330042100S	1	
R1925-1928	nsp	33-J,1/16W-1005REEL		C20003306M101S	4	
R1930-1933	nsp	33-J,1/16W-1005REEL		C20003306M101S	4	
R1934	nsp	33-J,1/16W SMD(1005)*4 WA04X		C180330042100S	1	
R1935-1942	nsp	33-J,1/16W-1005REEL		C20003306M101S	8	
R1943	nsp	1K-J,1/16W-1005REEL		C20001026M101S	1	
R1944,1945	nsp	10K-J,1/16W-1005REEL		C20001036M111S	2	
R1950	nsp	0-J,1/16W-1005REEL		C20000006M101S	1	
R1953-1955	nsp	10K-J,1/16W-1005REEL		C20001036M111S	3	
R1956	nsp	470-J,1/16W-1005REEL	E3	C20004716M101S	1	
R1957	nsp	47K-J,1/16W-1005REEL	E3	C20004736M101S	1	
R1958,1959	nsp	150-J,1/16W-1005REEL	E3	C20001516M101S	2	
R1960	nsp	330K-J,1/16W-1005REEL	E3	C20003346M101S	1	
R1961	nsp	33-J,1/16W-1005REEL		C20003306M101S	1	
R1963	nsp	33-J,1/16W-1005REEL		C20003306M101S	1	
R1965,1966	nsp	0-J,1/16W-1005REEL	E2/E1/E1C/K	C20000006M101S	2	
R1967	nsp	33-J,1/16W-1005REEL		C20003306M101S	1	
R1969-1975	nsp	33-J,1/16W-1005REEL		C20003306M101S	7	
R1976-1980	nsp	33-J,1/16W SMD(1005)*4 WA04X		C180330042100S	5	
R1981,1982	nsp	33-J,1/16W-1005REEL		C20003306M101S	2	
R1983	nsp	5.1-J,1/16W-1005REEL		C20005R106M100S	1	
R1984-1986	nsp	0-J*2,1/16W SMD(1005) WA04Y		C180000022100S	3	
R1988-1990	nsp	0-J*2,1/16W SMD(1005) WA04Y		C180000022100S	3	
R1993,1994	nsp	1K-J,1/16W-1005REEL		C20001026M101S	2	
R1997,1998	nsp	X7R)0.1UF-K/25V-1608REEL		D011104774161S	2	
R1999	nsp	100-J,1/16W-1608REEL		C20001016M160S	1	
R2002	nsp	100-J,1/16W-1608REEL		C20001016M160S	1	
R2010	nsp	100-J,1/16W-1608REEL		C20001016M160S	1	
R2013	nsp	100-J,1/16W-1608REEL		C20001016M160S	1	
R2017	nsp	100-J,1/16W-1608REEL		C20001016M160S	1	
R2020	nsp	33-J,1/16W SMD(1005)*4 WA04X		C180330042100S	1	
R2021	nsp	100-J,1/16W-1608REEL		C20001016M160S	1	
R2027,2028	nsp	33-J,1/16W-1005REEL		C20003306M101S	2	
R2029	nsp	0-J,1/16W-1005REEL		C20000006M101S	1	
R2032	nsp	33-J,1/16W-1005REEL		C20003306M101S	1	
R2033	nsp	1K-J,1/16W-1005REEL		C20001026M101S	1	
R2034	nsp	100-J,1/16W-1608REEL		C20001016M160S	1	
R2037	nsp	4.7K-J,1/16W-1005REEL		C20004726M101S	1	
R2038	nsp	100-J,1/16W-1608REEL		C20001016M160S	1	
R2043	nsp	4.7K-J,1/16W-1005REEL		C20004726M101S	1	
R2044	nsp	100-J,1/16W-1608REEL		C20001016M160S	1	
R2047	nsp	100-J,1/16W-1608REEL		C20001016M160S	1	
R2049	nsp	0-J,1/16W-1005REEL		C20000006M101S	1	
R2057	nsp	0-J,1/16W-1005REEL		C20000006M101S	1	
R2058	nsp	100-J,1/16W-1608REEL		C20001016M160S	1	
R2061	nsp	10K-J,1/16W-1005REEL		C20001036M111S	1	
R2062	nsp	100-J,1/16W-1608REEL		C20001016M160S	1	
R2066	nsp	470-J,1/16W-1005REEL		C20004716M101S	1	
R2067	nsp	10K-J,1/16W-1005REEL		C20001036M111S	1	
R2068	nsp	100K-J,1/16W-1005REEL		C20001046M101S	1	
R2069	nsp	100-J,1/16W-1608REEL		C20001016M160S	1	
R2072	nsp	100-J,1/16W-1608REEL		C20001016M160S	1	
R2074	nsp	100K-J,1/16W-1005REEL		C20001046M101S	1	
R2078	nsp	470-J,1/16W-1005REEL		C20004716M101S	1	
R2082	nsp	100-J,1/16W-1608REEL		C20001016M160S	1	
R2085	nsp	100-J,1/16W-1608REEL		C20001016M160S	1	
R2089-2092	nsp	24-J,1/16W-1608REEL		C20002406M160S	4	
R2093-2096	nsp	51-J,1/16W-1608REEL		C20005106M160S	4	
R2097	nsp	2.2K-J,1/16W-1005REEL		C20002226M101S	1	
R2117	nsp	0-J,1/16W-1608REEL		C20000006M160S	1	
R2118	nsp	10K-J,1/16W-1005REEL		C20001036M111S	1	
R2120	nsp	470-D,1/16W-1608REEL		C20004711M160S	1	

REF No.	Part No.	Part Name	Remarks	Q'ty	New	Ver
R2121	nsp	10K-J,1/16W-1005REEL		C20001036M111S	1	
R2123,2124	nsp	4.7K-J,1/16W-1005REEL		C20004726M101S	2	
R2125	nsp	4.7K-J,1/16W SMD(1005)*4 WA04X		C180472042100S	1	
R2126	nsp	47K-J,1/16W-1005REEL		C20004736M101S	1	
R2127	nsp	47-J,1/16W-1005REEL		C20004706M101S	1	
R2129	nsp	4.7K-J,1/16W SMD(1005)*4 WA04X		C180472042100S	1	
R2132	nsp	4.7K-J,1/16W SMD(1005)*4 WA04X		C180472042100S	1	
R2133	nsp	47K-J,1/16W SMD(1005)*4 WA04X		C180473042100S	1	
R2134	nsp	33-J,1/16W SMD(1005)*4 WA04X		C180330042100S	1	
R2135	nsp	4.7K-J,1/16W SMD(1005)*4 WA04X		C180472042100S	1	
R2136	nsp	47K-J,1/16W SMD(1005)*4 WA04X		C180473042100S	1	
R2137	nsp	33-J,1/16W SMD(1005)*4 WA04X		C180330042100S	1	
R2139	nsp	4.7K-J,1/16W SMD(1005)*4 WA04X		C180472042100S	1	
R2140,2141	nsp	47K-J,1/16W-1005REEL		C20004736M101S	2	
R2142	nsp	10-J,1/16W SMD(1005)*4 WA04X		C180100042100S	1	
R2143,2144	nsp	2.2K-J,1/16W-1005REEL		C20002226M101S	2	
R2146	nsp	4.7K-J,1/16W-1005REEL		C20004726M101S	1	
R2147	nsp	10-J,1/16W-1005REEL		C20001006M101S	1	
R2150	nsp	47K-J,1/16W SMD(1005)*4 WA04X		C180473042100S	1	
R2151	nsp	4.7K-J,1/16W SMD(1005)*4 WA04X		C180472042100S	1	
R2156	nsp	4.7K-J,1/16W SMD(1005)*4 WA04X		C180472042100S	1	
R2159	nsp	1K-J,1/16W-1005REEL		C20001026M101S	1	
R2162	nsp	47K-J,1/16W-1005REEL		C20004736M101S	1	
R2163	nsp	4.7K-J,1/16W-1005REEL		C20004726M101S	1	
R2164	nsp	4.7K-J,1/16W SMD(1005)*4 WA04X		C180472042100S	1	
R2171	nsp	10K-J,1/16W-1005REEL		C20001036M111S	1	
R2173-2180	nsp	0-J,1/16W-1005REEL		C20000006M101S	8	
R6000	nsp	680K-J,1/16W-1005REEL		C20006846M101S	1	
R6001	nsp	22M-J,1/16W-1005REEL		C20002266M100S	1	
R6002-6004	nsp	10K-J,1/16W-1005REEL		C20001036M111S	3	
R6005	nsp	39K-J,1/16W-1005REEL		C20003936M101S	1	
R6006	nsp	11K-J,1/16W-1005REEL		C20001136M101S	1	
R6007-6012	nsp	0-J,1/16W-1005REEL		C20000006M101S	6	
<b>CAPACITORS GROUP</b>						
C1000-1007	nsp	X7R)1000PF-K/50V-1005REEL		D011102177101S	8	
C1008-1010	nsp	X7R)4.7UF-K/6.3V-1608REEL		D011475571160S	3	
C1015	nsp	X7R)4.7UF-K/6.3V-1608REEL		D011475571160S	1	
C1016-1025	nsp	X7R)0.1UF-K/16V-1005REEL		D011104177101S	10	
C1030,1031	nsp	X7R)4.7UF-K/6.3V-1608REEL		D011475571160S	2	
C1032	nsp	X7R)0.1UF-K/16V-1005REEL		D011104177101S	1	
C1034,1035	nsp	X7R)4.7UF-K/6.3V-1608REEL		D011475571160S	2	
C1042,1043	nsp	X7R)4.7UF-K/6.3V-1608REEL		D011475571160S	2	
C1044	nsp	X7R)1UF-K/10V-1608REEL		D011105772161S	1	
C1045-1047	nsp	X7R)0.1UF-K/16V-1005REEL		D011104177101S	3	
C1056,1057	nsp	X7R)4.7UF-K/6.3V-1608REEL		D011475571160S	2	
C1058	nsp	X7R)0.1UF-K/16V-1005REEL		D011104177101S	1	
C1059	nsp	X7R)1UF-K/10V-1608REEL		D011105772161S	1	
C1060,1061	nsp	X7R)0.1UF-K/16V-1005REEL		D011104177101S	2	
C1062	nsp	X7R)1UF-K/10V-1608REEL		D011105772161S	1	
C1067,1068	nsp	X7R)4.7UF-K/6.3V-1608REEL		D011475571160S	2	
C1069-1072	nsp	X7R)0.1UF-K/16V-1005REEL		D011104177101S	4	
C1073	nsp	X7R)1UF-K/10V-1608REEL		D011105772161S	1	
C1074-1076	nsp	X7R)0.1UF-K/16V-1005REEL		D011104177101S	3	
C1077,1078	nsp	COG)10PF-J/50V-1608REEL		D010100167161S	2	
C1079-1085	nsp	X7R)0.1UF-K/16V-1005REEL		D011104177101S	7	
C1086	nsp	X7R)1000PF-K/50V-1005REEL		D011102177101S	1	
C1087-1090	nsp	X7R)0.1UF-K/16V-1005REEL		D011104177101S	4	
C1091-1093	nsp	X7R)4.7UF-K/6.3V-1608REEL		D011475571160S	3	
C1098	nsp	X7R)4.7UF-K/6.3V-1608REEL		D011475571160S	1	
C1099-1108	nsp	X7R)0.1UF-K/16V-1005REEL		D011104177101S	10	
C1113,1114	nsp	X7R)4.7UF-K/6.3V-1608REEL		D011475571160S	2	
C1115	nsp	X7R)0.1UF-K/16V-1005REEL		D011104177101S	1	
C1117,1118	nsp	X7R)4.7UF-K/6.3V-1608REEL		D011475571160S	2	
C1125,1126	nsp	X7R)4.7UF-K/6.3V-1608REEL		D011475571160S	2	
C1127	nsp	X7R)1UF-K/10V-1608REEL		D011105772161S	1	
C1128-1130	nsp	X7R)0.1UF-K/16V-1005REEL		D011104177101S	3	
C1139,1140	nsp	X7R)4.7UF-K/6.3V-1608REEL		D011475571160S	2	
C1141	nsp	X7R)0.1UF-K/16V-1005REEL		D011104177101S	1	
C1142	nsp	X7R)1UF-K/10V-1608REEL		D011105772161S	1	
C1143,1144	nsp	X7R)0.1UF-K/16V-1005REEL		D011104177101S	2	
C1145	nsp	X7R)1UF-K/10V-1608REEL		D011105772161S	1	
C1150,1151	nsp	X7R)4.7UF-K/6.3V-1608REEL		D011475571160S	2	
C1152-1155	nsp	X7R)0.1UF-K/16V-1005REEL		D011104177101S	4	
C1156	nsp	X7R)1UF-K/10V-1608REEL		D011105772161S	1	
C1157-1159	nsp	X7R)0.1UF-K/16V-1005REEL		D011104177101S	3	
C1160,1161	nsp	COG)10PF-J/50V-1608REEL		D010100167161S	2	
C1162-1168	nsp	X7R)0.1UF-K/16V-1005REEL		D011104177101S	7	
C1169	nsp	X7R)1000PF-K/50V-1005REEL		D011102177101S	1	
C1170,1171	nsp	X7R)0.1UF-K/16V-1005REEL		D011104177101S	2	
C1173	nsp	X7R)0.1UF-K/16V-1005REEL		D011104177101S	1	
C1174	nsp	X7R)1000PF-K/50V-1005REEL		D011102177101S	1	
C1176,1177	nsp	X7R)0.1UF-K/16V-1005REEL		D011104177101S	2	
C1179,1180	nsp	X7R)4.7UF-K/6.3V-1608REEL		D011475571160S	2	
C1182,1183	nsp	X7R)4.7UF-K/6.3V-1608REEL		D011475571160S	2	
C1187,1188	nsp	X7R)0.1UF-K/16V-1005REEL		D011104177101S	2	
C1201	nsp	X7R)1000PF-K/50V-1005REEL		D011102177101S	1	
C1202	nsp	X7R)0.1UF-K/16V-1005REEL		D011104177101S	1	
C1203	nsp	X7R)0.22UF-K/25V-1608REEL		D01122377160S	1	
C1286,1287	nsp	X7R)0.1UF-K/16V-1005REEL		D011104177101S	2	
C1288,1289	nsp	X7R)0.01UF-K/25V-1005REEL		D011103174101S	2	
C1292-1297	nsp	X7R)0.01UF-K/25V-1005REEL		D011103174101S	6	
C1299	nsp	X7R)0.1UF-K/16V-1005REEL		D011104177101S	1	
C1305-1310	nsp	X7R)0.1UF-K/16V-1005REEL		D011104177101S	6	
C1317-1325	nsp	X7R)0.1UF-K/16V-1005REEL		D011104177101S	9	
C1327	nsp	X7R)0.1UF-K/16V-1005REEL		D011104177101S	1	
C1330-1332	nsp	X7R)0.1UF-K/16V-1005REEL		D011104177101S	3	
C1333	nsp	X7R)1000PF-K/50V-1005REEL	X2100E3	D011102177101S	1	
C1334,1335	nsp	X7R)0.1UF-K/16V-1005REEL		D011104177101S	2	
C1336,1337	nsp	COG)10PF-D/50V-1005REEL		D011100117101S	2	
C1338	nsp	X7R)1000PF-K/50V-1005REEL	X2100E3	D011102177101S	1	
C1339	nsp	X7R)4.7UF-K/6.3V-1608REEL		D011475571160S	1	
C1340	nsp	X7R)0.1UF-K/16V-1005REEL	X2100E3	D011104177101S	1	



REF No.	Part No.	Part Name	Remarks	Q'ty	New	Ver
C1346	nsp	X7R)0.1UF-K/16V-1005REEL	D011104177101S	1		
C1348	nsp	X7R)0.1UF-K/16V-1005REEL	D011104177101S	1		
C1349	nsp	X7R)220PF-K/50V-1005REEL	D011221177101S	1		
C1350-1354	nsp	X7R)0.1UF-K/16V-1005REEL	D011104177101S	5		
C1355,1356	nsp	COG 8PF-D/50V-1005REEL FENGHUA	D011080117101S	2		
C1357	nsp	X7R)0.1UF-K/16V-1005REEL	D011104177101S	1		
C1380	nsp	X5R)10UF-K/16V-2012REEL GRM21BR61C106KE15L	D011106573200S	1		
C1385-1387	nsp	X7R)0.1UF-K/16V-1005REEL	D011104177101S	3		
C1388	nsp	X7R)0.01UF-K/25V-1005REEL	D011103174101S	1		
C1389,1390	nsp	X7R)0.1UF-K/16V-1005REEL	D011104177101S	2		
C1391	nsp	X5R)10UF-K/16V-2012REEL GRM21BR61C106KE15L	D011106573200S	1		
C1392,1393	nsp	X7R)0.1UF-K/16V-1005REEL	D011104177101S	2		
C1394,1395	nsp	X7R)1000PF-K/50V-1005REEL	D011102177101S	2		
C1396	nsp	X5R)10UF-K/16V-2012REEL GRM21BR61C106KE15L	D011106573200S	1		
C1402	nsp	X7R)1000PF-K/50V-1005REEL	D011102177101S	1		
C1403,1404	nsp	X7R)0.1UF-K/16V-1005REEL	D011104177101S	2		
C1405	nsp	X7R)1000PF-K/50V-1005REEL	D011102177101S	1		
C1406	nsp	X7R)0.1UF-K/16V-1005REEL	D011104177101S	1		
C1407,1408	nsp	X7R)1000PF-K/50V-1005REEL	D011102177101S	2		
C1409	nsp	X7R)0.1UF-K/16V-1005REEL	D011104177101S	1		
C1410	nsp	X7R)1000PF-K/50V-1005REEL	D011102177101S	1		
C1411,1412	nsp	X7R)0.1UF-K/16V-1005REEL	D011104177101S	2		
C1413	nsp	X7R)1000PF-K/50V-1005REEL	D011102177101S	1		
C1414	nsp	X7R)0.1UF-K/16V-1005REEL	D011104177101S	1		
C1415,1416	nsp	X7R)1000PF-K/50V-1005REEL	D011102177101S	2		
C1417	nsp	X7R)0.1UF-K/16V-1005REEL	D011104177101S	1		
C1418	nsp	X7R)1000PF-K/50V-1005REEL	D011102177101S	1		
C1419	nsp	X7R)0.1UF-K/16V-1005REEL	D011104177101S	1		
C1420	nsp	X7R)1000PF-K/50V-1005REEL	D011102177101S	1		
C1421	nsp	X7R)0.1UF-K/16V-1005REEL	D011104177101S	1		
C1422	nsp	X7R)1000PF-K/50V-1005REEL	D011102177101S	1		
C1423	nsp	X7R)0.1UF-K/16V-1005REEL	D011104177101S	1		
C1424	nsp	X7R)1000PF-K/50V-1005REEL	D011102177101S	1		
C1425	nsp	X7R)0.1UF-K/16V-1005REEL	D011104177101S	1		
C1426	nsp	X7R)1000PF-K/50V-1005REEL	D011102177101S	1		
C1427	nsp	X7R)0.1UF-K/16V-1005REEL	D011104177101S	1		
C1428-1431	nsp	X7R)1000PF-K/50V-1005REEL	D011102177101S	4		
C1432,1433	nsp	X7R)0.1UF-K/16V-1005REEL	D011104177101S	2		
C1434	nsp	X7R)1000PF-K/50V-1005REEL	D011102177101S	1		
C1435,1436	nsp	X7R)0.1UF-K/16V-1005REEL	D011104177101S	2		
C1437	nsp	X7R)1000PF-K/50V-1005REEL	D011102177101S	1		
C1438	nsp	X7R)0.1UF-K/16V-1005REEL	D011104177101S	1		
C1439	nsp	X7R)1000PF-K/50V-1005REEL	D011102177101S	1		
C1440	nsp	X7R)0.1UF-K/16V-1005REEL	D011104177101S	1		
C1441-1443	nsp	X7R)1000PF-K/50V-1005REEL	D011102177101S	3		
C1444,1445	nsp	X7R)0.1UF-K/16V-1005REEL	D011104177101S	2		
C1446-1448	nsp	X7R)1000PF-K/50V-1005REEL	D011102177101S	3		
C1449,1450	nsp	X7R)0.1UF-K/16V-1005REEL	D011104177101S	2		
C1451	nsp	X7R)1000PF-K/50V-1005REEL	D011102177101S	1		
C1452	nsp	X7R)0.1UF-K/16V-1005REEL	D011104177101S	1		
C1453	nsp	X7R)1000PF-K/50V-1005REEL	D011102177101S	1		
C1454	nsp	X7R)0.1UF-K/16V-1005REEL	D011104177101S	1		
C1455	nsp	X7R)1000PF-K/50V-1005REEL	D011102177101S	1		
C1456	nsp	X7R)0.1UF-K/16V-1005REEL	D011104177101S	1		
C1457,1458	nsp	X7R)1000PF-K/50V-1005REEL	D011102177101S	2		
C1459,1460	nsp	X7R)0.1UF-K/16V-1005REEL	D011104177101S	2		
C1461	nsp	X7R)1000PF-K/50V-1005REEL	D011102177101S	1		
C1462,1463	nsp	X7R)0.1UF-K/16V-1005REEL	D011104177101S	2		
C1464,1465	nsp	X7R)1000PF-K/50V-1005REEL	D011102177101S	2		
C1466-1468	nsp	X7R)0.1UF-K/16V-1005REEL	D011104177101S	3		
C1469-1472	nsp	X7R)1000PF-K/50V-1005REEL	D011102177101S	4		
C1473	nsp	X7R)0.1UF-K/16V-1005REEL	D011104177101S	1		
C1474	nsp	X7R)1000PF-K/50V-1005REEL	D011102177101S	1		
C1475	nsp	X7R)0.1UF-K/16V-1005REEL	D011104177101S	1		
C1476,1477	nsp	X7R)1000PF-K/50V-1005REEL	D011102177101S	2		
C1478-1480	nsp	X7R)0.1UF-K/16V-1005REEL	D011104177101S	3		
C1481-1483	nsp	X7R)1000PF-K/50V-1005REEL	D011102177101S	3		
C1484	nsp	X7R)0.1UF-K/16V-1005REEL	D011104177101S	1		
C1485,1486	nsp	X7R)1000PF-K/50V-1005REEL	D011102177101S	2		
C1487,1488	nsp	X7R)0.1UF-K/16V-1005REEL	D011104177101S	2		
C1489,1490	nsp	X7R)1000PF-K/50V-1005REEL	D011102177101S	2		
C1491,1492	nsp	X7R)0.1UF-K/16V-1005REEL	D011104177101S	2		
C1493	nsp	X7R)1000PF-K/50V-1005REEL	D011102177101S	1		
C1494	nsp	X7R)0.1UF-K/16V-1005REEL	D011104177101S	1		
C1495,1496	nsp	X7R)1000PF-K/50V-1005REEL	D011102177101S	2		
C1497,1498	nsp	X7R)0.1UF-K/16V-1005REEL	D011104177101S	2		
C1499	nsp	X7R)1000PF-K/50V-1005REEL	D011102177101S	1		
C1500,1501	nsp	X7R)4.7UF-K/6.3V-1608REEL	D011475571160S	2		
C1504,1505	nsp	X7R)4.7UF-K/6.3V-1608REEL	D011475571160S	2		
C1506,1507	nsp	X7R)1000PF-K/50V-1005REEL	D011102177101S	2		
C1508	nsp	X7R)0.1UF-K/16V-1005REEL	D011104177101S	1		
C1509	nsp	COG)12PF-J/50V-1005REEL	D011120167101S	1		
C1510	nsp	COG)10PF-D/50V-1005REEL	D011100117101S	1		
C1514	nsp	X7R)4.7UF-K/6.3V-1608REEL	D011475571160S	1		
C1515-1517	nsp	X7R)0.01UF-K/25V-1005REEL	D011103174101S	3		
C1518-1522	nsp	X7R)0.1UF-K/16V-1005REEL	D011104177101S	5		
C1523	nsp	X7R)0.01UF-K/25V-1005REEL	D011103174101S	1		
C1524,1525	nsp	X7R)0.1UF-K/16V-1005REEL	D011104177101S	2		
C1526	nsp	X7R)0.01UF-K/25V-1005REEL	D011103174101S	1		
C1527,1528	nsp	X7R)0.1UF-K/16V-1005REEL	D011104177101S	2		
C1529-1532	nsp	X7R)0.01UF-K/25V-1005REEL	D011103174101S	4		
C1534	nsp	X7R)4.7UF-K/6.3V-1608REEL	D011475571160S	1		
C1535	nsp	X7R)0.1UF-K/16V-1005REEL	D011104177101S	1		
C1536	nsp	X7R)0.01UF-K/25V-1005REEL	D011103174101S	1		
C1540	nsp	X7R)4.7UF-K/6.3V-1608REEL	D011475571160S	1		
C1541	nsp	X7R)0.1UF-K/16V-1005REEL	D011104177101S	1		
C1542	nsp	X7R)0.01UF-K/25V-1005REEL	D011103174101S	1		
C1543	nsp	X7R)4.7UF-K/6.3V-1608REEL	D011475571160S	1		
C1544	nsp	X7R)0.1UF-K/16V-1005REEL	D011104177101S	1		
C1545	nsp	X7R)0.01UF-K/25V-1005REEL	D011103174101S	1		
C1547	nsp	X7R)4.7UF-K/6.3V-1608REEL	D011475571160S	1		
C1548	nsp	X7R)0.1UF-K/16V-1005REEL	D011104177101S	1		

REF No.	Part No.	Part Name	Remarks	Q'ty	New	Ver
C1549	nsp	X7R)0.01UF-K/25V-1005REEL	D011103174101S	1		
C1551	nsp	X7R)4.7UF-K/6.3V-1608REEL	D011475571160S	1		
C1552	nsp	X7R)0.1UF-K/16V-1005REEL	D011104177101S	1		
C1553	nsp	X7R)0.01UF-K/25V-1005REEL	D011103174101S	1		
C1554	nsp	X7R)0.1UF-K/16V-1005REEL	D011104177101S	1		
C1555	nsp	X7R)4.7UF-K/6.3V-1608REEL	D011475571160S	1		
C1556-1561	nsp	X7R)0.1UF-K/16V-1005REEL	D011104177101S	6		
C1562-1565	nsp	X7R)0.01UF-K/25V-1005REEL	D011103174101S	4		
C1566	nsp	X7R)4.7UF-K/6.3V-1608REEL	D011475571160S	1		
C1567	nsp	X7R)0.1UF-K/16V-1005REEL	D011104177101S	1		
C1568	nsp	X7R)0.01UF-K/25V-1005REEL	D011103174101S	1		
C1569	nsp	X7R)4.7UF-K/6.3V-1608REEL	D011475571160S	1		
C1570	nsp	X7R)0.01UF-K/25V-1005REEL	D011103174101S	1		
C1571	nsp	X7R)0.1UF-K/16V-1005REEL	D011104177101S	1		
C1575	nsp	X7R)4.7UF-K/6.3V-1608REEL	D011475571160S	1		
C1576	nsp	X7R)0.1UF-K/16V-1005REEL	D011104177101S	1		
C1577	nsp	X7R)0.01UF-K/25V-1005REEL	D011103174101S	1		
C1580	nsp	X7R)4.7UF-K/6.3V-1608REEL	D011475571160S	1		
C1581	nsp	X7R)0.1UF-K/16V-1005REEL	D011104177101S	1		
C1582	nsp	X7R)0.01UF-K/25V-1005REEL	D011103174101S	1		
C1583	nsp	X7R)0.1UF-K/16V-1005REEL	D011104177101S	1		
C1585	nsp	X7R)4.7UF-K/6.3V-1608REEL	D011475571160S	1		
C1586	nsp	X7R)0.1UF-K/16V-1005REEL	D011104177101S	1		
C1587	nsp	X7R)0.01UF-K/25V-1005REEL	D011103174101S	1		
C1588	nsp	X7R)4.7UF-K/6.3V-1608REEL	D011475571160S	1		
C1589	nsp	X7R)0.01UF-K/25V-1005REEL	D011103174101S	1		
C1590-1592	nsp	X7R)0.1UF-K/16V-1005REEL	D011104177101S	3		
C1593	nsp	X7R)0.01UF-K/25V-1005REEL	D011103174101S	1		
C1594	nsp	X7R)0.1UF-K/16V-1005REEL	D011104177101S	1		
C1595	nsp	X7R)0.01UF-K/25V-1005REEL	D011103174101S	1		
C1596	nsp	X7R)4.7UF-K/6.3V-1608REEL	D011475571160S	1		
C1597	nsp	X7R)0.1UF-K/16V-1005REEL	D011104177101S	1		
C1598,1599	nsp	X7R)0.01UF-K/25V-1005REEL	D011103174101S	2		
C1600	nsp	X7R)0.1UF-K/16V-1005REEL	D011104177101S	1		
C1607	nsp	X7R)0.15uF-K/10V-1608REEL	D011154172160S	1		
C1608	nsp	X7R)0.012UF-K/50V-1608REEL	D011123177161S	1		
C1609	nsp	X7R)0.15uF-K/10V-1608REEL	D011154172160S	1		
C1610	nsp	X7R)0.012UF-K/50V-1608REEL	D011123177161S	1		
C1611,1612	nsp	COG7PF-D/50V-1608REEL	D010070117160S	2		
C1613	nsp	X7R)1000PF-K/50V-1005REEL	D011102177101S	1		
C1614	nsp	X7R)0.1UF-K/16V-1005REEL	D011104177101S	1		
C1615	nsp	X7R)1000PF-K/50V-1005REEL	D011102177101S	1		
C1616	nsp	COG33PF-J/50V-1005REEL	D011330167101S	1		
C1618	nsp	X7R)0.1UF-K/16V-1005REEL	D011104177101S	1		
C1620	nsp	X5R)10UF-K/16V-2012REEL GRM21BR61C106KE15L	D011106573200S	1		
C1629-1644	nsp	X7R)0.1UF-K/16V-1005REEL	D011104177101S	16		
C1645	nsp	X5R)10UF-K/16V-2012REEL GRM21BR61C106KE15L	D011106573200S	1		
C1654-1671	nsp	X7R)0.1UF-K/16V-1005REEL	D011104177101S	18		
C1672	nsp	X7R)1UF-K/10V-1608REEL	D011105772161S	1		
C1675	00D9630325402	470UF-MVG/6.3V,8.3*9.0*10 REEL (Z8158) SY	D050471081200S	1		
C1677,1678	nsp	X7R)0.1UF-K/16V-1005REEL	D011104177101S	2		
C1680	963134501220S	470UF-M/6.3V,8*10 RVO-6V471MG10P2U-R2 ELNA	D050471081330S	1		
C1681	nsp	X7R)0.1UF-K/16V-1005REEL	D011104177101S	1		
C1684,1685	nsp	X7R)0.1UF-K/16V-1005REEL	D011104177101S	2		
C1686	nsp	X5R)22UF-M/6.3V-2012REEL JMK212BJ226MG-T	D011226581203S	1		
C1687	nsp	X7R)1UF-K/10V-1608REEL	D011105772161S	1		
C1688	nsp	COG5PF-C/50V-1005REEL	D011050107101S	1		
C1689	nsp	X5R)22UF-M/6.3V-2012REEL JMK212BJ226MG-T	D011226581203S	1		
C1690	nsp	X5R)10UF-K/16V-2012REEL GRM21BR61C106KE15L	D011106573200S	1		
C1691	00D9630338606	10UF-MVG/16V,3.3*3.7*5.2 REEL (Z8154) SY	D050100083470S	1		
C1693	nsp	X7R)1UF-K/10V-1608REEL	D011105772161S	1		
C1694,1695	nsp	X7R)0.1UF-K/16V-1005REEL	D011104177101S	2		
C1696	nsp	X5R)22UF-M/6.3V-2012REEL JMK212BJ226MG-T	D011226581203S	1		
C1697	nsp	COG5PF-C/50V-1005REEL	D011050107101S	1		
C1698	nsp	X5R)2.2UF-K/16V-1608REEL GRM188R61C225KE15D	D011225573160S	1		
C1699,1700	nsp	X7R)0.1UF-K/16V-1005REEL	D011104177101S	2		
C1701	nsp	X5R)22UF-M/6.3V-2012REEL JMK212BJ226MG-T	D011226581203S	1		
C1702	nsp	X7R)1UF-K/10V-1608REEL	D011105772161S	1		
C1703	nsp	X5R)10UF-K/16V-2012REEL GRM21BR61C106KE15L	D011106573200S	1		
C1704	00D9630338606	10UF-MVG/16V,3.3*3.7*5.2 REEL (Z8154) SY	D050100083470S	1		
C1705	nsp	X7R)1UF-K/10V-1608REEL	D011105772161S	1		
C1707	nsp	X7R)0.1UF-K/16V-1005REEL	D011104177101S	1		
C1708	nsp	X7R)0.015UF-K/50V-1608REEL	D01115377160S	1		
C1709,1710	nsp	X7R)0.1UF-K/16V-1005REEL	D011104177101S	2		
C1713	nsp	X7R)1000PF-K/50V-1005REEL	D011102177101S	1		
C1714	nsp	X5R)22UF-M/6.3V-2012REEL JMK212BJ226MG-T	D011226581203S	1		
C1715	nsp	COG5PF-C/50V-1005REEL	D011050107101S	1		
C1717	nsp	X7R)0.1UF-K/16V-1005REEL	D011104177101S	1		
C1718	nsp	X5R)22UF-M/6.3V-2012REEL JMK212BJ226MG-T	D011226581203S	1		
C1719	nsp	X7R)1UF-K/10V-1608REEL	D011105772161S	1		
C1720	nsp	X5R)10UF-K/16V-2012REEL GRM21BR61C106KE15L	D011106573200S	1		
C1722	nsp	X7R)0.1UF-K/16V-1005REEL	D011104177101S	1		
C1723	nsp	X5R)22UF-M/6.3V-2012REEL JMK212BJ226MG-T	D011226581203S	1		
C1724	nsp	COG5PF-C/50V-1005REEL	D011050107101S	1		
C1726	nsp	X7R)1UF-K/10V-1608REEL	D011105772161S	1		
C1727	nsp	X7R)0.1UF-K/16V-1005REEL	D011104177101S	1		
C1728	nsp	X5R)2.2UF-K/16V-1608REEL GRM188R61C225KE15D	D011225573160S	1		
C1729	nsp	X7R)0.1UF-K/16V-1005REEL	D011104177101S	1		
C1730	nsp	X5R)22UF-M/6.3V-2012REEL JMK212BJ226MG-T	D011226581203S	1		
C1731	nsp	X7R)1UF-K/10V-1608REEL	D011105772161S	1		
C1732	nsp	X5R)10UF-K/16V-2012REEL GRM21BR61C106KE15L	D011106573200S	1		
C1734	nsp	X7R)0.1UF-K/16V-1005REEL	D011104177101S	1		
C1735	nsp	X5R)22UF-M/6.3V-2012REEL JMK212BJ226MG-T	D011226581203S	1		
C1736	nsp	COG5PF-C/50V-1005REEL	D011050107101S	1		
C1737,1738	nsp	X7R)0.1UF-K/16V-1005REEL	D011104177101S	2		
C1739	nsp	X5R)22UF-M/6.3V-2012REEL JMK212BJ226MG-T	D011226581203S	1		
C1740	nsp	X7R)1UF-K/10V-1608REEL	D011105772161S	1		
C1741	nsp	X5R)10UF-K/16V-2012REEL GRM21BR61C106KE15L	D011106573200S	1		
C1744	nsp	X5R)22UF-M/6.3V-2012REEL JMK212BJ226MG-T	D011226581203S	1		
C1745	nsp	COG5PF-C/50V-1005REEL	D011050107101S	1		
C1746,1747	nsp	X7R)0.1UF-K/16V-1005REEL	D011104177101S	2		
C1749	nsp	X7R)0.1UF-K/16V-1005REEL	D011104177101S	1		

REF No.	Part No.	Part Name	Remarks	Q'ty	New	Ver
C1750	nsp	X5R)22UF-M/6.3V-2012REEL JMK212BJ226MG-T		D011226581203S	1	
C1751,1752	nsp	X7R)0.1UF-K/16V-1005REEL		D011104177101S	2	
C1753	nsp	X7R)1UF-K/10V-1608REEL		D011105772161S	1	
C1754	nsp	X5R)22UF-M/6.3V-2012REEL JMK212BJ226MG-T		D011226581203S	1	
C1755	nsp	COG)5PF-C/50V-1005REEL		D011050107101S	1	
C1756,1757	nsp	X5R)10UF-K/16V-2012REEL GRM21BR61C106KE15L		D011106573200S	2	
C1758	nsp	X7R)0.1UF-K/16V-1005REEL		D011104177101S	1	
C1759,1760	nsp	X5R)22UF-M/6.3V-2012REEL JMK212BJ226MG-T		D011226581203S	2	
C1761,1762	nsp	COG)5PF-C/50V-1005REEL		D011050107101S	2	
C1763,1764	nsp	X5R)10UF-K/16V-2012REEL GRM21BR61C106KE15L		D011106573200S	2	
C1766,1767	nsp	X7R)0.1UF-K/16V-1005REEL		D011104177101S	2	
C1769	00D9630338606	10UF-MVG/16V.3.3*3.7*5.2 REEL (Z8154) SY		D050100083470S	1	
C1770	nsp	X5R)22UF-M/6.3V-2012REEL JMK212BJ226MG-T		D011226581203S	1	
C1771	nsp	X7R)0.1UF-K/16V-1005REEL		D011104177101S	1	
C1773-1775	nsp	X7R)0.1UF-K/16V-1005REEL		D011104177101S	3	
C1777	nsp	X5R)22UF-M/6.3V-2012REEL JMK212BJ226MG-T		D011226581203S	1	
C1779	nsp	X5R)22UF-M/6.3V-2012REEL JMK212BJ226MG-T		D011226581203S	1	
C1782,1783	nsp	X7R)1UF-K/10V-1608REEL		D011105772161S	2	
C1784	nsp	X7R)0.1UF-K/16V-1005REEL		D011104177101S	1	
C1785	nsp	X7R)1UF-K/10V-1608REEL		D011105772161S	1	
C1787	nsp	X5R)22UF-M/6.3V-2012REEL JMK212BJ226MG-T		D011226581203S	1	
C1788	nsp	X7R)1UF-K/10V-1608REEL		D011105772161S	1	
C1789	nsp	X7R)0.1UF-K/16V-1005REEL		D011104177101S	1	
C1790	nsp	X5R)22UF-M/6.3V-2012REEL JMK212BJ226MG-T		D011226581203S	1	
C1791	nsp	COG)5PF-C/50V-1005REEL		D011050107101S	1	
C1796	nsp	X7R)0.1UF-K/16V-1005REEL		D011104177101S	1	
C1797	nsp	X5R)10UF-K/16V-2012REEL GRM21BR61C106KE15L		D011106573200S	1	
C1802	nsp	X7R)0.1UF-K/16V-1005REEL		D011104177101S	1	
C1807	nsp	X7R)0.01UF-K/25V-1005REEL		D011103174101S	1	
C1826-1828	nsp	X7R)1000PF-K/50V-1005REEL		D011102177101S	3	
C1852	nsp	X7R)0.1UF-K/16V-1005REEL		D011104177101S	1	
C1973,1974	nsp	X7R)4.7UF-K/6.3V-1608REEL		D011475571160S	2	
C1979,1980	nsp	X7R)4.7UF-K/6.3V-1608REEL		D011475571160S	2	
C1989-1992	nsp	X7R)4.7UF-K/6.3V-1608REEL		D011475571160S	4	
C1999,2000	nsp	X7R)4.7UF-K/6.3V-1608REEL		D011475571160S	2	
C2002-2011	nsp	X7R)0.1UF-K/16V-1005REEL		D011104177101S	10	
C2012,2013	nsp	X7R)4.7UF-K/6.3V-1608REEL		D011475571160S	2	
C2018,2019	nsp	X7R)4.7UF-K/6.3V-1608REEL		D011475571160S	2	
C2024	nsp	X7R)1UF-K/10V-1608REEL		D011105772161S	1	
C2025-2028	nsp	X7R)0.1UF-K/16V-1005REEL		D011104177101S	4	
C2029	nsp	X7R)1UF-K/10V-1608REEL		D011105772161S	1	
C2030,2031	nsp	X7R)0.1UF-K/16V-1005REEL		D011104177101S	2	
C2032	nsp	X7R)1UF-K/10V-1608REEL		D011105772161S	1	
C2033-2035	nsp	X7R)0.1UF-K/16V-1005REEL		D011104177101S	3	
C2036	nsp	X7R)1UF-K/10V-1608REEL		D011105772161S	1	
C2037,2038	nsp	X7R)0.1UF-K/16V-1005REEL		D011104177101S	2	
C2040,2041	nsp	X7R)0.1UF-K/16V-1005REEL		D011104177101S	2	
C2042-2044	nsp	X7R)1UF-K/10V-1608REEL		D011105772161S	3	
C2045-2050	nsp	X7R)0.1UF-K/16V-1005REEL		D011104177101S	6	
C2051	nsp	X7R)1000PF-K/50V-1005REEL		D011102177101S	1	
C2052	nsp	COG)10PF-D/50V-1005REEL		D011100117101S	1	
C2055	nsp	COG)10PF-D/50V-1005REEL		D011100117101S	1	
C2056	nsp	X7R)1000PF-K/50V-1005REEL		D011102177101S	1	
C2057	nsp	X7R)0.1UF-K/16V-1005REEL		D011104177101S	1	
C2058,2059	00D9630338606	10UF-MVG/16V.3.3*3.7*5.2 REEL (Z8154) SY		D050100083470S	2	
C2060,2061	nsp	X7R)0.1UF-K/16V-1005REEL		D011104177101S	2	
C2062	00D9630338606	10UF-MVG/16V.3.3*3.7*5.2 REEL (Z8154) SY		D050100083470S	1	
C2063	nsp	COG)12PF-G/50V-1005REEL GRM1555C1H120GA01D		D010120157100S	1	
C2064	nsp	COG)15PF-G/50V-1005REEL GRM1555C1H150GA01D		D010150157100S	1	
C2065	nsp	COG)0.068UF-J/50V-3216REEL GRM31C5C1H683JA01L		D010683167300S	1	
C2066	nsp	X7R)0.1UF-K/16V-1005REEL		D011104177101S	1	
C2067	nsp	COG)4700PF-J/50V-2012REEL GRM2165C1H472JA01D		D010472167200S	1	
C2068,2069	nsp	X7R)0.1UF-K/16V-1005REEL		D011104177101S	2	
C2070,2071	nsp	X7R)0.1UF-K/25V-1608REEL		D011104774161S	2	
C2072,2073	00D9630338606	10UF-MVG/16V.3.3*3.7*5.2 REEL (Z8154) SY		D050100083470S	2	
C2074	nsp	X7R)0.1UF-K/16V-1005REEL		D011104177101S	1	
C2076-2083	nsp	X7R)0.1UF-K/16V-1005REEL		D011104177101S	8	
C2085	nsp	X7R)4.7UF-K/6.3V-1608REEL	E3	D011475571160S	1	
C2086	nsp	X7R)0.1UF-K/16V-1005REEL	E3	D011104177101S	1	
C2088	nsp	X7R)0.01UF-K/25V-1005REEL	E3	D011103174101S	1	
C2090-2102	nsp	X7R)0.1UF-K/16V-1005REEL		D011104177101S	13	
C2103	00D9630325305	47UF-MVG/6.3V.4*3*5.1*5.3 REEL (Z8155) SY		D050470081460S	1	
C2104,2105	00D9630338606	10UF-MVG/16V.3.3*3.7*5.2 REEL (Z8154) SY		D050100083470S	2	
C2110,2111	nsp	X7R)0.1UF-K/16V-1005REEL		D011104177101S	2	
C2112-2136	nsp	X7R)1000PF-K/50V-1005REEL		D011102177101S	25	
C2143	nsp	X5R)10UF-K/16V-2012REEL GRM21BR61C106KE15L		D011106573200S	1	
C2147	nsp	X7R)0.1UF-K/16V-1005REEL		D011104177101S	1	
C2150	nsp	X7R)1UF-K/10V-1608REEL		D011105772161S	1	
C2154	nsp	X7R)1UF-K/10V-1608REEL		D011105772161S	1	
C2156	nsp	X7R)0.1UF-K/16V-1005REEL		D011104177101S	1	
C2159,2160	nsp	X7R)1UF-K/10V-1608REEL		D011105772161S	2	
C2161	nsp	X5R)2.2UF-K/16V-1608REEL GRM188R61C225KE15D		D011225573160S	1	
C2163	00D9630325305	47UF-MVG/6.3V.4*3*5.1*5.3 REEL (Z8155) SY		D050470081460S	1	
C2165	963134000450S	100UF-MVG/16V.6.6*7.2*5.7 REEL (Z8157) SY		D050101083660S	1	
C2168,2169	nsp	X7R)0.1UF-K/16V-1005REEL		D011104177101S	2	
C2174,2175	nsp	X7R)0.1UF-K/16V-1005REEL		D011104177101S	2	
C2176	00D9630338606	10UF-MVG/16V.3.3*3.7*5.2 REEL (Z8154) SY		D050100083470S	1	
C2177	nsp	X7R)2200PF-K/50V-1005REEL		D011222177101S	1	
C2178,2179	nsp	X5R)2.2UF-M/6.3V-1005REEL		D011225581100S	2	
C2181	nsp	X7R)2200PF-K/50V-1005REEL		D011222177101S	1	
C2187-2192	nsp	X7R)0.1UF-K/16V-1005REEL		D011104177101S	6	
C2193	nsp	X7R)0.01UF-K/25V-1005REEL		D011103174101S	1	
C2194-2200	nsp	X7R)0.1UF-K/16V-1005REEL		D011104177101S	7	
C2201	nsp	X7R)4.7UF-K/6.3V-1608REEL		D011475571160S	1	
C2202	nsp	X7R)1000PF-K/50V-1005REEL		D011102177101S	1	
C2203-2208	nsp	X7R)0.1UF-K/16V-1005REEL		D011104177101S	6	
C2209	nsp	X7R)0.01UF-K/25V-1005REEL		D011103174101S	1	
C2210	nsp	X7R)0.1UF-K/16V-1005REEL		D011104177101S	1	
C2211,2212	nsp	X7R)0.01UF-K/25V-1005REEL		D011103174101S	2	
C2213	nsp	X7R)4.7UF-K/6.3V-1608REEL		D011475571160S	1	
C2214	nsp	X7R)0.1UF-K/16V-1005REEL		D011104177101S	1	
C2215	nsp	X7R)0.01UF-K/25V-1005REEL		D011103174101S	1	

REF No.	Part No.	Part Name	Remarks	Q'ty	New	Ver
C2216	nsp	X7R)4.7UF-K/6.3V-1608REEL		D011475571160S	1	
C2217	nsp	X7R)1000PF-K/50V-1005REEL		D011102177101S	1	
C2218-2220	nsp	X7R)0.1UF-K/16V-1005REEL		D011104177101S	3	
C2221	nsp	X7R)0.01UF-K/25V-1005REEL		D011103174101S	1	
C2222	nsp	X7R)0.1UF-K/16V-1005REEL		D011104177101S	1	
C2223	nsp	X7R)0.01UF-K/25V-1005REEL		D011103174101S	1	
C2224	nsp	X7R)0.1UF-K/16V-1005REEL		D011104177101S	1	
C2225-2228	nsp	X7R)0.01UF-K/25V-1005REEL		D011103174101S	4	
C2229	nsp	X7R)0.1UF-K/16V-1005REEL		D011104177101S	1	
C2230	nsp	X7R)0.01UF-K/25V-1005REEL		D011103174101S	1	
C2231,2232	nsp	X7R)4.7UF-K/6.3V-1608REEL		D011475571160S	2	
C2234,2235	nsp	X7R)0.1UF-K/16V-1005REEL		D011104177101S	2	
C2236,2237	nsp	X7R)0.01UF-K/25V-1005REEL		D011103174101S	2	
C2240-2243	nsp	X7R)0.1UF-K/16V-1005REEL		D011104177101S	4	
C2244-2246	nsp	X7R)0.01UF-K/25V-1005REEL		D011103174101S	3	
C2247	nsp	X7R)0.1UF-K/16V-1005REEL		D011104177101S	1	
C2248,2249	nsp	X7R)0.01UF-K/25V-1005REEL		D011103174101S	2	
C2250,2251	nsp	X7R)0.1UF-K/16V-1005REEL		D011104177101S	2	
C2252,2253	nsp	X7R)0.01UF-K/25V-1005REEL		D011103174101S	2	
C2254	nsp	X7R)0.1UF-K/16V-1005REEL		D011104177101S	1	
C2255	nsp	X7R)4.7UF-K/6.3V-1608REEL		D011475571160S	1	
C2256,2257	nsp	X7R)0.1UF-K/16V-1005REEL		D011104177101S	2	
C2258	nsp	X7R)0.01UF-K/25V-1005REEL		D011103174101S	1	
C2259-2261	nsp	X7R)0.1UF-K/16V-1005REEL		D011104177101S	3	
C2262-2268	nsp	X7R)0.01UF-K/25V-1005REEL		D011103174101S	7	
C2269	nsp	X7R)4.7UF-K/6.3V-1608REEL		D011475571160S	1	
C2271,2272	nsp	X7R)0.1UF-K/16V-1005REEL		D011104177101S	2	
C2273,2274	nsp	X7R)0.01UF-K/25V-1005REEL		D011103174101S	2	
C2275,2276	nsp	X7R)0.1UF-K/16V-1005REEL		D011104177101S	2	
C2277-2280	nsp	X7R)0.01UF-K/25V-1005REEL		D011103174101S	4	
C2281	nsp	X7R)4.7UF-K/6.3V-1608REEL		D011475571160S	1	
C2282-2284	nsp	X7R)0.1UF-K/16V-1005REEL		D011104177101S	3	
C2285-2290	nsp	X7R)0.01UF-K/25V-1005REEL		D011103174101S	6	
C2291	nsp	X7R)4.7UF-K/6.3V-1608REEL		D011475571160S	1	
C2292	nsp	X7R)0.1UF-K/16V-1005REEL		D011104177101S	1	
C2293	nsp	X7R)0.01UF-K/25V-1005REEL		D011103174101S	1	
C2294	nsp	X7R)4.7UF-K/6.3V-1608REEL		D011475571160S	1	
C2295-2297	nsp	X7R)0.1UF-K/16V-1005REEL		D011104177101S	3	
C2298,2299	nsp	X7R)0.01UF-K/25V-1005REEL		D011103174101S	2	
C2300	nsp	X7R)4.7UF-K/6.3V-1608REEL		D011475571160S	1	
C2301-2303	nsp	X7R)0.1UF-K/16V-1005REEL		D011104177101S	3	
C2304	nsp	X7R)0.01UF-K/25V-1005REEL		D011103174101S	1	
C2305	nsp	X7R)4.7UF-K/6.3V-1608REEL		D011475571160S	1	
C2307	nsp	X7R)0.1UF-K/16V-1005REEL		D011104177101S	1	
C2308	nsp	X7R)0.01UF-K/25V-1005REEL		D011103174101S	1	
C2309	nsp	X7R)4.7UF-K/6.3V-1608REEL		D011475571160S	1	
C2311,2312	nsp	X7R)4.7UF-K/6.3V-1608REEL		D011475571160S	2	
C2320	nsp	X7R)0.1UF-K/25V-1608REEL		D011104774161S	1	
C2322	nsp	COG8PF-D/50V-1608REEL		D010080117160S	1	
C2323	nsp	COG7PF-D/50V-1608REEL		D010070117160S	1	
C2325	nsp	X7R)1UF-K/10V-1608REEL		D01110572161S	1	
C2327	nsp	X7R)0.1UF-K/16V-1005REEL		D011104177101S	1	
C2340	nsp	X7R)1000PF-K/50V-1005REEL		D011102177101S	1	
C2341	nsp	X7R)0.1UF-K/16V-1005REEL		D011104177101S	1	
C6000	nsp	COG)27PF-J/50V-1005REEL		D011270167101S	1	
C6001	nsp	COG)22PF-J/50V-1005REEL		D011220167101S	1	
C6002	nsp	X5R)10UF-K/16V-2012REEL GRM21BR61C106KE15L		D011106573200S	1	
C6003,6004	nsp	X7R)0.1UF-K/16V-1005REEL		D011104177101S	2	
C6005,6006	nsp	X7R)1UF-K/6.3V-1005REEL		D011105771100S	2	
C6007	nsp	X7R)0.1UF-K/16V-1005REEL		D011104177101S	1	
<b>OTHER PARTS GROUP</b>						
★	nsp	MINI JUMPER 2.00MM		L424010280210S	1	
★	nsp	AVR5900WBKE3 SPCC t0.8 Sn-Plating A4/HDMI FRONT		4010215996000S	1	
CLP1000-1002	nsp	HMX9800(ON)(HAI)AI (W=2.6,L=50)/WIRE(SOLDER)		4330000120000S	3	
CP6001	nsp	460MM/11P 20010HS-11=CKM2002HR-11 RD2725#24,28 SHL		L002461110010S	1	
K1000,1001	00D9630244703	EARPHONE JACK P.J-308-02	X2100E3	G40130802000YS	2	
K1003	963643003580S	RCA-107C-02(OR)	E3	G600107C0020YS	1	
L1000-1013	nsp	CB05YTYH221-2012REEL		D340201292210S	14	
L1016	nsp	CB05YTYH221-2012REEL		D340201292210S	1	
L1017,1018	nsp	DLW21SN900HQ2L COMMON MODE CHOKE COILS SMD2012		D311201219000S	2	
L1019	nsp	CB05YTYH221-2012REEL		D340201292210S	1	
L1027-1030	nsp	0-J,1/10W-2012REEL		C200000060200S	4	
L1034-1036	nsp	0-J,1/10W-2012REEL		C200000060200S	3	
L1037-1049	nsp	CB05YTYH221-2012REEL		D340201292210S	13	
L1051-1057	nsp	CB05YTYH221-2012REEL		D340201292210S	7	
L1058	nsp	CB03YTYN121-1608REEL		D340160891210S	1	
L1059-1077	nsp	CB05YTYH221-2012REEL		D340201292210S	19	
L1080-1088	nsp	CB05YTYH221-2012REEL		D340201292210S	9	
L1089	nsp	CB03YTYN121-1608REEL		D340160891210S	1	
L1090-1106	nsp	CB05YTYH221-2012REEL		D340201292210S	17	
L1109-1115	nsp	CB05YTYH221-2012REEL		D340201292210S	7	
L1119	nsp	EXC24CH900U 90OHM COMMON MODE SMD-REEL		D311121089000S	1	
L1123	nsp	EXC24CH900U 90OHM COMMON MODE SMD-REEL		D311121089000S	1	
L1124-1127	nsp	CB05YTYH221-2012REEL		D340201292210S	4	
L1136	nsp	0-J,1/10W-2012REEL		C200000060200S	1	
L6000,6001	nsp	CB05YTYH221-2012REEL		D340201292210S	2	
L6002	nsp	0-J,1/10W-2012REEL		C200000060200S	1	
N1000	nsp	1.0-16-23PB-2 23P ST SMT (JSY)		L130100162330S	1	
N1001-1007	963643102850S	HD 19F SMT-028 19P SMT HDMICON WITH FLANGE		L109100190280S	7	*
N1009	nsp	1.0-16-7PB-2 7P ST SMT (JSY)		L130100160730S	1	
N1010	963643102800S	RJ45-JACK(KR/J-015XXNL) KYD		G4060R/J450230S	1	*
N1011	nsp	1.0-16-7PB-2 7P ST SMT (JSY)		L130100160730S	1	
N1013	nsp	C125Z2-07 7P BtoB SOCKET(FEMALE) P=1.25MM		L109012520740S	1	*
N1014	nsp	C125Z2-23 23P BtoB SOCKET(FEMALE) P=1.25MM		L109012523340S	1	*
N1015	nsp	C125Z2-15 15P BtoB SOCKET(FEMALE) P=1.25MM		L109012521540S	1	*
N1016	nsp	C125Z2-23 23P BtoB SOCKET(FEMALE) P=1.25MM		L109012523340S	1	*
N1017	nsp	1.0-15-40PB 40P VER SMT		L130100154030S	1	
N1018	nsp	C125Z2-17 17P BtoB SOCKET(FEMALE) P=1.25MM		L109012521740S	1	*
N1019	nsp	20010WS-07A00 DIP7P STRAIGHT		L101200100710S	1	
N1021	nsp	1.0-16-11PB-2 11P ST SMT (JSY)		L130100161130S	1	
N1025	nsp	1.0-16-11PB-2 11P ST SMT (JSY)		L130100161130S	1	
N1026	963643102860S	HD 19F SMT-029 19P SMT HDMICON W/O FLANGE		L109100190290S	1	*

REF No.	Part No.	Part Name	Remarks		Q'ty	New	Ver
N1027	nsp	1.0-16-10PB-2 10P ST SMT (JSY)		L130100161030S	1		
N1028	nsp	1.0-16-7PB-2 7P ST SMT (JSY)		L130100160730S	1		
N1029	nsp	SMW250-5P DIP ST		L102050010040S	1		
N1030,1031	963643102850S	HD 19F SMT-028 19P SMT HDMICON WITH FLANGE		L109100190280S	2	*	
N1032	nsp	1.0-16-7PB-2 7P ST SMT (JSY)		L130100160730S	1		
N1033	nsp	C125Z2-11 11P BtoB SOCKET(FEMALE) P=1.25MM		L109012521140S	1	*	
N1034	nsp	1.0-16-6PB-2 6P ST SMT (JSY)		L130100160630S	1		
N1035	nsp	1.0-16-7PB-2 7P ST SMT (JSY)		L130100160730S	1		
N1036	nsp	20010WS-04A00 DIP4P STRAIGHT		L101200100410S	1		
N1038	nsp	1.0-16-23PB-2 23P ST SMT (JSY)		L130100162330S	1		
SW1	nsp	C12001-2020-03G-2537 HEADER P=2.0MM		L101012000310S	1		
X1000,1001	963141101180S	27.000MHz CL=7PF FA-238/SMD3225 EPSON		E80527R000050S	2	*	
X1003,1004	963141101160S	12.000MHz CL=8PF FA-238V/SMD3225 EPSON		E80512R000260S	2	*	
X1005	963141101170S	21.875MHz CL=8PF FA-238/SMD3225 EPSON		E80521R875260S	1	*	
X1006,1007	963141101180S	27.000MHz CL=7PF FA-238/SMD3225 EPSON		E80527R000050S	2	*	
X1008	963141100770S	24.576MHz CL=10PF FA-238/SMD3225 EPSON		E80524R576050S	1		
X1009	963141101180S	27.000MHz CL=7PF FA-238/SMD3225 EPSON		E80527R000050S	1	*	
X6000	963141101190S	32.768KHz CL=12.5PF FC-135/SMD3215 EPSON		E80532R768260S	1	*	

## CX870\_MIDDLE PCB ASS'Y

※Parts indicated by "nsp" on this table cannot be supplied.

※The parts listed below are only for maintenance. Therefore they might differ from the parts used in the unit in appearances or dimensions.

NOTE: The symbols in the column Remarks indicate the following destinations.

E3 : U.S.A. & Canada model E2 : Europe model E1C : China model E1 : Asia model K : Japan model

BK : Black model SP : Silver gold model

REF No.	Part No.	Part Name	Remarks	Q'ty	New	Ver
<b>SEMICONDUCTORS GROUP</b>						
U7000	963239101360S	BD82065FVJ CURRENT LIMIT 2.4A TSSOP-B8J		J046820650010S	1	*
<b>RESISTOR GROUP</b>						
R7002,7003	nsp	0-J,1/16W-2012REEL		C200000060200S	2	
R7004	nsp	10K-J,1/16W-1005REEL		C20001036M111S	1	
R7006,7007	nsp	0J*4 1/16W SMD(1005)		C180000040500S	2	
R7008,7009	nsp	0-J,1/16W-1005REEL		C20000006M101S	2	
R7010	nsp	0J*4 1/16W SMD(1005)		C180000040500S	1	
R7011-7013	nsp	0-J,1/16W-1005REEL		C20000006M101S	3	
R7014	nsp	10K-J,1/16W-1005REEL		C20001036M111S	1	
R7015	nsp	0-J,1/16W-1005REEL		C20000006M101S	1	
R7016	nsp	10K-J,1/16W-1005REEL		C20001036M111S	1	
R7021	nsp	10K-J,1/16W-1005REEL		C20001036M111S	1	
R7025-7027	nsp	0-J,1/16W-1005REEL		C20000006M101S	3	
R7028-7035	nsp	0-J,1/16W-1608REEL		C20000006M160S	8	
R7036,7037	nsp	2.2K-J,1/16W-1005REEL		C20002226M101S	2	
R7038	nsp	0-J,1/16W-1005REEL		C20000006M101S	1	
R7041	nsp	0-J,1/16W-1005REEL		C20000006M101S	1	
R7048-7052	nsp	0-J,1/16W-1005REEL		C20000006M101S	5	
<b>CAPACITORS GROUP</b>						
C7000	nsp	X7R)0.1UF-K/16V-1005REEL		D011104177101S	1	
C7005	nsp	X7R)0.1UF-K/16V-1005REEL		D011104177101S	1	
C7006-7010	nsp	X7R)10UF-K/6.3V-2012REEL		D011106771201S	5	
C7013,7014	nsp	X7R)0.1UF-K/16V-1005REEL		D011104177101S	2	
C7015,7016	nsp	X7R)1UF-K/10V-1608REEL		D011105772161S	2	
<b>OTHER PARTS GROUP</b>						
BKT7000,7001	nsp	AVRX2100BKE3 SPCC t0.5 Sn-Plating A4/SCREW L4.5		4010216006000S	2	
CLP7000	nsp	HMX9800(ON)(HAITAI) (W=2.6,L=50)/WIRE(SOLDER)		4330000120000S	1	
L7000,7001	nsp	CB05YTYH221-2012REEL		D340201292210S	2	
N7000	nsp	160MM/4P 20010HS-04=CKM2002HR-04 WH1007#26		L002161042630S	1	
N7001	nsp	14-5046-120-645-829+ BD TO BD CON 120P WITH TAPE		L136504601260S	1	
N7002	nsp	20010WR-05A00 DIP5P RIGHT ANGLE		L101200100520S	1	
N7003,7004	nsp	FEMALE HEADER 1.27MM 32*2P CSEC202-3202 B001 C1 AF		L109020232020S	2	
N7005	nsp	20010WR-11A00 DIP11P RIGHT ANGLE		L101200101120S	1	

## EXPLODE

※Parts indicated by "nsp" on this table cannot be supplied.

※The parts listed below are only for maintenance. Therefore they might differ from the parts used in the unit in appearances or dimensions.

NOTE: The symbols in the column Remarks indicate the following destinations.

E3 : U.S.A. & Canada model E2 : Europe model E1C : China model E1 : Asia model K : Japan model

BK : Black model SP : Silver gold model

REF No.	Part No.	Part Name	Remarks	Q'ty	New	Ver
<b>PCB GROUP</b>						
P13	9U6391013700D	HDMI PCB ASSY (E3) (FOR CX870)	X2100E3	7025HK1314026	1	*
P13	9U6391013800D	HDMI PCB ASSY (E2/E1) (FOR CX870)	E2/E1	7025HK1314016	1	*
P13	9U6391013900D	HDMI PCB ASSY (E1C) (FOR CX870)	E1C	7025HK1314036	1	*
P13	9U6391014000D	HDMI PCB ASSY (JP) (FOR CX870)	K	7025HK1314046	1	*
P13	9U6391013600D	HDMI PCB ASSY (S900W) (FOR CX870)	S900	7025HK1313016	1	*
HP01	F	PCB FRONT HDMI ASSY		7028074982010	1	
LP16	L	PCB BLUETOOTH ASSY		7028074983010	1	
P20	963639101400S	PCB CX870 MIDDLE ASSY	E3/JP	7025HK131501A	1	* Ver.2
P20	963639101860S	PCB CX870 MIDDLE ASSY	E2/E1C	7025HK131503A	1	* Ver.2
P21	963189100690D	CX870 MODULE ASSY (E3)	X2100E3	8952210000010	1	*
P21	963189100700D	CX870 MODULE ASSY (E2/E1)	E2/E1	8952210000020	1	*
P21	963189100710D	CX870 MODULE ASSY (E1C)	E1C	8952210000030	1	*
P21	963189100720D	CX870 MODULE ASSY (JP)	K	8952210000040	1	*
P21	963189100680D	CX870 MODULE ASSY (S900S)	S900	8952900000010	1	*
P02	-	PCB USB ASSY		-	-	*
P03	nsp	PCB FRONT ASSY		7028074931020	1	*
HP04	F	PCB FUNCTION ASSY		7028074932020	1	
HP05	F	PCB CNT ASSY		7028074933010	1	
HP06	F	PCB F/H_GUIDE ASSY		7028074936010	1	
HP17	F	PCB GUIDE L		7028074934010	1	
HP18	F	PCB TOP_GUIDE		7028074935010	1	
P19	L	PCB GUIDE R		7028074938010	1	
P07	nsp	PCB AMP ASSY		7028074971010	1	*
P08	nsp	PCB SMPS ASSY		7028074961020	1	*
P09	nsp	PCB MAIN ASSY		7028074921020	1	*
HP14	F	PCB RS232C ASSY	X2100E3	7028074922010	1	
LP15	L	PCB RS CNT ASSY	X2100E3	7028074923010	1	
P10	nsp	PCB INPUT ASSY		7028074951020	1	*
P11	nsp	PCB FRONT CNT ASSY		7028074942010	1	*
LP12	L	PCB VIDEO ASSY		7028074941020	1	
1	963446100780D	PANEL SUB&PLATE SUB X2100E3	X2100E3/K	4477212911000S	1	*
1	963446100790D	PANEL SUB&PLATE SUB X2100E2	E2/E1	4477212911010S	1	*
1	963446100800D	PANEL SUB&PLATE SUB X2100E1C	E1C	306721592101MS	1	*
1	963446100770D	PANEL SUB&PLATE SUB S900E3	S900	4477212901000S	1	*
2	963412100730D	KNOB VOLUME	BK	5080212641000S	1	* Ver.2
2	963412100740D	KNOB VOLUME	SP	50872126411000S	1	
3	963421100500D	BADGE IN-COMMAND	X2100E3	5630210878000S	1	*
4	963416101340D	WINDOW (E3/JP)	X2100E3/K	50772133330060S	1	*
4	963416101350D	WINDOW (E2/E1/E1C)	E2/E1/E1C	50772133330070S	1	*
4	963416101330D	WINDOW (S900W)	S900	50772133330050S	1	*
5	963421100510D	BADGE	X2100E3/K	5630210838200S	1	*
5	42151002100AD	BADGE	E2/E1/S900	5637210838000S	1	
5	42151002101AD	BADGE	E1C	5637210838010S	1	
6	963402104450D	PANEL FRONT X2100E3	X2100E3	3068216151000	1	* Ver.2
6	963402104460D	PANEL FRONT X2100E2	E2/E1	3068216141010	1	* Ver.2
6	963402104470D	PANEL FRONT X2100E1C	E1C	306821556150MS	1	* Ver.2
6	963402104480D	PANEL FRONT X2100K	K	3068216141020	1	* Ver.2
6	963402104440D	PANEL FRONT (S900W)	S900	3068216141000	1	* Ver.2
7	963411002820S	BUTTON POWER BK	BK	5098212361000SZ	1	
7	963411101790D	BUTTON POWER SP	SP	5097212368100SZ	1	
F	nsp	AVRE400BKE3 ABS BK/POWER		5090215301000S	1	
L	nsp	AVR390BKE3 ABS SPIN PI-0.16/ BUTTON		4500210351000S	1	
8	963423100500D	LENS STANDBY		3710211283100S	1	*
9	963411103160D	BUTTON 10KEY BK	BK	5090215381000S	1	*
9	963411101780D	BUTTON 10KEY SP	SP	5090215001000S	1	
10	nsp	BRACKET HDMI FRONT		4010216016000S	1	
11	nsp	PLATE USB		4470212696000S	1	
12	nsp	CHASSIS MAIN		3200214626200S	1	
!	963101102340D	POWER TRANS (E3)	E3	8200960611610S	1	*
!	963101102350D	POWER TRANS (E2/E1)	E2/E1	8200960611620S	1	*
!	963101102360D	POWER TRANS (E1C)	E1C	8200960611630S	1	*
!	963101102370D	POWER TRANS (JP)	K	8200960611640S	1	*
14	nsp	SUPPORTER PCB		4070001601010S	2	
15	00D9630214607	CUSHION FOOT		4050211295000S	4	
16	963407100200D	FOOT	E3/E1C/K	4000210261000S	4	
16	963407100420D	FOOT	E2/E1	4000210831000S	4	*
17	nsp	CHASSIS BACK X2100E3	X2100E3	3207214896100S	1	
17	nsp	CHASSIS BACK X2100E2	E2/E1	3207214896300S	1	
17	nsp	CHASSIS BACK X2100E1C	E1C	3207214896410S	1	
17	nsp	CHASSIS BACK X2100K	K	3207214896400S	1	
17	nsp	CHASSIS BACK S900E3	S900	3207214896000S	1	
18	nsp	STOPPER AC CORD	E1C/K/S900	4380040162010S	1	
!	963611500410S	AC CORD E1C	E1C	L068125071890S	1	
!	963611500570D	AC CORD K	K	L068125071890S	1	
!	00D963029220S	AC CORD E3	S900	L068125100320S	1	
20	nsp	HEATSINK MAIN	BK	212021204800TS	1	
20	nsp	HEATSINK MAIN	SP	212021204800DS	1	
21	nsp	BRACKET PCB		4010056906010S	5	
22	nsp	BRACKET SMPS		4010214886000S	1	
23	963403101100D	CABINET TOP BK	BK	3007212026100S	1	*
23	963403101110D	CABINET TOP SP	SP	3007212026110S	1	*
24	963412101090D	KNOB FUNCTION BK	BK	5080212631000S	1	
24	963412101091D	KNOB FUNCTION SP	SP	5087212631100S	1	
25	nsp	CUSHION CABINET SIDE		4050214795000S	2	
26	nsp	SHEET RATING CHASSIS		1210211909000S	1	
27	nsp	CUSHION SCREW		4050213025000S	3	
28	nsp	LABEL POP	X2100E3	5507000015680S	1	
28	nsp	LABEL POP	E2	5507000015690S	1	
28	nsp	LABEL POP	E1	5507000015720S	1	
28	nsp	LABEL POP	E1C	5507000015710S	1	
28	nsp	LABEL POP	K	5507000015700S	1	
28	nsp	LABEL POP	S900	5507000016110S	1	
29	nsp	ACETATE TAPE		1220211459000S	2	

REF No.	Part No.	Part Name	Remarks		Q'ty	New	Ver
30	963451101130D	SHEET PET CLEAR		1210211919000S	1		
31-1	nsp	DOUBLE TAPE(W:10mm)		A710000270000S	0.3		
31-2	nsp	DOUBLE TAPE(W:5mm)		A710000280000S	0.1		
32	963451101140D	SHEET PET CLEAR FUNCTION		1210211939000S	1		
33	nsp	GASKET		4400210609000S	1		
34	nsp	SPRING KNOB		3720210566000S	2		
35	963411103170D	BUTTON 6KEY	S900	5090215371000S	1	*	
36	963411103180D	BUTTON 4KEY	S900	5090215361000S	1	*	
37	nsp	SPEAKER REAR SHEET		1217212349000S	1		
38	963419100910S	BUSH,WIFI ANT		2410210161000S	2	*	
39	963419100920S	HOLDER,WIFI ANT		4320211391000S	2	*	
40	963419100930S	SUPPORTER,WIFI ANT		4070212301000S	2	*	
41-1	963116100530S	WIFI ANT(L) : wire 450mm		E600506600010S	1	*	
41-2	963116100540S	WIFI ANT(R) : wire 300mm		E600505600010S	1	*	
42	nsp	CUSHION		4050215205000S	1		
★	963606501980S	1.0*23*230*A(4/4/8/8)*(0.035*0.65) (AC+AL) SHIELD		N713232312480S	1		
★	963606502430D	1.0*40*190*A(4/4/8/8)*(0.035*0.65) AL SHIELD		N713401912490S	1	*	
★	nsp	AVRS900WBKE3EVA(BK) HD(20-25) 17*17*5T		4050215325000S	1		
<b>SEMICONDUCTORS GROUP</b>							
A1-Q404	00D9960018706	TR NPN 2SD2390-Y (2SD2390-Y and 2SB1560-Y is one pair parts.)		J5032390Y0000S	1		
A2-Q440	00D9960018706	TR NPN 2SD2390-Y (2SD2390-Y and 2SB1560-Y is one pair parts.)		J5032390Y0000S	1		
A3-Q428	00D9960018706	TR NPN 2SD2390-Y (2SD2390-Y and 2SB1560-Y is one pair parts.)		J5032390Y0000S	1		
A4-Q452	00D9960018706	TR NPN 2SD2390-Y (2SD2390-Y and 2SB1560-Y is one pair parts.)		J5032390Y0000S	1		
A5-Q416	00D9960018706	TR NPN 2SD2390-Y (2SD2390-Y and 2SB1560-Y is one pair parts.)		J5032390Y0000S	1		
A6-Q464	00D9960018706	TR NPN 2SD2390-Y (2SD2390-Y and 2SB1560-Y is one pair parts.)		J5032390Y0000S	1		
A7-Q476	00D9960018706	TR NPN 2SD2390-Y (2SD2390-Y and 2SB1560-Y is one pair parts.)		J5032390Y0000S	1		
B1-Q409	963219003340S	KTC3964/TO126S-BULK		J502396400010S	1		
B2-Q445	963219003340S	KTC3964/TO126S-BULK		J502396400010S	1		
B3-Q433	963219003340S	KTC3964/TO126S-BULK		J502396400010S	1		
B4-Q457	963219003340S	KTC3964/TO126S-BULK		J502396400010S	1		
B5-Q421	963219003340S	KTC3964/TO126S-BULK		J502396400010S	1		
B6-Q469	963219003340S	KTC3964/TO126S-BULK		J502396400010S	1		
B7-Q481	963219003340S	KTC3964/TO126S-BULK		J502396400010S	1		
C1-Q410	00D9960018706	TR PNP 2SB1560-Y (2SD2390-Y and 2SB1560-Y is one pair parts.)		J5011560Y0000S	1		
C2-Q446	00D9960018706	TR PNP 2SB1560-Y (2SD2390-Y and 2SB1560-Y is one pair parts.)		J5011560Y0000S	1		
C3-Q434	00D9960018706	TR PNP 2SB1560-Y (2SD2390-Y and 2SB1560-Y is one pair parts.)		J5011560Y0000S	1		
C4-Q458	00D9960018706	TR PNP 2SB1560-Y (2SD2390-Y and 2SB1560-Y is one pair parts.)		J5011560Y0000S	1		
C5-Q422	00D9960018706	TR PNP 2SB1560-Y (2SD2390-Y and 2SB1560-Y is one pair parts.)		J5011560Y0000S	1		
C6-Q470	00D9960018706	TR PNP 2SB1560-Y (2SD2390-Y and 2SB1560-Y is one pair parts.)		J5011560Y0000S	1		
C7-Q482	00D9960018706	TR PNP 2SB1560-Y (2SD2390-Y and 2SB1560-Y is one pair parts.)		J5011560Y0000S	1		
<b>SCREW GROUP</b>							
A	nsp	SCREW(+2S 3X8 ZNW/BH)		B020030081B10D	65		
B	nsp	SCREW(+2S 3X6 ZNW/BH)		B020030061B10S	4		
C	nsp	SCREW(+3S 3X8 BK/FH)		B020930083F10S	1		
D	nsp	SCREW(+2S 3X6 ROUND BK/BH)		B020230063B10S	7		
E	nsp	SCREW(+3S 3X8 BK/BH)		B020930083B10S	3		
F	nsp	NUT		-	2		
G	nsp	SCREW(+3S 4X10 P+S WASHER ROUND ZNW/BH)		B028940101B11S	4		
H	nsp	SCREW(+2S 3X14 P+S WASHER ZNW/HH)		B018230141H11D	21		
I	nsp	SCREW(+2S 3X17 ZNW/BH)		B020030171B10S	2		
J	nsp	SCREW(+2S 4X8 BK/BH DOT)	BK	1500040083B10S	8		
J	nsp	SCREW(+2S 4X8 NI/BH DOT)	SP	1500040084B10S	6		
K	nsp	SCREW(+2S 3X10 BK/BH DOT)		B020030103B11S	27		
L	nsp	SCREW(+3S 3X6(DOT)BK/BH)		B020930063B10S	10		
M	nsp	SCREW(+2S 3X8 9.5 ZNW/WH)		1500001206010D	2		



## PACKING

※Parts indicated by "nsp" on this table cannot be supplied.

※The parts listed below are only for maintenance. Therefore they might differ from the parts used in the unit in appearances or dimensions.

NOTE: The symbols in the column Remarks indicate the following destinations.

E3 : U.S.A. &amp; Canada model E2 : Europe model E1C : China model E1 : Asia model K : Japan model

BK : Black model SP : Silver gold model

REF No.	Part No.	Part Name	Remarks	Q'ty	New	Ver
2	nsp	PE.SHEET		6327040059000S	1	
3	30701016900AD	REMOCON (RC-1192)		8300119200010S	1	*
4	963533102390D	CUSHION SNOW (F/TOP)		6230213614000S	1	*
4	963533102400D	CUSHION SNOW (F/BTTM)		6230213624000S	1	*
4	963533102410D	CUSHION SNOW (R/TOP)		6230213634000S	1	*
4	963533102420D	CUSHION SNOW (R/BTTM)		6230213644000S	1	*
5	nsp	R03 AAA SIZE 1.5V		G670001R50242S	2	
6	32401000800AD	AUTO SETUP MIC ACM1HB		M040000310080S	1	
7	53121050300AM	BOX GIFT AVR-X2100(E3)	X2100E3	6007212470050S	1	*
7	53121050400AM	BOX GIFT AVR-X2100(E2)	E2	6007212470060S	1	*
7	53121050500AM	BOX GIFT AVR-X2100(E1)	E1	6007212460020S	1	*
7	53121050600AM	BOX GIFT AVR-X2100(E1C)	E1C	6007212470080S	1	*
7	53121050700AM	BOX GIFT AVR-X2100(K)	K	6007212470070S	1	*
7	53121050200AM	BOX-GIFT(S900W)	S900	6007212470090S	1	*
8	nsp	LABEL CONTROL		-	2	
9	nsp	WARRANTY CARD	K	5727000002003S	1	
9	nsp	WARRANTY CARD	S900	5727000000402S	1	
10	nsp	TAPE PACKING W:50(NEW TAPE:4.5kgf)		1220210772000S	1.5	
11	nsp	COLOR LABEL	SP	5507000004600S	2	
-	-	A4 SIZE POLYBAG ASSY		-	-	-
★	nsp	RD6108(A GROUP) 330*240*0.05 SILK JACK-HOLE		6337040062010S	1	
★	54311036000AD	SAFETY INSTRUCTIONS (NOTES ON RADIO)		5227000003160S	1	*
★	54311035900AD	SAFETY INSTRUCTIONS (E3)	E3	5227000003120S	1	*
★	nsp	SAFEY INST.	E2/E1	5227000003130S	1	*
★	nsp	SAFEY INST.	K	5227000003140S	1	*
★	nsp	SAFEY INST.	E1C	5227000003150S	1	*
★	nsp	S.S LIST	K	577200004001ES	1	
★	nsp	WARRANTY CARD(E3 ONLY)	E3	5727000003006S	1	
★	nsp	INSERTION SHEET(2100E3 ONLY)	X2100E3	5227000007700S	1	
★	963419100940S	SPK WIRE LABEL		5507000016170S	1	*
★	963116100550S	FM ANTENNA WIRE		E605010140050S	1	*
★	963116100560S	AM ANTENNA WIRE		E601019000050S	1	*
★	nsp	ANTENNA ISORATOR(E1C ONLY)	E1C	L170200060010S	1	*
-	-	A4 SIZE POLYBAG ASSY		-	-	-
★	nsp	LD 160*250 NO SILK ZIPPER		6330210719000S	1	
★	35201033500AD	INST. MANUAL (E3 CD-ROM)	X2100E3	6517000001880S	1	*
★	35201033501AD	INST. MANUAL (E2/E1 CD-ROM)	E2/E1	6517000001890S	1	*
★	35201033502AD	INST. MANUAL (E1C CD-ROM)	E1C	6517000001910S	1	*
★	35201033503AD	INST. MANUAL (JP CD-ROM)	K	6517000001900S	1	*
★	35201033504AD	INST. MANUAL (E3 CD-ROM)	S900	6517000001870S	1	*
★	54111118100AD	QUICK START GUIDE E3	X2100E3	5707000009160S	1	*
★	54111118101AD	QUICK START GUIDE E2/E1	E2/E1	5707000009170S	1	*
★	54111118102AD	QUICK START GUIDE E1C	E1C	5707000009190S	1	*
★	54111118103AD	QUICK START GUIDE JP	K	5707000009180S	1	*
★	54111118104AD	QUICK START GUIDE E3	S900	5707000009150S	1	*
12	963549101000D	MIC STAND ASSY		4148210170000S	1	*
┌	nsp	AVRX2100 PAPER WH A3/MIC BASE A		4140210170000S	1	
┌	nsp	AVRX2100WBKE3(DENON) PAPER WH A3/MIC BASE B		4140210180000S	1	
┌	nsp	AVRX2100WBKE3(DENON) PAPER WH A3/MIC BODY A		4140210190000S	1	
┌	nsp	AVRX2100WBKE3(DENON) PAPER WH A3/MIC BODY B		4140210200000S	1	
┌	nsp	AVRX2100WBKE3(DENON) PAPER WH A3/MIC BODY C		4140210210000S	1	
┌	nsp	AVR-X2100W(BKE3) / MIC STAND		5227000008170S	1	
13	nsp	LABEL MIC		5507000015960S	1	*
!	90M-ZC000470R	13A/125V ME302/VAC17S SJT 16AWG*2C 1.8M WH-STRAP	X2100E3	L068125130020S	1	
!	90M-ZC000600R	16A/250V M3204/VAC17S H05VVFC*1MM 1.8M WHSTRAP	E2/E1	L068250160120S	1	
15	nsp	BUSHING	E2E1/E1C	2410040353010S	1	
★	nsp	AVR-S900/X2100(ALL) 40X5 / MAC ADDRESS		5507000016380S	2	
★	nsp	AVR-S900/X2100(ALL) Bluetooth MAC ADDRESS(40X5)		5507000016670S	2	