

## SERVICE MANUAL

MODEL	JP	E3	E2	EK	EA	E1	E1C	E1K
AVR-X5200W		✓	✓				✓	

### INTEGRATED NETWORK AV RECEIVER

• For purposes of improvement, specifications and design are subject to change without notice.

• Please use this service manual with referring to the operating instructions without fail.

• Some illustrations using in this service manual are slightly different from the actual set.

# CONTENTS

<b>ABOUT THIS MANUAL</b> .....	3	<b>CLOCK FLOW &amp; WAVE FORM IN DIGITAL BLOCK</b> .....	115
What you can do with this manual.....	3	<b>LEVEL DIAGRAM</b> .....	116
Using Adobe Reader (Windows version).....	4	<b>GND DIAGRAM</b> .....	124
<b>SAFETY PRECAUTIONS</b> .....	6	<b>POWER DIAGRAM</b> .....	125
<b>NOTE FOR SCHEMATIC DIAGRAM</b> .....	7	<b>CPU DIAGRAM</b> .....	126
<b>NOTE FOR PARTS LIST</b> .....	7	<b>PRINTED WIRING BOARDS</b> .....	127
<b>TECHNICAL SPECIFICATIONS</b> .....	9	<b>SCHEMATIC DIAGRAMS (1/35)</b> .....	133
<b>DIMENSION</b> .....	9	SCH01_DIGITAL CONNECT.....	133
<b>Precautions During Service</b> .....	10	SCH02_DIR ADC ZONEDAC.....	134
Initializing This Unit.....	10	SCH03_AUDIO PLD.....	135
Service Jigs.....	10	SCH04_DSP1.....	136
<b>DISASSEMBLY</b> .....	11	SCH05_DSP2.....	137
1. FRONT PANEL ASSY.....	13	SCH06_DSP3.....	138
2. RADIATOR ASSY.....	14	SCH07_DSP4.....	139
3. SMPS ASSY.....	15	SCH08_MAIN CPU.....	140
4. POWER TRANS.....	16	SCH09_SUB CPU.....	141
5. BACK PANEL ASSY.....	17	SCH10_DECODER.....	142
<b>SPECIAL MODE</b> .....	18	SCH11_HDMI SW1.....	143
Special Mode Configuration Buttons.....	18	SCH12_HDMI SW2.....	144
1. Version Display Mode.....	19	SCH13_IP SCALER.....	145
2. PANEL / REMOTE LOCK Selection Mode.....	23	SCH14_IP SCALER DDR.....	146
3. Selection Modes for Service-related Operations.....	24	SCH15_VIDEO PLD.....	147
DIAGNOSTIC PATH DIAGRAM.....	31	SCH16_HDMI RX TX.....	148
4. Remote ID Setup Mode.....	74	SCH17_HDMI SUPPLY.....	149
5. Protection Pass Mode.....	75	SCH18_NETWORK.....	150
6. CX870 / CY920 Reboot Mode.....	75	SCH19_AUDIO VIDEO CONNECT.....	151
7. CX870 / CY920 Initialization Mode.....	76	SCH20_AUDIO VOLUME.....	152
<b>JIG FOR SERVICING</b> .....	77	SCH21_PREOUT.....	153
<b>Procedure after Replacing the Microprocessor, etc.</b> .....	79	SCH22_VIDEO SELECTOR.....	154
<b>Firmware Update Procedure</b> .....	79	SCH23_CONNECT.....	155
1. Updating by USB.....	79	SCH24_ZONEDAC ADC.....	156
2. Updating by DPMS.....	88	SCH25_MAIN DAC.....	157
<b>ADJUSTMENT</b> .....	95	SCH26_FRONT HDMI USB.....	158
<b>SURROUND MODES AND PARAMETERS</b> .....	96	SCH27_SPEAKER.....	159
<b>TROUBLE SHOOTING</b> .....	99	SCH28_REG.....	160
1. POWER.....	99	SCH29_FRONT.....	161
2. Analog video.....	100	SCH30_SMPS.....	162
3. HDMI/DVI.....	102	SCH31_AMP CONNECT.....	163
4. AUDIO.....	104	SCH32_232C PHONO.....	164
5. Network/Bluetooth/USB.....	107	SCH33_POWER AMP.....	165
6. SMPS.....	112	SCH34_CX870 CONNECT (CX870 Only).....	166
<b>Audio Check PASS</b> .....	114	SCH35_BT MODULE (CX870 Only).....	167
		<b>EXPLODED VIEW</b> .....	168
		<b>PACKING VIEW</b> .....	169
		<b>SEMICONDUCTORS</b> .....	170
		1. IC's.....	170
		2. FL DISPLAY.....	192

# ABOUT THIS MANUAL

Read the following information before using the service manual.

## What you can do with this manual

### Search for a Ref. No. (phrase) (Ctrl+Shift+F)

You can use the search function in Acrobat Reader to search for a Ref. No. in schematic diagrams, printed wiring circuit diagrams, block diagrams, and parts lists.

1. Press **Ctrl+Shift+F** on the keyboard.
- The Search window appears.

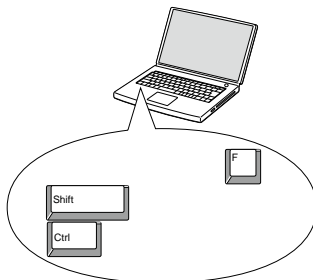

2. Enter the Ref. No. you want to search for in the Search window, and then click the **Search** button.
- A list of search results appears.

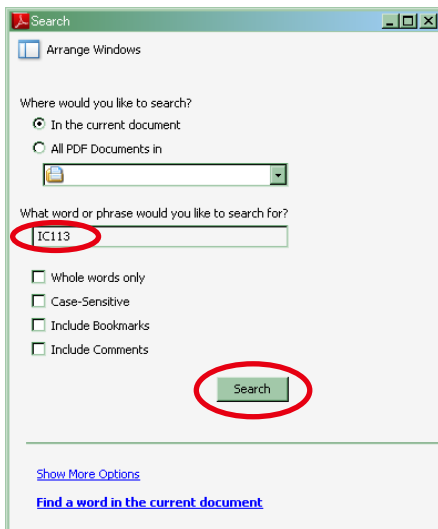

3. Click an item on the list.
- The screen jumps to the page for that item, and the search phrase is displayed.

### Jump to the target of a schematic diagram connector

- Click the Ref. No. of the target connector in the red box around a schematic diagram connector.
- The screen jumps to the target connector.

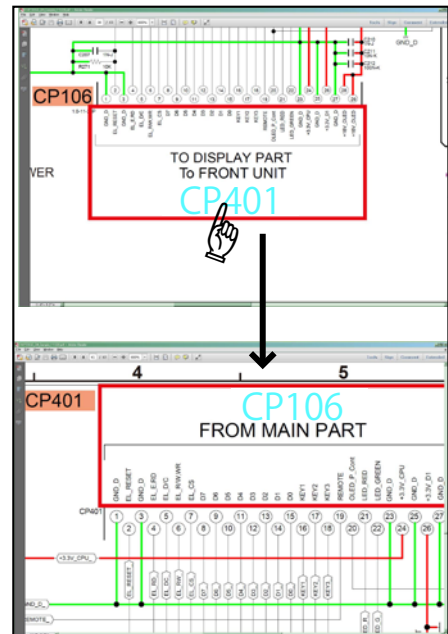

- Page magnification stays the same as before the jump.

## Using Adobe Reader (Windows version)

### Add notes to this data (Sign)

The Sign function lets you add notes to the data in this manual.

Save the file once you have finished adding notes.

#### [Example using Adobe Reader X]

On the "View" menu, click "Sign".

- The Sign pane appears.

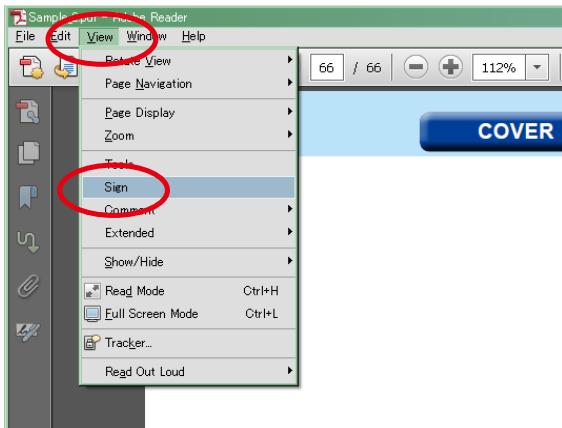

#### [Example using Adobe Reader 9]

On the "Document" menu, click "Sign".

### Magnify schematic / printed circuit board diagrams - 1

#### (Ctrl+Space, mouse operation)

Press **Ctrl+Space** on the keyboard and drag the mouse to select the area you want to view.

- The selected area is magnified.

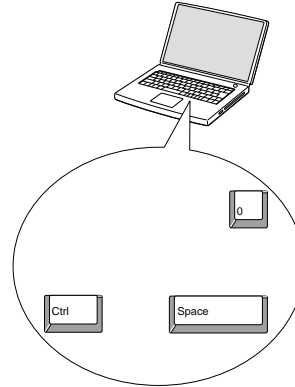

- When you want to move the area shown, hold down **Space** and drag the mouse.
- When you want to show a full page view, press **Ctrl+0** on the keyboard.

### Print a magnified part of the manual

The Properties dialog box and functions will vary depending on your printer.

1. Drag the mouse to magnify the part you want to print.
2. On the "File" menu, click "Print".
3. Configure the following settings in the Print dialog box.

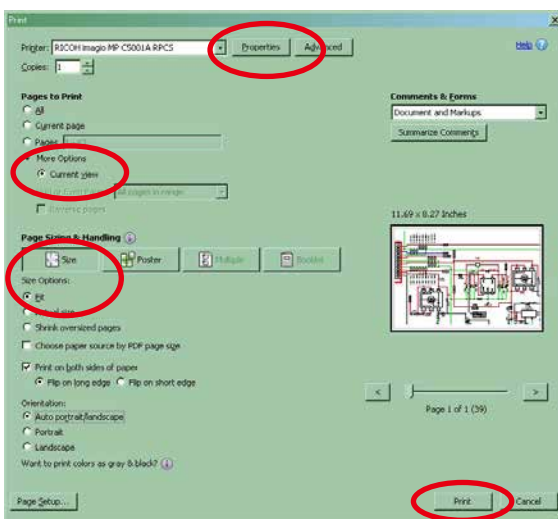

4. Click the **Print** button to start printing.

#### • Properties

Click this button and check that the printer is set to a suitable paper size.

#### • Page to print

Select the following checkbox.

"More Options" : "Current View"

#### • Page Sizing & Handling

Select the following checkbox.

"Size" / "Size Options" : "Fit"



## Magnify schematic / printed circuit board diagrams - 2

### (Pan & Zoom function)

The Pan & Zoom function lets you see which part of a magnified diagram is being shown in a separate window.

#### [Example using Adobe Reader X]

On the "View" menu, point to "Zoom", and then click "Pan & Zoom".

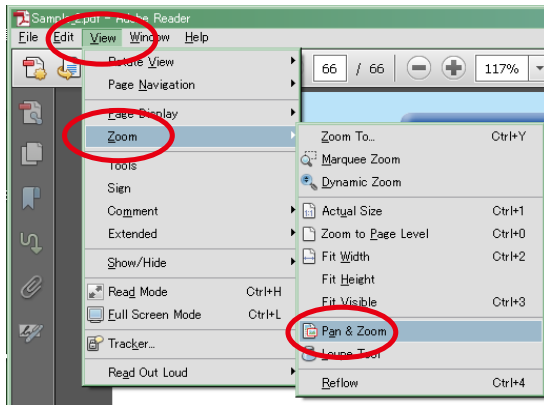

- The Pan & Zoom window appears on the screen.

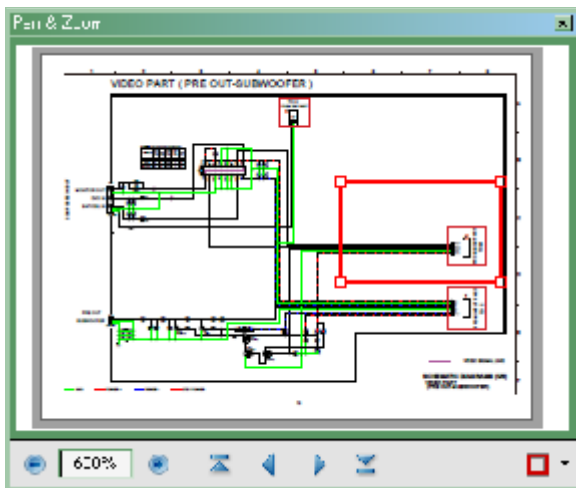

#### [Example using Adobe Reader 9]

On the "Tools" menu, point to "Select & Zoom", and then click "Pan & Zoom Window".

## Magnify schematic / printed circuit board diagrams - 3

### (Loupe Tool function)

The Loupe Tool function lets you magnify a specific part of a diagram in a separate window.

#### [Example using Adobe Reader X]

On the "View" menu, point to "Zoom", and then click "Loupe Tool".

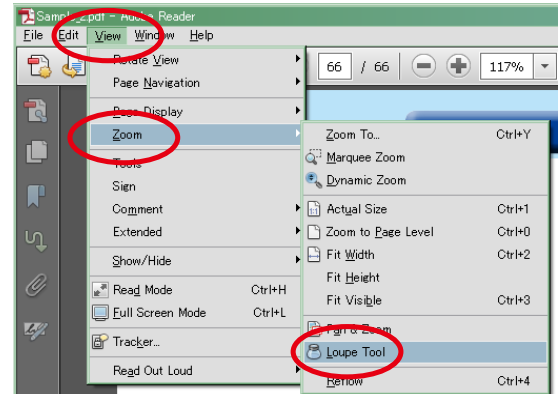

- The Loupe Tool window appears on the screen.

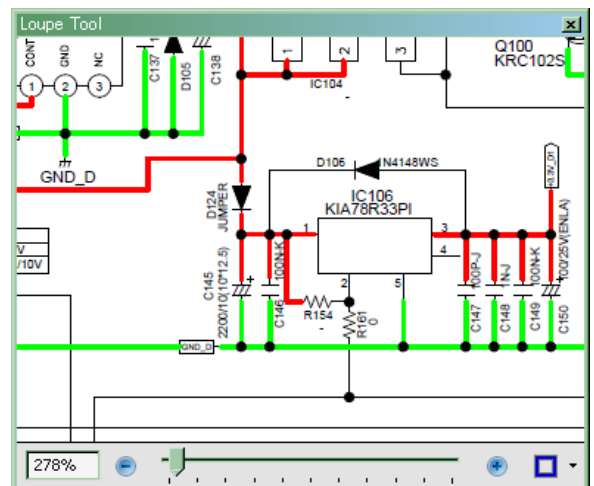

#### [Example using Adobe Reader 9]

On the "Tools" menu, point to "Select & Zoom", and then click "Loupe Tool Window".

## SAFETY PRECAUTIONS

The following items should be checked for continued protection of the customer and the service technician.

### leakage current check

Before returning the set to the customer, be sure to carry out either (1) a leakage current check or (2) a line to chassis resistance check. If the leakage current exceeds 0.5 milliamps, or if the resistance from chassis to either side of the power cord is less than 460 kohms, the set is defective.

Be sure to test for leakage current with the AC plug in both polarities, in addition, when the set's power is in each state (on, off and standby mode), if applicable.

## CAUTION Please heed the following cautions and instructions during servicing and inspection.

### ⊙ Heed the cautions!

Cautions which are delicate in particular for servicing are labeled on the cabinets, the parts and the chassis, etc. Be sure to heed these cautions and the cautions described in the handling instructions.

### ⊙ Cautions concerning electric shock!

- (1) An AC voltage is impressed on this set, so if you touch internal metal parts when the set is energized, you may get an electric shock. Avoid getting an electric shock, by using an isolating transformer and wearing gloves when servicing while the set is energized, or by unplugging the power cord when replacing parts, for example.
- (2) There are high voltage parts inside. Handle with extra care when the set is energized.

### ⊙ Caution concerning disassembly and assembly!

Through great care is taken when parts were manufactured from sheet metal, there may be burrs on the edges of parts. The burrs could cause injury if fingers are moved across them in some rare cases. Wear gloves to protect your hands.

### ⊙ Use only designated parts!

The set's parts have specific safety properties (fire resistance, voltage resistance, etc.). Be sure to use parts which have the same properties for replacement. The burrs have the same properties. In particular, for the important safety parts that are indicated by the ⚠ mark on schematic diagrams and parts lists, be sure to use the designated parts.

### ⊙ Be sure to mount parts and arrange the wires as they were originally placed!

For safety reasons, some parts use tapes, tubes or other insulating materials, and some parts are mounted away from the surface of printed circuit boards. Care is also taken with the positions of the wires by arranging them and using clamps to keep them away from heating and high voltage parts, so be sure to set everything back as it was originally placed.

### ⊙ Make a safety check after servicing!

Check that all screws, parts and wires removed or disconnected when servicing have been put back in their original positions, check that no serviced parts have deteriorate the area around. Then make an insulation check on the external metal connectors and between the blades of the power plug, and otherwise check that safety is ensured.

(Insulation check procedure)

Unplug the power cord from the power outlet, disconnect the antenna, plugs, etc., and on the power. Using a 500V insulation resistance tester, check that the insulation resistance value between the inplug and the externally exposed metal parts (antenna terminal, headphones terminal, input terminal, etc.) is 1MΩ or greater. If it is less, the set must be inspected and repaired.

## CAUTION Concerning important safety parts

Many of the electric and the structural parts used in the set have special safety properties. In most cases these properties are difficult to distinguish by sight, and the use of replacement parts with higher ratings (rated power and withstand voltage) does not necessarily guarantee that safety performance will be preserved. Parts with safety properties are indicated as shown below on the wiring diagrams and the parts list in this service manual. Be sure to replace them with the parts which have the designated part number.

- (1) Schematic diagrams.....Indicated by the ⚠ mark.
- (2) Parts lists.....Indicated by the ⚠ mark.

The use of parts other than the designated parts could cause electric shocks, fires or other dangerous situations.

## NOTE FOR SCHEMATIC DIAGRAM

### WARNING:

Parts indicated by the  $\triangle$  mark have critical characteristics. Use ONLY replacement parts recommended by the manufacturer.

### CAUTION:

Before returning the set to the customer, be sure to carry out either (1) a leakage current check or (2) a line to chassis resistance check. If the leakage current exceeds 0.5 milliamps, or if the resistance from chassis to either side of the power cord is less than 460 kohms, the set is defective.

### WARNING:

DO NOT return the set to the customer unless the problem is identified and remedied.

### NOTICE:

ALL RESISTANCE VALUES IN OHM. k=1,000 OHM / M=1,000,000 OHM

ALL CAPACITANCE VALUES ARE EXPRESSED IN MICRO FARAD, UNLESS OTHERWISE INDICATED. P INDICATES MICRO-MICRO FARAD. EACH VOLTAGE AND CURRENT ARE MEASURED AT NO SIGNAL INPUT CONDITION. CIRCUIT AND PARTS ARE SUBJECT TO CHANGE WITHOUT PRIOR NOTICE.

## NOTE FOR PARTS LIST

1. Parts indicated by "nsp" on this table cannot be supplied.
2. When ordering a part, make a clear distinction between "1" and "1" (i) to avoid mis-supplying.
3. A part ordered without specifying its part number can not be supplied.
4. Part indicated by "★" mark is not illustrated in the exploded view.

**WARNING:** Parts indicated by the  $\triangle$  mark have critical characteristics. Use ONLY replacement parts recommended by the manufacturer.

## INSTRUCTIONS FOR HANDLING SEMI-CONDUCTORS AND OPTICAL UNIT

Electrostatic breakdown of the semi-conductors or optical pickup may occur due to a potential difference caused by electrostatic charge during unpacking or repair work.

### 1. Ground for Human Body

Be sure to wear a grounding band (1 M $\Omega$ ) that is properly grounded to remove any static electricity that may be charged on the body.

### 2. Ground for Workbench

Be sure to place a conductive sheet or copper plate with proper grounding (1 M $\Omega$ ) on the workbench or other surface, where the semi-conductors are to be placed. Because the static electricity charge on clothing will not escape through the body grounding band, be careful to avoid contacting semi-conductors with your clothing

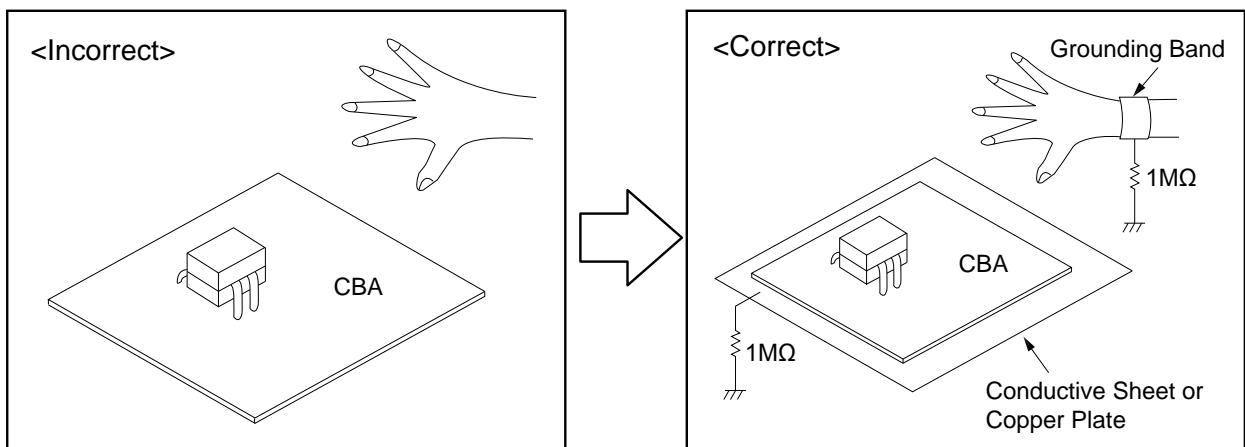



# TECHNICAL SPECIFICATIONS

## Audio section

### Power amplifier

#### Rated output :

##### Front :

140W+140W (8Ω, 20Hz - 20kHz with 0.05% T.H.D.)  
175W+175W (6Ω, 1kHz with 0.7% T.H.D.)

##### Center :

140W (8Ω, 20Hz - 20kHz with 0.05% T.H.D.)  
175W (6Ω, 1 kHz with 0.7 % T.H.D.)

##### Surround :

140W+140W (8Ω, 20 Hz - 20 kHz with 0.05% T.H.D.)  
175W+175W (6Ω, 1 kHz with 0.7 % T.H.D.)

#### Surround back / Height1 / Front wide / Height2:

140W+140W (8Ω, 20 Hz - 20 kHz with 0.05% T.H.D.)  
175W+175W (6Ω, 1 kHz with 0.7 % T.H.D.)

#### Rated output :

160 W x 2-channel (8 Ω)  
250 W x 2-channel (4 Ω)

#### Output connectors : 4 - 16Ω

## Analog section

**Input sensitivity/Input impedance :** 200 mV/47 kΩ

**Frequency response :** 10 Hz - 100 kHz — +1, -3 dB(Direct mode)

**S/N :** 102 dB(IHF-A weighted, Direct mode)

**Distortion :** 0.005 % (20 Hz - 20 kHz) (Direct mode)

**Rated output :** 1.2 V

## Digital section

**D/A output :** Rated output — 2 V (at 0 dB playback)  
Total harmonic distortion — 0.008 % (1 kHz, at 0 dB)  
S/N ratio — 102 dB  
Dynamic range — 100 dB

**Digital input :** Format — Digital audio interface

## Phono equalizer section

**Input sensitivity :** 2.5 mV

**RIAA deviation :** ±1 dB (20 Hz to 20 kHz)

**S/N :** 74 dB (IHF-A)

**Distortion factor :** 0.03 % (1 kHz, 3 V)

## Video section

### Standard video connectors

**Input/output level and impedance :** 1 Vp-p, 75 Ω

**Frequency response :** 5 Hz - 10 MHz — 0, -3 dB

### Color component video connector

**Input/output level and impedance :** Y signal — 1 Vp-p, 75 Ω  
PB / CB signal — 0.7 Vp-p, 75 Ω  
PR / CR signal — 0.7 Vp-p, 75 Ω

**Frequency response :** 5 Hz - 60 MHz — 0, -3 dB

## Tuner section

**Reception frequency range :** FM 87.5 MHz - 107.9 MHz(for E3)  
FM 87.5 MHz - 108.0 MHz(for E2, E1C)  
AM 530 kHz - 1710 kHz(for E3)  
AM 522 kHz - 1611 kHz(for E2, E1C)

**Effective sensitivity :** FM 1.5μV(14.8dBf)  
AM 20 μV

**50 dB sensitivity :** MONO — 2.8 μV (20.2 dBf)

**S/N ratio (IHF-A) :** MONO — 78 dB  
STEREO — 68 dB  
HD — FM 85dB AM 85dB

**Distortion (1 kHz) :** MONO — 0.1 %  
SRETEO — 0.2 %  
HD — FM 0.02% AM 0.02%

## Wireless LAN section

**Network type (wireless LAN standard):** Conforming to Wi-Fi®\*1

**Security :** WEP 64 bit, WEP 128 bit  
WPA/WPA2-PSK (AES)  
WPA/WPA2-PSK (TKIP)

**Radio frequency :** 2.4 GHz

**No. of channels :** 1 - 11 ch (for E3)  
1 - 13 ch (for E2, E1C)

\*1 The Wi-Fi® CERTIFIED Logo and the Wi-Fi CERTIFIED On-Product Logo are registered trademarks of the Wi-Fi Alliance.

## Bluetooth section

**Communications system :** Bluetooth Version 2.1 + EDR (Enhanced Data Rate)

**Transmission power :** Maximum 2.5 mW (Class 2)

**Maximum communication range :** Approx. 32.8 ft/10 m in line of sight

**Frequency band :** 2.4 GHz band

**Modulation scheme :** FHSS (Frequency-Hopping Spread Spectrum)

**Supported profiles :** A2DP 1.2 (Advanced Audio Distribution Profile)  
AVRCP 1.4 (Audio Video Remote Control Profile)

**Corresponding codec :** SBC, AAC

**Transmission range (A2DP) :** 20 Hz - 20,000 Hz

## General

**Power supply :** (for E3) : AC 120 V, 60 Hz  
(for E2) : AC 230 V, 50 Hz / 60Hz  
(for E1C) : AC 220 V, 50 Hz

**Power consumption :** 730W

**Power consumption in standby mode :** 0.1W

**Power consumption in CEC standby mode :** 0.5W

**Power consumption in network standby mode :** 4.5W

For purposes of improvement, specifications and design are subject to change without notice.

# DIMENSION

Unit : in. (mm) Weight : 31 lb 1 oz (14.1 kg)

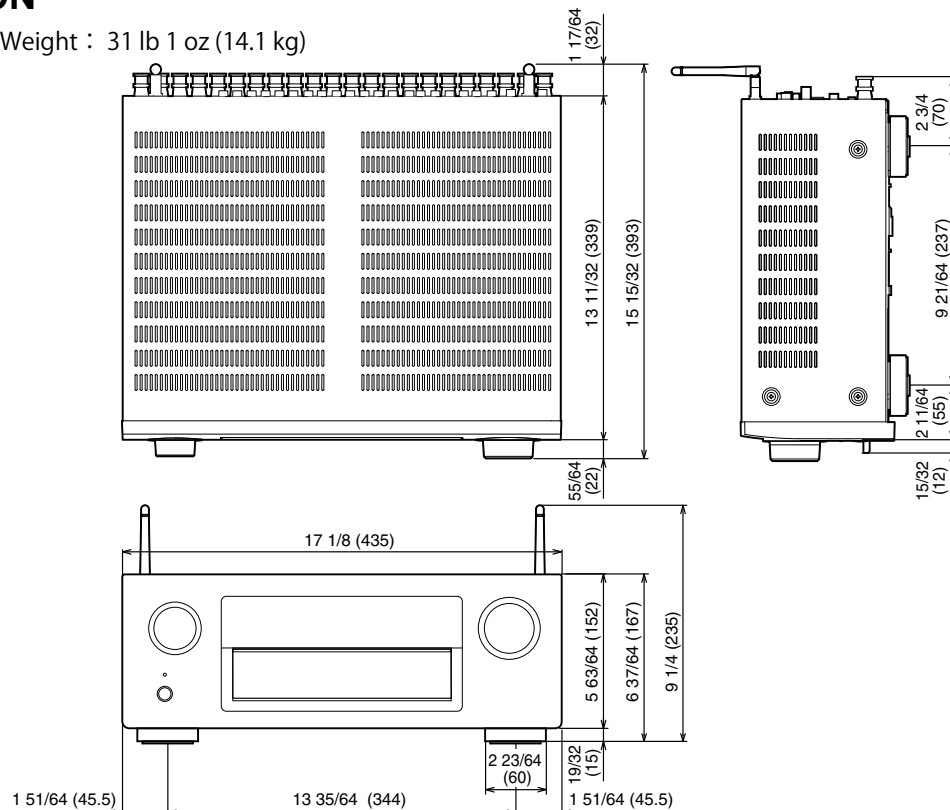

# PRECAUTIONS DURING SERVICE

## Initializing This Unit

Initialize this unit if you have replaced the microcomputer, one of the parts around the microcomputer, or the digital PCB.

1. Press the power button to turn off the power.
2. Hold down buttons "**CURSOR ▲**" and "**CURSOR ▼**" at the same time and press the power button to turn on the power.
3. Release the buttons after confirming that the display flashes in intervals of approximately 1 second.
  - \* The unit is initialized.

**NOTE :**

- If the status in step 3 does not occur, start again from step 1.
- Initializing the device restores settings configured by the user to the factory settings. Take note of your settings beforehand and reconfigure them after initialization.

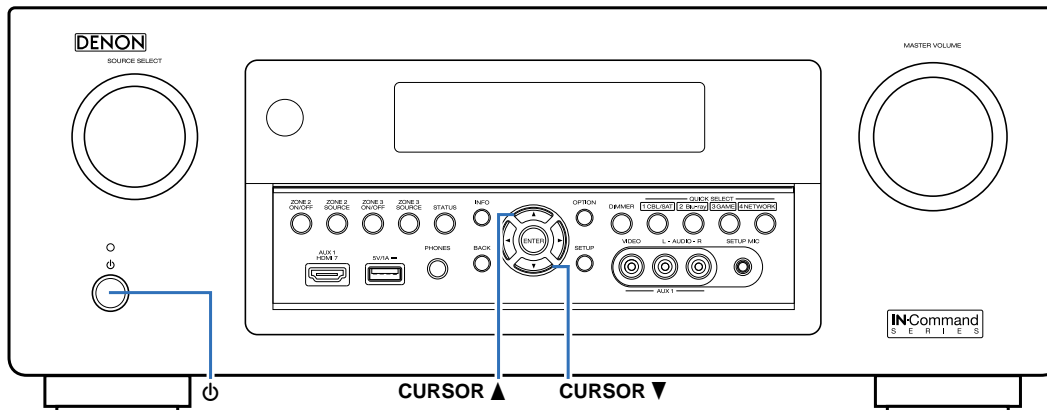

## Service Jigs

The following jigs (extension cable kit) are used when repairing the PCBs.  
Order the jigs from your dealer if necessary.

8U- 110084S : EXTENSION UNIT KIT : 2 Set

(See [77 page](#))

# DISASSEMBLY

- Remove each part in the order of the arrows below.
- Reassemble removed parts in the reverse order.
- Read "**Precautions During Work**" before reassembling removed parts.
- If wire bundles are removed or moved during adjustment or part replacement, reshape the wires after completing the work. Failure to shape the wires correctly may cause problems such as noise.

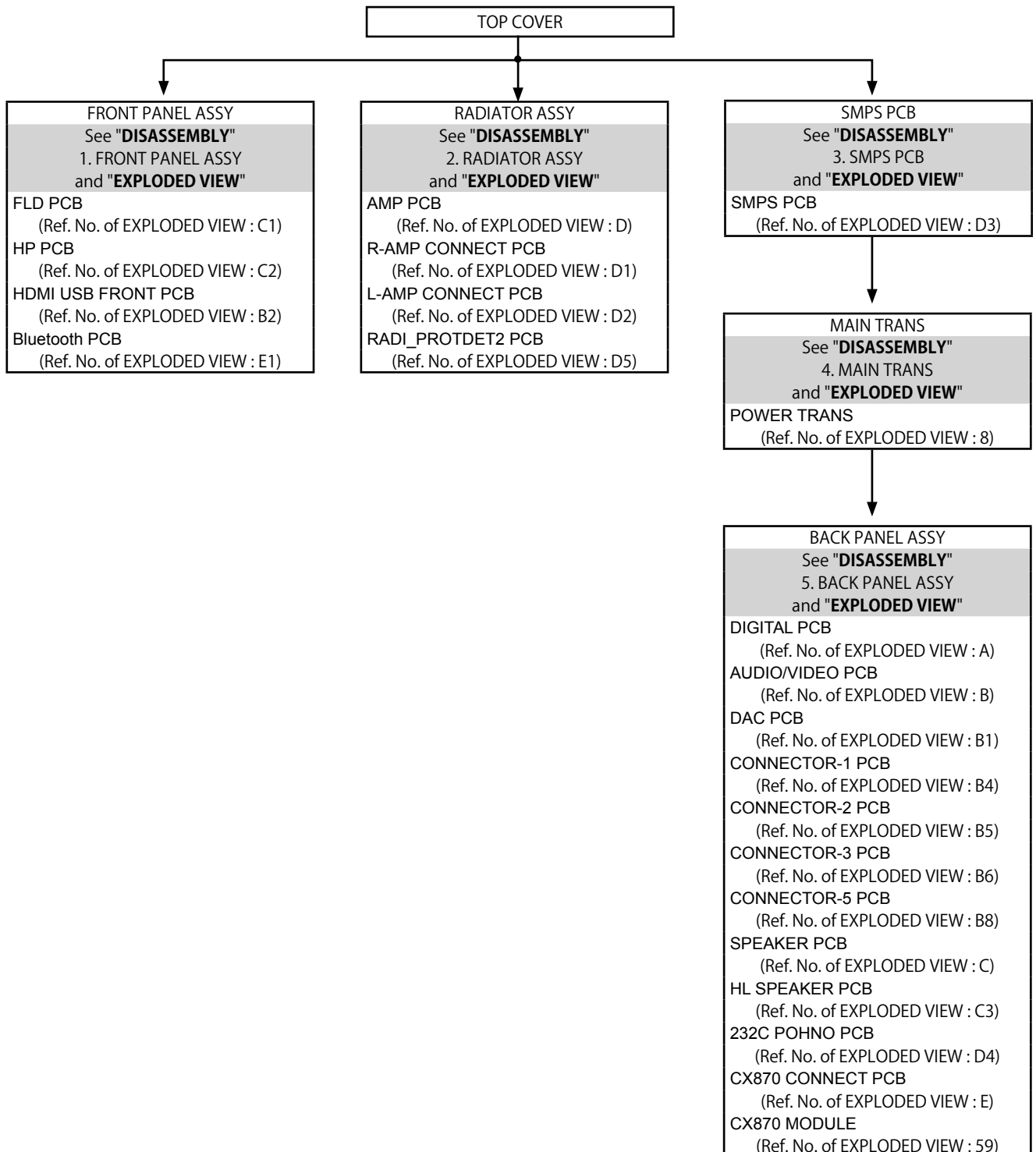

## Explanatory Photos for DISASSEMBLY

- The angles from which the photos are taken are shown by "Photo angle: A, B, C, D".
- See the diagram below about the shooting direction of each photograph.
- Photographs with no shooting direction indicated were taken from the top of the unit.
- The photograph is AVR-X5200WE3 model.

### The viewpoint of each photograph

(Shooting direction:X)[View from the top]

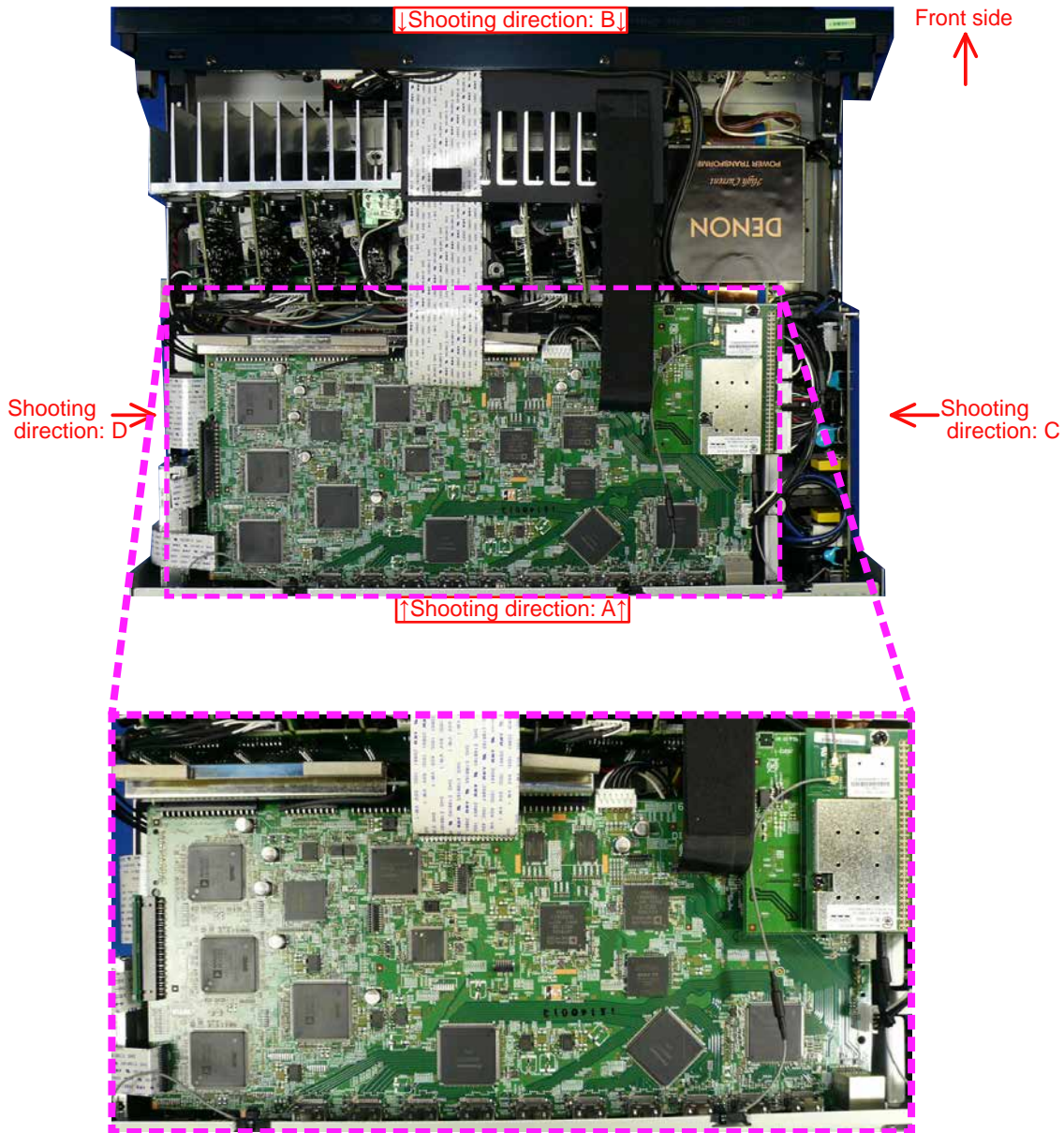



# 1. FRONT PANEL ASSY

Proceeding : **TOP COVER** → **FRONT PANEL ASSY**

(1) Remove the screws.

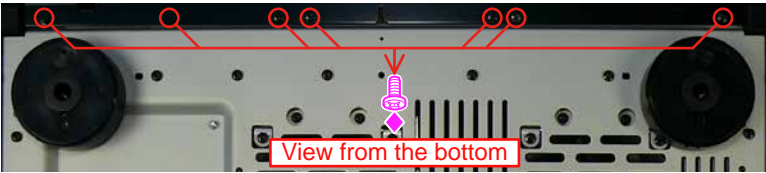

(2) Remove the screws. Remove the STYLE PIN, HOLDER, FFC and connector wire.

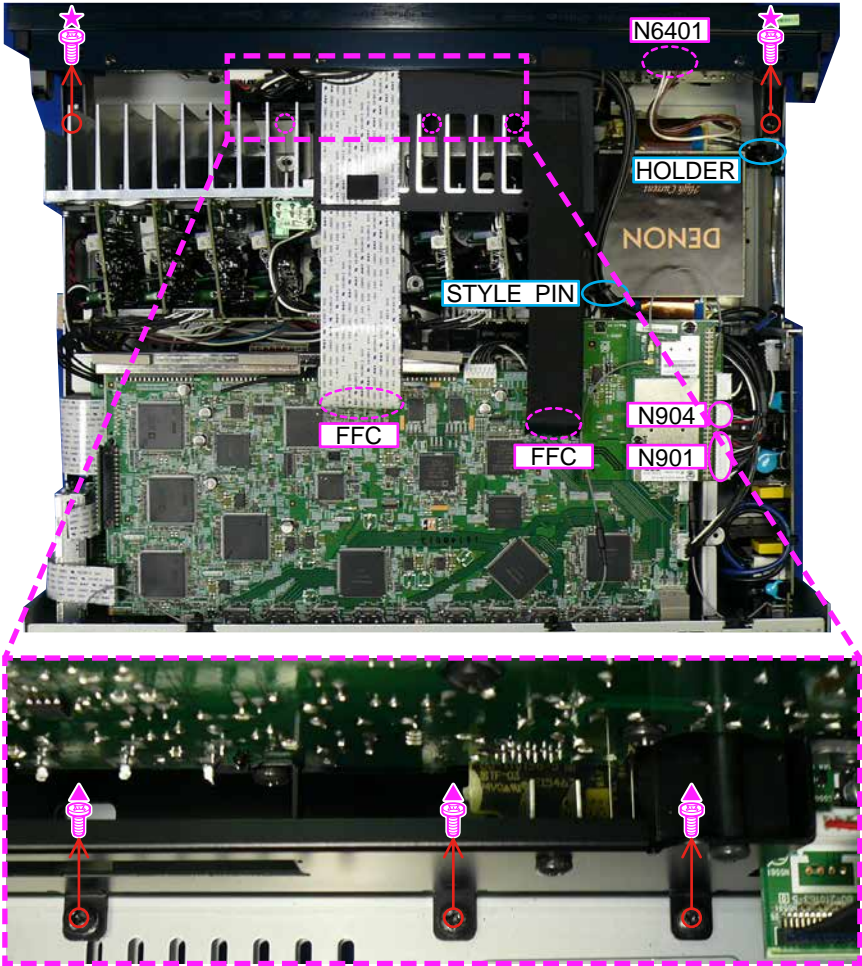

## 2. RADIATOR ASSY

Proceeding : **TOP COVER** → **FRONT PANEL ASSY** → **RADIATOR ASSY**

(1) Remove the STYLE PIN and connector wire. Remove the screws.

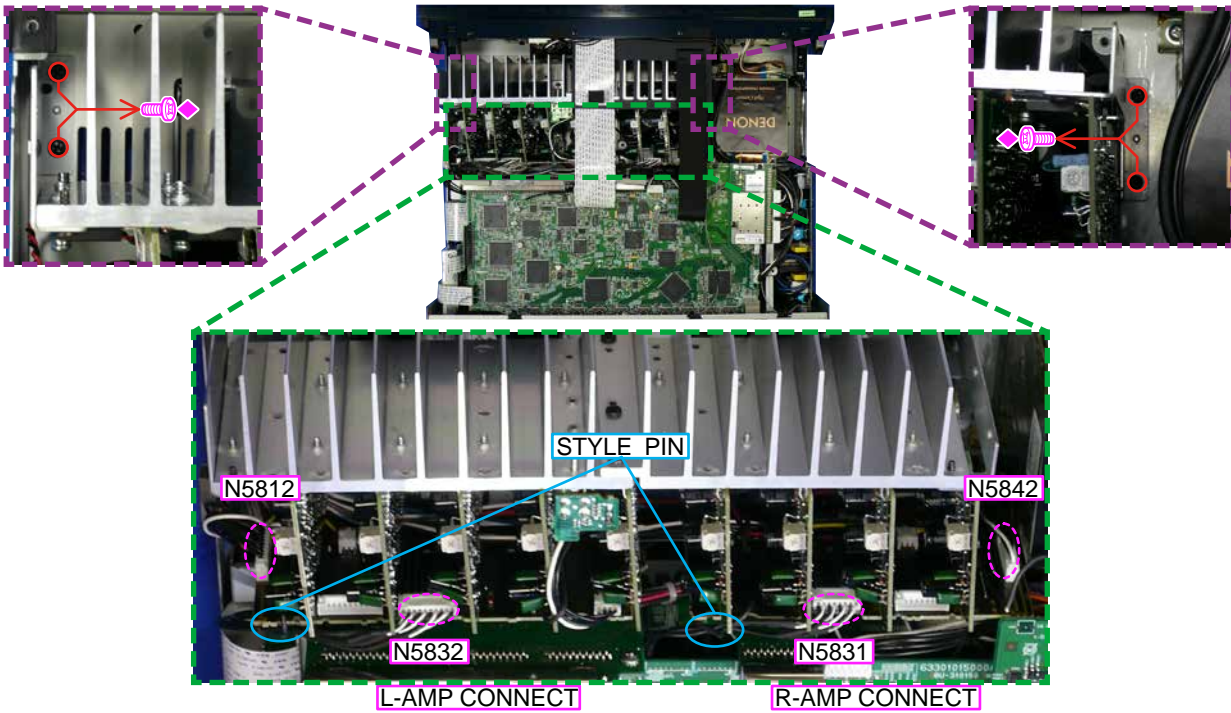

(2) Remove the connector wire.

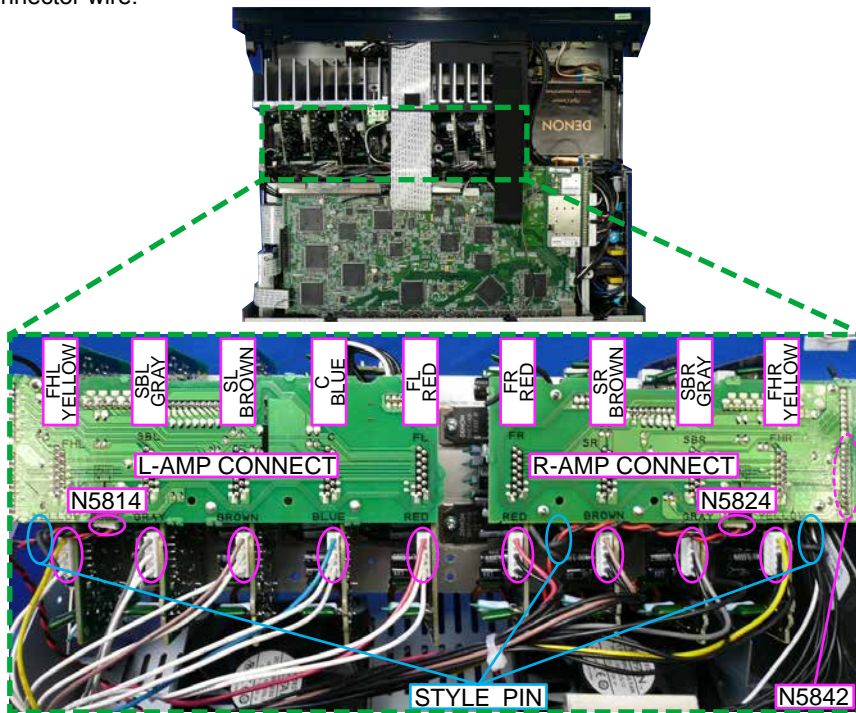

### 3. SMPS ASSY

Proceeding : **TOP COVER** → **FRONT PANEL ASSY** → **RADIATOR ASSY** → **SMPS ASSY**

(1) Remove the screws.

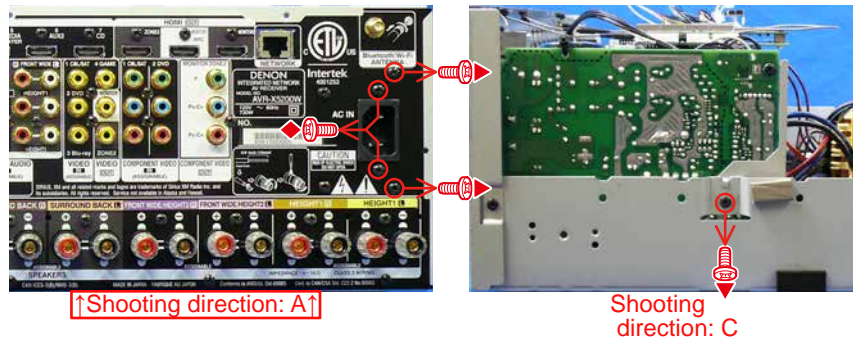

(2) Cut the wire clamp, then remove the connector wires.

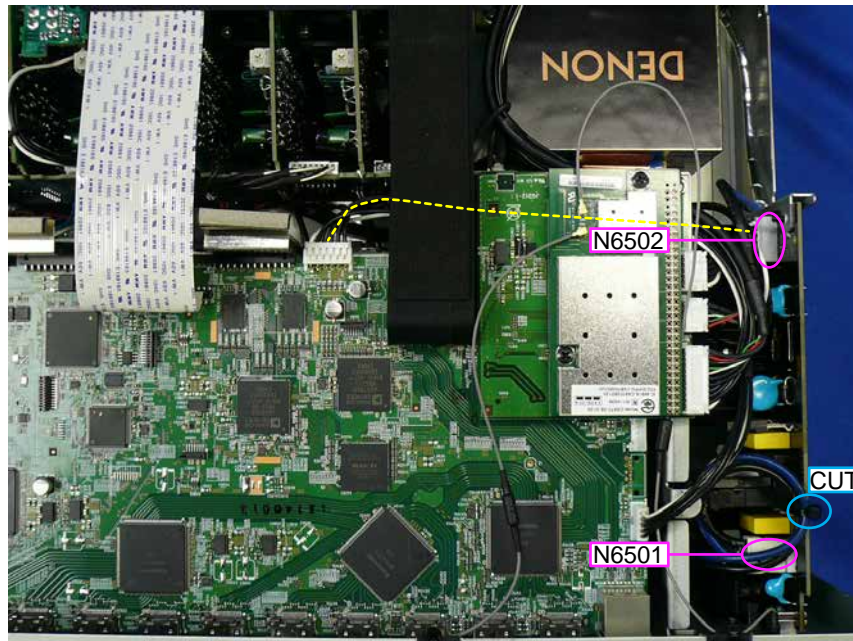



## 4. POWER TRANS

Proceeding : **TOP COVER** → **FRONT PANEL ASSY** → **RADIATOR ASSY** → **SMPS ASSY** → **POWER TRANS**

(1) Remove the screws. Remove the HOLDER.

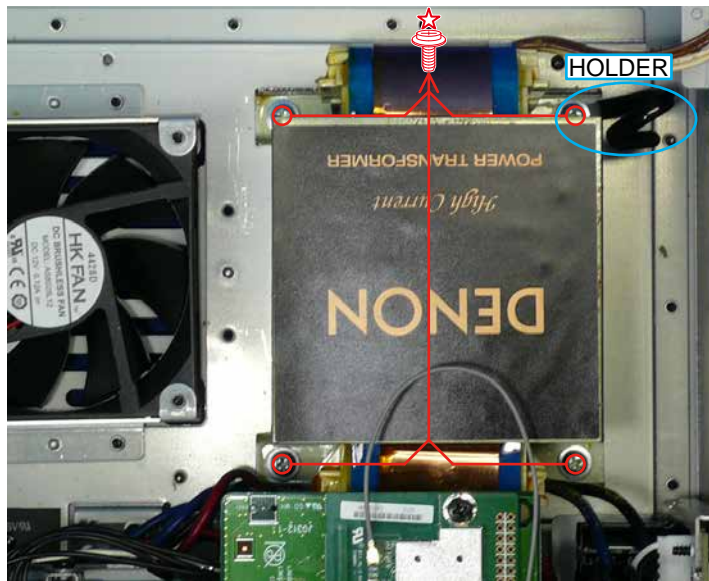

(2) Remove the STYLE PIN and connector wire.

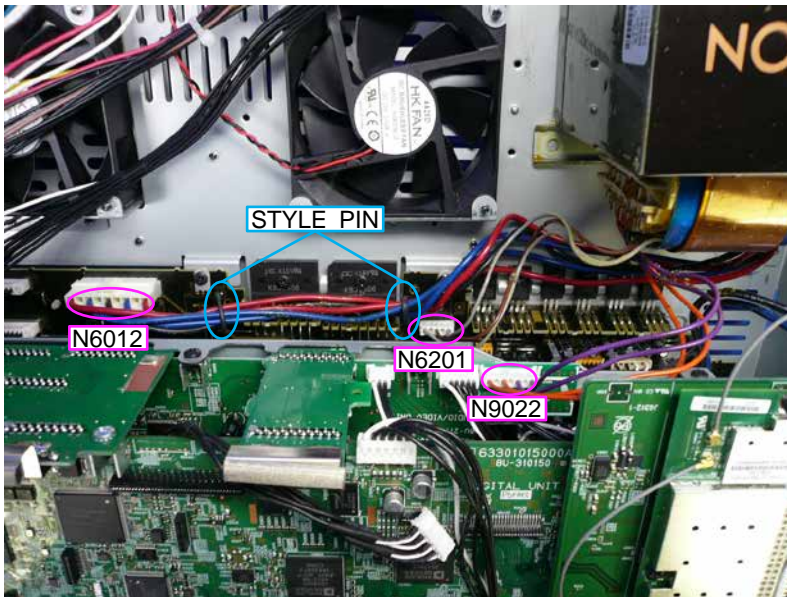

# 5. BACK PANEL ASSY

Proceeding : **TOP COVER** → **FRONT PANEL ASSY** → **RADIATOR ASSY** → **SMPS ASSY** → **POWER TRANS**  
 → **BACK PANEL ASSY**

(1) Remove the screws.

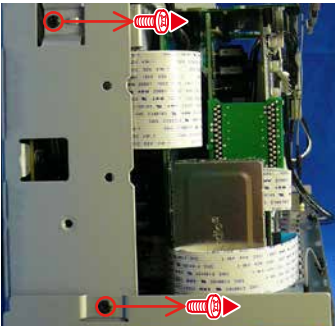
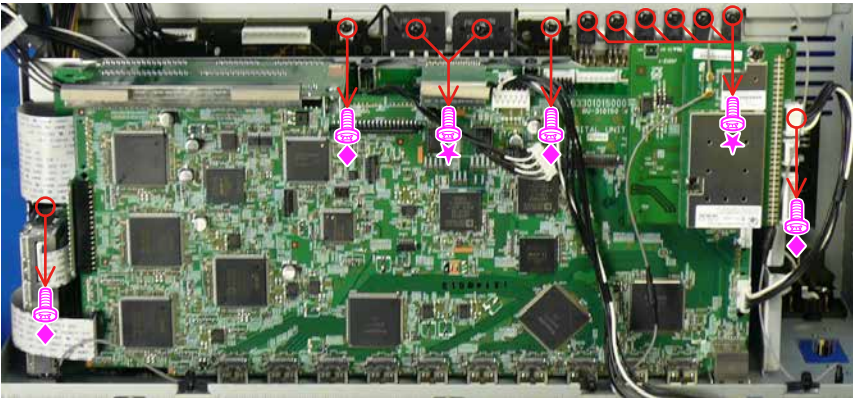

Shooting direction: D

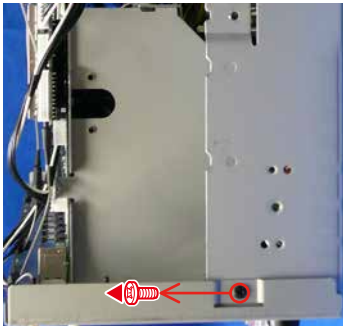

Shooting direction: C

# SPECIAL MODE

## Special Mode Configuration Buttons

- ※ No. 1 - 12, 15 : Hold down buttons "A", "B" and "C" at the same time and press the power button to turn on the power.
- ※ No. 13, 14: Hold down buttons "A" and "B" for at least 3 seconds while the power is on.
- ※ No. 16 : Press the "A" and "B" buttons simultaneously while inserting the AC plug to turn the power on.

No.	Mode	Button A	Button B	Button C	Contents
1	Version Display Mode (u-COM / DSP Error Display)	SETUP	OPTION	-	Displays the version of firmware such as the main firmware or DSP, etc. Errors that have occurred are displayed. (See 19 page)
2	User Initialization Mode (Settings for the Installer Setup are not initialized.)	BACK	INFO	-	Initializes backup data. (Settings for the Installer Setup are not initialized.)
3	Factory Initialization Mode (Initialization includes settings for the Installer Setup.)	CURSOR ▲	CURSOR ▼	-	Initializes backup data. (Initialization includes settings for the Installer Setup.)
4	PANEL / REMOTE LOCK Selection Mode	STATUS	INFO	-	Start this unit in the PANEL/REMOTE LOCK selection mode so that PANEL LOCK and Remote Lock can be selected as ON or OFF. (See 23 page)
5	Check the Video/Audio pass Mode	STATUS	ZONE3 SOURCE	-	This is a special mode for service confirmation used during repair work to simplify the confirmation work for the Audio channel/video channel. (See 27 page)
6	Protection History Display Mode	↑	↑	-	Displays the protection occurrence history. (See 70 page)
7	232C Standby Clear Mode	↑	↑	-	Switches from 232C standby mode to normal standby mode. (See 71 page)
8	Operation Info Mode	↑	↑	-	Displays the total operating time of the set, number of times the power was switched on, and number of occurrences of each protection. (See 72 page)
9	TUNER STEP Mode (E3 and E2 model only)	↑	↑	-	Enables reception STEP of the ANALOG TUNER to be changed. (See 73 page)
10	Remote ID Setup Mode	↑	↑	-	If there are multiple DENON AV receivers in the same area, this mode stops the other AV receivers from being operated concurrently with this device. (See 74 page)
11	Installer Setup Mode	CURSOR ◀	BACK	-	Access the Remote Maintenance mode via the internet. Installer Setup is displayed on Setup menu / Network. ※ Refer to AVR_RemoteMaintenance_.pdf of SDI.
12	Protection Pass Mode	CURSOR ◀	STATUS	ZONE3 SOURCE	Enables the power to be turned on when protection detection is in the stopped state. (See 75 page)
13	CX870 / CY920 Reboot Mode	DIMMER	SETUP	-	Restarts CX870 / CY920. (See 75 page)
14	CX870 / CY920 Initialization Mode	DIMMER	CURSOR ▶	-	Enter this mode only after replacing Flash for CX870 / CY920 and rewriting the firmware. (See 76 page)
15	USB Update Mode	STATUS	OPTION	-	Switches this unit to USB Update mode. (See 79 page)
16	Forced USB All Device Write Mode	STATUS	OPTION	-	Mode used when this unit cannot be recovered. Forcibly switches this unit to USB update mode. (See 81 page)

### NOTE :

When the volume indicator displays "-00.0", the set has entered a special mode for developers. In this case, RS-232C communication cannot be used.

To cancel this special mode, press and hold the "CURSOR ▼" and "STATUS" buttons for 3 seconds and longer. When the volume indicator returns to the normal display, RS-232C communication can be used.

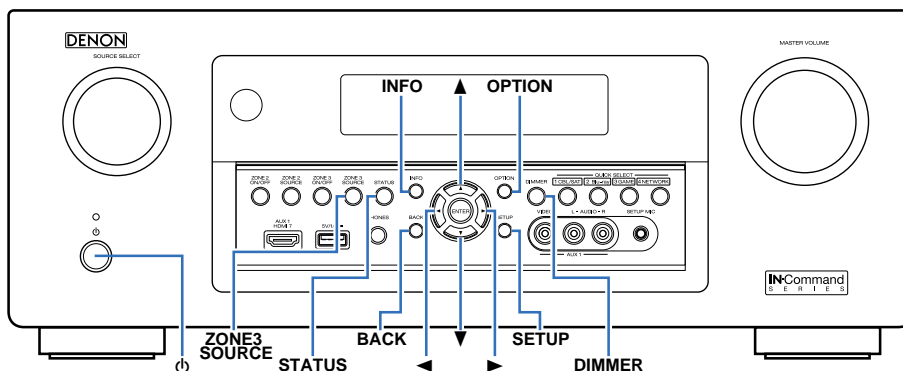

# 1. Version Display Mode

## 1.1. Actions

Version information is displayed when the device is started in this mode.

## 1.2. Starting up

Hold down buttons "SETUP" and "OPTION" at the same time and press the power button to turn on the power. Press the "OPTION" button after this to show the information in section 1.3 on the display.

※ A version list is also displayed on GUI while the version appears on the display.

## 1.3. Display Order

Error information(See "1.4. Error display") → ① Model destination information, Serial Number  
 → ② Firmware Package Version → ③ Main μ-com, Main 1st Boot Loader Version  
 → ④ Sub μ-com, Sub 1st Boot Loader Version → ⑤ DSP1/2/3/4 ROM → ⑥ Audio, Video PLD → ⑦ GUI SFLASH  
 → ⑧ Ethernet 1st Boot Loader, Hardware ID → ⑨ Ethernet 2nd Boot Loader, Rhapsody Flag → ⑩ Ethernet IMAGE  
 → ⑪ Ethernet MAC ADDRESS information → ⑫ BT MAC ADDRESS information → ⑬ HD Radio(E3 only)  
 → ⑭ MultEQ Pro APP (Displayed when Audyssey Pro is complete) → ⑮ MultEQ Pro ICL (Displayed when Audyssey Pro is complete)

① Model destination information, Serial Number :

FLD	L1	A	V	R	-	X	5	2	0	0	U	E	3	*	Case of CX870 : Display "*" at the end	
FLD	L1	A	V	R	-	X	5	2	0	0	U	E	2	*	Case of CX870 : Display "*" at the end	
FLD	L1	A	V	R	-	X	5	2	0	0	U	E	1	C	*	Case of CX870 : Display "*" at the end
FLD	L2	S	/	N	.	*	*	*	*	*	*	*	*	*		

② Firmware Package Version :

FLD	L1	F	i	r	m	.	P	a	c	k	a	g	e	
	L2						V	e	r	.	*	*	*	*

③ Main μ-com, Main 1st Boot Loader Version :

FLD	L1	M	a	i	n	:	*	*	.	*	*	*	Case of CX870 : Display "*" at the end
	L2	M	a	i	n	F	B	L	:	*	*	.	*

④ Sub μ-com, Sub 1st Boot Loader Version :

FLD	L1	S	u	b	:	7	1	1	0	*	*	*	*
	L2	S	u	b	F	B	L	:	*	*	.	*	*

⑤ DSP1/2 ROM :

FLD	L1	D	S	P	1	:	*	*	.	*	*
	L2	D	S	P	2	:	*	*	.	*	*

DSP3/4 ROM :

FLD	L1	D	S	P	3	:	*	*	.	*	*
	L2	D	S	P	4	:	*	*	.	*	*

⑥ Audio, Video PLD :

FLD	L1	A	u	d	i	o	P	L	D	:	*	*	.	*	*
	L2	V	i	d	e	o	P	L	D	:	*	*	.	*	*

⑦ GUI SFLASH :

FLD	L1	G	U	I	:	7	0	1	Z	*	*	*	*
	L2												

Z : Region code(E3/E2=1, E1C=5)

⑧ Ethernet 1st Boot Loader, Hardware ID :

FLD	L1	E	t	h	e	r	n	e	t	F	B	L		
	L2	*	*	*	*	*	*	-	A	A				

AA:Hardware ID

⑨ Ethernet 2nd Boot Loader, Rhapsody Flag :

FLD	L1	E	t	h	e	r	n	e	t	S	B	L		
	L2	*	*	*	*	*	*	*	*	*	*	*	*	-

⑩ Ethernet IMAGE :

FLD	L1	E	t	h	e	r	n	e	t	I	M	G		
	L2	*	*	*	*	*	*	*	*	*	*	*	*	

⑪ Ethernet MAC ADDRESS information :

FLD	L1	*	N	E	T	M	A	C	A	d	d	r	e	s	s
	L2	*	*	*	*	*	*	*	-	*	*	*	*	*	

⑫ BT MAC ADDRESS information :

FLD	L1	*	B	T	M	A	C	A	d	d	r	e	s	s
	L2	*	*	*	*	*	*	*	-	*	*	*	*	S

⑬ HD Radio :

FLD	L1	*	H	D	:	S	S	S	S	S	S	S	S	-
	L2					R	U	U	U	U	.	B	B	B

S:Software Configuration, R:Release Type, U:Base Version No., B:Build No.

⑭ MultEQ Pro APP :

FLD	L1	*	M	U	I	T	E	Q	P	r	O	A	P	P
	L2	*	*	.	*	*	.	*	*	.	*	*	*	*

⑮ MultEQ Pro ICL :

FLD	L1	*	M	U	I	T	E	Q	P	r	O	I	C	L
	L2	*	*	.	*	*	.	*	*	.	*	*	*	*



## 1.4. Error display

See the table below for descriptions of displayed errors and countermeasures for these.

Display order is ①,②,③,④,⑤,⑥,⑦.

Condition	States	Display	TROUBLE SHOOTING																																																																																										
① Firm Check NG	The model name, brand name and region information written in the firmware are compared to the region settings in the PCB. This error is displayed if the information does not match.  "▲" is displayed as the first character if the firmware is not correct (see right section of table).	<table border="1"> <tr><td> </td><td> </td><td>F</td><td>I</td><td>R</td><td>M</td><td>E</td><td>R</td><td>R</td><td>O</td><td>R</td><td> </td><td> </td></tr> <tr><td>▲</td><td>M</td><td>a</td><td>i</td><td>n</td><td> </td><td>:</td><td>*</td><td>*</td><td>.</td><td>*</td><td>*</td><td> </td></tr> <tr><td>▲</td><td>D</td><td>S</td><td>P</td><td>1</td><td> </td><td>:</td><td>*</td><td>*</td><td>.</td><td>*</td><td>*</td><td> </td></tr> <tr><td>▲</td><td>A</td><td>u</td><td>d</td><td>i</td><td>o</td><td>P</td><td>L</td><td>D</td><td>:</td><td>*</td><td>*</td><td>.</td><td>*</td><td>*</td><td> </td></tr> <tr><td>▲</td><td>G</td><td>U</td><td>I</td><td> </td><td>:</td><td>*</td><td>*</td><td>*</td><td>*</td><td>*</td><td>*</td><td>*</td><td>*</td><td>*</td><td> </td></tr> </table>			F	I	R	M	E	R	R	O	R			▲	M	a	i	n		:	*	*	.	*	*		▲	D	S	P	1		:	*	*	.	*	*		▲	A	u	d	i	o	P	L	D	:	*	*	.	*	*		▲	G	U	I		:	*	*	*	*	*	*	*	*	*		<ul style="list-style-type: none"> <li>•Check the resistor for setting region(R5003, R5004, R5006, R5007, R5013, R5014 DIGITAL PCB).</li> <li>•Write the firmware for the correct region.</li> </ul>																			
		F	I	R	M	E	R	R	O	R																																																																																			
▲	M	a	i	n		:	*	*	.	*	*																																																																																		
▲	D	S	P	1		:	*	*	.	*	*																																																																																		
▲	A	u	d	i	o	P	L	D	:	*	*	.	*	*																																																																															
▲	G	U	I		:	*	*	*	*	*	*	*	*	*																																																																															
② SUB μ -COM NG	There is not a reply from SUB μ -COM.	<table border="1"> <tr><td>S</td><td>U</td><td>B</td><td> </td><td>E</td><td>R</td><td>R</td><td>O</td><td>R</td><td> </td><td>0</td><td>1</td><td> </td><td> </td></tr> </table>	S	U	B		E	R	R	O	R		0	1			<ul style="list-style-type: none"> <li>•Check the SUB(U2101) and surrounding circuits.</li> </ul>																																																																												
S	U	B		E	R	R	O	R		0	1																																																																																		
③ IP SCALER NG	An error occurs in Loopback Test of the DDR memory to perform at initial setting of i/p Scaler(ADV8003).  In initial setting of i/p Scaler ( ADV8003 ) , there is not the reply of the Loopback Test result of the DDR memory .	<table border="1"> <tr><td>I</td><td>P</td><td> </td><td>S</td><td>C</td><td>A</td><td>L</td><td>E</td><td>R</td><td> </td><td>E</td><td>R</td><td>R</td><td> </td><td>0</td><td>1</td><td> </td></tr> <tr><td>I</td><td>P</td><td> </td><td>S</td><td>C</td><td>A</td><td>L</td><td>E</td><td>R</td><td> </td><td>E</td><td>R</td><td>R</td><td> </td><td>0</td><td>2</td><td> </td></tr> </table>	I	P		S	C	A	L	E	R		E	R	R		0	1		I	P		S	C	A	L	E	R		E	R	R		0	2		<ul style="list-style-type: none"> <li>•Check the circuits around the IP SCALER (U2800, DIGITAL PCB) and DDR2 (U3000/ U3001).</li> <li>If there appear to be no problems, U2800 or U3000/U3001 is faulty.</li> </ul>																																																								
I	P		S	C	A	L	E	R		E	R	R		0	1																																																																														
I	P		S	C	A	L	E	R		E	R	R		0	2																																																																														
④ GUI Serial Flash NG	When it is different from Version of the Main CPU which Version of GUI Serial Flash supports . (ADV8003) "▼" is displayed as the first character of the GUI firmware version.	<table border="1"> <tr><td>G</td><td>U</td><td>I</td><td> </td><td>V</td><td>E</td><td>R</td><td>.</td><td> </td><td>E</td><td>R</td><td>R</td><td>O</td><td>R</td><td> </td><td> </td></tr> <tr><td>▼</td><td>G</td><td>U</td><td>I</td><td> </td><td>:</td><td>*</td><td>*</td><td>*</td><td>*</td><td>*</td><td>*</td><td>*</td><td>*</td><td>*</td><td> </td></tr> </table>	G	U	I		V	E	R	.		E	R	R	O	R			▼	G	U	I		:	*	*	*	*	*	*	*	*	*		<ul style="list-style-type: none"> <li>•Check the firmware version.</li> </ul>																																																										
G	U	I		V	E	R	.		E	R	R	O	R																																																																																
▼	G	U	I		:	*	*	*	*	*	*	*	*	*																																																																															
⑤ DIR NG	This error is displayed if there is no response from the DIR.	<table border="1"> <tr><td>D</td><td>I</td><td>R</td><td> </td><td>E</td><td>R</td><td>R</td><td>O</td><td>R</td><td> </td><td>0</td><td>1</td><td> </td><td> </td></tr> </table>	D	I	R		E	R	R	O	R		0	1			<ul style="list-style-type: none"> <li>•Check the DIR (U1000, DIGITAL PCB) and surrounding circuits.</li> </ul>																																																																												
D	I	R		E	R	R	O	R		0	1																																																																																		
⑥ DSP* NG (* : 1/2/3/4)	The DSP* FLAG0 port does not enter "Hi" status even after executing a DSP reset during a DSP code boot.  The DSP* FLAG0 port does not enter "Hi" status before issuing a DSP command.  ACK="Hi" does not occur during DSP* data reading, even when WRITE="Lo".  ACK="Lo" does not occur during DSP* data reading, even when REQ="Lo".  ACK="Hi" does not occur during DSP* data writing, even when WRITE="Hi".  ACK="Lo" does not occur during DSP* data writing, even when REQ="Lo".	<table border="1"> <tr><td>D</td><td>S</td><td>P</td><td>*</td><td> </td><td>E</td><td>R</td><td>R</td><td>O</td><td>R</td><td> </td><td>0</td><td>1</td><td> </td><td> </td></tr> <tr><td>D</td><td>S</td><td>P</td><td>*</td><td> </td><td>E</td><td>R</td><td>R</td><td>O</td><td>R</td><td> </td><td>0</td><td>2</td><td> </td><td> </td></tr> <tr><td>D</td><td>S</td><td>P</td><td>*</td><td> </td><td>E</td><td>R</td><td>R</td><td>O</td><td>R</td><td> </td><td>0</td><td>3</td><td> </td><td> </td></tr> <tr><td>D</td><td>S</td><td>P</td><td>*</td><td> </td><td>E</td><td>R</td><td>R</td><td>O</td><td>R</td><td> </td><td>0</td><td>4</td><td> </td><td> </td></tr> <tr><td>D</td><td>S</td><td>P</td><td>*</td><td> </td><td>E</td><td>R</td><td>R</td><td>O</td><td>R</td><td> </td><td>0</td><td>5</td><td> </td><td> </td></tr> <tr><td>D</td><td>S</td><td>P</td><td>*</td><td> </td><td>E</td><td>R</td><td>R</td><td>O</td><td>R</td><td> </td><td>0</td><td>6</td><td> </td><td> </td></tr> </table>	D	S	P	*		E	R	R	O	R		0	1			D	S	P	*		E	R	R	O	R		0	2			D	S	P	*		E	R	R	O	R		0	3			D	S	P	*		E	R	R	O	R		0	4			D	S	P	*		E	R	R	O	R		0	5			D	S	P	*		E	R	R	O	R		0	6			<ul style="list-style-type: none"> <li>•Check the DSP (U101, U201, U301, U401, DIGITAL PCB) and surrounding circuits.</li> </ul>
D	S	P	*		E	R	R	O	R		0	1																																																																																	
D	S	P	*		E	R	R	O	R		0	2																																																																																	
D	S	P	*		E	R	R	O	R		0	3																																																																																	
D	S	P	*		E	R	R	O	R		0	4																																																																																	
D	S	P	*		E	R	R	O	R		0	5																																																																																	
D	S	P	*		E	R	R	O	R		0	6																																																																																	
⑦ EEPROM NG	An error occurred in a checksum of the EEPROM(*** is a block address number).	<table border="1"> <tr><td>E</td><td>2</td><td>P</td><td>R</td><td>O</td><td>M</td><td> </td><td>E</td><td>R</td><td>R</td><td> </td><td>*</td><td>*</td><td>*</td><td> </td><td> </td></tr> </table>	E	2	P	R	O	M		E	R	R		*	*	*																																																																													
E	2	P	R	O	M		E	R	R		*	*	*																																																																																

## 1.5. Version Display in the Setup Menu

Follow the steps below to display the firmware information.

- (1) Press the **"SETUP"** button on the remote control.
- (2) Select **"General - Information - Firmware"**.

The version information is displayed as a 14-digit number as shown in the screenshot below.



GUI Image

This 14-digit number comprises part of the version number of each device and module. These version numbers correspond to the 14-digit number as shown below.

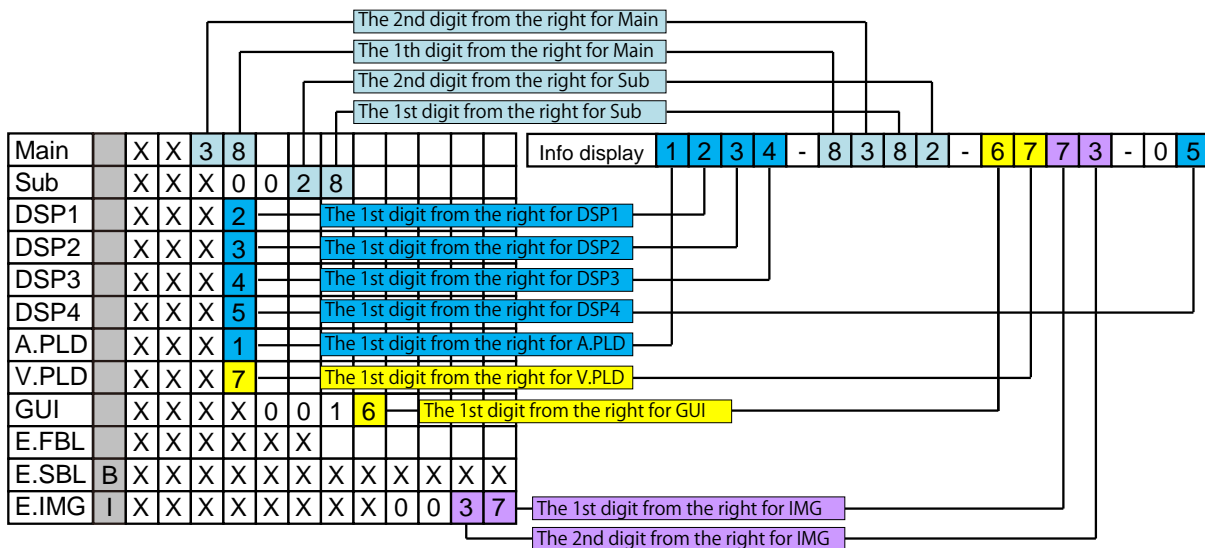

※ The firmware version numbers and this 14-digit version information are written in the Service Information.

## 2. PANEL / REMOTE LOCK Selection Mode

### 2.1. Actions

Turn the PANEL LOCK and REMOTE LOCK modes on and off.

### 2.2. Starting up

Hold down buttons "STATUS" and "INFO" at the same time and press the power button to turn on the power. Select the mode using the button "CURSOR ▼", and press the button "ENTER" to commit the selection.

### 2.3. Displaying and Selecting Each Mode

The information shown on the display changes each time the button "CURSOR ▼" is pressed. Press the button "ENTER" to set the currently displayed mode and restart the device. The On/Off setting for each mode is shown by an asterisk "\*".

①

FLD	L1	▶	F	P	/	V	O	L		L	O	C	K	*	O	n
	L2		F	P		L	O	C	K						O	n

The buttons on the unit and the master volume knob cannot be operated.

②

FLD	L1		F	P	/	V	O	L		L	O	C	K	*	O	n
	L2	▶	F	P		L	O	C	K						O	n

The buttons on the unit cannot be operated.

③

FLD	L1		F	P		L	O	C	K					*	O	n
	L2	▶	F	P		L	O	C	K						O	f

The PANEL LOCK mode is turned off.

④

FLD	L1		F	P		L	O	C	K						O	f
	L2	▶	R	C		L	O	C	K						O	n

The device cannot be operated by the remote control.

⑤

FLD	L1		R	C		L	O	C	K						O	n
	L2	▶	R	C		L	O	C	K						O	f

The REMOTE LOCK mode is turned off.

### 3. Selection Modes for Service-related Operations

#### 3.1. Actions

Select diagnostic mode (service path check mode), protection history display mode, or 232C standby clear mode.

#### 3.2. Starting up

Hold down buttons "STATUS" and "ZONE3 SOURCE" at the same time and press the power button to turn on the power. Select the mode using the button "CURSOR ▼", and press the button "ENTER" to commit the selection.

#### 3.3. Displaying and Selecting Each Mode

The information shown on the display changes each time the button "CURSOR ▼" is pressed. Press the button "ENTER" to set the currently displayed mode and restart the device.

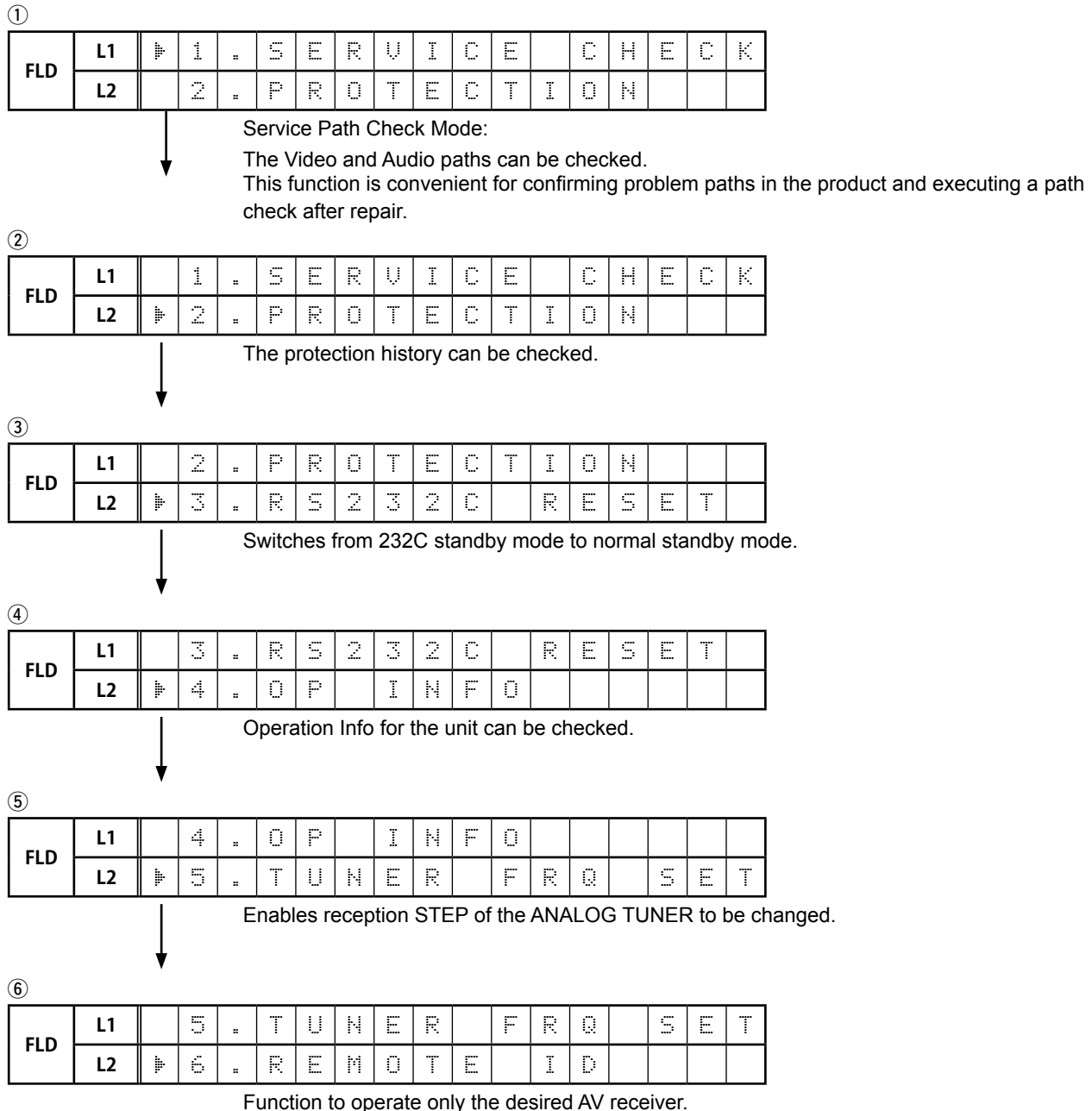

#### 3.3. Canceling the mode

Press the power button to turn off the power.





### 3.5. DIAGNOSTIC MODE (Service Path Check Mode)

#### 3.5.1. Actions

This function is convenient for confirming problem paths in the product and executing a path check after repair.  
The Video and Audio paths can be checked.  
The backup data is not rewritten.

#### 3.5.2. Starting up

Hold down buttons "STATUS" and "ZONE3 SOURCE" at the same time and press the power button to turn on the power.  
Select "1. SERVICE CHECK" and press the "ENTER" button to start the diagnostic mode.  
The "TUNED", "STEREO" and "RDS" segments are lit in this mode.

#### 3.5.3. Canceling diagnostic mode

Press the power button to turn off the power.

#### 3.5.4. Selecting items

Press ① button to switch between video items and audio items.

Press button ② or ③ to select the previous or next item.

Actions	The unit			Remote control unit		
	① Audio ⇄ Video	② PREVIOUS	③ NEXT	① Audio ⇄ Video	② PREVIOUS	③ NEXT
Button	DIMMER	CURSOR ◀	CURSOR ▶	SLEEP	CURSOR ◀	CURSOR ▶

#### 3.5.5. Audio system confirmation items

fig. XX: See the block diagram of the fig.XXth.

Paths confirmation item		Display	Settings	Contents of confirmation Remarks
1	Analog (MAIN ZONE) <b>fig.01</b>	A01:ANALOG P A S S	Input Source : CBL/SAT Input Mode : Analog(fixed) Sound mode : Direct Vol. : 60.0 (-20.0dB) Amp assign : 9.1ch ZONE2 : OFF ZONE3 : OFF	• Analog input ⇒ Speaker output (Front L/R) • Analog input ⇒ Preout output (Front L/R) (※As the input source, you can switch from CBL/SAT to other ones.)
2	Digital (MAIN ZONE) <b>fig.02a</b> <b>fig.02b</b>	A02:DIGITAL	Input Source : CBL/SAT Input Mode : Digital(fixed) Sound mode : Multi Ch Stereo Vol. : 60.0 (-20.0dB) Amp assign : 9.1ch Speaker Select : Floor Speaker Config : All Speaker=Small/Subwoofer=2spkrs ZONE2 : OFF ZONE3 : OFF	• Digital input ⇒ Speaker output (Front L/R, Center, Surround L/R, Surround Back L/R) • Digital input ⇒ Preout output (Front L/R, Center, Subwoofer1/2, Surround L/R, Surround Back L/R) (※As the input source, you can switch from CBL/SAT to other ones.)
3	Digital (signal) Path (ZONE2) <b>fig.03a</b> <b>fig.03b</b> <b>fig.03c</b>	A03:DIGITAL-Z2	Input Source : Online Music Input Mode : Auto Sound mode : Stereo Amp assign : 7.1ch + ZONE2 Speaker for ZONE2 : SURROUND BACK ZONE2 : ON ZONE2 Source : Source Z2 Vol. : 60.0 (-20.0dB) ZONE3 : OFF	• Digital(PCM) input ⇒ Speaker output (Surround Back L/R → ZONE2 L/R) • Digital(PCM) input ⇒ Preout output (ZONE2 L/R) (※As the input source, you can switch from Online Music to other ones.)
4	Digital (signal) Path (ZONE3) <b>fig.04a</b> <b>fig.04b</b>	A04:DIGITAL-Z3	Input Source : Online Music Input Mode : Auto Sound mode : Stereo Amp assign : 7.1ch + ZONE3 Speaker for ZONE3 : FRONT WIDE/HEIGHT 2 ZONE2 : OFF ZONE3 : ON ZONE3 Source : Source Z3 Vol. : 60.0 (-20.0dB)	• Digital(PCM) input ⇒ Speaker output (Front Wide/Height2 L/R → ZONE3 L/R) • Digital(PCM) input ⇒ Preout output (ZONE3 L/R) (※As the input source, you can switch from Online Music to other ones.)
5	HDMI (MAIN ZONE) <b>fig.05a</b> <b>fig.05b</b> <b>fig.05c</b>	A05:HDMI	Input Source : CBL/SAT Input Mode : HDMI(fixed) Sound mode : Stereo Vol. : 60.0 (-20.0dB) Amp assign : 9.1ch ZONE2 : OFF ZONE3 : OFF	• HDMI Input ⇒ Speaker output (Front L/R) • HDMI Input ⇒ Preout output (Front L/R) (※As the input source, you can switch from CBL/SAT to other ones.)

Paths confirmation item	Display	Settings	Contents of confirmation Remarks
6 A/D (MAIN ZONE)  fig.06a fig.06b	A06:AD	Input Source : CBL/SAT Input Mode : Analog(fixed) Sound mode : Multi Ch Stereo Vol. : 60.0 (-20.0dB) Amp assign : 9.1ch Height Speakers=2 Height Speakers Height Layout=Front Height Speaker Select : Floor Speaker Config : All Speaker=Small/Subwoofer=2spkr ZONE2 : OFF ZONE3 : OFF	<ul style="list-style-type: none"> <li>Analog input ⇒ Speaker output (Front L/R, Center, Surround L/R, Surround Back L/R, Front Wide L/R)</li> <li>Analog input ⇒ Preout output, SW(20Hz) (Front L/R, Center, Subwoofer1/2, Surround L/R, Surround Back L/R, Front Wide L/R)</li> </ul> (※As the input source, you can switch from CBL/SAT to other ones.)
7 Amp Assign (ZONE2)  fig.07	A07:ASSIGN-Z2	Input Source : CBL/SAT Input Mode : Auto Sound mode : Stereo Amp assign : 7.1ch + ZONE2 Speaker for ZONE2 : Surround Back ZONE2 : ON Z2 Source : Source Z2 Vol : 60 (-20dB) ZONE3 : OFF	<ul style="list-style-type: none"> <li>Analog input ⇒ Speaker output (Surround Back L/R → ZONE2 L/R)</li> <li>Analog input ⇒ Preout output (ZONE2 L/R)</li> </ul> (※As the input source, you can switch from CBL/SAT to other ones.)
8 Amp Assign (ZONE3)  fig.08	A08:ASSIGN-Z3	Input Source : CBL/SAT Input Mode : Auto Sound mode : Stereo Amp assign : 7.1ch + ZONE3 Speaker for ZONE3 : FRONT WIDE/HEIGHT 2 ZONE2 : OFF ZONE3 : ON ZONE3 Source : Source Z3 Vol. : 60.0 (-20.0dB)	<ul style="list-style-type: none"> <li>Analog input ⇒ Speaker output (Front Wide/Height2 L/R → ZONE3 L/R)</li> <li>Analog input ⇒ Preout output (ZONE3 L/R)</li> </ul> (※As the input source, you can switch from CBL/SAT to other ones.)
9 Amp Assign (ZONE2/ZONE3-MONO)  fig.09	A09:ASSIGN-Z3/3M	Input Source : CBL/SAT Input Mode : Auto Sound mode : STEREO Amp assign : 7.1ch + ZONE2/3-MONO Speaker for ZONE2/3 : HEIGHT1 ZONE2 : ON Z2 Source : Source Z2 Vol : 60 (-20dB) ZONE3 : ON Z3 Source : Source Z3 Vol : 60 (-20dB)	<ul style="list-style-type: none"> <li>Analog input ⇒ Speaker output (Height1 L → ZONE2 MONO, Height2 R → ZONE3 MONO)</li> <li>Analog input ⇒ Preout output (ZONE2 L/R → ZONE2 MONO, ZONE3 L/R → ZONE3 MONO)</li> </ul> (※As the input source, you can switch from CBL/SAT to other ones.)
10 Amp Assign (7.1ch (Bi-Amp))  fig.10a fig.10b	A11:ASSIGN-BIAMP	Input Source : CBL/SAT Input Mode : Auto Sound mode : Multi Ch Stereo Vol. : 60.0 (-20.0dB) Amp assign : 7.1ch (Bi-Amp) Speaker for Bi-Amp : SURROUND BACK ZONE2 : OFF ZONE3 : OFF	<ul style="list-style-type: none"> <li>Analog input ⇒ Speaker output (Surround Back L/R → Front L/R)</li> </ul> (※As the input source, you can switch from CBL/SAT to other ones.)
11 Front Height  fig.11a fig.11b	A14:FRONT HEIGHT	Input Source : CBL/SAT Input Mode : Auto Sound mode : Multi Ch Stereo Vol. : 60.0 (-20.0dB) Amp assign : 11.1ch Height Speakers : 4Height Speakers Height Layout : Top Front & Top Rear Pre-out Channel : Top Rear Speaker Config : Front Wide=None Speaker Select : Floor & Height ZONE2 : OFF ZONE3 : OFF	<ul style="list-style-type: none"> <li>Analog input ⇒ Speaker output (Height 1 L/R → Top Front L/R)</li> <li>Analog input ⇒ Preout output (Height 1 L/R → Top Front, Height 2 L/R → Top Rear)</li> </ul> (※As the input source, you can switch from CBL/SAT to other ones.)
12 Front Wide  fig.12a fig.12b	A15:FRONT WIDE	Input Source : CBL/SAT Input Mode : Auto Sound mode : Multi Ch Stereo Vol. : 60.0 (-20.0dB) Amp assign : 11.1ch Height Spakers : 4 Height Speakers Height Layout : Front Height & Top Middle Wide/Height2 : Front Wide Speaker Config: S.Back=None Speaker Select : Floor ZONE2 : OFF ZONE3 : OFF	<ul style="list-style-type: none"> <li>Analog input ⇒ Speaker output (Front Wide L/R)</li> <li>Analog input ⇒ Preout output (Front Wide L/R)</li> </ul> (※As the input source, you can switch from CBL/SAT to other ones.)



Paths confirmation item		Display	Settings	Contents of confirmation Remarks
13	Front Amp>>Height 1 <b>fig.13a</b> <b>fig.13b</b>	A 2 0 : F - A M P H E I G H T	Input Source : CBL/SAT Input Mode:Auto Sound mode: Multi ch Stereo Vol. : 60.0 (-20.0dB) Amp assign : 11.1ch Height Speakers=4Height Speakers Height Layout=Top Front & Top Rear Pre-out Channel=Front & Top Rear Speaker Conofig : Surround Back=None Speaker Select=Floor & Height ZONE2 : OFF ZONE3 : OFF	<ul style="list-style-type: none"> <li>• Analog input ⇒ Speaker output (Height1 L/R → Top Front L/R)</li> <li>• Analog input ⇒ Preout output (Height1 L/R → Top Front, Height2 → Top Rear L/R)</li> </ul> (※As the input source, you can switch from CBL/SAT to other ones.)
14	Front Amp>>Front Wide <b>fig.14a</b> <b>fig.14b</b>	A 2 1 : F - A M P W I D E	Input Source : CBL/SAT Input Mode : Auto Sound mode : Multi ch Stereo Vol. : 60.0 (-20.0dB) Amp assign : 11.1ch Height Speakers : 2Height Speakers Height Layout : Front Height Pre-out Channel : Front Speaker Select=Front ZONE2 : OFF ZONE3 : OFF	<ul style="list-style-type: none"> <li>• Analog input ⇒ Speaker output (Front Wide L/R)</li> </ul> (※As the input source, you can switch from CBL/SAT to other ones.)
15	Wide/Height Amp>>Surround Back <b>fig.15a</b> <b>fig.15b</b>	A 2 3 : H - A M P B A C K	Input Source : CBL/SAT Input Mode : Auto Sound mode : Multi ch Stereo Vol. : 60.0 (-20.0dB) Amp assign : 7.1ch+ZONE2 Speakers for ZONE2 : FRONT WIDE/HEIGHT 2 Height Layout : Front Height Speaker Select : Floor ZONE2 : OFF ZONE3 : OFF	<ul style="list-style-type: none"> <li>• Analog input ⇒ Speaker output (Surround Back L/R)</li> </ul> (※As the input source, you can switch from CBL/SAT to other ones.)

### 3.5.6. Video system confirmation items

fig. XX: See the block diagram of the fig.XXth.

Paths confirmation item		Display	Settings	Contents of confirmation Remarks
1	Analog Video <b>fig.16</b>	V01:VIDEO PASS	Input Source : CBL/SAT Video Convert(IP Scaler) : OFF, All sources MAIN ZONE : ON ZONE2 : ON ZONE3 : OFF	• Component input ⇒ Component output (※As the input source, you can switch from CBL/SAT to other ones.)
2	Video Convert (Analog or HDMI ⇒ HDMI) <b>fig.17</b>	V02:V.CONVERT	Input Source : CBL/SAT Video Convert(IP Scaler) : ON, All sources IP Scaler : "Analog & HDMI", All sources Resolution : "Auto", All sources MAIN ZONE : ON ZONE2 : OFF ZONE3 : OFF	• CVBS input ⇒ IP Scaler ⇒ HDMI output. • Component input ⇒ IP Scaler ⇒ HDMI output. • HDMI input ⇒ IP Scaler ⇒ HDMI output. • ETHERNET input ⇒ IP Scaler ⇒ HDMI output. (※The input source can be switched to any source except CBL/SAT.)
3	HDMI pass (MAIN ZONE) <b>fig.18</b>	V03:HDMI PASS	Input Source : CBL/SAT Source of Video Convert(IP Scaler) : OFF, All sources MAIN ZONE : ON ZONE2 : OFF ZONE3 : OFF	• HDMI input ⇒ HDMI output (MAIN ZONE) (※The input source can be switched to any source except CBL/SAT.)
4	HDMI CEC <b>fig.19</b>	V04:HDMI CEC	Input Source : CBL/SAT HDMI Control : ON MAIN ZONE : ON ZONE2 : OFF ZONE3 : OFF	• When the power supply of a TV is put in the standby mode, make sure that the power supply of this unit is also put in the standby mode. • The ARC path can also be checked (check this using the TV input source). (※The input source can be switched to any source except CBL/SAT.)
5	HDMI Audio (Audio : AVR) <b>fig.20a</b> <b>fig.20b</b> <b>fig.20c</b>	V05:H.AUDIO-AVR	Input Source : CBL/SAT HDMI Control : OFF HDMI Audio : AVR ( if checking the audio output from AVR )	• HDMI input(PCM , DolbyDigital , DTS) ⇒ Speaker output. • HDMI input(HD audio) ⇒ Speaker output. (※The input source can be switched to any source except CBL/SAT.)
6	HDMI Audio (Audio : TV) <b>fig.21a</b> <b>fig.21b</b>	V06:H.AUDIO-TV	Input Source : CBL/SAT HDMI Control : OFF HDMI Audio : TV ( if checking the audio output from TV )	• HDMI input(PCM , DolbyDigital , DTS) ⇒ HDMI output (audio output from connected TV) (※The input source can be switched to any source except CBL/SAT.)
7	GUI <b>fig.22</b>	V07:GUI MENU ON	Input Source : CBL/SAT Video Convert(IP Scaler) : ON, All sources IP Scaler : "Analog & HDMI", All sources Resolution : "AUTO", All sources Setup Menu : ON MAIN ZONE : ON ZONE2 : OFF ZONE3 : OFF	• GUI display ⇒ HDMI output. (※The input source can be switched to any source except CBL/SAT.)
8	HDMI (ZONE2) <b>fig.23</b>	V08:ZONE2 HDMI	Input Source : CBL/SAT ZONE2 Source : Source MAIN ZONE : ON ZONE2 : ON ZONE3 : OFF	• HDMI input ⇒ HDMI output (ZONE2) (※As the input source, you can switch from CBL/SAT to other ones.)



fig.02a

AVR-X5200 DIGITAL AUDIO/NETWORK BLOCK DIRAGRAM

DIGITAL PCB BLOCK

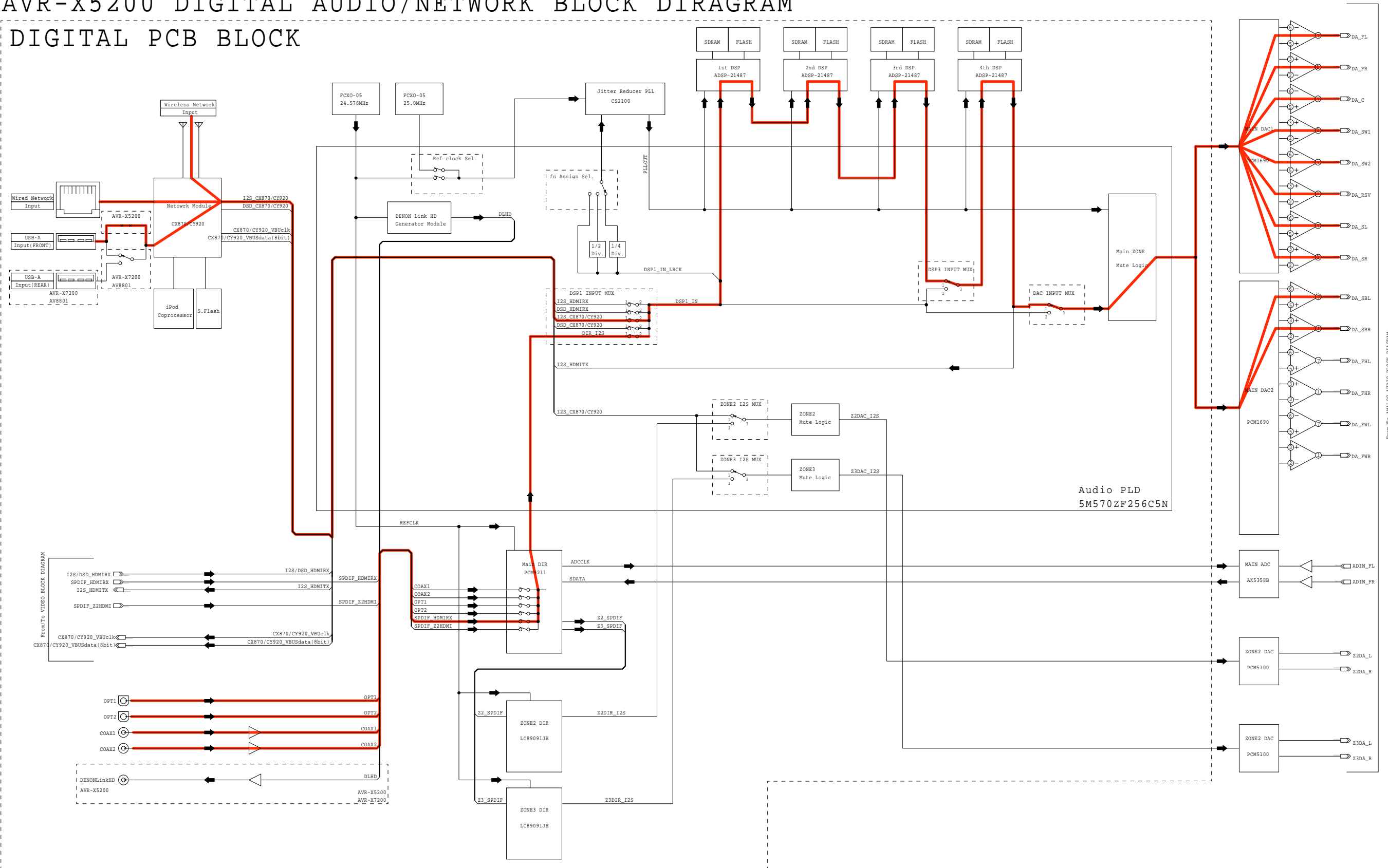



fig.03a

# AVR-X5200 BLOCK DIAGRAM (VIDEO) DIGITAL PCB BLOCK

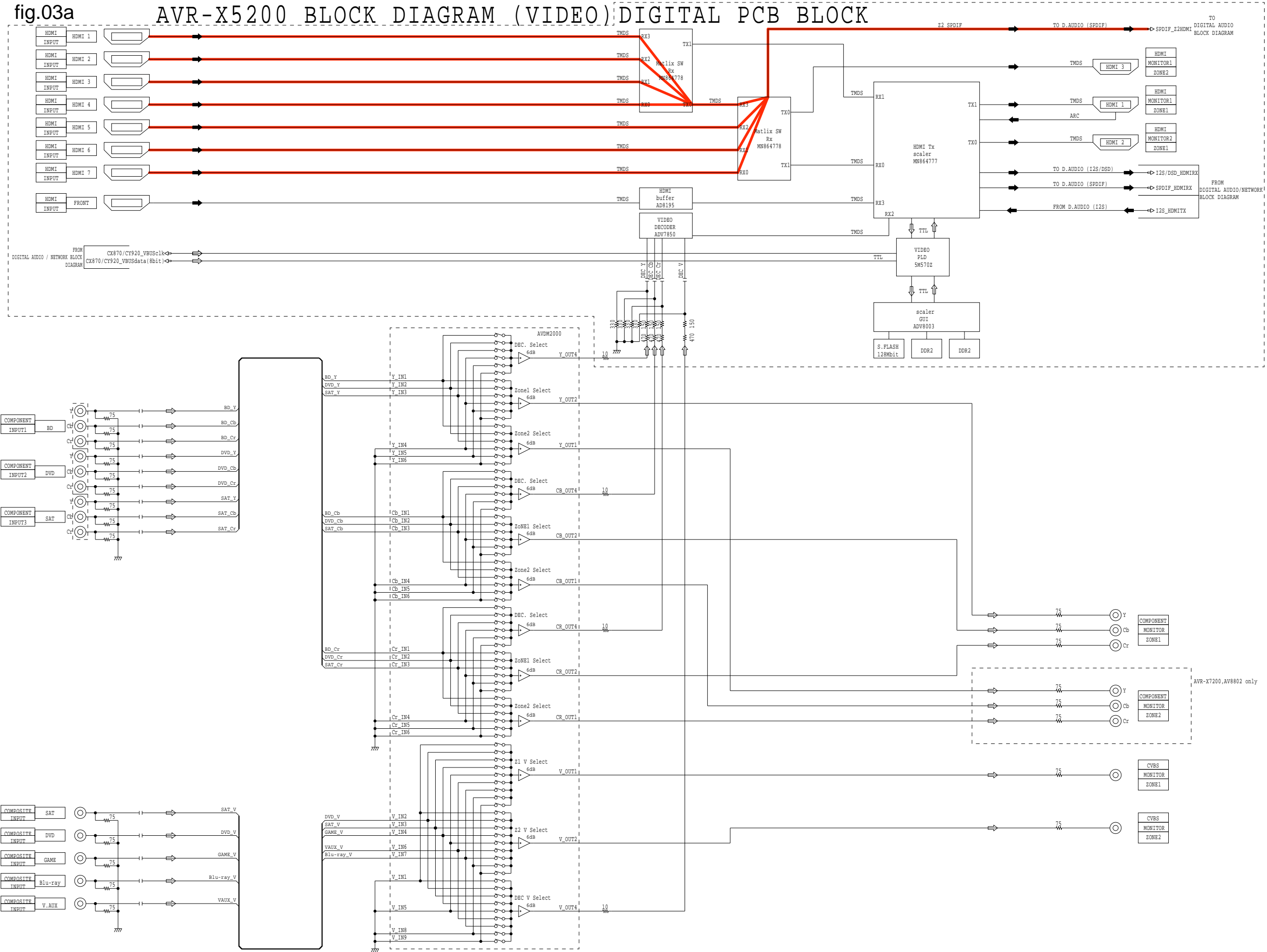

fig.03b

AVR-X5200 DIGITAL AUDIO/NETWORK BLOCK DIRAGRAM

DIGITAL PCB BLOCK

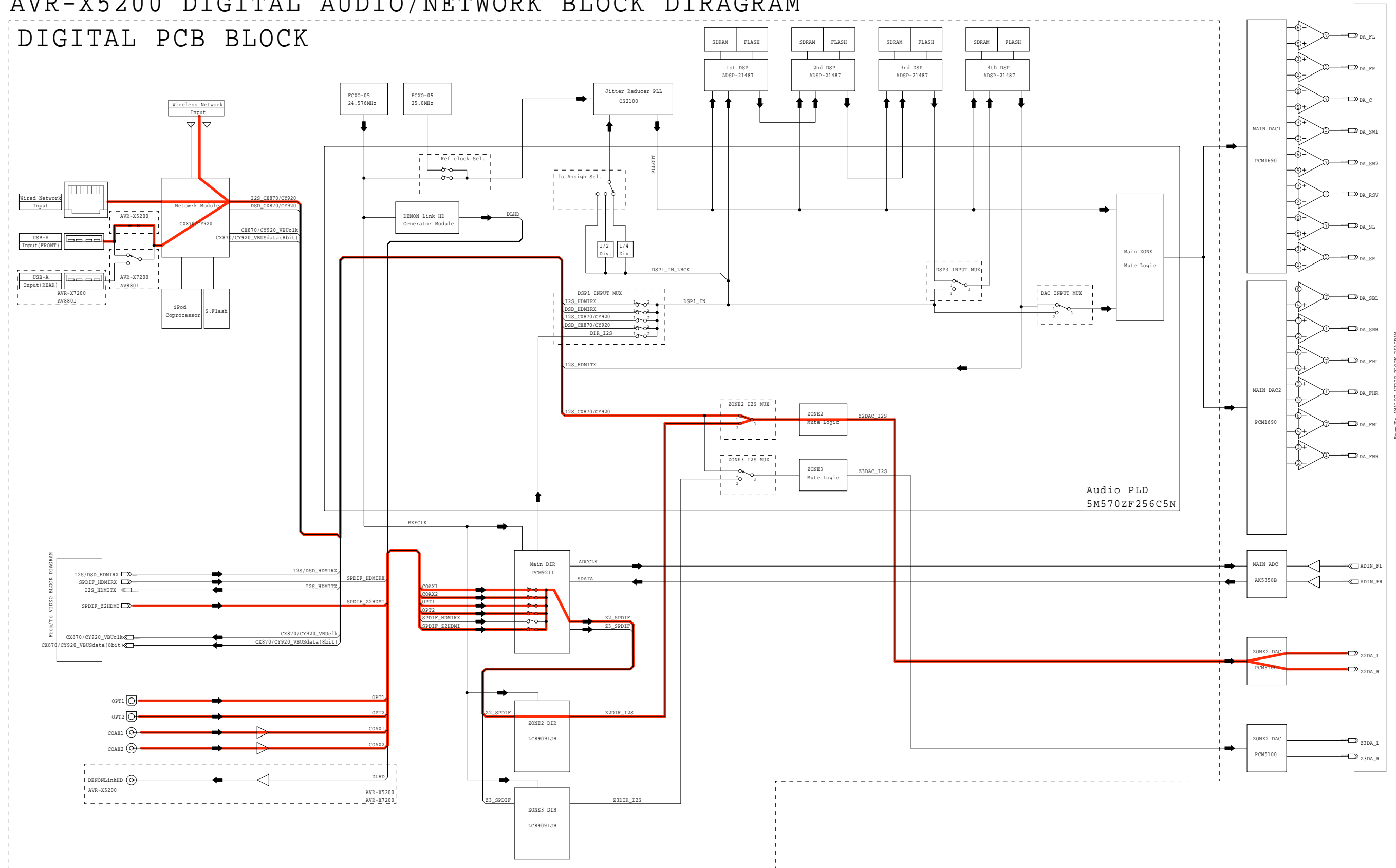





fig.04a

# AVR-X5200 DIGITAL AUDIO/NETWORK BLOCK DIRAGRAM

## DIGITAL PCB BLOCK

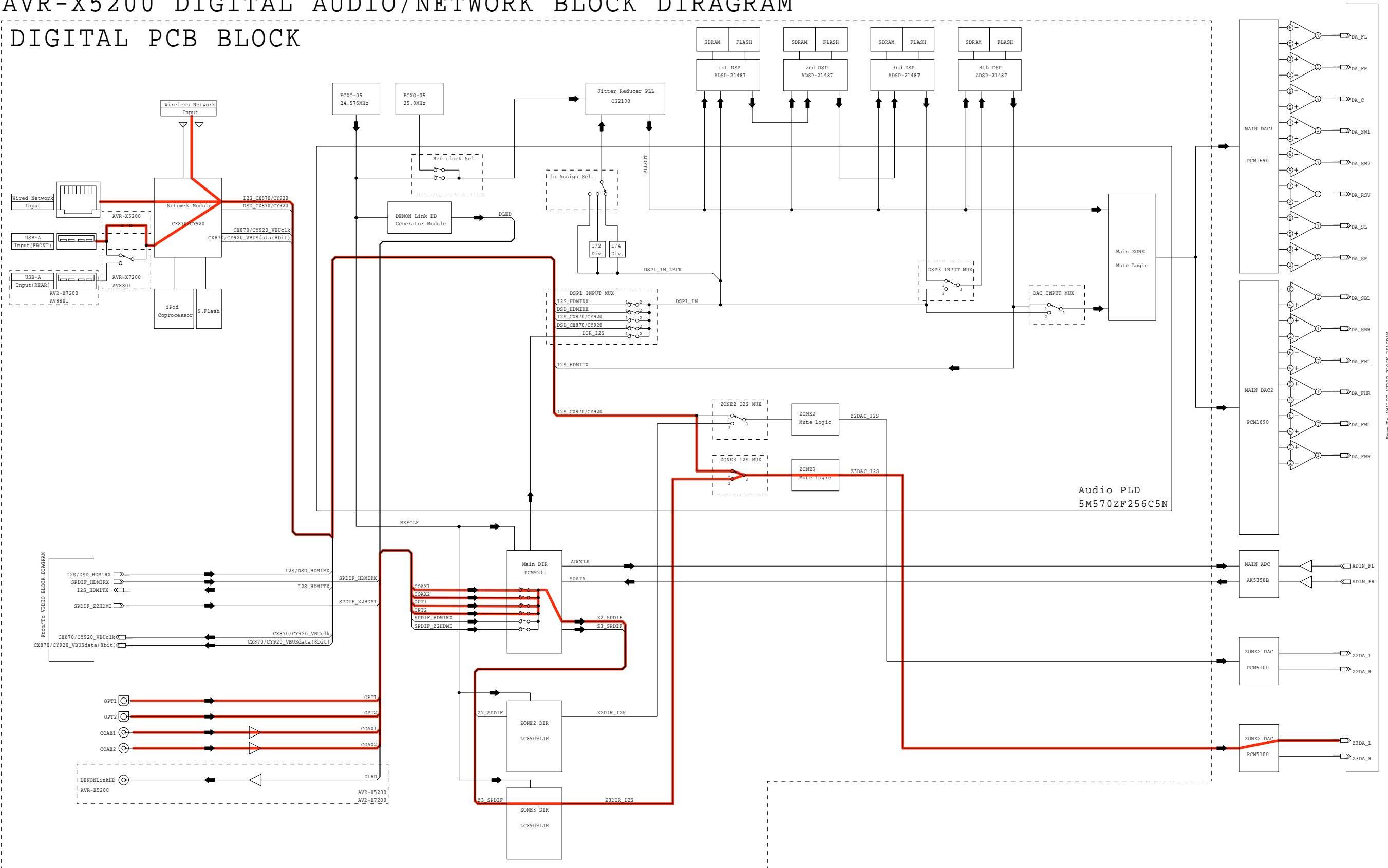



fig.05a

AVR-X5200 BLOCK DIAGRAM (VIDEO) DIGITAL PCB BLOCK

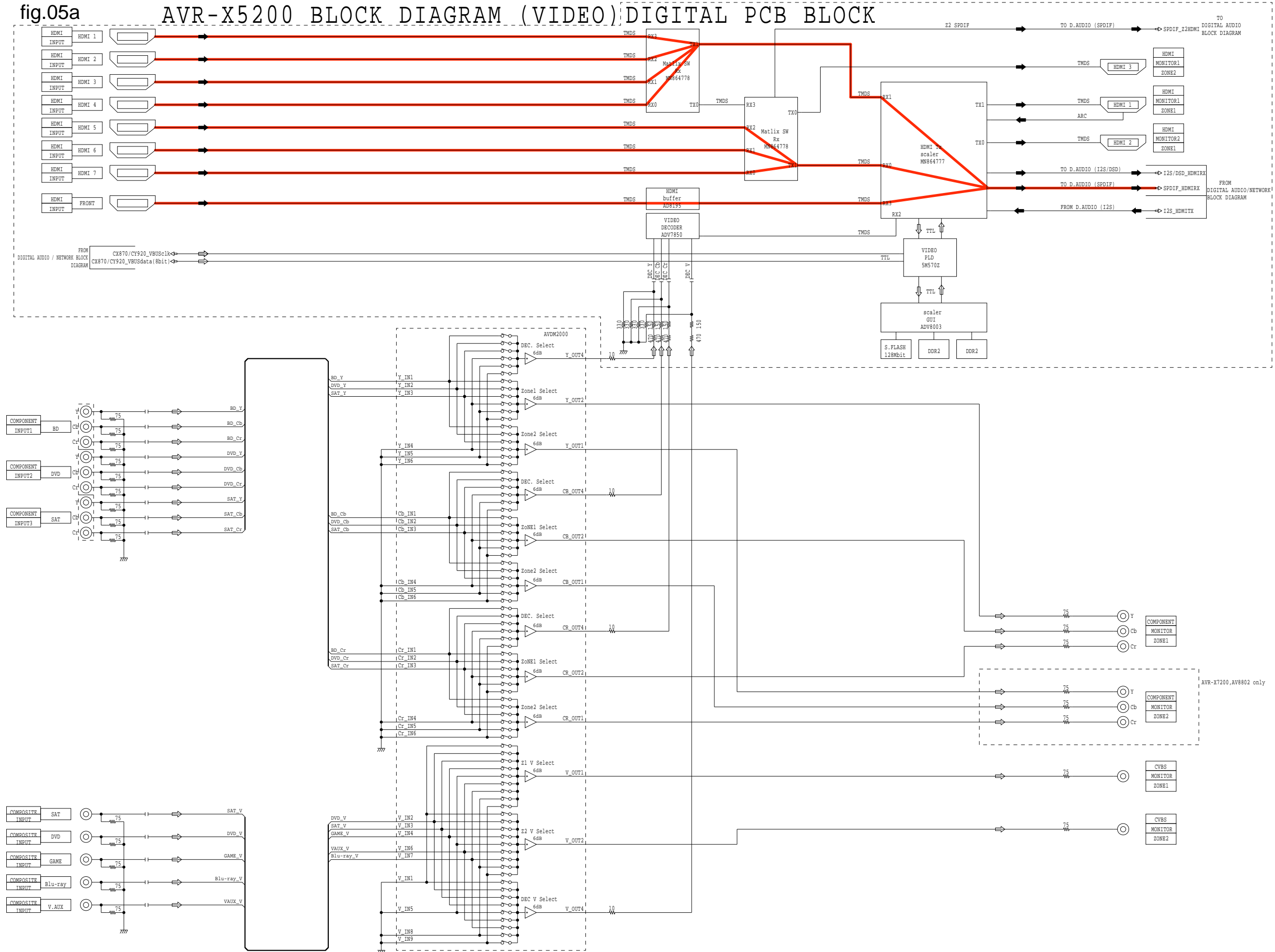
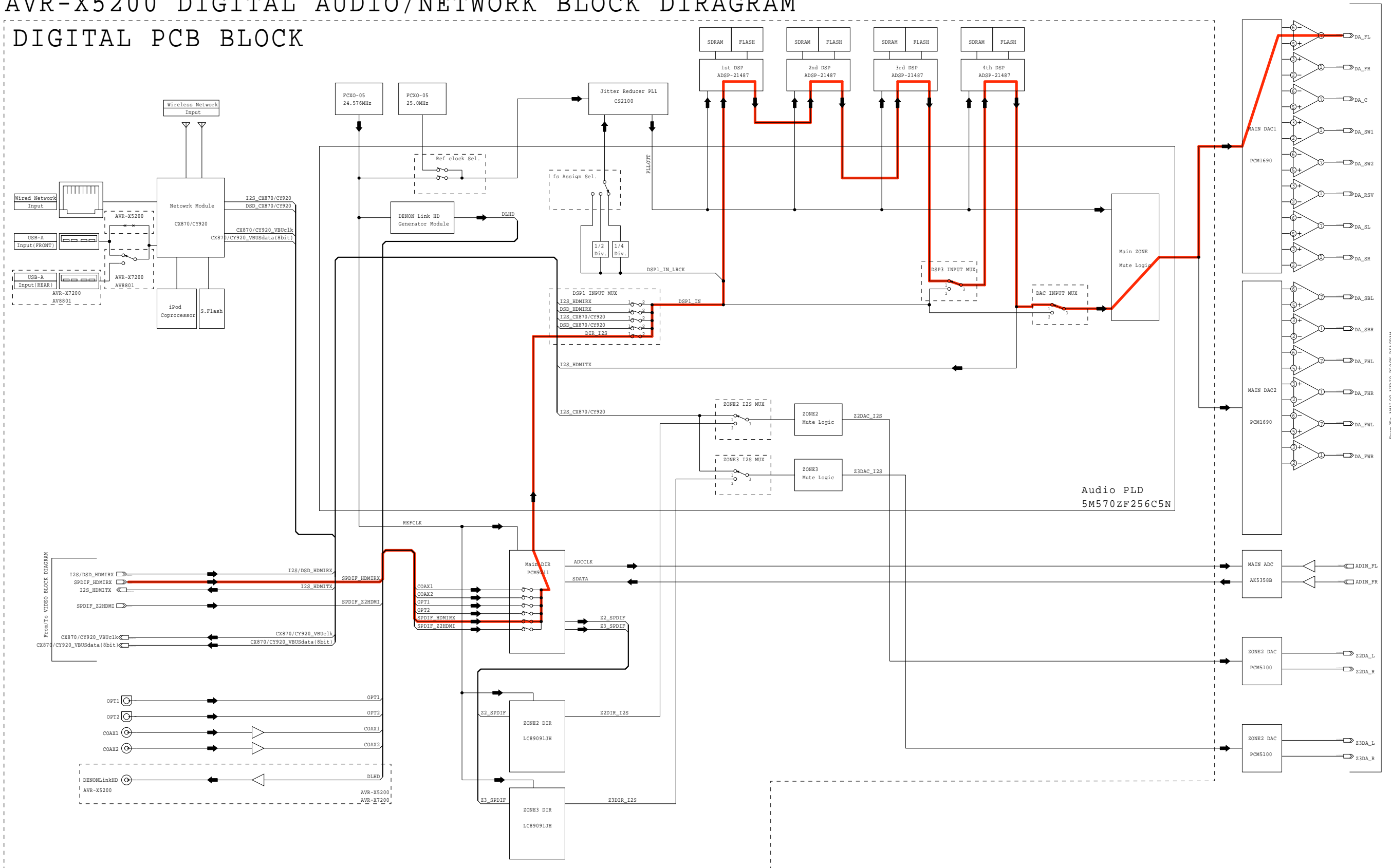

fig.05b

AVR-X5200 DIGITAL AUDIO/NETWORK BLOCK DIRAGRAM

DIGITAL PCB BLOCK



From To ANALOG AUDIO BLOCK DIAGRAM



fig.06a

AVR-X5200 DIGITAL AUDIO/NETWORK BLOCK DIRAGRAM

DIGITAL PCB BLOCK

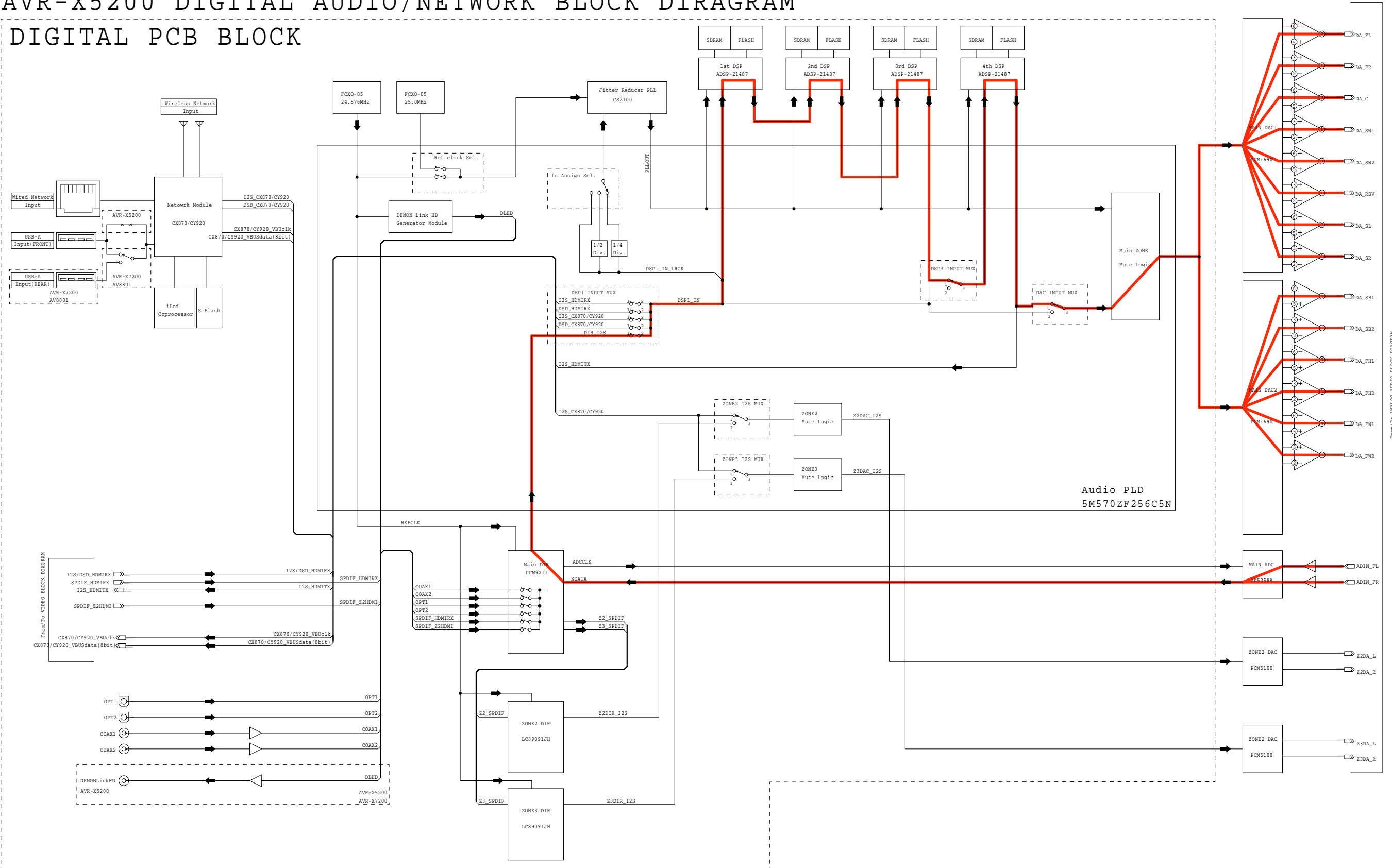

From/To ANALOG AUDIO BLOCK DIAGRAM





fig.07

AVR-X5200 BLOCK DIAGRAM (A.AUDIO/Z2,3HPF)

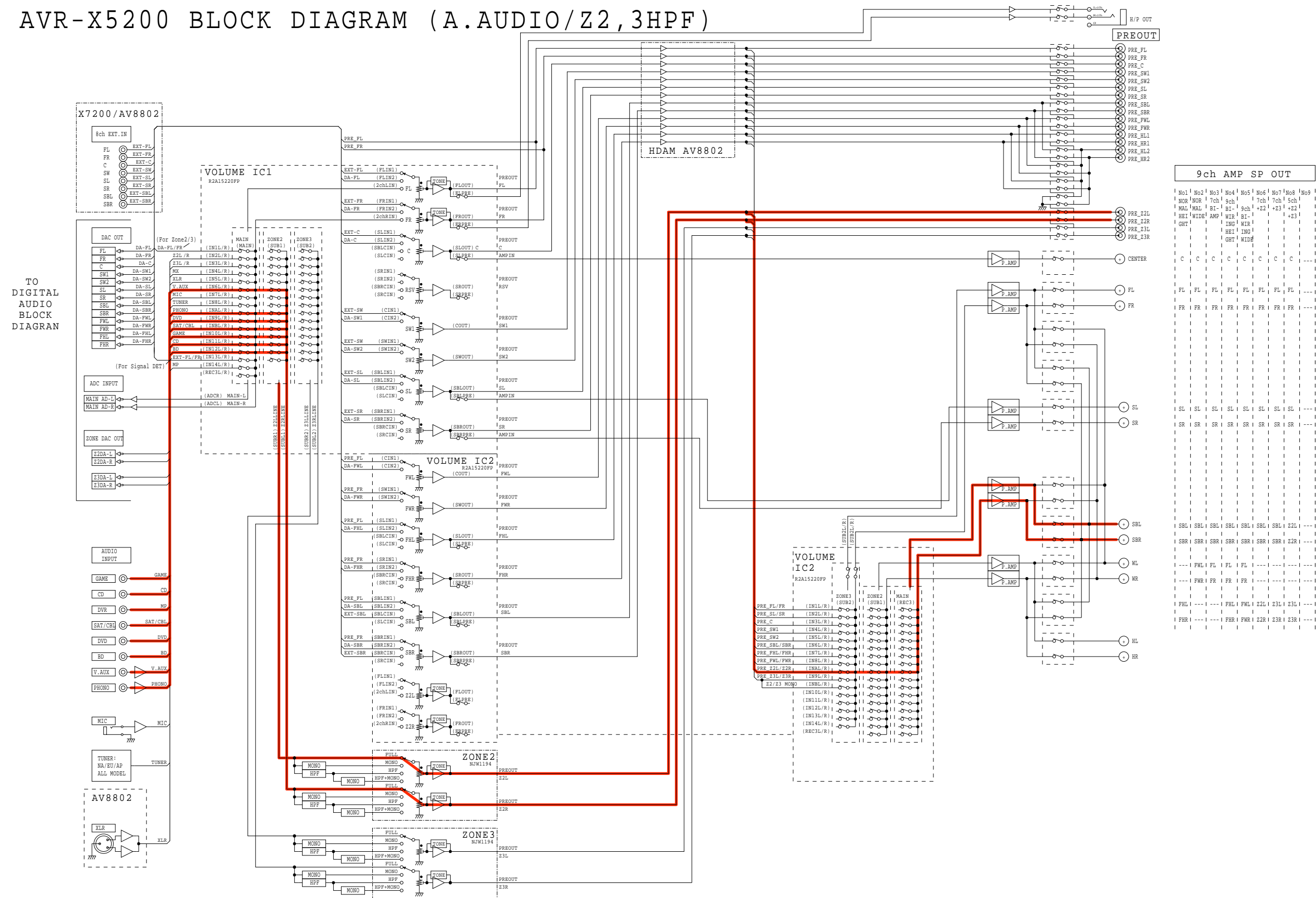

9ch AMP SP OUT

No1	No2	No3	No4	No5	No6	No7	No8	No9
WDR	WDR	7ch	9ch	7ch	7ch	5ch		
WAL	WAL	BT-	BT-	9ch	+22	+23	+22	+23
HEI	WIDE	AMP	WIR	BT-				
GHT			ING	WIR				
			HEI	ING				
			GHT	WIDE				
C	C	C	C	C	C	C	C	C
FL	FL	FL	FL	FL	FL	FL	FL	FL
FR	FR	FR	FR	FR	FR	FR	FR	FR
SL	SL	SL	SL	SL	SL	SL	SL	SL
SR	SR	SR	SR	SR	SR	SR	SR	SR
SBL	SBL	SBL	SBL	SBL	SBL	SBL	Z2L	
SBR	SBR	SBR	SBR	SBR	SBR	SBR	Z2R	
FWL	FWL	FWL	FWL	FWL	FWL	FWL		
FWR	FWR	FWR	FWR	FWR	FWR	FWR		
HL								
HR								





fig.09

AVR-X5200 BLOCK DIAGRAM (A.AUDIO/Z2,3HPF)

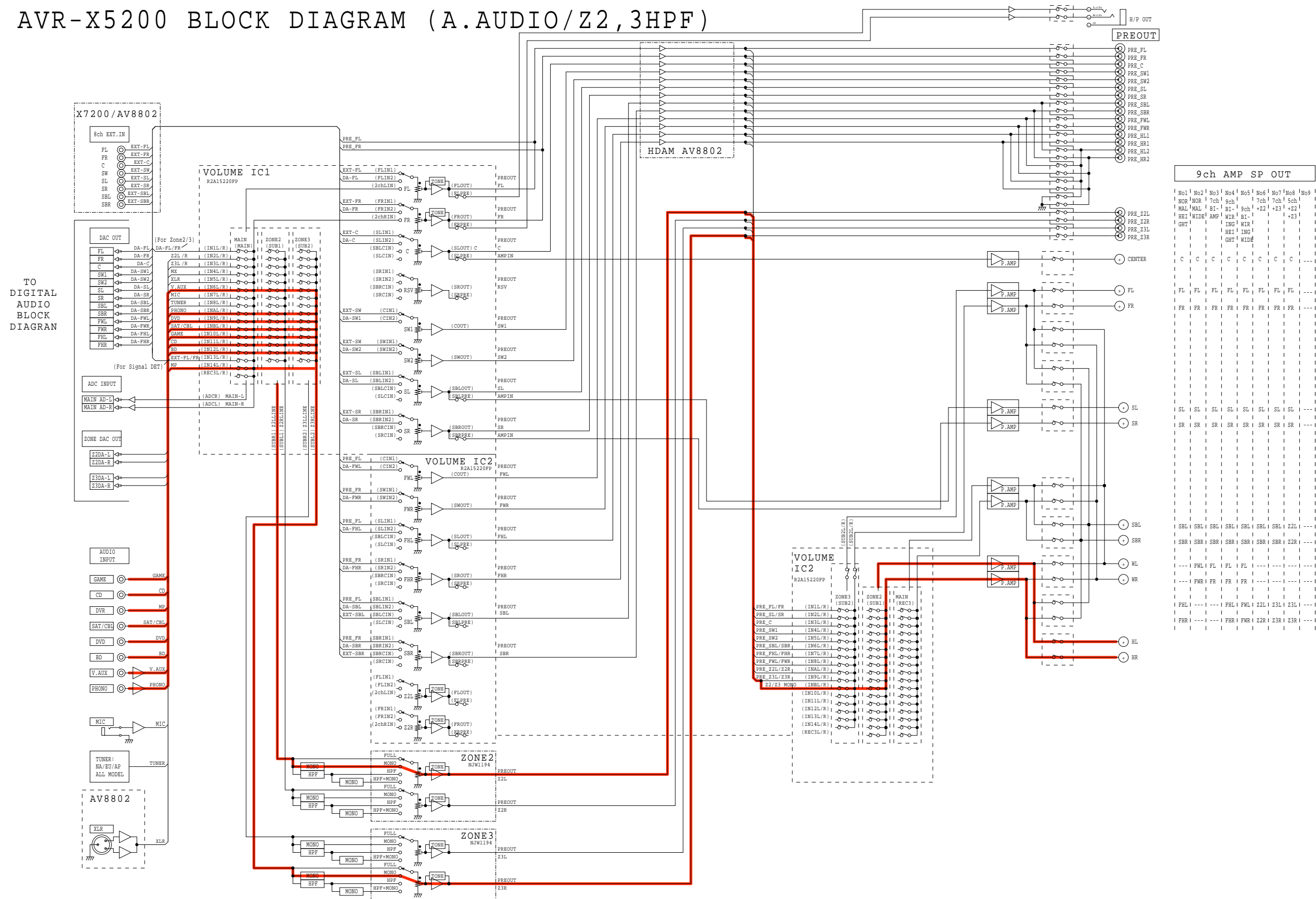

fig.10a

# AVR-X5200 DIGITAL AUDIO/NETWORK BLOCK DIRAGRAM

## DIGITAL PCB BLOCK

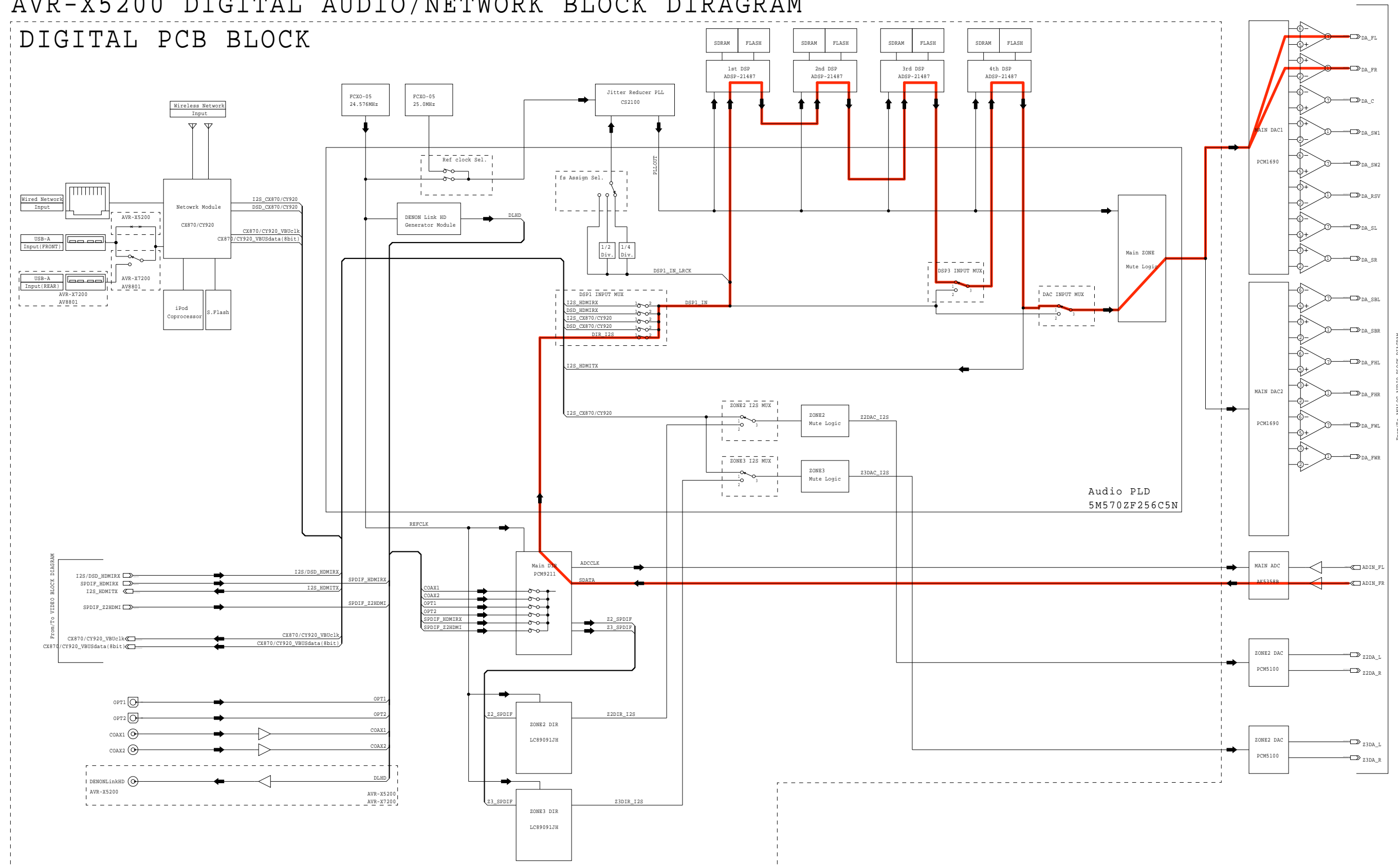



fig.11a

# AVR-X5200 DIGITAL AUDIO/NETWORK BLOCK DIRAGRAM

## DIGITAL PCB BLOCK

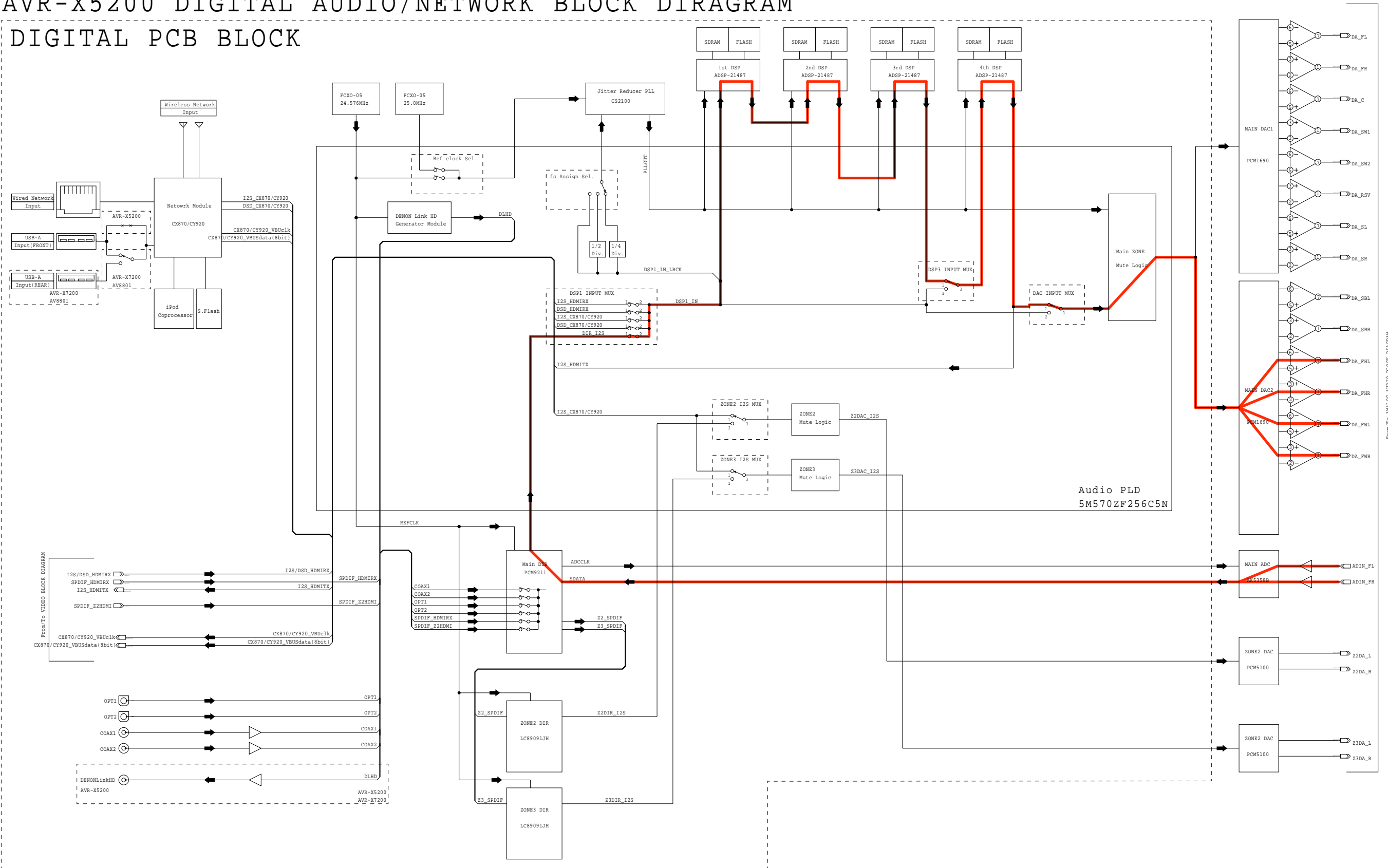



fig.12a

AVR-X5200 DIGITAL AUDIO/NETWORK BLOCK DIRAGRAM

DIGITAL PCB BLOCK

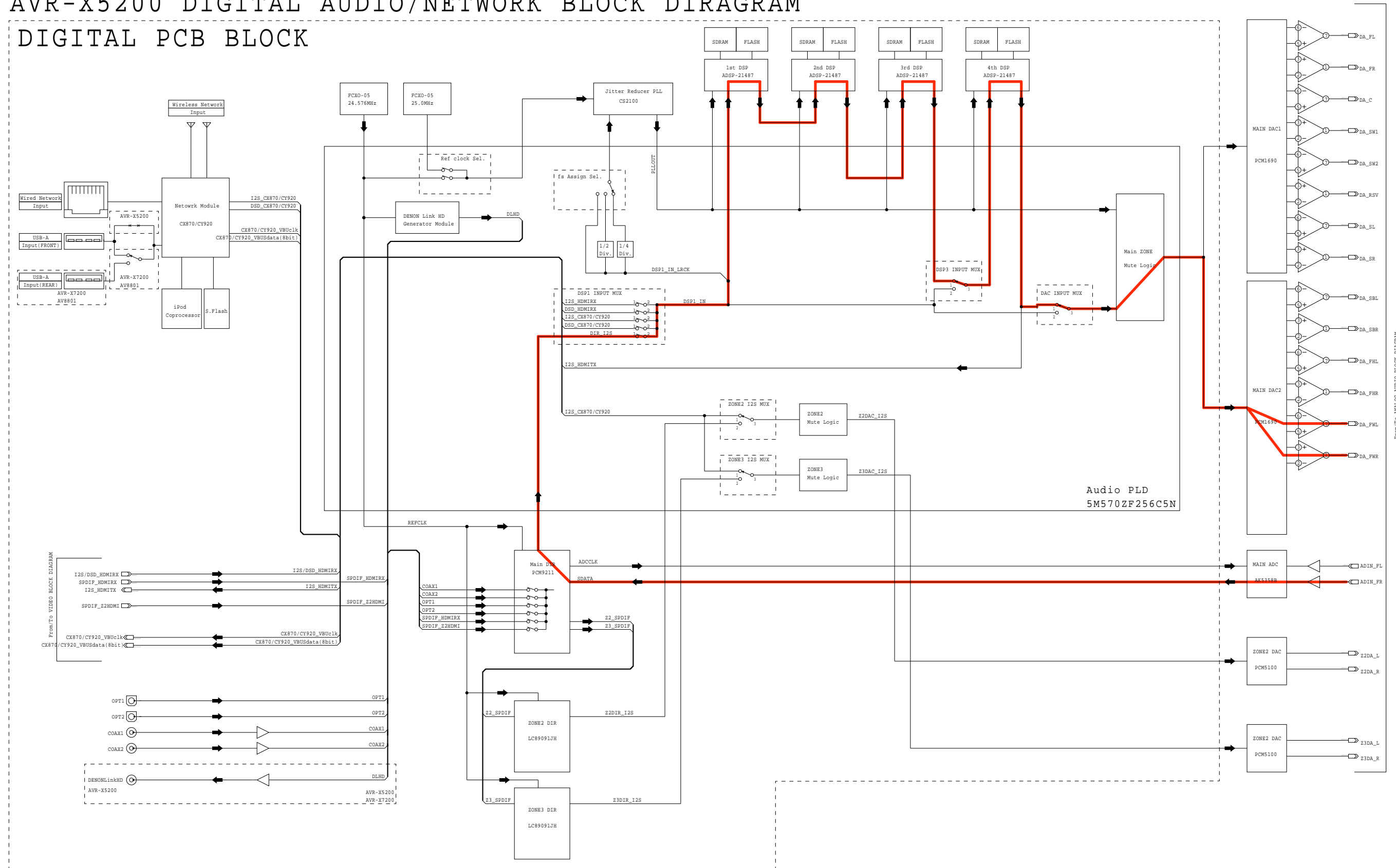



fig.12b

# AVR-X5200 BLOCK DIAGRAM (A.AUDIO/Z2,3HPF)

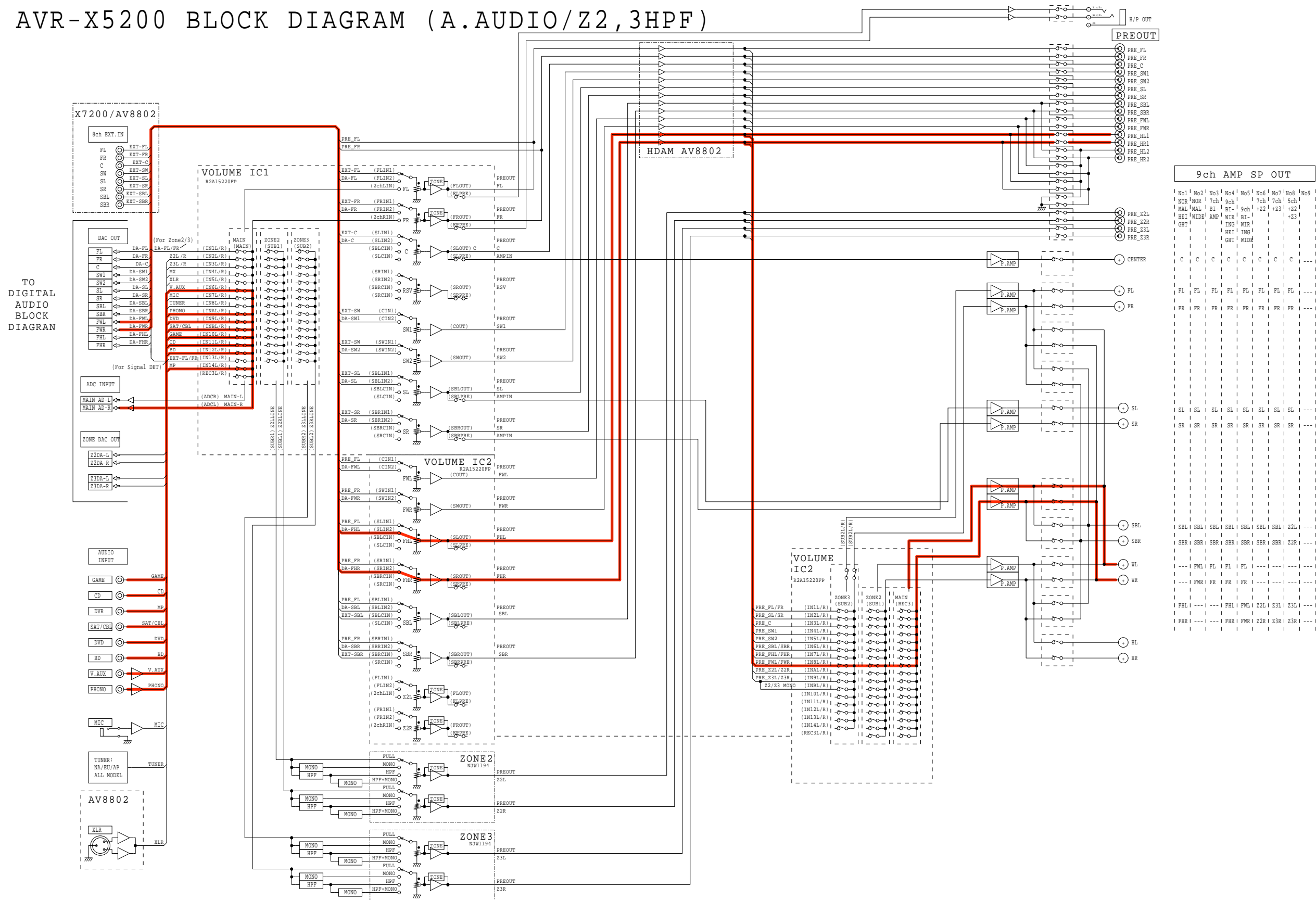



fig.13a

AVR-X5200 DIGITAL AUDIO/NETWORK BLOCK DIRAGRAM

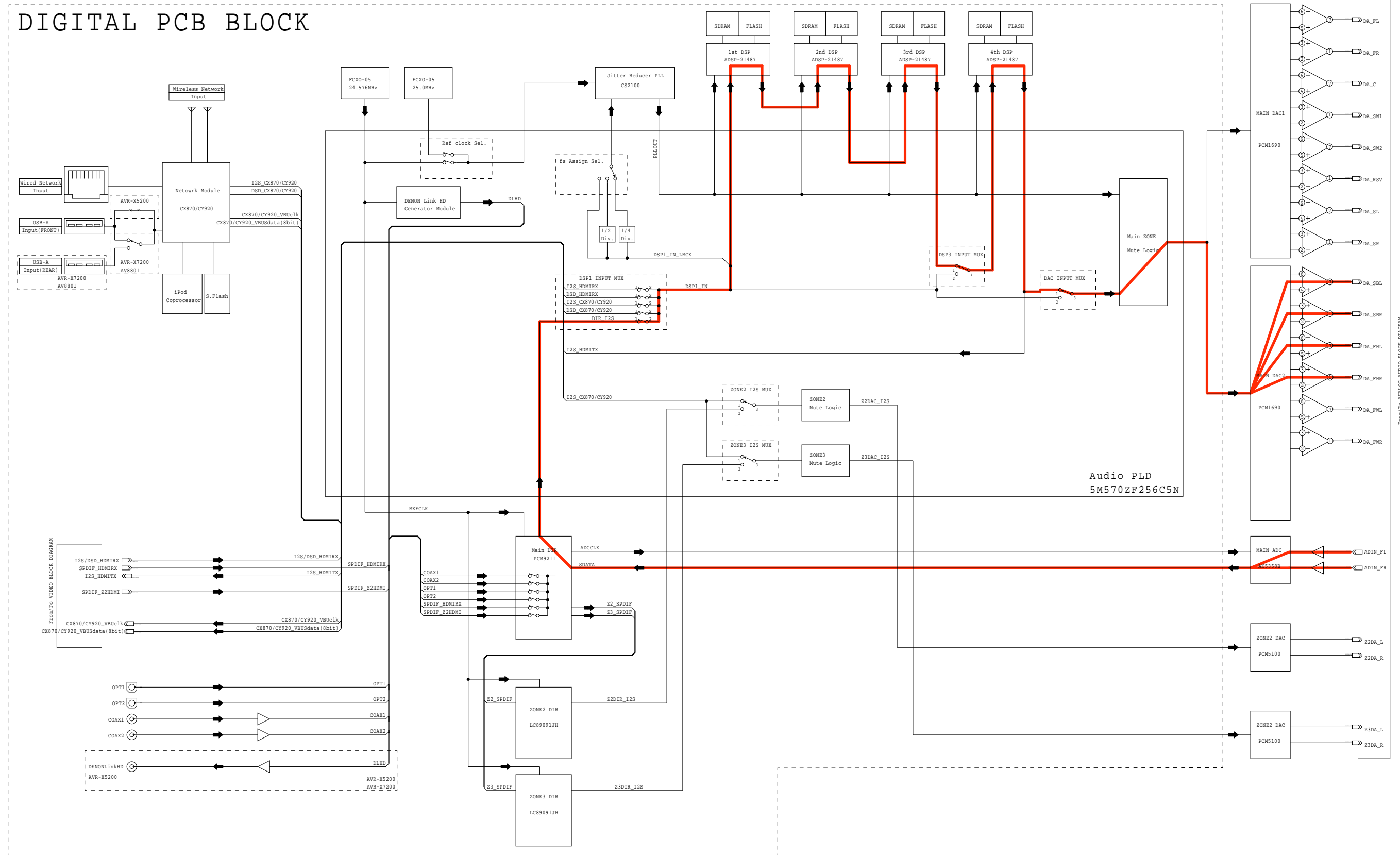

fig.13b

# AVR-X5200 BLOCK DIAGRAM (A.AUDIO/Z2,3HPF)

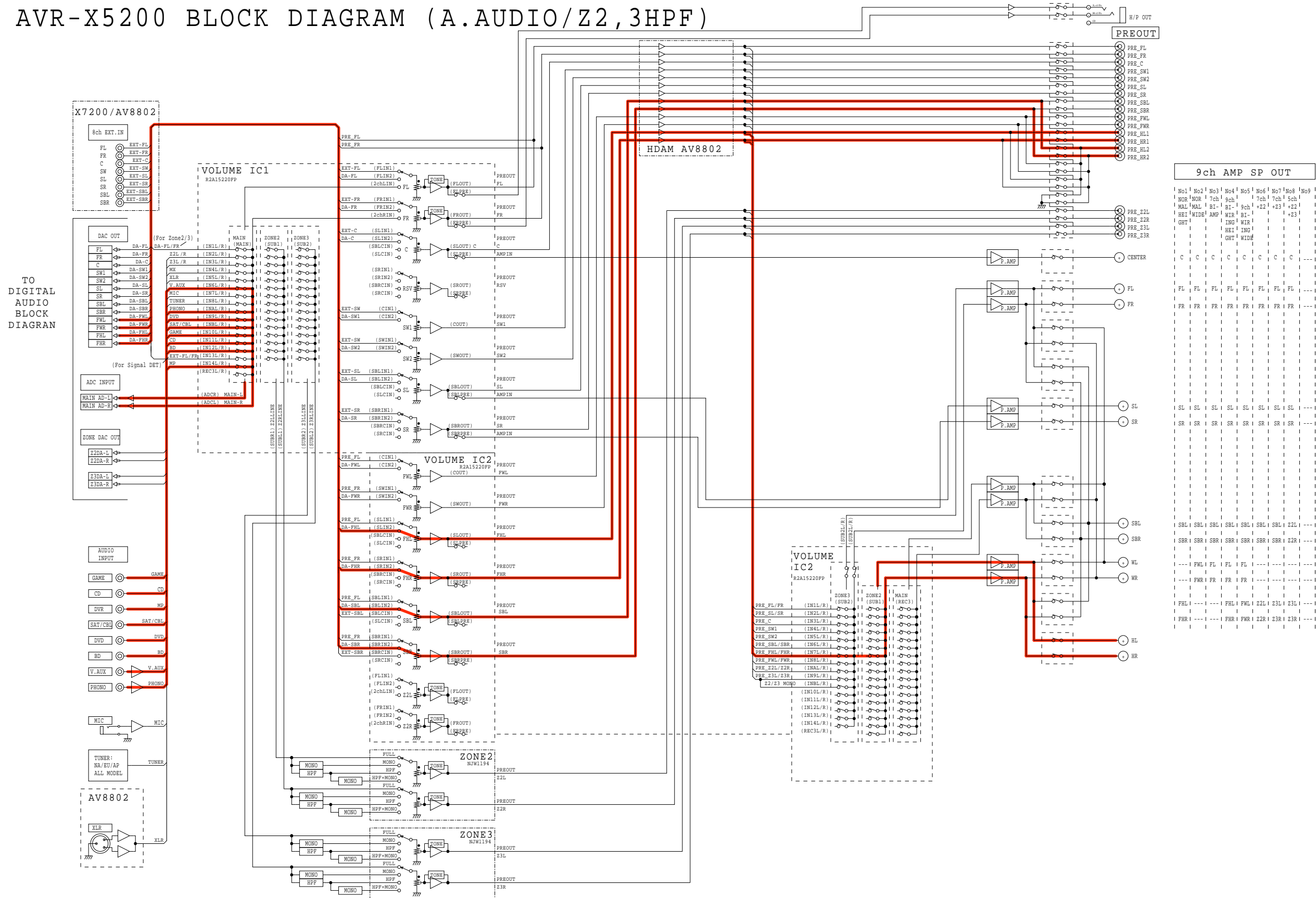

fig.14a

AVR-X5200 DIGITAL AUDIO/NETWORK BLOCK DIRAGRAM

DIGITAL PCB BLOCK

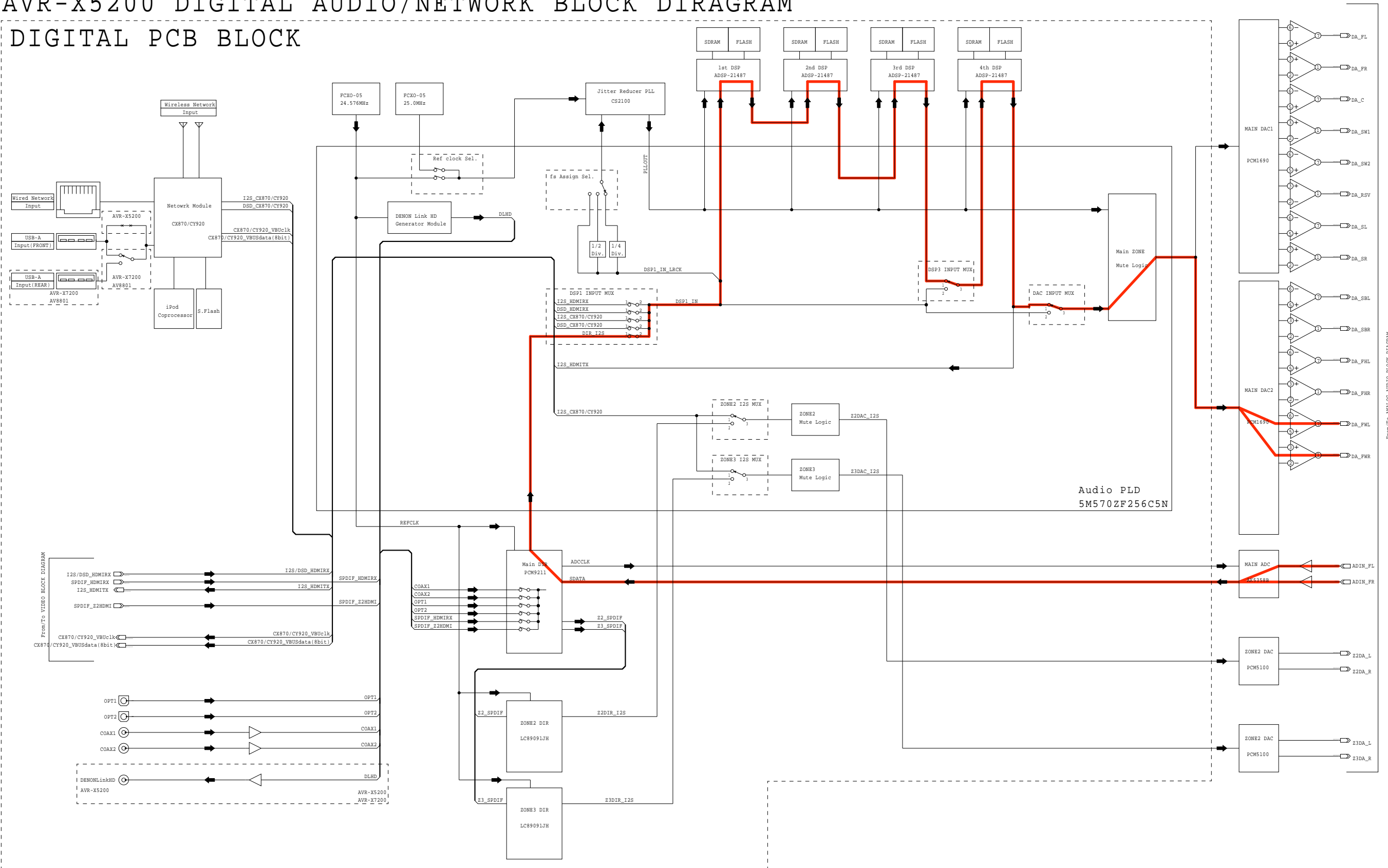
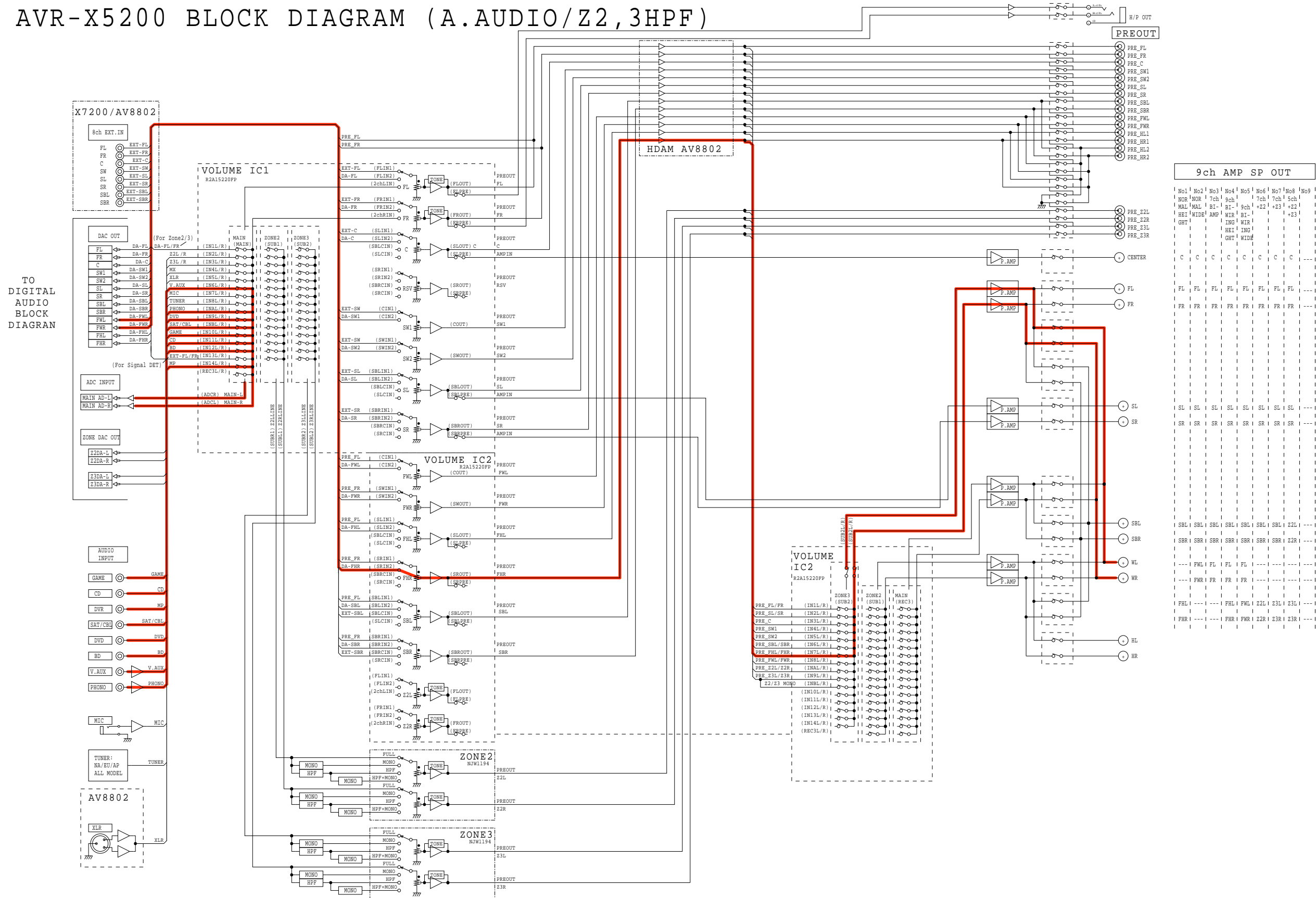

fig.14b

# AVR-X5200 BLOCK DIAGRAM (A.AUDIO/Z2,3HPF)



TO  
DIGITAL  
AUDIO  
BLOCK  
DIAGRAM

### 9ch AMP SP OUT

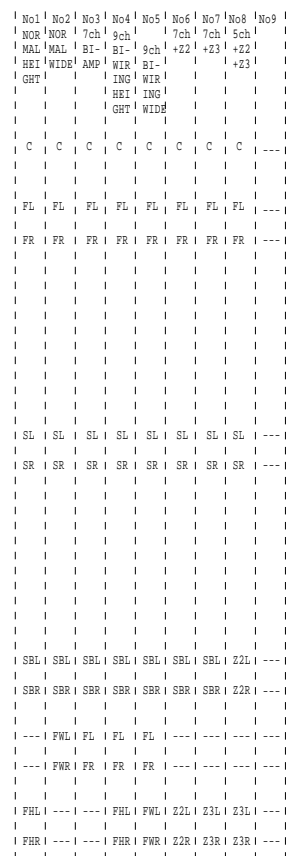





fig.16

AVR-X5200 BLOCK DIAGRAM (VIDEO) DIGITAL PCB BLOCK

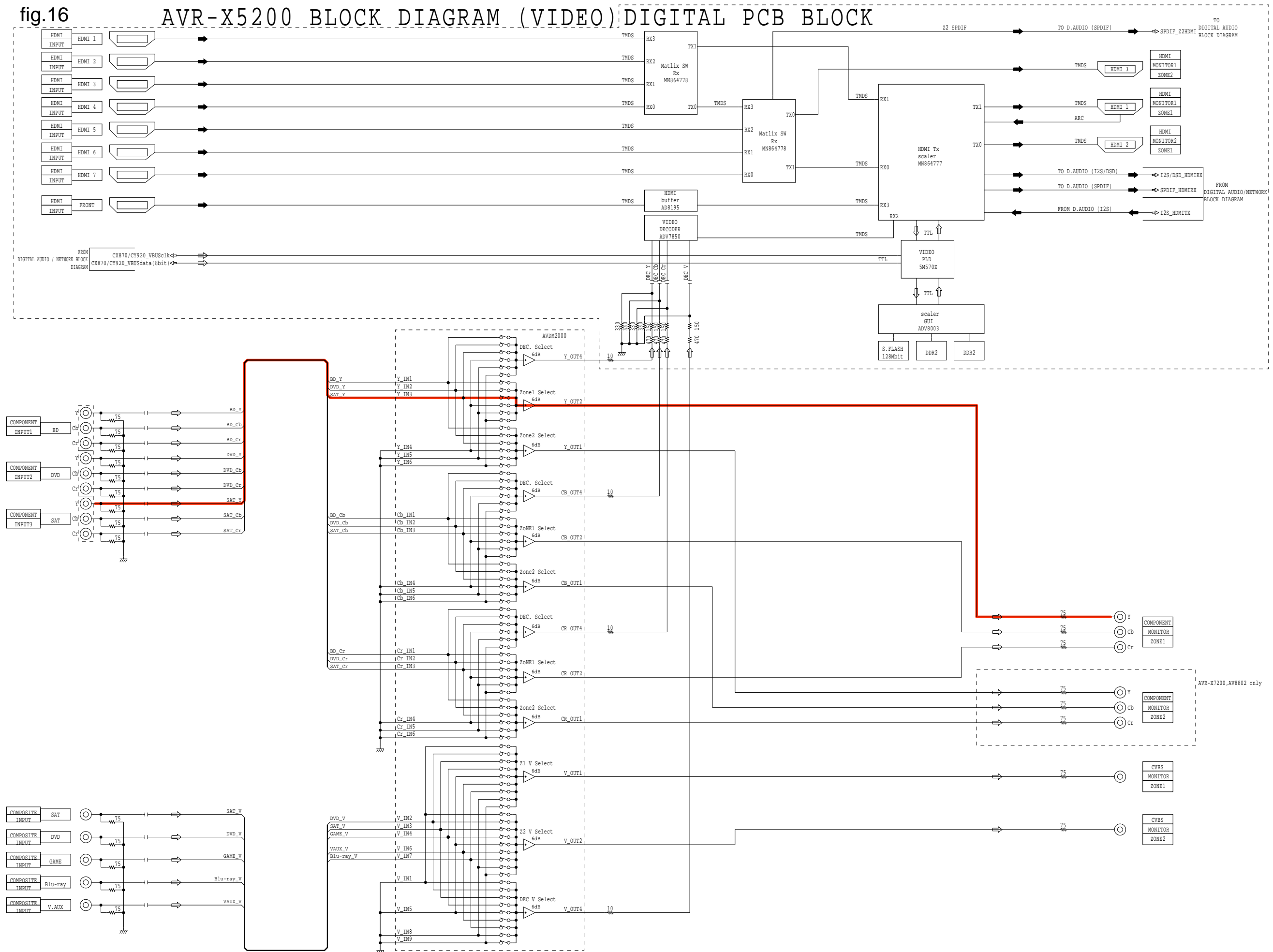



fig.17 AVR-X5200 BLOCK DIAGRAM (VIDEO) DIGITAL PCB BLOCK

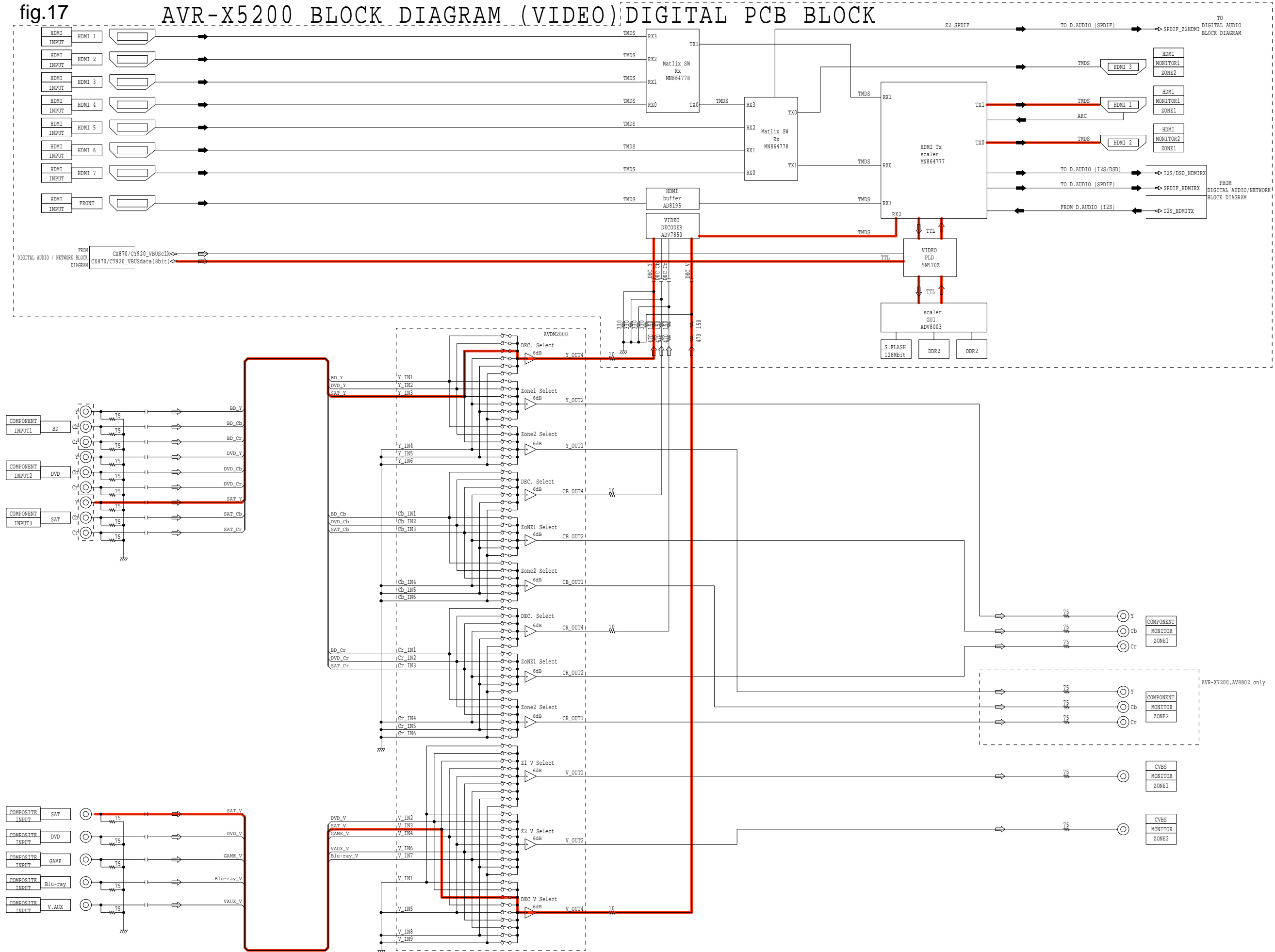

fig.18

AVR-X5200 BLOCK DIAGRAM (VIDEO) DIGITAL PCB BLOCK

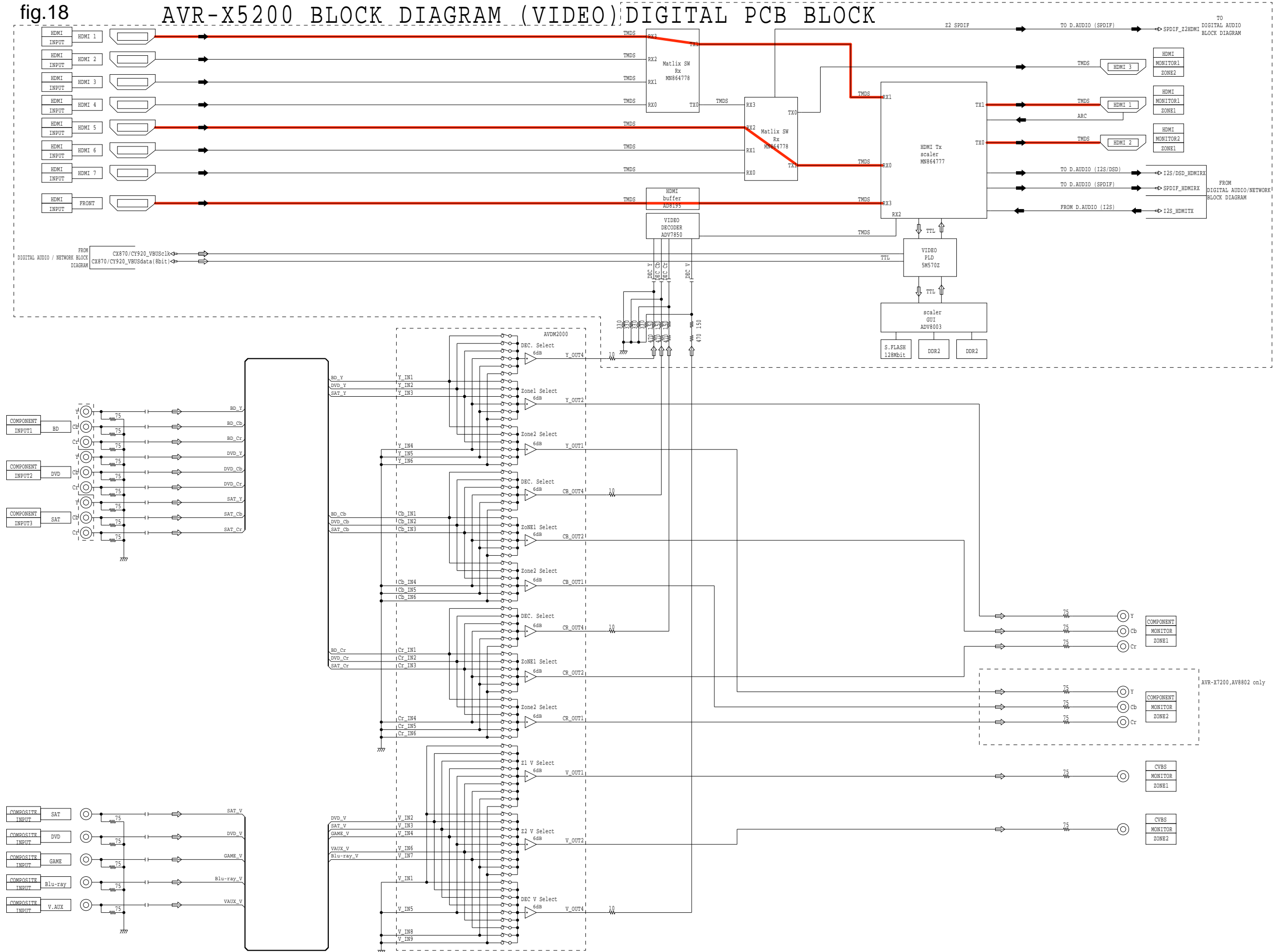

fig.19 AVR-X5200 BLOCK DIAGRAM (VIDEO) DIGITAL PCB BLOCK

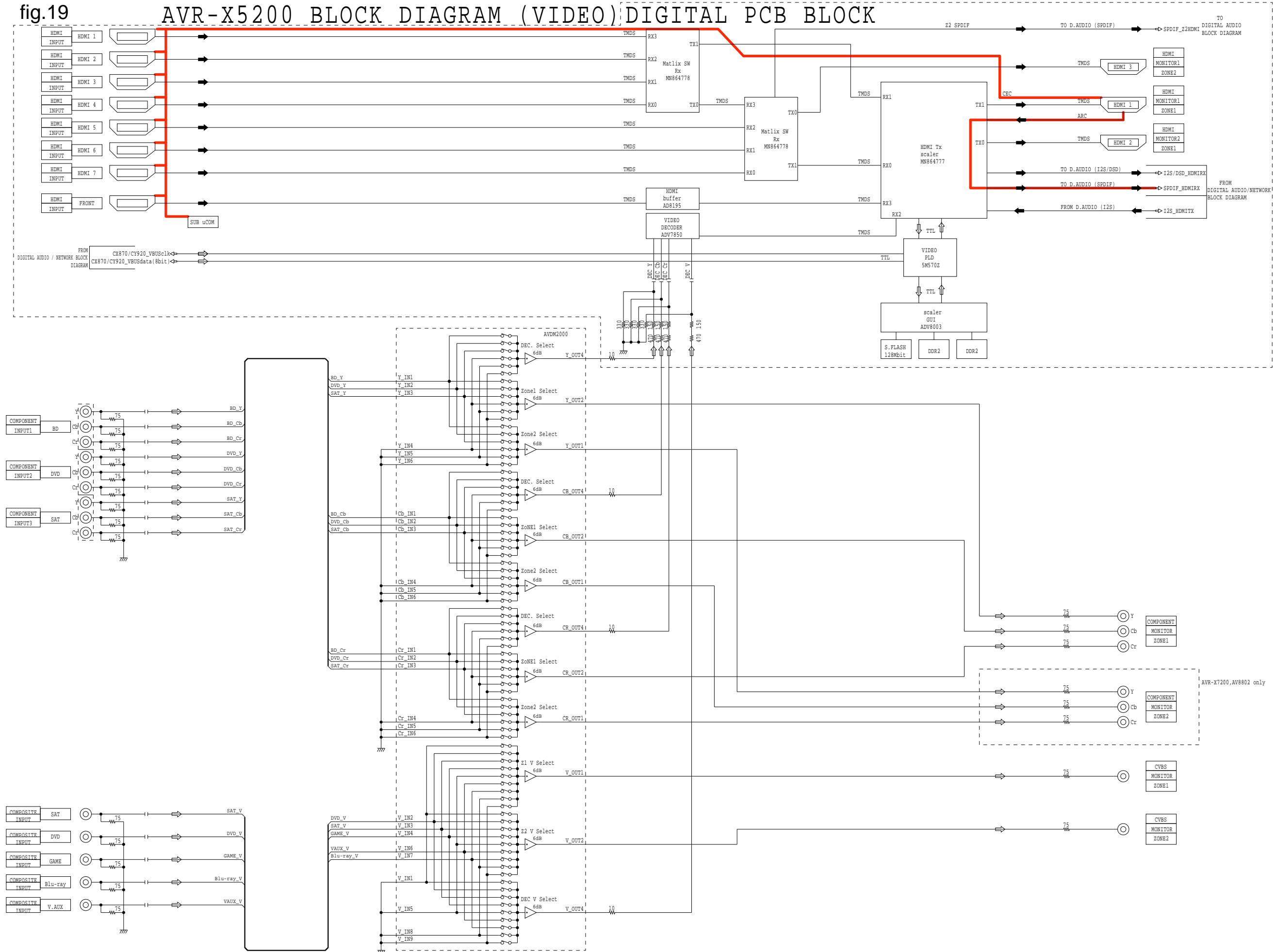

fig.20a

# AVR-X5200 BLOCK DIAGRAM (VIDEO) DIGITAL PCB BLOCK

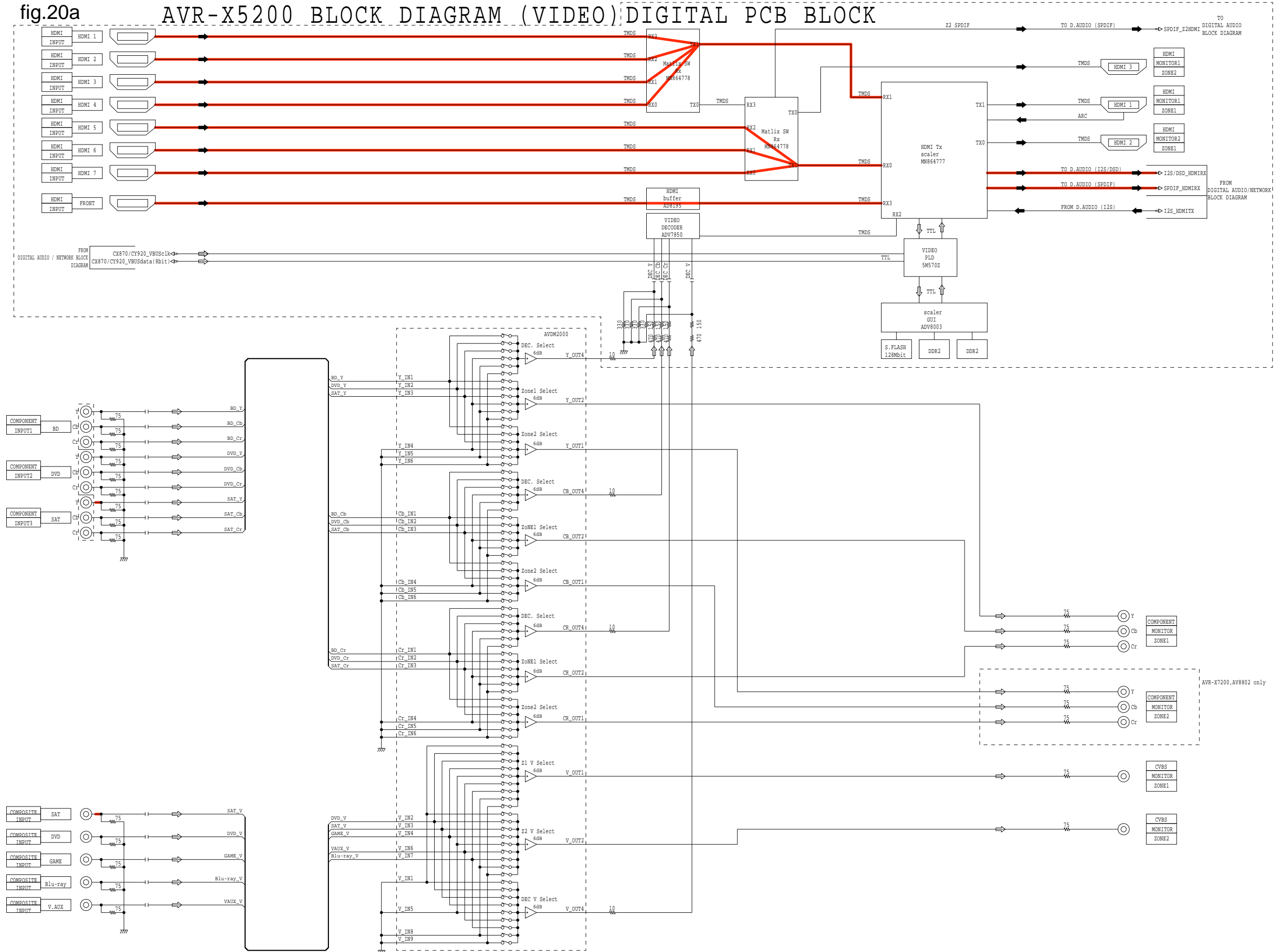
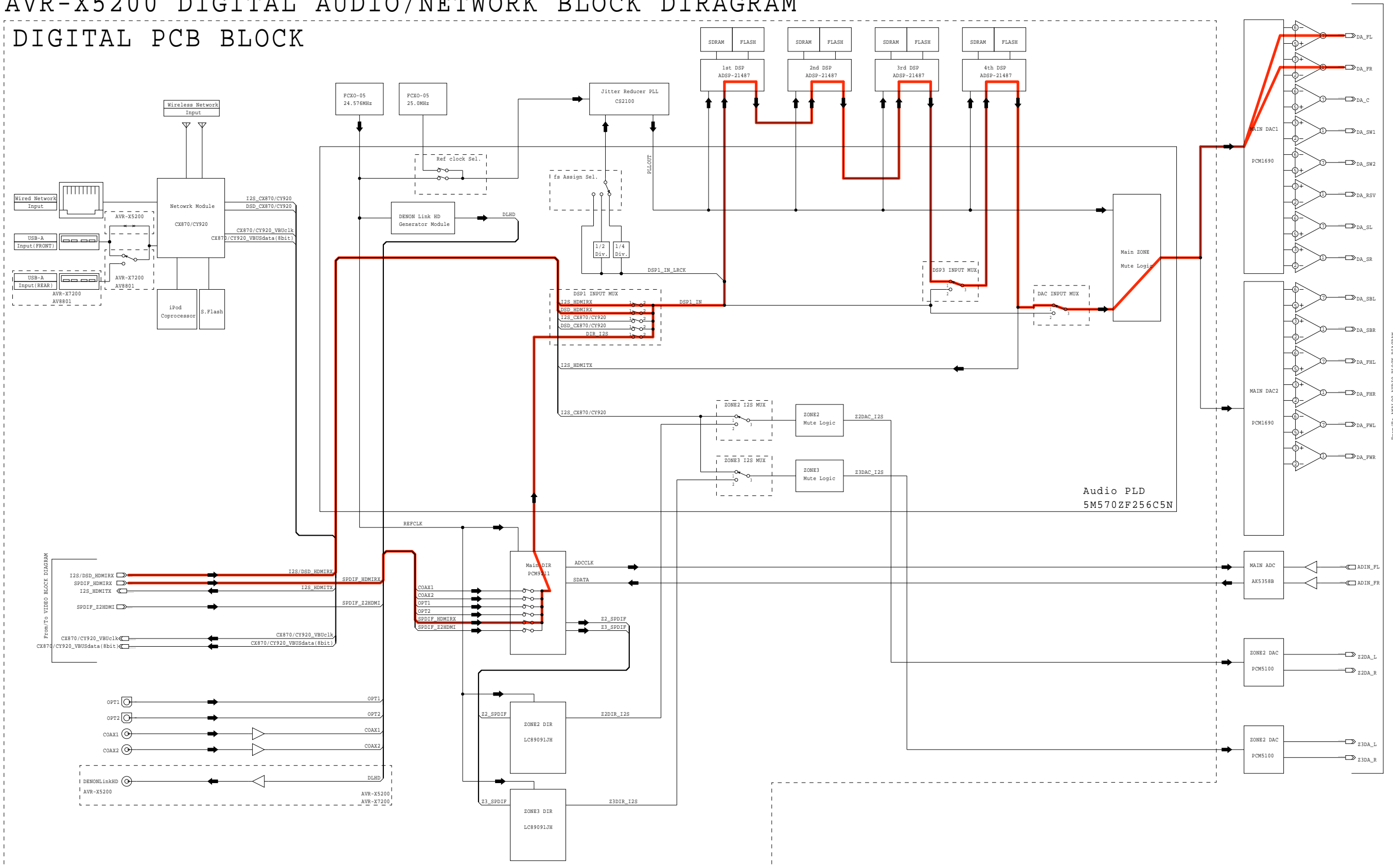

fig.20b

# AVR-X5200 DIGITAL AUDIO/NETWORK BLOCK DIRAGRAM

## DIGITAL PCB BLOCK



From To ANALOG AUDIO BLOCK DIAGRAM

fig.20c

AVR-X5200 BLOCK DIAGRAM (A.AUDIO/Z2,3HPF)

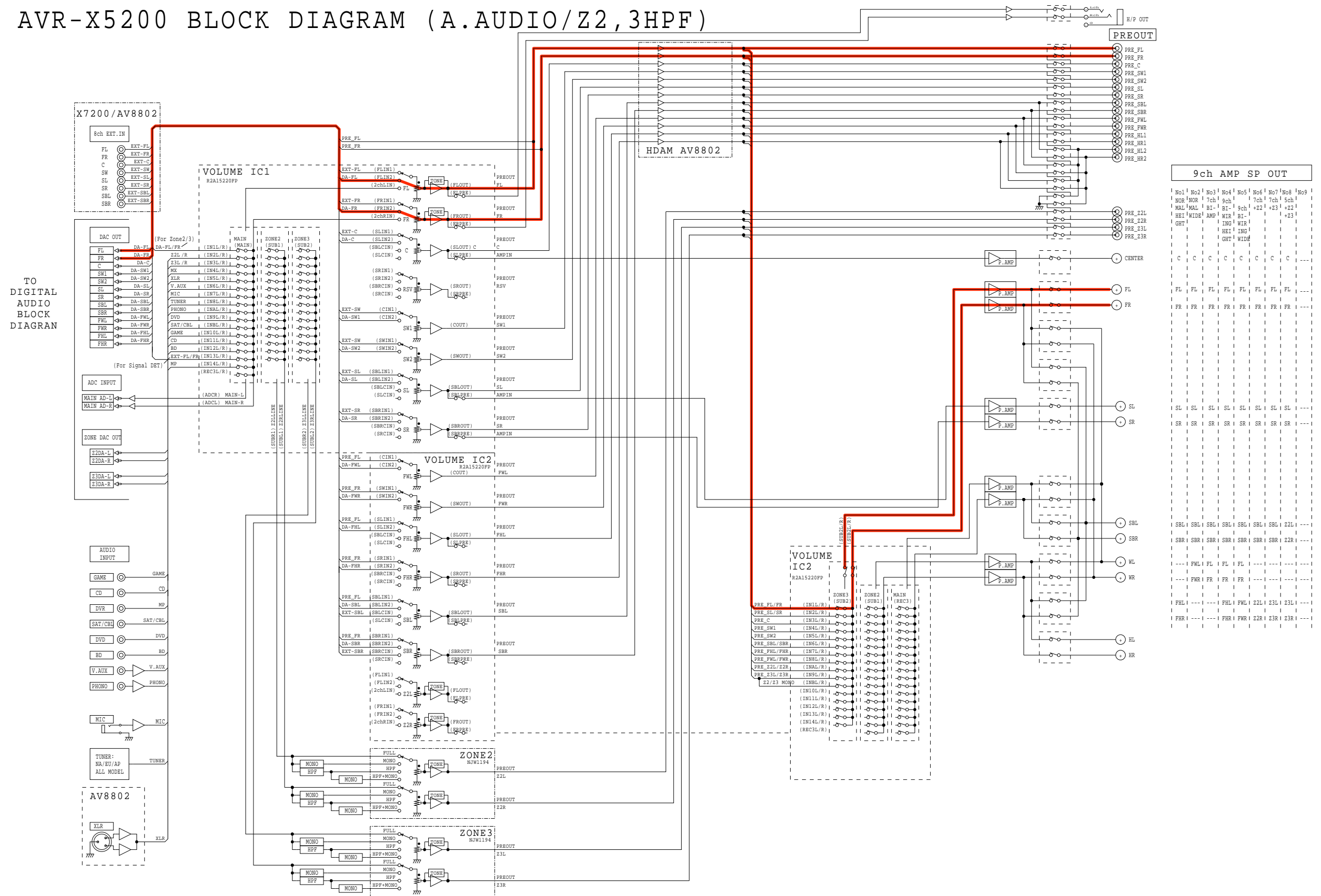





fig.21b

AVR-X5200 DIGITAL AUDIO/NETWORK BLOCK DIRAGRAM

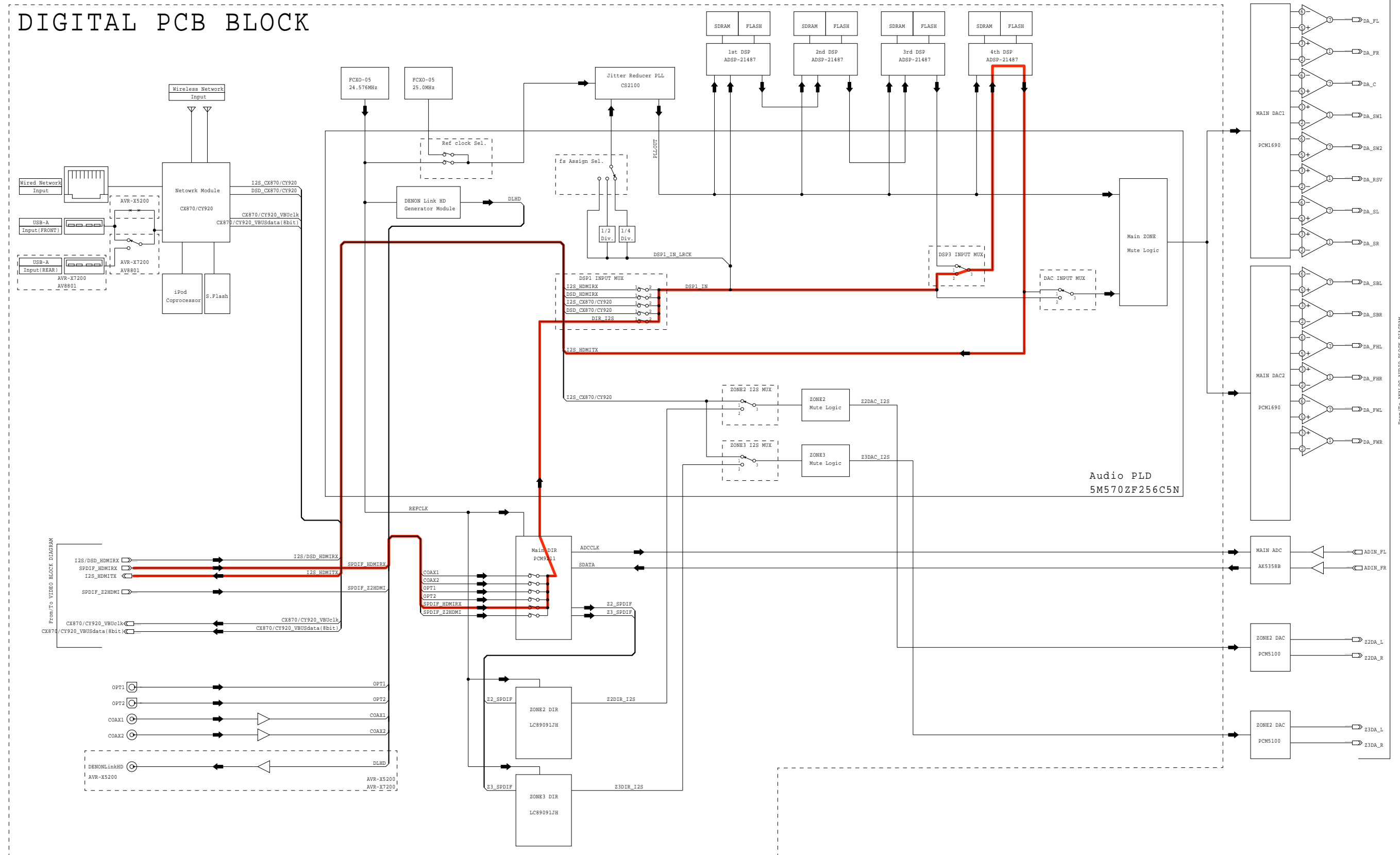

fig.22 AVR-X5200 BLOCK DIAGRAM (VIDEO) DIGITAL PCB BLOCK

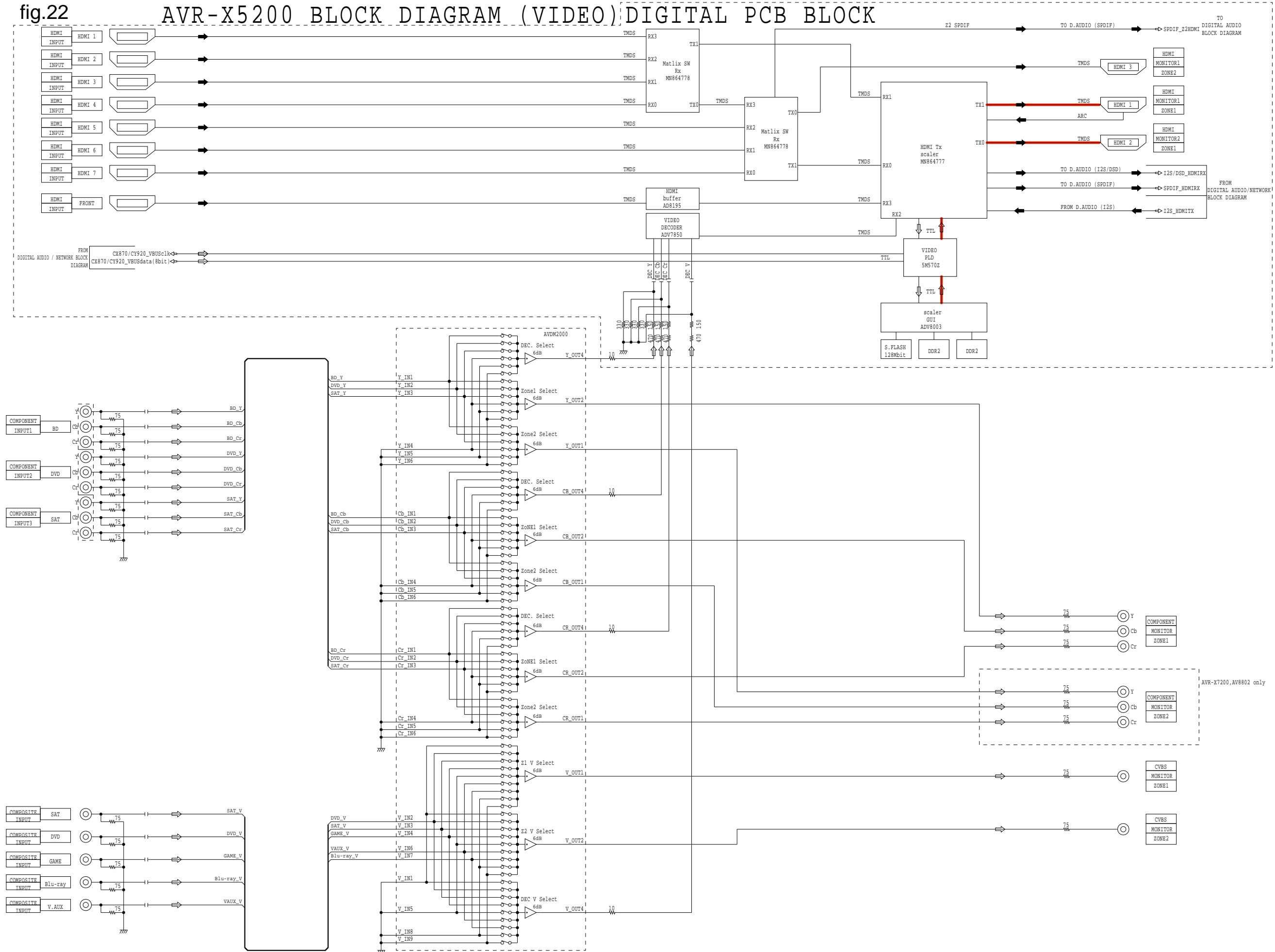
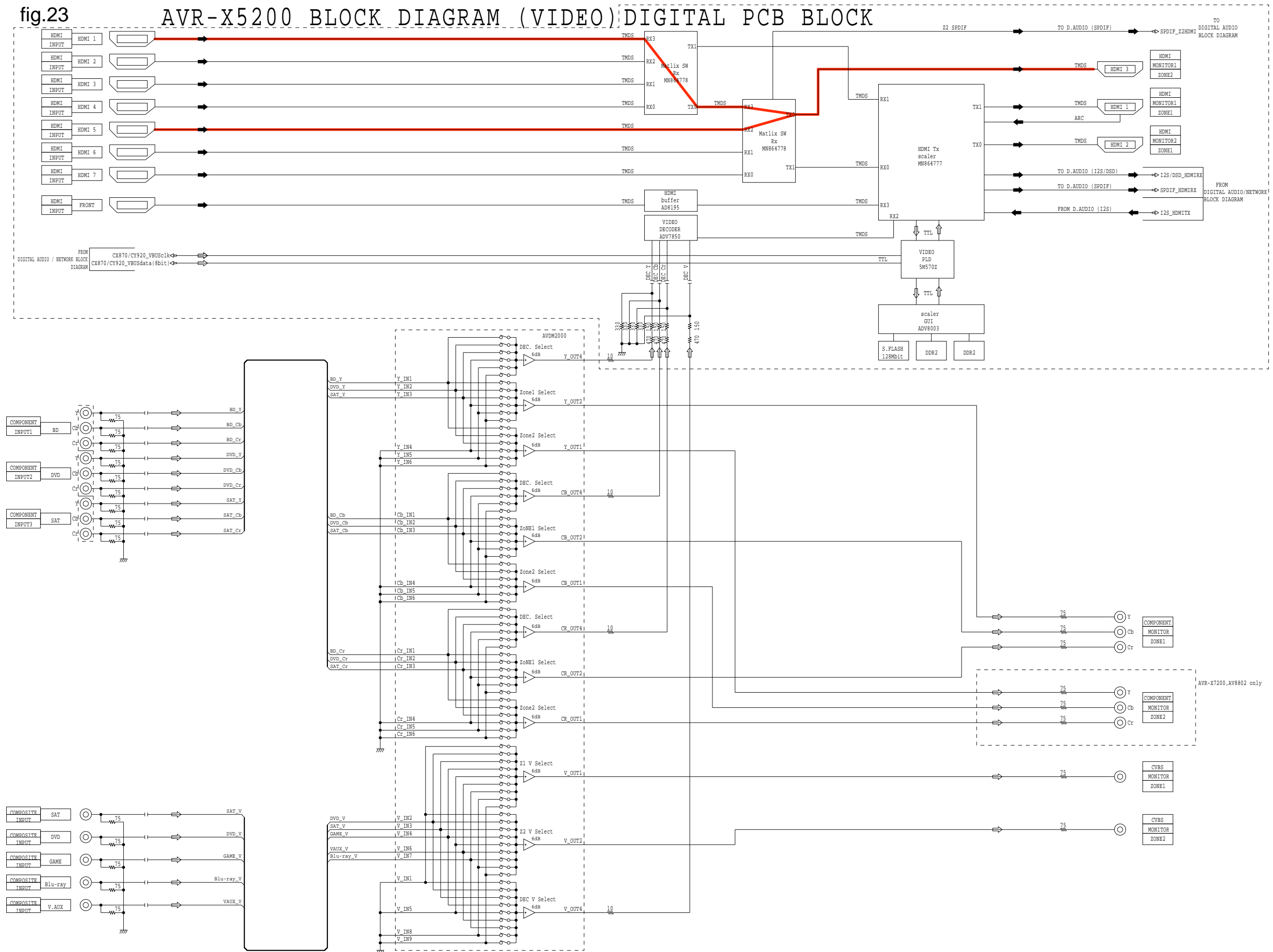

fig.23

AVR-X5200 BLOCK DIAGRAM (VIDEO) DIGITAL PCB BLOCK



### 3.6. Protection History Display Mode

#### 3.6.1. Actions

This mode records and displays an event in which the THERMAL, CURRENT, ASO or DC protection was activated. If protections have been activated multiple times, the latest protection operation is recorded.

#### 3.6.2. Starting up

Hold down buttons "STATUS" and "ZONE3 SOURCE" at the same time and press the power button to turn on the power. Select the "2. PROTECTION" using the button "CURSOR ▼", and press the button "ENTER" to commit the selection.

#### 3.6.3. Protection information and displays

- Press the "STATUS" button in Protection History Display Mode.
- The protection history can be checked.

(a) If no protections have occurred.

FLD	L1	P	R	O	T	E	C	T	H	I	S	T	O	R	Y
	L2	:	N	O		P	R	O	T	E	C	T			

(b) ASO (if the last protection was ASO)

FLD	L2	:	A	S	O										
-----	----	---	---	---	---	--	--	--	--	--	--	--	--	--	--

**Cause:** The line between speaker terminals is shorted, or speakers with impedance of less than the rated value. If the power is turned on during this abnormality, protection is activated after around 6 seconds and the power is turned off.

(c) DC (if the last protection was DC)

FLD	L2	:	D	C											
-----	----	---	---	---	--	--	--	--	--	--	--	--	--	--	--

**Cause:** DC output of the power amplifier is abnormal. If the power is turned on during this abnormality, protection is activated after around 6 seconds and the power is turned off.

(d) THERMAL (if the last protection was THERMAL(E) or THERMAL(F))

FLD	L2	:	T	H	E	R	M	A	L	E					
-----	----	---	---	---	---	---	---	---	---	---	--	--	--	--	--

FLD	L2	:	T	H	E	R	M	A	L	F					
-----	----	---	---	---	---	---	---	---	---	---	--	--	--	--	--

**Cause:** Abnormal heat sink temperature. If the power is turned on during this abnormality, protection is activated after around 6 seconds and the power is turned off.

(e) Case of CURRENT (when the last protection incident was CURRENT protection)

FLD	L2	:	C	U	R	R	E	N	T						
-----	----	---	---	---	---	---	---	---	---	--	--	--	--	--	--

**Caution :** These protections may also be activated due to causes such as disconnection of connectors or operations around the microcomputer. If the power is turned on during this abnormality, protection is activated after around 2 minutes and the power is turned off. After viewing the above protection history, press the button "STATUS" to return to the normal display.

### 3.6.4. Clearing the Protection History

There are two ways to clear the protection history.

- (a) Start Protection History Display Mode. Press the button "**STATUS**" to display the protection history. Press and hold the button "**ENTER**" for 3 seconds.

FLD	L1	P	R	O	T	E	C	T	H	I	S	T	O	R	Y
	L2	:	D	C											

↓ Press and hold the button "**ENTER**" for 3 seconds.

FLD	L2					C	L	E	A	R				
-----	----	--	--	--	--	---	---	---	---	---	--	--	--	--

↓ The above is displayed and the protection history is cleared.

FLD	L2	:	N	O	P	R	O	T	E	C	T			
-----	----	---	---	---	---	---	---	---	---	---	---	--	--	--

- (b) Initialize this unit. ( "See "**Initializing This Unit**"[10 page](#) )

※ Use the method in **3.6.3.(1)** if you do not want to erase your settings from this unit.

### Warning Displays by POWER LED

If the power is turned off while a protection is detected, the POWER LED (red) flashes in the following ways as a warning according to the protection status.

- (a) ASO/DC protection: Flashes in 0.5-second cycles (0.25 seconds lit, 0.25 seconds unlit)
- (b) THERMAL (E/F) protection: Flashes in 2-second cycles (1 seconds lit, 1 seconds unlit)
- (c) CURRENT protection: Flashes in 4-second cycles(2 seconds lit, 2 seconds unlit)

## 3.7. 232C Standby Clear Mode

### 3.7.1. Actions

Switches from 232C standby mode to normal standby mode.

### 3.7.2. Starting up

Hold down buttons "**STATUS**" and "**ZONE3 SOURCE**" at the same time and press the power button to turn on the power. Select the "**3. RS232C RESET**" using the button "**CURSOR ▼**", and press the button "**ENTER**" to commit the selection.

FLD	L1		2	.	P	R	O	T	E	C	T	I	O	N
	L2	▶	3	.	R	S	2	3	2	C	R	E	S	E

### 3.8. Operation Info Mode

#### 3.8.1. Actions

This mode displays the accumulated operating time, power on count and each protection count.

#### 3.8.2. Starting up

Hold down buttons "STATUS" and "ZONE3 SOURCE" at the same time and press the power button to turn on the power. Select the "4. OP INFO" using the button "CURSOR ▼", and press the button "ENTER" to commit the selection.

#### 3.8.3. Operations

Press the "STATUS" button after starting this device in Operation Info mode. The following information is displayed in the following order.

(a) Accumulated operating time

FLD	L1	O	P	e	r	a	t	i	o	n	T	i	m	e
	L2	T	o	t	a	l	:							H

↑Time display

↓"STATUS"

(b) Power on count

FLD	L1	P	o	w	e	r	O	n	T	i	m	e
	L2	T	o	t	a	l	:					

↑Count display

↓"STATUS"

(c) DC / ASO Protection count

FLD	L1	P	r	o	t	e	c	t	i	o	n	T	i	m	e
	L2	D	C	:			/	A	S	O	:				

↓"STATUS"

(d) Thermal Protection count

FLD	L1	P	r	o	t	e	c	t	i	o	n	T	i	m	e
	L2	T	H	M	E	:			/	F	:				

↓"STATUS"

(e) CURRENT Protection count

FLD	L1	P	r	o	t	e	c	t	i	o	n	T	i	m	e
	L2	C	u	r	r	e	n	t	:						

↓"STATUS"

(Returns to normal display)

### 3.9. TUNER STEP mode (E2/E3 only)

#### 3.9.1. Actions

This is a special mode for enabling reception STEP of the ANALOG TUNER to be changed.

#### 3.9.2. Starting up

Hold down buttons "STATUS" and "ZONE3 SOURCE" at the same time and press the power button to turn on the power. Select the "5. TUNER FRQ SET" using the button "CURSOR ▼", and press the button "ENTER" to commit the selection.

#### 3.9.3. Displays

Start this unit in TUNER STEP mode, select using button "CURSOR ◀/▶" and enter using button "ENTER". The following information is displayed in the following order.

(1) AM9kHz/FM50kHz selected

FLD	L1	*	T	U	N	E	R		F	R	Q	S	e	t		
	L2		<			A	M	9	/	F	M	5	0			>

"CURSOR ◀"

"CURSOR ▶"

(2) AM10kHz/FM200kHz selected

FLD	L2		<			A	M	1	0	/	F	M	2	0	0	>
-----	----	--	---	--	--	---	---	---	---	---	---	---	---	---	---	---

"ENTER"

- (3) Press the power button to turn off the power.
- (4) Press the power button to turn on the power.



## 4. Remote ID Setup Mode

### 4.1. Actions

This function allows only the desired AV receiver to be operated if multiple DENON AV receivers are used in the same room.

### 4.2. Starting up

Hold down buttons "**STATUS**" and "**ZONE3 SOURCE**" at the same time and press the power button to turn on the power. Select the "**6. REMOTE ID**" using the button "**CURSOR ▼**", and press the button "**ENTER**" to commit the selection.

### 4.3. Operations

(1) When Remote ID Setup mode is started, the following is displayed.

FLD	L1																
	L2				R	E	M	O	T	E		I	D		?		

(2) Press the "**QUICK SELECT 1 - 4**" button that corresponds to the number you want to set.

Button	Display																
QUICK SELECT 1	L2				R	E	M	O	T	E		I	D		1		
QUICK SELECT 2	L2				R	E	M	O	T	E		I	D		2		
QUICK SELECT 3	L2				R	E	M	O	T	E		I	D		3		
QUICK SELECT 4	L2				R	E	M	O	T	E		I	D		4		

(3) Press the power button to turn off the power.

(4) Press the power button to turn on the power.

※ Only "**QUICK SELECT 1 - 4**" and the POWER button on the unit can be used in Remote ID Setup Mode.

### 4.4. Setting the Remote control unit

(1) Press and hold "**DEVICE MENU**" button for at least 3 seconds "**DEV.**", "**TU**" and "**AVR**" indicators flash time.

(2) Press the "**MAIN**" button.  
The "**DEV.**", "**TU**" and "**AVR**" indicators flash twice.

(3) Press the "**1**", "**2**", "**3**" or "**4**" button.  
The "**DEV.**", "**TU**" and "**AVR**" indicators flash twice.

#### NOTE:

If the ID of the unit and remote control do not match, "**AVAMP\***" appears on the display of the unit when the remote control is used (\*: own remote control ID).

## 5. Protection Pass Mode

### 5.1. Actions

- This mode allows the power to be turned on without activating protections.
- This is the same as normal power-on, except that protections are not activated.

### 5.2. Operations

Hold down buttons "CURSOR ◀", "STATUS" and "ZONE3 SOURCE" at the same time and press the power button to turn on the power.

The device returns to the normal display after the following is displayed.

FLD	L1	P	r	o	t	e	c	t	i	o	n	P	a	s	s
-----	----	---	---	---	---	---	---	---	---	---	---	---	---	---	---

This is displayed for 5 seconds before returning to the normal display.

## 6. CX870 / CY920 Reboot Mode

### 6.1. Actions

- The CX870 / CY920 is restarted after CX870 / CY920 hangup.
- The CX870 / CY920 can be restarted even in the network standby setting.  
("Setup menu" – "Network" – "IP Control" – "Always On")

### 6.2. Operations

- (1) Select "Online Music" as the input source.
- (2) Hold down buttons "DIMMER" and "SETUP" for at least 3 seconds while the power is on.  
FL display during CX870 / CY920 reboot

FLD	L1	N	e	t	w	o	r	k	R	e	s	t	a	r	t
-----	----	---	---	---	---	---	---	---	---	---	---	---	---	---	---

- (3) Returns to the normal display.

#### NOTE:

- The CX870 / CY920 Reboot operation is not accepted again for one minute after executing the reboot.
- Reception is prohibited during update, save and load.

## 7. CX870 / CY920 Initialization Mode

### 7.1. Actions

The following items are initialized.

- (1) Favorites
- (2) Quick Select
- (3) Presets
- (4) Internet Radio Recently Played
- (5) Flickr contacts
- (6) User ID
- (7) Resume Playback station

### 7.2. Operations

- (1) Select "**Online Music**"
- (2) Hold down buttons "**DIMMER**" and "**CURSOR ►**" for at least 3 seconds while the power is on.

Initializing Display

FLD	L1	I	n	i	t	i	a	l	i	z	i	n	g				
-----	----	---	---	---	---	---	---	---	---	---	---	---	---	--	--	--	--

FLD	L1	I	n	i	t	i	a	l	i	z	i	n	g	.			
-----	----	---	---	---	---	---	---	---	---	---	---	---	---	---	--	--	--

FLD	L1	I	n	i	t	i	a	l	i	z	i	n	g	.	.		
-----	----	---	---	---	---	---	---	---	---	---	---	---	---	---	---	--	--

FLD	L1	I	n	i	t	i	a	l	i	z	i	n	g	.	.	.	
-----	----	---	---	---	---	---	---	---	---	---	---	---	---	---	---	---	--

Complete Display

FLD	L1				C	o	m	p	l	e	t	e	d				
-----	----	--	--	--	---	---	---	---	---	---	---	---	---	--	--	--	--

This is displayed for 5 seconds before returning to the normal display.

Failed Display

FLD	L1					F	a	i	l	e	d						
-----	----	--	--	--	--	---	---	---	---	---	---	--	--	--	--	--	--

# JIG FOR SERVICING

The following jigs (extension cable kit) are used when repairing the PCBs.  
 Order the jigs from your dealer if necessary.

**CAUTION : Incorrect connections may cause malfunction.**

- Connection of Jig for DIGITAL PCB**

**-Items to Be Prepared-**

- 8U- 110084S : EXTENSION UNIT KIT : 1 Set
- Insulation sheet (Not supplied) : 1 sheet
- Ground lead (Not supplied) : 1 pc

**-Procedures-**

(1) Remove the screws.



(2) Remove the connector PCB.

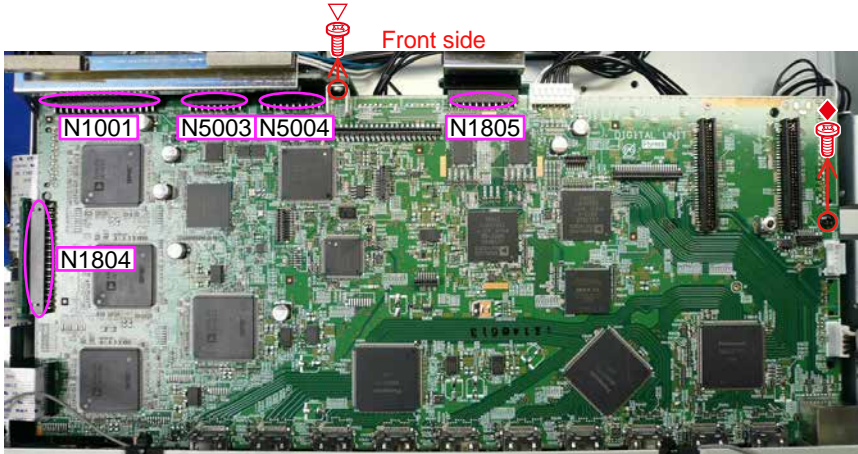

- (3) Remove the DIGITAL PCB from the chassis and turn it over.  
 Place an insulation sheet larger than the PCB underneath the DIGITAL PCB.  
 ※ Connect the earth of the PCB to the chassis using an earth wire, etc.



- (4) Connect the expansion cables.

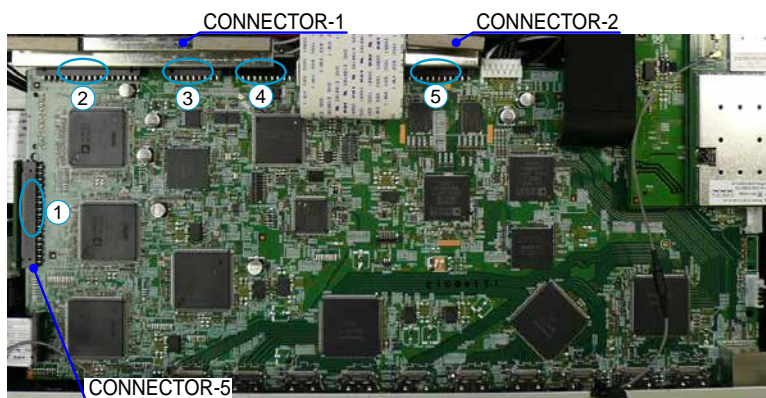

Connection table of Board to Board

No.	Pin	Ref. No.	PCB		Ref. No.	PCB
①	33pin	N5202	CONNECTOR-5	↔	N1804	DIGITAL
②	33pin	N5901	CONNECTOR-1	↔	N1001	DIGITAL
③	17pin	N5905	CONNECTOR-1	↔	N5003	DIGITAL
④	19pin	N5907	CONNECTOR-1	↔	N5004	DIGITAL
⑤	21pin	N5909	CONNECTOR-2	↔	N1805	DIGITAL

# PROCEDURE AFTER REPLACING THE MICROPROCESSOR, ETC.

The procedure after replacing the u-COM (microprocessor), flash ROM, etc. is as follows.

PCB Name	Ref. No.	Description	Procedure after Replacement	Remark
DIGITAL	U5001	R5F56108VNFP	B	SOFTWARE: Main
DIGITAL	U2101	R5F5210ABDFP	B	SOFTWARE: Sub
DIGITAL	U103/U203/ U303/U403	MX25L1606EM2I-12G	B	SOFTWARE: DSP1 / 2 / 3 / 4 ROM
DIGITAL	U2801	MX25L12835FMI-10G	B	SOFTWARE: GUI ROM
DIGITAL	U1201	5M570ZF256C5N	B	SOFTWARE: AUDIO PLD
DIGITAL	U3200	EPM570F256C4N	B	SOFTWARE: VIDEO PLD

Procedure after Replacement

**A:** The software has been written. The software is not written at the time of replacement.

**B:** The software has been written. The software may need to be rewritten by version updates. Check the version.

**C:** The software has not been written. The software needs to be written after replacement.

See "**Firmware Update Procedure**" for information on writing the software.

**D:** The software has been written. Be sure to rewrite with the latest software for your service region.

See "**Firmware Update Procedure**" for information on writing the software.



## FIRMWARE UPDATE PROCEDURE

### 1. Updating by USB

The latest firmware can be downloaded to a USB memory for updates.

#### 1.1. Connecting to the USB Memory

(1) Preparation

- Use a memory that supports USB2.0. 
- Do not run the USB memory through a hub.
- Do not connect a computer to the USB port of this unit using a USB cable.
- Do not use an extension cable when connecting the USB unit.
- If a USB memory device cannot be updated, replace it with a different USB memory device and perform the update again. 

#### 1.2. Unzip Download File

Unzip the downloaded file on your computer.

AVR-XXXXXXX	USB_AVR-XXXXXXXX_XXXXXXXXXXXX-XXXX.zip
-------------	--

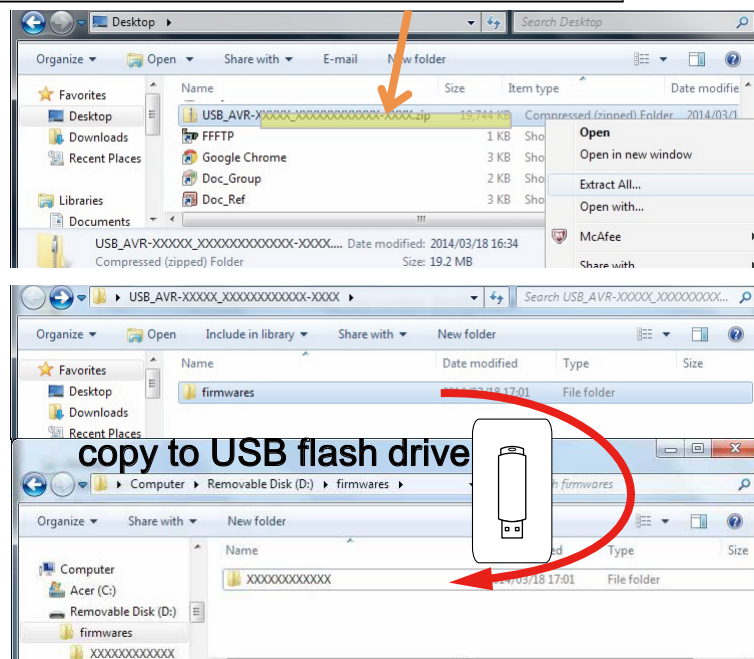

You can find "**firmwares**" folder after unzipped.

Copy that folder to USB flash drive.

You have to put "**firmwares**" folder on root directly on USB flash drive(memory).





### 1.5. Start the update.

Hold down buttons "STATUS" and "OPTION" at the same time and press the power button to turn on the power.

### 1.6. Display during USB update

The following message appears on the display after around 30 seconds

Display

FLD	L1	* F I R M W A R E U P D A T E
	L2	U S B U p d a t e S t a r t

### 1.7. Press the "ENTER" key on the remote control unit or this unit.

Then start Firmware Update.

Display

FLD	L1	P l e a s e w a i t . . .
	L2	U p d a t e F i l e C h e c k

### 1.8. The firmware update finishes.

The following message appears on the display:

Display

FLD	L1	F i r m U p d a t e
	L2	U p d a t e C o m p l e t e

#### --- Precautions for Updates ---

- Never remove the USB memory before the update is finished.
- Never turn off the power before an update is completed.
- It takes around 1 hour to complete the update.

Once an update is started, normal operations cannot be performed until it is completed.

The GUI menu settings and image adjustment settings of this unit may be initialized.

Take note of your settings beforehand and reconfigure them after the update.

### 1.9 Forced USB All Device Write Mode

#### 1.9.1. Actions

Mode used when this unit cannot be recovered.

Forcibly switches this unit to USB update mode.

#### 1.9.2. Operations

Press the "STATUS" and "OPTION" buttons simultaneously while inserting the AC plug to turn the power on.

#### 1.9.2. The firmware update finishes.

The update after the restart, all devices will be updated.

## 1.10.About the error code

See the table below for error codes and details of faults when the firmware is updated through USB memory.

Error Code	USB Update Error Display	Details of Error code	Coping strategies
01	Connection fail 1	Unable to detect USB.	Disconnect and connect the USB memory.
02	FilesNot Found	No Firmware File in USB.	Make sure that the Firmware File is in the USB memory.
03	NotMatchFirm	Firmware File in USB for unsupported Model name/area.	Check the supported Model name/area for the Firmware File.
04	Connection fail 4	Failed to obtain entire Firmware information.	Start the USB Update again.
05	Connection fail 5	Time Out while obtaining entire Firmware information.	Start the USB Update again.
08	Connection fail 8	Error notification received while requesting Firmware Info.	This unit automatically retries several times. Wait until the FL display stops. If the FL display stops at the Error display, press and hold the "Power operation" button for five seconds.
09	Connection fail 9	Time Out while obtaining Firmware information.	This unit automatically retries several times. Wait until the FL display stops. If the FL display stops at the Error display, press and hold the "Power operation" button for five seconds.
0A	Connection fail A	Unable to detect USB for Firmware Download.	Disconnect and connect the USB memory.
0B	FilesNot Found	No Firmware File for Firmware Download.	Disconnect and connect the USB memory.
0D	Connection fail D	Received value with invalid Package Version.	This unit automatically retries several times. Wait until the FL display stops. If the FL display stops at the Error display, press and hold the "Power operation" button for five seconds.
10	Main Update fail 10	No Update Packet received from CX870 / CY920 (Time Out).	This unit automatically retries several times. Wait until the FL display stops. If the FL display stops at the Error display, press and hold the "Power operation" button for five seconds.
11	Main Update fail 11	Abnormal data in Update Packet received from CX870 / CY920 (CRCError).	This unit automatically retries several times. Wait until the FL display stops. If the FL display stops at the Error display, press and hold the "Power operation" button for five seconds.
12	Main Update fail 12	Abnormal data in Update Packet received from CX870 / CY920 (PacketNoError).	This unit automatically retries several times. Wait until the FL display stops. If the FL display stops at the Error display, press and hold the "Power operation" button for five seconds.
13	Main Erase fail 13	Block Erase failed before rewriting Main.	This unit automatically retries several times. Wait until the FL display stops. If the FL display stops at the Error display, press and hold the "Power operation" button for five seconds.

Error Code	USB Update Error Display	Details of Error code	Coping strategies
14	<pre> Main Update *****           </pre>	Block Write failed while rewriting Main.	This unit automatically retries several times. Wait until the FL display stops. If the FL display stops at the Error display, press and hold the "Power operation" button for five seconds.
15	<pre> Main Update *****           </pre>	Error in Verify after rewriting Main (Check Sum Error).	This unit automatically retries several times. Wait until the FL display stops. If the FL display stops at the Error display, press and hold the "Power operation" button for five seconds.
16	<pre> Main Update *****           </pre>	Setup failure of the transfer method of XModem.	This unit automatically retries several times. Wait until the FL display stops. If the FL display stops at the Error display, press and hold the "Power operation" button for five seconds.
20	<pre> Connection fail           </pre>	Unable to detect USB after SBL Mode.	Disconnect and connect the USB memory.
21	<pre> Firmware Not Found           </pre>	No Firmware File in USB after SBL Mode.	Disconnect and connect the USB memory.
22	<pre> Not Match Firm           </pre>	Firmware File in USB after SBL Mode for unsupported Model name/area.	Check the supported Model name/area for the Firmware File.
23	<pre> Connection fail           </pre>	Failed to obtain entire Firmware information after SBL Mode.	Disconnect and connect the USB memory.
24	<pre> Connection fail           </pre>	Time Out while obtaining entire Firmware information after SBL Mode.	This unit automatically retries several times. Wait until the FL display stops. If the FL display stops at the Error display, press and hold the "Power operation" button for five seconds.
25	<pre> Connection fail           </pre>	Failed to transit to SBL Mode.	This unit automatically retries several times. Wait until the FL display stops. If the FL display stops at the Error display, press and hold the "Power operation" button for five seconds.
26	<pre> Download fail           </pre>	Time Out in Download (writing to SDRAM) for Firmware Download.	This unit automatically retries several times. Wait until the FL display stops. If the FL display stops at the Error display, press and hold the "Power operation" button for five seconds.
27	<pre> Connection fail           </pre>	Failed to write to EEPROM after SBL Mode.	This unit automatically retries several times. Wait until the FL display stops. If the FL display stops at the Error display, press and hold the "Power operation" button for five seconds.
36	<pre> Main Connection Fail           </pre>	Unable to detect USB.	This unit automatically retries several times. Wait until the FL display stops. If the FL display stops at the Error display, press and hold the "Power operation" button for five seconds.
37	<pre> Main Firmware Not Found           </pre>	No Firmware File in USB.	This unit automatically retries several times. Wait until the FL display stops. If the FL display stops at the Error display, press and hold the "Power operation" button for five seconds.
38	<pre> Main Not Match Firm           </pre>	Firmware File in USB for unsupported Model name/area.	This unit automatically retries several times. Wait until the FL display stops. If the FL display stops at the Error display, press and hold the "Power operation" button for five seconds.

Error Code	USB Update Error Display	Details of Error code	Coping strategies
39	Main Connection Fail 39	Time Out in USB Check.	This unit automatically retries several times. Wait until the FL display stops. If the FL display stops at the Error display, press and hold the "Power operation" button for five seconds.
3A	Main Connection Fail 3A	Unable to detect USB for Firmware Download.	This unit automatically retries several times. Wait until the FL display stops. If the FL display stops at the Error display, press and hold the "Power operation" button for five seconds.
3B	Main Files Not Found 3B	No Firmware File for Firmware Download.	This unit automatically retries several times. Wait until the FL display stops. If the FL display stops at the Error display, press and hold the "Power operation" button for five seconds.
3C	Main Updating fail 3C	Error notification received while requesting Firmware Info.	This unit automatically retries several times. Wait until the FL display stops. If the FL display stops at the Error display, press and hold the "Power operation" button for five seconds.
3D	Main Updating fail 3D	Time Out while obtaining Firmware information.	This unit automatically retries several times. Wait until the FL display stops. If the FL display stops at the Error display, press and hold the "Power operation" button for five seconds.
3F	Main Connection Fail 3F	Failed to transit to SBL Mode.	This unit automatically retries several times. Wait until the FL display stops. If the FL display stops at the Error display, press and hold the "Power operation" button for five seconds.
50	Sub Connection Fail 50	Unable to detect USB.	This unit automatically retries several times. Wait until the FL display stops. If the FL display stops at the Error display, press and hold the "Power operation" button for five seconds.
51	Sub Connection Fail 51	No Firmware File in USB.	This unit automatically retries several times. Wait until the FL display stops. If the FL display stops at the Error display, press and hold the "Power operation" button for five seconds.
52	Sub Not Match Firm 52	Firmware File in USB for unsupported Model name/area.	This unit automatically retries several times. Wait until the FL display stops. If the FL display stops at the Error display, press and hold the "Power operation" button for five seconds.
54	Sub Updating fail 54	Error notification received while requesting Firmware Info.	This unit automatically retries several times. Wait until the FL display stops. If the FL display stops at the Error display, press and hold the "Power operation" button for five seconds.
55	Sub Updating fail 55	Time Out while obtaining Firmware information.	This unit automatically retries several times. Wait until the FL display stops. If the FL display stops at the Error display, press and hold the "Power operation" button for five seconds.
56	Sub Connection Fail 56	Unable to detect USB for Firmware Download.	This unit automatically retries several times. Wait until the FL display stops. If the FL display stops at the Error display, press and hold the "Power operation" button for five seconds.
57	Sub Files Not Found 57	No Firmware File for Firmware Download.	This unit automatically retries several times. Wait until the FL display stops. If the FL display stops at the Error display, press and hold the "Power operation" button for five seconds.
5A	Sub Connection Fail 5A	Invalid DeviceID in response or no response from Sub for C command.	This unit automatically retries several times. Wait until the FL display stops. If the FL display stops at the Error display, press and hold the "Power operation" button for five seconds.

Error Code	USB Update Error Display	Details of Error code	Coping strategies
5B		NACK received in response or no response from Sub for L command.	This unit automatically retries several times. Wait until the FL display stops. If the FL display stops at the Error display, press and hold the "Power operation" button for five seconds.
5C		No Update Packet received from CX870 / CY920 (Time Out).	This unit automatically retries several times. Wait until the FL display stops. If the FL display stops at the Error display, press and hold the "Power operation" button for five seconds.
5D		Abnormal data in Update Packet received from CX870 / CY920 (CRCError).	This unit automatically retries several times. Wait until the FL display stops. If the FL display stops at the Error display, press and hold the "Power operation" button for five seconds.
5E		Abnormal data in Update Packet received from CX870 / CY920 (PacketNoError).	This unit automatically retries several times. Wait until the FL display stops. If the FL display stops at the Error display, press and hold the "Power operation" button for five seconds.
5F		Setup failure of the transfer method of XModem.	This unit automatically retries several times. Wait until the FL display stops. If the FL display stops at the Error display, press and hold the "Power operation" button for five seconds.
60		NACK received in response or no response from Sub for P command.	This unit automatically retries several times. Wait until the FL display stops. If the FL display stops at the Error display, press and hold the "Power operation" button for five seconds.
61		Mismatched Check Sum in response or no response from Sub for I command.	This unit automatically retries several times. Wait until the FL display stops. If the FL display stops at the Error display, press and hold the "Power operation" button for five seconds.
62		Failed to start up Sub in Power On sequence during Update.	This unit automatically retries several times. Wait until the FL display stops. If the FL display stops at the Error display, press and hold the "Power operation" button for five seconds.
63		Failed to transit to Application Mode.	This unit automatically retries several times. Wait until the FL display stops. If the FL display stops at the Error display, press and hold the "Power operation" button for five seconds.
64		Failed to transit to Boot Loader Mode.	This unit automatically retries several times. Wait until the FL display stops. If the FL display stops at the Error display, press and hold the "Power operation" button for five seconds.
80		Write Enable Latch Bit not set in Read after issuing WREN command.	This unit automatically retries several times. Wait until the FL display stops. If the FL display stops at the Error display, press and hold the "Power operation" button for five seconds.
81		Block Erase failed in Read after issuing BE command.	This unit automatically retries several times. Wait until the FL display stops. If the FL display stops at the Error display, press and hold the "Power operation" button for five seconds.
82		No Update Packet received from CX870 / CY920 (Time Out).	This unit automatically retries several times. Wait until the FL display stops. If the FL display stops at the Error display, press and hold the "Power operation" button for five seconds.
83		Abnormal data in Update Packet received from CX870 / CY920 (CRCError).	This unit automatically retries several times. Wait until the FL display stops. If the FL display stops at the Error display, press and hold the "Power operation" button for five seconds.

Error Code	USB Update Error Display	Details of Error code	Coping strategies
84	GUI Updateing ***min Updateing fail B4	Abnormal data in Update Packet received from CX870 / CY920 (PacketNoError).	This unit automatically retries several times. Wait until the FL display stops. If the FL display stops at the Error display, press and hold the "Power operation" button for five seconds.
85	GUI Updateing ***min Updateing fail B5	Abnormal data in Update Packet received from CX870 / CY920 (DataLength/DataNo).	This unit automatically retries several times. Wait until the FL display stops. If the FL display stops at the Error display, press and hold the "Power operation" button for five seconds.
86	GUI Updateing ***min Updateing fail B6	Mismatched Check Sum in Check Sum comparison after rewriting.	This unit automatically retries several times. Wait until the FL display stops. If the FL display stops at the Error display, press and hold the "Power operation" button for five seconds.
A2	EthernetIMG ***min ConnectionFailA2	Unable to detect USB.	This unit automatically retries several times. Wait until the FL display stops. If the FL display stops at the Error display, press and hold the "Power operation" button for five seconds.
A3	EthernetIMG ***min FilesNotFoundA3	No Firmware File in USB.	This unit automatically retries several times. Wait until the FL display stops. If the FL display stops at the Error display, press and hold the "Power operation" button for five seconds.
A4	EthernetIMG ***min NotMatchFirmA4	Firmware File in USB for unsupported Model name/area.	This unit automatically retries several times. Wait until the FL display stops. If the FL display stops at the Error display, press and hold the "Power operation" button for five seconds.
A6	EthernetIMG ***min Updateing fail A6	Error notification received while requesting Firmware Info.	This unit automatically retries several times. Wait until the FL display stops. If the FL display stops at the Error display, press and hold the "Power operation" button for five seconds.
A7	EthernetIMG ***min Updateing fail A7	Time Out while obtaining Firmware information.	This unit automatically retries several times. Wait until the FL display stops. If the FL display stops at the Error display, press and hold the "Power operation" button for five seconds.
AE	EthernetIMG ***min ConnectionFailAE	Unable to detect USB for Firmware Download.	This unit automatically retries several times. Wait until the FL display stops. If the FL display stops at the Error display, press and hold the "Power operation" button for five seconds.
AF	EthernetIMG ***min FilesNotFoundAF	No Firmware File for Firmware Download.	This unit automatically retries several times. Wait until the FL display stops. If the FL display stops at the Error display, press and hold the "Power operation" button for five seconds.
B1	EthernetIMG ***min ConnectionFailB1	Time Out in Download (writing to SDRAM) for Firmware Download.	This unit automatically retries several times. Wait until the FL display stops. If the FL display stops at the Error display, press and hold the "Power operation" button for five seconds.
B2	EthernetIMG ***min Updateing fail B2	Error notification received after rewriting CX870 / CY920 Firm.	This unit automatically retries several times. Wait until the FL display stops. If the FL display stops at the Error display, press and hold the "Power operation" button for five seconds.
B3	EthernetIMG ***min Updateing fail B3	Error in Firmware Update (Time Out).	This unit automatically retries several times. Wait until the FL display stops. If the FL display stops at the Error display, press and hold the "Power operation" button for five seconds.
B4	EthernetIMG ***min Updateing fail B4	Failed to transit to BootLoader Mode.	This unit automatically retries several times. Wait until the FL display stops. If the FL display stops at the Error display, press and hold the "Power operation" button for five seconds.

Error Code	USB Update Error Display	Details of Error code	Coping strategies																																
B5	<table border="1"> <tr> <td>E</td><td>t</td><td>h</td><td>e</td><td>r</td><td> </td><td>I</td><td>M</td><td>G</td><td> </td><td>*</td><td>*</td><td>*</td><td>n</td><td>i</td><td>n</td> </tr> <tr> <td>U</td><td>p</td><td>d</td><td>a</td><td>t</td><td>i</td><td>n</td><td>g</td><td> </td><td>F</td><td>a</td><td>i</td><td>l</td><td>B</td><td>S</td><td></td> </tr> </table>	E	t	h	e	r		I	M	G		*	*	*	n	i	n	U	p	d	a	t	i	n	g		F	a	i	l	B	S		Failed to transit to Application Mode.	This unit automatically retries several times. Wait until the FL display stops. If the FL display stops at the Error display, press and hold the "Power operation" button for five seconds.
E	t	h	e	r		I	M	G		*	*	*	n	i	n																				
U	p	d	a	t	i	n	g		F	a	i	l	B	S																					

---Check the firmware version after updating.---

After updating the firmware, check the version. See "1. Version Display Mode" (19 page).

### 1.11. Device display during firmware update

Display of target device during firmware update.

Target device	USB Update Display	Error code when an error occurs																																																																																
Main CPU	<table border="1"> <tr> <td>L1</td><td>M</td><td>a</td><td>i</td><td>n</td><td> </td><td> </td><td> </td><td> </td><td> </td><td>*</td><td>*</td><td>*</td><td>n</td><td>i</td><td>n</td> </tr> <tr> <td>L2</td><td>U</td><td>p</td><td>d</td><td>a</td><td>t</td><td>i</td><td>n</td><td>g</td><td> </td><td> </td><td> </td><td> </td><td>*</td><td>*</td><td>%</td> </tr> </table>	L1	M	a	i	n						*	*	*	n	i	n	L2	U	p	d	a	t	i	n	g					*	*	%	10 - 16 36 - 3D 3F																																																
L1	M	a	i	n						*	*	*	n	i	n																																																																			
L2	U	p	d	a	t	i	n	g					*	*	%																																																																			
Sub	<table border="1"> <tr> <td>L1</td><td>S</td><td>u</td><td>b</td><td> </td><td> </td><td> </td><td> </td><td> </td><td> </td><td>*</td><td>*</td><td>*</td><td>n</td><td>i</td><td>n</td> </tr> <tr> <td>L2</td><td>U</td><td>p</td><td>d</td><td>a</td><td>t</td><td>i</td><td>n</td><td>g</td><td> </td><td> </td><td> </td><td> </td><td>*</td><td>*</td><td>%</td> </tr> </table>	L1	S	u	b							*	*	*	n	i	n	L2	U	p	d	a	t	i	n	g					*	*	%	50 - 52 54 - 57 5A - 64																																																
L1	S	u	b							*	*	*	n	i	n																																																																			
L2	U	p	d	a	t	i	n	g					*	*	%																																																																			
Audio PLD	<table border="1"> <tr> <td>L1</td><td>A</td><td>P</td><td>L</td><td>D</td><td> </td><td> </td><td> </td><td> </td><td> </td><td>*</td><td>*</td><td>*</td><td>n</td><td>i</td><td>n</td> </tr> <tr> <td>L2</td><td>U</td><td>p</td><td>d</td><td>a</td><td>t</td><td>i</td><td>n</td><td>g</td><td> </td><td> </td><td> </td><td> </td><td>*</td><td>*</td><td>%</td> </tr> </table>	L1	A	P	L	D						*	*	*	n	i	n	L2	U	p	d	a	t	i	n	g					*	*	%	50 - 52 54 - 57 5A - 64																																																
L1	A	P	L	D						*	*	*	n	i	n																																																																			
L2	U	p	d	a	t	i	n	g					*	*	%																																																																			
VIDEO PLD	<table border="1"> <tr> <td>L1</td><td>V</td><td>P</td><td>L</td><td>D</td><td> </td><td> </td><td> </td><td> </td><td> </td><td>*</td><td>*</td><td>*</td><td>n</td><td>i</td><td>n</td> </tr> <tr> <td>L2</td><td>U</td><td>p</td><td>d</td><td>a</td><td>t</td><td>i</td><td>n</td><td>g</td><td> </td><td> </td><td> </td><td> </td><td>*</td><td>*</td><td>%</td> </tr> </table>	L1	V	P	L	D						*	*	*	n	i	n	L2	U	p	d	a	t	i	n	g					*	*	%	50 - 52 54 - 57 5A - 64																																																
L1	V	P	L	D						*	*	*	n	i	n																																																																			
L2	U	p	d	a	t	i	n	g					*	*	%																																																																			
DSP	<table border="1"> <tr> <td>L1</td><td>D</td><td>S</td><td>P</td><td>1</td><td> </td><td> </td><td> </td><td> </td><td> </td><td>*</td><td>*</td><td>*</td><td>n</td><td>i</td><td>n</td> </tr> <tr> <td>L2</td><td>U</td><td>p</td><td>d</td><td>a</td><td>t</td><td>i</td><td>n</td><td>g</td><td> </td><td> </td><td> </td><td> </td><td>*</td><td>*</td><td>%</td> </tr> <tr> <td>L1</td><td>D</td><td>S</td><td>P</td><td>2</td><td> </td><td> </td><td> </td><td> </td><td> </td><td>*</td><td>*</td><td>*</td><td>n</td><td>i</td><td>n</td> </tr> <tr> <td>L1</td><td>D</td><td>S</td><td>P</td><td>3</td><td> </td><td> </td><td> </td><td> </td><td> </td><td>*</td><td>*</td><td>*</td><td>n</td><td>i</td><td>n</td> </tr> <tr> <td>L1</td><td>D</td><td>S</td><td>P</td><td>4</td><td> </td><td> </td><td> </td><td> </td><td> </td><td>*</td><td>*</td><td>*</td><td>n</td><td>i</td><td>n</td> </tr> </table>	L1	D	S	P	1						*	*	*	n	i	n	L2	U	p	d	a	t	i	n	g					*	*	%	L1	D	S	P	2						*	*	*	n	i	n	L1	D	S	P	3						*	*	*	n	i	n	L1	D	S	P	4						*	*	*	n	i	n	50 - 52 54 - 57 5A - 64
L1	D	S	P	1						*	*	*	n	i	n																																																																			
L2	U	p	d	a	t	i	n	g					*	*	%																																																																			
L1	D	S	P	2						*	*	*	n	i	n																																																																			
L1	D	S	P	3						*	*	*	n	i	n																																																																			
L1	D	S	P	4						*	*	*	n	i	n																																																																			
GUI Serial Flash	<table border="1"> <tr> <td>L1</td><td>G</td><td>U</td><td>I</td><td> </td><td> </td><td> </td><td> </td><td> </td><td> </td><td>*</td><td>*</td><td>*</td><td>n</td><td>i</td><td>n</td> </tr> <tr> <td>L2</td><td>U</td><td>p</td><td>d</td><td>a</td><td>t</td><td>i</td><td>n</td><td>g</td><td> </td><td> </td><td> </td><td> </td><td>*</td><td>*</td><td>%</td> </tr> </table>	L1	G	U	I							*	*	*	n	i	n	L2	U	p	d	a	t	i	n	g					*	*	%	50 - 52 54 - 57 5A 62 - 64 80 - 86																																																
L1	G	U	I							*	*	*	n	i	n																																																																			
L2	U	p	d	a	t	i	n	g					*	*	%																																																																			
CX870 / CY920 second Boot Loader	<table border="1"> <tr> <td>L1</td><td>E</td><td>t</td><td>h</td><td>e</td><td>r</td><td> </td><td>S</td><td>B</td><td>L</td><td> </td><td> </td><td> </td><td>*</td><td>*</td><td>*</td><td>n</td><td>i</td><td>n</td> </tr> <tr> <td>L2</td><td>U</td><td>p</td><td>d</td><td>a</td><td>t</td><td>i</td><td>n</td><td>g</td><td> </td><td> </td><td> </td><td> </td><td>*</td><td>*</td><td>%</td><td></td><td></td><td></td> </tr> </table>	L1	E	t	h	e	r		S	B	L				*	*	*	n	i	n	L2	U	p	d	a	t	i	n	g					*	*	%				A2 - A4 A6 - A7 AE - AF B1 - B5																																										
L1	E	t	h	e	r		S	B	L				*	*	*	n	i	n																																																																
L2	U	p	d	a	t	i	n	g					*	*	%																																																																			
CX870 / CY920 Image	<table border="1"> <tr> <td>L1</td><td>E</td><td>t</td><td>h</td><td>e</td><td>r</td><td> </td><td>I</td><td>M</td><td>G</td><td> </td><td> </td><td> </td><td>*</td><td>*</td><td>*</td><td>n</td><td>i</td><td>n</td> </tr> <tr> <td>L2</td><td>U</td><td>p</td><td>d</td><td>a</td><td>t</td><td>i</td><td>n</td><td>g</td><td> </td><td> </td><td> </td><td> </td><td>*</td><td>*</td><td>%</td><td></td><td></td><td></td> </tr> </table>	L1	E	t	h	e	r		I	M	G				*	*	*	n	i	n	L2	U	p	d	a	t	i	n	g					*	*	%				A2 - A4 A6 - A7 AE - AF B1 - B5																																										
L1	E	t	h	e	r		I	M	G				*	*	*	n	i	n																																																																
L2	U	p	d	a	t	i	n	g					*	*	%																																																																			
CX870 / CY920 Image (Emergency Mode)	<table border="1"> <tr> <td>L1</td><td>P</td><td>l</td><td>e</td><td>a</td><td>s</td><td>e</td><td> </td><td>w</td><td>a</td><td>i</td><td>t</td><td> </td><td> </td><td> </td><td> </td><td> </td><td> </td><td> </td> </tr> <tr> <td>L2</td><td>U</td><td>p</td><td>d</td><td>a</td><td>t</td><td>e</td><td> </td><td>r</td><td>e</td><td>t</td><td>r</td><td>y</td><td> </td><td> </td><td> </td><td> </td><td> </td><td> </td> </tr> </table>	L1	P	l	e	a	s	e		w	a	i	t								L2	U	p	d	a	t	e		r	e	t	r	y							-																																										
L1	P	l	e	a	s	e		w	a	i	t																																																																							
L2	U	p	d	a	t	e		r	e	t	r	y																																																																						

### Checking the Firmware Version After an Update

After updating the firmware, check the version. See "1. Version Display Mode" (19 page).



## 2. Updating by DPMS

Download the latest firmware from the internet and update the firmware.

### 2.1. Network Connection

#### (1) System Requirements

- A broadband internet connection
- Modem
- Router
- Ethernet cable (CAT-5 or greater recommended)

#### (2) Settings

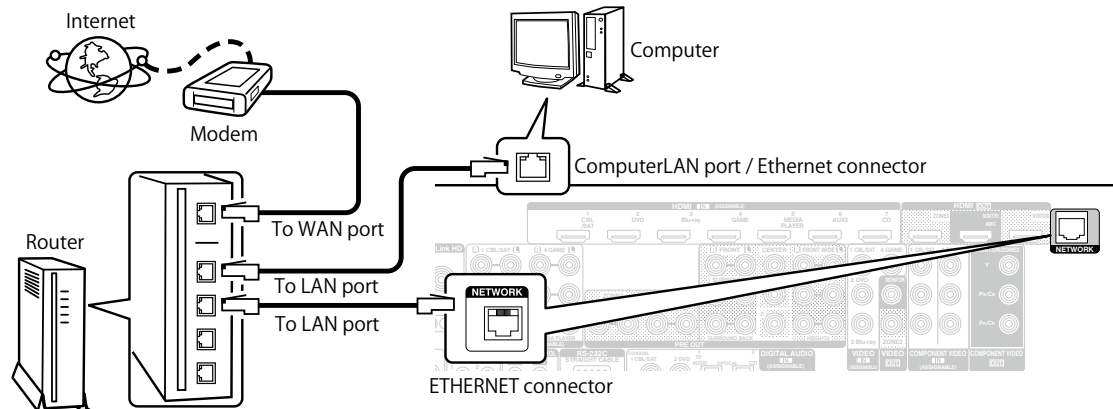

### 2.2. Check and update the firmware

Check whether new firmware is available. It is also possible to check approximately how long the update will take.

- (1) Press the button **"SETUP"** on the remote control to display the GUI menu.
- (2) Press the cursor button to select **"General"** → **"Firmware"** → **"Update"** → **"Check for Update"**.
- (3) Press the button **"ENTER"**.
  - The latest firmware version uploaded to our website is displayed.
  - Proceed to (4) if new firmware is available on our website.
  - If the latest firmware is already installed, press the button **"SETUP"** to exit the menu.
- (4) Select **"Start"** using the cursor buttons and then press **"ENTER"**.
  - The power display lights in red and the GUI screen display disappears during the update. The remaining time of the update is shown on the display of the unit.
  - The normal status resumes after the update is completed.

#### --- Precautions for Updates ---

- The environment and settings must allow connection to broadband Internet for updates.
- Never turn off the power before an update is completed.
- It takes around 1 hour to complete the update.

Once an update is started, normal operations cannot be performed until it is completed.

The GUI menu settings and image adjustment settings of this unit may be initialized.

Take note of your settings beforehand and reconfigure them after the update.

### 2.3. About the error code

See the following table for details on the error code, details of the error code, display and coping strategies when updating the firmware from DPMS. (DPMS:Denon Product Management Server).

Error Code	DPMS Update Error Display	Details of Error code	Coping strategies
01	Log in failed	Failed to log in to DPMS.	Initialize the unit and try updating again. Update in an environment where there is a small network load.
02	Server is busy	Line etc. is congested when logging in to DPMS.	Update in an environment where there is a small network load.
03	Connection failed	Connection to DPMS failed.	Check the network connection. Update in an environment where there is a small network load.
04	Connection failed	Failed to obtain entire Firmware information.	Check the network connection. Update in an environment where there is a small network load.
05	Connection failed	Time Out while obtaining entire Firmware information.	Check the network connection. Update in an environment where there is a small network load.
06	Connection failed	Failed to obtain individual Firmware information.	Check the network connection. Update in an environment where there is a small network load.
07	Connection failed	Time Out while obtaining individual Firmware information.	Check the network connection. Update in an environment where there is a small network load.
08	Connection failed	Error notification received while requesting Firmware Info.	Check the network connection. Update in an environment where there is a small network load.
09	Connection failed	Time Out while obtaining Firmware information.	Check the network connection. Update in an environment where there is a small network load.
0A	Download failed	Error(NG) notification received while requesting Firmware Download.	Check the network connection. Update in an environment where there is a small network load.
0B	Download failed	Error(ServerBusy) notification received while requesting Firmware Download.	Check the network connection. Update in an environment where there is a small network load.
0C	Download failed	Error(Connect failure) notification received while requesting Firmware Download.	Check the network connection. Update in an environment where there is a small network load.
0D	Connection failed	Received value with invalid Package Version.	Check the network connection. Update in an environment where there is a small network load.
0E	Connection failed	Connection to DPMS failed. (Cannot get NTP)	Check the network connection. Update in an environment where there is a small network load.
10	Main updating failed	No Update Packet received from CX870 / CY920 (Time Out).	Turn on the power again. Update will start automatically.
11	Main updating failed	Abnormal data in Update Packet received from CX870 / CY920 (CRCError).	Turn on the power again. Update will start automatically.

Error Code	DPMS Update Error Display	Details of Error code	Coping strategies
12	Main Updating fail 12	Abnormal data in Update Packet received from CX870 (PacketNo-Error).	Turn on the power again. Update will start automatically.
13	Main Erase fail 13	Block Erase failed before rewriting Main.	Turn on the power again. Update will start automatically.
14	Main Updating fail 14	Block Write failed while rewriting Main.	Turn on the power again. Update will start automatically.
15	Main UpdateCheckNG 15	Error in Verify after rewriting Main (Check SumError).	Turn on the power again. Update will start automatically.
16	Main Updating fail 16	Setup failure of the transfer method of XModem.	Check the network connection. Update in an environment where there is a small network load.
20	Connection fail 20	SBL Mode after IP Address acquisition failure (AutoIP).	Check the network connection. Update in an environment where there is a small network load.
21	Connection fail 21	SBL Mode after IP Address acquisition failure (Time Out).	Check the network connection. Update in an environment where there is a small network load.
22	Login failed 22	Login incorrect notification SBL Mode after DPMS connection.	Initialize the unit and try updating again. Update in an environment where there is a small network load.
23	Server is busy 23	Server congestion notification SBL Mode after DPMS connection.	Update in an environment where there is a small network load.
24	Connection fail 24	Connection failure notification SBL Mode after DPMS connection.	Check the network connection. Update in an environment where there is a small network load.
25	Connection fail 25	Failed to transit to SBL Mode.	Initialize the unit and try updating again.
26	Download fail 26	Error in Firmware Download (Time Out).	Check the network connection. Update in an environment where there is a small network load.
27	Connection fail 27	Failed to write to EEPROM after SBL Mode.	Initialize the unit and try updating again.
36	Main Login failed 36	Login incorrect notification DPMS connection.	Update in an environment where there is a small network load.
37	Main Server is busy 37	Server congestion notification by DPMS connection.	Update in an environment where there is a small network load.
38	Main ConnectionFail 38	Connection failure notification DPMS connection.	Check the network connection. Update in an environment where there is a small network load.

Error Code	DPMS Update Error Display	Details of Error code	Coping strategies
39	Main * * * n i n C o n n e c t i o n F a i l 3 9	Connect Time Out by DPMS connection.	Check the network connection. Update in an environment where there is a small network load.
3A	Main * * * n i n D o w n l o a d e d f a i l 3 A	Error(NG) notification received while requesting Firmware Download.	Turn on the power again. Update will start automatically. Update in an environment where there is a small network load.
3B	Main * * * n i n D o w n l o a d e d f a i l 3 B	Error(ServerBusy) notification received while requesting Firmware Download.	Turn on the power again. Update will start automatically. Update in an environment where there is a small network load.
3C	Main * * * n i n D o w n l o a d e d f a i l 3 C	Error(Connect failure) notification received while requesting Firmware Download.	Turn on the power again. Update will start automatically. Update in an environment where there is a small network load.
3D	Main * * * n i n C o n n e c t i o n F a i l 3 D	SBL Mode after IP Address acquisition failure (AutoIP).	Check the network connection. Update in an environment where there is a small network load.
3E	Main * * * n i n C o n n e c t i o n F a i l 3 E	SBL Mode after IP Address acquisition failure (Time Out).	Check the network connection. Update in an environment where there is a small network load.
3F	Main * * * n i n C o n n e c t i o n F a i l 3 F	Failed to transit to SBL Mode.	Check the network connection. Update in an environment where there is a small network load.
50	S u b * * * n i n L o g i n f a i l 5 0	Login incorrect notification DPMS connection.	Update in an environment where there is a small network load.
51	S u b * * * n i n S e r v e r i s b u s y 5 1	Server congestion notification by DPMS connection.	Update in an environment where there is a small network load.
52	S u b * * * n i n C o n n e c t i o n F a i l 5 2	Connection failure notification DPMS connection.	Check the network connection. Update in an environment where there is a small network load.
54	S u b * * * n i n U p d a t i n g f a i l 5 4	Error notification received while requesting Firmware Info.	Turn on the power again. Update will start automatically. Update in an environment where there is a small network load.
55	S u b * * * n i n U p d a t i n g f a i l 5 5	Time Out while obtaining Firmware information.	Turn on the power again. Update will start automatically. Update in an environment where there is a small network load.
56	S u b * * * n i n D o w n l o a d e d f a i l 5 6	Error(NG) notification received while requesting Firmware Download.	Turn on the power again. Update will start automatically. Update in an environment where there is a small network load.
57	S u b * * * n i n D o w n l o a d e d f a i l 5 7	Error(ServerBusy) notification received while requesting Firmware Download.	Turn on the power again. Update will start automatically. Update in an environment where there is a small network load.
58	S u b * * * n i n D o w n l o a d e d f a i l 5 8	Error(Connect failure) notification received while requesting Firmware Download.	Turn on the power again. Update will start automatically. Update in an environment where there is a small network load.
5A	S u b * * * n i n C o n n e c t i o n F a i l 5 A	Invalid DeviceID in response or no response from Sub for C command.	Turn on the power again. Update will start automatically.

Error Code	DPMS Update Error Display	Details of Error code	Coping strategies
5B	Sub Updating failed 5B	NACK received in response or no response from Sub for L command.	Turn on the power again. Update will start automatically.
5C	Sub Updating failed 5C	No Update Packet received from CX870 / CY920 (Time Out).	Turn on the power again. Update will start automatically.
5D	Sub Updating failed 5D	Abnormal data in Update Packet received from CX870 / CY920 (CRCError).	Turn on the power again. Update will start automatically.
5E	Sub Updating failed 5E	Abnormal data in Update Packet received from CX870 / CY920 (PacketNoError).	Turn on the power again. Update will start automatically.
5F	Sub Updating failed 5F	Setup failure of the transfer method of XModem.	Turn on the power again. Update will start automatically.
60	Sub Updating failed 60	NACK received in response or no response from Sub for "P" command.	Turn on the power again. Update will start automatically.
61	Sub Update CheckNG failed 61	Mismatched Check Sum in response or no response from Sub for "I" command.	Turn on the power again. Update will start automatically.
62	Sub Updating failed 62	Failed to start up Sub in Power On sequence during Update.	Turn on the power again. Update will start automatically.
80	GUI Updating failed 80	Write Enable Latch Bit not set in Read after issuing WREN command.	Turn on the power again. Update will start automatically.
81	GUI Updating failed 81	Block Erase failed in Read after issuing BE command.	Turn on the power again. Update will start automatically.
82	GUI Updating failed 82	No Update Packet received from CX870 / CY920 (Time Out).	Turn on the power again. Update will start automatically.
83	GUI Updating failed 83	Abnormal data in Update Packet received from CX870 / CY920 (CRCError).	Turn on the power again. Update will start automatically.
84	GUI Updating failed 84	Abnormal data in Update Packet received from CX870 / CY920 (PacketNoError).	Turn on the power again. Update will start automatically.
85	GUI Updating failed 85	Setup failure of the transfer method of XModem.	Turn on the power again. Update will start automatically.
86	GUI Updating failed 86	Mismatched Check Sum in Check Sum comparison after rewriting.	Turn on the power again. Update will start automatically.
A0	Ethernet Connection Failed A0	IP Address acquisition failure (AutoIP).	Check the network connection. Update in an environment where there is a small network load.

Error Code	DPMS Update Error Display	Details of Error code	Coping strategies
A1	Ether IMG ***min ConnectionFailed A1	IP Address acquisition failure (Time Out).	Check the network connection. Update in an environment where there is a small network load.
A2	Ether IMG ***min Login failed A2	Login incorrect notification DPMS connection.	Check the network connection. Update in an environment where there is a small network load.
A3	Ether IMG ***min Server is busy A3	Server congestion notification by DPMS connection.	Check the network connection. Update in an environment where there is a small network load.
A4	Ether IMG ***min ConnectionFailed A4	Connection failure notification DPMS connection.	Check the network connection. Update in an environment where there is a small network load.
A6	Ether IMG ***min Updating failed A6	Error notification received while requesting Firmware Info.	Turn on the power again. Update will start automatically. Update in an environment where there is a small network load.
A7	Ether IMG ***min Updating failed A7	Time Out while obtaining Firmware information.	Turn on the power again. Update will start automatically. Update in an environment where there is a small network load.
AE	Ether IMG ***min Download failed AE	Error(NG) notification received while requesting Firmware Download.	Turn on the power again. Update will start automatically. Update in an environment where there is a small network load.
AF	Ether IMG ***min Download failed AF	Error(ServerBusy) notification received while requesting Firmware Download.	Turn on the power again. Update will start automatically. Update in an environment where there is a small network load.
B0	Ether IMG ***min Download failed B0	Error(Connect failure) notification received while requesting Firmware Download.	Turn on the power again. Update will start automatically. Update in an environment where there is a small network load.
B1	Ether IMG ***min Download failed B1	Error in Firmware Download (Time Out).	Turn on the power again. Update will start automatically. Update in an environment where there is a small network load.
B2	Ether IMG ***min Updating failed B2	Error notification received after rewriting CX870 / CY920 Firm.	Turn on the power again. Update will start automatically. Update in an environment where there is a small network load.
B3	Ether IMG ***min Updating failed B3	Error in Firmware Update (Time Out).	Turn on the power again. Update will start automatically. Update in an environment where there is a small network load.
B4	Ether IMG ***min Updating failed B4	Failed to transit to Boot Loader Mode.	Initialize the unit and try updating again.
B5	Ether IMG ***min Updating failed B5	Failed to transit to Application Mode.	Initialize the unit and try updating again.

## Device display during firmware update

Display of target device during firmware update.

Target device	DPMS Update Display	Error code when an error occurs																																																																																
Main CPU	<table border="1"> <tr> <td>L1</td> <td>M</td><td>a</td><td>i</td><td>n</td><td></td><td></td><td></td><td></td><td></td><td>*</td><td>*</td><td>*</td><td>n</td><td>i</td><td>n</td> </tr> <tr> <td>L2</td> <td>U</td><td>p</td><td>d</td><td>a</td><td>t</td><td>i</td><td>n</td><td>g</td><td></td><td></td><td></td><td></td><td>*</td><td>*</td><td>%</td> </tr> </table>	L1	M	a	i	n						*	*	*	n	i	n	L2	U	p	d	a	t	i	n	g					*	*	%	10 - 16 36 - 3F																																																
L1	M	a	i	n						*	*	*	n	i	n																																																																			
L2	U	p	d	a	t	i	n	g					*	*	%																																																																			
Sub	<table border="1"> <tr> <td>L1</td> <td>S</td><td>u</td><td>b</td><td></td><td></td><td></td><td></td><td></td><td></td><td>*</td><td>*</td><td>*</td><td>n</td><td>i</td><td>n</td> </tr> <tr> <td>L2</td> <td>U</td><td>p</td><td>d</td><td>a</td><td>t</td><td>i</td><td>n</td><td>g</td><td></td><td></td><td></td><td></td><td>*</td><td>*</td><td>%</td> </tr> </table>	L1	S	u	b							*	*	*	n	i	n	L2	U	p	d	a	t	i	n	g					*	*	%	50 - 52 54 - 58 5A - 62																																																
L1	S	u	b							*	*	*	n	i	n																																																																			
L2	U	p	d	a	t	i	n	g					*	*	%																																																																			
Audio PLD	<table border="1"> <tr> <td>L1</td> <td>A</td><td>P</td><td>L</td><td>D</td><td></td><td></td><td></td><td></td><td></td><td>*</td><td>*</td><td>*</td><td>n</td><td>i</td><td>n</td> </tr> <tr> <td>L2</td> <td>U</td><td>p</td><td>d</td><td>a</td><td>t</td><td>i</td><td>n</td><td>g</td><td></td><td></td><td></td><td></td><td>*</td><td>*</td><td>%</td> </tr> </table>	L1	A	P	L	D						*	*	*	n	i	n	L2	U	p	d	a	t	i	n	g					*	*	%	50 - 52 54 - 58 5A - 62																																																
L1	A	P	L	D						*	*	*	n	i	n																																																																			
L2	U	p	d	a	t	i	n	g					*	*	%																																																																			
VIDEO PLD	<table border="1"> <tr> <td>L1</td> <td>V</td><td>P</td><td>L</td><td>D</td><td></td><td></td><td></td><td></td><td></td><td>*</td><td>*</td><td>*</td><td>n</td><td>i</td><td>n</td> </tr> <tr> <td>L2</td> <td>U</td><td>p</td><td>d</td><td>a</td><td>t</td><td>i</td><td>n</td><td>g</td><td></td><td></td><td></td><td></td><td>*</td><td>*</td><td>%</td> </tr> </table>	L1	V	P	L	D						*	*	*	n	i	n	L2	U	p	d	a	t	i	n	g					*	*	%	50 - 52 54 - 58 5A - 62																																																
L1	V	P	L	D						*	*	*	n	i	n																																																																			
L2	U	p	d	a	t	i	n	g					*	*	%																																																																			
DSP	<table border="1"> <tr> <td>L1</td> <td>D</td><td>S</td><td>P</td><td>1</td><td></td><td></td><td></td><td></td><td></td><td>*</td><td>*</td><td>*</td><td>n</td><td>i</td><td>n</td> </tr> <tr> <td>L2</td> <td>U</td><td>p</td><td>d</td><td>a</td><td>t</td><td>i</td><td>n</td><td>g</td><td></td><td></td><td></td><td></td><td>*</td><td>*</td><td>%</td> </tr> <tr> <td>L1</td> <td>D</td><td>S</td><td>P</td><td>2</td><td></td><td></td><td></td><td></td><td></td><td>*</td><td>*</td><td>*</td><td>n</td><td>i</td><td>n</td> </tr> <tr> <td>L1</td> <td>D</td><td>S</td><td>P</td><td>3</td><td></td><td></td><td></td><td></td><td></td><td>*</td><td>*</td><td>*</td><td>n</td><td>i</td><td>n</td> </tr> <tr> <td>L1</td> <td>D</td><td>S</td><td>P</td><td>4</td><td></td><td></td><td></td><td></td><td></td><td>*</td><td>*</td><td>*</td><td>n</td><td>i</td><td>n</td> </tr> </table>	L1	D	S	P	1						*	*	*	n	i	n	L2	U	p	d	a	t	i	n	g					*	*	%	L1	D	S	P	2						*	*	*	n	i	n	L1	D	S	P	3						*	*	*	n	i	n	L1	D	S	P	4						*	*	*	n	i	n	50 - 52 54 - 58 5A - 62
L1	D	S	P	1						*	*	*	n	i	n																																																																			
L2	U	p	d	a	t	i	n	g					*	*	%																																																																			
L1	D	S	P	2						*	*	*	n	i	n																																																																			
L1	D	S	P	3						*	*	*	n	i	n																																																																			
L1	D	S	P	4						*	*	*	n	i	n																																																																			
GUI Serial Flash	<table border="1"> <tr> <td>L1</td> <td>G</td><td>U</td><td>I</td><td></td><td></td><td></td><td></td><td></td><td></td><td>*</td><td>*</td><td>*</td><td>n</td><td>i</td><td>n</td> </tr> <tr> <td>L2</td> <td>U</td><td>p</td><td>d</td><td>a</td><td>t</td><td>i</td><td>n</td><td>g</td><td></td><td></td><td></td><td></td><td>*</td><td>*</td><td>%</td> </tr> </table>	L1	G	U	I							*	*	*	n	i	n	L2	U	p	d	a	t	i	n	g					*	*	%	50 - 52 54 - 58 5A 62 80 - 86																																																
L1	G	U	I							*	*	*	n	i	n																																																																			
L2	U	p	d	a	t	i	n	g					*	*	%																																																																			
CX870 / CY920 second Boot Loader	<table border="1"> <tr> <td>L1</td> <td>E</td><td>t</td><td>h</td><td>e</td><td>r</td><td>S</td><td>B</td><td>L</td><td></td><td>*</td><td>*</td><td>*</td><td>n</td><td>i</td><td>n</td> </tr> <tr> <td>L2</td> <td>U</td><td>p</td><td>d</td><td>a</td><td>t</td><td>i</td><td>n</td><td>g</td><td></td><td></td><td></td><td></td><td>*</td><td>*</td><td>%</td> </tr> </table>	L1	E	t	h	e	r	S	B	L		*	*	*	n	i	n	L2	U	p	d	a	t	i	n	g					*	*	%	A0 - A4 A6 - A7 AE - B5																																																
L1	E	t	h	e	r	S	B	L		*	*	*	n	i	n																																																																			
L2	U	p	d	a	t	i	n	g					*	*	%																																																																			
CX870 / CY920 Image	<table border="1"> <tr> <td>L1</td> <td>E</td><td>t</td><td>h</td><td>e</td><td>r</td><td>I</td><td>M</td><td>G</td><td></td><td>*</td><td>*</td><td>*</td><td>n</td><td>i</td><td>n</td> </tr> <tr> <td>L2</td> <td>U</td><td>p</td><td>d</td><td>a</td><td>t</td><td>i</td><td>n</td><td>g</td><td></td><td></td><td></td><td></td><td>*</td><td>*</td><td>%</td> </tr> </table>	L1	E	t	h	e	r	I	M	G		*	*	*	n	i	n	L2	U	p	d	a	t	i	n	g					*	*	%	A0 - A4 A6 - A7 AE - B5																																																
L1	E	t	h	e	r	I	M	G		*	*	*	n	i	n																																																																			
L2	U	p	d	a	t	i	n	g					*	*	%																																																																			
CX870 / CY920 Image (Emergency Mode)	<table border="1"> <tr> <td>L1</td> <td>P</td><td>l</td><td>e</td><td>a</td><td>s</td><td>e</td><td>r</td><td>e</td><td>t</td><td>.</td><td>.</td><td>.</td><td></td><td></td><td></td> </tr> <tr> <td>L2</td> <td>U</td><td>p</td><td>d</td><td>a</td><td>t</td><td>e</td><td>r</td><td>e</td><td>t</td><td>r</td><td>y</td><td></td><td></td><td></td><td></td> </tr> </table>	L1	P	l	e	a	s	e	r	e	t	.	.	.				L2	U	p	d	a	t	e	r	e	t	r	y					-																																																
L1	P	l	e	a	s	e	r	e	t	.	.	.																																																																						
L2	U	p	d	a	t	e	r	e	t	r	y																																																																							

## Checking the Firmware Version After an Update

After updating the firmware, check the version.

See "1. Version Display Mode" ( 19 page ).



# ADJUSTMENT

## Adjusting Idling Current

### 1. Preparation

- (1) Prepare a DV voltmeter.
- (2) Place the unit in normal usage conditions, away from highly ventilated areas such as next to an air conditioning machine or electric fan.  
The set requires an ambient temperature of 15°C to 30°C and standard humidity.
- (3) Settings of This Unit
  - POWER (Power source switch)      STANDBY
  - SPEAKER (Speaker terminal)      No load
 ( Do not connect equipment such as speakers or dummy resistors. )

### 2. Adjustment Procedure

- (1) Remove the top cover and turn V101(ALL Channel) of the AMP UNIT as far anticlockwise(↺) as possible.
- (2) Connect the DC Voltmeter test points. ⚠
 

FRONT-Lch	: N5813 10, 11pin
FRONT-Rch	: N5823 2, 3pin
CENTER ch	: N5813 8, 9pin
SURROUND-Lch	: N5813 6, 7pin
SURROUND-Rch	: N5823 4, 5pin
SURROUND-BACK Lch	: N5813 4, 5pin
SURROUND-BACK Rch	: N5823 6, 7pin
FRONT-WIDE/HEIGHT Lch	: N5813 2, 3pin
FRONT-WIDE/HEIGHT Rch	: N5823 8, 9pin
- (3) Connect the power cord to an outlet. Next, press the power button to turn on the power.
- (4) Set this unit as follows.
 

MASTER VOLUME	: "---" anticlockwise (↺ min.)
SPEAKER (Speaker terminal)	: No load

 ( Do not connect equipment such as speakers or dummy resistors. )
 

MODE	: MCH STEREO
FUNCTION	: DVD
- (5) Turn VR101 clockwise (↻) and adjust the voltage of the test point to "**8.0mV ± 0.5mV DC**" within 2 minutes.
- (6) 10 minutes after the preliminary adjustment, turn V101 and set the voltage as "**8.0mV ± 0.5mV DC**".
- (7) Adjust the variable resistance of each channel using the same method.

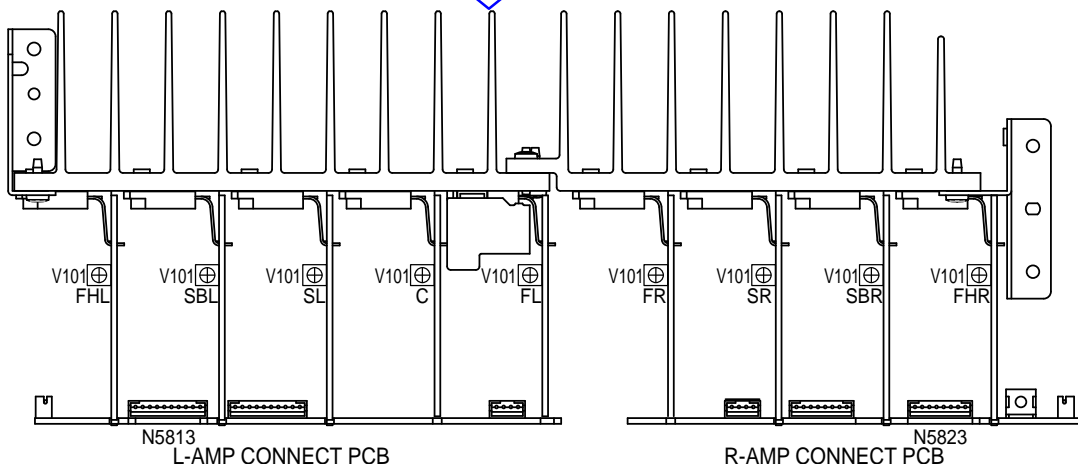
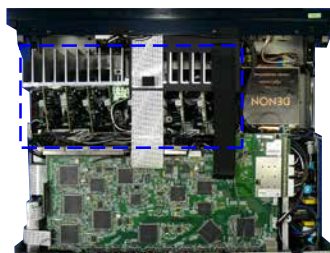

# SURROUND MODES AND PARAMETERS

## Sound modes and channel output

○ This indicates the audio output channels or surround parameters that can be set.

⊙ This indicates the audio output channels. The output channels depend on the settings of "Speaker Config." (☞ p. 230).

Sound mode	Channel output														
	Front L/R	Center	Surround L/R	Surround back L/R	Front wide L/R	Front height L/R	Top Front L/R	Top Middle L/R	Top Rear L/R	Rear Height L/R	Front Dolby Enabled L/R	Surround Dolby Enabled L/R	Back Dolby Enabled L/R	Subwoofer	
Direct/Pure Direct (2-channel)	○													⊙*7	
Direct/Pure Direct (Multi-channel)	○	⊙	⊙	⊙*3	⊙*3	⊙*3								⊙	
DSD Direct (2-channel)	○													⊙*7	
DSD Direct (Multi-channel)	○	⊙	⊙											⊙	
Stereo	○													⊙	
Multi Ch In	○	⊙	⊙	⊙*3										⊙	
Dolby Surround *1	○	⊙	⊙	⊙*4		⊙	⊙	⊙	⊙	⊙	⊙	⊙	⊙	⊙	
DTS Neo:X *2	○	⊙	⊙	⊙*5	⊙*5	⊙*5								⊙	
Audyssey DSX®	○	⊙	⊙		⊙*6	⊙*6								⊙	
Dolby Digital	○	⊙	⊙											⊙	
Dolby Digital Plus	○	⊙	⊙	⊙*3	⊙*3	⊙*3								⊙	
Dolby TrueHD	○	⊙	⊙	⊙*3	⊙*3	⊙*3								⊙	
Dolby Atmos	○	⊙	⊙	⊙	⊙	⊙	⊙	⊙	⊙	⊙	⊙	⊙	⊙	⊙	
DTS Surround	○	⊙	⊙	⊙										⊙	
DTS 96/24	○	⊙	⊙	⊙										⊙	
DTS-HD	○	⊙	⊙	⊙*3	⊙*3	⊙*3								⊙	
DTS Express	○	⊙	⊙	⊙										⊙	
Multi Ch Stereo	○	⊙	⊙	⊙*5	⊙*5	⊙*5	⊙*5	⊙*5	⊙*5	⊙*5	⊙*5	⊙*5	⊙*5	⊙	
Rock Arena	○	⊙	⊙	⊙*5	⊙*5	⊙*5	⊙*5	⊙*5	⊙*5	⊙*5	⊙*5	⊙*5	⊙*5	⊙	
Jazz Club	○	⊙	⊙	⊙*5	⊙*5	⊙*5	⊙*5	⊙*5	⊙*5	⊙*5	⊙*5	⊙*5	⊙*5	⊙	
Mono Movie	○	⊙	⊙	⊙*5	⊙*5	⊙*5	⊙*5	⊙*5	⊙*5	⊙*5	⊙*5	⊙*5	⊙*5	⊙	
Video Game	○	⊙	⊙	⊙*5	⊙*5	⊙*5	⊙*5	⊙*5	⊙*5	⊙*5	⊙*5	⊙*5	⊙*5	⊙	
Matrix	○	⊙	⊙	⊙*5	⊙*5	⊙*5	⊙*5	⊙*5	⊙*5	⊙*5	⊙*5	⊙*5	⊙*5	⊙	
Virtual	○													⊙	

\*1 The applicable sound mode includes "Dolby Surround" and sound modes that have "+Dolby Surround" in the sound mode name.

\*2 The applicable sound mode includes "DTS Neo:X" and sound modes that have "+Neo:X" in the sound mode name.

\*3 A signal for each channel contained in an input signal is output as audio.

\*4 Audio is not output when "Speaker Config." - "Surr. Back" in the menu is set to "1 spkr". (☞ p. 231)

\*5 Audio is output from the speakers specified in the "Surround Parameter" - "Speaker Select" settings. (☞ p. 178)

\*6 Audio is output from the speakers specified in the "Audyssey DSX®" settings. (☞ p. 184)

\*7 Audio is output when "Subwoofer Mode" in the menu is set to "LFE+Main". (☞ p. 237)

## Sound modes and surround parameters

Sound mode	Surround Parameter									
	Subwoofer Level Adjust	Cinema EQ	Loudness Management *1	Dynamic Compression *2	Low Frequency Effects*3	Delay Time	Effect Level	Room Size	Speaker Select	
Direct/Pure Direct (2-channel) *4	○*5		○	○						
Direct/Pure Direct (Multi-channel) *4	○		○	○	○					
DSD Direct (2-channel)	○*5									
DSD Direct (Multi-channel) *4	○				○					
Stereo	○		○	○						
Multi Ch In	○	○			○					
Dolby Surround	○	○	○	○						
DTS Neo:X	○	○	○	○					○	
Audyssey DSX®	○	○	○	○	○					
Dolby Digital	○	○	○	○	○					
Dolby Digital Plus	○	○	○	○	○					
Dolby TrueHD	○	○	○	○	○					
Dolby Atmos	○	○	○	○	○					
DTS Surround	○	○		○	○					
DTS 96/24	○	○			○					
DTS-HD	○	○			○					
DTS Express	○	○			○					
Multi Ch Stereo	○		○	○	○				○	
Rock Arena	○		○	○	○		○		○	
Jazz Club	○		○	○	○		○		○	
Mono Movie	○		○	○	○		○		○	
Video Game	○		○	○	○		○		○	
Matrix	○		○	○	○	○			○	
Virtual	○		○	○	○					

Sound mode	Surround Parameter		Dialog Enhancer	Tone*6	Audyssey					Restorer*9
	Center Spread	Center Gain			MultEQ® XT 32 *7	Dunamic EQ *8	Dunamic Volume *8	Audyssey LFC™*8	Audyssey DSX®	
Direct/Pure Direct (2-channel) *4										
Direct/Pure Direct (Multi-channel) *4										
DSD Direct (2-channel)										
DSD Direct (Multi-channel) *4										
Stereo			<input type="radio"/>	<input type="radio"/>	<input type="radio"/>	<input type="radio"/>	<input type="radio"/>	<input type="radio"/>		<input type="radio"/>
Multi Ch In			<input type="radio"/>	<input type="radio"/>	<input type="radio"/>	<input type="radio"/>	<input type="radio"/>	<input type="radio"/>	<input type="radio"/>	
Dolby Surround	<input type="radio"/>		<input type="radio"/>	<input type="radio"/>	<input type="radio"/>	<input type="radio"/>	<input type="radio"/>	<input type="radio"/>		<input type="radio"/>
DTS Neo:X		<input type="radio"/>	<input type="radio"/>	<input type="radio"/>	<input type="radio"/>	<input type="radio"/>	<input type="radio"/>	<input type="radio"/>		<input type="radio"/>
Audyssey DSX®			<input type="radio"/>	<input type="radio"/>	<input type="radio"/>	<input type="radio"/>	<input type="radio"/>	<input type="radio"/>	<input type="radio"/>	
Dolby Digital			<input type="radio"/>	<input type="radio"/>	<input type="radio"/>	<input type="radio"/>	<input type="radio"/>	<input type="radio"/>	<input type="radio"/>	
Dolby Digital Plus			<input type="radio"/>	<input type="radio"/>	<input type="radio"/>	<input type="radio"/>	<input type="radio"/>	<input type="radio"/>	<input type="radio"/>	
Dolby TrueHD			<input type="radio"/>	<input type="radio"/>	<input type="radio"/>	<input type="radio"/>	<input type="radio"/>	<input type="radio"/>	<input type="radio"/>	
Dolby Atmos			<input type="radio"/>	<input type="radio"/>	<input type="radio"/>	<input type="radio"/>	<input type="radio"/>	<input type="radio"/>	<input type="radio"/>	
DTS Surround			<input type="radio"/>	<input type="radio"/>	<input type="radio"/>	<input type="radio"/>	<input type="radio"/>	<input type="radio"/>	<input type="radio"/>	
DTS 96/24			<input type="radio"/>	<input type="radio"/>	<input type="radio"/>	<input type="radio"/>	<input type="radio"/>	<input type="radio"/>	<input type="radio"/>	
DTS-HD			<input type="radio"/>	<input type="radio"/>	<input type="radio"/>	<input type="radio"/>	<input type="radio"/>	<input type="radio"/>	<input type="radio"/>	
DTS Express			<input type="radio"/>	<input type="radio"/>	<input type="radio"/>	<input type="radio"/>	<input type="radio"/>	<input type="radio"/>	<input type="radio"/>	
Multi Ch Stereo			<input type="radio"/>	<input type="radio"/>	<input type="radio"/>	<input type="radio"/>	<input type="radio"/>	<input type="radio"/>		<input type="radio"/>
Rock Arena			<input type="radio"/>	<input type="radio"/>	<input type="radio"/>	<input type="radio"/>	<input type="radio"/>	<input type="radio"/>		<input type="radio"/>
Jazz Club			<input type="radio"/>	<input type="radio"/>	<input type="radio"/>	<input type="radio"/>	<input type="radio"/>	<input type="radio"/>		<input type="radio"/>
Mono Movie			<input type="radio"/>	<input type="radio"/>	<input type="radio"/>	<input type="radio"/>	<input type="radio"/>	<input type="radio"/>		<input type="radio"/>
Video Game			<input type="radio"/>	<input type="radio"/>	<input type="radio"/>	<input type="radio"/>	<input type="radio"/>	<input type="radio"/>		<input type="radio"/>
Matrix			<input type="radio"/>	<input type="radio"/>	<input type="radio"/>	<input type="radio"/>	<input type="radio"/>	<input type="radio"/>		<input type="radio"/>
Virtual			<input type="radio"/>	<input type="radio"/>	<input type="radio"/>	<input type="radio"/>	<input type="radio"/>	<input type="radio"/>		<input type="radio"/>

- \*1 This item can be selected when the Dolby Digital, Dolby Digital Plus, Dolby TrueHD or Dolby Atmos signal is played back.
- \*2 This item can be selected when the Dolby Digital, Dolby Digital Plus, Dolby TrueHD, Dolby Atmos or DTS is played back.
- \*3 This item can be selected when a Dolby Digital or DTS signal or DVD-Audio is played.
- \*4 During playback in Pure Direct mode, the surround parameters are the same as in Direct mode.
- \*5 This setting is available when "Subwoofer Mode" in the menu is set to "LFE+Main". (☞ p. 237)
- \*6 This item cannot be set when "Dynamic EQ" is set to "On". (☞ p. 182)
- \*7 This item cannot be set when Audyssey® Setup (Speaker Calibration) has not been performed.
- \*8 This item cannot be set when "MultEQ® XT32" in the menu is set to "Off". (☞ p. 181)
- \*9 This item can be set when the input signal is analog, PCM 48 kHz or 44.1 kHz.

# Types of input signals, and corresponding sound modes

- This indicates the default sound mode.
- This indicates the selectable sound mode.

Sound mode	NOTE	2-channel signal					Multi-channel signal									
		Analog / PCM	Dolby Digital (+/HD)	DTS (-HD)	DSD (Super Audio CD)	PCM Multi	DTS-HD	DTS Express	DTS ES Dscr6.1	DTS ES Mtr6.1	DTS	Dolby Atmos	Dolby TrueHD	Dolby Digital Plus	Dolby Digital (EX)	DSD (Super Audio CD)
DTS Surround																
DTS-HD MSTR							●*3									
DTS-HD HI RES							●*4									
DTS ES Dscr6.1	*1								●							
DTS ES Mtr6.1	*1									●						
DTS Surround									○		○					
DTS 96/24												●*5				
DTS(-HD) + Dolby Surround							○	○	○	○	○					
DTS Express								●								
DTS(-HD) + Neo:X	*2						○	○	○	○	○					
DTS Neo:X		○	○	●	○											
Dolby Surround																
Dolby Atmos												●				
Dolby TrueHD												○*6	○			
Dolby Digital+												○*7		○		
Dolby(D+)(HD) + Dolby Surround													●	●	●	
Dolby Digital															○	
Dolby(D)(D+)(HD) + Neo:X	*2											○*8	○	○	○	
Dolby Surround		○	●	○	○											

Sound mode	NOTE	2-channel signal					Multi-channel signal									
		Analog / PCM	Dolby Digital (+/HD)	DTS (-HD)	DSD (Super Audio CD)	PCM Multi	DTS-HD	DTS Express	DTS ES Dscr6.1	DTS ES Mtr6.1	DTS	Dolby Atmos	Dolby TrueHD	Dolby Digital Plus	Dolby Digital (EX)	DSD (Super Audio CD)
Multi Ch In																
Multi Ch In						●										●
Multi Ch In + Dolby Surround						○										○
Multi Ch In + Neo:X	*2					○										○
Multi Ch In 7.1	*1					●*10										
Audyssey																
Audyssey DSX®						○	○	○	○	○	○	○*8	○	○	○	○
Direct																
Direct		○*9	○	○		○	○	○	○	○	○	○	○	○	○	
DSD Direct					○											○
Pure Direct																
Pure Direct		○	○	○		○	○	○	○	○	○	○	○	○	○	
DSD Pure Direct					○											○
Original sound mode																
Multi Ch Stereo		○	○	○	○	○	○	○	○	○	○	○	○	○	○	○
Rock Arena		○	○	○	○	○	○	○	○	○	○	○*8	○	○	○	○
Jazz Club		○	○	○	○	○	○	○	○	○	○	○*8	○	○	○	○
Mono Movie		○	○	○	○	○	○	○	○	○	○	○*8	○	○	○	○
Video Game		○	○	○	○	○	○	○	○	○	○	○*8	○	○	○	○
Matrix		○	○	○	○	○	○	○	○	○	○	○*8	○	○	○	○
Virtual		○	○	○	○	○	○	○	○	○	○	○*8	○	○	○	○
Stereo																
Stereo		●	○	○	●	○	○	○	○	○	○	○	○	○	○	○

- \*1 This item can be selected when surround back speakers are used.
- \*2 The "Cinema" mode, "Music" mode or "Game" mode can be selected. This item can be selected when using any of the surround back, front height or front wide speaker.
- \*3 This item can be selected when the input signal is DTS-HD Master Audio.
- \*4 This item can be selected when the input signal is DTS-HD Hi Resolution.
- \*5 This item can be selected when the input signal is DTS 96/24.
- \*6 This can be selected when the Dolby Atmos signal contains the Dolby TrueHD signal.
- \*7 This can be selected when the Dolby Atmos signal contains the Dolby Digital+ signal.
- \*8 This can be selected when the Dolby Atmos signal contains the Dolby TrueHD or Dolby Digital+ signal.
- \*9 The default sound mode for the AirPlay playback is "Direct".
- \*10 This item can be selected when the input signals contain surround back signals.

# TROUBLE SHOOTING

## 1. POWER

### 1.1. The unit does not power on

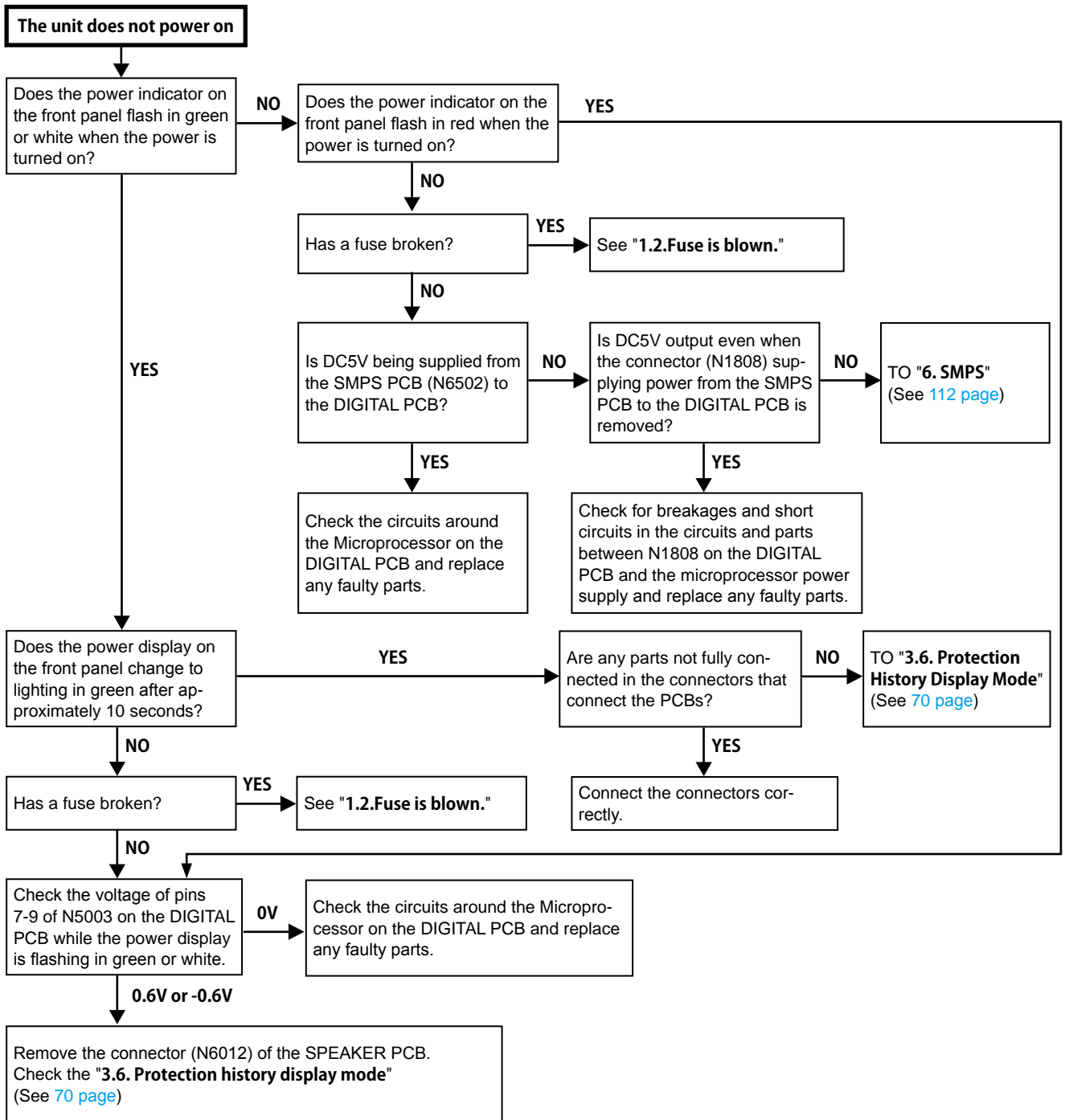

### 1.2. Fuse is blown

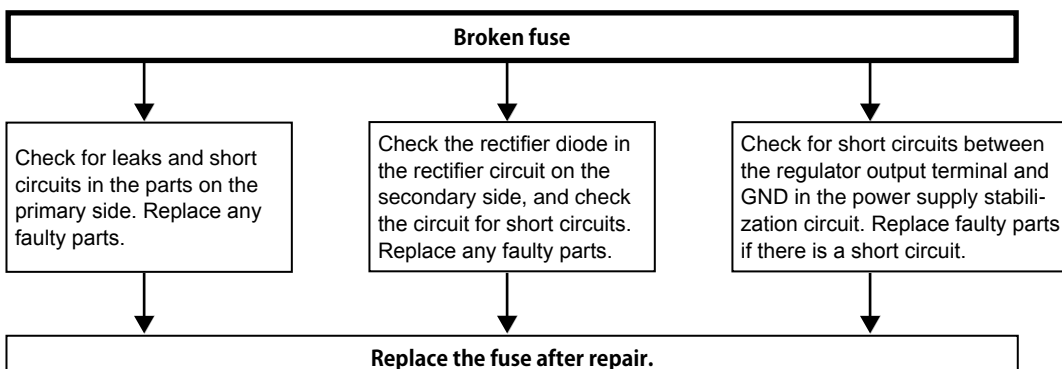

## 2. Analog video

※ Function is set to CBL/SAT.

※ ZONE2 is set to POWER ON (functin CBL/SAT).

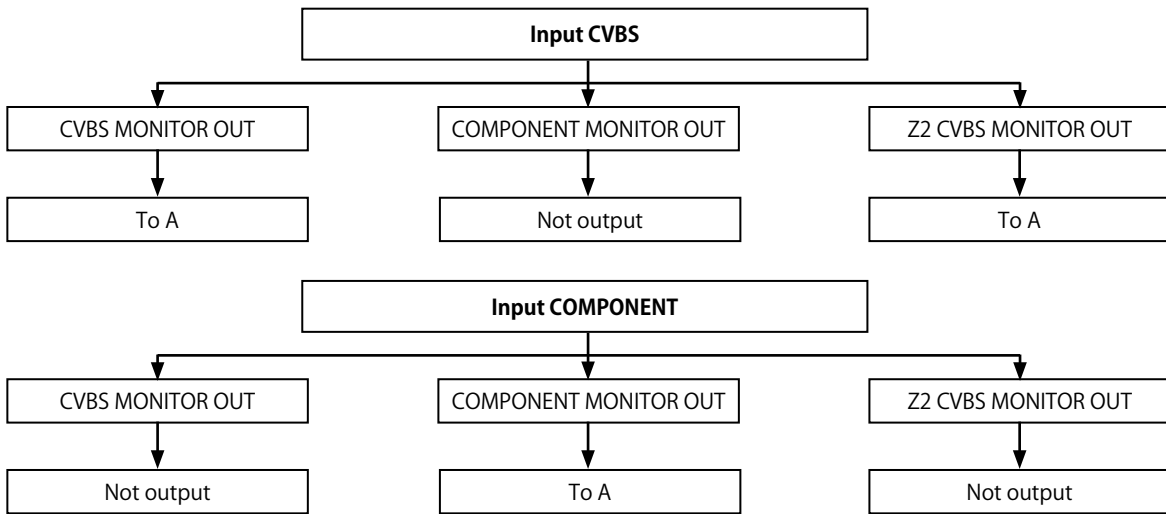

### <AUDIO VIDEO PCB> test point

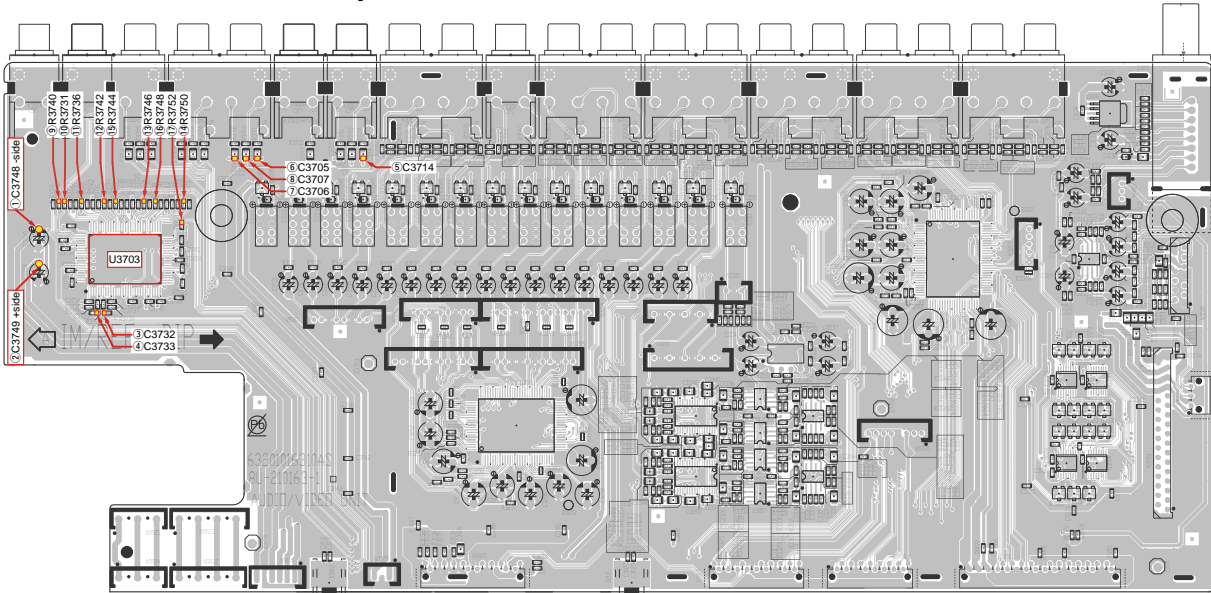

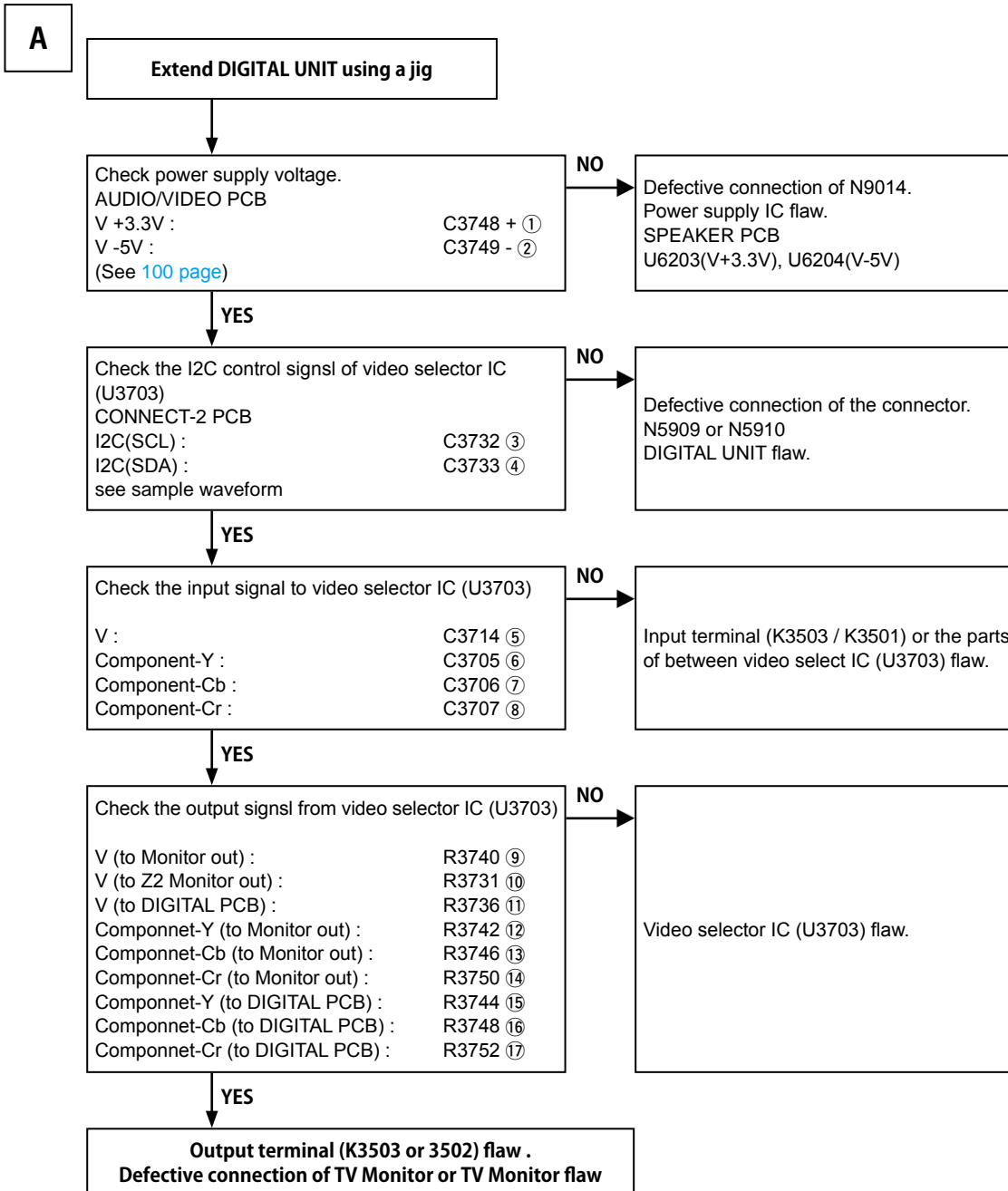

**I2C communication wave form (sample)**

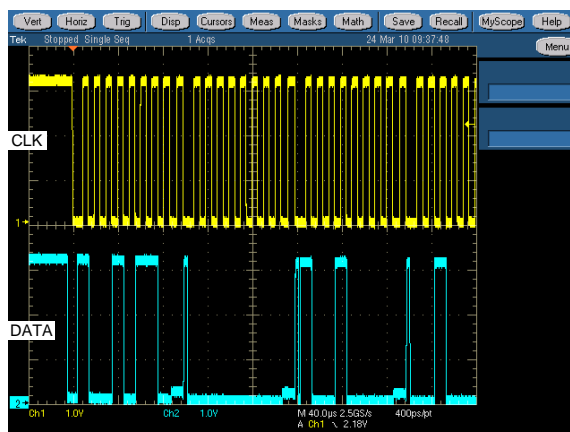

### 3. HDMI/DVI

#### 3.1. No picture or sound is output (HDMI to HDMI)

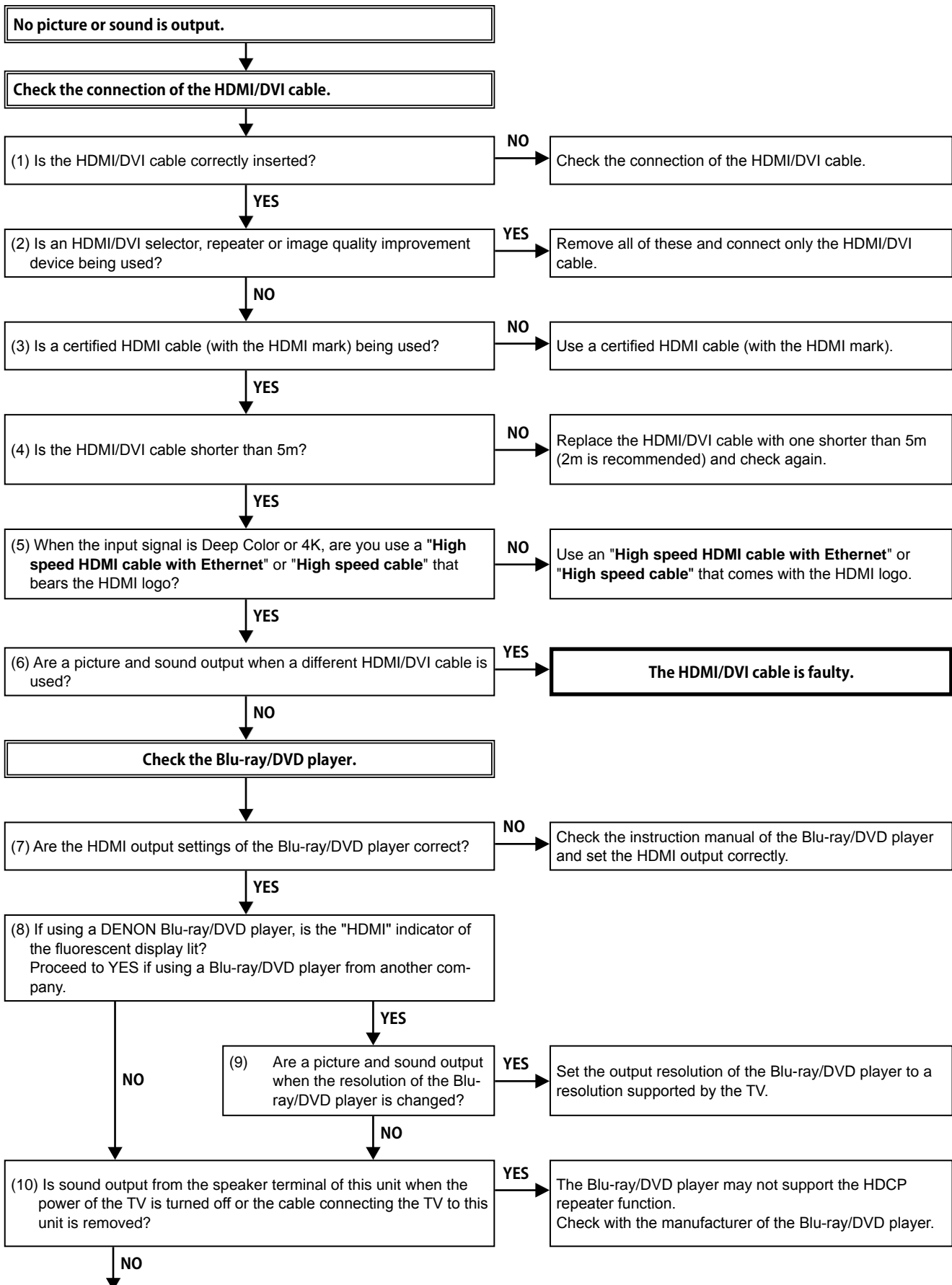



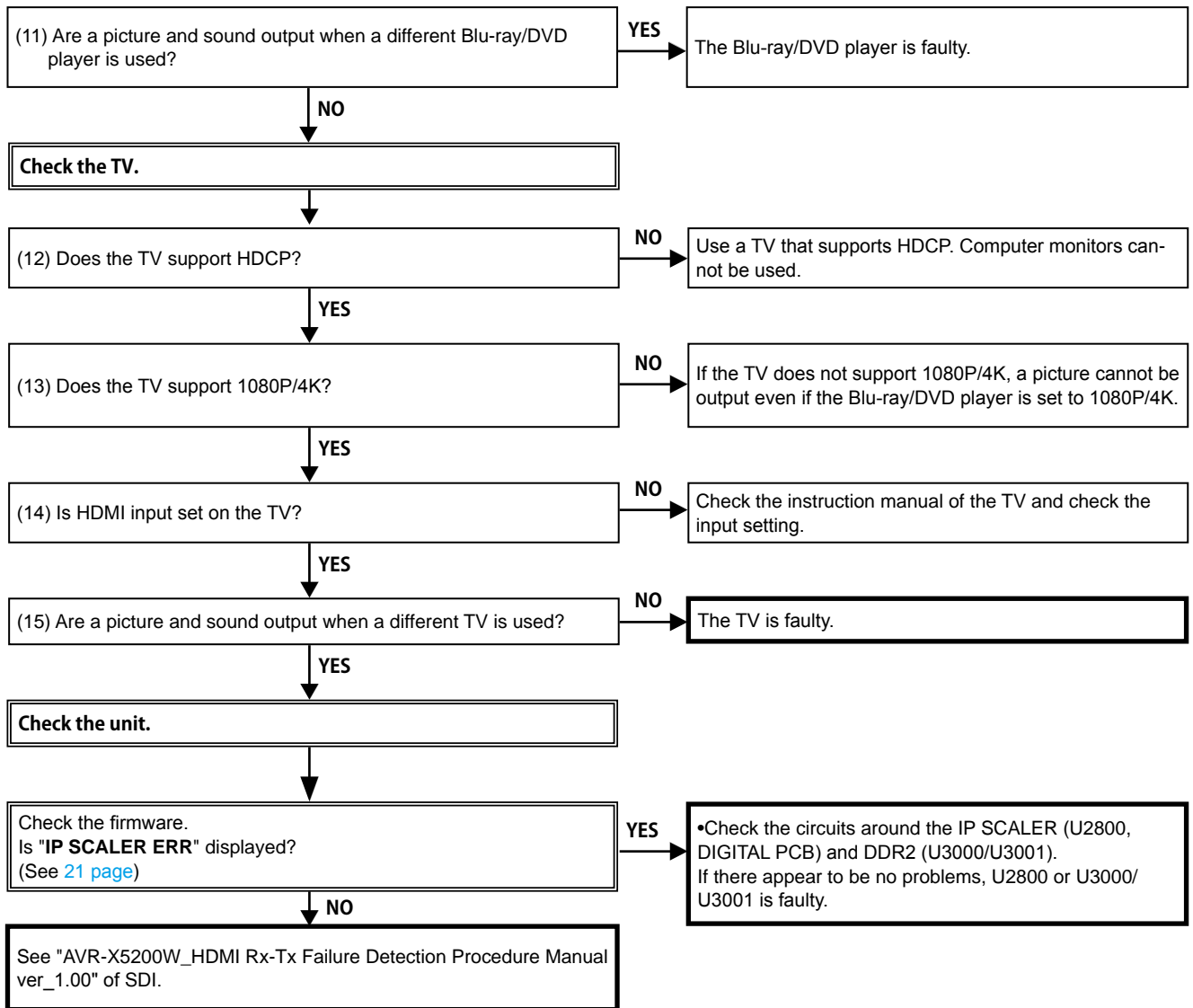

## 4. AUDIO

### 4.1. AUDIO CHECK

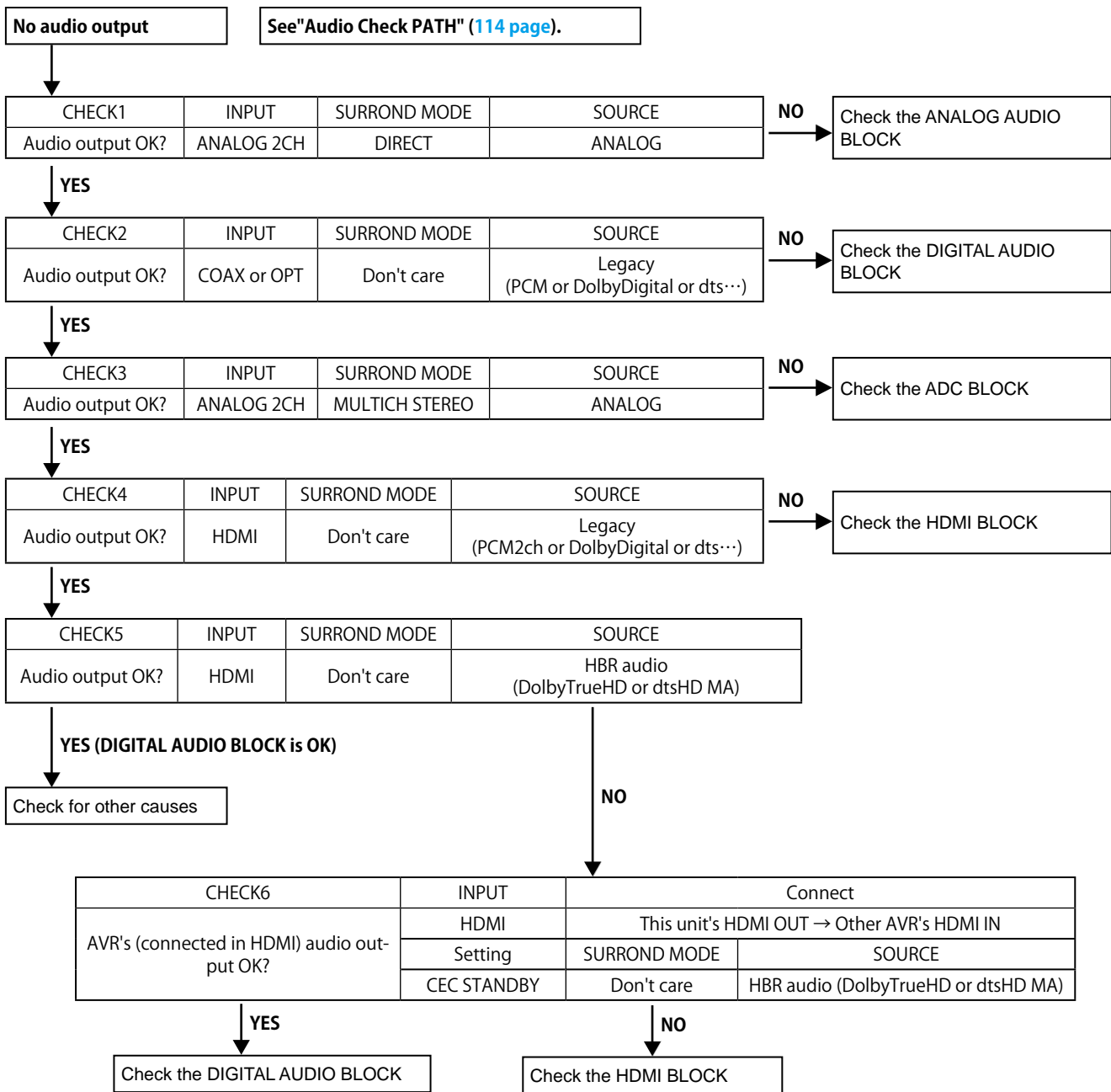

## 4.2. Power AMP (AMP PCB)

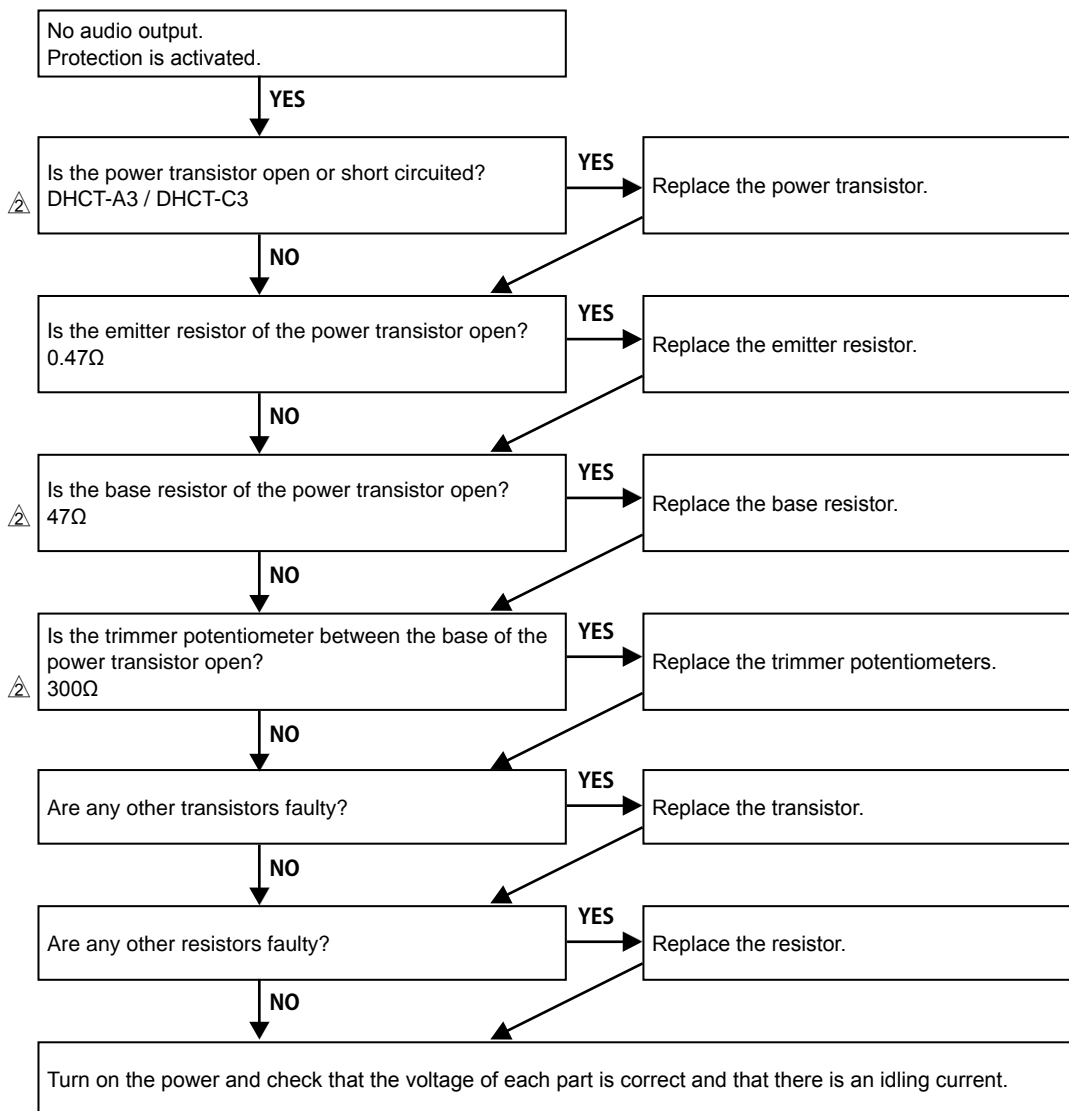

### 4.3. Analog audio

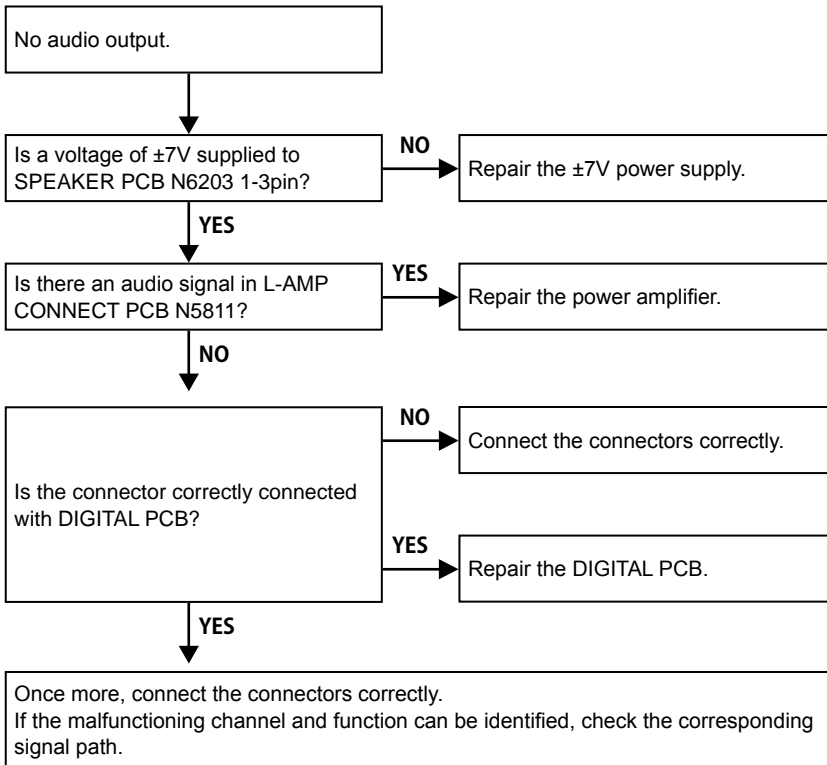

## 5. Network/Bluetooth/USB

### 5.1. Cannot connect to the network

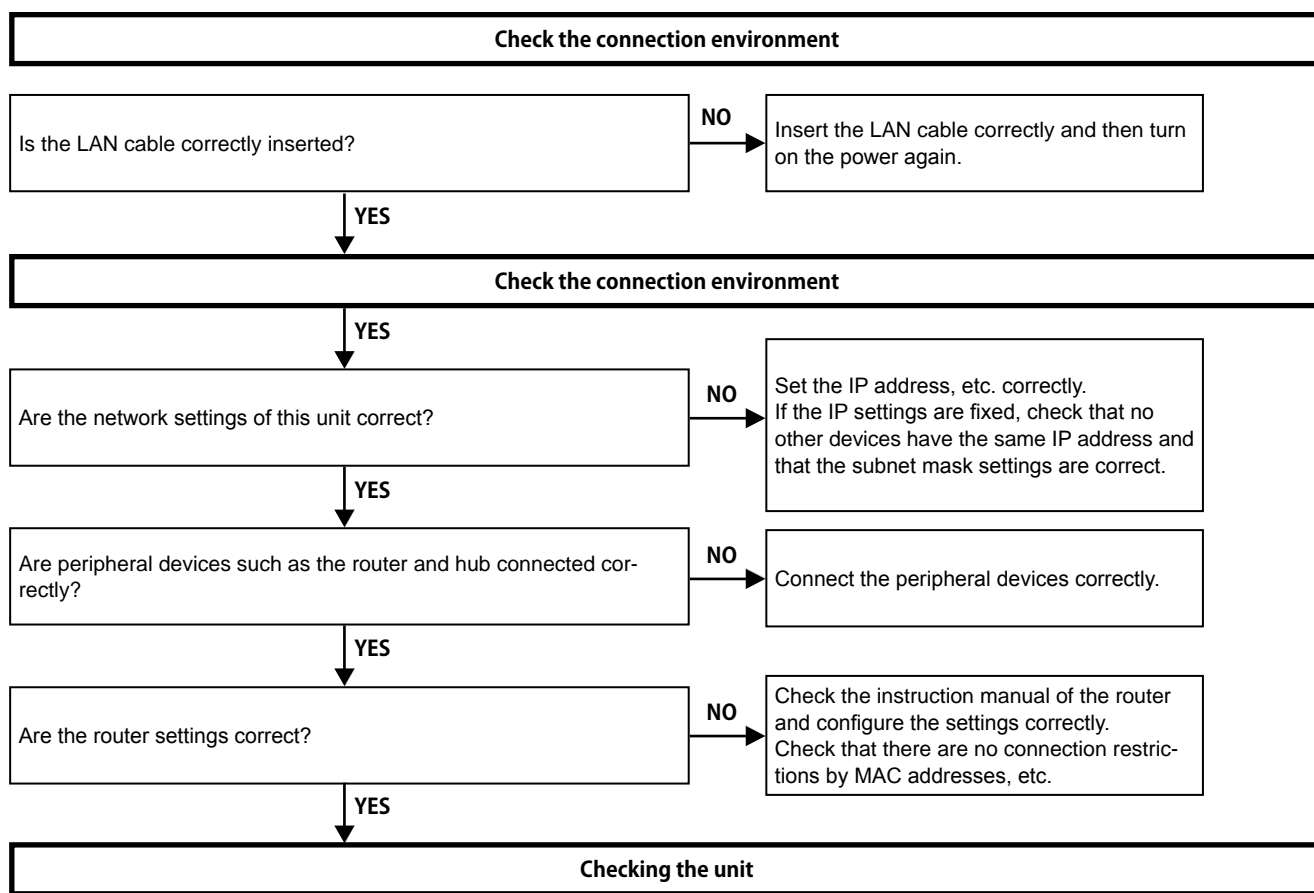

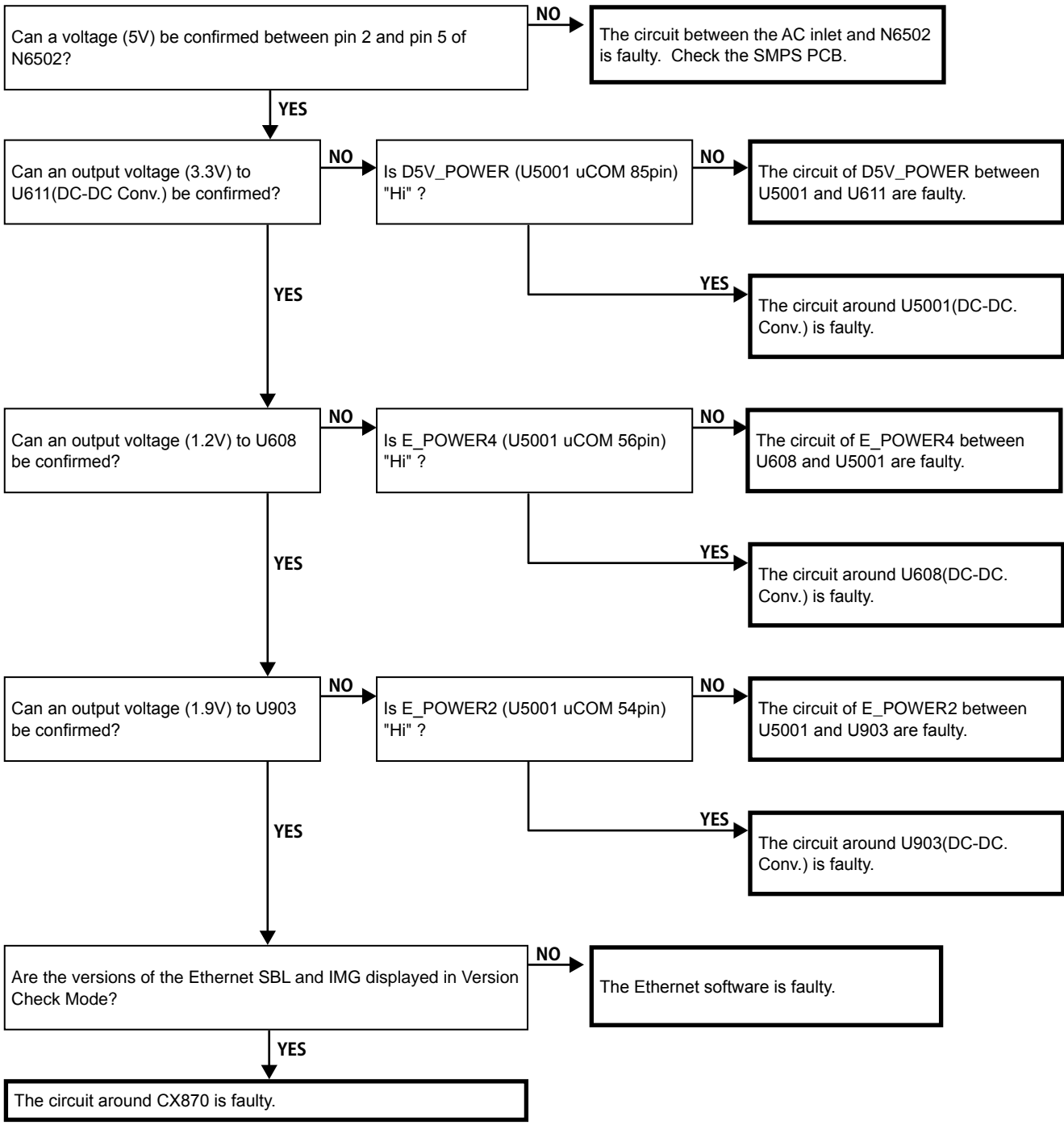

## 5.2. Cannot connect to the Bluetooth

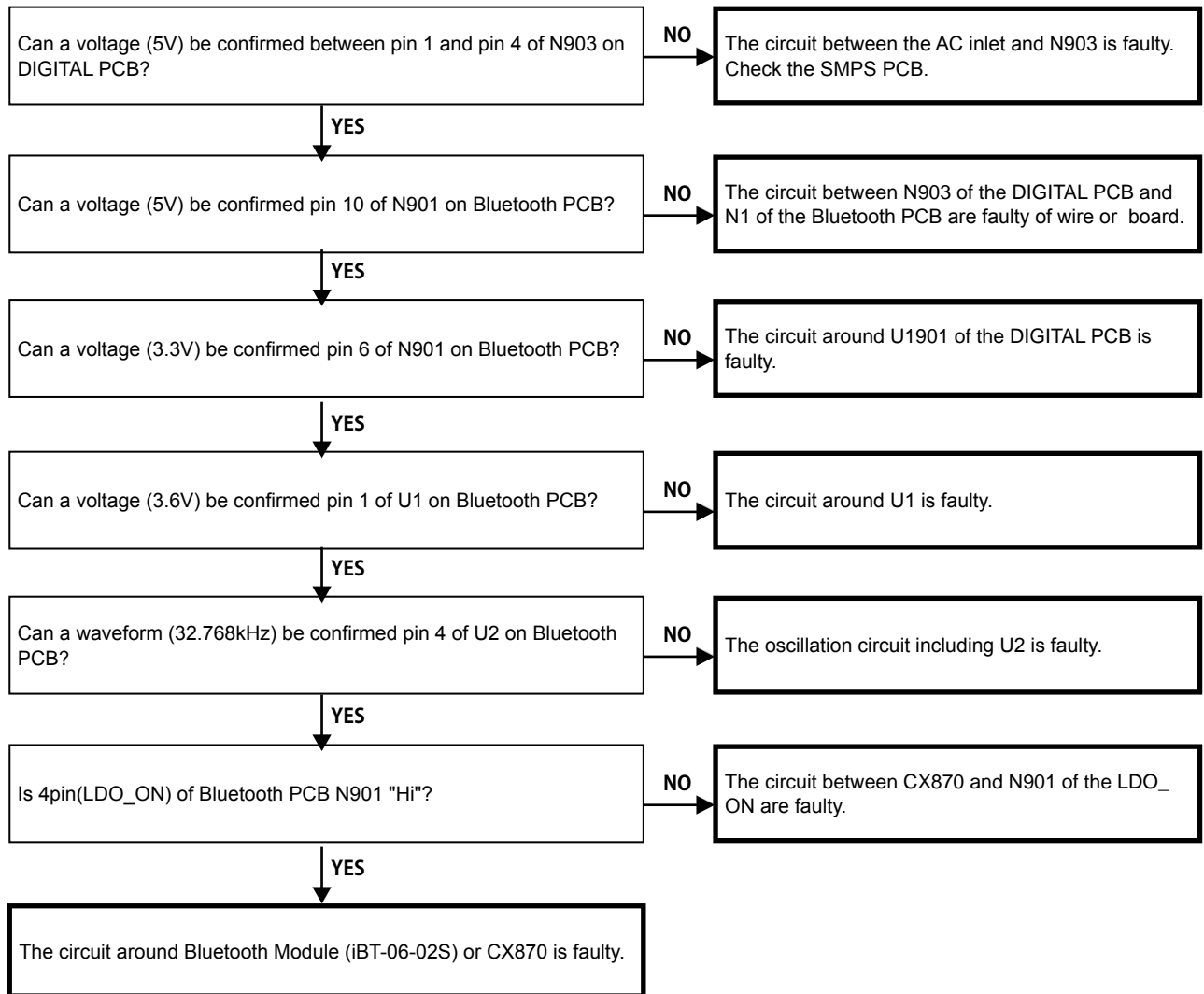

### 5.3. A connected USB device is not recognized.

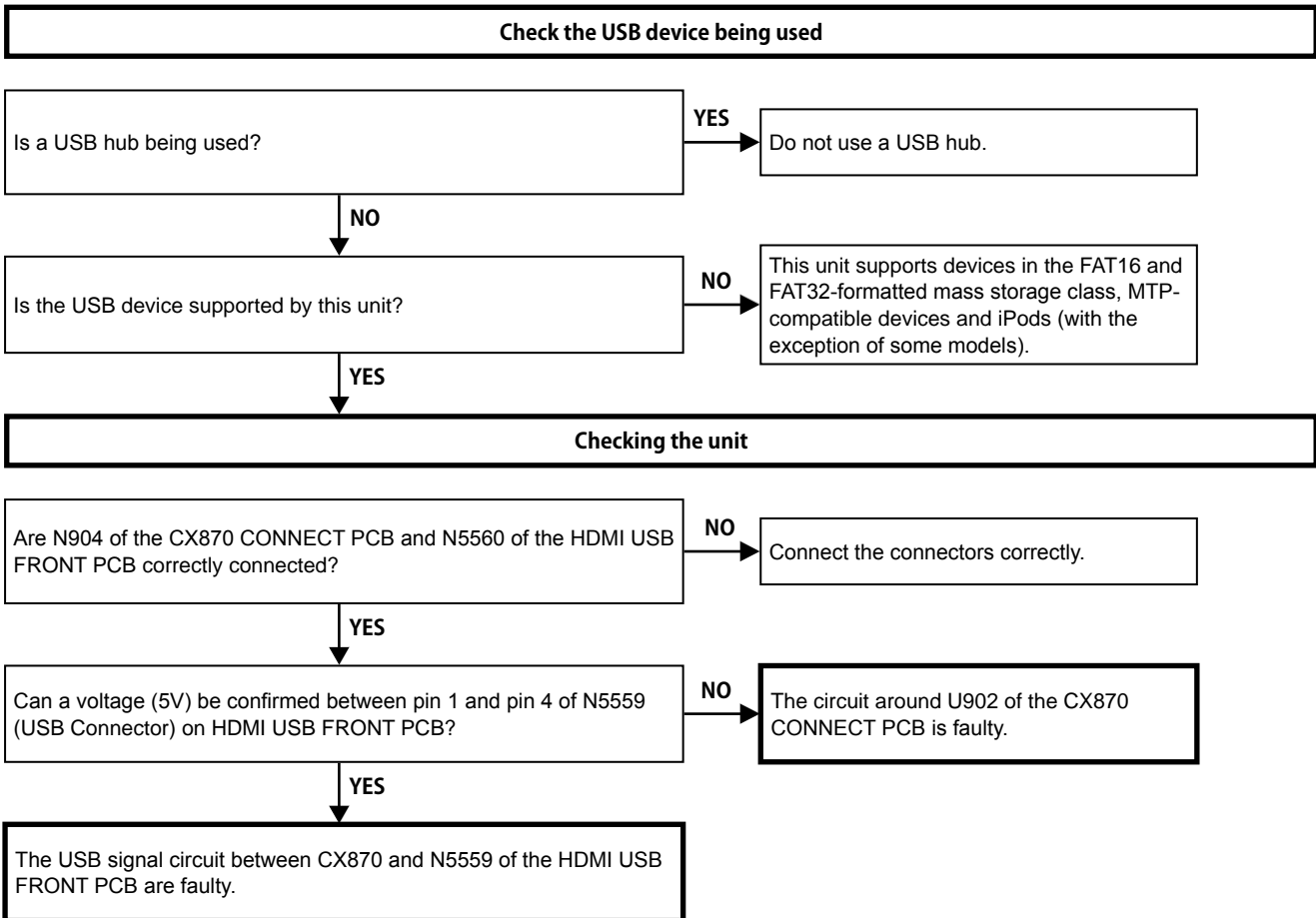

### 5.4. No picture or sound is output

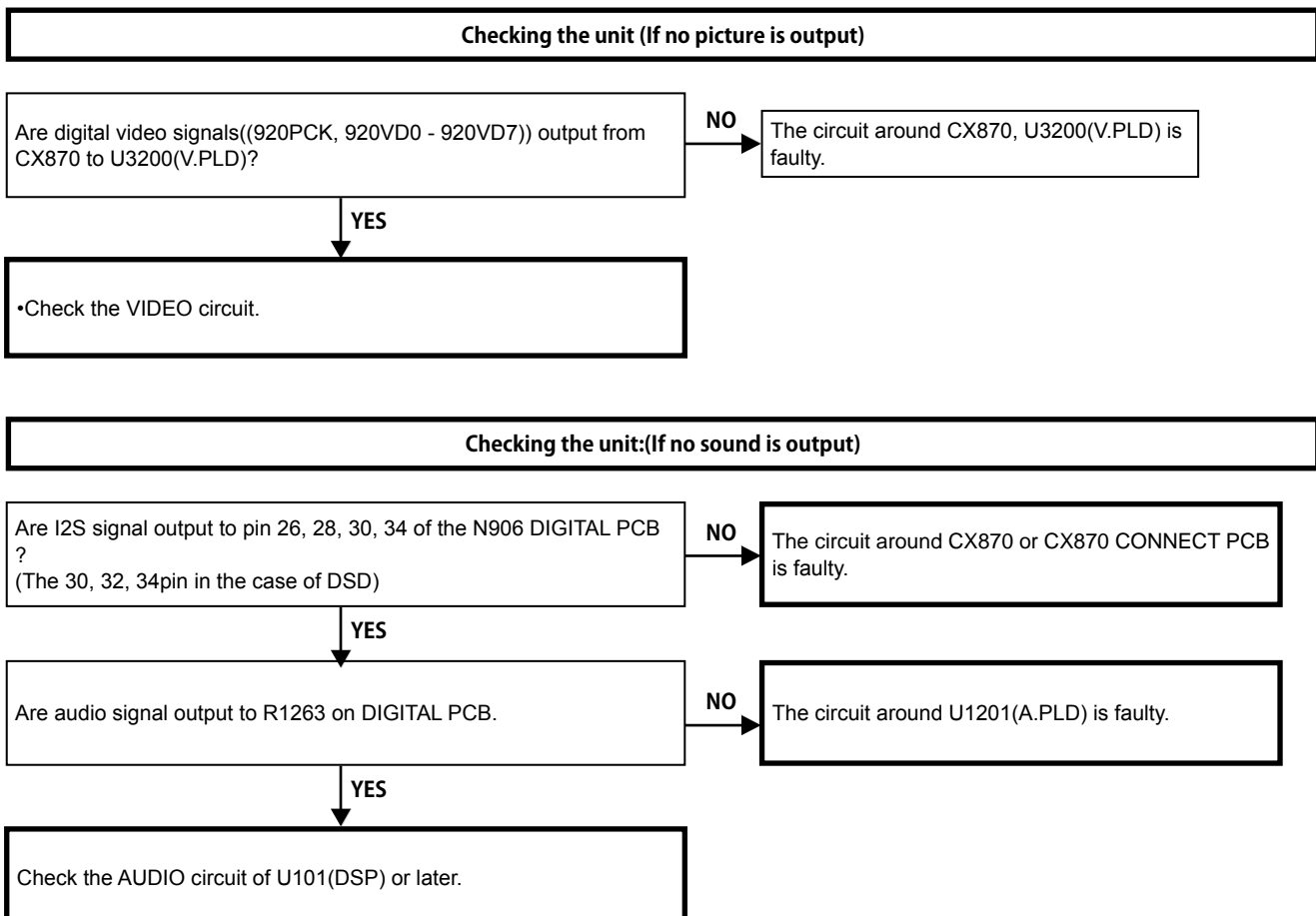



## DIGITAL test point

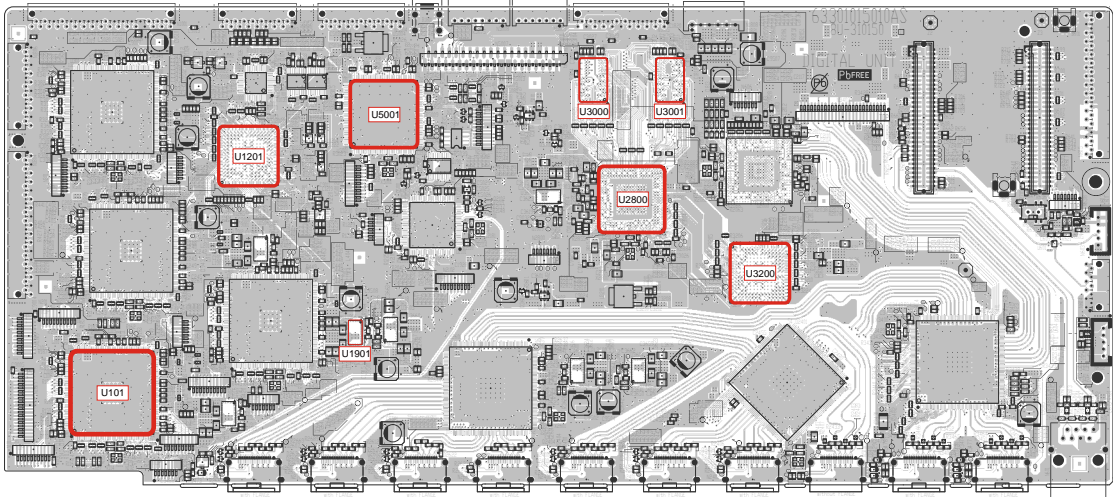

(A SIDE)

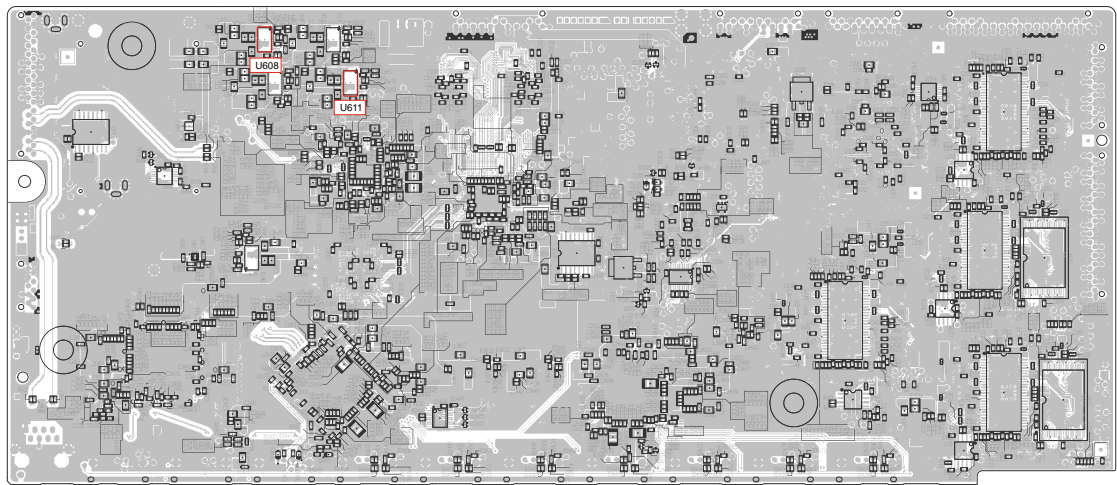

(B SIDE)

## CX870 CONNECT test point

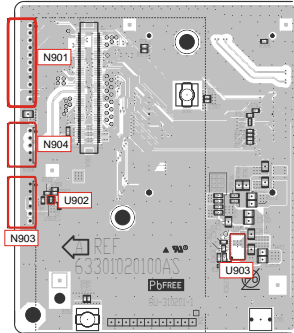

(A SIDE)

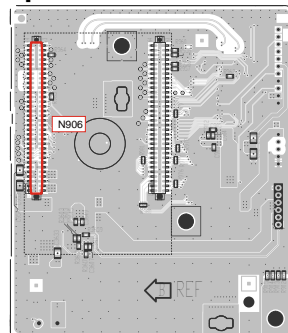

(B SIDE)

## USB test point

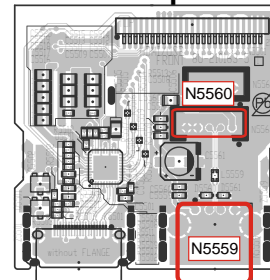

(A SIDE)

## Bluetooth test point

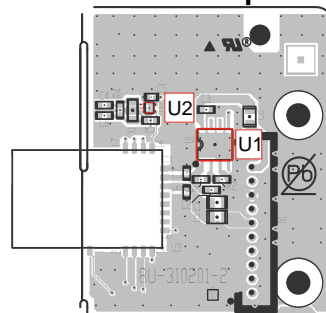

(A SIDE)

## 6. SMPS

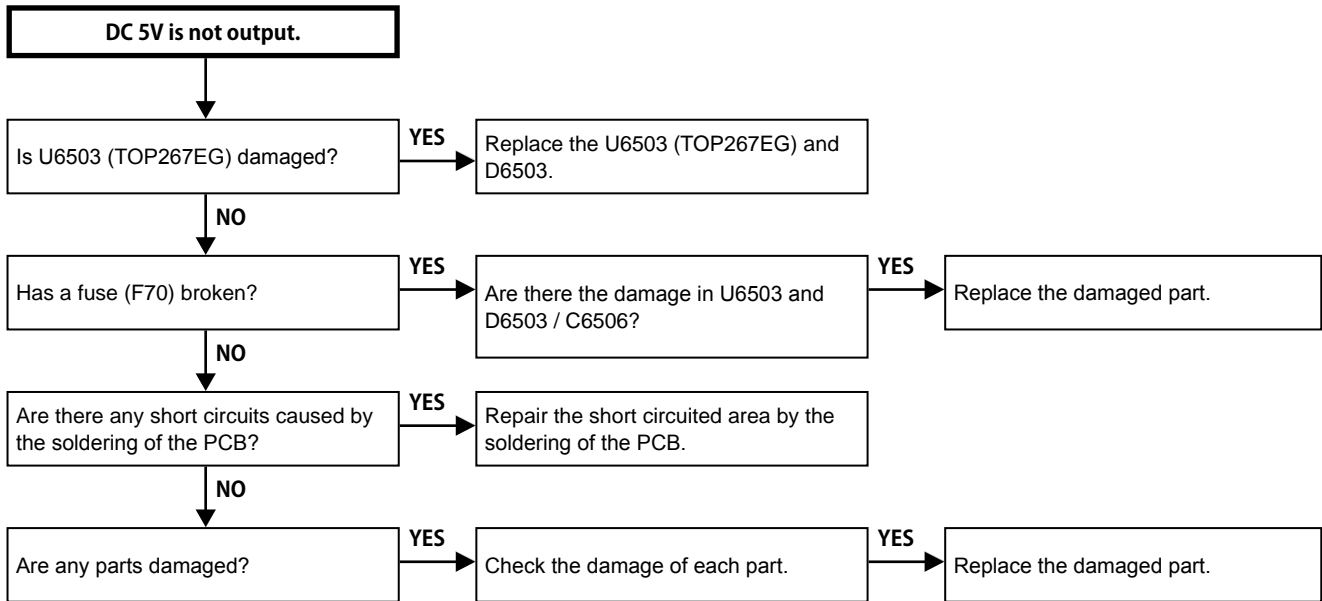

# Operation waveform for each part

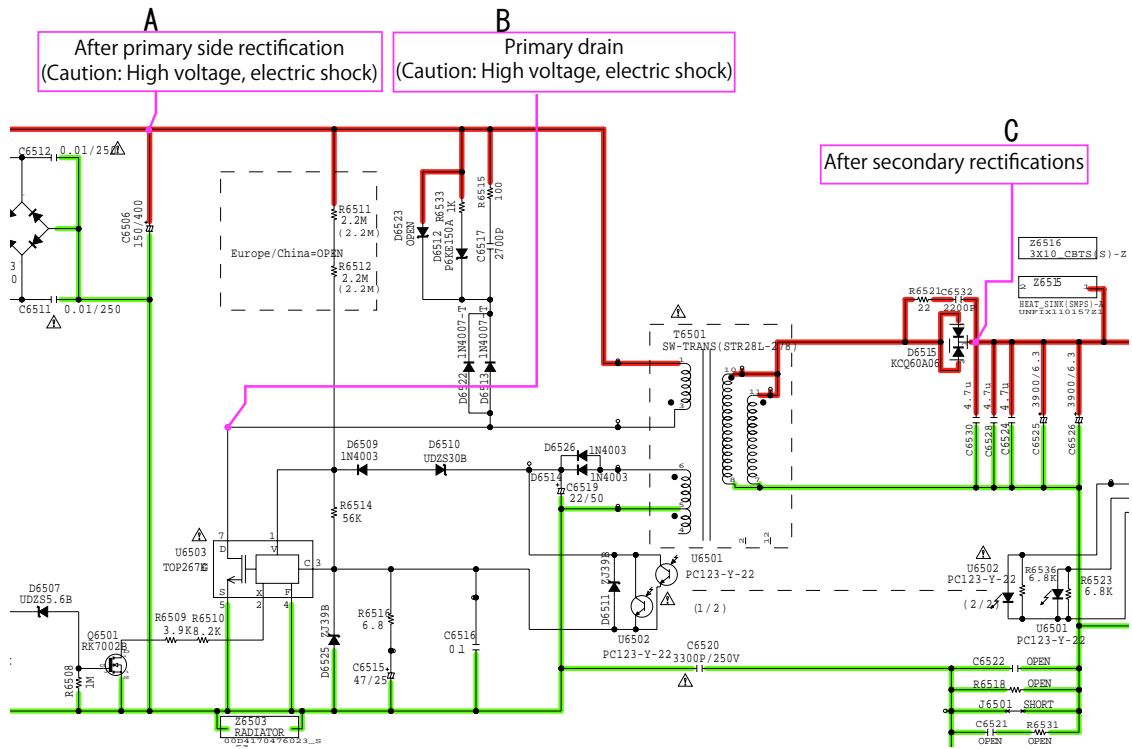

## SMPS unit (Unloaded)

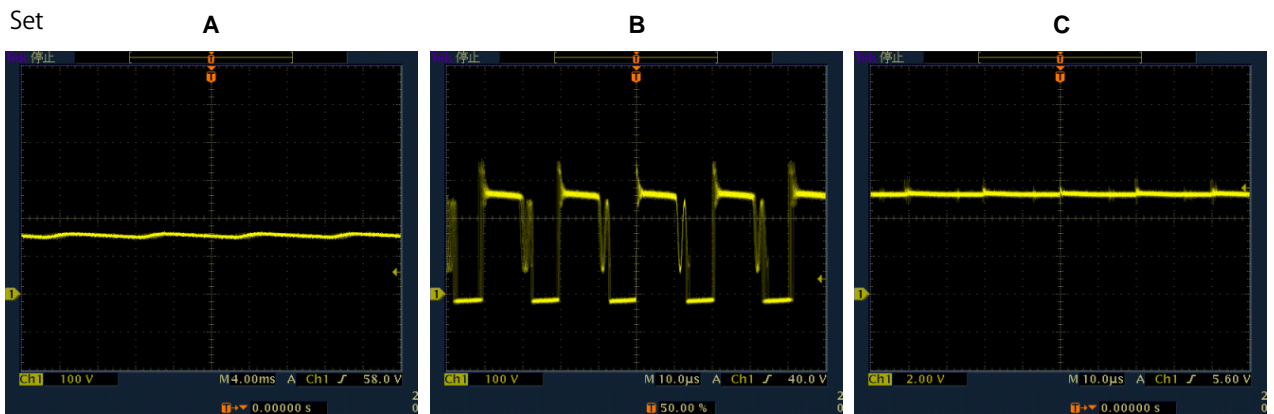
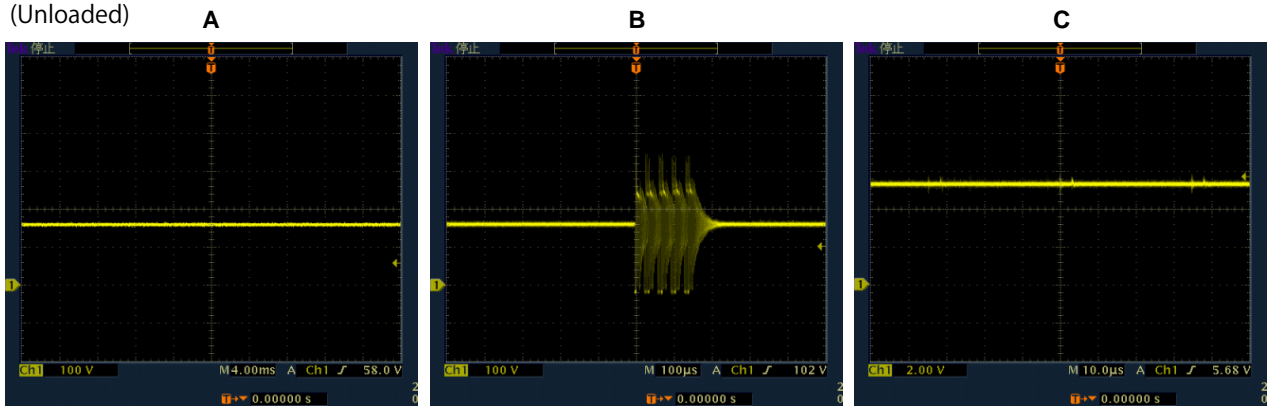

# AUDIO CHECK PASS

See troubleshooting "4.1. AUDIO CHECK"(104 page).

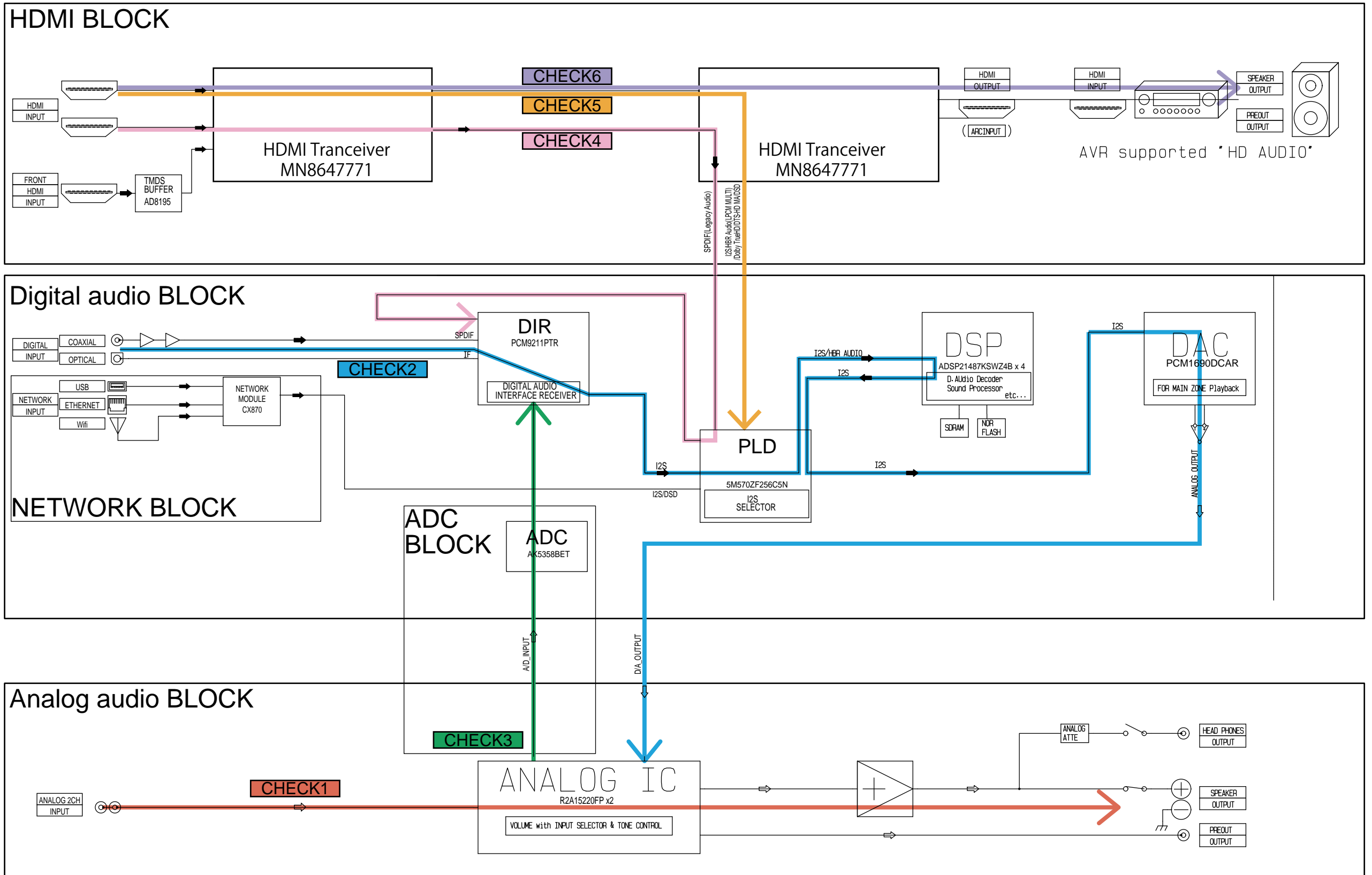
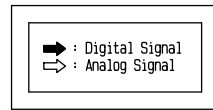



# CLOCK FLOW & WAVE FORM IN DIGITAL BLOCK

## WAVE FORM

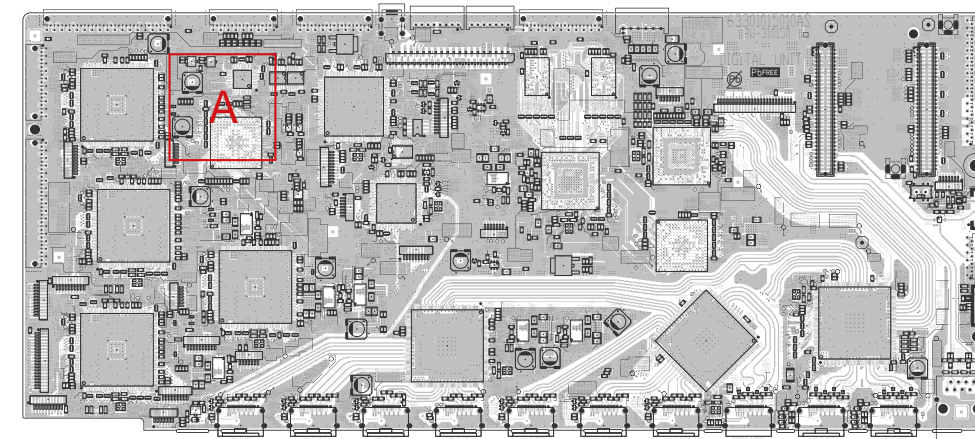
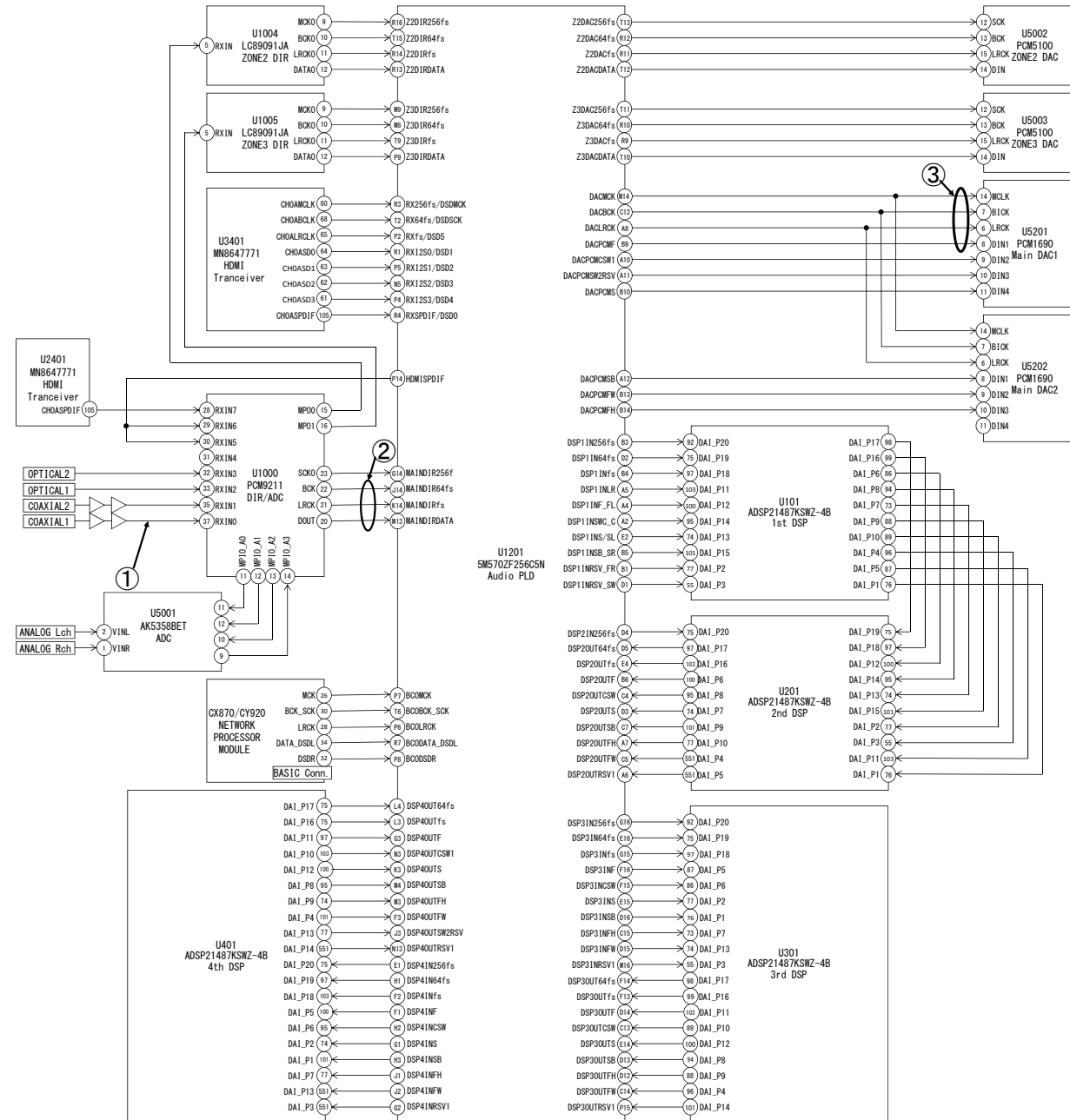
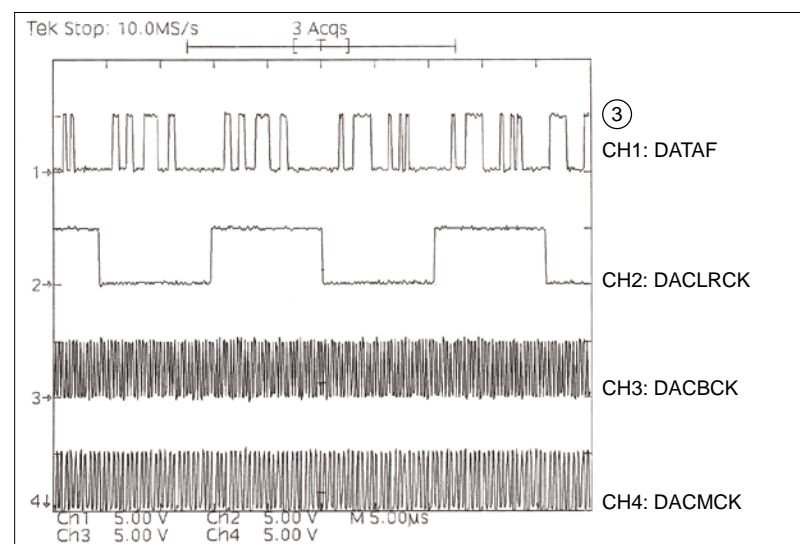
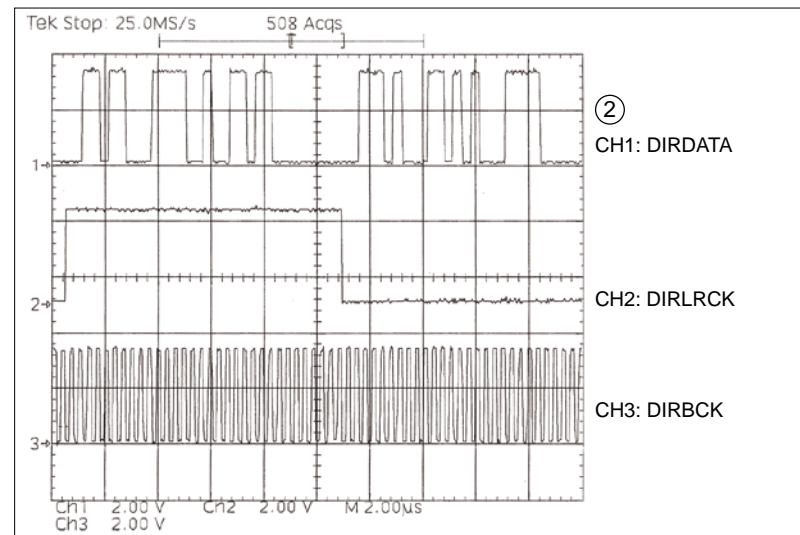
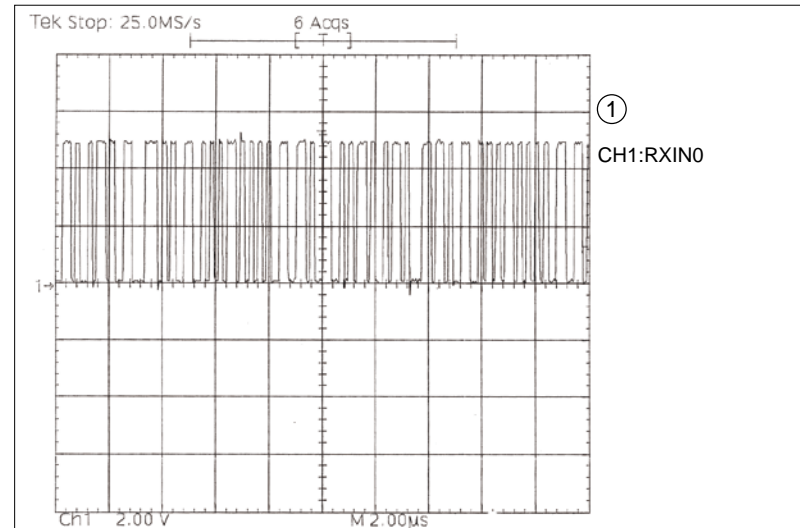

Detail A Aside

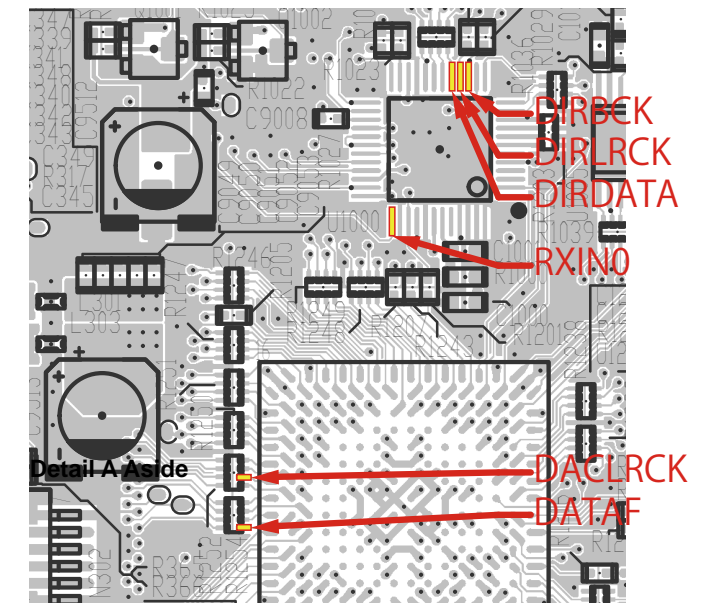

Detail A Bside

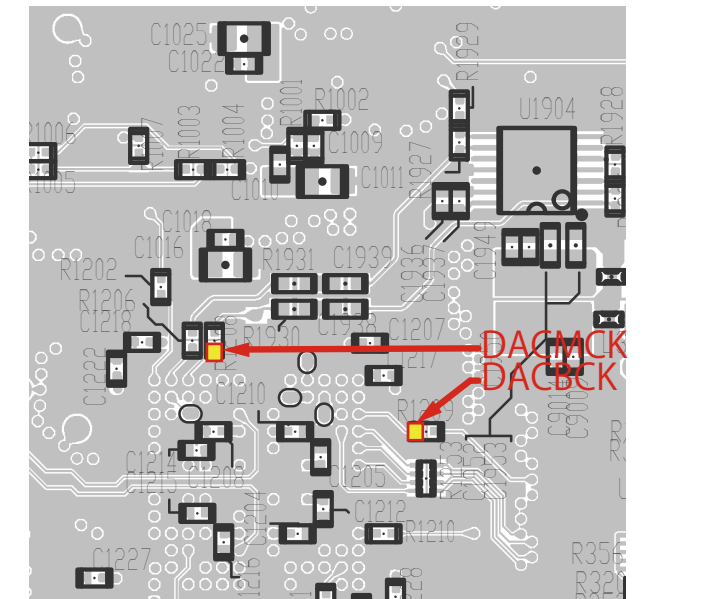

# LEVEL DIAGRAM

## AVR-X5200 LEVEL DIAGRAM FRONT ch

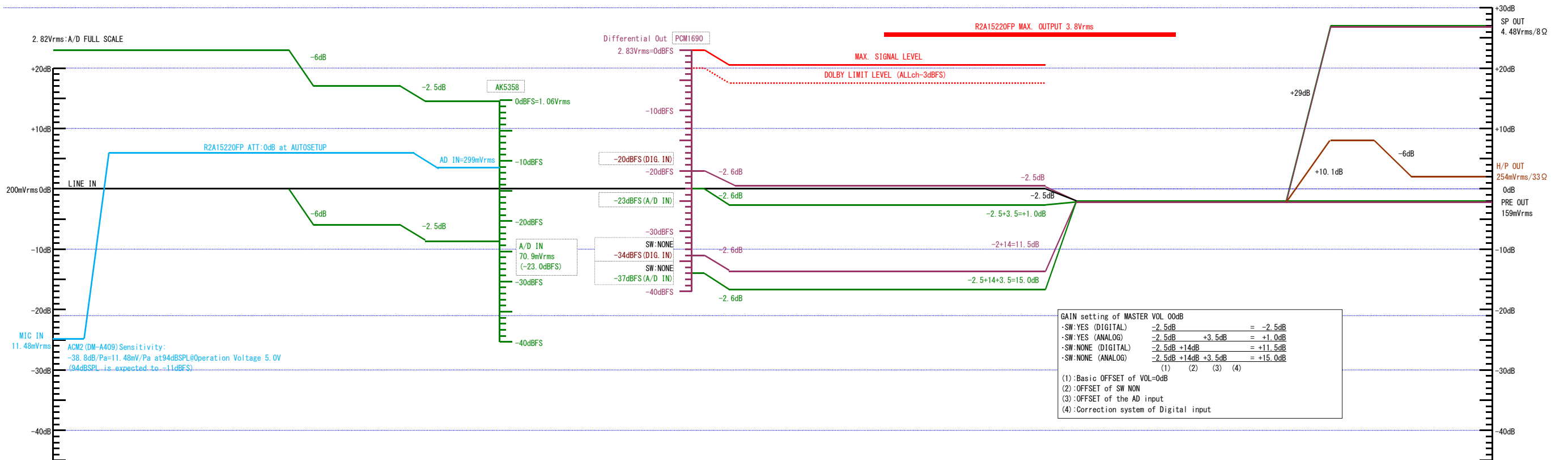
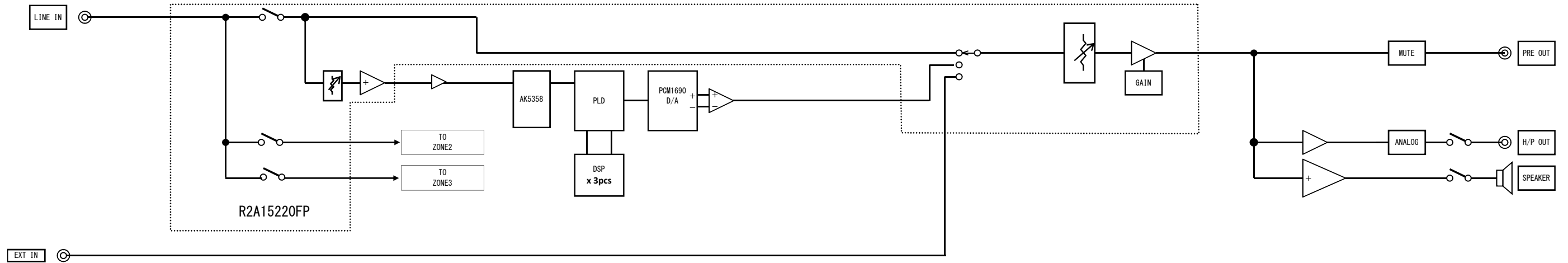

**AVR-X5200  
LEVEL DIAGRAM  
CENTER ch**

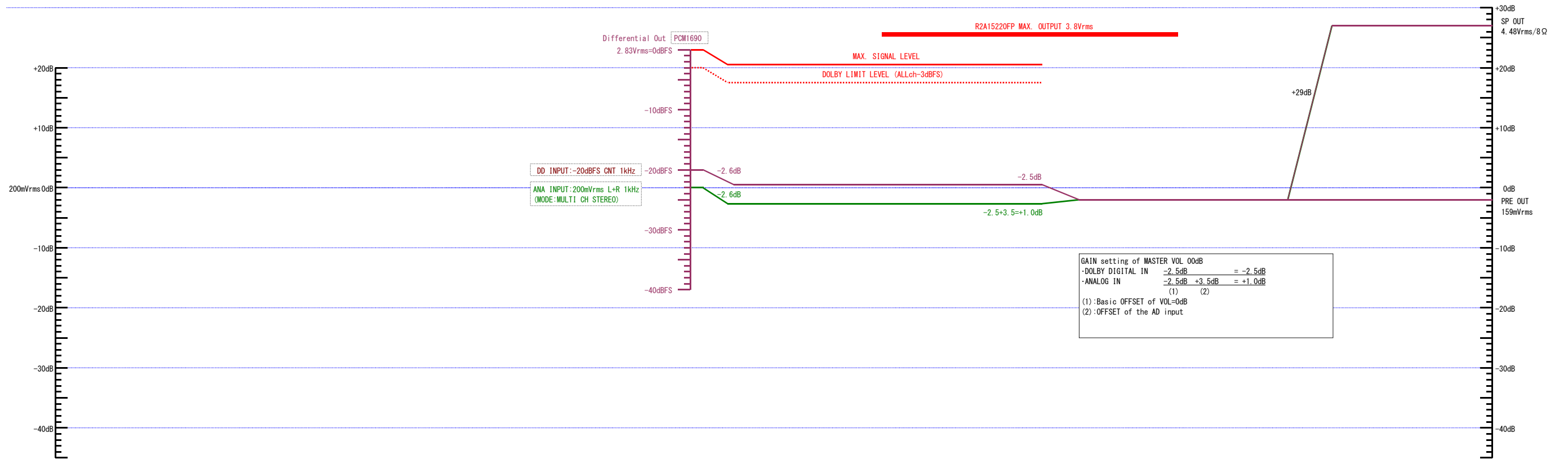
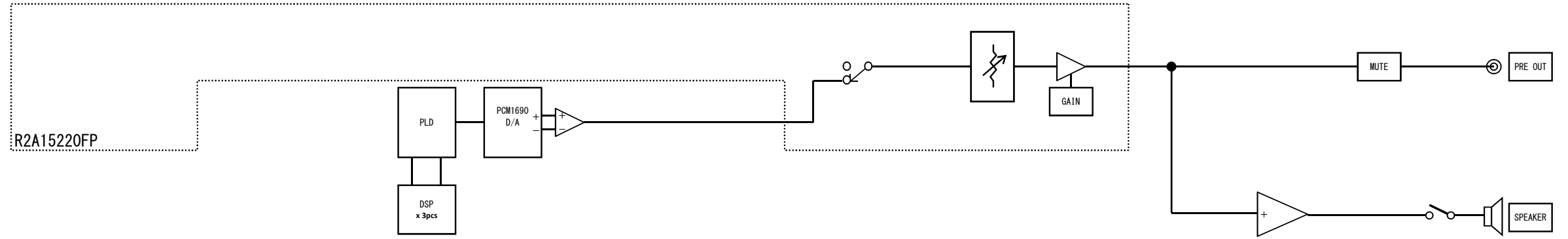

**AVR-X5200  
LEVEL DIAGRAM  
SUBWOOFER ch**

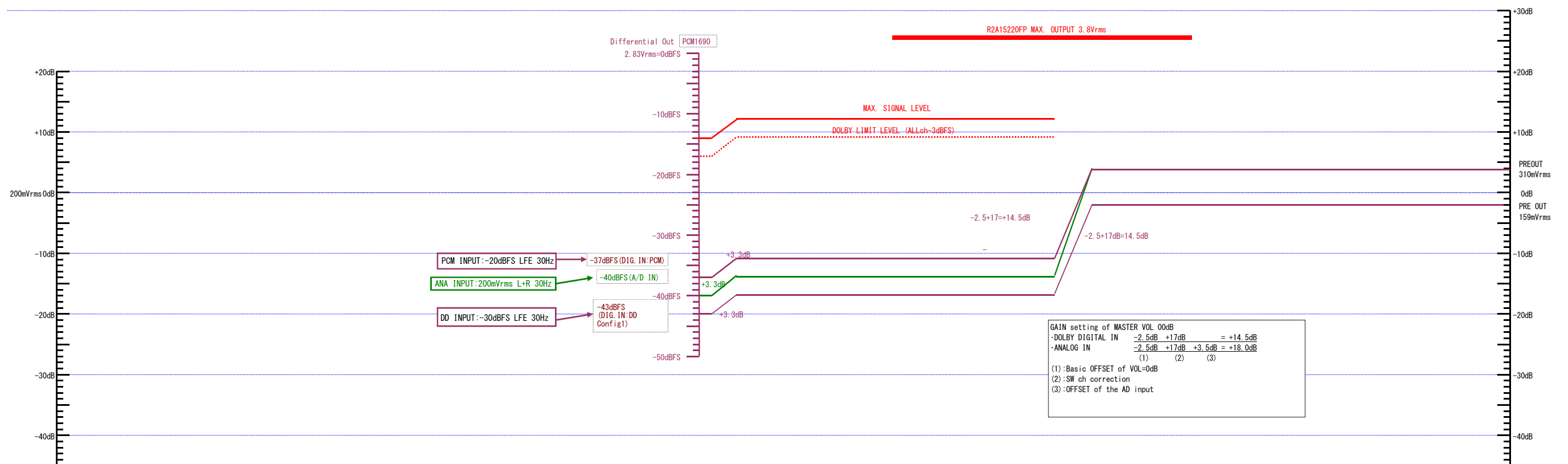
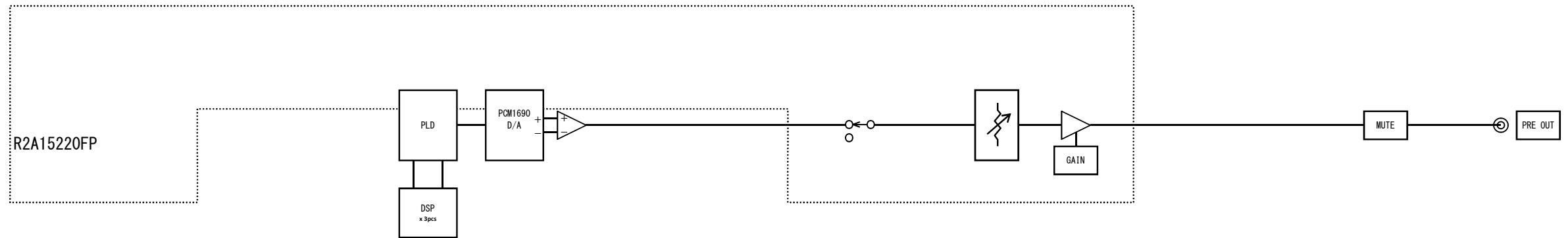



**AVR-X5200  
LEVEL DIAGRAM  
SURROUND ch**

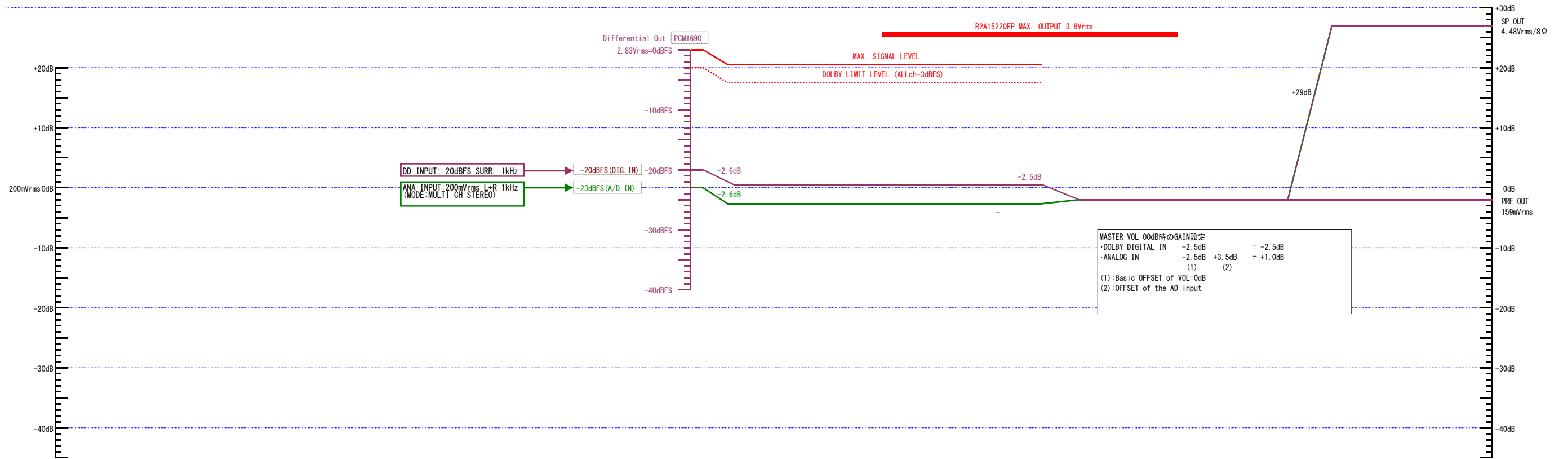
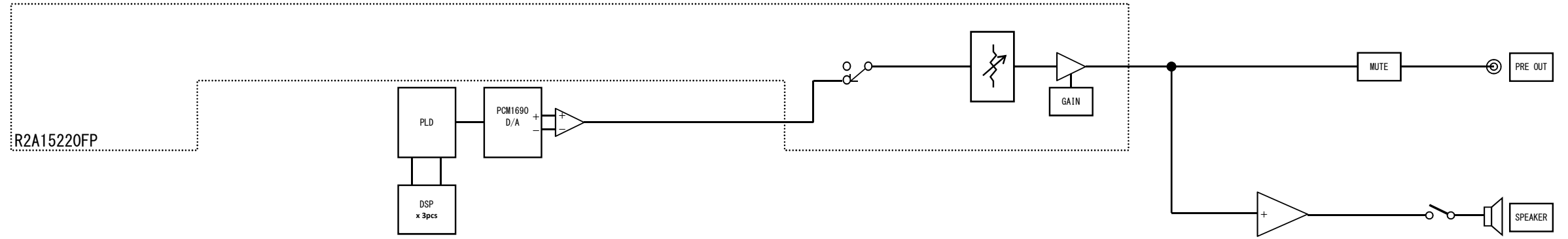

**AVR-X5200  
LEVEL DIAGRAM  
SURR.BACK ch**

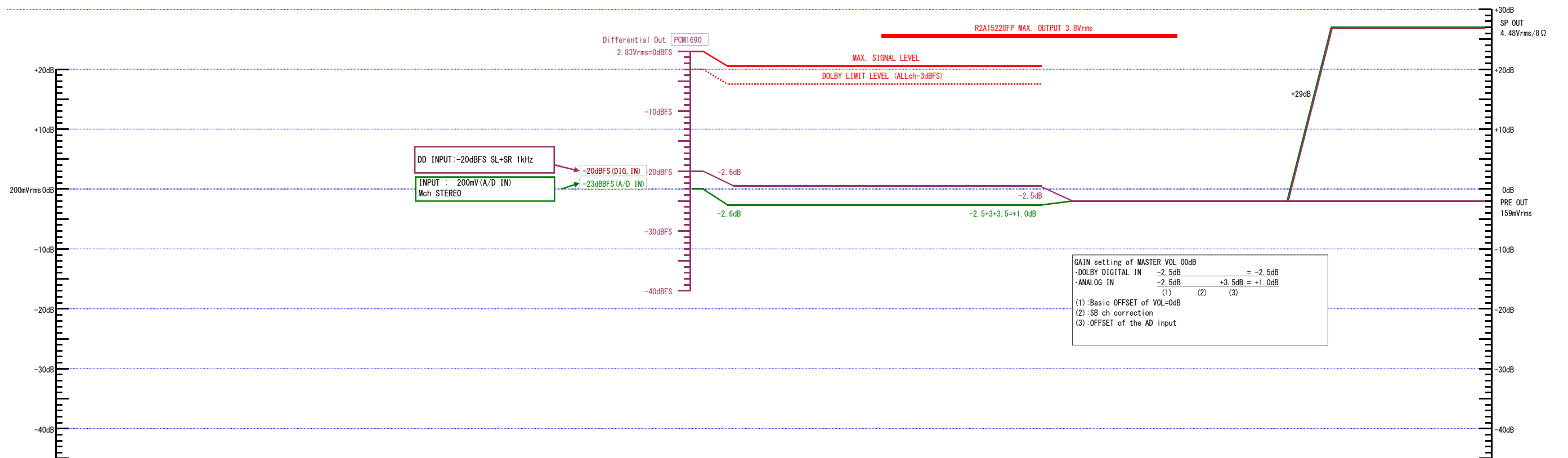
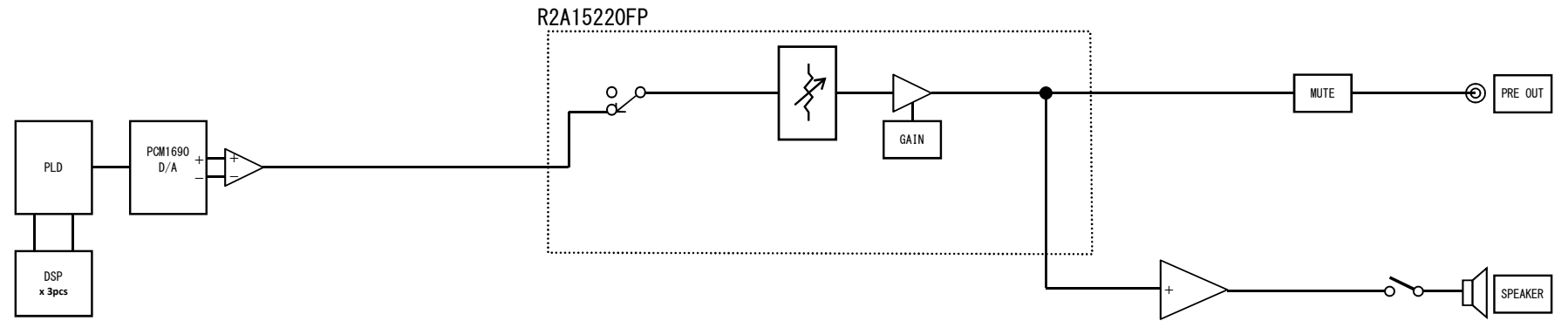

**AVR-X5200  
LEVEL DIAGRAM  
FRONT WIDE ch**

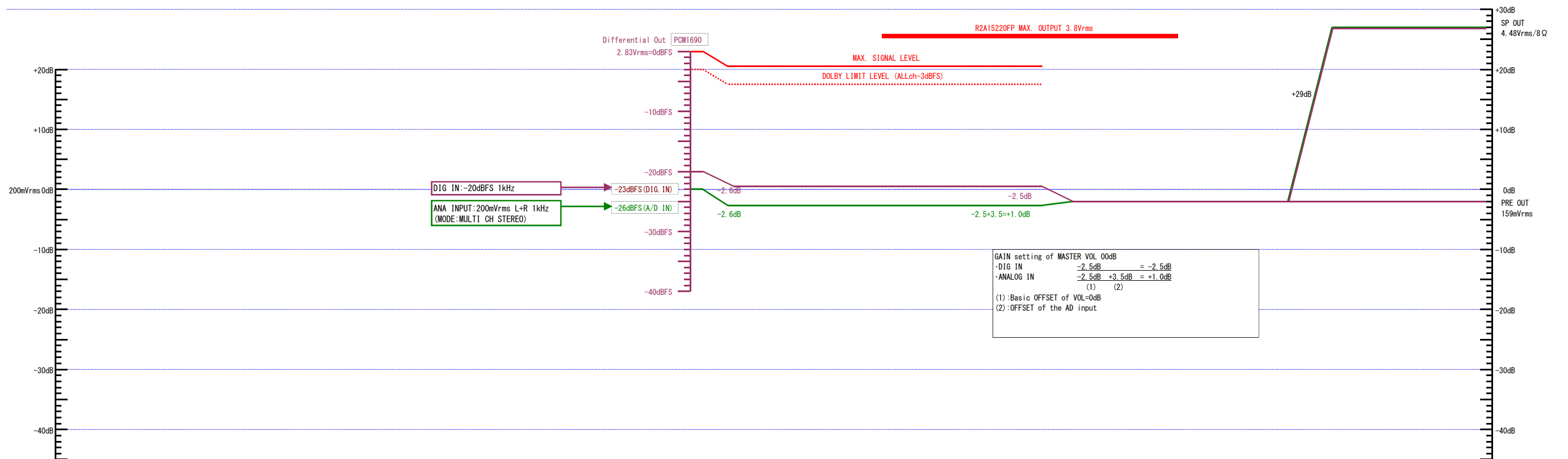
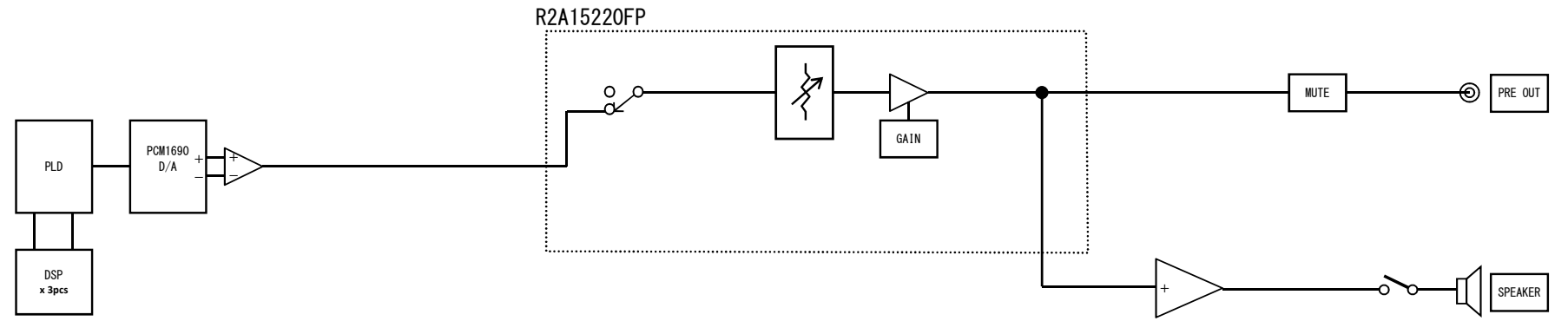

**AVR-X5200  
LEVEL DIAGRAM  
HEIGHT1,2 ch**

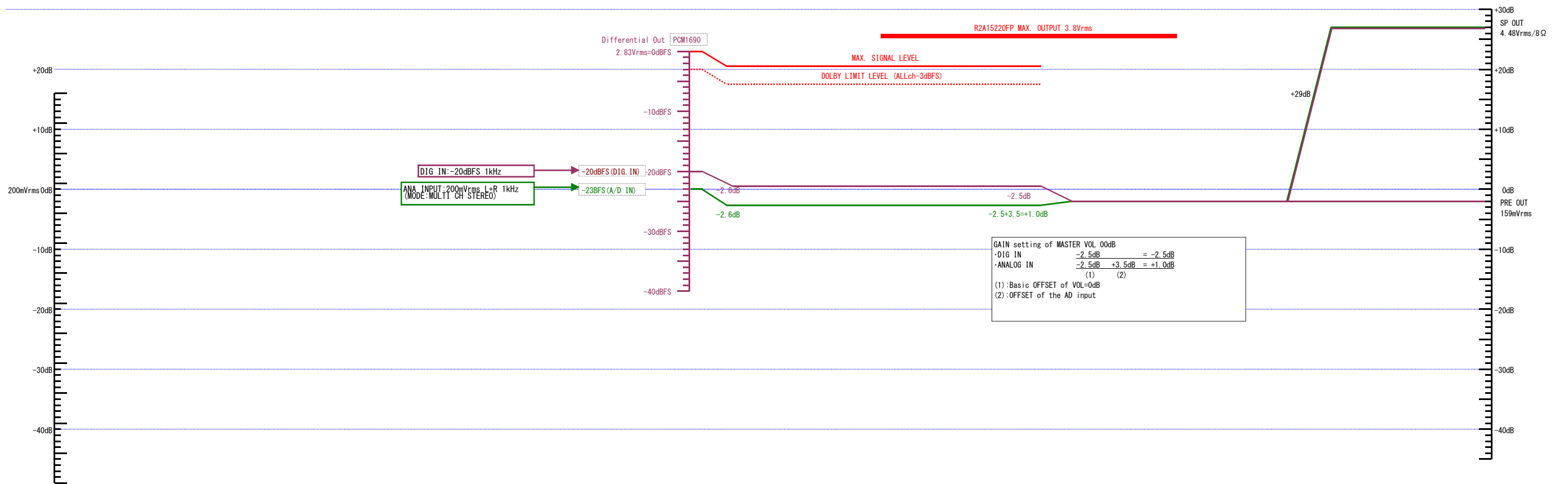
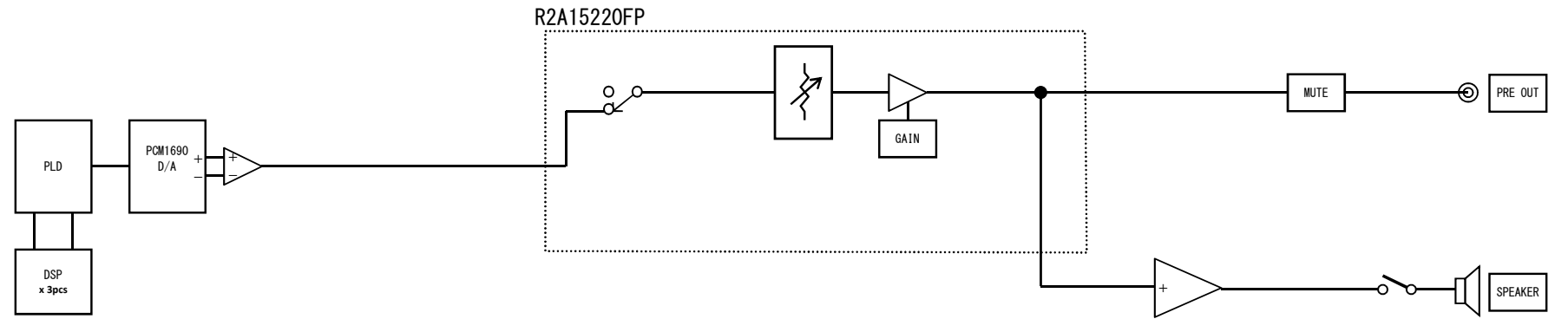

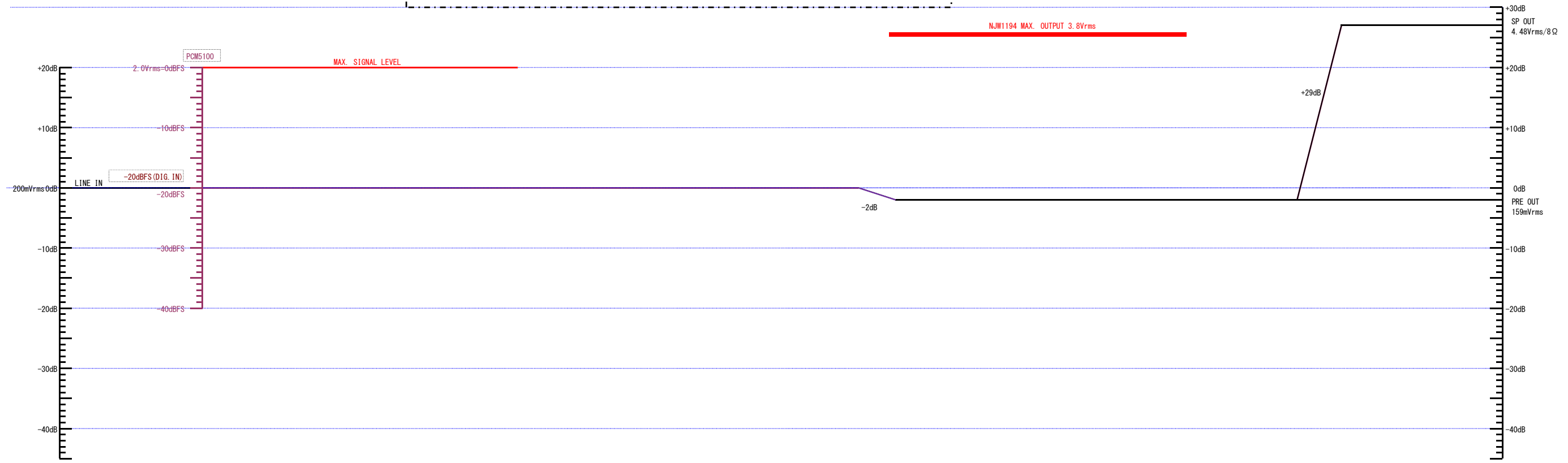
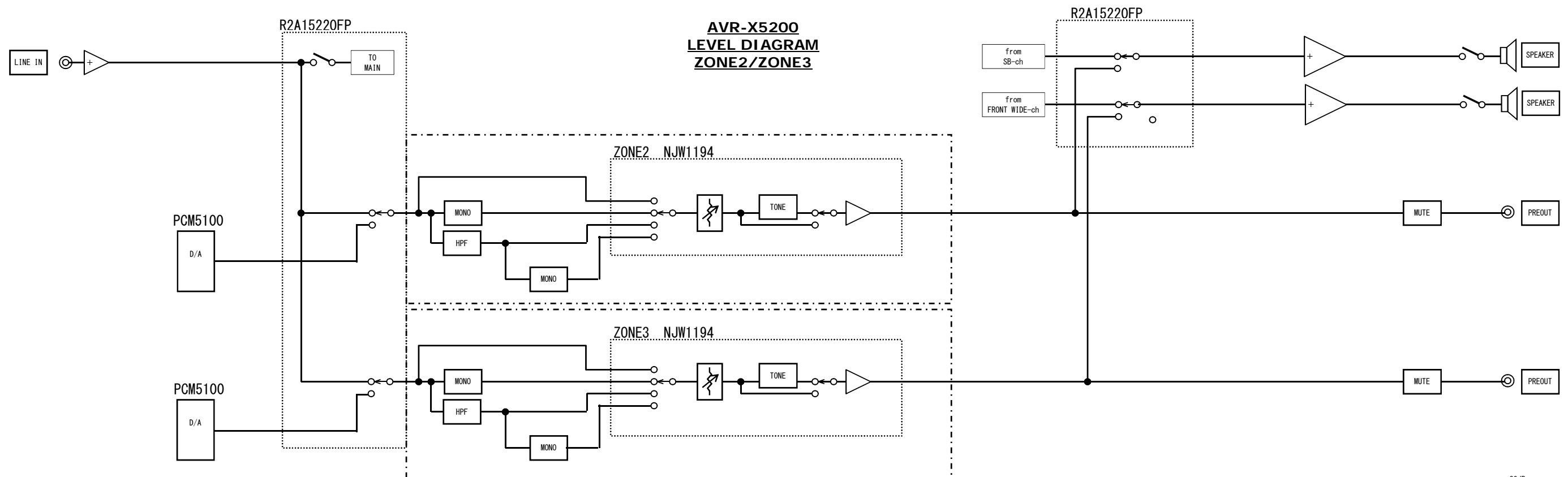

# GND DIAGRAM

## AVR-X5200/7200 GND DIAGRAM

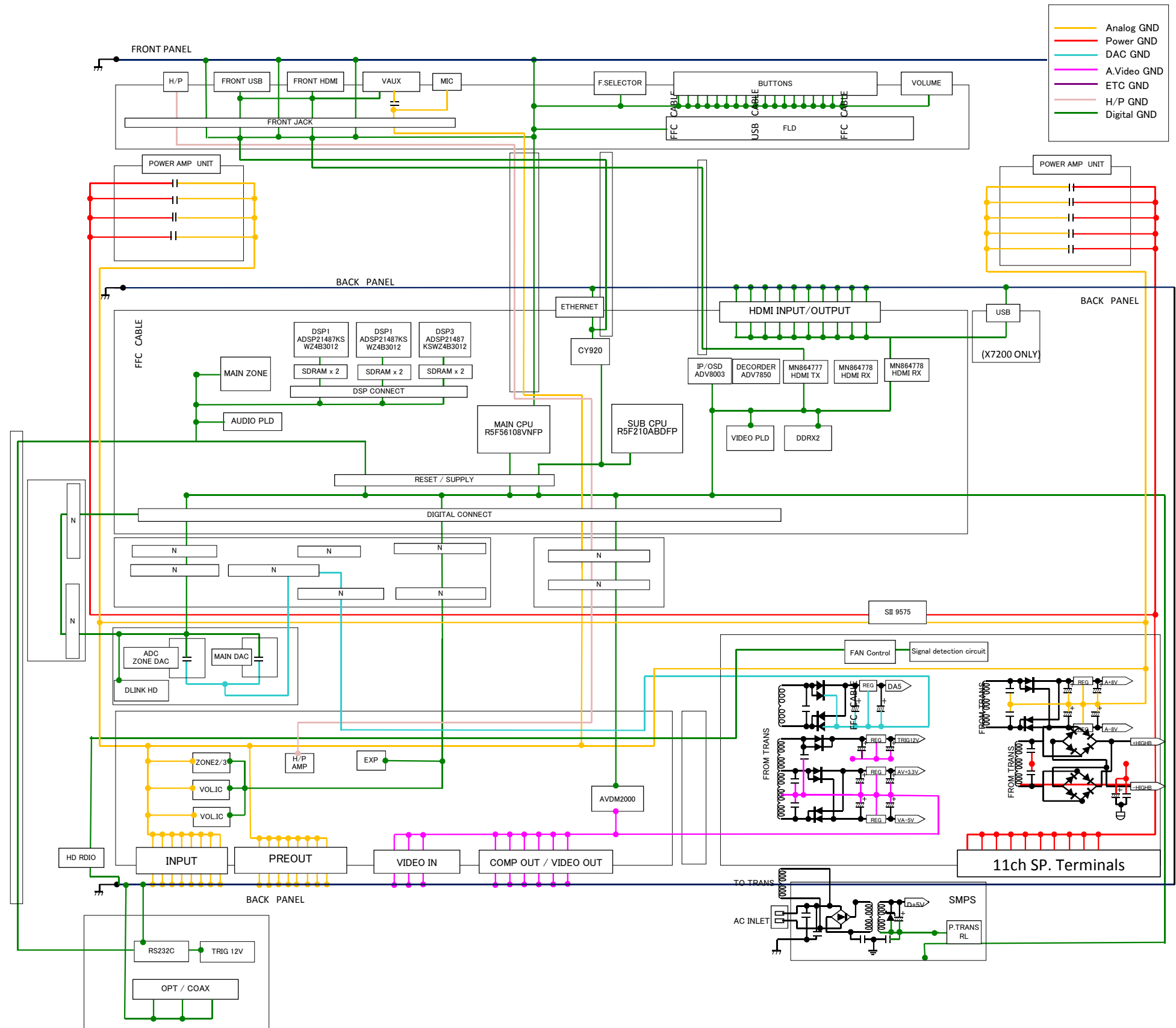

# POWER DIAGRAM

## AVR-X5200 BLOCK DIAGRAM (P.SUPPLY)

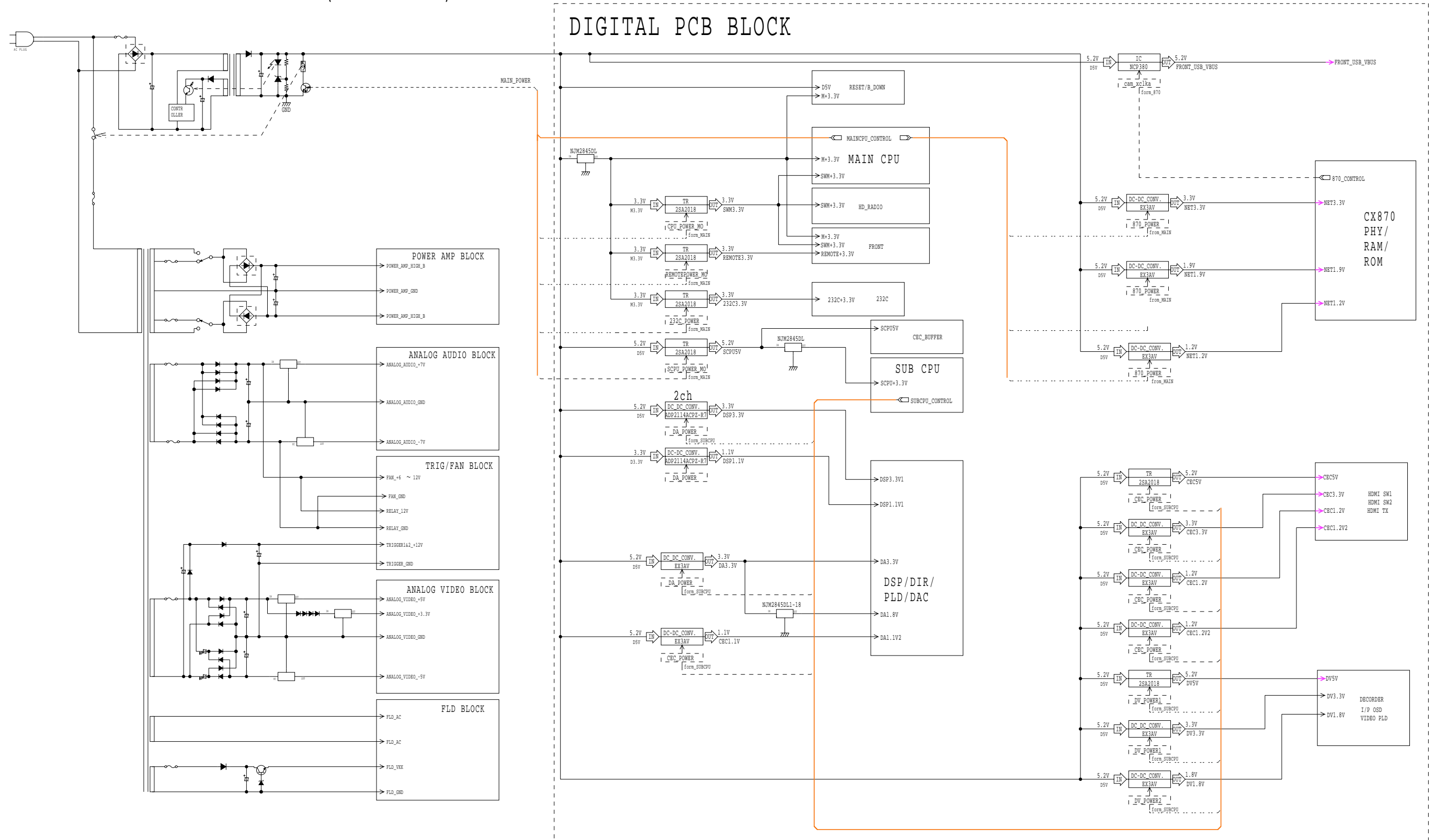

# CPU DIAGRAM

AVRX5200/X7200/AV8802 CPU Control Block Diagram

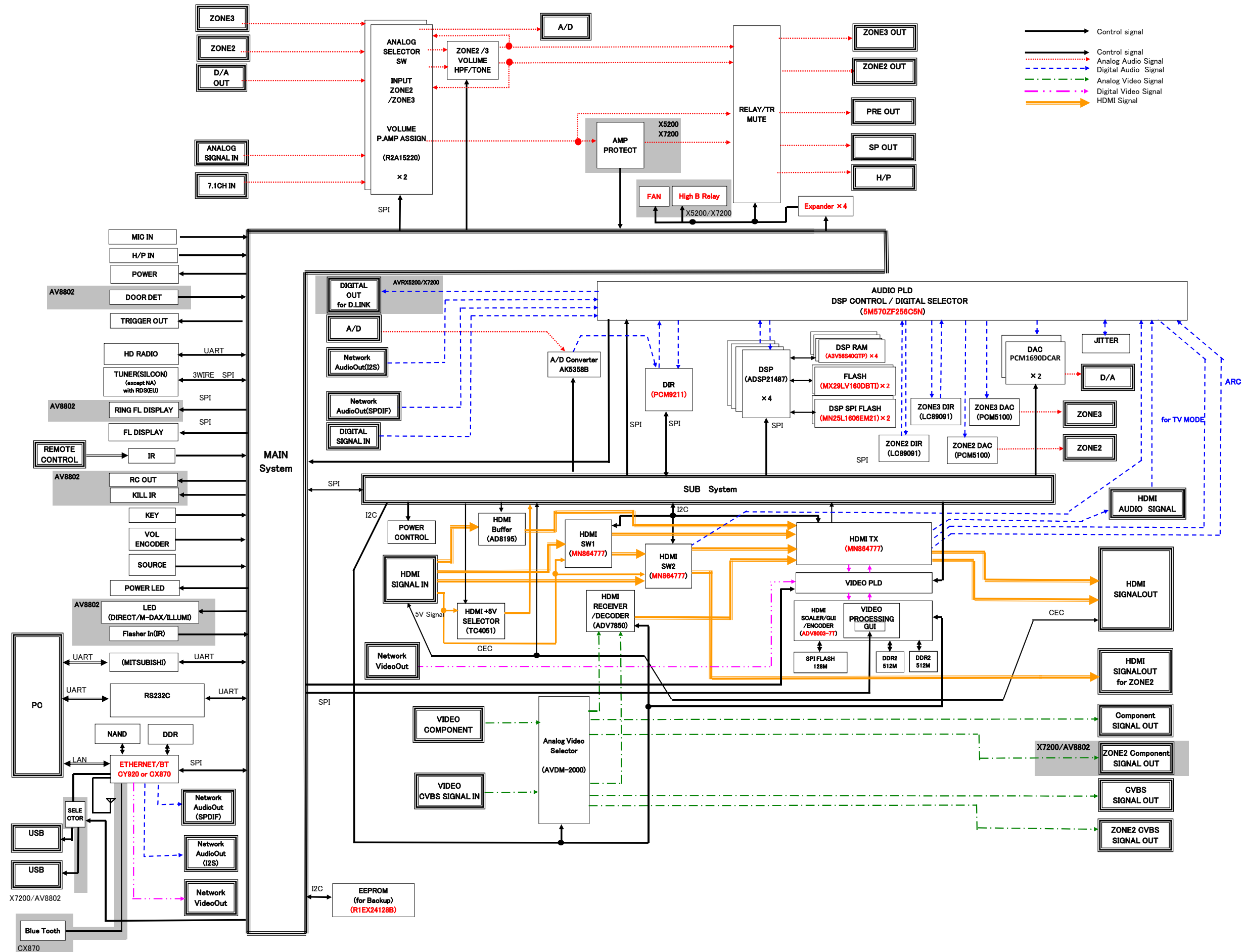



# PRINTED WIRING BOARDS

**Lead-free Solder**  
When soldering, use the Lead-free Solder (Sn-Ag-Cu).

### DIGITAL (A SIDE)

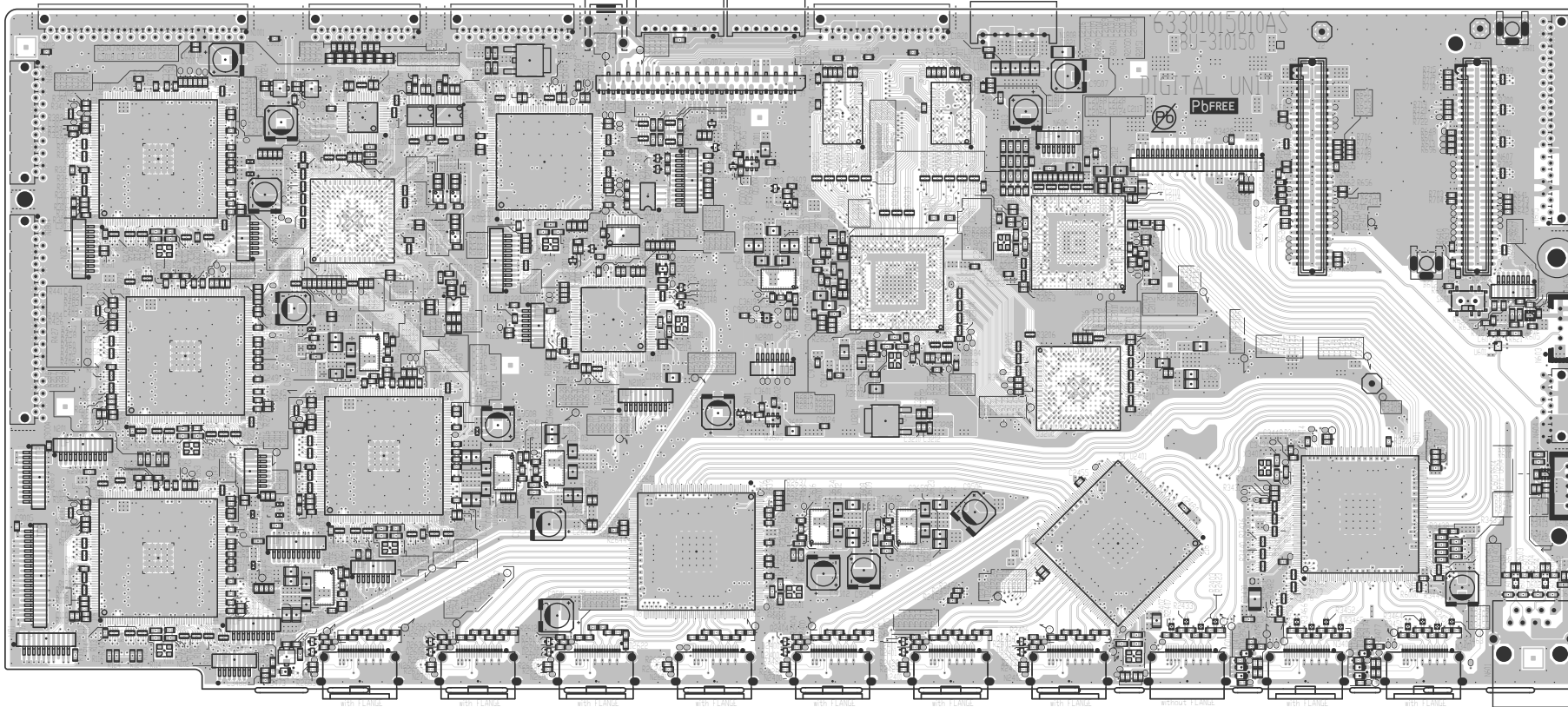

### DAC (A SIDE)

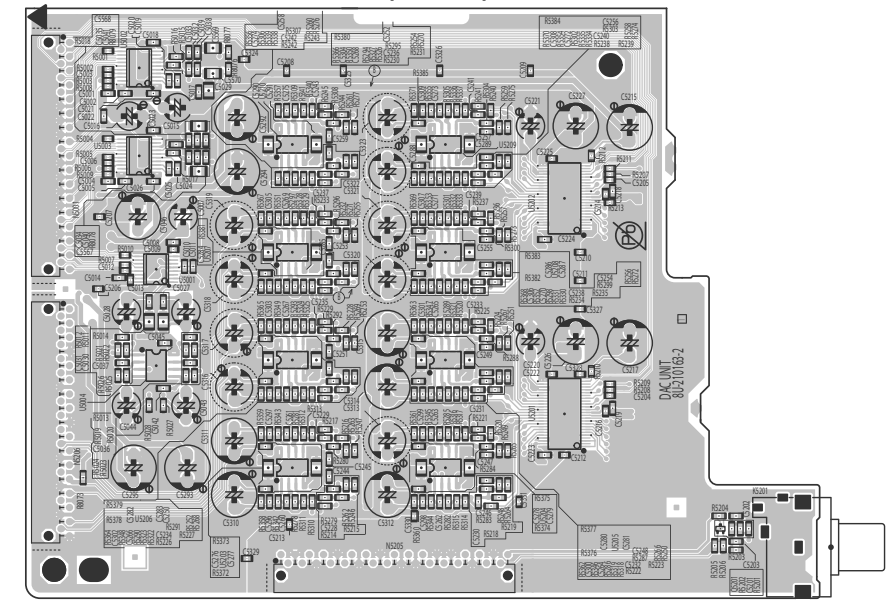

### DAC (B SIDE)

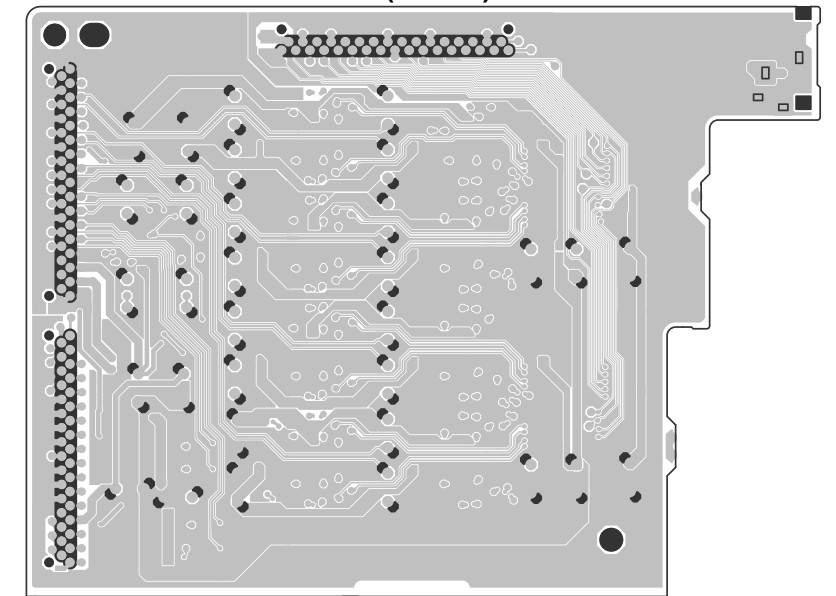

### DIGITAL (B SIDE)

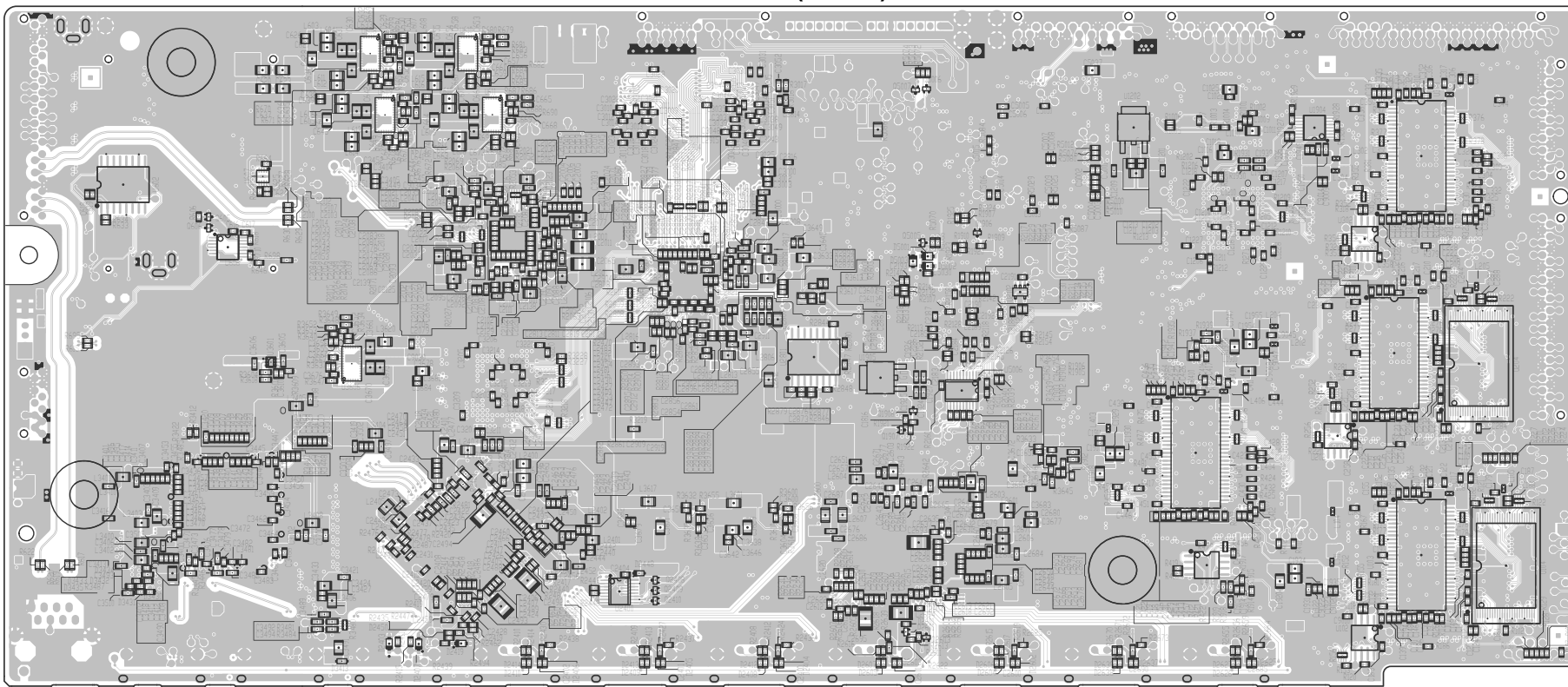

### HDMI USB FRONT (A SIDE)

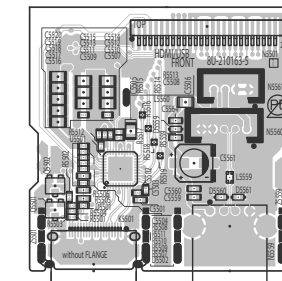

### HDMI USB FRONT (B SIDE)

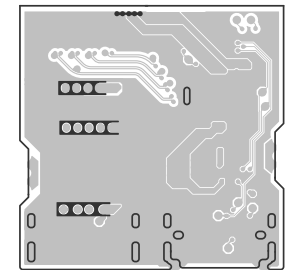

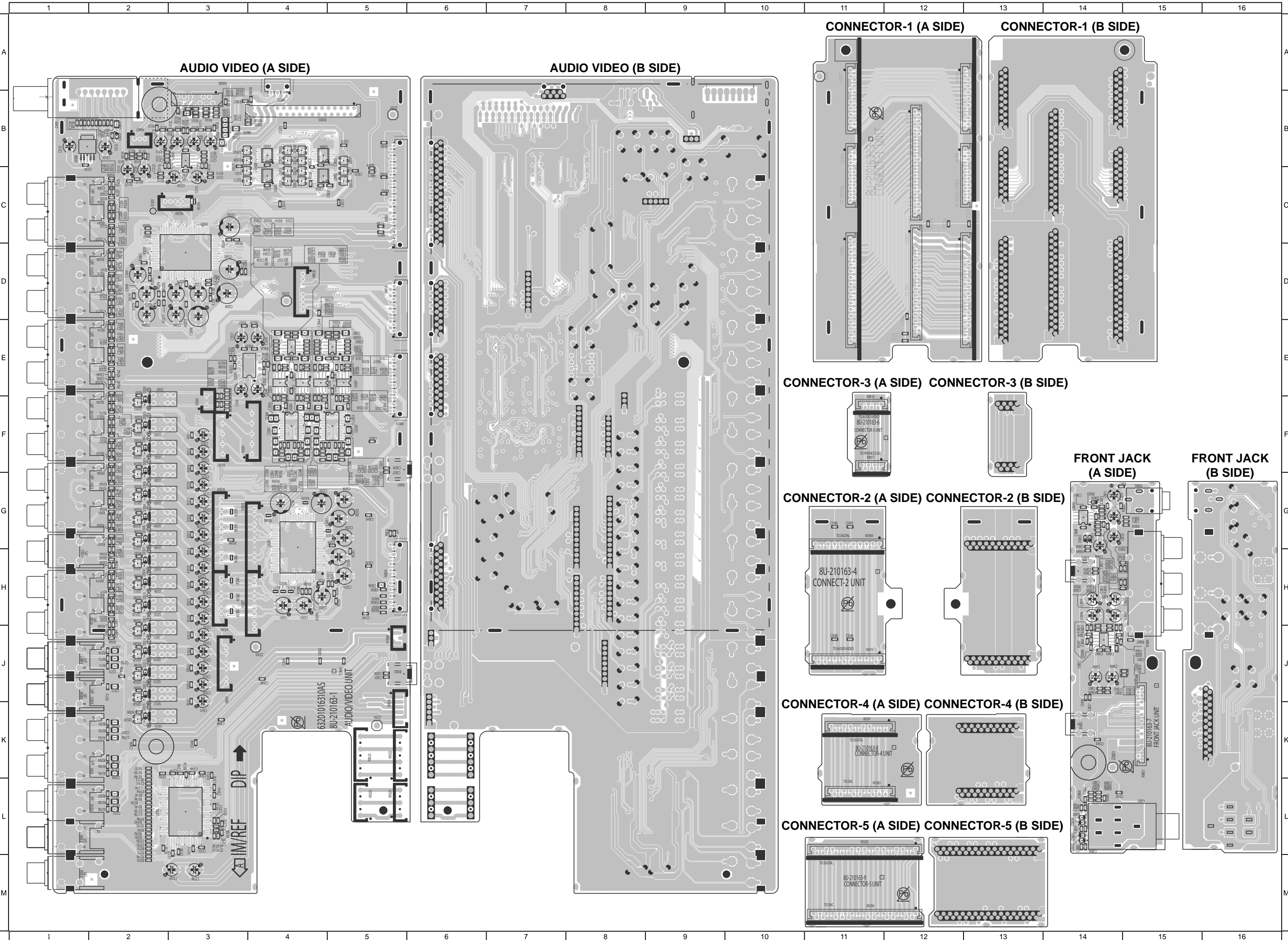

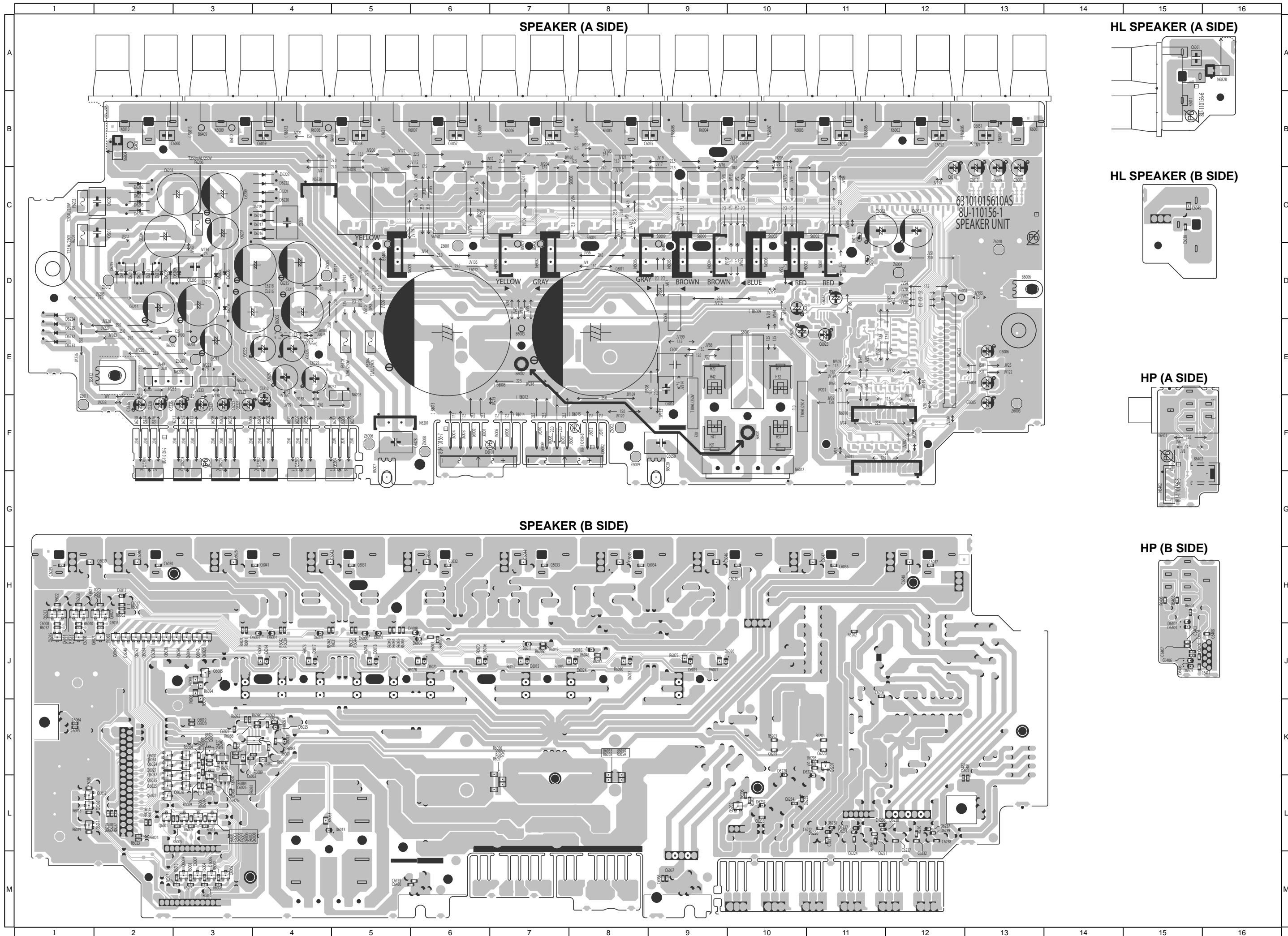

**SPEAKER (A SIDE)**

**HL SPEAKER (A SIDE)**

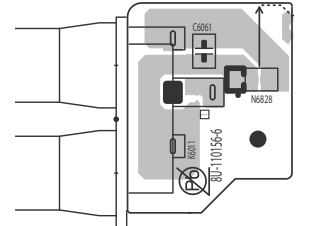

**HL SPEAKER (B SIDE)**

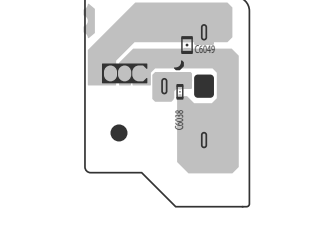

**HP (A SIDE)**

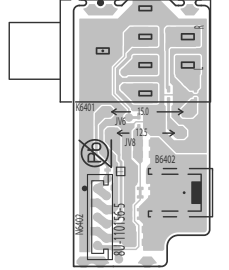

**HP (B SIDE)**

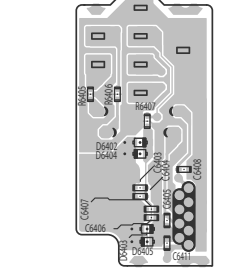

**SPEAKER (B SIDE)**

63101015610AS  
8U-110156-1  
SPEAKER UNIT

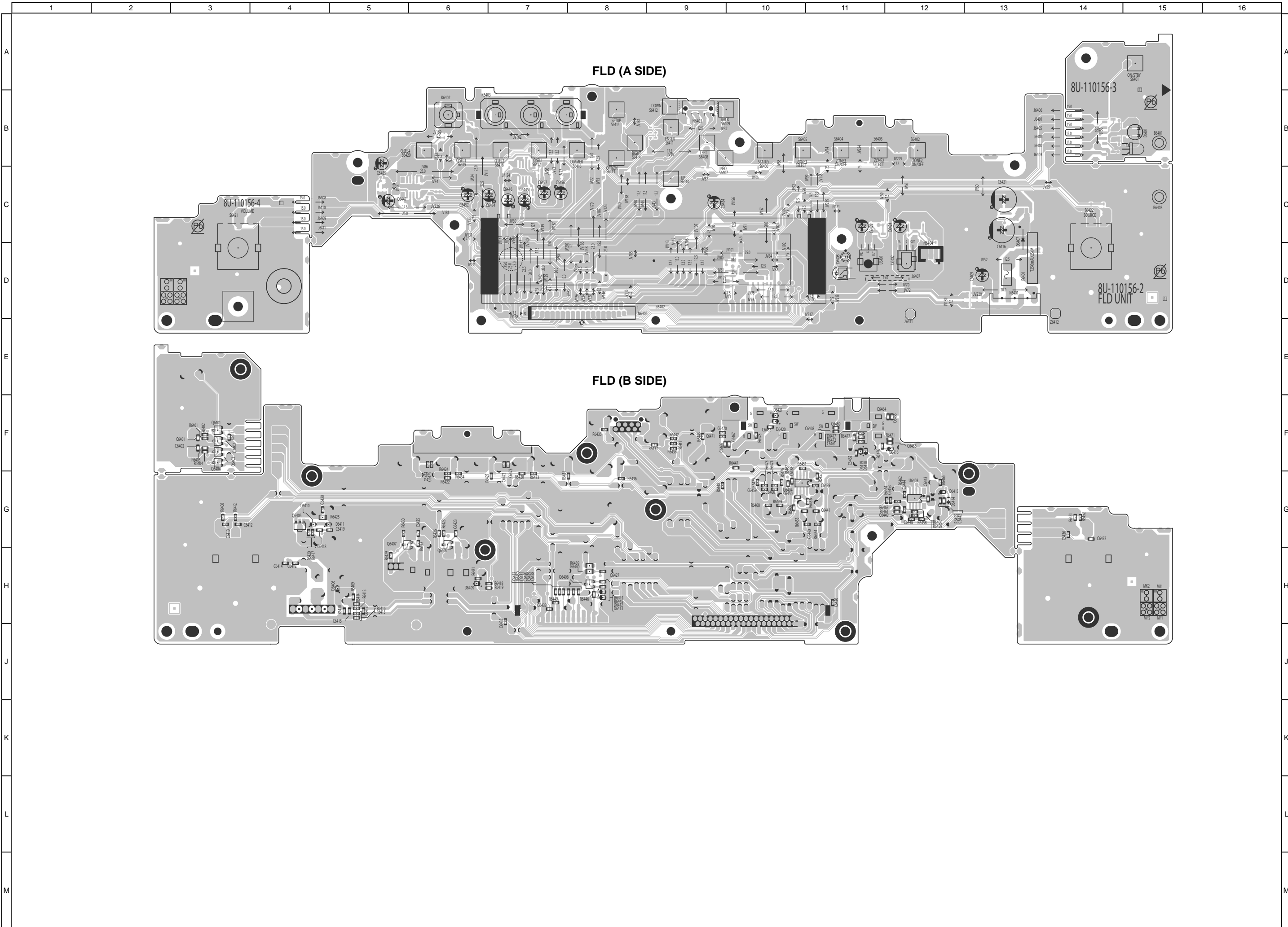

**FLD (A SIDE)**

**FLD (B SIDE)**

8U-110156-4  
VOL/LINE

8U-110156-3  
ON/STBY  
56401

8U-110156-2  
FLD UNIT

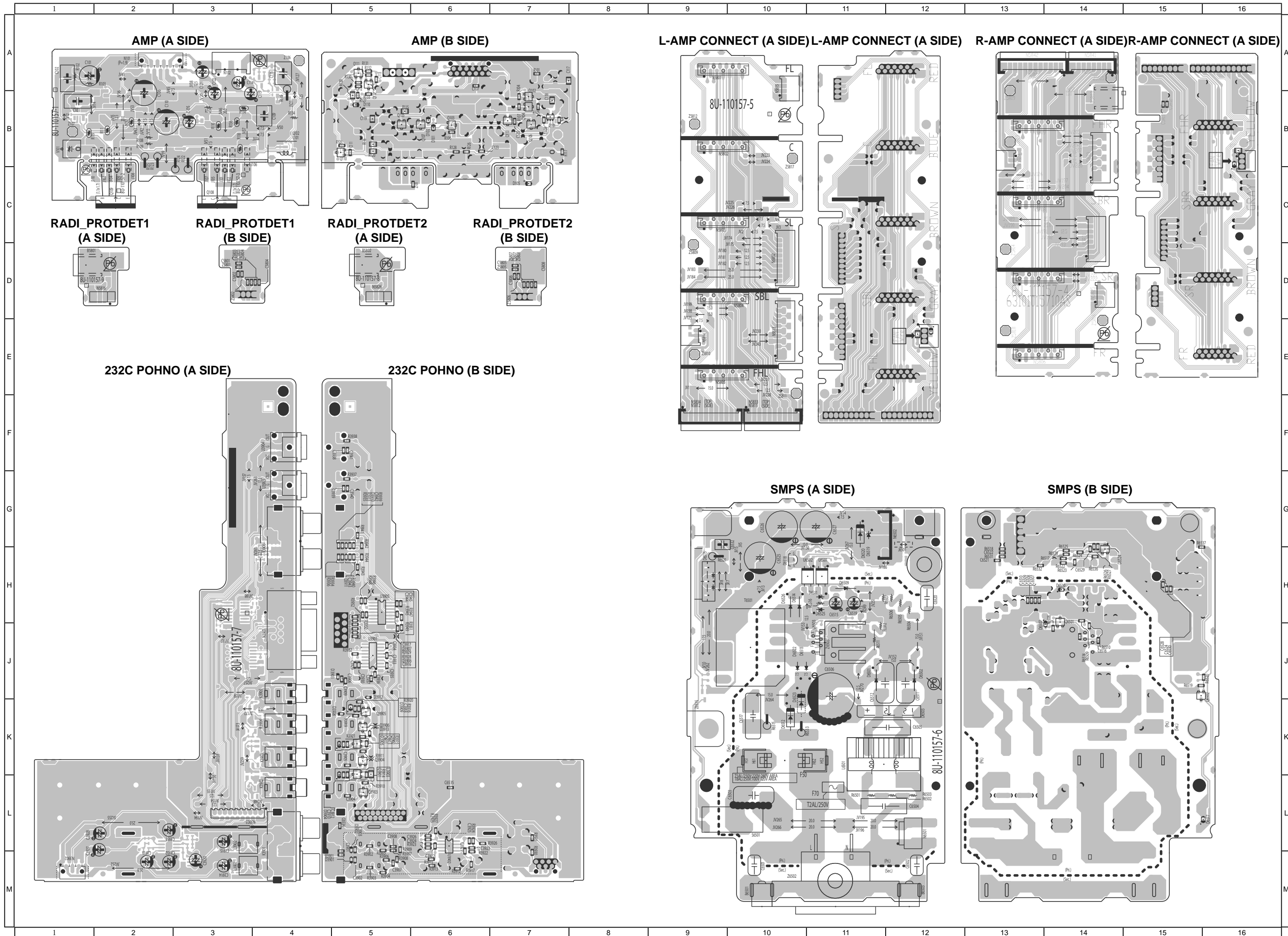

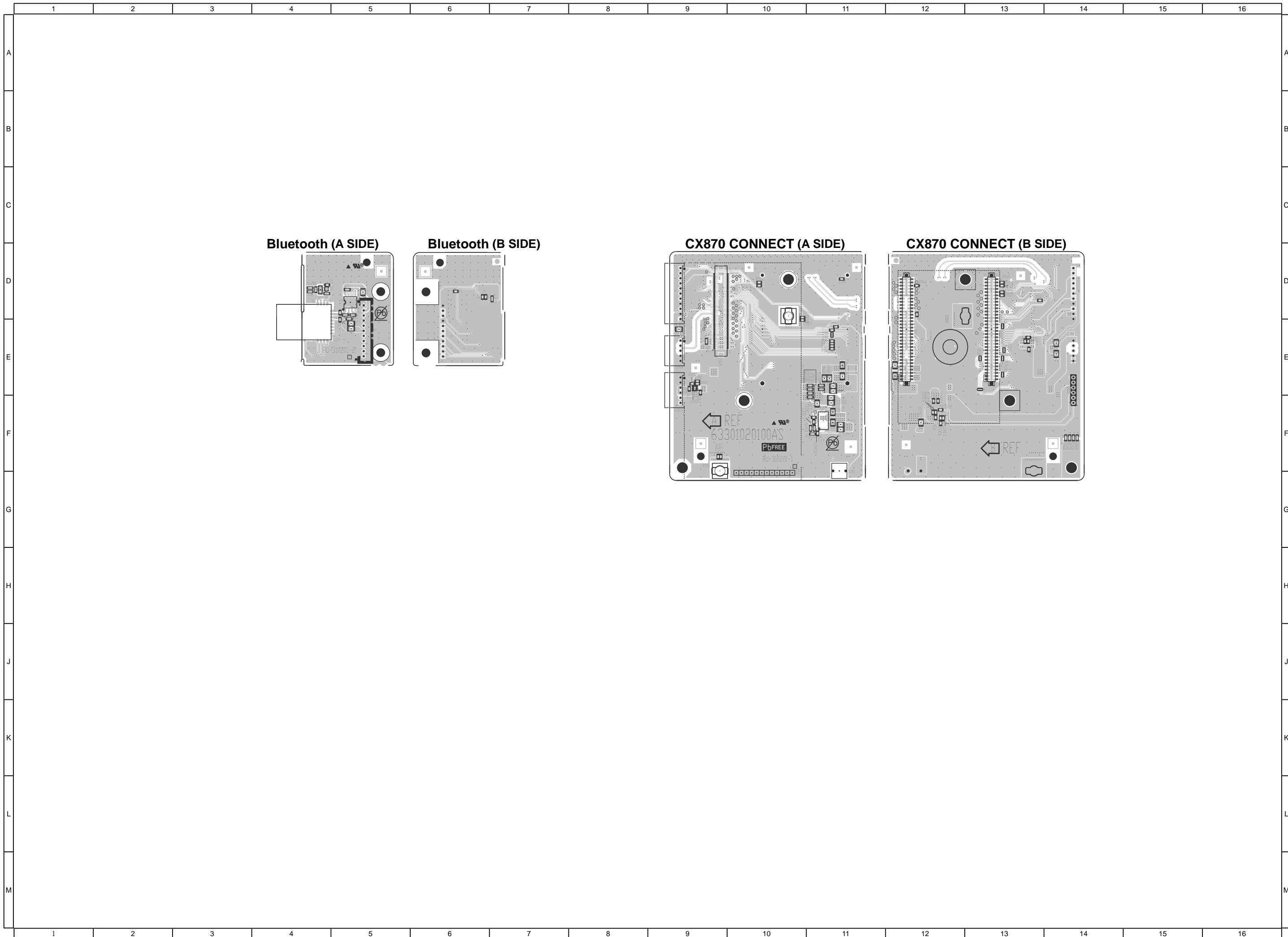

**Bluetooth (A SIDE)**      **Bluetooth (B SIDE)**

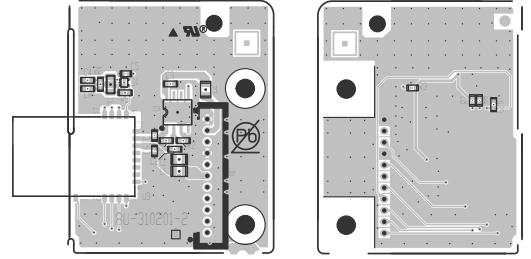

**CX870 CONNECT (A SIDE)**      **CX870 CONNECT (B SIDE)**

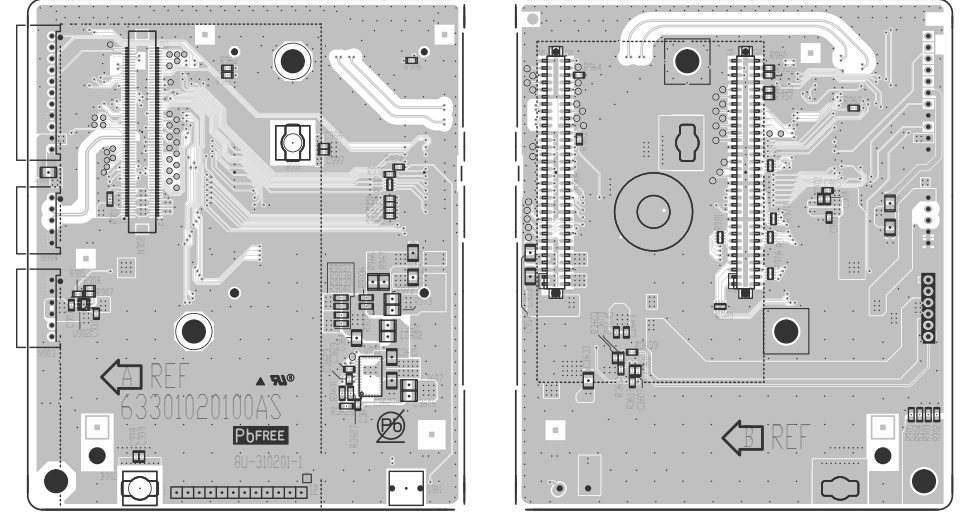



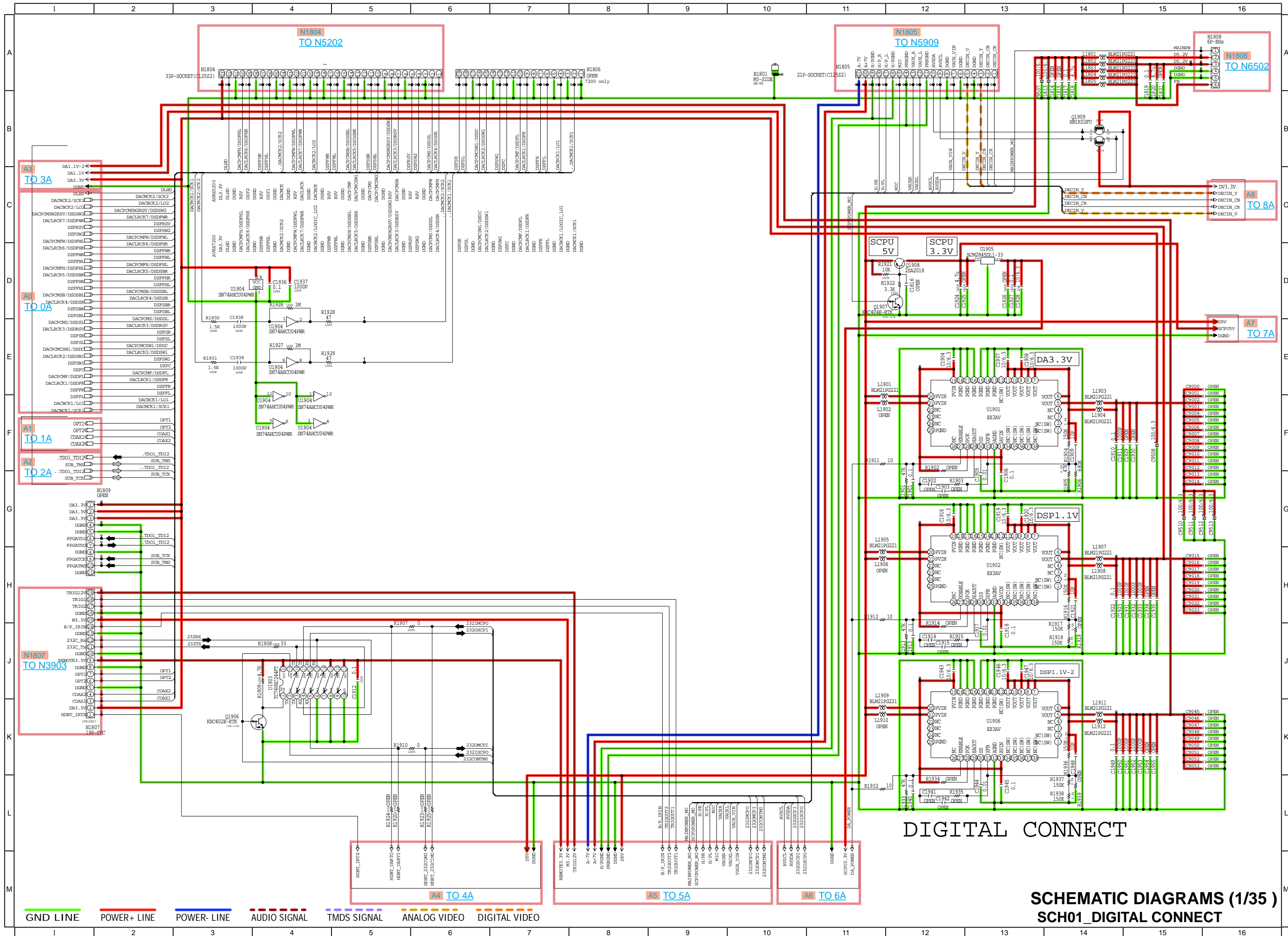

DIGITAL CONNECT

**SCHEMATIC DIAGRAMS (1/35)**  
**SCH01\_DIGITAL\_CONNECT**

— GND LINE  
— POWER+ LINE  
— POWER- LINE  
— AUDIO SIGNAL  
— TMDS SIGNAL  
— ANALOG VIDEO  
— DIGITAL VIDEO









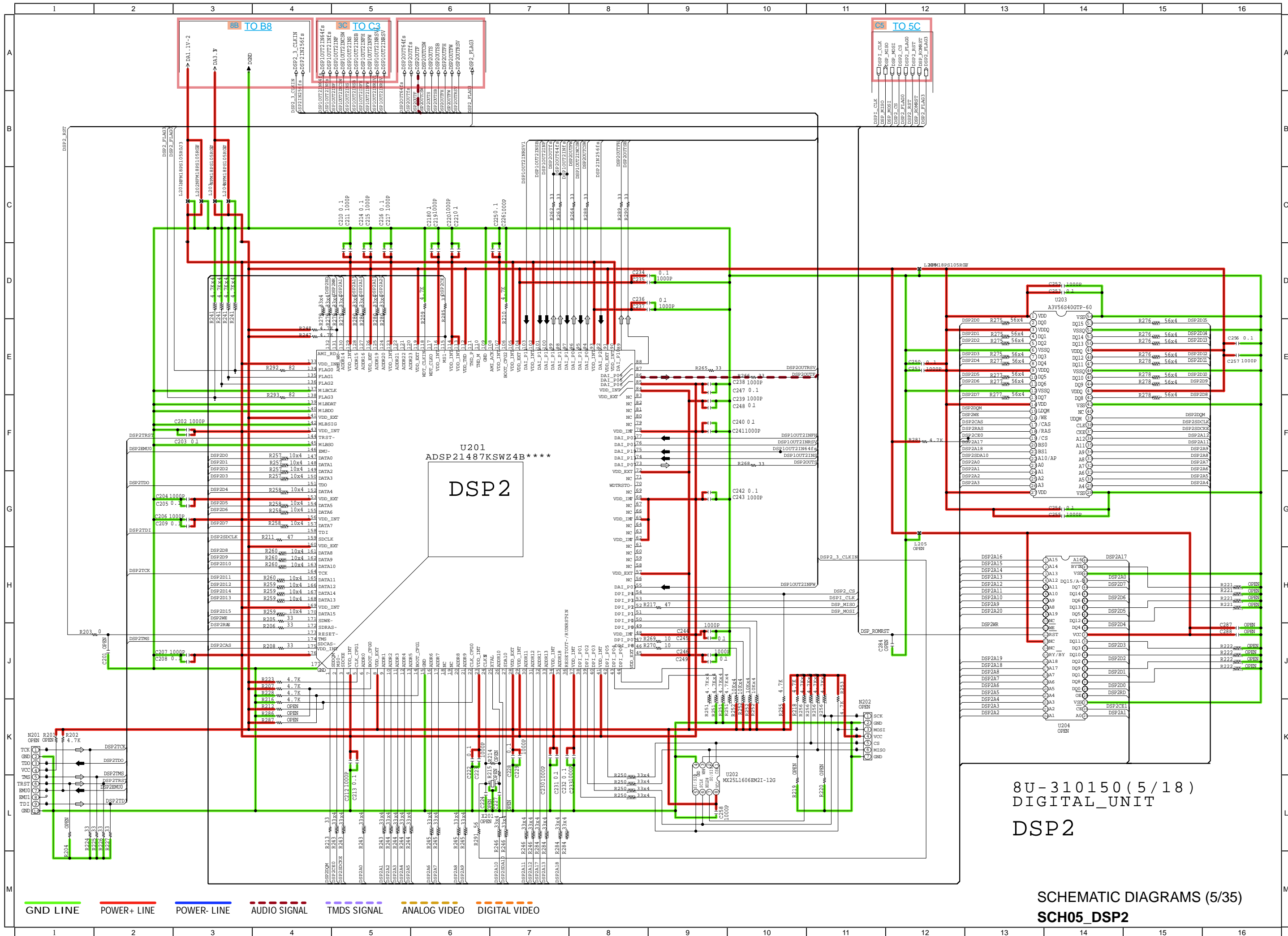

8U-310150 (5/18)  
DIGITAL\_UNIT  
DSP2

SCHEMATIC DIAGRAMS (5/35)  
SCH05\_DSP2

- GND LINE
- POWER+ LINE
- POWER- LINE
- - - AUDIO SIGNAL
- TMS SIGNAL
- ANALOG VIDEO
- DIGITAL VIDEO

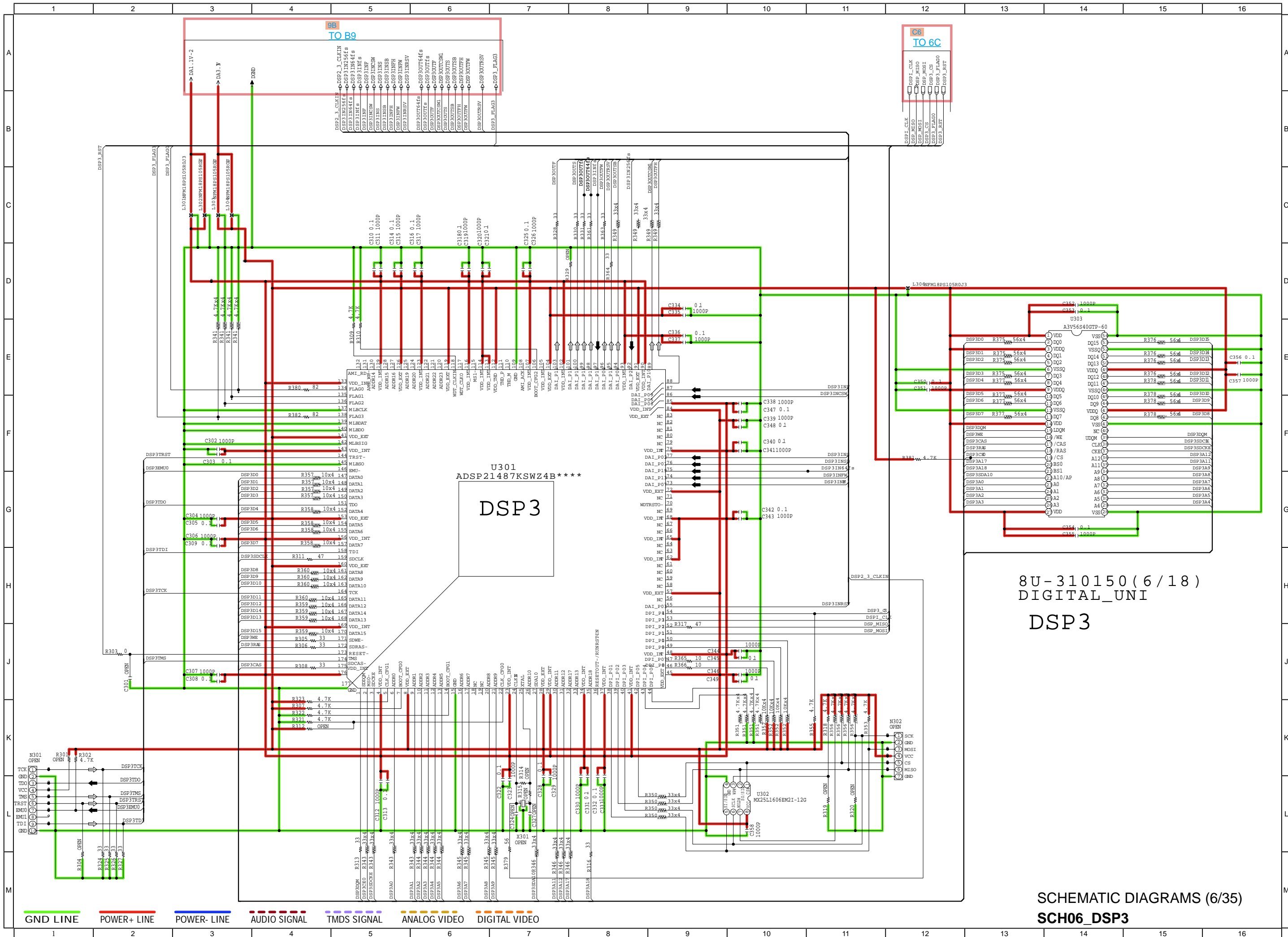

8U-310150(6/18)  
DIGITAL\_UNI  
DSP3

SCHEMATIC DIAGRAMS (6/35)  
SCH06\_DSP3







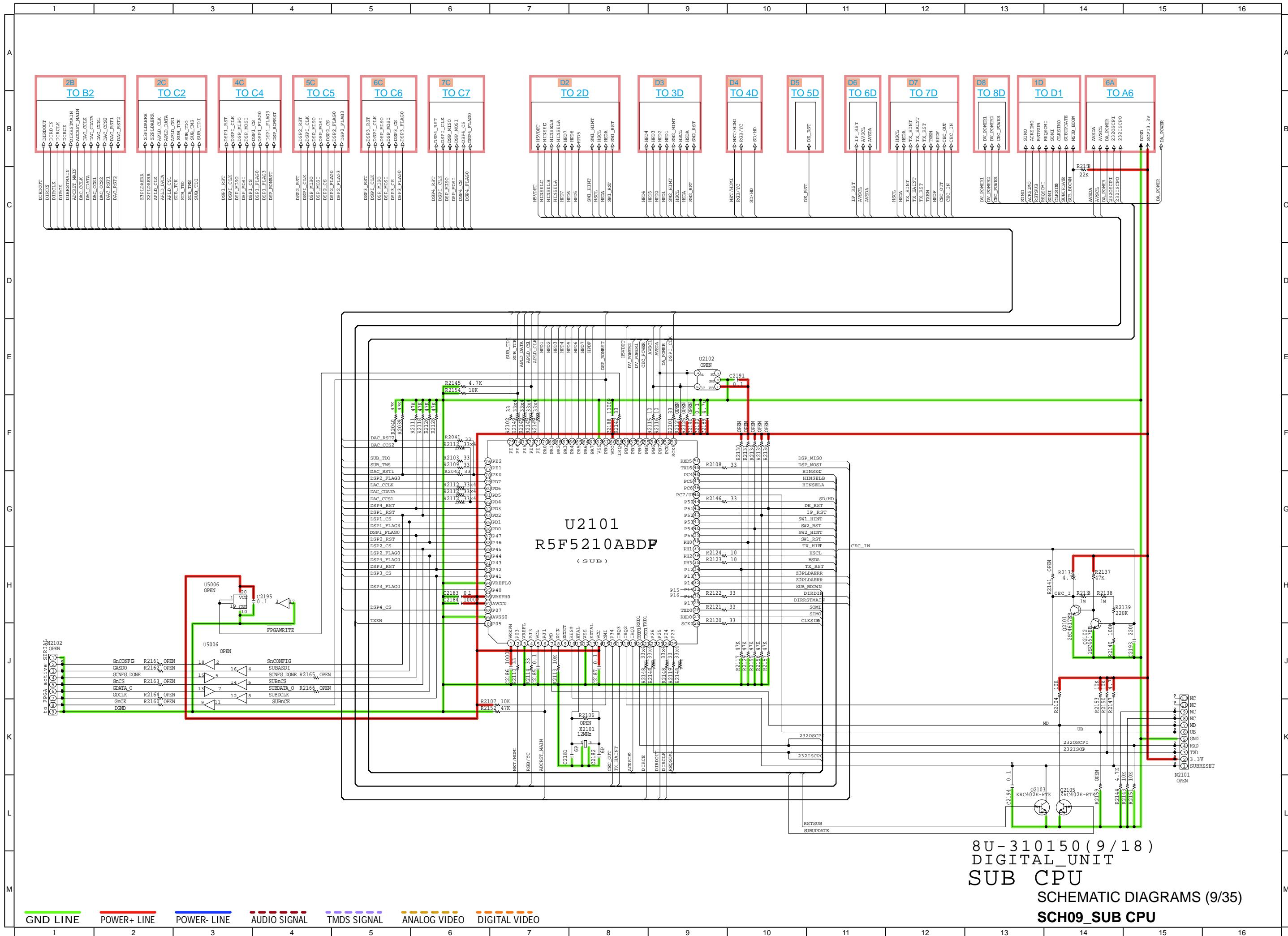

8U-310150 (9/18)  
 DIGITAL\_UNIT  
 SUB CPU  
 SCHEMATIC DIAGRAMS (9/35)  
 SCH09 SUB CPU

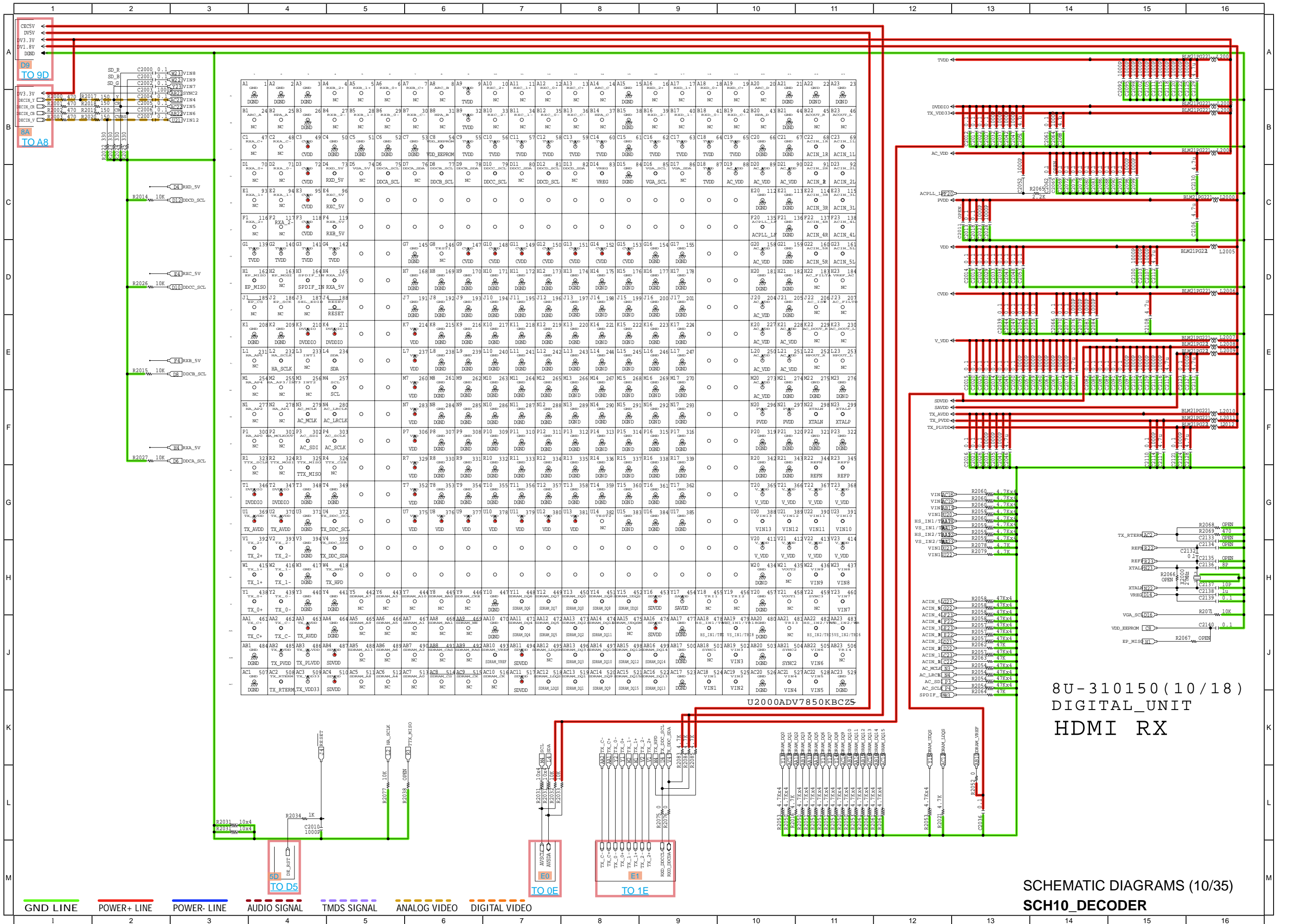

8U-310150(10/18)  
DIGITAL\_UNIT  
HDMI\_RX

SCHEMATIC DIAGRAMS (10/35)  
SCH10\_DECODER



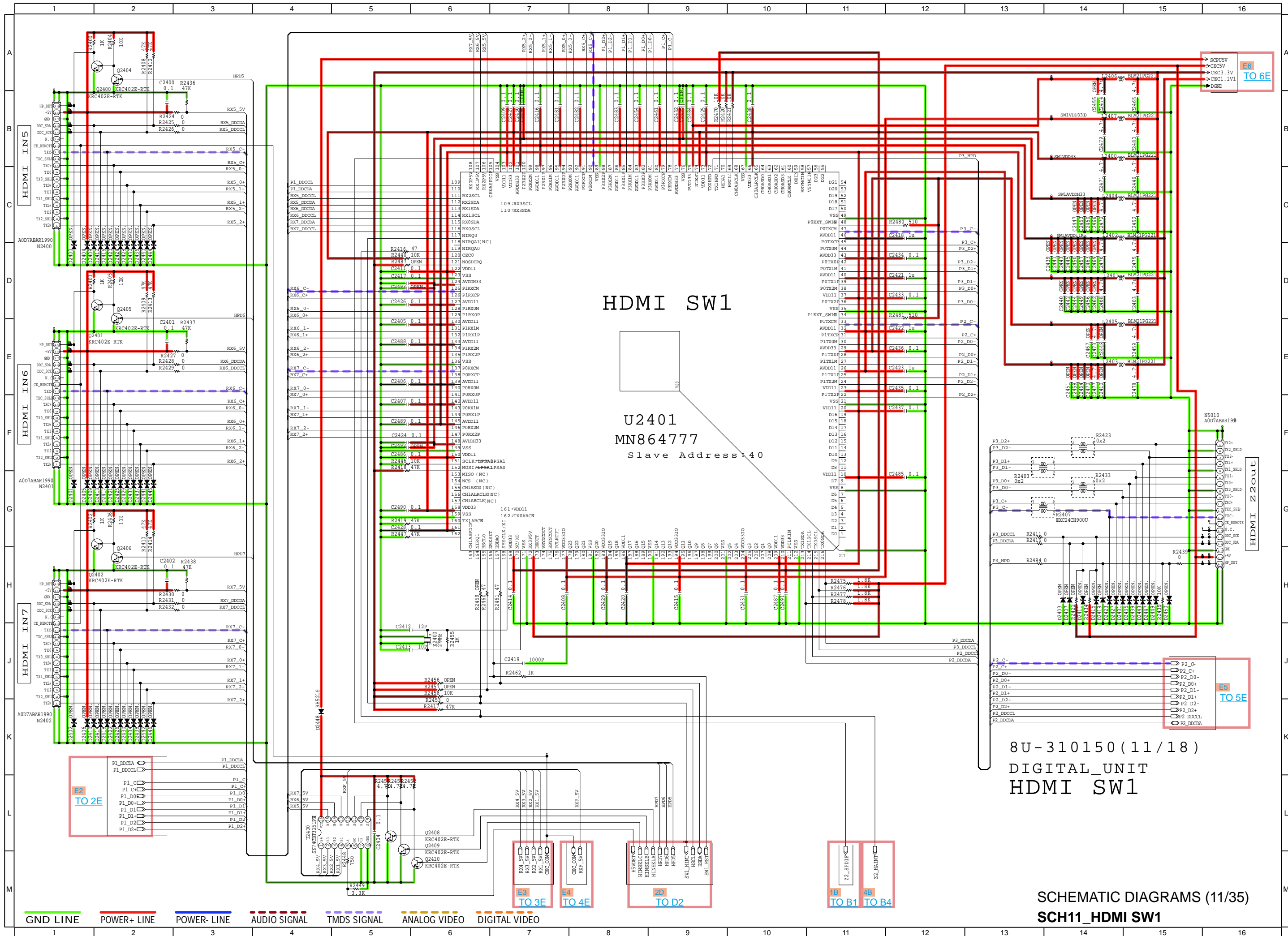

HDMI SW1

U2401  
MN864777  
Slave Address: 40

8U-310150 (11/18)  
DIGITAL UNIT  
HDMI SW1

SCHEMATIC DIAGRAMS (11/35)  
SCH11\_HDMI SW1

- GND LINE
- POWER+ LINE
- POWER- LINE
- AUDIO SIGNAL
- TMDS SIGNAL
- ANALOG VIDEO
- DIGITAL VIDEO

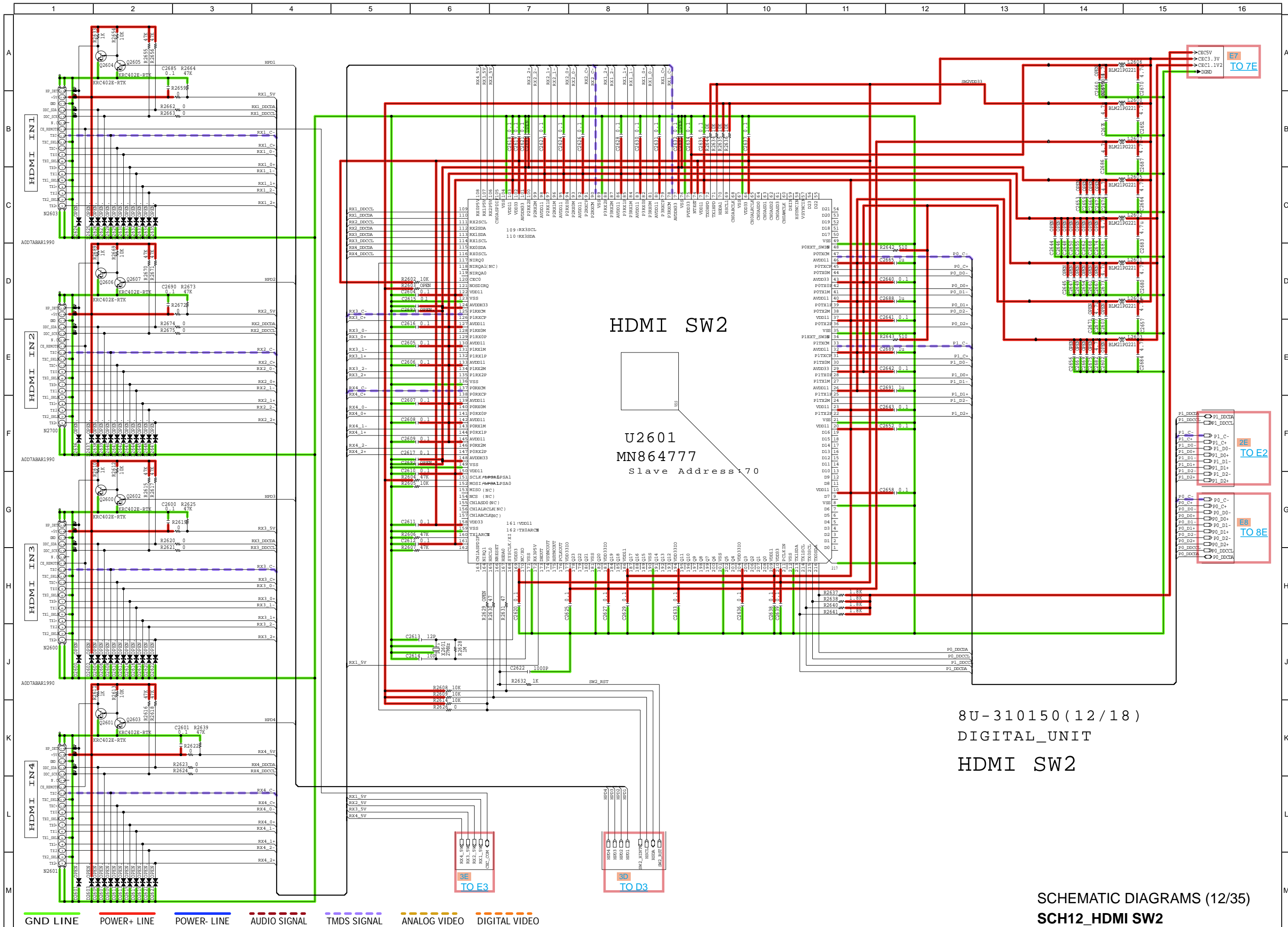

HDMI SW2

U2601  
MN864777  
Slave Address: 70

8U-310150(12/18)  
DIGITAL\_UNIT  
HDMI SW2

GND LINE    POWER+ LINE    POWER- LINE    AUDIO SIGNAL    TMDS SIGNAL    ANALOG VIDEO    DIGITAL VIDEO

TO E7

TO E2

TO E8

TO E3

TO D3

SCHEMATIC DIAGRAMS (12/35)  
SCH12\_HDMI SW2





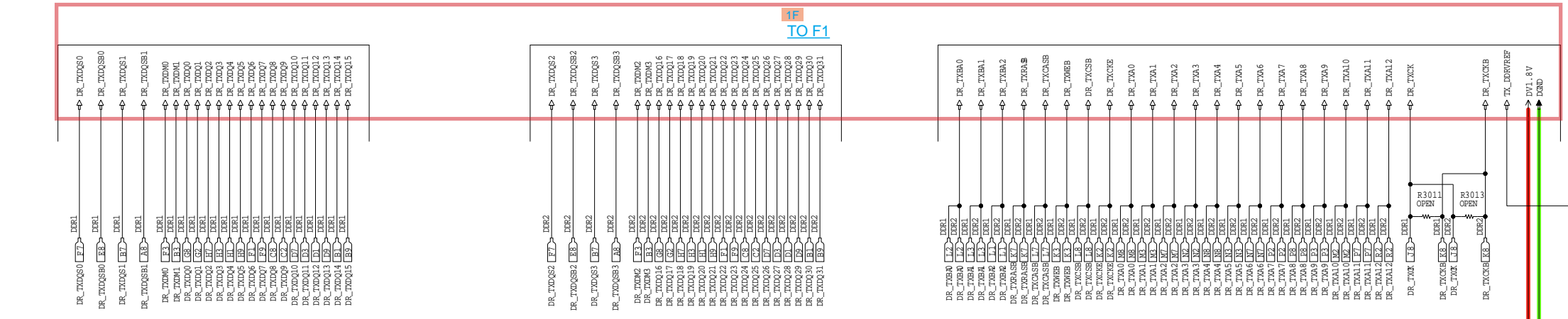

A1	1	A2	2	A3	3					A7	7	A8	8	A9	9
	DDR_1.8V				DGND						DR_TXDQSB1			DDR_1.8V	
B1	10	B2	11	B3	12					B7	16	B8	17	B9	18
	DR_TXDQ14		DGND		DR_TXDQ15						DR_TXDQ30			DR_TXDQ31	
C1	19	C2	20	C3	21					C7	25	C8	26	C9	27
	DDR_1.8V		DR_TXDQ9		DDR_1.8V						DDR_1.8V			DR_TXDQ24	DDR_1.8V
D1	28	D2	29	D3	30					D7	34	D8	35	D9	36
	DR_TXDQ12		DGND		DR_TXDQ11						DR_TXDQ10			DR_TXDQ13	
E1	37	E2	38	E3	39					E7	43	E8	44	E9	45
	DDR_1.8V				DGND						DR_TXDQSB8			DDR_1.8V	
F1	46	F2	47	F3	48					F7	52	F8	53	F9	54
	DR_TXDQ6		DGND		DR_TXDQ0						DR_TXDQ22			DR_TXDQ23	DR_TXDQ24
G1	55	G2	56	G3	57					G7	61	G8	62	G9	63
	DDR_1.8V		DR_TXDQ1		DDR_1.8V						DDR_1.8V			DR_TXDQ16	DDR_1.8V
H1	64	H2	65	H3	66					H7	70	H8	71	H9	72
	DR_TXDQ4		DGND		DR_TXDQ3						DR_TXDQ2			DR_TXDQ5	
J1	73	J2	74	J3	75					J7	79	J8	80	J9	81
	DDR_1.8V		TX_DDRVREF		DGND						DR_TXCK			DDR_1.8V	
K1	82	K2	83	K3	84					K7	88	K8	89	K9	90
			DR_TXCKE		DR_TXCKB						DR_TXRASE		DR_TXCKB	DDR_1_ODT	
L1	91	L2	92	L3	93					L7	97	L8	98		
	DR_TXBA2		DR_TXBA0		DR_TXBA1						DR_TXCAS9		DR_TXCAS8		
M1	101	M2	102	M3	103					M7	106	M8	107	M9	108
	DR_TXA10		DR_TXA1								DR_TXA2		DR_TXA0		DDR_1.8V
N1	109	N2	110	N3	111					N7	115	N8	116		
	DGND		DR_TXA3		DR_TXA5						DR_TXA6		DR_TXA4		
P1	119	P2	120	P3	121					P7	124	P8	125	P9	126
	DR_TXA7		DR_TXA9								DR_TXA11		DR_TXA8		DGND
R1	127	R2	128	R3	129					R7	133	R8	134		
	DDR_1.8V		DR_TXA12		DR_1_RFU1						DR_2_RFU2		DR_2_RFU3		

U3000 DDR\_1st  
A3R12E40CBF-8E

A1	1	A2	2	A3	3					A7	7	A8	8	A9	9
	DDR_1.8V				DGND						DR_TXDQSB1			DDR_1.8V	
B1	10	B2	11	B3	12					B7	16	B8	17	B9	18
	DR_TXDQ30		DGND		DR_TXDQ31						DR_TXDQ3			DR_TXDQ24	DDR_1.8V
C1	19	C2	20	C3	21					C7	25	C8	26	C9	27
	DDR_1.8V		DR_TXDQ25		DDR_1.8V						DDR_1.8V			DR_TXDQ24	DDR_1.8V
D1	28	D2	29	D3	30					D7	34	D8	35	D9	36
	DR_TXDQ28		DGND		DR_TXDQ27						DR_TXDQ26			DR_TXDQ29	
E1	37	E2	38	E3	39					E7	43	E8	44	E9	45
	DDR_1.8V				DGND						DR_TXDQSB8			DDR_1.8V	
F1	46	F2	47	F3	48					F7	52	F8	53	F9	54
	DR_TXDQ22		DGND		DR_TXDQ2						DR_TXDQ22			DR_TXDQ23	DR_TXDQ24
G1	55	G2	56	G3	57					G7	61	G8	62	G9	63
	DDR_1.8V		DR_TXDQ17		DDR_1.8V						DDR_1.8V			DR_TXDQ16	DDR_1.8V
H1	64	H2	65	H3	66					H7	70	H8	71	H9	72
	DR_TXDQ20		DGND		DR_TXDQ19						DR_TXDQ18			DR_TXDQ21	
J1	73	J2	74	J3	75					J7	79	J8	80	J9	81
	DDR_1.8V		TX_DDRVREF		DGND						DR_TXCK			DDR_1.8V	
K1	82	K2	83	K3	84					K7	88	K8	89	K9	90
			DR_TXCKE		DR_TXCKB						DR_TXRASE		DR_TXCKB	DDR_2_ODT	
L1	91	L2	92	L3	93					L7	97	L8	98		
	DR_TXBA2		DR_TXBA0		DR_TXBA1						DR_TXCAS9		DR_TXCAS8		
M1	101	M2	102	M3	103					M7	106	M8	107	M9	108
	DR_TXA10		DR_TXA1								DR_TXA2		DR_TXA0		DDR_1.8V
N1	109	N2	110	N3	111					N7	115	N8	116		
	DGND		DR_TXA3		DR_TXA5						DR_TXA6		DR_TXA4		
P1	119	P2	120	P3	121					P7	124	P8	125	P9	126
	DR_TXA7		DR_TXA9								DR_TXA11		DR_TXA8		DGND
R1	127	R2	128	R3	129					R7	133	R8	134		
	DDR_1.8V		DR_TXA12		DR_2_RFU1						DR_2_RFU2		DR_2_RFU3		

U3001 DDR\_2nd  
A3R12E40CBF-8E

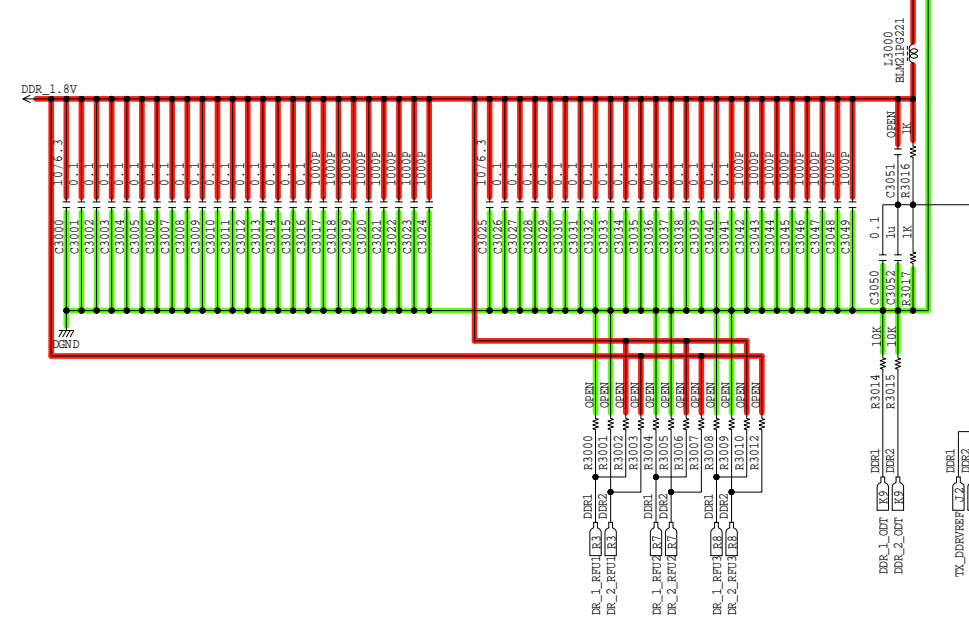

8U-310150(14/18)  
DIGITAL\_UNIT  
HDMI TX DDR

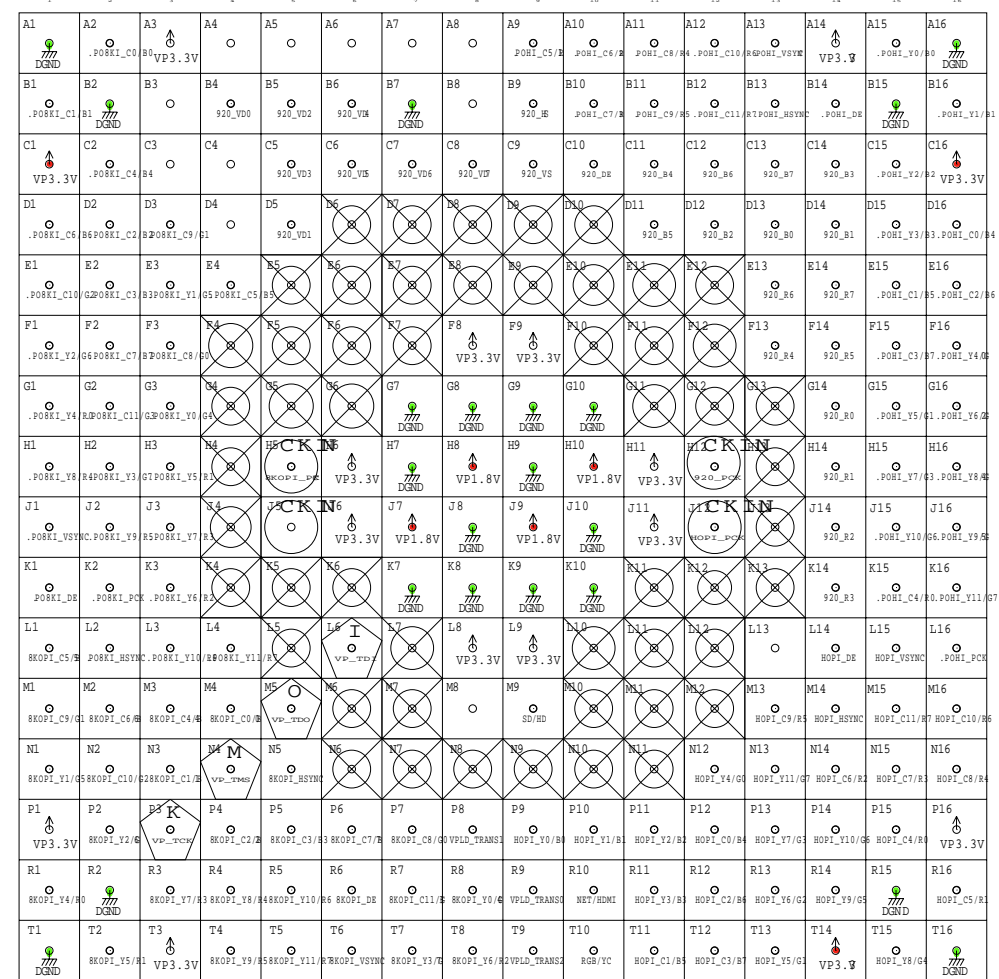

U3200 5M570ZF256C4N

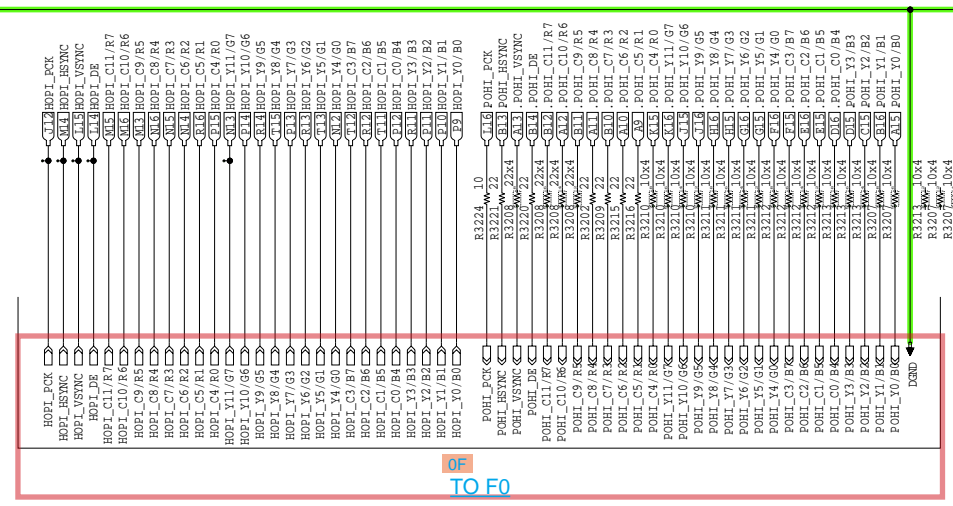
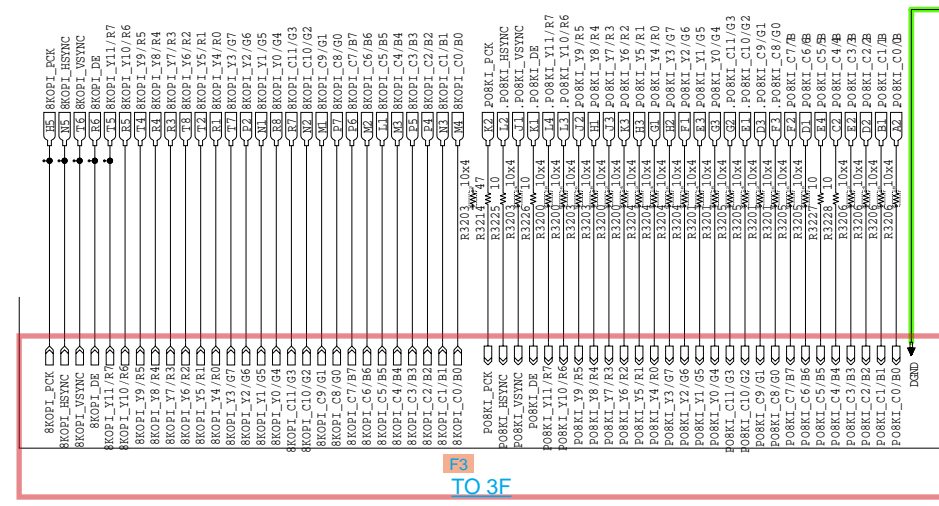
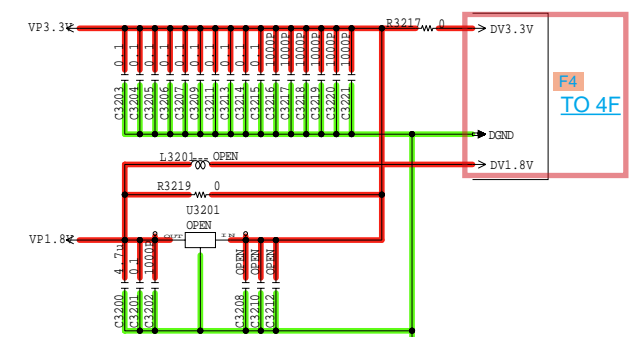
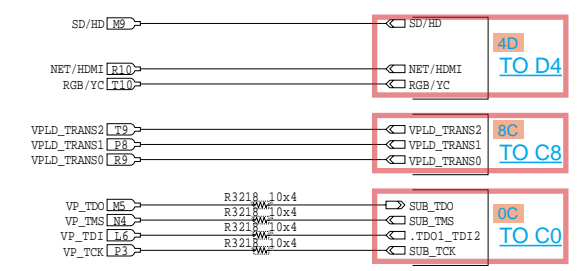
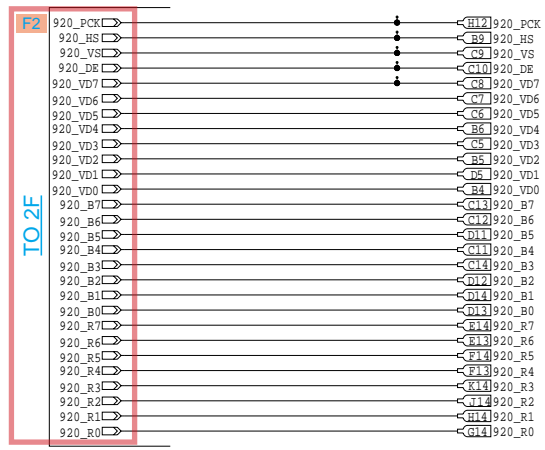

8U-310150(15/18)  
DIGITAL\_UNIT  
VIDEO PLD

SCHEMATIC DIAGRAMS (15/35)  
SCH15\_VIDEO PLD

— GND LINE  
— POWER+ LINE  
— POWER- LINE  
— AUDIO SIGNAL  
— TMDS SIGNAL  
— ANALOG VIDEO  
— DIGITAL VIDEO



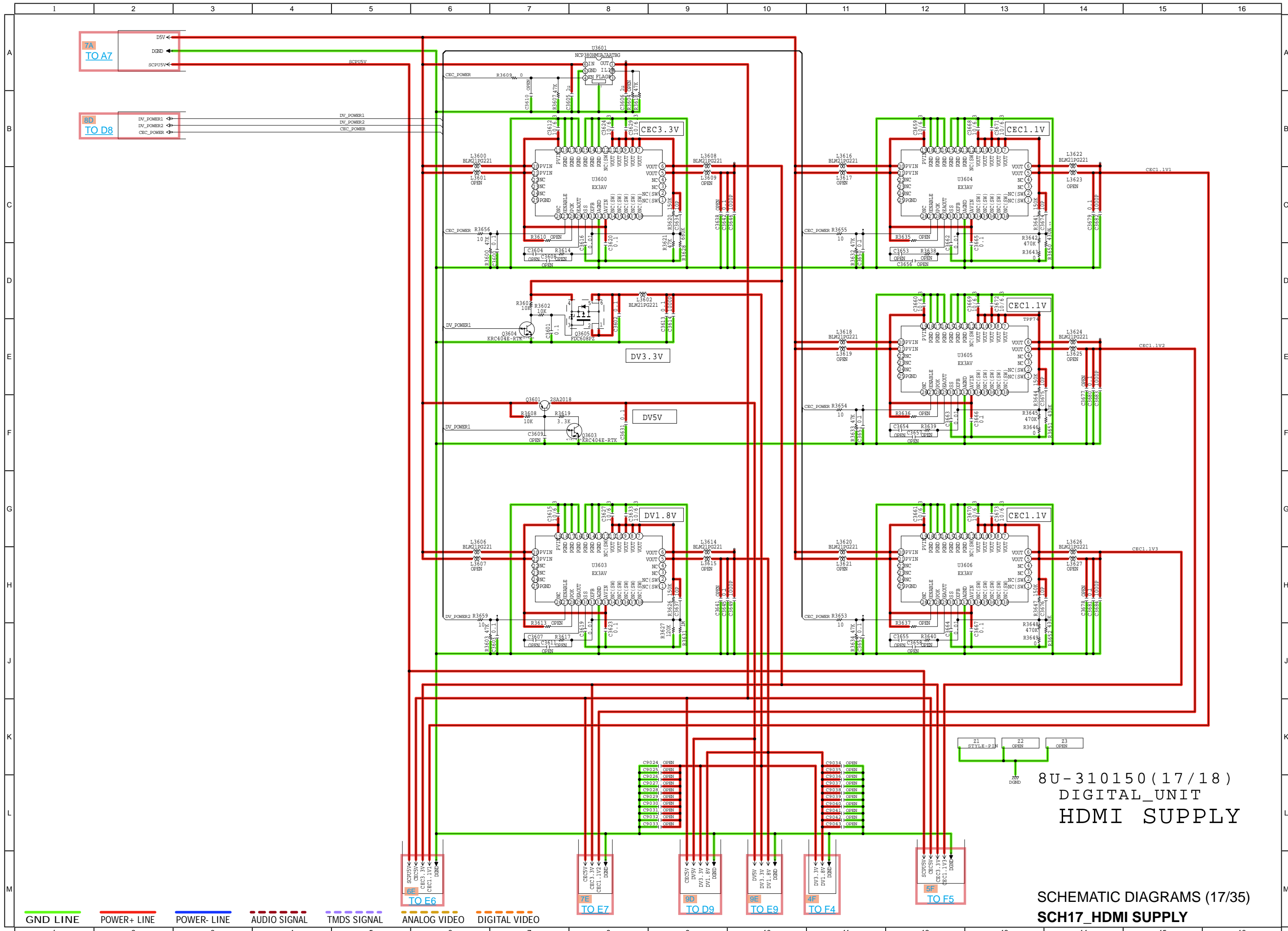

8U-310150(17/18)  
DIGITAL\_UNIT  
HDMI SUPPLY

SCHEMATIC DIAGRAMS (17/35)  
SCH17\_HDMI SUPPLY



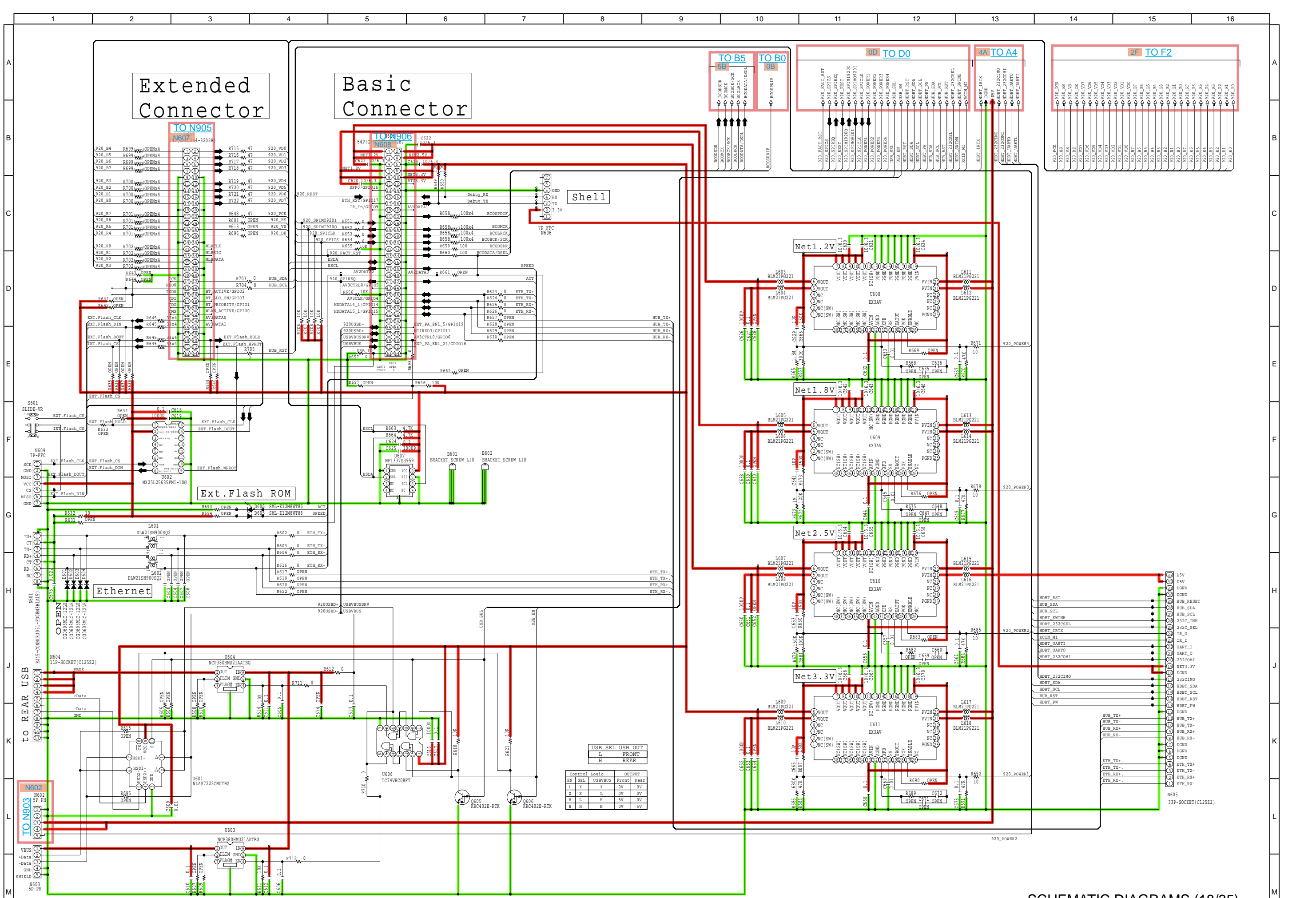

Extended Connector

Basic Connector

TO N905

TO N906

TO B5  
5B

TO B0  
0B

0D TO D0

4A TO A4

2F TO F2

Shell

Ext. Flash ROM

Ethernet

USB_SEL		USB OUT	
FR	Rear	FRONT	REAR
L	X	OV	OV
X	X	L	OV
H	L	H	SV
H	H	H	OV

SCHEMATIC DIAGRAMS (18/35)  
SCH18\_NETWORK



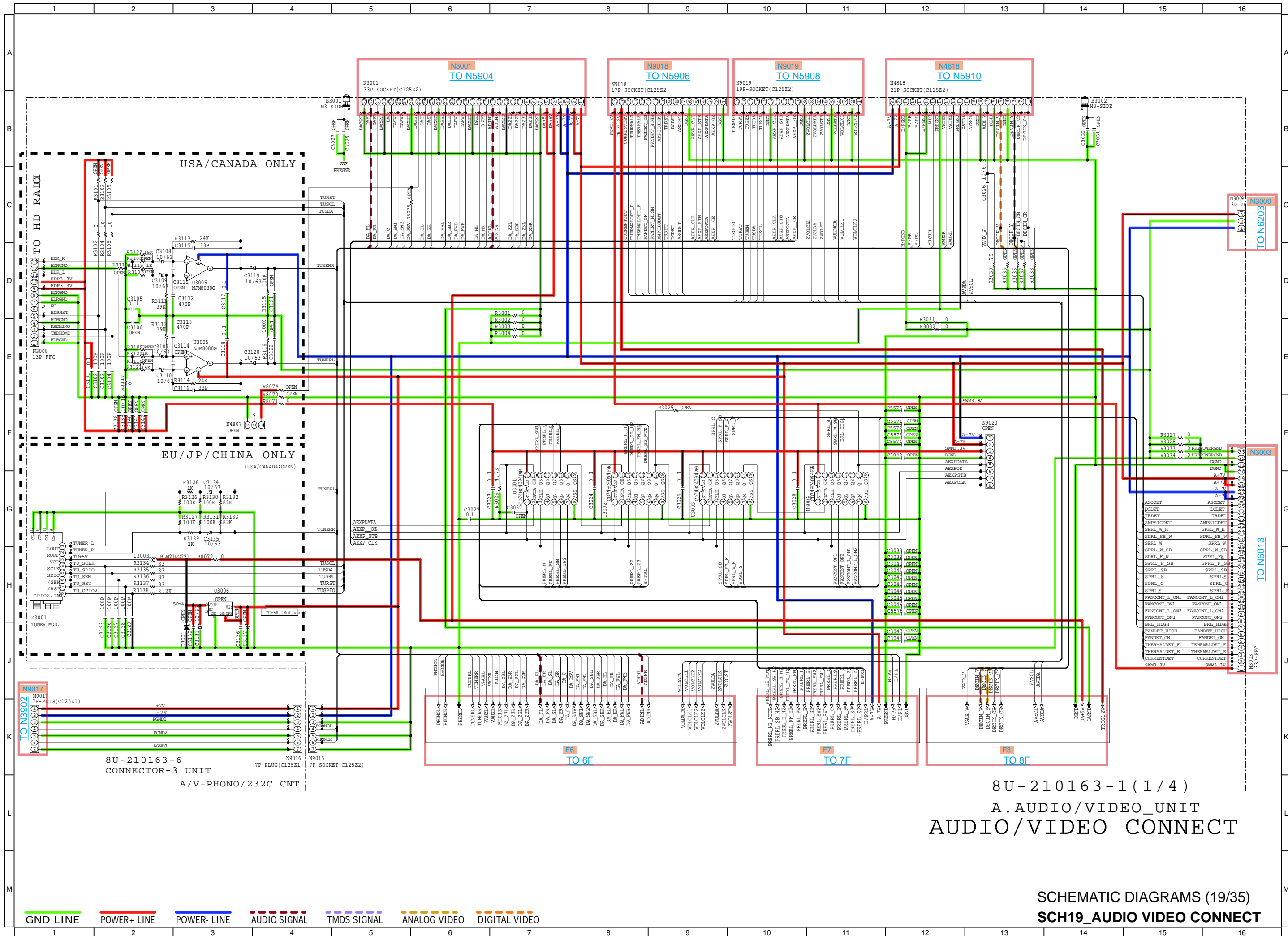

USA/CANADA ONLY

EU/JP/CHINA ONLY  
(USA/CANADA: OPEN)

8U-210163-6  
CONNECTOR-3 UNIT  
A/V-PHONO/232C CNT

8U-210163-1(1/4)  
A.AUDIO/VIDEO\_UNIT  
AUDIO/VIDEO CONNECT

SCHEMATIC DIAGRAMS (19/35)  
SCH19\_AUDIO VIDEO CONNECT

- GND LINE
- POWER+ LINE
- POWER- LINE
- AUDIO SIGNAL
- TMS SIGNAL
- ANALOG VIDEO
- DIGITAL VIDEO

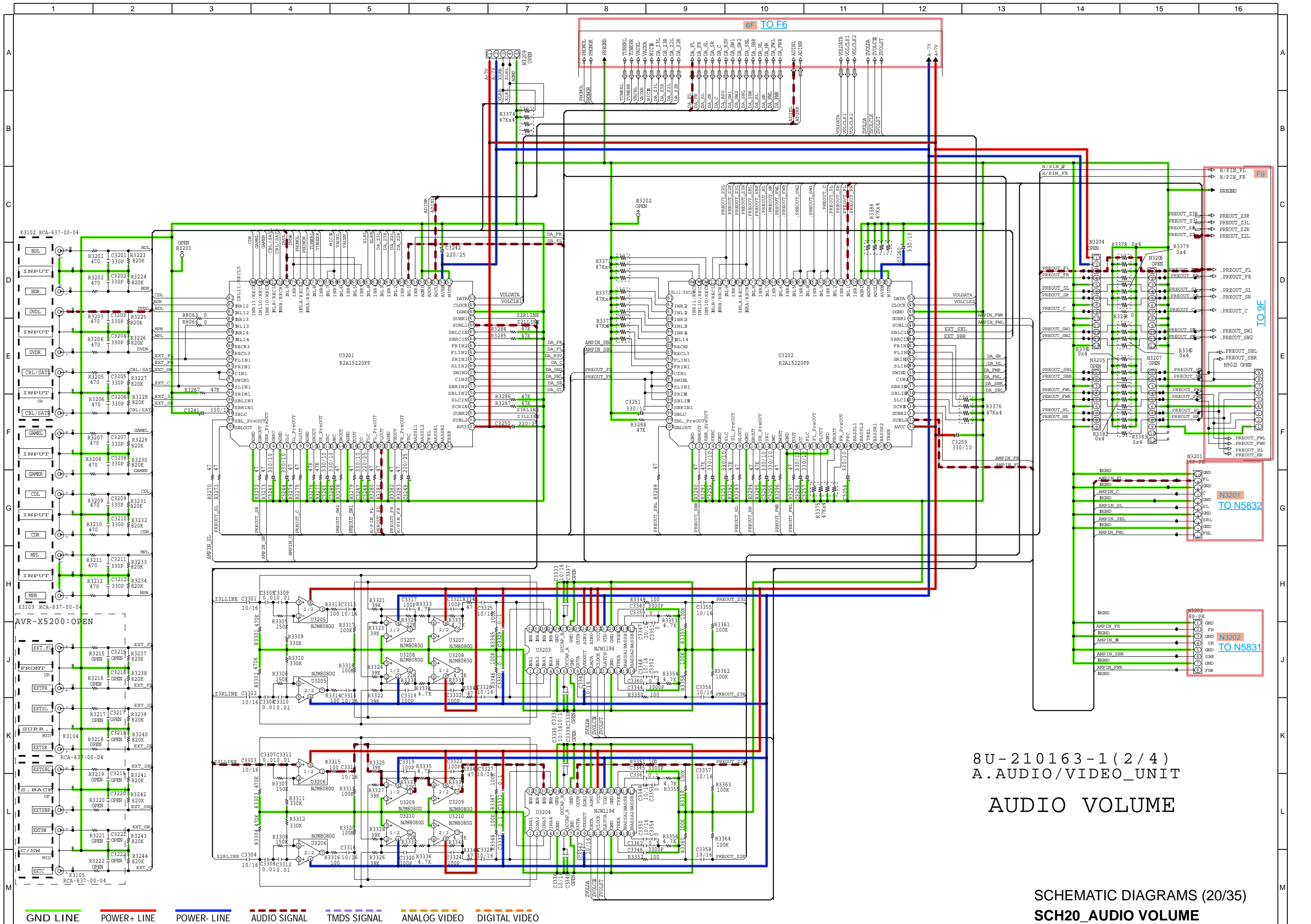

8U-210163-1 (2/4)  
 A.AUDIO/VIDEO\_UNIT  
 AUDIO VOLUME

SCHEMATIC DIAGRAMS (20/35)  
 SCH20\_AUDIO VOLUME

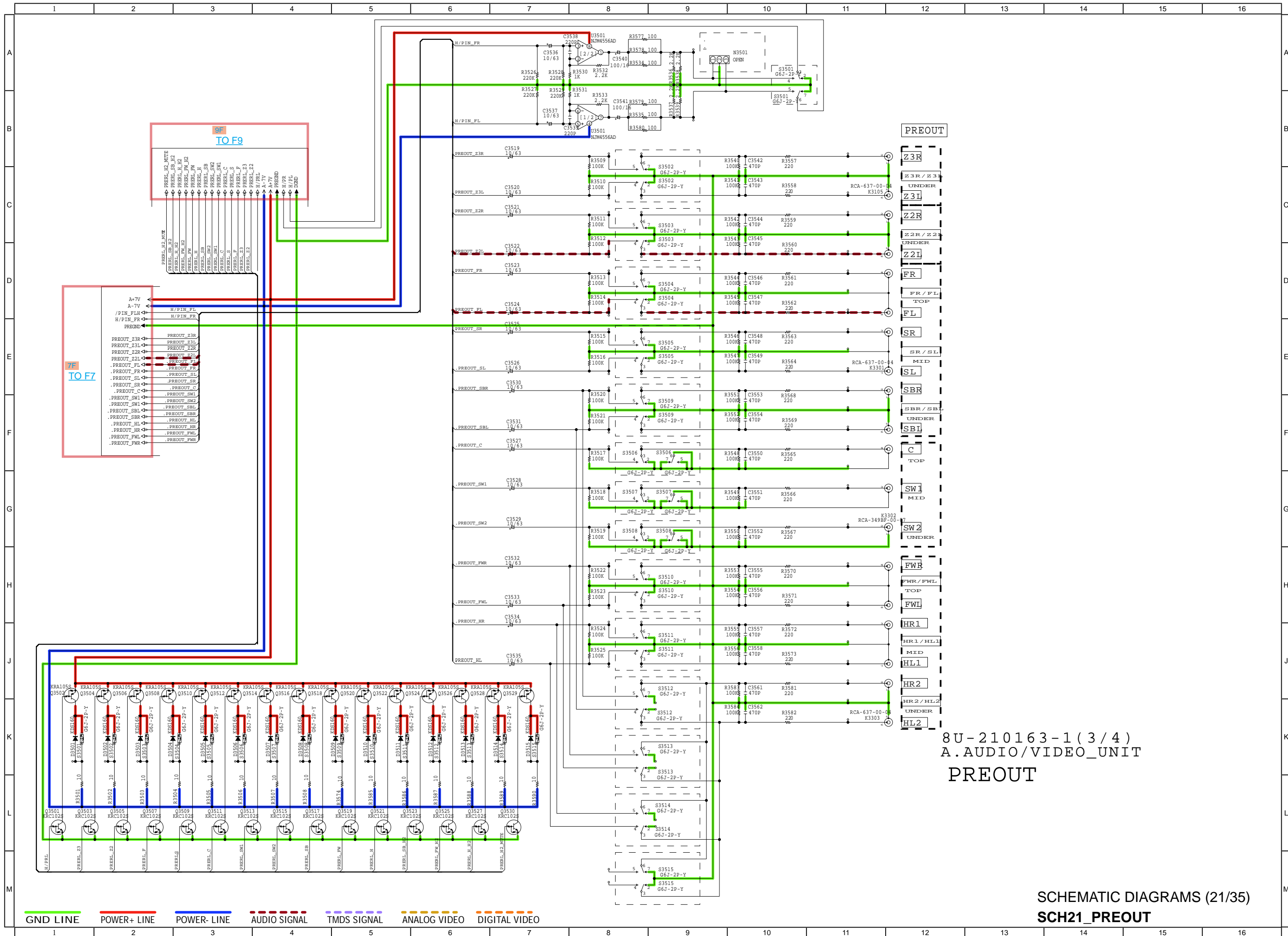

8U-210163-1(3/4)  
 A.AUDIO/VIDEO\_UNIT  
 PREOUT

SCH21\_PREOUT

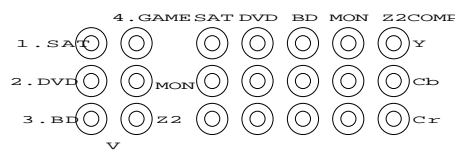
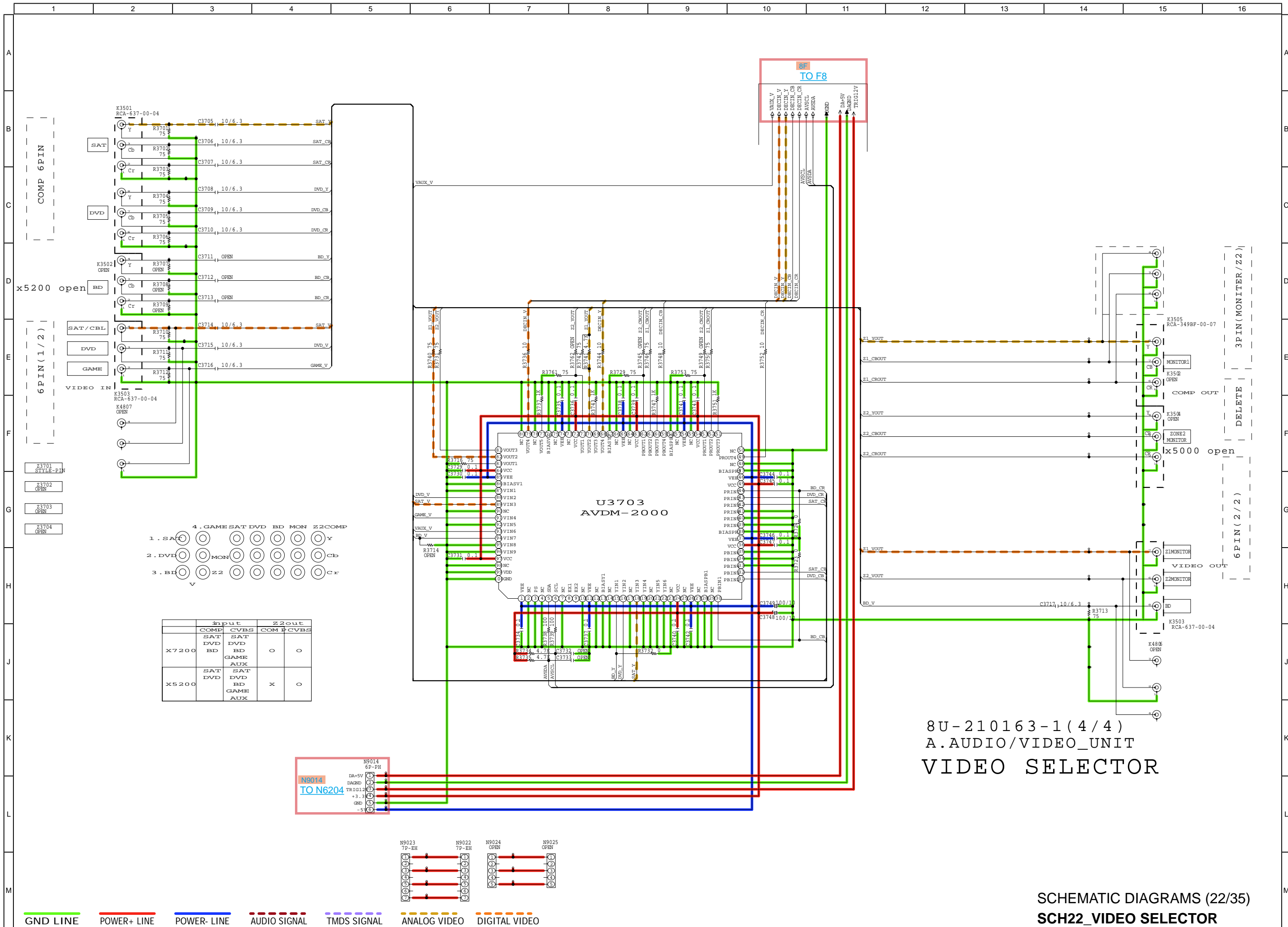

	input	CVBS	Z2out	COM P CVBS
x7200	COMP	SAT		
	DVD	DVD	○	○
	BD	BD		
x5200	SAT	SAT		
	DVD	DVD		
	GAME	AUX	X	○

8U-210163-1(4/4)  
A.AUDIO/VIDEO\_UNIT  
VIDEO\_SELECTOR

SCHEMATIC DIAGRAMS (22/35)  
SCH22\_VIDEO\_SELECTOR





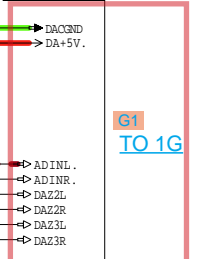
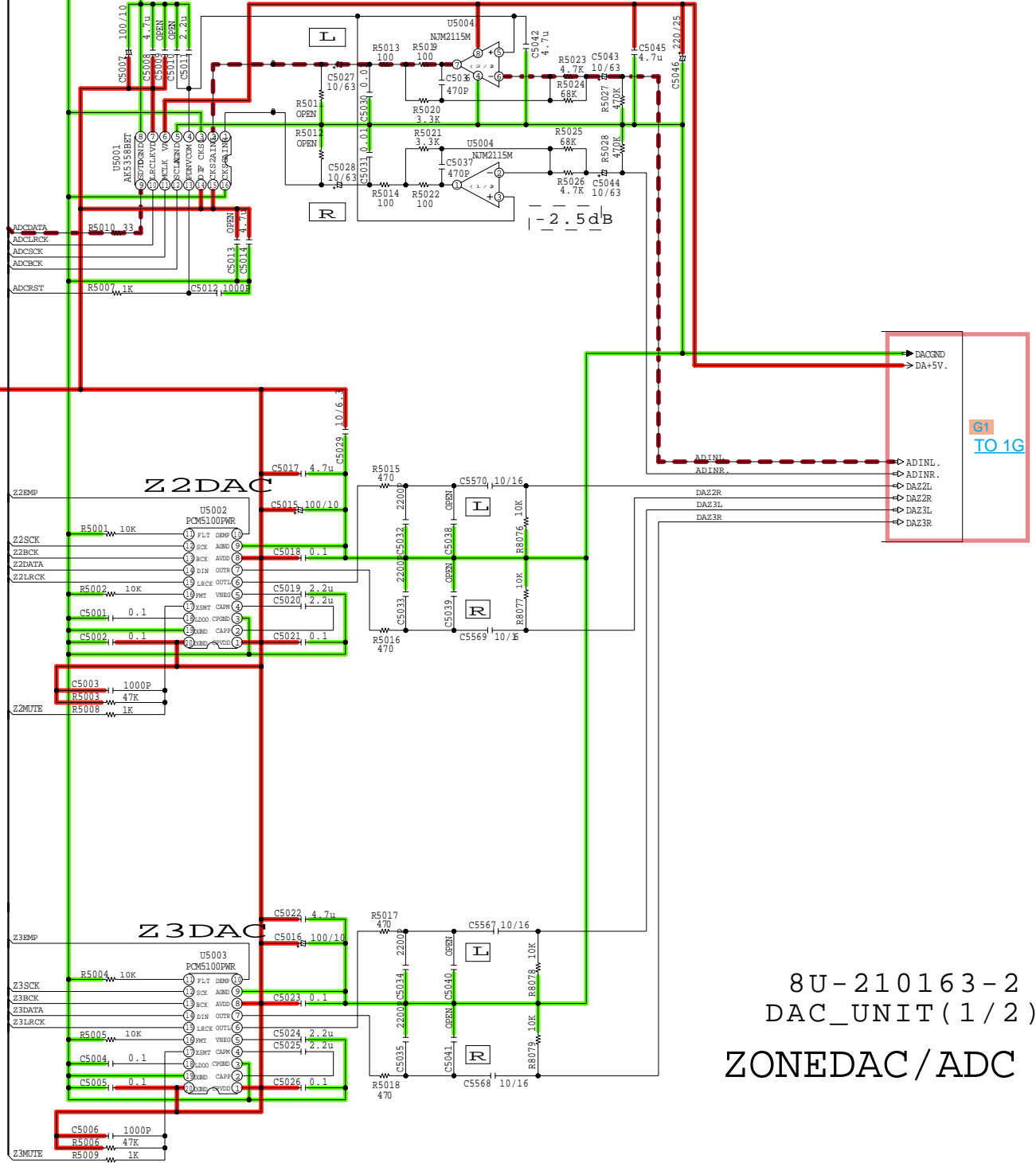
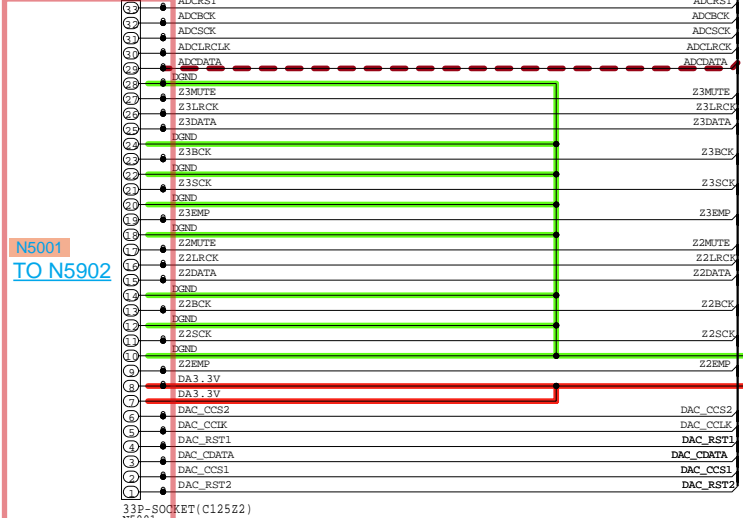
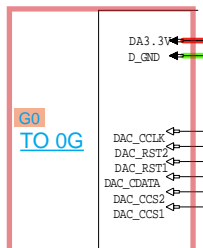

8U-210163-2  
DAC\_UNIT(1/2)  
ZONEDAC / ADC



SCHEMATIC DIAGRAMS (24/35)  
SCH24\_ZONEDAC ADC

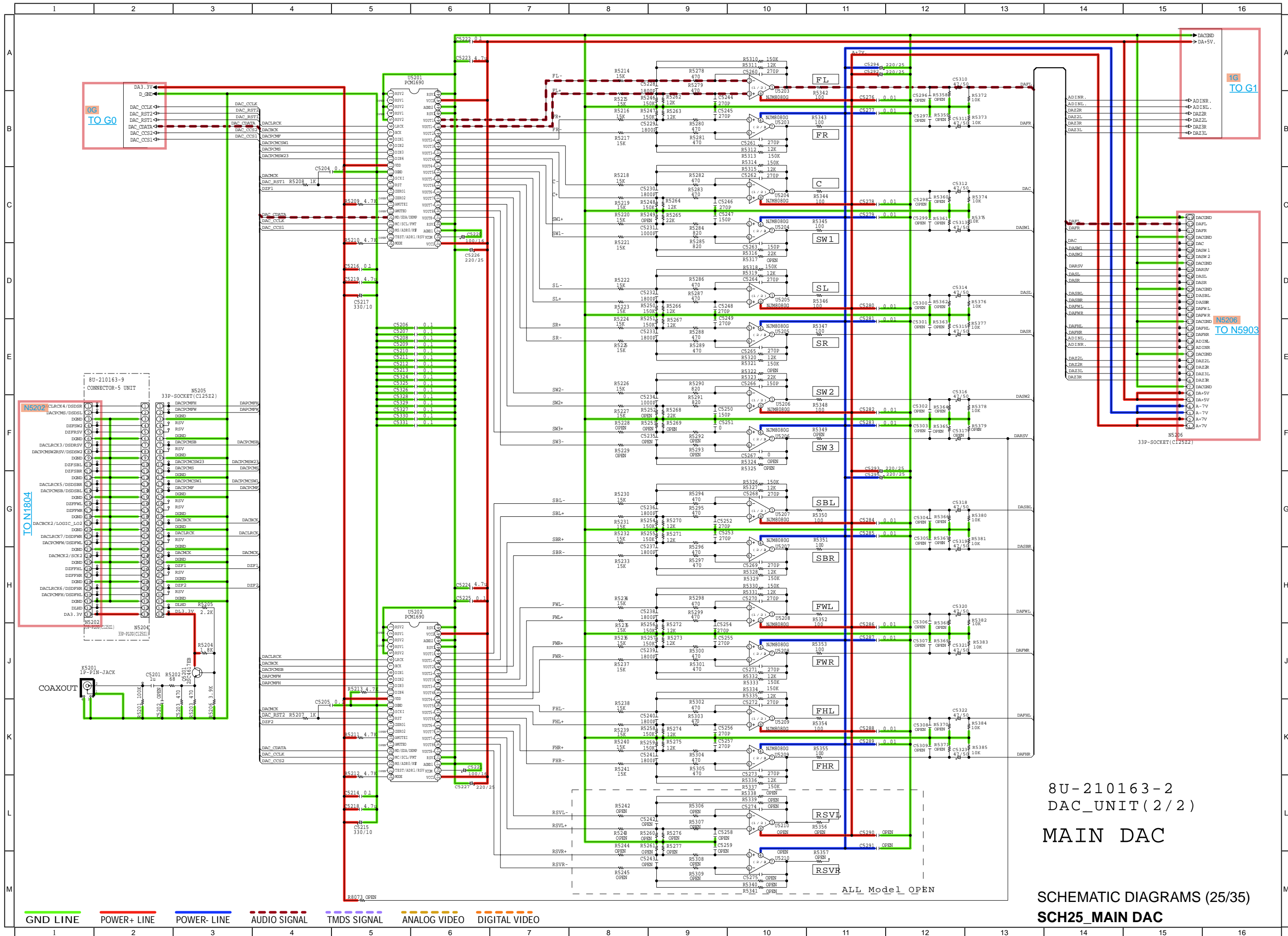

— GND LINE   
 — POWER+ LINE   
 — POWER- LINE   
 — AUDIO SIGNAL   
 — TMDS SIGNAL   
 — ANALOG VIDEO   
 — DIGITAL VIDEO

8U-210163-2  
 DAC\_UNIT(2/2)  
 MAIN DAC

SCHEMATIC DIAGRAMS (25/35)  
 SCH25\_MAIN DAC



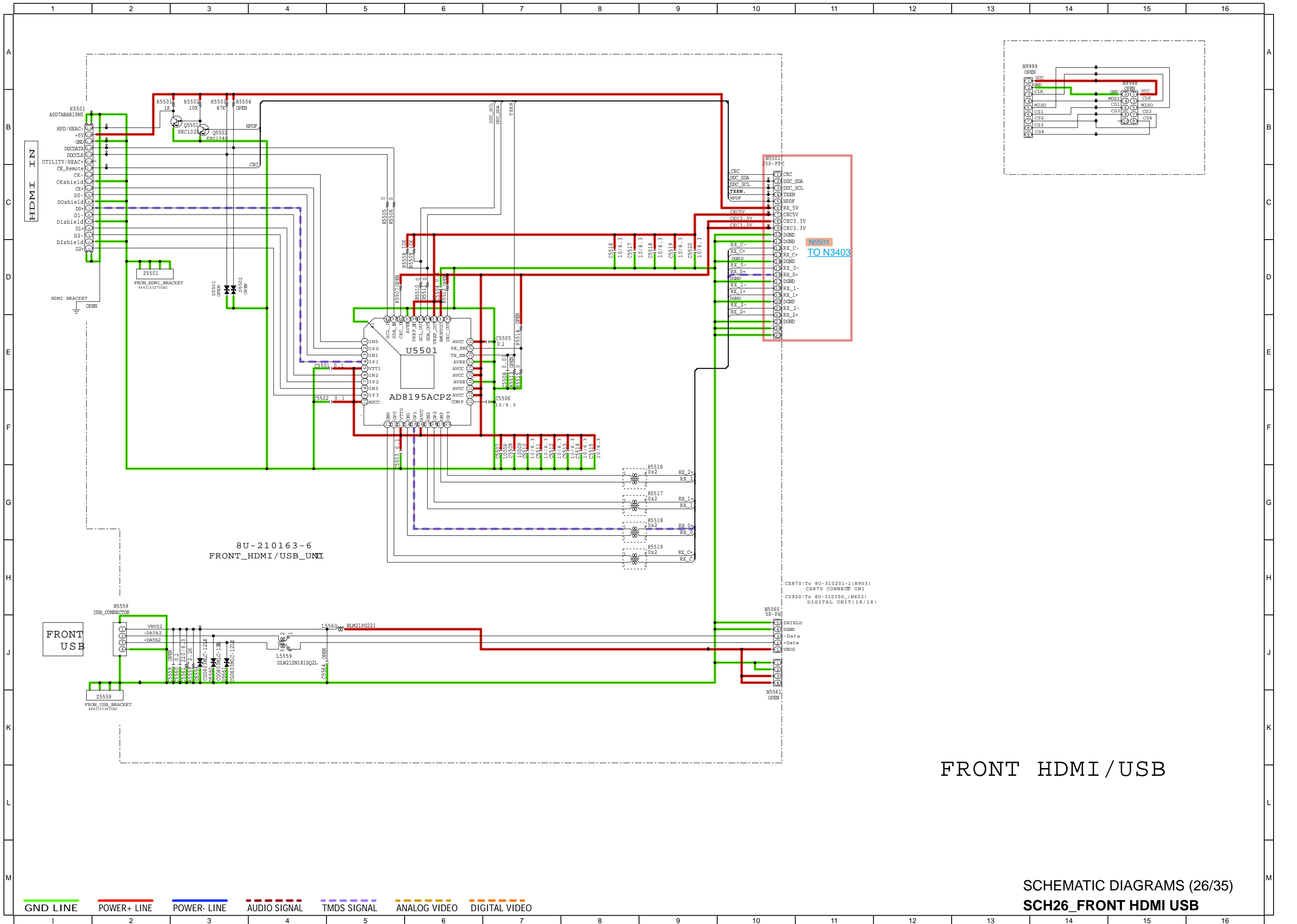

FRONT HDMI / USB

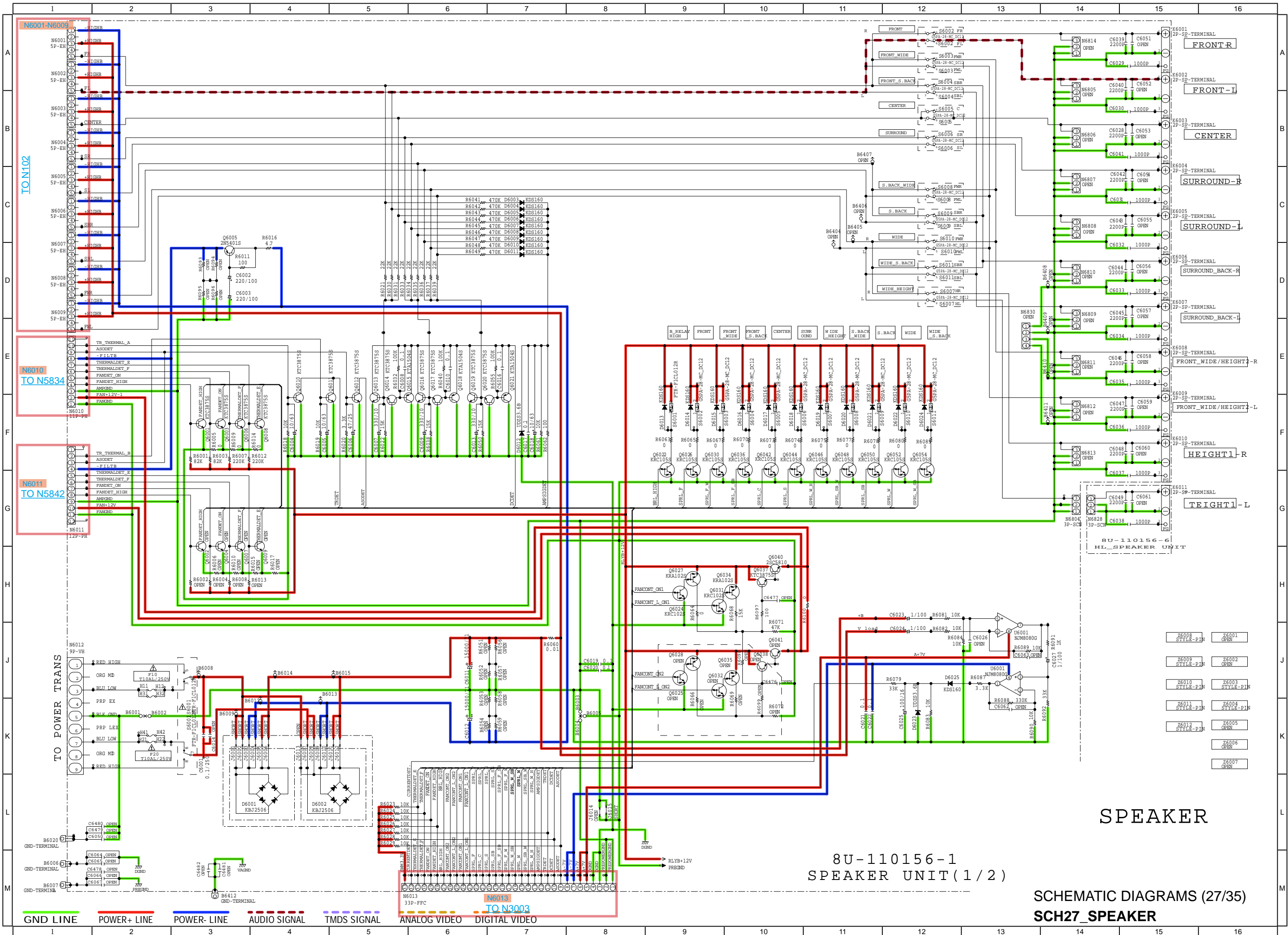

SPEAKER

8U-110156-1  
SPEAKER UNIT (1/2)

SCHEMATIC DIAGRAMS (27/35)  
SCH27\_SPEAKER

- GND LINE
- POWER+ LINE
- POWER LINE
- AUDIO SIGNAL
- TMDS SIGNAL
- ANALOG VIDEO
- DIGITAL VIDEO

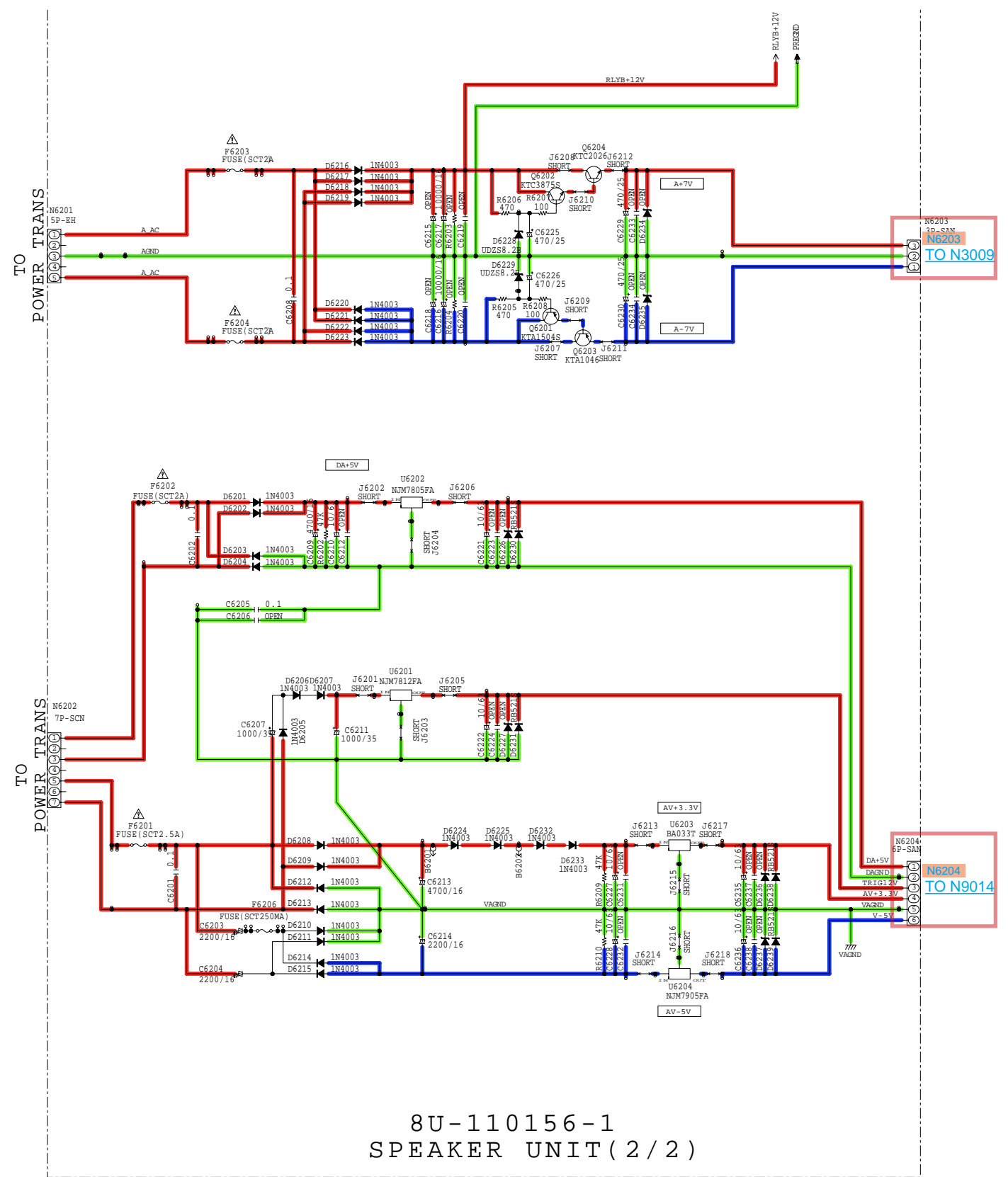

8U-110156-1  
SPEAKER UNIT (2/2)

REG

- GND LINE
- POWER+ LINE
- POWER- LINE
- AUDIO SIGNAL
- TMSD SIGNAL
- ANALOG VIDEO
- DIGITAL VIDEO

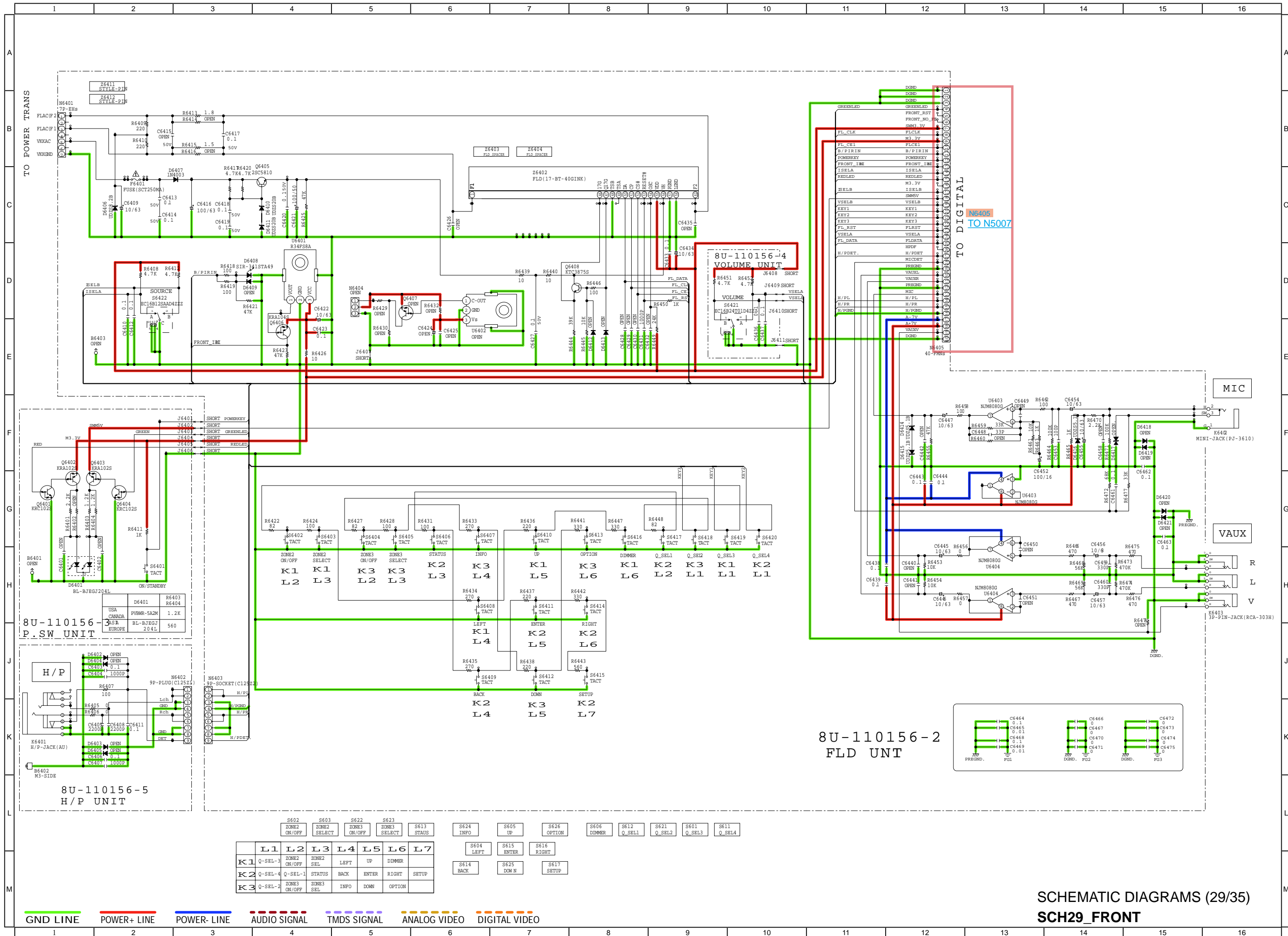

SCH29\_FRONT

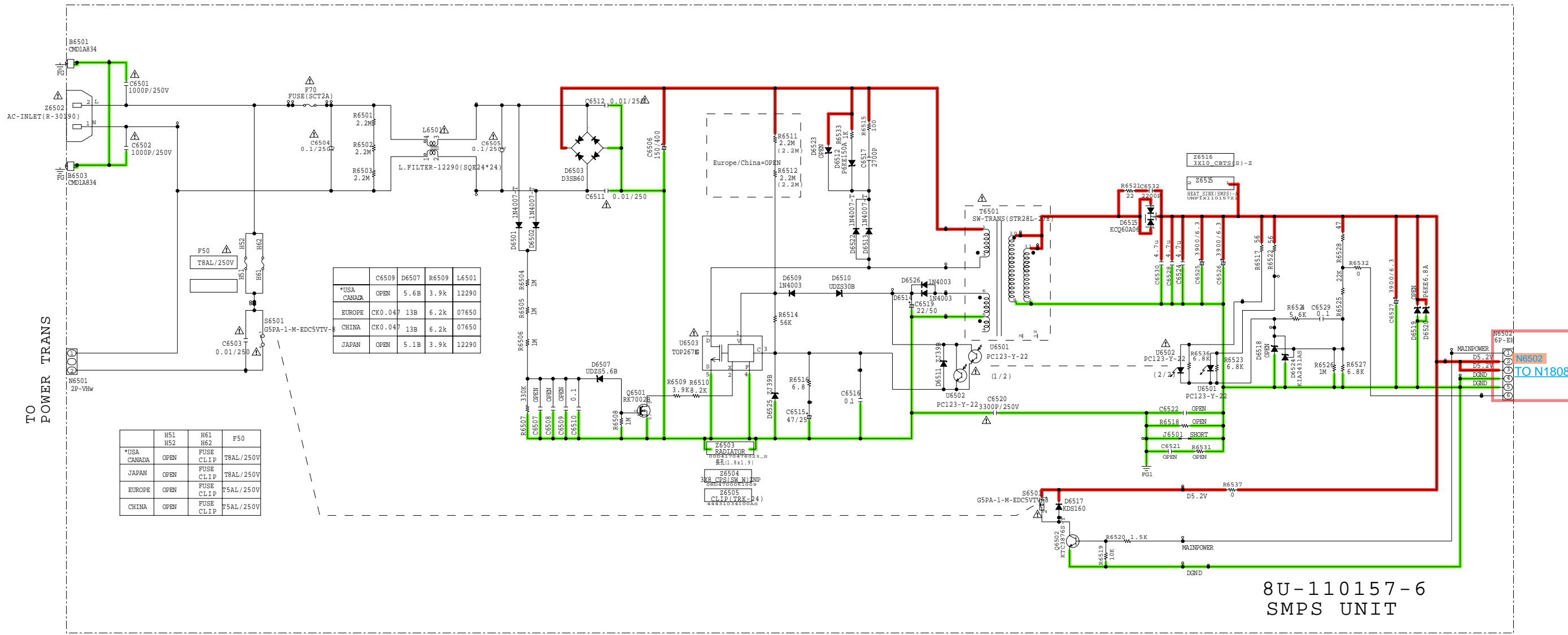

	C6509	D6507	R6509	L6501
*USA	OPEN	5.6B	3.9k	12290
CANADA				
EUROPE	CK0.047	13B	6.2k	07650
CHINA	CK0.047	13B	6.2k	07650
JAPAN	OPEN	5.1B	3.9k	12290

	H51	H61	F50
*USA	OPEN	FUSE CLIP	T8AL/250V
CANADA			
EUROPE	OPEN	FUSE CLIP	T8AL/250V
CHINA	OPEN	FUSE CLIP	T8AL/250V
JAPAN	OPEN	FUSE CLIP	T8AL/250V

N6502  
6P-EH  
TO N1808

8U-110157-6  
SMPS UNIT

SMPS

SCHEMATIC DIAGRAMS (30/35)  
SCH30\_SMPS

GND LINE    POWER+ LINE    POWER- LINE    AUDIO SIGNAL    TMSD SIGNAL    ANALOG VIDEO    DIGITAL VIDEO

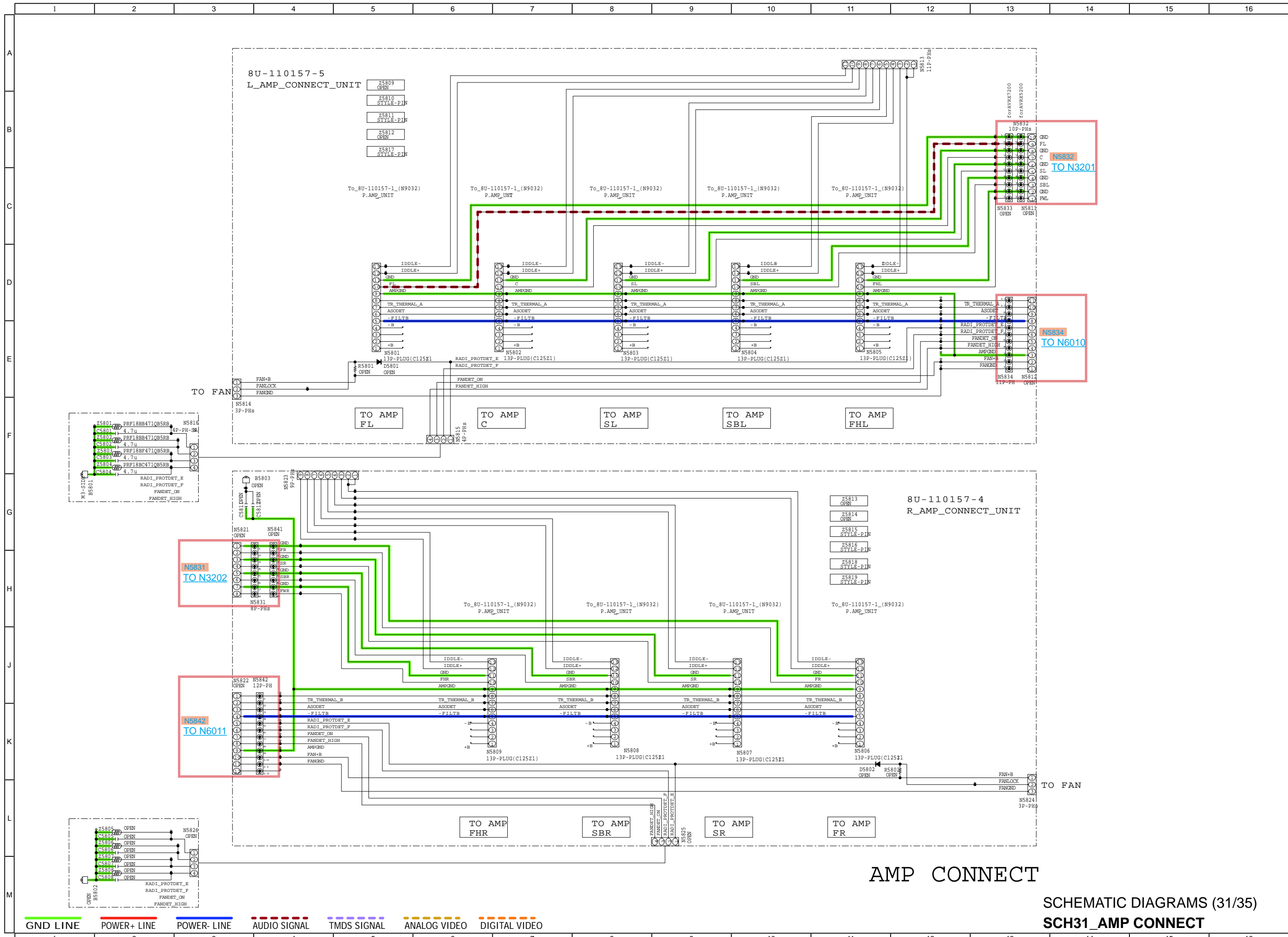



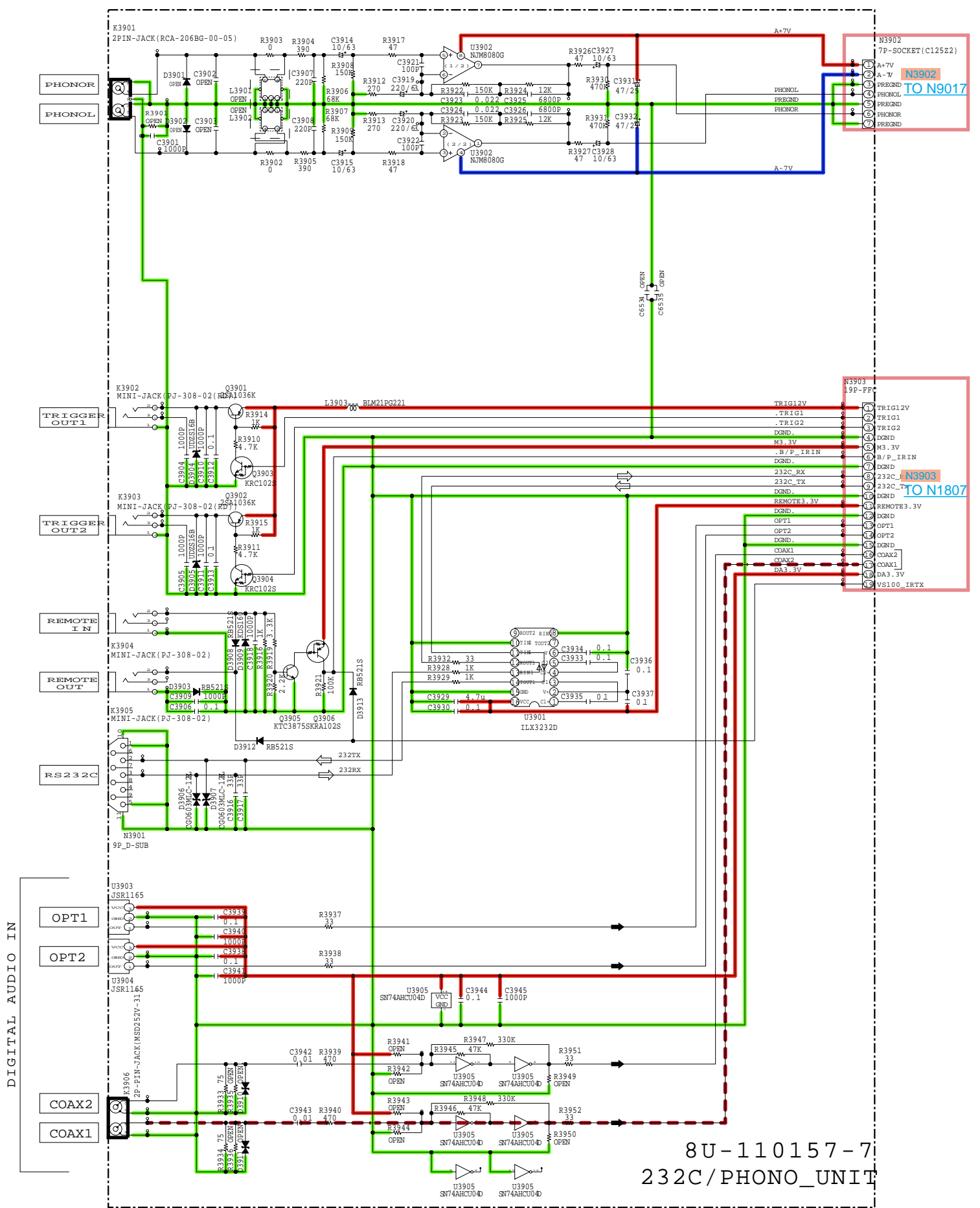

8U-110157-7  
232C/PHONO\_UNIT

SCHEMATIC DIAGRAMS (32/35)  
SCH32\_232C PHONO

- GND LINE
- POWER+ LINE
- POWER- LINE
- AUDIO SIGNAL
- TMSD SIGNAL
- ANALOG VIDEO
- - - DIGITAL VIDEO



To\_8U-110157-5  
L\_AMP\_CONNECT\_UNIT  
To\_8U-110157-4  
R\_AMP\_CONNECT\_UNIT

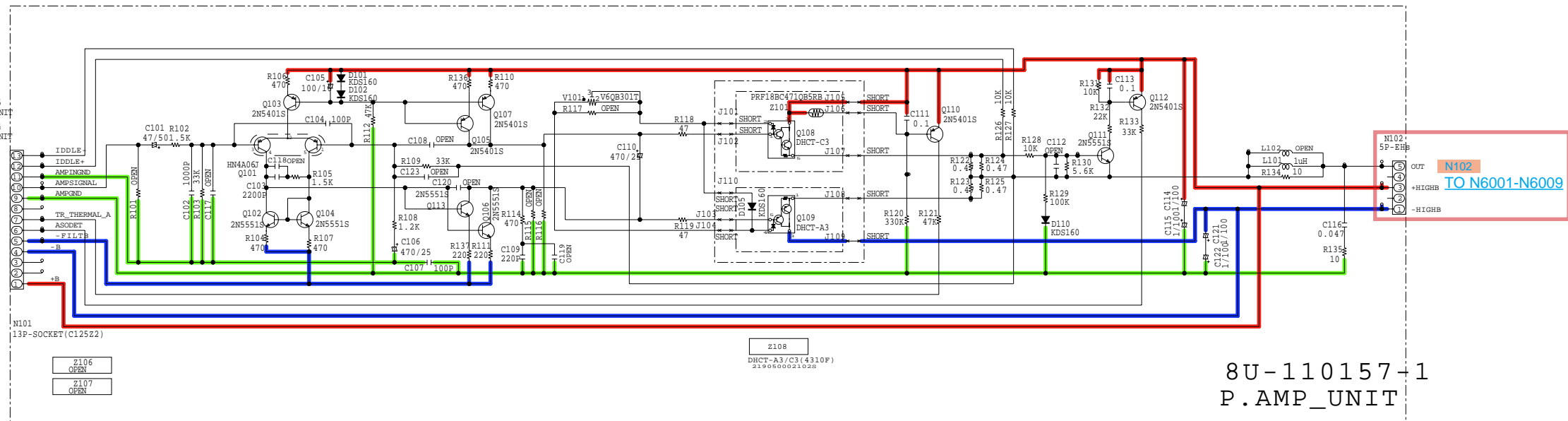

8U-110157-1  
P.AMP\_UNIT

POWER AMP

SCH33\_POWER AMP  
SCHEMATIC DIAGRAMS (33/35)

GND LINE    POWER+ LINE    POWER- LINE    AUDIO SIGNAL    TMDS SIGNAL    ANALOG VIDEO    DIGITAL VIDEO

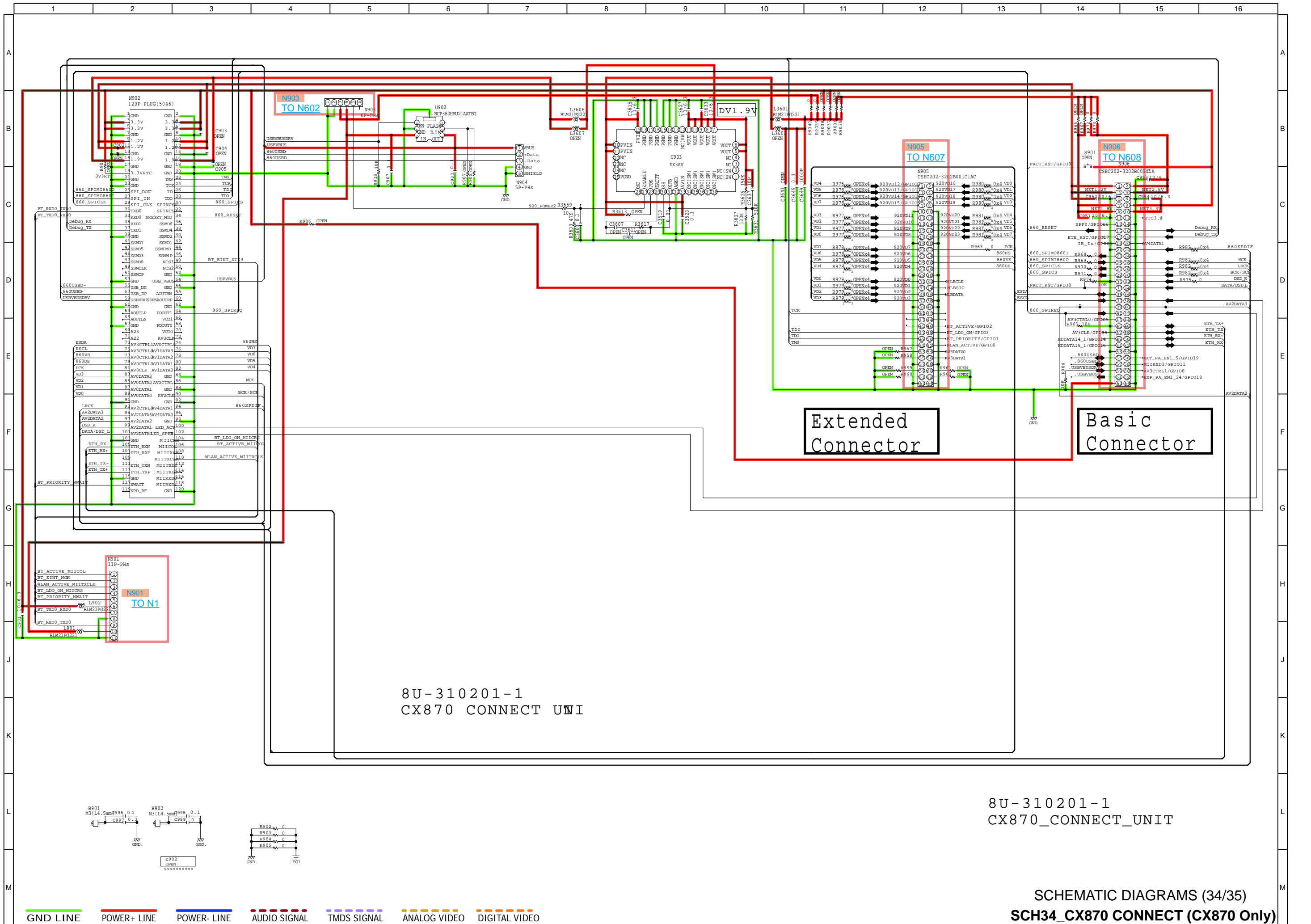

8U-310201-1  
CX870 CONNECT UNI

8U-310201-1  
CX870\_CONNECT\_UNIT

SCHEMATIC DIAGRAMS (34/35)  
SCH34\_CX870 CONNECT (CX870 Only)

- GND LINE
- POWER+ LINE
- POWER- LINE
- AUDIO SIGNAL
- TMDS SIGNAL
- ANALOG VIDEO
- DIGITAL VIDEO



# EXPLODED VIEW

Please see the last chapter for the part list.

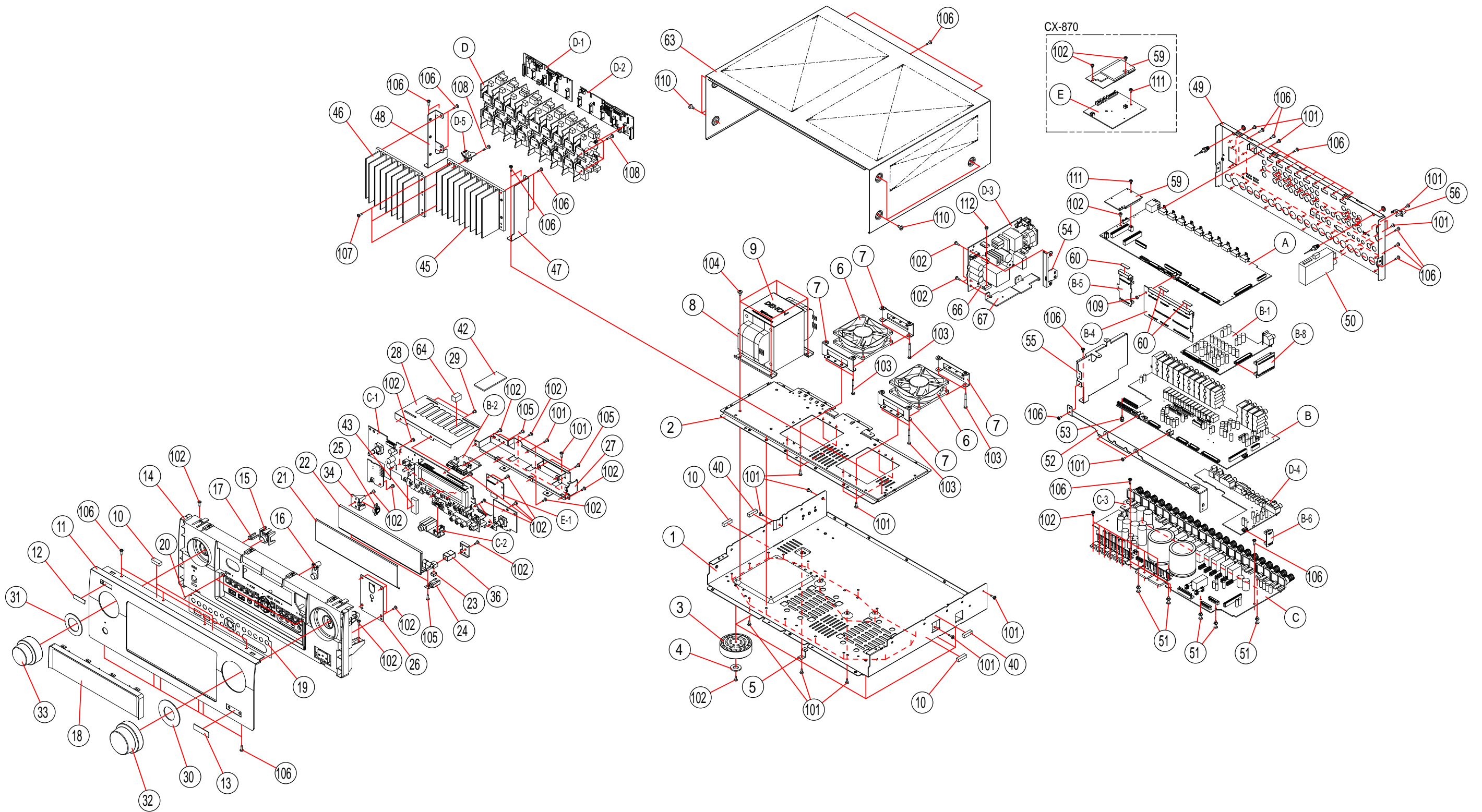

**WARNING:**  
Parts marked with this symbol  $\triangle$  have critical characteristics.  
Use ONLY replacement parts recommended by the manufacturer.

# PACKING VIEW

Please see the last chapter for the part list.

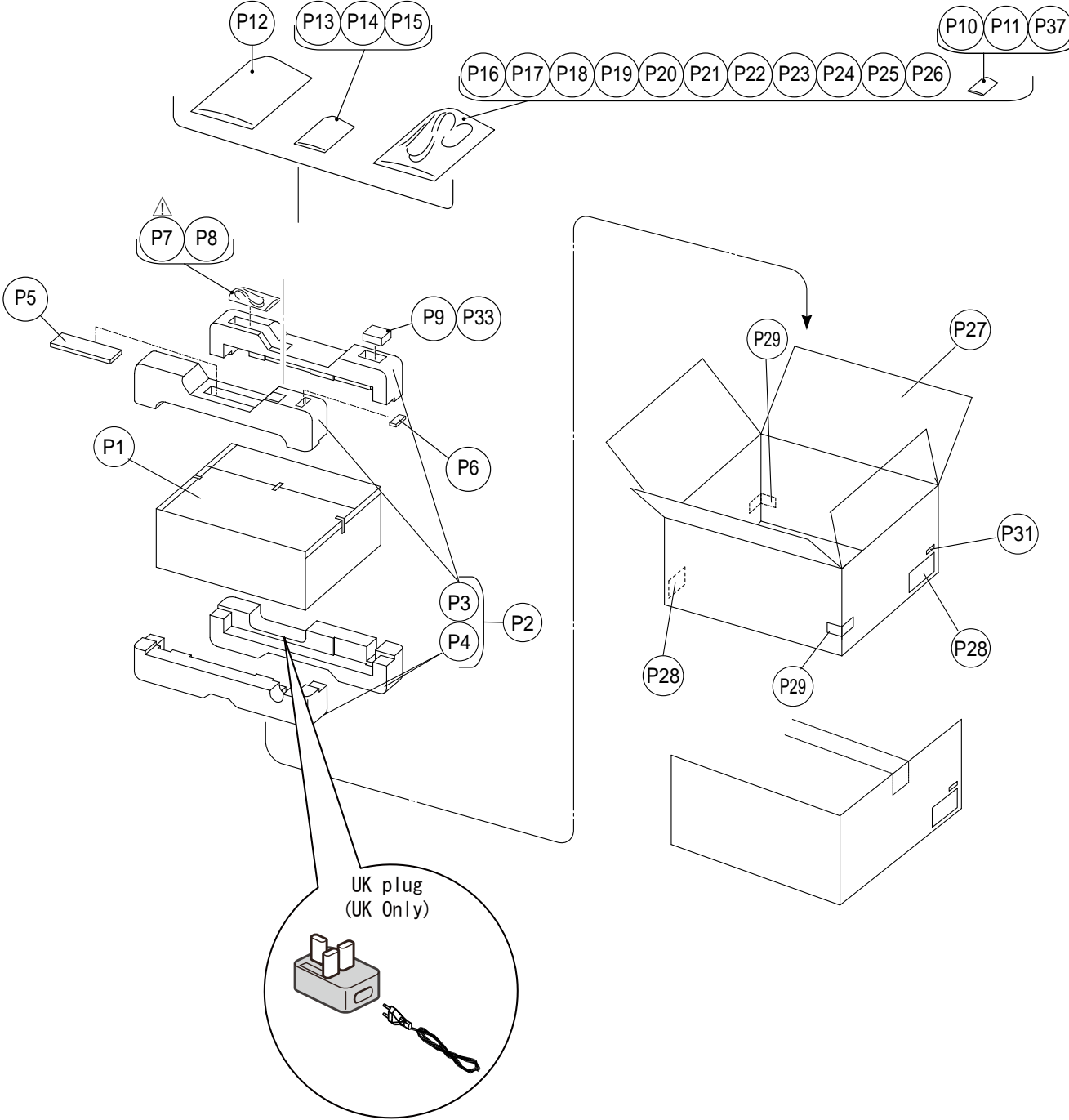

# SEMICONDUCTORS

Only major semiconductors are shown, general semiconductors etc. are omitted to list.  
The semiconductor which described a detailed drawing in a schematic diagram are omitted to list.

## 1. IC's

### R5F56108VNFP (HDMI : U5001)

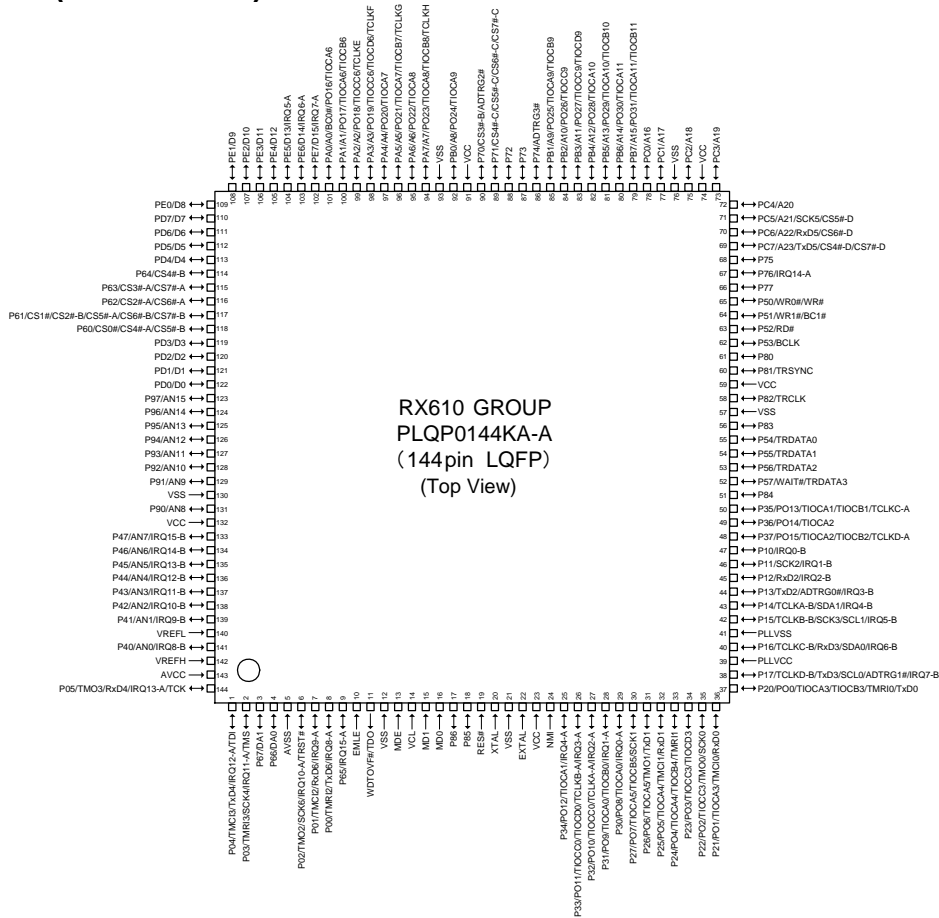

### R5F56108VNFP Terminal Functions

Pin	Pin Name	Symbol	I/O	Pull up/down	LvCnv	STBY	STOP	CEC STBY	Function
1	P04/IRQ12-A/TMC13/TxD4/TDI	NC	I	M3VPu	-	I	I	I	NC
2	P03/IRQ11-A/TMR13/SCK4/TMS	NC	I	M3VPu	-	I	I	I	NC
3	P67/DA1	HIN SELA	O	-	-	L	L	L	TC74VHC4051AFT control pin. (Control the detection of HDMI 5V INPUT for CEC STANDBY.)
4	P66/DA0	HIN SELB	O	-	-	L	L	L	TC74VHC4051AFT control pin. (Control the detection of HDMI 5V INPUT for CEC STANDBY.)
5	AVSS	AVSS	-	-	-	-	-	-	GND
6	P02/IRQ10-A/TMO2/SCK6/TRST#	NC	I	Pd	-	I	I	I	NC
7	P01/IRQ9-A/TMC12/RxD6	RXD MI232O	I	M3VPu	-	I	I	I	Data received from the external pin(AMX)/Use for firmware upgrading by DFW.
8	P00/IRQ8-A/TMR12/TxD6	TXD MO232I	O	-	-	L	L	L	Data transfer to external pin(AMX)/Use for firmware upgrading by DFW.
9	P65/IRQ15-A	POWER KEY	I	M3VPu	-	I	I	I	POWER KEY (Waiting Mode cancel, interrupt port)
10	EMLE	NC	I	Pd	-	-	-	-	NC
11	WDTOVF#/TDO	NC	O/O	-	-	-	-	-	NC
12	VSS	VSS	I	-	-	-	-	-	GND
13	MDE	MDE	I	Pd	-	-	-	-	NC
14	VCL	VCL	I	-	-	-	-	-	Smoothing capacitor connection pin
15	MD1	MD1	I	M3VPu	-	-	-	-	NC
16	MD0	MD0	I	M3VPu	-	-	-	-	NC

Pin	Pin Name	Symbol	I/O	Pull up/ down	LvCnv	STBY	STOP	CEC STBY	Function
17	P86	(CEC POWER2)	O	-	-	L	L	H	Reserve (CEC POWER2 control)
18	P85	R E M O T E POWER(232C)	O	-	-	L	L	L	232C POWER SUPPLY (REMOTE 3.3V) control pin.(ON: H)
19	RES#	RESET	I	-	-	-	-	-	Reset input (reset: L)
20	XTAL	XTAL	I	-	-	-	-	-	Clock input
21	VSS	VSS	-	-	-	-	-	-	GND
22	EXTAL	EXTAL	-	-	-	-	-	-	Clock output
23	VCC	VCC	-	-	-	-	-	-	+3.3V
24	NMI	NMI	I	M3VPu	-	-	-	-	NC
25	P34/IRQ4-A/PO12/ TIOCA1	BDOWN	I	-	-	I	I	I	Power failure detection pin(Power failure:L)
26	P33/IRQ3-A/PO11/ TIOCC0/TIOCD0/ TCLKB-A	PLDAERR	I	-	-	L	L	L	PLD ERROR detection pin
27	P32/IRQ2-A/PO10/ TIOCC0/TCLKA-A	NC	O	-	-	L	O	L	Unused
28	P31/IRQ1-A/PO9/ TIOCA0/TIOCB0	ADV8003 INT1	I	-	-	I	I	I	HDMI transmitter / OSD (ADV8003) INT1 Input pin
29	P30/IRQ0-A/PO8/ TIOCA0	RC IN	I	-	-	I	I	I	Remote control signal input pin
30	P27/PO7/TIOCA5/ TIOCB5/SCK1	HDMI A SEL	O	-	-	L	L	L	TC74VHCT244AFT control pin. (Control the HDMI Audio input. H : DSP signal path / L : HDMI Rx -> Tx )
31	P26/PO6/TIOCA5/ TMO1/TxD1	NC	O	-	-	L	L	L	Unused
32	P25/PO5/TIOCA4/ TMC1/RxD1	NC	O	-	-	L	L	L	Unused
33	P24/PO4/TIOCA4/ TIOCB4/TMRI1	TU RST	O	SW3VPu	-	L	L	L	TUNER RESET pin (E3 model)
34	P23/PO3/TIOCC3/ TIOCD3	E RESET	O	N3VPu	-	L	L	L	ETHERNET RESET control pin (DM860)
35	P22/PO2/TIOCC3/ TMO0/SCK0	E POWER	O	-/-	-	L	L	L	ETHERNET POWER SUPPLY (NET3.3V) control pin.(ON:H)
36	P21/PO1/TIOCA3/ TMC10/RxD0	E_RXDMIEO	I	-/-	-	I	I	I	ETHERNET communication control pin (DM860)
37	P20/PO0/TIOCA3/ TIOCB3/TMRI0/TxD0	E_TXDMOEI	O	-/-	-	L	L	L	ETHERNET communication control pin (DM860)
38	P 1 7 / I R Q 7 - B / T C L K D - B / T x D 3 / SCL0/ADTRG1#	TU SCLK	O	-	-	L	L	L	TUNER control pin
39	PLLVCC	PLLVCC	-	-	-	-	-	-	+3.3V
40	P 1 6 / I R Q 6 - B / T C L K C - B / R x D 3 / SDA0	TU SDIO	I_O	-	-	L	L	L	TUNER control pin
41	PLLVSS	PLLVSS	-	-	-	-	-	-	GND
42	P 1 5 / I R Q 5 - B / T C L K B - B / S C K 3 / SCL1	HSCL (400k)	O	CEC3VPu	-	L	L	L	VIDEO I2C Control for - HDMI SW (ADV3002) / HDMI RX , A to H Decoder (ADV7850) / HDMI ip Scaler , TX (ADV8003)
43	P 1 4 / I R Q 4 - B / TCLKA-B/SDA1	HSDA (400k)	I_O	CEC3VPu	-	L	L	L	VIDEO I2C Control for - HDMI SW (ADV3002) / HDMI RX , A to H Decoder (ADV7850) / HDMI ip Scaler , TX (ADV8003)
44	P13/IRQ3-B/TxD2/ ADTRG0#	ADV8003 SPI MO	O	-	-	L	L	L	OSD control pin (ADV8002 or ADV8003)
45	P12/IRQ2-B/RxD2	ADV8003 SPI MI	I	-	-	L	L	L	OSD control pin (ADV8002 or ADV8003)
46	P11/IRQ1-B/SCK2	ADV8003 SPI CLK	O	-	-	L	L	L	OSD control pin (ADV8002 or ADV8003)
47	P10/IRQ0-B	ADV8003 SPI CS	O	-	-	L	L	L	OSD control pin (ADV8002 or ADV8003)
48	P37/PO15/TIOCA2/ TIOCB2/TCLKD-A	EEPROM SDA	I_O	M3VPu	-	I	I	I	EEPROM control pin
49	P36/PO14/TIOCA2	EEPROM SCL	O	M3VPu	-	I	I	I	EEPROM control pin
50	P35/PO13/TIOCA1/ TIOCB1/TCLKC-A	ADV7850 RST	O	-	-	L	L	L	HDMI RX , A to H Decoder (ADV7850) RESET control pin
51	P84	CEC_OUT	O	-	-	L	L	-	CEC-D signal output pin
52	P 5 7 / W A I T # / TRDATA3	ADV3002 RST	O	SW3VPu	-	L	L	L	HDMI switcher RESET control pin (ADV3002)
53	P56/TRDATA2	E SPI MOEI	O	N3VPu	-	L	L	L	ETHERNET communication control pin (DM860)
54	P55/TRDATA1	ADV8003 RST	O	SW3VPu	-	L	L	L	HDMI Tx/ip Scaler/OSD RESET control pin (ADV8003)



Pin	Pin Name	Symbol	I/O	Pull up/ down	LvCnv	STBY	STOP	CEC STBY	Function
55	P54/TRDATA0	E SPI MIEO	I	N3VPu	-	I	L	I	ETHERNET communication control pin (DM860)
56	P83	E SPI CLK	O	N3VPu	-	L	L	L	ETHERNET communication control pin (DM860)
57	VSS	VSS	-	-	-	-	-	-	GND
58	P82/TRCLK	FL CE	O	-	-	L	L	L	VFD control pin
59	VCC	VCC	-	-	-	-	-	-	+3.3V
60	P81/TRSYNC	FL RST	O	-	-	L	L	L	VFD control pin
61	P80	ZVOL DATA	O	-	-	L	L	L	ZONE VOLUME control pin (NJW1194)
62	BCLK/P53	NC	I	-	-	I	I	I	NC
63	P52/RD#	ZVOL CLK	O	-	-	L	L	L	ZONE VOLUME control pin (NJW1194)
64	P51/WR1#/BC1#	ZVOL STB	O	-	-	L	L	L	ZONE VOLUME control pin (NJW1194)
65	P50/WR0#/WR#	V SDA	O	-	-	L	L	L	A-VIDEO switcher control pin (AVDM-2000)
66	P77	V SCL	O	-	-	L	L	L	A-VIDEO switcher control pin (AVDM-2000)
67	P76/IRQ14-A	TU GPO2_INT	I	-	-	L	L	L	TUNER GPIO2 input pin
68	P75	DSP ROMRST	O	-	-	I	I	I	Memory reset for DSP (Reset : L)
69	PC7/A23/CS4#-D/ CS7#-D/TxD5	DSP MOSI	O	DA3VPu	-	L	L	L	DSP control pin (ADSP21487KSWZ-3B)
70	PC6/A22/CS6#-D/ RxD5	DSP MISO	I	DA3VPu	-	L	L	L	DSP control pin (ADSP21487KSWZ-3B)
71	PC5/A21/CS5#-D/ SCK5	DSPI CLK	O	DA3VPu	-	L	L	L	DSP control pin (ADSP21487KSWZ-3B)
72	PC4/A20	DSP RST	O	-	-	L	L	L	DSP(ADSP21487KSWZ-3B) reset output pin (Reset : L)
73	PC3/A19	DSP FLAG0	I	Pd	-	L	L	L	DSP control pin (ADSP21487KSWZ-3B)
74	VCC	VCC	-	-	-	-	-	-	+3.3V
75	PC2/A18	DSP ICS	O	DA3VPu	-	L	L	L	DSP control pin (ADSP21487KSWZ-3B)
76	VSS	VSS	-	-	-	-	-	-	GND
77	PC1/A17	GRN LED	O	-	-	L	L	L	POWER LED control pin(ON:H)
78	PC0/A16	RED LED	O	-	-	L	L	H	POWER/STANDBY LED control pin (ON:H)
79	PB7/A15/PO31/ TIOCA11/TIOCB11	H/P RLY	O	-	-	L	L	L	HEADPHONE RLY control pin
80	PB6/A14/PO30/ TIOCA11	FRONT RLY	O	-	-	L	L	L	FRONT Ch RELAY control pin
81	PB5/A13/PO29/ TIOCA10/TIOCB10	HIN SELC	O	-	-	L	L	L	TC74VHC4051AFT control pin. (Control the detection of HDMI 5V INPUT for CEC STANDBY.)
82	PB4/A12/PO28/ TIOCA10	TU_SEN	O	-	-	L	L	L	TUNER control pin
83	PB3/A11/PO27/ TIOCC9/TIOCD9	C/S RLY	O	-	-	L	L	L	CENTER/SURROUND Ch RELAY control pin
84	PB2/A10/PO26/ TIOCC9	SB RLY	O	-	-	L	L	L	SURROUND-BACK Ch RELAY control pin
85	PB1/A9/PO25/ TIOCA9/TIOCB9	D5V POWER	O	-	-	L	L	L	DIGITAL POWER SUPPLY (D3.3V) control pin (ON:H)
86	P74/ADTRG3#	DIR CE	O	-	-	L	L	L	DIR control pin (LC89058W-E)
87	P73	DIR DIN	O	-	-	L	L	L	DIR control pin (LC89058W-E)
88	P72	DIR DOUT	I	DA3VPu	-	I	I	I	DIR control pin (LC89058W-E)
89	P71/CS4#-C/ CS5#-C/CS6#-C/ CS7#-C	DIR CLK	O	-	-	L	L	L	DIR control pin (LC89058W-E)
90	P70/CS3#-B/ ADTRG2#	DIR RST	O	-	-	L	L	L	DIR RESET pin (LC89058W-E)
91	VCC	VCC	-	-	-	-	-	-	+3.3V
92	PB0/A8/PO24/ TIOCA9	CEC SEL	O	-	-	L	L	L	CEC output LINE switching
93	VSS	VSS	-	-	-	-	-	-	GND
94	PA7/A7/PO23/ TIOCA8/TIOCB8/ TCLKH	NC	O/O	-/-	-	L	L	L	Unused
95	PA6/A6/PO22/ TIOCA8	VS ELA	I	-	-	I	I	I	Master Volume rotation detection pin(Rotary encoder)
96	PA5/A5/PO21/ TIOCA7/TIOCB7/ TCLKG	VS ELB	I	-	-	I	I	I	Master Volume rotation detection pin(Rotary encoder)
97	PA4/A4/PO20/ TIOCA7	E POWER 2 (Reserve)	O	-/-	-	L	L	L	Unused

Pin	Pin Name	Symbol	I/O	Pull up/ down	LvCnv	STBY	STOP	CEC STBY	Function
98	PA3/A3/PO19/ TIOCC6/TIOCD6/ TCLKF	DAC(ETHER) MUTE	O	-	-	L	L	L	DAC(ETHER) MUTE control pin (PCM5100 for DM860)
99	PA2/A2/PO18/ TIOCC6/TCLKE	PRE Z2 MUTE	O	-	-	L	L	L	Z2 PRE OUT MUTE control pin
100	PA1/A1/PO17/ TIOCA6/TIOCB6	NC	O	-	-	L	L	L	Unused
101	PA0/A0/BC0#/PO16/ TIOCA6	PRE MUTE	O	-	-	L	L	L	Sub Woofer PRE OUT MUTE control pin
102	PE7/IRQ7-A/D15	ADV8003 INT2	I	-	-	I	I	I	HDMI TX1.0SD INT2 input pin (ADV8003)
103	PE6/IRQ6-A/D14	ADV7850 INT1	I	-	-	I	I	I	HDMI RX INT1 input pin (ADV7850)
104	PE5/IRQ5-A/D13	ADV7850 INT2	I	-	-	L	L	L	HDMI RX INT2 input pin (ADV7850)
105	PE4/D12	ISEL A	I/O	-	-	I/L	I/L	I/L	Input Selector rotation detection pin(Rotary encoder)
106	PE3/D11	ISEL B	I/O	-	-	I/L	I/L	I/L	Input Selector rotation detection pin(Rotary encoder)
107	PE2/D10	VOL CLK	O	-	-	L	L	L	FUNCTION / VOLUME control pin (R2A15218)
108	PE1/D9	VOL DATA	O	-	-	L	L	L	FUNCTION / VOLUME control pin (R2A15218)
109	PE0/D8	PLD WRITE	O	-	-	L	L	L	A.PLD /JTAG switching control pin
110	PD7/D7	JTAG TDO	I	-	-	L	L	L	A.PLD rewriting control pin (JTAG)
111	PD6/D6	JTAG TMS/APLD CS	O/O	-	-	L	L	L	A.PLD rewriting & control pin
112	PD5/D5	JTAG TDI/APLD DATA/DAC DATA	O/O	-	-	L	L	L	A.PLD rewriting & control /DAC control pin
113	PD4/D4	JTAG TCK/APLD CLK/DAC CLK	O/O	-	-	L	L	L	A.PLD rewriting & control /DAC control pin
114	P64/CS4#-B	ADC RST	O	-	-	L	L	L	A/D converter control pin (AK5358B)
115	P63/CS3#-A/CS7#-A	NC	O	-	-	L	L	L	Unused
116	P62/CS2#-A/CS6#-A	E SPI CS	O	N3VPu	-	L	L	L	ETHERNET communication control pin(DM860)
117	P61/CS1#/CS2#-B/ CS5#-A/CS6#-B/ CS7#-B	DAC MS	O	-	-	L	L	L	D/A converter control pin (AK4358VQ)
118	P60/CS0#/CS4#-A/ CS5#-B	DAC RST	O	-	-	L	L	L	D/A converter control pin (AK4358VQ)
119	PD3/D3	NC	O	-	-	L	L	L	Unused
120	PD2/D2	NC	O	-	-	L	L	L	Unused
121	PD1/D1	FL CLK	O	-	-	L	L	L	VFD control pin
122	PD0/D0	FL DATA	O	-	-	L	L	L	VFD control pin
123	P97/AN15	DA POWER	O	-	-	L	L	L	DIGITAL AUDIO POWER SUPPLY (DA3.3V & DA1.2V) control pin.(ON:H)
124	P96/AN14	CEC POWER	O	-	-	L	L	H	HDMI CEC POWER SUPPLY (CEC5V & CEC3.3V & CEC1.8V) control pin. (ON:H)
125	P95/AN13	DV POWER1	O	-	-	L	L	*	Digital VIDEO POWER SUPPLY (DV5V & DV3.3V) control pin. *CEC STANDBY : MODE1=H , MODE2=L , MODE3=L
126	P94/AN12	DV POWER2	O	-	-	L	L	*	Digital VIDEO POWER SUPPLY (DV1.8V) control pin. *CEC STANDBY : MODE1=H , MODE2=L , MODE3=L
127	P93/AN11	MAIN POWER	O	-	-	L	L	L	MAIN POWER control pin
128	P92/AN10	CPU POWER	O	-	-	L	L	L	CPU INTERFACE POWER SUPPLY (SWM3.3V & SWM5V) control pin (POWER ON: H , CEC ON STANDBY: H)
129	P91/AN9	TX EN	O	-	-	L	L	L	Front HDMI INPUT (AD8195) control pin
130	VSS	VSS	-	-	-	-	-	-	GND
131	P90/AN8	MODE	I	-	-	I	I	I	Destination detection pin
132	VCC	VCC	-	-	-	-	-	-	+3.3V
133	P47/IRQ15-B/AN7	THERMAL B/DC DET/ASO	I	-	-	I	I	I	ASO PROTECT / DC PROTECT / HEAT PROTECT-B detection pin
134	P46/IRQ14-B/AN6	H/P DET / MIC DET/THERMAL A	I	-	-	I	I	I	MIC detection / Headphone detection / HEAT PROTECT-A detection pin
135	P45/IRQ13-B/AN5	KEY3	I	SW3VPu	-	I	I	I	Button input 3
136	P44/IRQ12-B/AN4	KEY2	I	SW3VPu	-	I	I	I	Button input 2
137	P43/IRQ11-B/AN3	KEY1	I	SW3VPu	-	I	I	I	Button input 1
138	P42/IRQ10-B/AN2	E SPI REQ	I	Pd	-	I	L	I	ETHERNET communication control pin(DM860)

Pin	Pin Name	Symbol	I/O	Pull up/ down	LvCnv	STBY	STOP	CEC STBY	Function
139	P41/IRQ9-B/AN1	HDMI IN 5V SET	I	-	-	I	I	I	HDMI INPUT 5V (for EDID / HOT PLUG) detection pin
140	AVSS	AVSS	-	-	-	-	-	-	GND
141	P40/IRQ8-B/AN0	CEC_IN	I	SW3VPu	-	I	I	I	CEC-D signal input pin
142	VREF	VREF	-	-	-	-	-	-	Reference voltage (+3.3V) input pin for A/D port
143	AVCC	AVCC	-	-	-	-	-	-	+3.3V
144	P05/IRQ13-A/TMO3/ Rx/D4/TCK	NC	I	M3VPu	-	I	I	I	NC

## R5F5210ABDFP (HDMI : U2101)

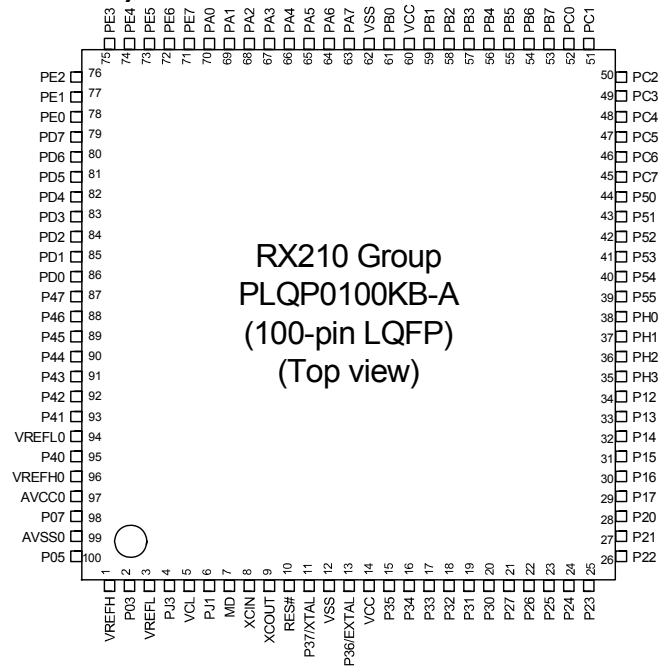

RX210 Group  
PLQP0100KB-A  
(100-pin LQFP)  
(Top view)

## R5F5210ABDFP Terminal Functions

Pin	Symbol	Pin Name	I/O	Pu/Pd	LvCnv	STBY	CEC STBY	Function
1	VREFH	VREFH	-	-	-	-	-	+3.3V
2	P03/DA0	NET/HDMI	O	C	-	Z	L	VPLD control pin (H:NET/WiFi/USB/BT,L:HDMI)
3	VREFL	VREFL	-	-	-	-	-	GND
4	PJ3	778_3/778_2	O	C	-	Z	-	Audio data Bus control pin (HDMI input) (H:MN8647781_3,L:MN8647781_2)
5	VCL	VCL	I	-	-	-	-	Smoothing capacitor connection pin
6	PJ1	TX/RX	O	C	-	Z	-	NC
7	MD	MD	I	-	SCPU 3VPu	-	-	Single-chip/Micro-processor mode switching (Normal single-chip : L, Rewrite boot program start : H input set)
8	XCIN	XCIN	I	-	-	-	-	NC
9	XCOUT	XCOUT	O	-	-	-	-	NC
10	RES#	SUB_RESET	I	-	SCPU 3VPu	Z	-	Reset input
11	XTAL/P37	XTAL	O	-	-	-	-	Oscillator connection
12	VSS	VSS	-	-	-	-	-	GND
13	EXTAL/P36	EXTAL	I	-	-	-	-	Oscillator connection
14	VCC	VCC	-	-	-	-	-	+3.3V
15	P35/NMI(input)	NMI	I	-	SCPU 3VPu	-	-	NC
16	P34/SCK6/IRQ4	CEC_OUT	O	C	-	Z	-	CEC-D signal output pin
17	P33/RXD6/SSCL6/IRQ3-DS	778_2_HAINT	I	-	-	Z	-	HDMI MN8647781(RX) Audio INT input pin
18	P32/TXD6/SSDA6/IRQ2-DS	CEC_IN	I	-	SCPU 3VPu	Z	-	CEC-D signal input pin
19	P31/IRQ1-DS	ACKSIMO	I	-	-	Z	-	MAIN-SUB ucom communication control pin
20	P30/RXD1/SSCL1/IRQ0DS	SCPURXD	I	-	Pd	Z	-	Data reception input from the external
21	P27/SCK1	DIRCE	O	C	-	Z	L	DIR control pin(PCM9211)
22	P26/TXD1/SSDA1	SCPUTXD	O	C	SCPU 3VPu	Z	-	Data transmission output to external
23	P25	DIRDOUT	I	-	DA 3.3Pu	Z	-	DIR control pin(PCM9211)
24	P24	DIRCLK	O	C	-	Z	L	DIR control pin(PCM9211)
25	P23	REQSOMI	O	C	-	Z	-	MAIN-SUB ucom communication control pin
26	P22/SCK0	CLKSIMO	I	-	-	Z	-	MAIN-SUB ucom communication control pin
27	P21/RXD0/SSCL0	SIMO	I	-	-	Z	-	MAIN-SUB ucom communication control pin
28	P20/TXD0/SSDA0	SOMI	O	C	-	Z	-	MAIN-SUB ucom communication control pin
29	P17/SCK1/IRQ7	DIRRST	O	C	-	O/L	L	DIR control pin(PCM9211)
30	P16/TXD1/SSDA1/IRQ6	DIRDIN	O	C	-	Z	L	DIR control pin(PCM9211)
31	P15/RXD1/SSCL1/IRQ5	SUB_BDOWN	I	-	-	Z	-	Power failure detect(Power failure:L)
32	P14/IRQ4	NC	O	C	-	Z	-	NC
33	P13/SDA/IRQ3	NC	O	C	-	Z	-	NC

Pin	Symbol	Pin Name	I/O	Pu/Pd	LvCnv	STBY	CEC STBY	Function
34	P12/SCL/IRQ2	778_1_RST	O	C	Pd	Z	※	HDMI MN8647781(TX) RESET control pin
35	PH3	HSDA	I/O	C	CEC 3VPu	O/L	L	HDMI I2C- MN8647781
36	PH2/IRQ1	HSCL	I/O	C	CEC 3VPu	O/L	L	HDMI I2C- MN8647781
37	PH1/IRQ0	778_1_HINT	I	-	-	Z	-	HDMI MN8647781(TX) HDMI INT input pin
38	PH0	778_2_RST	O	C	Pd	Z	※	HDMI MN8647781(RX) RESET control pin
39	P55	778_2_HINT	I	-	-	Z	-	HDMI MN8647781(RX) HDMI INT input pin
40	P54	778_3_RST	O	C	Pd	Z	※	HDMI MN8647781(RX) RESET control pin
41	BCLK/P53	778_3_HINT	I	-	-	Z	-	HDMI MN8647781(RX) HDMI INT input pin
42	P52	IP_RST	O	C	Pd	Z	L	HDMI ADV8003 RESET control pin
43	P51	DE_RST	O	C	Pd	Z	L	HDMI ADV7850 RESET control pin
44	P50	DE_INT	I	-	-	Z	-	HDMI ADV7850 HDMI INT input pin
45	PC7/TXD8/SSDA8	UB	I	-	Pd	Z	-	Unused
46	PC6/RXD8/SSCL8	HINSELA	O	C	-	Z	-	TC74VHC4051AFT control pin. (Control the detection of HDMI 5V INPUT for CEC STANDBY. )
47	PC5/SCK8	HINSELB	O	C	-	Z	-	TC74VHC4051AFT control pin. (Control the detection of HDMI 5V INPUT for CEC STANDBY. )
48	PC4/SCK5	HINSELC	O	C	-	Z	-	TC74VHC4051AFT control pin. (Control the detection of HDMI 5V INPUT for CEC STANDBY. )
49	PC3/TXD5/SSDA5	DSPMOSI	O	C	DA3 VPu	Z	L	DSP control pin (ADSP21487KSWZ-3B)
50	PC2/RXD5/SSCL5	DSPMISO	I	-	DA3 VPu	Z	-	DSP control pin (ADSP21487KSWZ-3B)
51	PC1/SCK5	DSPICLK	O	C	DA3 VPu	Z	L	DSP control pin (ADSP21487KSWZ-3B)
52	PC0	DA_POWER	O	C	-	Z	L	DIGITAL AUDIO POWER SUPPLY (DA3.3V & DA1.1V) control pin.(ON:H)
53	PB7/TXD9/SSDA9	AVSDA	I/O	C	DV3 VPu	O/L	L	VIDEO I2C- ADV8003/ADV7850
54	PB6/RXD9/SSCL9	AVSCL	I/O	C	DV3 VPu	O/L	L	VIDEO I2C- ADV8003/ADV7850
55	PB5/SCK9	CEC_POWER	O	C	-	Z	※	HDMI CEC POWER SUPPLY control pin (CEC5V,CEC3.3V,CEC1.8V)
56	PB4	DV_POWER1	O	C	-	Z	L	Digital VIDEO POWER SUPPLY control pin (DV5V,DV3.3V)
57	PB3/SCK8	DV_POWER2	O	C	-	Z	-	Digital VIDEO POWER SUPPLY control pin (DV1.8V)
58	PB2	H5VDET	I	-	-	Z	-	HDMI INPUT 5V (for EDID / HOT PLUG) detection pin
59	PB1/TXD6/SSDA6/IRQ4-DS	778_3_HAINT	I	-	-	Z	-	HDMI MN8647781(RX) Audio INT input pin
60	VCC	VCC	-	-	-	-	-	+3.3V
61	PB0/RXD6/SSCL6	NC	O	C	-	Z	-	NC
62	VSS	VSS	-	-	-	-	-	GND
63	PA7	HPD8	O	C	-	Z	L	HPD8 output pin
64	PA6	HPD7	O	C	-	Z	L	HPD7 output pin
65	PA5	HPD6	O	C	-	Z	L	HPD6 output pin
66	PA4/TXD5/SSDA5/IRQ5-DS	HPD5	O	C	-	Z	L	HPD5 output pin
67	PA3/RXD5/SSCL5/IRQ6-DS	HPD4	O	C	-	Z	L	HPD4 output pin
68	PA2/RXD5/SSCL5	HPD3	O	C	-	Z	L	HPD3 output pin
69	PA1/SCK5	HPD2	O	C	-	Z	L	HPD2 output pin
70	PA0	HPD1	O	C	-	Z	L	HPD1 output pin
71	PE7/IRQ7/AN015	APLDCK	O	C	-	Z	L	A.PLD control pin
72	PE6/IRQ6/AN014	APLDCS	O	C	-	O/L	L	A.PLD control pin
73	PE5/IRQ5/AN013	APLDDI	O	C	-	Z	L	A.PLD control pin
74	PE4/AN012	SUB_TCK	O	C	Pd	Z	L	A.PLD/V.PLD rewriting pin(JTAG)
75	PE3/AN011	SUB_TDI	O	C	DA 3.3Pu	Z	L	A.PLD/V.PLD rewriting pin(JTAG)
76	PE2/RXD12/SSCL12/IRQ7-DS/AN010	SUB_TDO	I	-	-	Z	L	A.PLD/V.PLD rewriting pin(JTAG)
77	PE1/TXD12/SSDA12/AN009	SUB_TMS	O	C	DA 3.3Pu	Z	L	A.PLD/V.PLD rewriting pin(JTAG)
78	PE0/SCK12/AN008	DACRST1	O	C	-	Z	L	D/A converter control pin(PCM1690)
79	PD7/IRQ7	NC	O	C	-	Z	-	NC
80	PD6/IRQ6	DACMC	O	C	-	Z	L	D/A converter control pin(PCM1690)
81	PD5/IRQ5	DACMD	O	C	-	Z	L	D/A converter control pin(PCM1690)
82	PD4/IRQ4	DACMS1	O	C	-	Z	L	D/A converter control pin(PCM1690)
83	PD3/IRQ3	NC	O	C	-	Z	-	NC
84	PD2/IRQ2	DSP1RST	O	C	-	Z	L	DSP(ADSP21487KSWZ-3B) reset output pin (Reset : L)

Pin	Symbol	Pin Name	I/O	Pu/Pd	LvCnv	STBY	CEC STBY	Function
85	PD1/IRQ1	DSP1CS	O	C	DA 3VP <sub>u</sub>	Z	L	DSP control pin (ADSP21487KSWZ-3B)
86	PD0/IRQ0	DSP1FLAG0	I	-	Pd	Z	-	DSP control pin (ADSP21487KSWZ-3B)
87	P47/AN007	NC	O	C	-	Z	-	NC
88	P46/AN006	VIN A	O	C	-	Z	-	COMPOSITE VIDEO SELECT IC(NJM2595)
89	P45/AN005	VIN B	O	C	-	Z	-	COMPOSITE VIDEO SELECT IC(NJM2595)
90	P44/AN004	VIN C	O	C	-	Z	-	COMPOSITE VIDEO SELECT IC(NJM2595)
91	P43/AN003	COMP SW1	O	C		O/L	L	COMPONENT VIDEO SELECT IC(NJM2586)
92	P42/AN002	COMP SW2	O	C		O/L	L	COMPONENT VIDEO SELECT IC(NJM2586)
93	P41/AN001	NC	O	C	-	Z	-	NC
94	VREFL0	VREFL0	-	-	-	-	-	GND
95	P40/AN000	NC	O	C	-	Z	-	NC
96	VREFH0	VREFH0	-	-	-	-	-	+3.3V
97	AVCC0	AVCC	-	-	-	-	-	+3.3V
98	P07	NC	O	C	-	Z	-	NC
99	AVSS0	AVSS0	-	-	-	-	-	GND
100	P05	TXEN	O	C	-	Z	-	Front HDMI INPUT (AD8195) control pin

## PCM9211 (HDMI : U1000)

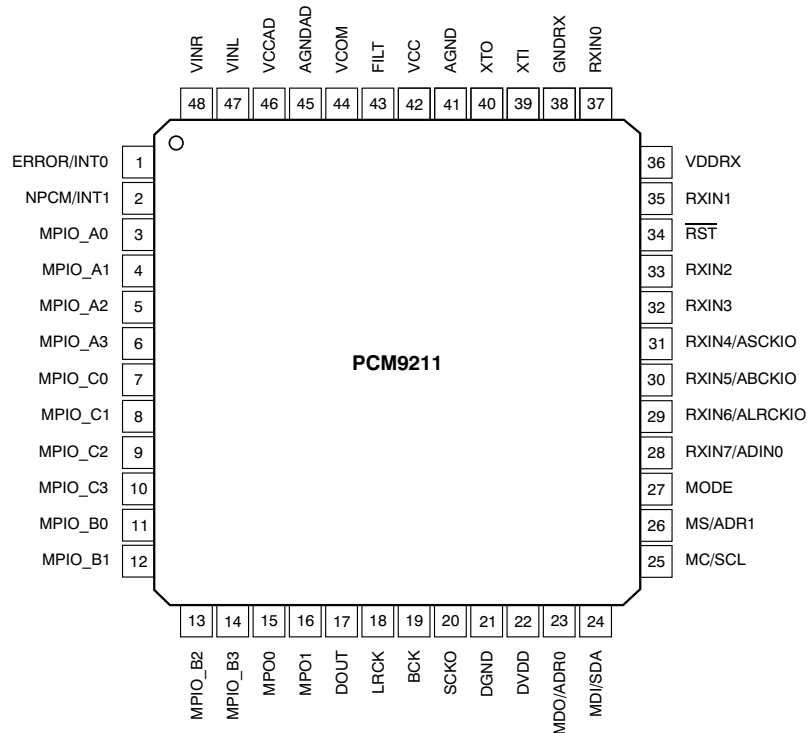

### PIN Functions

PIN				DESCRIPTION
NO.	NAME	I/O	5-V TOLERANT	
1	ERROR/INT0	O	No	DIR Error detection output / Interrupt0 output
2	NPCM/INT1	O	No	DIR Non-PCM detection output / Interrupt1 output
3	MPIO_A0	I/O	Yes	Multipurpose I/O, Group A(1)
4	MPIO_A1	I/O	Yes	Multipurpose I/O, Group A(1)
5	MPIO_A2	I/O	Yes	Multipurpose I/O, Group A(1)
6	MPIO_A3	I/O	Yes	Multipurpose I/O, Group A(1)
7	MPIO_C0	I/O	Yes	Multipurpose I/O, Group C(1)
8	MPIO_C1	I/O	Yes	Multipurpose I/O, Group C(1)
9	MPIO_C2	I/O	Yes	Multipurpose I/O, Group C(1)
10	MPIO_C3	I/O	Yes	Multipurpose I/O, Group C(1)
11	MPIO_B0	I/O	Yes	Multipurpose I/O, Group B(1)
12	MPIO_B1	I/O	Yes	Multipurpose I/O, Group B(1)
13	MPIO_B2	I/O	Yes	Multipurpose I/O, Group B(1)
14	MPIO_B3	I/O	Yes	Multipurpose I/O, Group B(1)
15	MPO0	O	No	Multipurpose output 0
16	MPO1	O	No	Multipurpose output 1
17	DOUT	O	No	Main output port, serial digital audio data output
18	LRCK	O	No	Main output port, LR clock output
19	BCK	O	No	Main output port, Bit clock output
20	SCKO	O	No	Main output port, System clock output
21	DGND	-	-	Ground, for digital
22	DVDD	-	-	Power supply, 3.3 V (typ.), for digital
23	MDO/ADR0	I/O	Yes	Software control I/F, SPI data output / I2C slave address setting0(2)
24	MDI/SDA	I/O	Yes	Software control I/F, SPI data input / I2C data input/output(2) (3)
25	MC/SCL	I	Yes	Software control I/F, SPI clock input / I2C clock input(2)
26	MS/ADR1	I	Yes	Software control I/F, SPI chip select / I2C slave address setting1(2)
27	MODE	I	No	Control mode setting, (see the Serial Control Mode section, Control Mode Pin Setting)
28	RXIN7/ADIN0	I	Yes	Biphase signal, input 7 / AUXIN0, serial audio data input(2)
29	RXIN6/ALRCKIO	I	Yes	Biphase signal, input 6 / AUXIN0, LR clock input(2)
30	RXIN5/ABCKIO	I	Yes	Biphase signal, input 5 / AUXIN0, bit clock input(2)
31	RXIN4/ASCKIO	I	Yes	Biphase signal, input 4 / AUXIN0, system clock input(2)
32	RXIN3	I	Yes	Biphase signal, input 3(2)
33	RXIN2	I	Yes	Biphase signal, input 2(2)



PIN				DESCRIPTION
NO.	NAME	I/O	5-V TOLERANT	
34	RST	I	Yes	Reset Input, active low(2) (4)
35	RXIN1	I	Yes	Biphase signal, input 1, built-in coaxial amplifier
36	VDDR_X	-	-	Power supply, 3.3 V (typ.), for RXIN0 and RXIN1.
37	RXIN0	I	Yes	Biphase signal, input 0, built-in coaxial amplifier
38	GND_R_X	-	-	Ground, for RXIN
39	XTI	I	No	Oscillation circuit input for crystal resonator or external XTI clock source input(5)
40	XTO	O	No	Oscillation circuit output for crystal resonator
41	AGND	-	-	Ground, for PLL analog
42	VCC	-	-	Power supply, 3.3 V (typ.), for PLL analog
43	FILT	O	No	External PLL loop filter connection terminal; must connect recommended filter
44	VCOM	O	No	ADC common voltage output; must connect external decoupling capacitor
45	AGND_A_D	-	-	Ground, for ADC analog
46	VCC_A_D	-	-	Power supply, 5.0 V (typ.), for ADC analog
47	VIN_L	I	No	ADC analog voltage input, left channel
48	VIN_R	I	No	ADC analog voltage input, right channel

- (1) Schmitt trigger input
- (2) Schmitt trigger input
- (3) Open-drain configuration in I2C mode
- (4) Onboard pull-down resistor (50 kΩ, typical)
- (5) CMOS Schmitt trigger input

## PCM9211 BLOCK DIAGRAM

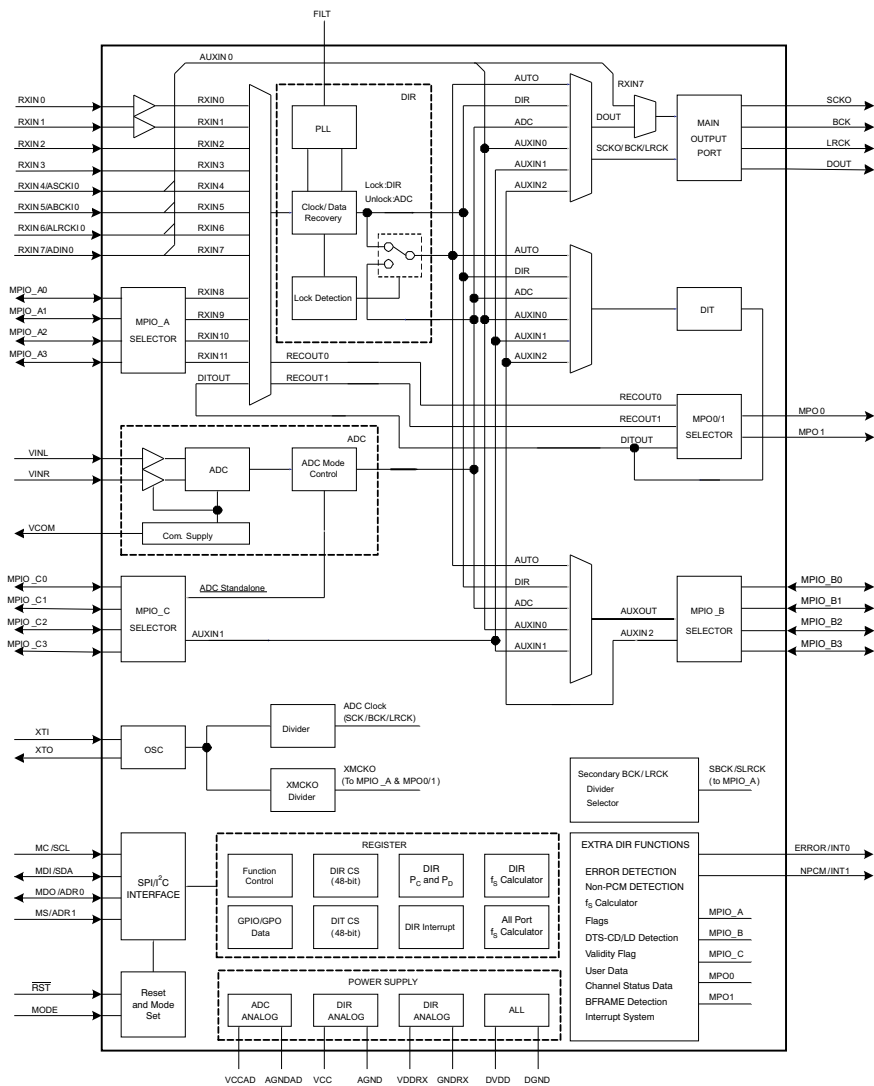

**LC89091JA (DIGITAL : U1004, U1005)**

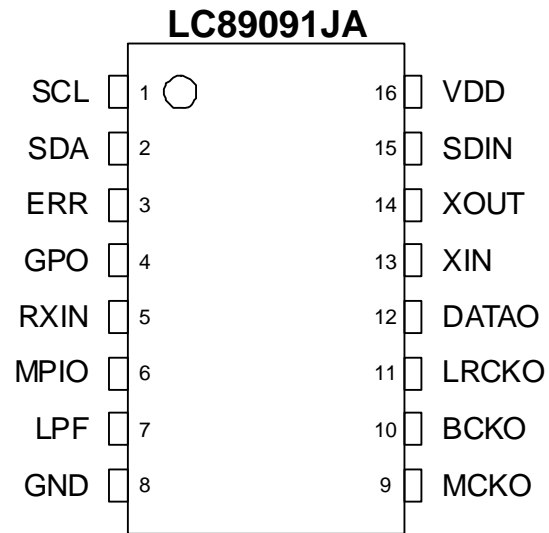

# ADSP21487KSWZ4B (DIGITAL:U101, U201, U301, U401)

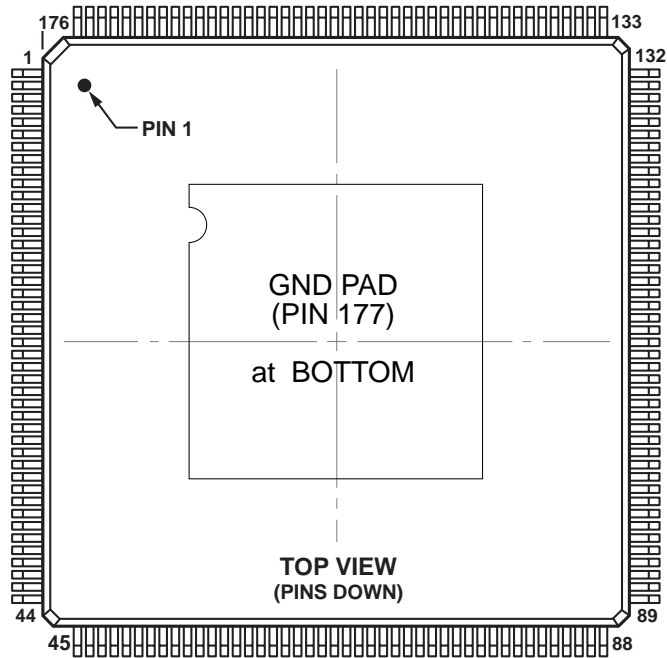

## ADSP21487KSWZ3B Terminal Function

Pin Name	Pin No.	Pin Name	Pin No.	Pin Name	Pin No.	Pin Name	Pin No.
SDDQM	1	V <sub>DD_EXT</sub>	45	DAI_P10	89	V <sub>DD_INT</sub>	133
$\overline{MS0}$	2	DPI_P08	46	V <sub>DD_INT</sub>	90	FLAG0	134
SDCKE	3	DPI_P07	47	V <sub>DD_EXT</sub>	91	FLAG1	135
V <sub>DD_INT</sub>	4	V <sub>DD_INT</sub>	48	DAI_P20	92	FLAG2	136
CLK_CFG1	5	DPI_P09	49	V <sub>DD_INT</sub>	93	NC	137
ADDR0	6	DPI_P10	50	DAI_P08	94	FLAG3	138
BOOT_CFG0	7	DPI_P11	51	DAI_P14	95	NC	139
V <sub>DD_EXT</sub>	8	DPI_P12	52	DAI_P04	96	NC	140
ADDR1	9	DPI_P13	53	DAI_P18	97	V <sub>DD_EXT</sub>	141
ADDR2	10	DPI_P14	54	DAI_P17	98	NC	142
ADDR3	11	DAI_P03	55	DAI_P16	99	V <sub>DD_INT</sub>	143
ADDR4	12	NC	56	DAI_P12	100	TRST	144
ADDR5	13	V <sub>DD_EXT</sub>	57	DAI_P15	101	NC	145
BOOT_CFG1	14	NC	58	V <sub>DD_INT</sub>	102	EMU	146
GND	15	NC	59	DAI_P11	103	DATA0	147
ADDR6	16	NC	60	V <sub>DD_EXT</sub>	104	DATA1	148
ADDR7	17	NC	61	V <sub>DD_INT</sub>	105	DATA2	149
NC	18	V <sub>DD_INT</sub>	62	BOOT_CFG2	106	DATA3	150
NC	19	NC	63	V <sub>DD_INT</sub>	107	TDO	151
ADDR8	20	NC	64	AMI_ACK	108	DATA4	152
ADDR9	21	V <sub>DD_INT</sub>	65	GND	109	V <sub>DD_EXT</sub>	153
CLK_CFG0	22	NC	66	THD_M	110	DATA5	154
V <sub>DD_INT</sub>	23	NC	67	THD_P	111	DATA6	155
CLKIN	24	V <sub>DD_INT</sub>	68	V <sub>DD_THD</sub>	112	V <sub>DD_INT</sub>	156
XTAL	25	NC	69	V <sub>DD_INT</sub>	113	DATA7	157
ADDR10	26	$\overline{WDTRSTO}$	70	V <sub>DD_INT</sub>	114	TDI	158
SDA10	27	NC	71	$\overline{MS1}$	115	SDCLK	159
V <sub>DD_EXT</sub>	28	V <sub>DD_EXT</sub>	72	V <sub>DD_INT</sub>	116	V <sub>DD_EXT</sub>	160
V <sub>DD_INT</sub>	29	DAI_P07	73	WDT_CLKO	117	DATA8	161
ADDR11	30	DAI_P13	74	WDT_CLKIN	118	DATA9	162
ADDR12	31	DAI_P19	75	V <sub>DD_EXT</sub>	119	DATA10	163
ADDR17	32	DAI_P01	76	ADDR23	120	TCK	164
ADDR13	33	DAI_P02	77	ADDR22	121	DATA11	165
V <sub>DD_INT</sub>	34	V <sub>DD_INT</sub>	78	ADDR21	122	DATA12	166
ADDR18	35	NC	79	V <sub>DD_INT</sub>	123	DATA14	167
RESETOUT/RUNRSTIN	36	NC	80	ADDR20	124	DATA13	168
V <sub>DD_INT</sub>	37	NC	81	ADDR19	125	V <sub>DD_INT</sub>	169
DPI_P01	38	NC	82	V <sub>DD_EXT</sub>	126	DATA15	170
DPI_P02	39	NC	83	ADDR16	127	$\overline{SDWE}$	171
DPI_P03	40	V <sub>DD_EXT</sub>	84	ADDR15	128	$\overline{SDRAS}$	172
V <sub>DD_INT</sub>	41	V <sub>DD_INT</sub>	85	V <sub>DD_INT</sub>	129	$\overline{RESET}$	173
DPI_P05	42	DAI_P06	86	ADDR14	130	TMS	174
DPI_P04	43	DAI_P05	87	$\overline{AMI_WR}$	131	$\overline{SDCAS}$	175
DPI_P06	44	DAI_P09	88	$\overline{AMI_RD}$	132	V <sub>DD_INT</sub>	176
						GND	177*

\* at BOTTOM

**A3V56S40GTP-60(DIGITAL:U103, U203, U303, U403)**

**PIN CONFIGURATION (TOP VIEW)**

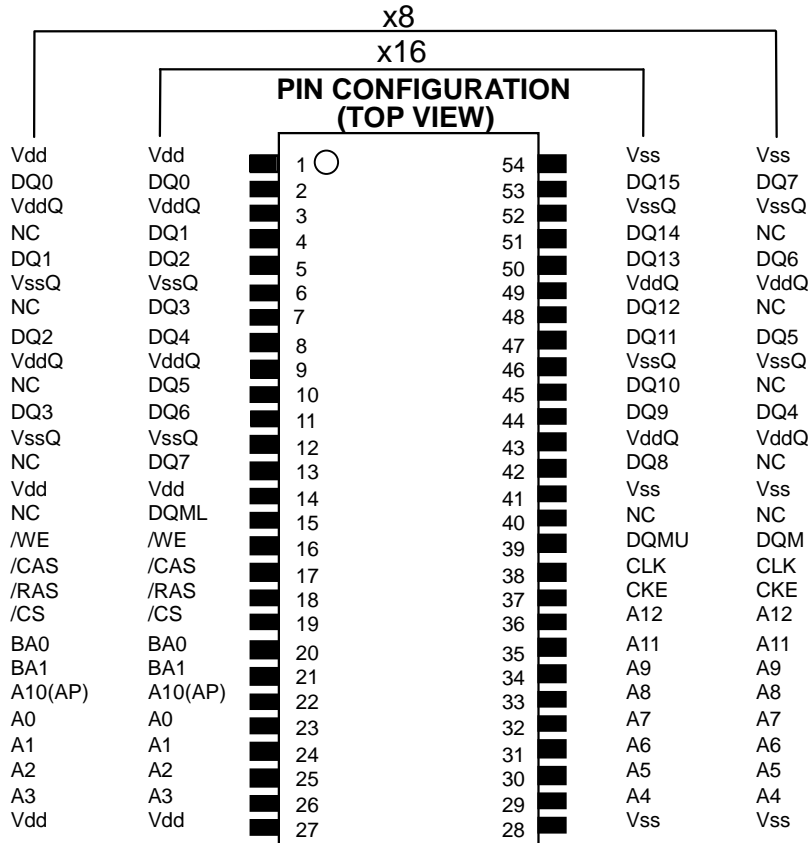

## A3V64S40GTP-60 Pin Function

### Pin Descriptions

SYMBOL	TYPE	DESCRIPTION
CLK	Input	Clock: CLK is driven by the system clock. All SDRAM input signals are sampled on the positive edge of CLK. CLK also increments the internal burst counter and controls the output registers.
CKE	Input	Clock Enable: CKE activates (HIGH) and deactivates (LOW) the CLK signal. Deactivating the clock provides PRECHARGE POWER-DOWN and SELF REFRESH operation (all banks idle), ACTIVE POWER-DOWN (row active in any bank), or CLOCK SUSPEND operation (burst / access in progress). CKE is synchronous except after the device enters self refresh mode, where CKE becomes asynchronous until after exiting the same mode. The input buffers, including CLK, are disabled during self refresh mode, providing low standby power. CKE may be tied HIGH.
/CS	Input	Chip Select: /CS enables (registered LOW) and disables (registered HIGH) the command decoder. All commands are masked when /CS is registered HIGH. /CS provides for external bank selection on systems with multiple banks. /CS is considered part of the command code.
/CAS, /RAS, /WE	Input	Command Inputs: /CAS, /RAS, and /WE (along with /CS) define the command being entered.
DQM, DQML, DQMU,	Input	Input / Output Mask: DQM is sampled HIGH and is an input mask signal for write accesses and an output disable signal for read accesses. Input data is masked during a WRITE cycle. The output buffers are placed in a High-Z state (two-clock latency) when during a READ cycle. DQM corresponds to DQ0–DQ7 (A3V56S30FTP). DQML corresponds to DQ0–DQ7, DQMU corresponds to DQ8–DQ15 (A3V56S40FTP).
BA0, BA1	Input	Bank Address Input(s): BA0 and BA1 define to which bank the ACTIVE, READ, WRITE or PRECHARGE command is being applied.
A0–A12	Input	A0-12 specify the Row / Column Address in conjunction with BA0,1. The Row Address is specified by A0-12. The Column Address is specified by A0-9(x8) and A0-8(x16). A10 is also used to indicate precharge option. When A10 is high at a read / write command, an auto precharge is performed. When A10 is high at a precharge command, all banks are precharged.
DQ0–DQ15	I/O	Data Input / Output: Data bus.
NC	–	Internally Not Connected: These could be left unconnected, but it is recommended they be connected or Vss.
VddQ	Supply	Data Output Power: Provide isolated power to output buffers for improved noise immunity.
VssQ	Supply	Data Output Ground: Provide isolated ground to output buffers for improved noise immunity.
Vdd	Supply	Power for the input buffers and core logic.
Vss	Supply	Ground for the input buffers and core logic.

# A3V64S40GTP-60 Block Diagram

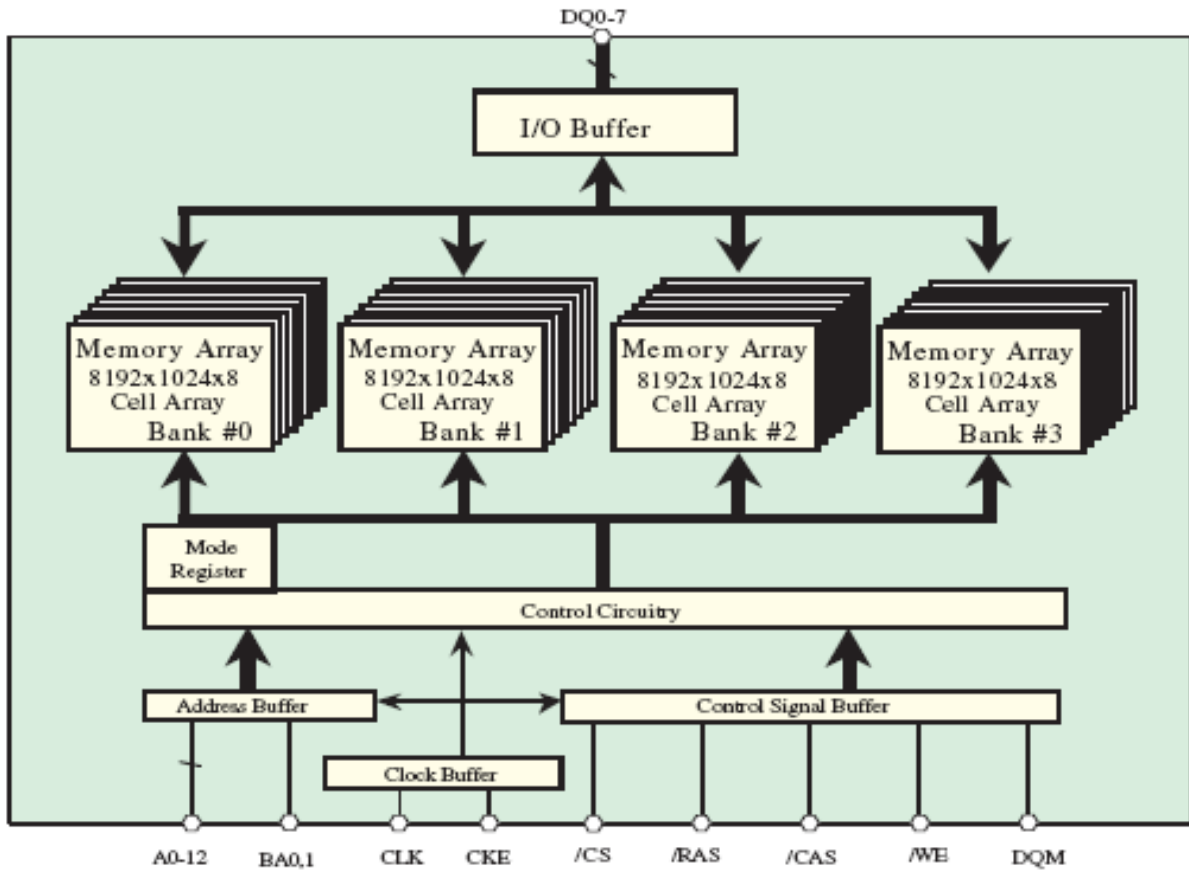

**MX25L1606EM2I-12G (DIGITAL : U102, U202, U302, U402)**

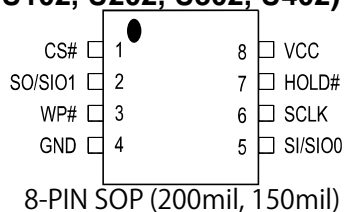

**MX25L1606EM2I-12G Block Diagram**

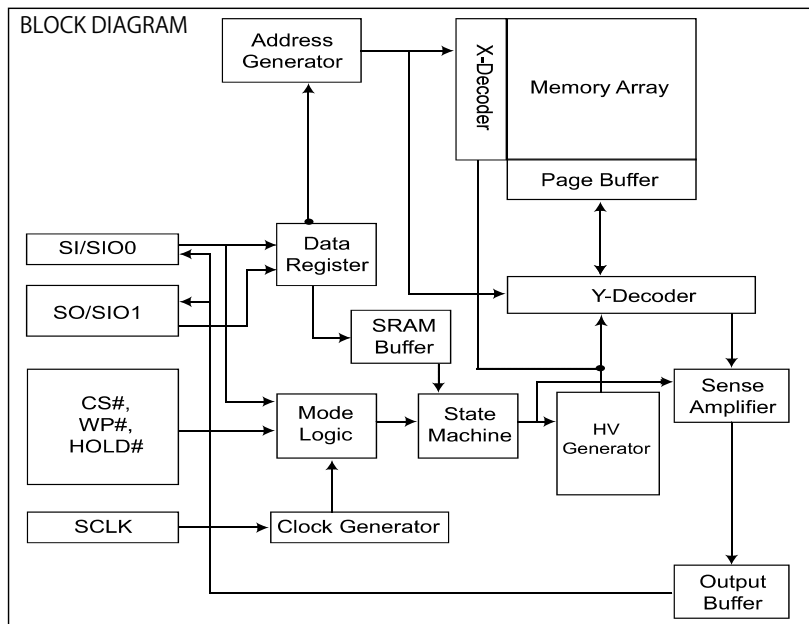



PCM5100 (DAC : U5002, U5003)

PCM510X (top view)

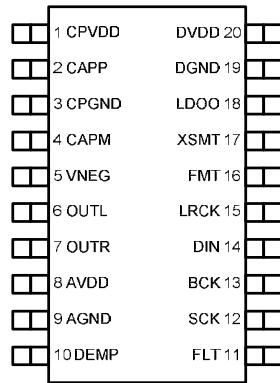

Table 2. TERMINAL FUNCTIONS, PCM510x

TERMINAL NAME	TERMINAL NO.	I/O	DESCRIPTION
CPVDD	1	-	Charge pump power supply, 3.3V
CAPP	2	O	Charge pump flying capacitor terminal for positive rail
CPGND	3	-	Charge pump ground
CAPM	4	O	Charge pump flying capacitor terminal for negative rail
VNEG	5	O	Negative charge pump rail terminal for decoupling, -3.3V
OUTL	6	O	Analog output from DAC left channel
OUTR	7	O	Analog output from DAC right channel
AVDD	8	-	Analog power supply, 3.3V
AGND	9	-	Analog ground
DEMP	10	I	De-emphasis control for 44.1kHz sampling rate <sup>(1)</sup> : Off (Low) / On (High)
FLT	11	I	Filter select : Normal latency (Low) / Low latency (High)
SCK	12	I	System clock input
BCK	13	I	Audio data bit clock input
DIN	14	I	Audio data input
LRCK	15	I	Audio data word clock input
FMT	16	I	Audio format selection : I <sup>2</sup> S (Low) / Left justified (High)
XSMT	17	I	Soft mute control : Soft mute (Low) / soft un-mute (High)
LDOO	18	-	Internal logic supply rail terminal for decoupling
DGND	19	-	Digital ground
DVDD	20	-	Digital power supply, 3.3V

(1) Failsafe LVCMOS Schmitt trigger input

PCM5100 Block Diagram

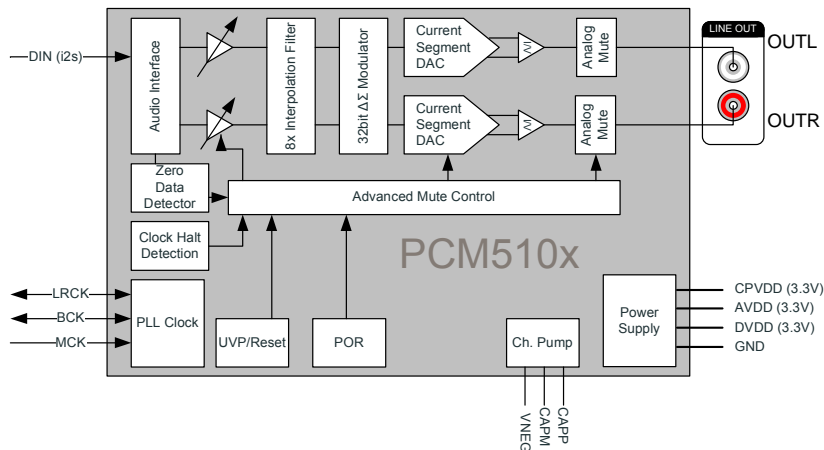
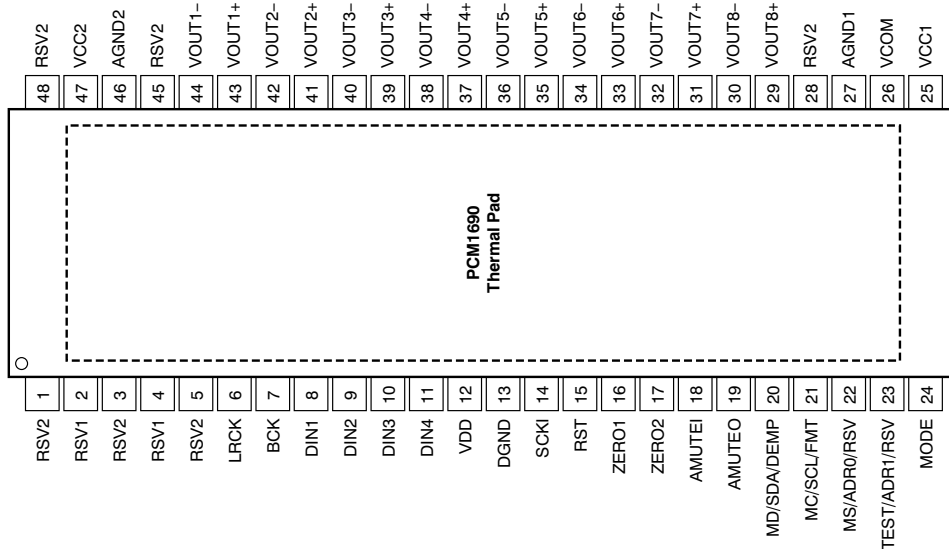

Figure 1. PCM510x Functional Block Diagram

## PCM1690(DAC : U5201, U5202)



### PCM1690 Pin Function

TERMINAL NAME	PIN	I/O	PULL-DOWN	5-V TOLERANT	DESCRIPTION
RSV2	1	—	—	—	Reserved, tied to analog ground
RSV1	2	—	—	—	Reserved, left open
RSV2	3	—	—	—	Reserved, tied to analog ground
RSV1	4	—	—	—	Reserved, left open
RSV2	5	—	—	—	Reserved, tied to analog ground
LRCK	6	I	Yes	No	Audio data word clock input
BCK	7	I	Yes	No	Audio data bit clock input
DIN1	8	I	No	No	Audio data input for DAC1 and DAC2
DIN2	9	I	No	No	Audio data input for DAC3 and DAC4
DIN3	10	I	No	No	Audio data input for DAC5 and DAC6
DIN4	11	I	No	No	Audio data input for DAC7 and DAC8
VDD	12	—	—	—	Digital power supply, +3.3 V
DGND	13	—	—	—	Digital ground
SCKI	14	I	No	Yes	System clock input
RST	15	I	Yes	Yes	Reset and power-down control input with active low
ZERO1	16	O	No	No	Zero detect flag output 1
ZERO2	17	O	No	No	Zero detect flag output 2
AMUTEI	18	I	No	Yes	Analog mute control input with active low
AMUTEO	19	O	No	Yes	Analog mute status output(1) with active low
MD/SDA/DEMP	20	I/O	No	Yes	Input data for SPI, data for I2C(1), de-emphasis control for hardware control mode
MC/SCL/FMT	21	I	No	Yes	Clock for SPI, clock for I2C, format select for hardware control mode
MS/ADR0/RSV	22	I	Yes	Yes	Chip Select for SPI, address select 0 for I2C, reserve (set low) for hardware control mode
TEST/ADR1/RSV	23	I/O	No	Yes	Test (factory use, left open) for SPI, address select 1 for I2C, reserve (set low) for hardware control mode
MODE	24	I	No	No	Control port mode selection. Tied to VDD: SPI, left open: H/W mode, tied to DGND: I2C
VCC1	25	—	—	—	Analog power supply 1, +5 V
VCOM	26	—	—	—	Voltage common decoupling
AGND1	27	—	—	—	Analog ground 1
RSV2	28	—	—	—	Reserved, tied to analog ground
VOUT8+	29	O	No	No	Positive analog output from DAC8
VOUT8-	30	O	No	No	Negative analog output from DAC8
VOUT7+	31	O	No	No	Positive analog output from DAC7
VOUT7-	32	O	No	No	Negative analog output from DAC7
VOUT6+	33	O	No	No	Positive analog output from DAC6
VOUT6-	34	O	No	No	Negative analog output from DAC6
VOUT5+	35	O	No	No	Positive analog output from DAC5
VOUT5-	36	O	No	No	Negative analog output from DAC5
VOUT4+	37	O	No	No	Positive analog output from DAC4
VOUT4-	38	O	No	No	Negative analog output from DAC4
VOUT3+	39	O	No	No	Positive analog output from DAC3
VOUT3-	40	O	No	No	Negative analog output from DAC3
VOUT2+	41	O	No	No	Positive analog output from DAC2
VOUT2-	42	O	No	No	Negative analog output from DAC2

TERMINAL		I/O	PULL-DOWN	5-V TOLERANT	DESCRIPTION
NAME	PIN				
VOUT1+	43	O	No	No	Positive analog output from DAC1
VOUT1-	44	O	No	No	Negative analog output from DAC1
RSV2	45	—	—	—	Reserved, tied to analog ground
AGND2	46	—	—	—	Analog ground 2
VCC2	47	—	—	—	Analog power supply 2, +5 V
RSV2	48	—	—	—	Reserved, tied to analog ground

(1) Open-drain configuration in out mode.

## PCM1690 FUNCTIONAL BLOCK DIAGRAM

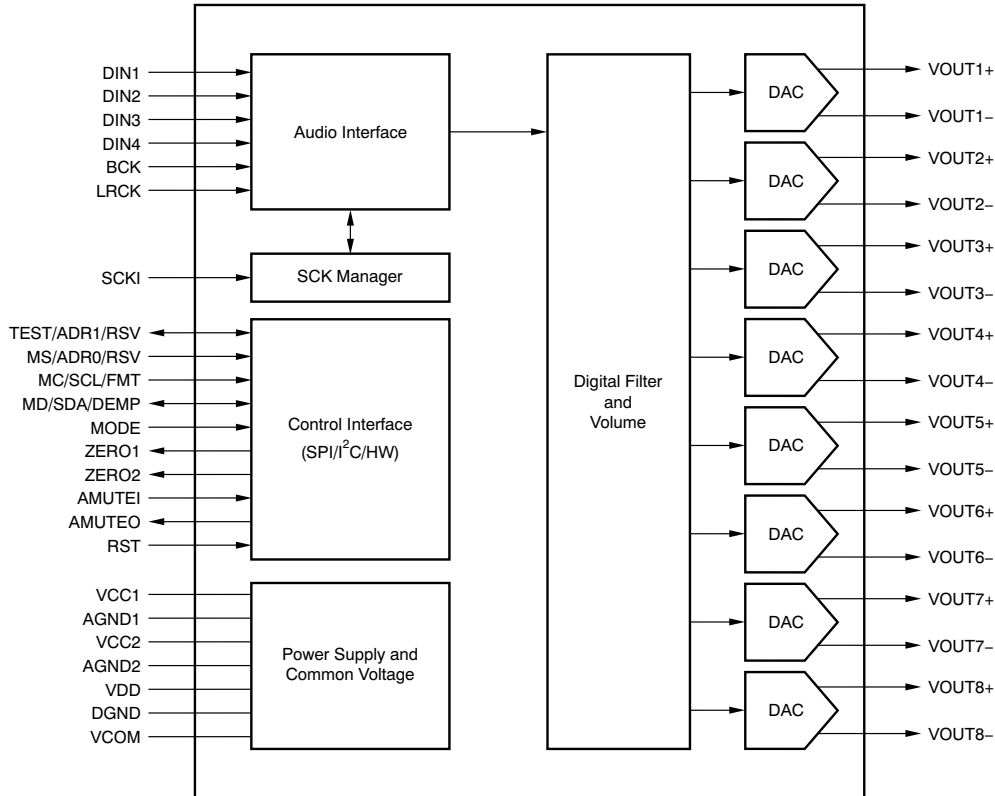

R2A15220FP (INPUT : U3201, U3202)

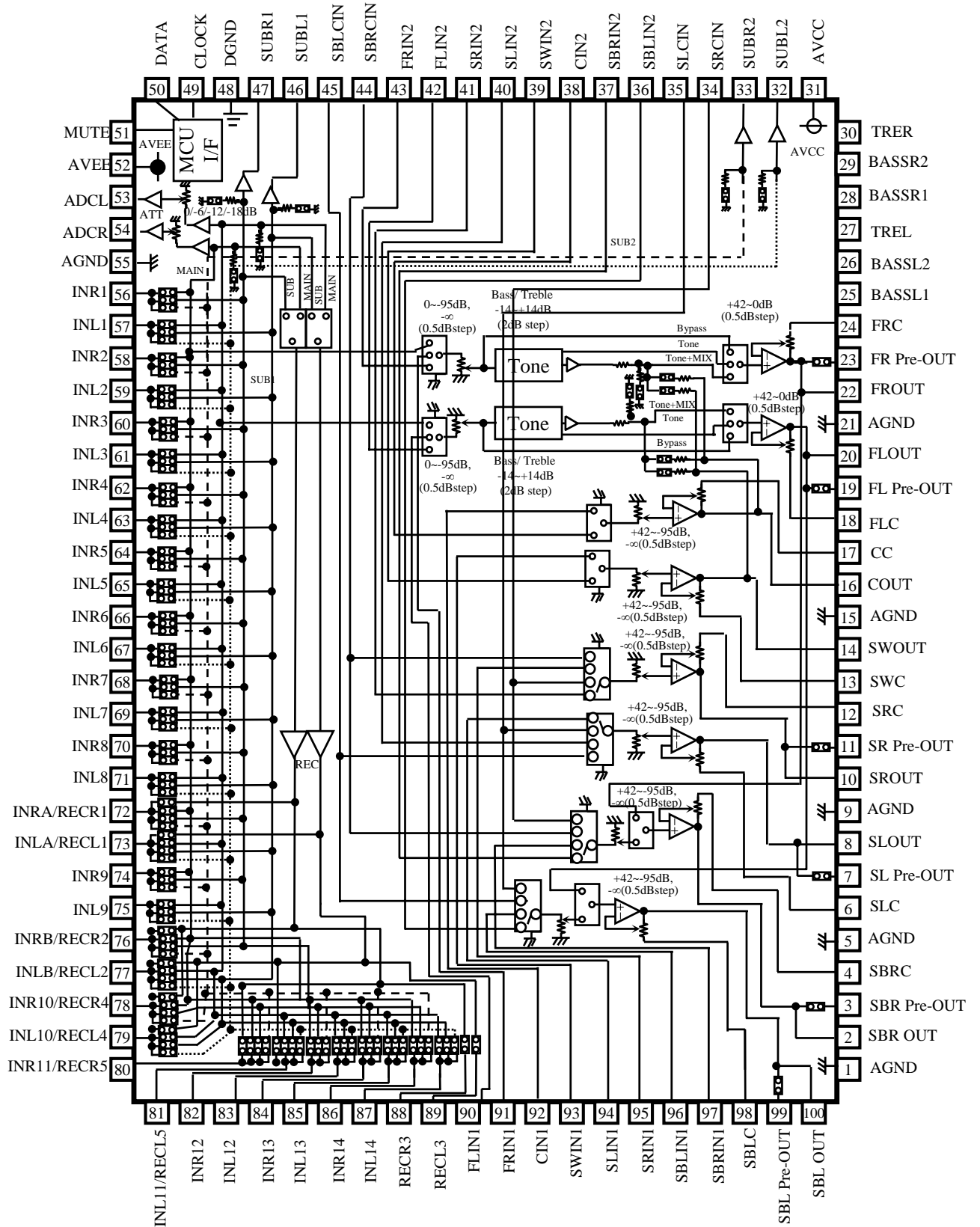

## R2A15220FP Pin Function

PIN No.	Name	Function
22,20, 16,14, 10, 8, 2, 100	FROUT,FLOUT, COUT,SWOUT, SROUT, SLOUT, SBROUT,SBLOUT	Output pin of FL/FR/C/SW/SL/SR/SBL/SBR channel
23,19, 11, 7, 3, 99	FR Pre-out,FL Pre-out, SR Pre-out, SL Pre-out, SBR Pre-out,SBL Pre-out	Pre-output pin of FL/FR/SL/SR/SBL/SBR channel
24,18, 17,13, 12, 6, 4, 98	FRC,FLC, CC,SWC, SRC,SLC, SBRC,SBLC	Connects capacitor for reducing click noise of L/R/C/SW/SL/SR/SBL/SBR channel volume
1,5,9,15, 21,55,98	AGND	Analog ground of internal circuit
27,30	TREL, TRER	Frequency characteristic setting pin of L/R channel tone control (Treble)
25,26, 28,29	BASSL1,BASSL2 BASSR1,BASSR2	Frequency characteristic setting pin of L/R channel tone control (Bass)
31	AVCC	Positive power supply to internal circuit
43,42, 41,40, 39,38, 37,36	FRIN2, FLIN2, SRN2,SLIN2, SWIN2,CIN2, SBRIN2,SBLIN2	Multi Input pin of L/R/C/SW/SL/SR/SBL/SBR channel (Multi IN 1/2)
90,91, 92,93, 94,95, 96,97	FLIN1, FRIN1, CIN1,SWIN1, SLIN1,SRIN1, SBLIN1,SBRIN1	
48	DGND	Digital ground of internal circuit
49	DATA	Input pin of control data
50	CLOCK	Input pin of control clock
52	AVEE	Negative power supply to internal circuit
57,59,61,63, 65,67,69,71, 75,83,85,87	INL1,INL2, INL3,INL4, INL5,INL6,INL7,INL8, INL9,INL12,INL13,INL14	Input pin of L/R channel (Input Selector)
56,58,60,62, 64,66,68,70, 74,82,84,86	INR1,INR2, INR3,INR4, INR5,INR6,INR7,INR8, INR9,INR12,INR13,INR14	
51	MUTE	Outside Mute Control PIN
44,45 34,35	SBRCIN,SBLCIN SRCIN,SLCIN	3 <sup>rd</sup> Multi Input pin for SBL/SBR/SL/SR channel Volume that is able to swap SBR/SBL with SR/SL
46,47 33,32	SUBL1,SUBR1 SUBL2,SUBR2	Output pin for L/R channel SUB1/SUB2 Output
53,54	ADCL, ADCR	Output pin for L/R channel ADC
88,89	RECR3,RECL3	Output pin for L/R channel REC Output
72,73, 76,77, 78,79 80,81	INRA/RECR1,INLA/RECL1, INRB/RECR2,INLB/RECL2, INR10/RECR4,INL10/RECL4, INR11/RECR5,INL11/RECL5	Input pin of L/R channel (Input Selector)/ Output pin for L/R channel REC Output

**NJW1194A (INPUT : U3203, U3204)**

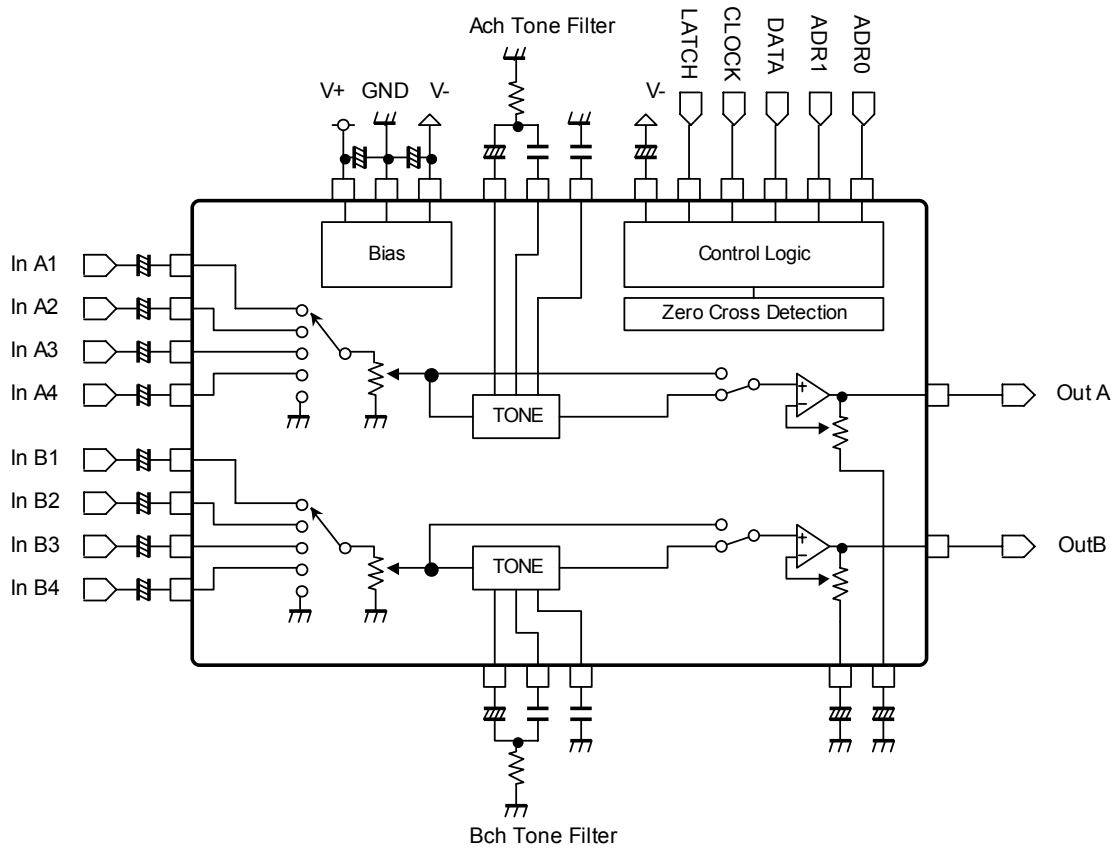



























## ANODE CONNECTION

	1G~16G	17G
D0A	1-1A	-
D1A	2-1A	-
D2A	3-1A	-
D3A	4-1A	-
D4A	5-1A	-
D5A	1-2A	-
D6A	2-2A	-
D7A	3-2A	-
D8A	4-2A	-
D9A	5-2A	-
D10A	1-3A	dB
D11A	2-3A	Dp
D12A	3-3A	3d
D13A	4-3A	3e
D14A	5-3A	3c
D15A	1-4A	3g
D16A	2-4A	3f
D17A	3-4A	3b
D18A	4-4A	3a
D19A	5-4A	2d
D20A	1-5A	2e
D21A	2-5A	2c
D22A	3-5A	2g
D23A	4-5A	2f
D24A	5-5A	2b
D25A	1-6A	2a
D26A	2-6A	1d
D27A	3-6A	1e
D28A	4-6A	1c
D29A	5-6A	1g
D30A	1-7A	1f
D31A	2-7A	1b
D32A	3-7A	1a
D33A	4-7A	S1
D34A	5-7A	

	1G~16G	17G
D0B	1-1B	
D1B	2-1B	
D2B	3-1B	
D3B	4-1B	
D4B	5-1B	
D5B	1-2B	
D6B	2-2B	dts
D7B	3-2B	AUDYSSEY
D8B	4-2B	TUNED
D9B	5-2B	STEREO
D10B	1-3B	RDS
D11B	2-3B	M
D12B	3-3B	1
D13B	4-3B	2
D14B	5-3B	
D15B	1-4B	
D16B	2-4B	MUTE
D17B	3-4B	IN
D18B	4-4B	OUT
D19B	5-4B	
D20B	1-5B	
D21B	2-5B	
D22B	3-5B	
D23B	4-5B	
D24B	5-5B	
D25B	1-6B	
D26B	2-6B	
D27B	3-6B	
D28B	4-6B	
D29B	5-6B	A
D30B	1-7B	B
D31B	2-7B	
D32B	3-7B	
D33B	4-7B	
D34B	5-7B	

FRONT SPK PCB ASS'Y

※Parts indicated by "nsp"on this table cannot be supplied.

※The parts listed b NOTE:The symbols in the column Remarks indicate the following destinations.

E3 : U.S.A. & Canada model E2 : Europe model E1C : China model E1 : Asia model JP : Japan model  
BK : Black model SP : Premium Silver model

REF No.	Part No.	Part Name	Remarks	Q'ty	New	Ver
<b>SEMICONDUCTORS GROUP</b>						
D6001,6002	20305004300AS	KBJ2506		20305004300AS	2	*
D6003-6011	00D2760794900	KDS160-RTK/P		00D2760794900	9	
D6012	00D2760683943	UDZS3.6B-TE17		00D2760683943	1	
D6013-6022	00D2760794900	KDS160-RTK/P		00D2760794900	10	
D6023	00D2760683943	UDZS3.6B-TE17		00D2760683943	1	
D6024,6025	00D2760794900	KDS160-RTK/P		00D2760794900	2	
D6201-6225	20305002730AS	1N4003(HOMI)		20305002730AS	25	
D6228,6229	00D2760798948	UDZS8.2B-TE17		00D2760798948	2	
D6230,6231	00D2760750902	RB521S-30TE61 +REF		00D2760750902	2	
D6232,6233	20305002730AS	1N4003(HOMI)		20305002730AS	2	
D6238,6239	00D2760750902	RB521S-30TE61 +REF		00D2760750902	2	
D6401	26301009410AS	PVBWR-5A2M(WHITE/RED LED)	E3	26301009410AS	1	*
D6401	26301006510AS	BL-BJEGJ204L	E2,E1C	26301006510AS	1	
D6406	00D2760798948	UDZS8.2B-TE17		00D2760798948	1	
D6407	20305002730AS	1N4003(HOMI)		20305002730AS	1	
D6408	263010032409S	SJR-341STA49		263010032409S	1	
D6410,6411	00D2760798935	UDZS20B-TE17		00D2760798935	2	
D6414-6416	00D2760683930	UDZS5.1B-TE17 +C		00D2760683930	3	
Q6001	00D2730464901	KTC3875S-GR-RTK/P		00D2730464901	1	
Q6003	00D2730464901	KTC3875S-GR-RTK/P		00D2730464901	1	
Q6005	00D2710318909	2N5401S-RTK/P		00D2710318909	1	
Q6006	00D2730464901	KTC3875S-GR-RTK/P		00D2730464901	1	
Q6008	00D2730464901	KTC3875S-GR-RTK/P		00D2730464901	1	
Q6010-6014	00D2730464901	KTC3875S-GR-RTK/P		00D2730464901	5	
Q6015	00D2710312905	KTA1504S-GR-RTK/P		00D2710312905	1	
Q6016,6017	00D2730464901	KTC3875S-GR-RTK/P		00D2730464901	2	
Q6018	00D2710312905	KTA1504S-GR-RTK/P		00D2710312905	1	
Q6019,6020	00D2730464901	KTC3875S-GR-RTK/P		00D2730464901	2	
Q6021	00D2710312905	KTA1504S-GR-RTK/P		00D2710312905	1	
Q6022	21685002450AS	KRC105S-RTK(2.2K-47K)		21685002450AS	1	*
Q6024	00D2690192902	KRC102S-RTK/P (10K-10K)		00D2690192902	1	
Q6026	21685002450AS	KRC105S-RTK(2.2K-47K)		21685002450AS	1	*
Q6027	00D2690184907	KRA102S-RTK/P (10K-10K)		00D2690184907	1	
Q6030	21685002450AS	KRC105S-RTK(2.2K-47K)		21685002450AS	1	*
Q6031	00D2690192902	KRC102S-RTK/P (10K-10K)		00D2690192902	1	
Q6034	00D2690184907	KRA102S-RTK/P (10K-10K)		00D2690184907	1	
Q6036	21685002450AS	KRC105S-RTK(2.2K-47K)		21685002450AS	1	*
Q6037	00D2730464901	KTC3875S-GR-RTK/P		00D2730464901	1	
Q6040	21385001950AS	2SC5810		21385001950AS	1	
Q6042	21685002450AS	KRC105S-RTK(2.2K-47K)		21685002450AS	1	*
Q6044	21685002450AS	KRC105S-RTK(2.2K-47K)		21685002450AS	1	*
Q6046	21685002450AS	KRC105S-RTK(2.2K-47K)		21685002450AS	1	*
Q6048	21685002450AS	KRC105S-RTK(2.2K-47K)		21685002450AS	1	*
Q6050	21685002450AS	KRC105S-RTK(2.2K-47K)		21685002450AS	1	*
Q6052	21685002450AS	KRC105S-RTK(2.2K-47K)		21685002450AS	1	*
Q6054	21685002450AS	KRC105S-RTK(2.2K-47K)		21685002450AS	1	*
Q6201	00D2710312905	KTA1504S-GR-RTK/P		00D2710312905	1	
Q6202	00D2730464901	KTC3875S-GR-RTK/P		00D2730464901	1	
Q6203	21205001820AS	KTA1046		21205001820AS	1	
Q6204	21405001920AS	KTC2026		21405001920AS	1	
Q6401	00D2690192902	KRC102S-RTK/P (10K-10K)		00D2690192902	1	
Q6402,6403	00D2690184907	KRA102S-RTK/P (10K-10K)		00D2690184907	2	
Q6404	00D2690192902	KRC102S-RTK/P (10K-10K)		00D2690192902	1	
Q6405	21385001950AS	2SC5810		21385001950AS	1	
Q6406	00D2690191903	KRA104S-RTK/P (47K-47K)		00D2690191903	1	
Q6408	00D2730464901	KTC3875S-GR-RTK/P		00D2730464901	1	
U6001	23281004150AS	NJM8080G		23281004150AS	1	
U6201	00D2630801004	NJM7812FA(S)		00D2630801004	1	
U6202	00D2630809006	NJM7805FA(S)		00D2630809006	1	
U6203	00D2631048002	BA033T		00D2631048002	1	
U6204	00D2630554005	NJM7905FA		00D2630554005	1	
U6401	262010009000S	R34FS8A		262010009000S	1	
U6403,6404	23281004150AS	NJM8080G		23281004150AS	2	
<b>RESISTOR GROUP</b>						
R6001	nsp	RM73B--823JT +1608		00D2472012909	1	
R6003	nsp	RM73B--823JT +1608		00D2472012909	1	
R6005	nsp	RM73B--0R0KT +1608		00D2472018903	1	
R6007	nsp	RM73B--224JT +1608		00D2472013908	1	
R6009	nsp	RM73B--0R0KT +1608		00D2472018903	1	
R6011	00MGG0510116X	100 OHM +- 5% 1/6W		00MGG0510116X	1	
R6012	nsp	RM73B--224JT +1608		00D2472013908	1	
R6014	nsp	RM73B--0R0KT +1608		00D2472018903	1	
R6016	00MGG0504716X	4.7 OHM +- 5% 1/6W		00MGG0504716X	1	
R6018,6019	nsp	RM73B--103JT +1608		00D2472009983	2	
R6020	nsp	RM73B--332JT +1608		00D2472008968	1	
R6021	nsp	RM73B--223JT +1608		00D2472010969	1	
R6022	nsp	RM73B--153JT +1608		00D2472010927	1	
R6023-6029	nsp	RM73B--103JT +1608		00D2472009983	7	
R6030,6031	nsp	RM73B--223JT +1608		00D2472010969	2	
R6032	nsp	RM73B--104JT +1608		00D2472012925	1	
R6033-6037	nsp	RM73B--223JT +1608		00D2472010969	5	
R6038	nsp	RM73B--153JT +1608		00D2472010927	1	
R6039	nsp	RM73B--223JT +1608		00D2472010969	1	
R6040	nsp	RM73B--104JT +1608		00D2472012925	1	
R6041-6049	nsp	RM73B--474JT +1608		00D2472013982	9	
R6050	nsp	RM73B--153JT +1608		00D2472010927	1	
R6055	nsp	RM73B--104JT +1608		00D2472012925	1	
R6060	12905006810AS	RGC502T02		12905006810AS	1	
R6061	nsp	RM73B--103JT +1608		00D2472009983	1	
R6062	nsp	RM73B--101JT +1608		00D2472005903	1	
R6063	nsp	RM73B--0R0KT +2125		00D2470018905	1	
R6064	nsp	RM73B--0R0KT +1608		00D2472018903	1	
R6065	nsp	RM73B--0R0KT +2125		00D2470018905	1	
R6067	nsp	RM73B--0R0KT +2125		00D2470018905	1	
R6068	nsp	RM73B--153JT +1608		00D2472010927	1	
R6070	nsp	RM73B--0R0KT +2125		00D2470018905	1	
R6071	nsp	RM73B--473JT +1608		00D2472011942	1	
R6073-6075	nsp	RM73B--0R0KT +2125		00D2470018905	3	

REF No.	Part No.	Part Name	Remarks	Q'ty	New	Ver
R6077,6078	nsp	RM73B--0R0KT +2125		00D2470018905	2	
R6079	nsp	RM73B--333JT +1608		00D2472011900	1	
R6080	nsp	RM73B--0R0KT +2125		00D2470018905	1	
R6081,6082	nsp	RM73B--103JT +2125		00D2470009985	2	
R6083,6084	nsp	RM73B--103JT +1608		00D2472009983	2	
R6085	nsp	RM73B--0R0KT +2125		00D2470018905	1	
R6087	nsp	RM73B--332JT +1608		00D2472008968	1	
R6088	nsp	RM73B--334JT +1608		00D2472013940	1	
R6089,6090	nsp	RM73B--103JT +1608		00D2472009983	2	
R6091	nsp	RM73B--102JT +1608		00D2472007943	1	
R6092	nsp	RM73B--333JT +1608		00D2472011900	1	
R6097	nsp	RM73B--101JT +1608		00D2472005903	1	
R6100	nsp	RM73B--0R0KT +1608		00D2472018903	1	
R6202	nsp	RM73B--473JT +1608		00D2472011942	1	
R6205,6206	nsp	RM73B--471JT +1608		00D2472006960	2	
R6207,6208	nsp	RM73B--101JT +1608		00D2472005903	2	
R6209,6210	nsp	RM73B--473JT +1608		00D2472011942	2	
R6401	nsp	RM73B--222JT +1608		00D2472008926	1	
R6403,6404	nsp	RM73B--122JT +1608		00D2472007969	2	
R6405,6406	nsp	RM73B--0R0KT +1608		00D2472018903	2	
R6407	nsp	RM73B--101JT +1608		00D2472005903	1	
R6408	nsp	RM73B--472JT (1608) +1608		00D2472009909	1	
R6409,6410	nsp	RM73B--221JT +1608		00D2472005987	2	
R6411	nsp	RM73B--102JT +1608		00D2472007943	1	
R6412	nsp	RM73B--472JT (1608) +1608		00D2472009909	1	
R6413	nsp	RM73B--1R8KT		00D2472018974	1	
R6415	nsp	RM73B--1R5KT		00D2472018958	1	
R6417	nsp	RM73B--472JT (1608) +1608		00D2472009909	1	
R6418,6419	nsp	RM73B--101JT +1608		00D2472005903	2	
R6420	nsp	RM73B--472JT (1608) +1608		00D2472009909	1	
R6421	nsp	RM73B--473JT +1608		00D2472011942	1	
R6422	nsp	RM73B--820JT +1608		00D2472004988	1	
R6423	nsp	RM73B--473JT +1608		00D2472011942	1	
R6424	nsp	RM73B--101JT +1608		00D2472005903	1	
R6425	nsp	RM73B--473JT +2125		00D2470011944	1	
R6426	nsp	RM73B--100JT +1608		00D2472002964	1	
R6427	nsp	RM73B--820JT +1608		00D2472004988	1	
R6428	nsp	RM73B--101JT +1608		00D2472005903	1	
R6431	nsp	RM73B--101JT +1608		00D2472005903	1	
R6433-6435	nsp	RM73B--271JT +1608		00D2472006915	3	
R6436-6438	nsp	RM73B--221JT +1608		00D2472005987	3	
R6439,6440	nsp	RM73B--100JT +2125		00D2470002966	2	
R6441,6442	nsp	RM73B--331JT (1608) +1608		00D2472006902	2	
R6443	nsp	RM73B--561JT +1608		00D2472006986	1	
R6444	nsp	RM73B--393JT +1608		00D2472011926	1	
R6445	nsp	RM73B--103JT +1608		00D2472009983	1	
R6446	nsp	RM73B--101JT +1608		00D2472005903	1	
R6447	nsp	RM73B--331JT (1608) +1608		00D2472006902	1	
R6448	nsp	RM73B--820JT +1608		00D2472004988	1	
R6449	nsp	RM73B--243JT +1608		00D2472010972	1	
R6450	nsp	RM73B--102JT +1608		00D2472007943	1	
R6451,6452	nsp	RM73B--472JT (1608) +1608		00D2472009909	2	
R6453,6454	nsp	RM73B--103JT +1608		00D2472009983	2	
R6455	nsp	RM73B--473JT +1608		00D2472011942	1	
R6456,6457	nsp	RM73B--0R0KT +1608		00D2472018903	2	
R6458	nsp	RM73B--101JT +1608		00D2472005903	1	
R6459	nsp	RM73B--333JT +1608		00D2472011900	1	
R6461	nsp	RM73B--103JT +1608		00D2472009983	1	
R6462	nsp	RM73B--101JT +1608		00D2472005903	1	
R6463	nsp	RM73B--102JT +1608		00D2472007943	1	
R6464	nsp	RM73B--104JT +1608		00D2472012925	1	
R6465	nsp	RM73B--102JT +1608		00D2472007943	1	
R6466,6467	nsp	RM73B--471JT +1608		00D2472006960	2	
R6468,6469	nsp	RM73B--563JT +1608		00D2472011968	2	
R6470	nsp	RM73B--222JT +1608		00D2472008926	1	
R6471	nsp	RM73B--104JT +1608		00D2472012925	1	
R6472	nsp	RM73B--683JT +1608		00D2472011984	1	
R6473,6474	nsp	RM73B--474JT +1608		00D2472013982	2	
R6475,6476	nsp	RM73B--471JT +1608		00D2472006960	2	
R6477	nsp	RM73B--333JT +1608		00D2472011900	1	
<b>CAPACITORS GROUP</b>						
C6001	13305030300AS	CQ93M2E104J(PEF)		13305030300AS	1	*
C6002,6003	13405018740AS	CE04W2A221MT(KR3)		13405018740AS	2	
C6004,6005	13405014840AS	CE04W1J100MT(KR3)		13405014840AS	2	
C6006	13405013240AS	CE04W1E470MT(KR3)		13405013240AS	1	
C6007	13405012740AS	CE04W1A331MT(KR3)		13405012740AS	1	
C6008	nsp	CK73B1E104KT +1608		00D2570516954	1	
C6009	13405012740AS	CE04W1A331MT(KR3)		13405012740AS	1	
C6010	nsp	CK73B1E104KT +1608		00D2570516954	1	
C6011,6012	13405028200AS	CE68W==153M(DL)		13405028200AS	2	*
C6013	13405012740AS	CE04W1A331MT(KR3)		13405012740AS	1	
C6016	nsp	CK73B1E104KT +1608		00D2570516954	1	
C6017	nsp	C1608X7R1H104K		00MDK9610430Y	1	
C6018	13405014840AS	CE04W1J100MT(KR3)		13405014840AS	1	
C6019-6022	nsp	CK73B1E104KT +1608		00D2570516954	4	
C6023,6024	13405018640AS	CE04W2A010MT(KR3)		13405018640AS	2	
C6025	13405012940AS	CE04W1C101MT(KR3)		13405012940AS	1	
C6027	13405018640AS	CE04W2A010MT(KR3)		13405018640AS	1	
C6028	nsp	CK73U2J2E222JT(2125)		00D2570043919	1	
C6029-6038	nsp	CC73CH1H102JT +1608		00D2570508988	10	
C6039,6040	nsp	CK73U2J2E222JT(2125)		00D2570043919	2	
C6041	nsp	CC73CH1H102JT +1608		00D2570508988	1	
C6042-6049	nsp	CK73U2J2E222JT(2125)		00D2570043919	8	
C6201,6202	133050083511S	CQ93M2A104JT(PEF)		133050083511S	2	
C6203,6204	13405025220AS	CE04D1C222MBPC(KRB)		13405025220AS	2	
C6205	133050090557S	CQ93P2A104JT(PPF)		133050090557S	1	
C6207	13405013540AS	CE04W1V102MT(KR3)		13405013540AS	1	
C6208	133050090557S	CQ93P2A104JT(PPF)		133050090557S	1	
C6209	13405018320AS	CE04W1C472MC(KR3)		13405018320AS	1	
C6210	13405014840AS	CE04W1J100MT(KR3)		13405014840AS	1	
C6211	13405013540AS	CE04W1V102MT(KR3)		13405013540AS	1	
C6213	13405018320AS	CE04W1C472MC(KR3)		13405018320AS	1	
C6214	13405018220AS	CE04W1C222MC(KR3)		13405018220AS	1	
C6216,6217	13405040220AS	CE04W1C103MC(KR1)		13405040220AS	2	*
C6221,6222	13405014840AS	CE04W1J100MT(KR3)		13405014840AS	2	
C6225,6226	13405013340AS	CE04W1E471MT(KR3)		13405013340AS	2	

REF No.	Part No.	Part Name	Remarks	Q'ty	New	Ver
C6227,6228	13405014840AS	CE04W1J100MT(KR3)		13405014840AS	2	
C6229,6230	13405013340AS	CE04W1E471MT(KR3)		13405013340AS	2	
C6235,6236	13405014840AS	CE04W1J100MT(KR3)		13405014840AS	2	
C6403	nsp	CK73B1E104KT +1608		00D2570516954	1	
C6404	nsp	CK73B1H102KT +1608		00D2570509929	1	
C6405	nsp	CK73B1H222KT +1608		00D2570509990	1	
C6406	nsp	CK73B1E104KT +1608		00D2570516954	1	
C6407	nsp	CK73B1H102KT +1608		00D2570509929	1	
C6408	nsp	CK73B1H222KT +1608		00D2570509990	1	
C6409	13405014840AS	CE04W1J100MT(KR3)		13405014840AS	1	
C6410-6412	nsp	CK73B1E104KT +1608		00D2570516954	3	
C6413,6414	nsp	C1608X7R1H104K		00MDK9610430Y	2	
C6416	13405014940AS	CE04W1J101MT(KR3)		13405014940AS	1	
C6417	nsp	CK73B1E104KT +1608		00D2570516954	1	
C6418-6420	nsp	C1608X7R1H104K		00MDK9610430Y	3	
C6421	13405014440AS	CE04W1H101MT(KR3)		13405014440AS	1	
C6422	13405014840AS	CE04W1J100MT(KR3)		13405014840AS	1	
C6423	nsp	CK73B1E104KT +1608		00D2570516954	1	
C6427	nsp	C1608X7R1H104K		00MDK9610430Y	1	
C6431	nsp	CK73B1H102KT +1608		00D2570509929	1	
C6433	nsp	CK73B1E104KT +1608		00D2570516954	1	
C6434	13405014840AS	CE04W1J100MT(KR3)		13405014840AS	1	
C6436-6439	nsp	CK73B1E104KT +1608		00D2570516954	4	
C6443,6444	nsp	CK73B1E104KT +1608		00D2570516954	2	
C6445-6447	13405014840AS	CE04W1J100MT(KR3)		13405014840AS	3	
C6448	nsp	CC73CH1H330JT +1608		00D2570504940	1	
C6452	13405012940AS	CE04W1C101MT(KR3)		13405012940AS	1	
C6453	nsp	CC73CH1H101JT +1608		00D2570506951	1	
C6454-6457	13405014840AS	CE04W1J100MT(KR3)		13405014840AS	4	
C6459,6460	nsp	CC73CH1H331JT +1608		00D2570507976	2	
C6461-6464	nsp	CK73B1E104KT +1608		00D2570516954	4	
C6465	nsp	CK73B1H103KT (1608) +1608		00D2570501901	1	
C6466,6467	nsp	RM73B-OR0KT +1608		00D2472018903	2	
C6468	nsp	CK73B1E104KT +1608		00D2570516954	1	
C6469	nsp	CK73B1H103KT (1608) +1608		00D2570501901	1	
C6470-6475	nsp	RM73B-OR0KT +1608		00D2472018903	6	
<b>OTHER PARTS GROUP</b>						
B6001	nsp	1P 130mm SIN-SIN		61205049500AS	1	
B6006,6007	nsp	GND TERMINAL FOR PCB		00MYL01010241	2	
B6020	nsp	GND TERMINAL FOR PCB		00MYL01010241	1	
B6402	nsp	M3 SCREW TERMINAL		00D2051034007	1	
B6412	nsp	GND TERMINAL FOR PCB		00MYL01010241	1	
! F0010	652010025070S	L=20mm 250V/T10A		652010025070S	1	*
! F0020	652010025070S	L=20mm 250V/T10A		652010025070S	1	*
! F6201	65205003444AS	FUSE(SCT2.5A)		65205003444AS	1	*
! F6202-6204	65205003443AS	FUSE(SCT2A)		65205003443AS	3	*
! F6206	65205003540AS	FUSE(SCT250MA)		65205003540AS	1	*
! F6401	65205003540AS	FUSE(SCT250MA)		65205003540AS	1	*
H0031,0032	nsp	FUSE CLIP(TAPE)		00D2020040909	2	
H0041,0042	nsp	FUSE CLIP(TAPE)		00D2020040909	2	
K6001-6011	64601006000AS	2P SP TERMINAL		64601006000AS	11	*
K6401	64301017400AS	H/P JACK(PJ-612AG-7)-AU		64301017400AS	1	
K6402	64301027400AS	MINI JACK(PJ-3610)		64301027400AS	1	*
K6403	64301019701AS	3P PIN JACK(MSP-303H)-AU-BK		64301019701AS	1	*
N6001-6009	nsp	B5B-EH		00MYP06010450	9	
N6010	nsp	B11B-PH-K-S (LF)(SN)		00MYJ06006310	1	
N6011	nsp	B12B-PH-K-S (LF)(SN)		00MYJ06006320	1	
N6012	nsp	B9P-VH		00MYP06010990	1	
N6013	nsp	33P FFC BASE		00D2050736005	1	
N6201	nsp	B5B-EH		00MYP06010450	1	
N6202	nsp	7P 130mm EH-SCN		61205062800AS	1	*
N6203	nsp	3P 130mm PH-SAN		61205049902AS	1	*
N6204	nsp	6P 130mm PH-SAN		61205062700AS	1	*
N6401	nsp	S7B-EH		00MYP06003960	1	
N6402	nsp	9P PLUG(C125Z1)		645010067014S	1	
N6403	nsp	9P SOCKET(C125Z2)		645010068017S	1	
N6405	nsp	40FMN-STRK-A(LF)(SN)		645010075008S	1	
N6804	nsp	3P 60mm SCN-SCN		61205062800AS	1	*
! S6001	68201003000AS	RELAY(FTR-F1CL012R)		68201003000AS	1	
! S6002-6011	682010020007S	G5PA-28-MC DC12		682010020007S	10	
S6401-6420	00D2125611903	TACT SWITCH(TAPE H5)		00D2125611903	20	
S6421	663010006000S	ROT.ENCODER(EC16B24T01D4ZZZ)		663010006000S	1	
S6422	66301001300AS	ROT.ENCODER(EC16B12SAAD4ZZZ)		66301001300AS	1	*
Z6003,6004	nsp	STYLE PIN		00D2050452017	2	
Z6008-6010	nsp	STYLE PIN		00D2050452017	3	
Z6012	nsp	STYLE PIN		00D2050452017	1	
Z6402	17201001300AS	FLD(17-BT-40GINK)		17201001300AS	1	
Z6403,6404	nsp	RUBBER SHEET (30X7X7)		47101008700AD	2	*
Z6411,6412	nsp	STYLE PIN		00D2050452017	2	

## P.AMP SMPS PCB ASS'Y

※Parts indicated by "nsp" on this table cannot be supplied.

※The parts listed b NOTE: The symbols in the column Remarks indicate the following destinations.

E3 : U.S.A. & Canada model E2 : Europe model E1C : China model E1 : Asia model JP : Japan model  
BK : Black model SP : Premium Silver model

REF No.	Part No.	Part Name	Remarks	Q'ty	New	Ver
<b>SEMICONDUCTORS GROUP</b>						
D0101,0102	00D2760794900	KDS160-RTK/P		00D2760794900	18	
D0105	00D2760794900	KDS160-RTK/P		00D2760794900	9	
D0110	00D2760794900	KDS160-RTK/P		00D2760794900	9	
D3903	00D2760750902	RB521S-30TE61 +REF		00D2760750902	1	
D3904,3905	00D2760683998	UDZS16B-TE17 +C		00D2760683998	2	
D3906,3907	251310004507S	CG0603MLC-12LE		251310004507S	2	
D3908	00D2760750902	RB521S-30TE61 +REF		00D2760750902	1	
D3909	00D2760794900	KDS160-RTK/P		00D2760794900	1	
D3912,3913	00D2760750902	RB521S-30TE61 +REF		00D2760750902	2	
D6501,6502	20305003950AS	1N4007-T(DIODES)		20305003950AS	2	
D6503	203010001007S	D3SB60		203010001007S	1	
D6507	00D2760683901	UDZS5.6B-TE17 +C	E3	00D2760683901	1	
D6509	20305002730AS	1N4003(HOMI)		20305002730AS	1	
D6510	20205010250AS	UDZSTE-1730B		20205010250AS	1	*
D6511	20205004900AS	ZENER DIODE 39V_ZJ39B 1/2W		20205004900AS	1	
D6512	20205004710AS	P6KE150A(PANJIT)		20205004710AS	1	
D6513	20305003950AS	1N4007-T(DIODES)		20305003950AS	1	
D6514	20305002730AS	1N4003(HOMI)		20305002730AS	1	
D6515	20305004200AS	KCQ60A06		20305004200AS	1	*
D6517	00D2760794900	KDS160-RTK/P		00D2760794900	1	
D6520	20205010130AS	P6KE6.8A(PANJIT)		20205010130AS	1	*
D6522	20305003950AS	1N4007-T(DIODES)		20305003950AS	1	
D6524	23181020150AS	KIA2431AS-RTK/P		23181020150AS	1	*
D6525	20205004900AS	ZENER DIODE 39V_ZJ39B 1/2W		20205004900AS	1	
D6526	20305002730AS	1N4003(HOMI)		20305002730AS	1	
Q0101	21785000550AS	HN4A06J		21785000550AS	9	
Q0102	00D2730479909	2N5551S-RTK/P		00D2730479909	9	
Q0103	00D2710318909	2N5401S-RTK/P		00D2710318909	9	
Q0104	00D2730479909	2N5551S-RTK/P		00D2730479909	9	
Q0105	00D2710318909	2N5401S-RTK/P		00D2710318909	9	
Q0106	00D2730479909	2N5551S-RTK/P		00D2730479909	9	
Q0107	00D2710318909	2N5401S-RTK/P		00D2710318909	9	
Q0110	00D2710318909	2N5401S-RTK/P		00D2710318909	9	
Q0111	00D2730479909	2N5551S-RTK/P		00D2730479909	9	
Q0112	00D2710318909	2N5401S-RTK/P		00D2710318909	9	
Q0113	00D2730479909	2N5551S-RTK/P		00D2730479909	9	
Q3901,3902	00D2710260905	2SA1036KT146(S/R) +C		00D2710260905	2	
Q3903,3904	00D2690192902	KRC102S-RTK/P (10K-10K)		00D2690192902	2	
Q3905	00D2730464901	KTC3875S-GR-RTK/P		00D2730464901	1	
Q3906	00D2690184907	KRA102S-RTK/P (10K-10K)		00D2690184907	1	
Q6501	22985001450AS	RK7002B		22985001450AS	1	*
Q6502	00D2730476902	KTC3876S-Y-RTK +2125		00D2730476902	1	
U3901	236810090504S	ILX3232D		236810090504S	1	
U3902	23281004150AS	NJM8080G		23281004150AS	1	
U3903,3904	262010006704S	JSR1165		262010006704S	2	
U3905	23381001150AS	SN74AHC04D		23381001150AS	1	*
! U6501,6502	00D2623047008	PC123Y22		00D2623047008	2	
! U6503	23901012400AS	TOP267EG		23901012400AS	1	*
<b>RESISTOR GROUP</b>						
R0102	nsp	RD14B2E152JT(5)		00D241239897	9	
R0103	nsp	RD14B2E333JT(5)		00D2412402919	9	
R0104	nsp	RM73B--471JT +1608		00D2472006960	9	
R0105	nsp	RM73B--152JT +1608		00D2472007985	9	
R0106,0107	nsp	RM73B--471JT +1608		00D2472006960	18	
R0108	nsp	RD14B2E122JT(5)		00D2412398971	9	
R0109	nsp	RD14B2E333JT(5)		00D2412402919	9	
R0110	00MGG0547116X	470 OHM +- 5% 1/6W		00MGG0547116X	9	
R0111	00MGG0522116X	220 OHM +- 5% 1/6W		00MGG0522116X	9	
R0112	nsp	RD14B2E473JT(5)		00D2412402951	9	
R0114	00MGG0547116X	470 OHM +- 5% 1/6W		00MGG0547116X	9	
R0118,0119	00MGG0547016X	47 OHM +- 5% 1/6W		00MGG0547016X	18	
R0120	nsp	RM73B--334JT +2125		00D2470013942	9	
R0121	nsp	RM73B--473JT +1608		00D2472011942	9	
R0122-0125	00D2442671956	RS14B3DR47JNBST(S)		00D2442671956	36	
R0126-0128	nsp	RM73B--103JT +1608		00D2472009983	27	
R0129	nsp	RM73B--104JT +2125		00D2470012927	9	
R0130	nsp	RM73B--562JT +1608		00D2472009925	9	
R0131	nsp	RM73B--103JT +1608		00D2472009983	9	
R0132	nsp	RM73B--223JT +1608		00D2472010969	9	
R0133	nsp	RM73B--333JT +1608		00D2472011900	9	
R0134	nsp	RD14B2E100JT(5)		00D2412393989	9	
R0135	00D2442671901	RS14B3D100JNBST(S)		00D2442671901	9	
R0136	00MGG0547116X	470 OHM +- 5% 1/6W		00MGG0547116X	9	
R0137	00MGG0522116X	220 OHM +- 5% 1/6W		00MGG0522116X	9	
R3902,3903	nsp	RM73B--0R0KT +1608		00D2472018903	2	
R3904,3905	nsp	RM73B--391JT +1608		00D2472006944	2	
R3906,3907	nsp	RM73B--683JT +1608		00D2472011984	2	
R3908,3909	nsp	RM73B--154JT +1608		00D2472012967	2	
R3910,3911	nsp	RM73B--472JT (1608) +1608		00D2472009909	2	
R3912,3913	nsp	RM73B--271JT +1608		00D2472006915	2	
R3914-3916	nsp	RM73B--102JT +1608		00D2472007943	3	
R3917,3918	nsp	RM73B--470JT +1608		00D2472004920	2	
R3919	nsp	RM73B--332JT +1608		00D2472008968	1	
R3920	nsp	RM73B--222JT +1608		00D2472008926	1	
R3921	nsp	RM73B--104JT +1608		00D2472012925	1	
R3922,3923	nsp	RM73B--154JT +1608		00D2472012967	2	
R3924,3925	nsp	RM73B--123JT +1608		00D2472010901	2	
R3926,3927	nsp	RM73B--470JT +1608		00D2472004920	2	
R3928,3929	nsp	RM73B--102JT +1608		00D2472007943	2	
R3930,3931	nsp	RM73B--474JT +1608		00D2472013982	2	
R3932	nsp	RM73B--330JT +1608		00D2472003989	1	
R3933,3934	nsp	RM73B--750JT +1608		00D2472004975	2	
R3937,3938	nsp	RM73B--330JT +1608		00D2472003989	2	
R3939,3940	nsp	RM73B--471JT +1608		00D2472006960	2	
R3945,3946	nsp	RM73B--473JT +1608		00D2472011942	2	
R3947,3948	nsp	RM73B--334JT +1608		00D2472013940	2	
R3951,3952	nsp	RM73B--330JT +1608		00D2472003989	2	
R6501-6503	nsp	RD14B2E225JT(5)		00D2412405990	3	

REF No.	Part No.	Part Name	Remarks	Q'ty	New	Ver
R6504-6506	nsp	RD14B2E105JT(5)		00D2412405974	3	
R6507	nsp	RD14B2E334JT(5)		00D2412404959	1	
R6508	nsp	RM73B--105JT +1608		00D2472014965	1	
R6509	nsp	RM73B--392JT +1608	E3	00D2472008984	1	
R6509	nsp	RM73B--622JT +1608	E2,E1C	00D2472009938	1	
R6510	nsp	RM73B--822JT +1608		00D2472009967	1	
R6511,6512	nsp	RD14B2E225JT(5)	E3	00D2412405990	2	
R6514	nsp	RM73B--563JT +1608		00D2472011968	1	
R6515	00D2442051961	RS14B3A101JNBST(S)		00D2442051961	1	
R6516	nsp	RD14B2E6R8JT(5)		00D2412393947	1	
R6517	nsp	RM73B--560JT +1608		00D2472004946	1	
R6519	nsp	RM73B--103JT +1608		00D2472009983	1	
R6520	nsp	RM73B--152JT +1608		00D2472007985	1	
R6521	00D2442050904	RS14B3A220JNBST(S)		00D2442050904	1	
R6522	nsp	RM73B--560JT +1608		00D2472004946	1	
R6523	nsp	RM73B--682JT +1608		00D2472009941	1	
R6524	nsp	RM73B--562JT +1608		00D2472009925	1	
R6525	nsp	RM73B--223DT(1608)		00D2472036927	1	
R6526	nsp	RM73B--105JT +1608		00D2472014965	1	
R6527	nsp	RM73B--682DT(1608)		00D2472041967	1	
R6528	nsp	RM73B--470JT +1608		00D2472004920	1	
R6532	nsp	RM73B--OR0KT +1608		00D2472018903	1	
R6533	00D2442051974	RS14B3A102JNBST(S)		00D2442051974	1	
R6536	nsp	RM73B--682JT +1608		00D2472009941	1	
R6537	nsp	RM73B--OR0KT +1608		00D2472018903	1	
<b>CAPACITORS GROUP</b>						
C0101	00D2544583971	CE04W1H470MT(ROB)		00D2544583971	9	
C0102	133050086527S	CQ93M2A102JT(PEF)		133050086527S	9	
C0103	133050086565S	CQ93M2A222JT(PEF)		133050086565S	9	
C0104	nsp	CC73CH1H101JT +1608		00D2570506951	9	
C0105	13405012940AS	CE04W1C101MT(KR3)		13405012940AS	9	
C0106	13405013340AS	CE04W1E471MT(KR3)		13405013340AS	9	
C0107	nsp	CC73CH1H101JT +1608		00D2570506951	9	
C0109	133050086503S	CQ93M2A221JT(PEF)		133050086503S	9	
C0110	13405013340AS	CE04W1E471MT(KR3)		13405013340AS	9	
C0111	nsp	C1608X7R1H104K		00MDK9610430Y	9	
C0113	nsp	C1608X7R1H104K		00MDK9610430Y	9	
C0114,0115	13405018640AS	CE04W2A010MT(KR3)		13405018640AS	18	
C0116	133050083504S	CQ93M2A473JT(PEF)		133050083504S	9	
C0121,0122	13405018640AS	CE04W2A010MT(KR3)		13405018640AS	18	
C3901	nsp	CC73CH1H102JT +1608		00D2570508988	1	
C3904,3905	nsp	CK73B1H102KT +1608		00D2570509929	2	
C3906	nsp	CK73B1E104KT +1608		00D2570516954	1	
C3907,3908	nsp	CC73CH1H221JT +1608		00D2570507934	2	
C3909-3911	nsp	CK73B1H102KT +1608		00D2570509929	3	
C3912,3913	nsp	CK73B1E104KT +1608		00D2570516954	2	
C3914,3915	13405014840AS	CE04W1J100MT(KR3)		13405014840AS	2	
C3916,3917	nsp	CC73CH1H330JT +1608		00D2570504940	2	
C3918	nsp	CK73B1H102KT +1608		00D2570509929	1	
C3919,3920	13405012440AS	CE04W0J221MT(KR3)		13405012440AS	2	
C3921,3922	nsp	CC73CH1H101JT +1608		00D2570506951	2	
C3923,3924	nsp	CK73B1E223KT +1608		00D2570516909	2	
C3925,3926	nsp	CK73B1H682KT +1608		00D2570510950	2	
C3927,3928	13405014840AS	CE04W1J100MT(KR3)		13405014840AS	2	
C3929	nsp	CK73B0J475KT +1608		00D2570522906	1	
C3930	nsp	CK73B1E104KT +1608		00D2570516954	1	
C3931,3932	13405013240AS	CE04W1E470MT(KR3)		13405013240AS	2	
C3933-3939	nsp	CK73B1E104KT +1608		00D2570516954	7	
C3940,3941	nsp	CK73B1H102KT +1608		00D2570509929	2	
C3942,3943	nsp	CK73B1H103KT (1608) +1608		00D2570501901	2	
C3944	nsp	CK73B1E104KT +1608		00D2570516954	1	
C3945	nsp	CK73B1H102KT +1608		00D2570509929	1	
C5801-5804	nsp	CK73B0J475KT +1608		00D2570522906	4	
! C6501,6502	00D2538032700	CK452EAC102MC(KX)		00D2538032700	2	
! C6503	00D2538022707	CK452EAC103MC		00D2538022707	1	
! C6504,6505	13305016720AS	MPXLC104K27515		13305016720AS	2	*
C6506	13405028320AS	CE04W2G151MC(CXW)		13405028320AS	1	*
C6509	nsp	CK73B1E473KT +1608		00D2570516941	1	
C6510	nsp	CK73B1E104KT +1608	E2,E1C	00D2570516954	1	
! C6511,6512	00D2538022707	CK452EAC103MC		00D2538022707	2	
C6515	13405040350AS	CE04W1E470MT(KZH)		13405040350AS	1	*
C6516	nsp	C1608X7R1H104K		00MDK9610430Y	1	
C6517	13305015021AS	CQ93M3A272J(PHF)		13305015021AS	1	*
C6519	13405040450AS	CE04W1H220MT(KZH)		13405040450AS	1	*
! C6520	00D2538029726	CK452EAC332MC(KX)		00D2538029726	1	
C6524	nsp	CK73B0J475KT +1608		00D2570522906	1	
C6525-6527	13405028420AS	CE04W0J392MC(ZL)		13405028420AS	3	*
C6528	nsp	CK73B0J475KT +1608		00D2570522906	1	
C6529	nsp	CK73B1E104KT +1608		00D2570516954	1	
C6530	nsp	CK73B0J475KT +1608		00D2570522906	1	
C6532	133050086565S	CQ93M2A222JT(PEF)		133050086565S	1	
<b>OTHER PARTS GROUP</b>						
B5801	nsp	M3 SCREW TERMINAL		00D2051034010	1	
B6501	nsp	M3 SCREW TERMINAL(CMD1A834)		44431033900AS	1	*
B6503	nsp	M3 SCREW TERMINAL(CMD1A834)		44431033900AS	1	*
! F0050	652010025063S	L=20mm 250V/T8A	E3	652010025063S	1	
! F0050	00D2061091014	FUSE(ET5A)	E2	00D2061091014	1	2
! F0050	0520100170060	# T5A L 250V 0218005.MXP	E1C	0520100170060	1	2
! F0070	65205003443AS	FUSE(SCT2A)		65205003443AS	1	*
H0061,0062	nsp	FUSE CLIP(TAPE)		00D2020040909	2	
K3901	64301000710AS	2PIN PIN JACK(RCA-206BG-00-05)-AU-RD/WH		64301000710AS	1	
K3902,3903	643010086019S	MINI JACK(PJ-308-02(RD))		643010086019S	2	
K3904,3905	643010086002S	MINI JACK(PJ-308-02)		643010086002S	2	
K3906	646010018015S	2P PIN JACK(MSD-252V-31)-AU-O		646010018015S	1	
L0101	00D2350191007	INDUCTOR(1MH)		00D2350191007	9	
L3903	nsp	E.FIL(BLM21PG221SN1)+2125		00D2350147909	1	
! L6501	11101005000AS	L.FILTER-12290(SQE24x24)	E3	11101005000AS	1	*
! L6501	11101010120AS	L.FILTER-07650(SQE24x24)	E2,E1C	11101010120AS	1	*
N0101	nsp	13P SOCKET(C125Z2)		645010057017S	9	
N0102	nsp	S5B-EH		00MYP06003950	9	
N3901	64301017200AS	9P D-SUB CONNECTOR(D227FD009S100BY)		64301017200AS	1	
N3902	nsp	7P SOCKET(C125Z2)		645010068000S	1	
N3903	nsp	19P FFC BASE (P=1)		00D2050892020	1	
N5801-5809	nsp	13P PLUG(C125Z1)		645010056014S	9	
N5813	nsp	S11B-PH-K-S (LF)(SN)		00MYJ06006510	1	
N5814	nsp	S3B-PH-K-S (LF)(SN)		00MYJ06006430	1	

REF No.	Part No.	Part Name	Remarks	Q'ty	New	Ver
N5815	nsp	S4B-PH-K-S (LF)(SN)		00MYJ06006440	1	
N5816	nsp	4P 80mm PH-SAN		61205049600AS	1	
N5823	nsp	S9B-PH-K-S (LF)(SN)		00MYJ06006490	1	
N5824	nsp	S3B-PH-K-S (LF)(SN)		00MYJ06006430	1	
N5831	nsp	S8B-PH-K-S (LF)(SN)		00MYJ06006480	1	
N5832	nsp	S10B-PH-K-S (LF)(SN)		00MYJ06006500	1	
N5834	nsp	B11B-PH-K-S (LF)(SN)		00MYJ06006310	1	
N5842	nsp	B12B-PH-K-S (LF)(SN)		00MYJ06006320	1	
N6501	nsp	CONNECTOR 2P B3P-VH		00MYP04000760	1	
N6502	nsp	B6B-EH 6P		00MYP06003840	1	
! S6501	68201003400AS	RELAY(G5PA-1-M-EDC5VTV-8)		68201003400AS	1	
! T6501	10201003700AS	SW-TRANS(STR28L-278)		10201003700AS	1	*
V0101	161010006405S	V6QB301T		161010006405S	9	
Z0101	252310006513S	PRF18BC471QB5RB		252310006513S	9	
Z0108	219050002102S	DHCT-A3/C3(4310F)		219050002102S	9	
! Z5801,5802	252310006506S	PRF18BB471QB5RB		252310006506S	2	
! Z5803	252310006544S	PRF18BF471QB5RB		252310006544S	1	
! Z5804	252310006513S	PRF18BC471QB5RB		252310006513S	1	
Z5810,5811	nsp	STYLE PIN		00D2050452017	2	
Z5815-5819	nsp	STYLE PIN		00D2050452017	5	
! Z6502	64105002280AS	AC INLET(R-30190)		64105002280AS	1	
Z6503	nsp	HEATSINK		44741007600AD	1	*
Z6504	nsp	3X8 CPS(SW W) ZNP		0RD4700051009	1	
Z6505	nsp	CLIP(TRK-24)		44431034100AS	1	*
Z6515	nsp	HEAT SINK(SMPS)		44731010100AD	1	*
Z6516	nsp	3X10 CBTS (S)-Z		0RD4737005002	1	

## AUDIO VIDEO PCB ASS'Y

※Parts indicated by "nsp" on this table cannot be supplied.

※The parts listed b NOTE: The symbols in the column Remarks indicate the following destinations.

E3 : U.S.A. & Canada model E2 : Europe model E1C : China model E1 : Asia model JP : Japan model  
BK : Black model SP : Premium Silver model

REF No.	Part No.	Part Name	Remarks	Q'ty	New	Ver
<b>SEMICONDUCTORS GROUP</b>						
D3501-3515	00D2760794900	KDS160-RTK/P		00D2760794900	15	
D5559-5561	251310004507S	CG0603MLC-12LE		251310004507S	3	
Q3501	00D2690192902	KRC102S-RTK/P (10K-10K)		00D2690192902	1	
Q3502	21585001550AS	KRA105S-RTK/P(2.2K-47K)		21585001550AS	1	
Q3503	00D2690192902	KRC102S-RTK/P (10K-10K)		00D2690192902	1	
Q3504	21585001550AS	KRA105S-RTK/P(2.2K-47K)		21585001550AS	1	
Q3505	00D2690192902	KRC102S-RTK/P (10K-10K)		00D2690192902	1	
Q3506	21585001550AS	KRA105S-RTK/P(2.2K-47K)		21585001550AS	1	
Q3507	00D2690192902	KRC102S-RTK/P (10K-10K)		00D2690192902	1	
Q3508	21585001550AS	KRA105S-RTK/P(2.2K-47K)		21585001550AS	1	
Q3509	00D2690192902	KRC102S-RTK/P (10K-10K)		00D2690192902	1	
Q3510	21585001550AS	KRA105S-RTK/P(2.2K-47K)		21585001550AS	1	
Q3511	00D2690192902	KRC102S-RTK/P (10K-10K)		00D2690192902	1	
Q3512	21585001550AS	KRA105S-RTK/P(2.2K-47K)		21585001550AS	1	
Q3513	00D2690192902	KRC102S-RTK/P (10K-10K)		00D2690192902	1	
Q3514	21585001550AS	KRA105S-RTK/P(2.2K-47K)		21585001550AS	1	
Q3515	00D2690192902	KRC102S-RTK/P (10K-10K)		00D2690192902	1	
Q3516	21585001550AS	KRA105S-RTK/P(2.2K-47K)		21585001550AS	1	
Q3517	00D2690192902	KRC102S-RTK/P (10K-10K)		00D2690192902	1	
Q3518	21585001550AS	KRA105S-RTK/P(2.2K-47K)		21585001550AS	1	
Q3519	00D2690192902	KRC102S-RTK/P (10K-10K)		00D2690192902	1	
Q3520	21585001550AS	KRA105S-RTK/P(2.2K-47K)		21585001550AS	1	
Q3521	00D2690192902	KRC102S-RTK/P (10K-10K)		00D2690192902	1	
Q3522	21585001550AS	KRA105S-RTK/P(2.2K-47K)		21585001550AS	1	
Q3523	00D2690192902	KRC102S-RTK/P (10K-10K)		00D2690192902	1	
Q3524	21585001550AS	KRA105S-RTK/P(2.2K-47K)		21585001550AS	1	
Q3525	00D2690192902	KRC102S-RTK/P (10K-10K)		00D2690192902	1	
Q3526	21585001550AS	KRA105S-RTK/P(2.2K-47K)		21585001550AS	1	
Q3527	00D2690192902	KRC102S-RTK/P (10K-10K)		00D2690192902	1	
Q3528,3529	21585001550AS	KRA105S-RTK/P(2.2K-47K)		21585001550AS	2	
Q3530	00D2690192902	KRC102S-RTK/P (10K-10K)		00D2690192902	1	
Q5201	213850009503S	2SC4617EBTLR		213850009503S	1	
Q5501	00D2690192902	KRC102S-RTK/P (10K-10K)		00D2690192902	1	
Q5502	00D2690193901	KRC104S-RTK/P (47K-47K)		00D2690193901	1	
U3001-3004	23381001450AS	CD74HC4094PWR		23381001450AS	4	*
U3005	23281004150AS	NJM8080G	E3	23281004150AS	1	
U3201,3202	235810045600S	R2A15220FP		235810045600S	2	
U3203,3204	00D2623727904	NJW1194V-TE1		00D2623727904	2	
U3205-3210	23281004150AS	NJM8080G		23281004150AS	6	
U3501	00D2630995004	NJM4556AD +T		00D2630995004	1	
U3703	235810046603S	AVDM-2000		235810046603S	1	
U5001	236810086505S	AK5358BET		236810086505S	1	
U5002,5003	23681012050AS	PCM5100PWR		23681012050AS	2	
U5004	00D2631047906	NJM2115M-TE1 +C		00D2631047906	1	
U5201,5202	236810082503S	PCM1690		236810082503S	2	
U5203-5209	23281004150AS	NJM8080G		23281004150AS	7	
U5501	236810064604S	AD8195ACPZ		236810064604S	1	
<b>RESISTOR GROUP</b>						
R3001-3004	nsp	RM73B--0R0KT +1608		00D2472018903	4	
R3026	nsp	RM73B--472JT (1608) +1608		00D2472009909	1	
R3027,3028	nsp	RM73B--0R0KT +1608		00D2472018903	2	
R3030	nsp	RM73B--750DT(1608)		00D2472032905	1	
R3031-3034	nsp	RM73B--0R0KT +1608		00D2472018903	4	
R3102	nsp	RM73B--0R0KT +1608	E3	00D2472018903	1	
R3104	nsp	RM73B--100JT +1608	E3	00D2472002964	1	
R3106	nsp	RM73B--100JT +1608	E3	00D2472002964	1	
R3111,3112	nsp	RM73B--393JT +1608	E3	00D2472011926	2	
R3113,3114	nsp	RM73B--243JT +1608	E3	00D2472010972	2	
R3115,3116	nsp	RM73B--104JT +1608	E3	00D2472012925	2	
R3117	nsp	RM73B--0R0KT +1608	E3	00D2472018903	1	
R3119,3120	nsp	RM73B--102JT +1608	E3	00D2472007943	2	
R3121,3122	nsp	RM73B--153JT +1608	E3	00D2472010927	2	
R3134-3137	nsp	RM73B--330JT +1608	E2,E1C	00D2472003989	4	
R3128,3129	nsp	RM73B--102JT +1608	E2,E1C	00D2472007943	2	
R3126,3127	nsp	RM73B--104JT +1608	E2,E1C	00D2472012925	2	
R3130,3131	nsp	RM73B--104JT +1608	E2,E1C	00D2472012925	2	
R3132,3133	nsp	RM73B--823JT +1608	E2,E1C	00D2472012909	2	
R3138	nsp	RM73B--222JT +1608	E2,E1C	00D2472008926	1	
R3201-3212	nsp	RM73B--471JT +1608		00D2472006960	12	
R3223-3234	nsp	RM73B--824JT +1608		00D2472014949	12	
R3237-3244	nsp	RM73B--824JT +1608		00D2472014949	8	
R3267	nsp	RM73B--473JT +1608		00D2472011942	1	
R3270-3275	nsp	RM73B--470JT +1608		00D2472004920	6	
R3276,3277	nsp	RM73B--473JT +1608		00D2472011942	2	
R3278-3283	nsp	RM73B--470JT +1608		00D2472004920	6	
R3284-3288	nsp	RM73B--473JT +1608		00D2472011942	5	
R3289,3290	nsp	RM73B--470JT +1608		00D2472004920	2	
R3291,3292	nsp	RM73B--473JT +1608		00D2472011942	2	
R3293,3294	nsp	RM73B--470JT +1608		00D2472004920	2	
R3295	nsp	RM73B--473JT +1608		00D2472011942	1	
R3296,3297	nsp	RM73B--470JT +1608		00D2472004920	2	
R3298	nsp	RM73B--0R0KT +1608		00D2472018903	1	
R3301-3304	nsp	RM73B--474JT +1608		00D2472013982	4	
R3305-3308	nsp	RM73B--154JT +1608		00D2472012967	4	
R3309-3312	nsp	RM73B--334JT +1608		00D2472013940	4	
R3313-3316	nsp	RM73B--101JT +1608		00D2472005903	4	
R3317-3320	nsp	RM73B--104JT +1608		00D2472012925	4	
R3321-3328	nsp	RM73B--393JT +1608		00D2472011926	8	
R3329-3332	nsp	RM73B--223JT +1608		00D2472010969	4	
R3333-3340	nsp	RM73B--472JT (1608) +1608		00D2472009909	8	
R3341-3344	nsp	RM73B--470JT +1608		00D2472004920	4	
R3345-3348	nsp	RM73B--104JT +1608		00D2472012925	4	
R3349-3352	nsp	RM73B--101JT +1608		00D2472005903	4	
R3353-3356	nsp	RM73B--472JT (1608) +1608		00D2472009909	4	
R3357-3364	nsp	RM73B--104JT +1608		00D2472012925	8	
R3371-3376	nsp	MNR04=473(1005X4)		126210009591S	6	
R3378-3383	nsp	PRB3T4=0R0(1005X4)		126250001502S	6	
R3386	nsp	MNR04=473(1005X4)		126210009591S	1	



REF No.	Part No.	Part Name	Remarks	Q'ty	New	Ver
R3501-3508	nsp	RM73B--100JT +1608		00D2472002964	8	
R3509-3525	nsp	RM73B--104JT +1608		00D2472012925	17	
R3526-3529	nsp	RM73B--224JT +1608		00D2472013908	4	
R3530-3531	nsp	RM73B--102JT +1608		00D2472007943	2	
R3532-3533	nsp	RM73B--222JT +1608		00D2472008926	2	
R3534-3535	nsp	RM73B--101JT +1608		00D2472005903	2	
R3536-3539	nsp	RM73B--222JT +1608		00D2472008926	4	
R3540-3556	nsp	RM73B--104JT +1608		00D2472012925	17	
R3557-3573	nsp	RM73B--221JT +1608		00D2472005987	17	
R3574	nsp	RM73B--100JT +1608		00D2472002964	1	
R3577-3580	nsp	RM73B--101JT +1608		00D2472005903	4	
R3581-3582	nsp	RM73B--221JT +1608		00D2472005987	2	
R3583-3584	nsp	RM73B--104JT +1608		00D2472012925	2	
R3585-3590	nsp	RM73B--100JT +1608		00D2472002964	6	
R3701-3706	nsp	RM73B--750DT(1608)		00D2472032905	6	
R3710-3713	nsp	RM73B--750DT(1608)		00D2472032905	4	
R3716	nsp	RM73B--750JT +1608		00D2472004975	1	
R3723-3724	nsp	RM73B--OROKT +1608		00D2472018903	2	
R3729	nsp	RM73B--750JT +1608		00D2472004975	1	
R3731	nsp	RM73B--750DT(1608)		00D2472032905	1	
R3732	nsp	RM73B--OROKT +1608		00D2472018903	1	
R3734-3735	nsp	RM73B--472JT (1608) +1608		00D2472009909	2	
R3736	nsp	RM73B--100JT +1608		00D2472002964	1	
R3737	nsp	RM73B--102JT +1608		00D2472007943	1	
R3738-3739	nsp	RM73B--101JT +1608		00D2472005903	2	
R3740	nsp	RM73B--750DT(1608)		00D2472032905	1	
R3741	nsp	RM73B--472JT (1608) +1608		00D2472009909	1	
R3742	nsp	RM73B--750DT(1608)		00D2472032905	1	
R3743	nsp	RM73B--102JT +1608		00D2472007943	1	
R3744	nsp	RM73B--100JT +1608		00D2472002964	1	
R3746	nsp	RM73B--750DT(1608)		00D2472032905	1	
R3747	nsp	RM73B--102JT +1608		00D2472007943	1	
R3748	nsp	RM73B--100JT +1608		00D2472002964	1	
R3750	nsp	RM73B--750DT(1608)		00D2472032905	1	
R3751	nsp	RM73B--102JT +1608		00D2472007943	1	
R3752	nsp	RM73B--100JT +1608		00D2472002964	1	
R3753	nsp	RM73B--750JT +1608		00D2472004975	1	
R3761	nsp	RM73B--750JT +1608		00D2472004975	1	
R5001-5002	nsp	RM73B--103JT +1005		00D2473010984	2	
R5003	nsp	RM73B--473JT+1005		00D2473012940	1	
R5004-5005	nsp	RM73B--103JT +1005		00D2473010984	2	
R5006	nsp	RM73B--473JT+1005		00D2473012940	1	
R5007-5009	nsp	RM73B--102JT		00D2473008941	3	
R5010	nsp	RM73B--330JT +1005		00D2473004987	1	
R5013-5014	nsp	RM73B--101JT +1608		00D2472005903	2	
R5015-5018	nsp	RM73B--471JT +1608		00D2472006960	4	
R5019	nsp	RM73B--101JT +1608		00D2472005903	1	
R5020-5021	nsp	RM73B--332JT +1608		00D2472008968	2	
R5022	nsp	RM73B--101JT +1608		00D2472005903	1	
R5023	nsp	RM73B--472JT (1608) +1608		00D2472009909	1	
R5024-5025	nsp	RM73B--683JT +1608		00D2472011984	2	
R5026	nsp	RM73B--472JT (1608) +1608		00D2472009909	1	
R5027-5028	nsp	RM73B--474JT +1608		00D2472013982	2	
R5201	nsp	RM73B--104JT +1608		00D2472012925	1	
R5202	nsp	RM73B--680JT +1608		00D2472004962	1	
R5203	nsp	RM73B--471JT +1608		00D2472006960	1	
R5204	nsp	RM73B--182JT +1608		00D2472008900	1	
R5205	nsp	RM73B--222JT +1608		00D2472008926	1	
R5206	nsp	RM73B--392JT +1608		00D2472008984	1	
R5207-5208	nsp	RM73B--102JT		00D2473008941	2	
R5209-5213	nsp	RM73B--472JT+1005		00D2473010900	5	
R5214-5227	nsp	RM73B--153JT +1608		00D2472010927	14	
R5230-5241	nsp	RM73B--153JT +1608		00D2472010927	12	
R5246-5248	nsp	RM73B--154JT +1608		00D2472012967	3	
R5250-5251	nsp	RM73B--154JT +1608		00D2472012967	2	
R5254-5259	nsp	RM73B--154JT +1608		00D2472012967	6	
R5262-5264	nsp	RM73B--123JT +1608		00D2472010901	3	
R5265	nsp	RM73B--223JT +1608		00D2472010969	1	
R5266-5267	nsp	RM73B--123JT +1608		00D2472010901	2	
R5268	nsp	RM73B--223JT +1608		00D2472010969	1	
R5270-5275	nsp	RM73B--123JT +1608		00D2472010901	6	
R5278-5283	nsp	RM73B--471JT +1608		00D2472006960	6	
R5284-5285	nsp	RM73B--821JT +1608		00D2472007927	2	
R5286-5289	nsp	RM73B--471JT +1608		00D2472006960	4	
R5290-5291	nsp	RM73B--821JT +1608		00D2472007927	2	
R5294-5305	nsp	RM73B--471JT +1608		00D2472006960	12	
R5310	nsp	RM73B--154JT +1608		00D2472012967	1	
R5311-5312	nsp	RM73B--123JT +1608		00D2472010901	2	
R5313-5314	nsp	RM73B--154JT +1608		00D2472012967	2	
R5315	nsp	RM73B--123JT +1608		00D2472010901	1	
R5316	nsp	RM73B--223JT +1608		00D2472010969	1	
R5318	nsp	RM73B--154JT +1608		00D2472012967	1	
R5319-5320	nsp	RM73B--123JT +1608		00D2472010901	2	
R5321	nsp	RM73B--154JT +1608		00D2472012967	1	
R5323	nsp	RM73B--223JT +1608		00D2472010969	1	
R5326	nsp	RM73B--154JT +1608		00D2472012967	1	
R5327-5328	nsp	RM73B--123JT +1608		00D2472010901	2	
R5329-5330	nsp	RM73B--154JT +1608		00D2472012967	2	
R5331-5332	nsp	RM73B--123JT +1608		00D2472010901	2	
R5333-5334	nsp	RM73B--154JT +1608		00D2472012967	2	
R5335-5336	nsp	RM73B--123JT +1608		00D2472010901	2	
R5337	nsp	RM73B--154JT +1608		00D2472012967	1	
R5342-5348	nsp	RM73B--101JT +1608		00D2472005903	7	
R5350-5355	nsp	RM73B--101JT +1608		00D2472005903	6	
R5372-5378	nsp	RM73B--103JT +1608		00D2472009983	7	
R5380-5385	nsp	RM73B--103JT +1608		00D2472009983	6	
R5501	nsp	RM73B--102JT		00D2473008941	1	
R5502	nsp	RM73B--103JT +1005		00D2473010984	1	
R5503	nsp	RM73B--473JT+1005		00D2473012940	1	
R5505-5506	nsp	RM73B--OROKT +1608		00D2472018903	2	
R5508-5509	nsp	RM73B--103JT +1005		00D2473010984	2	
R5510-5511	nsp	RM73B--OROKT+1005		00D2473001906	2	
R5515	nsp	RM73B--OROKT+1005		00D2473001906	1	
R5516-5519	nsp	MNR02=000(1005X2)		12625000450AS	4	
R5559	nsp	RM73B--222JT +1608		00D2472008926	1	
R8063-8064	nsp	RM73B--OROKT +1608		00D2472018903	2	

REF No.	Part No.	Part Name	Remarks	Q'ty	New	Ver
R8071	nsp	RM73B--0R0KT +2125	E3	00D2470018905	1	
R8072	nsp	RM73B--0R0KT +1608	E2,E1C	00D2472018903	1	
R8076-8079	nsp	RM73B--103JT +1608		00D2472009983	4	
<b>CAPACITORS GROUP</b>						
C3022-3025	nsp	CK73B1E104KT +1608		00D2570516954	4	
C3026	nsp	CK73X5R0J106MT(2125)		132450038507S	1	
C3028	nsp	CK73B1E104KT +1608		00D2570516954	1	
C3101	nsp	CK73B1E104KT +1608	E3	00D2570516954	1	
C3102-3104	nsp	CC73CH1H101JT +1608	E3	00D2570506951	3	
C3105	nsp	CK73B1E104KT +1608	E3	00D2570516954	1	
C3107-3110	13405014840AS	CE04W1J100MT(KR3)	E3	13405014840AS	4	
C3112,3113	nsp	CC73CH1H471JT +1608	E3	00D2570508917	2	
C3115,3116	nsp	CC73CH1H330JT +1608	E3	00D2570504940	2	
C3117,3118	nsp	CK73B1E104KT +1608	E3	00D2570516954	2	
C3119,3120	13405014840AS	CE04W1J100MT(KR3)	E3	13405014840AS	2	
C3123	nsp	CC73CH1H101JT +1608	E2,E1C	00D2570506951	1	
C3126-3129	nsp	CC73CH1H101JT +1608	E2,E1C	00D2570506951	4	
C3133-3135	13405014840AS	CE04W1J100MT(KR3)	E2,E1C	13405014840AS	3	
C3139	nsp	CK73X5R1C106KT(2125)	E3	13245005950AS	1	
C3201-3212	nsp	CC73CH1H331JT +1608		00D2570507976	12	
C3241	13405012740AS	CE04W1A331MT(KR3)		13405012740AS	1	
C3242	13405013040AS	CE04W1E221MT(KR3)		13405013040AS	1	
C3243-3247	13405012740AS	CE04W1A331MT(KR3)		13405012740AS	5	
C3248-3250	13405013040AS	CE04W1E221MT(KR3)		13405013040AS	3	
C3251-3260	13405012740AS	CE04W1A331MT(KR3)		13405012740AS	10	
C3301-3304	nsp	CK73X5R1C106KT(2125)		13245005950AS	4	
C3305-3312	nsp	CK73B1H103KT (1608) +1608		00D2570501901	8	
C3313-3316	nsp	CK73X5R1C106KT(2125)		13245005950AS	4	
C3317-3324	nsp	CC73CH1H101JT +1608		00D2570506951	8	
C3325-3328	nsp	CK73X5R1C106KT(2125)		13245005950AS	4	
C3329-3332	nsp	CK73B1E104KT +1608		00D2570516954	4	
C3333-3336	nsp	CK73X5R1C106KT(2125)		13245005950AS	4	
C3341,3342	nsp	CK73X5R1C106KT(2125)		13245005950AS	2	
C3343-3346	nsp	CK73B1H332KT +1608		00D2570510918	4	
C3347-3350	nsp	CK73X5R1C106KT(2125)		13245005950AS	4	
C3351-3354	nsp	RM73B--0R0KT +2125		00D2470018905	4	
C3355-3358	nsp	CK73X5R1C106KT(2125)		13245005950AS	4	
C3359-3362	nsp	CK73B1E104KT +1608		00D2570516954	4	
C3519-3537	13405014840AS	CE04W1J100MT(KR3)		13405014840AS	19	
C3538,3539	nsp	CC73CH1H221JT +1608		00D2570507934	2	
C3540,3541	13405012940AS	CE04W1C101MT(KR3)		13405012940AS	2	
C3542-3558	nsp	CC73CH1H471JT +1608		00D2570508917	17	
C3561,3562	nsp	CC73CH1H471JT +1608		00D2570508917	2	
C3705-3710	nsp	CK73X5R0J106MT(2125)		132450038507S	6	
C3714-3717	nsp	CK73X5R0J106MT(2125)		132450038507S	4	
C3729-3731	nsp	CK73B1E104KT +1608		00D2570516954	3	
C3734-3747	nsp	CK73B1E104KT +1608		00D2570516954	14	
C3748,3749	13405012840AS	CE04W1A101MT(KR3)		13405012840AS	2	
C5001,5002	nsp	CK73B1E104KT +1608		00D2570516954	2	
C5003	nsp	CK73B1H102KT +1005		00D2575006993	1	
C5004,5005	nsp	CK73B1E104KT +1608		00D2570516954	2	
C5006	nsp	CK73B1H102KT +1005		00D2575006993	1	
C5007	13405012840AS	CE04W1A101MT(KR3)		13405012840AS	1	
C5008	nsp	CK73B0J475KT +1608		00D2570522906	1	
C5011	nsp	CK73B1A225KT 1608		132350029504S	1	
C5012	nsp	CK73B1H102KT +1005		00D2575006993	1	
C5014	nsp	CK73B0J475KT +1608		00D2570522906	1	
C5015,5016	13405012840AS	CE04W1A101MT(KR3)		13405012840AS	2	
C5017	nsp	CK73B0J475KT +1608		00D2570522906	1	
C5018	nsp	CK73B1E104KT +1608		00D2570516954	1	
C5019,5020	nsp	CK73B1A225KT 1608		132350029504S	2	
C5021	nsp	CK73B1E104KT +1608		00D2570516954	1	
C5022	nsp	CK73B0J475KT +1608		00D2570522906	1	
C5023	nsp	CK73B1E104KT +1608		00D2570516954	1	
C5024,5025	nsp	CK73B1A225KT 1608		132350029504S	2	
C5026	nsp	CK73B1E104KT +1608		00D2570516954	1	
C5027,5028	13405014840AS	CE04W1J100MT(KR3)		13405014840AS	2	
C5029	nsp	CK73X5R0J106MT(2125)		132450038507S	1	
C5030,5031	nsp	CC73CH1H103JT +2125		00D2570041924	2	
C5032-5035	nsp	CC73CH1H222JT +1608		00D2570505936	4	
C5036,5037	nsp	CC73CH1H471JT +1608		00D2570508917	2	
C5042	nsp	CK73B0J475KT +1608		00D2570522906	1	
C5043,5044	13405014840AS	CE04W1J100MT(KR3)		13405014840AS	2	
C5045	nsp	CK73B0J475KT +1608		00D2570522906	1	
C5046	13405013040AS	CE04W1E221MT(KR3)		13405013040AS	1	
C5201	nsp	CK73B1A105KT +1608		00D2570521907	1	
C5203	nsp	RM73B--471JT +1608		00D2472006960	1	
C5204-5214	nsp	CK73B1A104KT +1005		00D2575008933	11	
C5215	13405012740AS	CE04W1A331MT(KR3)		13405012740AS	1	
C5216	nsp	CK73B1A104KT +1005		00D2575008933	1	
C5217	13405012740AS	CE04W1A331MT(KR3)		13405012740AS	1	
C5218,5219	nsp	CK73B0J475KT +1608		00D2570522906	2	
C5220,5221	13405012940AS	CE04W1C101MT(KR3)		13405012940AS	2	
C5222	nsp	CK73B1A104KT +1005		00D2575008933	1	
C5223,5224	nsp	CK73B0J475KT +1608		00D2570522906	2	
C5225	nsp	CK73B1A104KT +1005		00D2575008933	1	
C5226,5227	00D2544569937	CE04W1E221MT(RA3)		00D2544569937	2	
C5228-5230	nsp	CC73CH1H182JT +1608		00D2570505923	3	
C5231	nsp	CC73CH1H102JT +1608		00D2570508988	1	
C5232,5233	nsp	CC73CH1H182JT +1608		00D2570505923	2	
C5234	nsp	CC73CH1H102JT +1608		00D2570508988	1	
C5236-5241	nsp	CC73CH1H182JT +1608		00D2570505923	6	
C5244-5246	nsp	CC73CH1H271JT +1608		00D2570507950	3	
C5247	nsp	CC73CH1H151JT +1608		00D2570506993	1	
C5248,5249	nsp	CC73CH1H271JT +1608		00D2570507950	2	
C5250	nsp	CC73CH1H151JT +1608		00D2570506993	1	
C5251	nsp	RM73B--0R0KT +1608		00D2472018903	1	
C5252-5257	nsp	CC73CH1H271JT +1608		00D2570507950	6	
C5260-5262	nsp	CC73CH1H271JT +1608		00D2570507950	3	
C5263	nsp	CC73CH1H151JT +1608		00D2570506993	1	
C5264,5265	nsp	CC73CH1H271JT +1608		00D2570507950	2	
C5266	nsp	CC73CH1H151JT +1608		00D2570506993	1	
C5267	nsp	RM73B--0R0KT +1608		00D2472018903	1	
C5268-5273	nsp	CC73CH1H271JT +1608		00D2570507950	6	
C5276-5289	nsp	CC73CH1H103JT +2125		00D2570041924	14	
C5292-5295	13405013040AS	CE04W1E221MT(KR3)		13405013040AS	4	

REF No.	Part No.	Part Name	Remarks	Q'ty	New	Ver
C5310-5312	00D2544583971	CE04W1H470MT(ROB)		00D2544583971	3	
C5313	13405014340AS	CE04W1H470MT(KR3)		13405014340AS	1	
C5314,5315	00D2544583971	CE04W1H470MT(ROB)		00D2544583971	2	
C5316	13405014340AS	CE04W1H470MT(KR3)		13405014340AS	1	
C5318-5323	13405014340AS	CE04W1H470MT(KR3)		13405014340AS	6	
C5324-5331	nsp	CK73B1A104KT +1005		00D2575008933	8	
C5501	nsp	CK73B1E104KT +1608		00D2570516954	1	
C5502-5505	nsp	CK73B1A104KT +1005		00D2575008933	4	
C5506	nsp	CK73X5R0J106MT(2125)		132450038507S	1	
C5507	nsp	CK73B1H102KT +1005		00D2575008933	1	
C5508	nsp	CK73B1E103KT(1005)		00D2575008946	1	
C5509	nsp	CK73B1H102KT +1005		00D2575006993	1	
C5510-5520	nsp	CK73X5R0J106MT(2125)		132450038507S	11	
C5560	nsp	CK73B1E104KT +1608		00D2570516954	1	
C5561	00D2544645903	CE67C0J221MT(MVA) +REF		00D2544645903	1	
C5567-5570	nsp	CK73X5R1C106KT(2125)		13245005950AS	4	
C5577-5582	nsp	CK73B1E104KT +1608		00D2570516954	6	
<b>OTHER PARTS GROUP</b>						
B3001,3002	nsp	M3 SCREW TERMINAL		00D2051034007	2	
K3102,3103	64301016600AS	6P PIN JACK(RCA-637G)-AU-RW		64301016600AS	2	
K3104,3105	64601001803AS	2P PIN JACK(MSD-252V)-AU-RD/W/T		64601001803AS	2	*
K3301	64301016600AS	6P PIN JACK(RCA-637G)-AU-RW		64301016600AS	1	
K3302	64301016800AS	3P PIN JACK(RCA-349BG)-AU-WBB		64301016800AS	1	
K3303	64301016600AS	6P PIN JACK(RCA-637G)-AU-RW		64301016600AS	1	
K3501	64301017000AS	6P PIN JACK(RCA-637G)-AU-GBR		64301017000AS	1	
K3503	64301016900AS	6P PIN JACK(RCA-637G)-AU-Y		64301016900AS	1	
K3505	64301017100AS	3P PIN JACK(RCA-349BG)-AU-GBR		64301017100AS	1	
K5201	64301018100AS	1P PIN JACK(RJ-0111R-00T)		64301018100AS	1	
K5501	64401030160AS	A0D7ABAR19N0		64401030160AS	1	*
L3003	nsp	E.FIL(BLM21PG221SN1)+2125	E2,E1C	00D2350147909	1	
L5559	113410007504S	DLW21SN181SQ2L		113410007504S	1	
L5560	nsp	E.FIL(BLM21PG221SN1)+2125		00D2350147909	1	
N3001	nsp	33P SOCKET(C125Z2)		645010057093S	1	
N3003	nsp	33P FFC BASE		00D2050736005	1	
N3008	nsp	13P FFC BASE(9604SC)	E3	00D2051258045	1	
N3009	nsp	B3B-PH-K-S (LF)(SN)		00MYJ06006230	1	
N3201	nsp	B10B-PH-K-S (LF)(SN)		00MYJ06006300	1	
N3202	nsp	B8B-PH-K-S (LF)(SN)		00MYJ06006280	1	
N4818	nsp	21P SOCKET(C125Z2)		645010057055S	1	
N5001	nsp	33P SOCKET(C125Z2)		645010057093S	1	
N5202	nsp	33P PLUG(C125Z1)		645010056090S	1	
N5204	nsp	33P PLUG(C125Z1)		645010056090S	1	
N5205,5206	nsp	33P SOCKET(C125Z2)		645010057093S	2	
N5501	nsp	25P FFC.BASE(9610SCA +REF		00D2051313906	1	
N5559	00D2051381103	USB CONNECTOR		00D2051381103	1	
N5560	nsp	B5B-PH-K-S (LF)(SN)		00MYJ06006250	1	
N5901-5904	nsp	33P PLUG(C125Z1)		645010056090S	4	
N5905,5906	nsp	17P PLUG(C125Z1)		645010056038S	2	
N5907,5908	nsp	19P PLUG(C125Z1)		645010056045S	2	
N5909,5910	nsp	21P PLUG(C125Z1)		645010056052S	2	
N9014	nsp	B6B-PH-K-S (LF)(SN)		00MYJ06006260	1	
N9015	nsp	7P SOCKET(C125Z2)		645010068000S	1	
N9016,9017	nsp	7P PLUG(C125Z1)		645010067007S	2	
N9018	nsp	17P SOCKET(C125Z2)		645010057031S	1	
N9019	nsp	19P SOCKET(C125Z2)		645010057048S	1	
N9022,9023	nsp	B7B-EH		00MYP06010460	2	
S3501-3515	68201004200AS	RELAY(G6J-2P-Y)		68201004200AS	15	*
Z3001	18301004100AS	AM/FM+RDS TUNER MODULE	E2	18301004100AS	1	*
Z3001	18301004200AS	AM/FM TUNER MODULE	E1C	18301004200AS	1	*
Z3701	nsp	STYLE PIN		00D2050452017	1	
Z5501	nsp	FRONT HDMI BRACKET		44431032700AD	1	*
Z5559	nsp	FRONT USB BRACKET		44431032600AD	1	*
Z5901	nsp	STYLE PIN		00D2050452017	1	

## DIGITAL PCB ASS'Y

※Parts indicated by "nsp" on this table cannot be supplied.

※The parts listed b NOTE: The symbols in the column Remarks indicate the following destinations.

E3 : U.S.A. & Canada model E2 : Europe model E1C : China model E1 : Asia model JP : Japan model  
BK : Black model SP : Premium Silver model

REF No.	Part No.	Part Name	Remarks	Q'ty	New	Ver
<b>SEMICONDUCTORS GROUP</b>						
D2448	00D2760750902	RB521S-30TE61 +REF		00D2760750902	1	
D3404	00D2760794900	KDS160-RTK/P		00D2760794900	1	
D3413	25131010150AS	NV73A1JTTE8.2		25131010150AS	1	*
D5001-5003	00D2760794900	KDS160-RTK/P		00D2760794900	3	
Q1001,1002	00D2690144905	DTC114YKA-T146 +C		00D2690144905	2	
Q1906	00MBA2000399Y	KRC402E-RTK KEC		00MBA2000399Y	1	
Q1907	00MBA2000199Y	KRC404E-RTK KEC STANDARD		00MBA2000199Y	1	
Q1908	211850008504S	2SA2018TL		211850008504S	1	
Q1909	00D2750110905	HN1K02FU-TE85L		00D2750110905	1	
Q2101,2102	213850009503S	2SC4617EBTLR		213850009503S	2	
Q2103	00MBA2000399Y	KRC402E-RTK KEC		00MBA2000399Y	1	
Q2105	00MBA2000399Y	KRC402E-RTK KEC		00MBA2000399Y	1	
Q2400-2402	00MBA2000399Y	KRC402E-RTK KEC		00MBA2000399Y	3	
Q2404-2406	00MBA2000399Y	KRC402E-RTK KEC		00MBA2000399Y	3	
Q2408-2410	00MBA2000399Y	KRC402E-RTK KEC		00MBA2000399Y	3	
Q2600-2607	00MBA2000399Y	KRC402E-RTK KEC		00MBA2000399Y	8	
Q3402	00D2740195901	2SD2114KT196 +C		00D2740195901	1	
Q3601	211850008504S	2SA2018TL		211850008504S	1	
Q3603,3604	00MBA2000199Y	KRC404E-RTK KEC STANDARD		00MBA2000199Y	2	
Q3605	00D2757001907	FDC608PZ		00D2757001907	1	
Q5001	00MBA2000399Y	KRC402E-RTK KEC		00MBA2000399Y	1	
Q5002	211850008504S	2SA2018TL		211850008504S	1	
Q5003	00MBA2000399Y	KRC402E-RTK KEC		00MBA2000399Y	1	
Q5004	00D2757001907	FDC608PZ		00D2757001907	1	
Q5005	213850009503S	2SC4617EBTLR		213850009503S	1	
Q5006-5008	00MBA2000399Y	KRC402E-RTK KEC		00MBA2000399Y	3	
Q5009	211850008504S	2SA2018TL		211850008504S	1	
U0101	24581010060AD	ADSP-21487KSWZ-4B(3071-1)		24581010060AD	1	*
U0102	-	MX25L1606EM2I-12G		24681009160AS	1	*
U0102	9R2481025500S	DSP1 ROM SUB ASSY		-	1	*
U0103	24681008960AS	A3V56S40GTP-60		24681008960AS	1	
U0201	24581010061AD	ADSP-21487KSWZ-4B(3071-2)		24581010061AD	1	*
U0202	-	MX25L1606EM2I-12G		24681009160AS	1	*
U0202	9R2481025600S	DSP2 ROM SUB ASSY		-	1	*
U0203	24681008960AS	A3V56S40GTP-60		24681008960AS	1	
U0301	24581010062AD	ADSP-21487KSWZ-4B(3071-3)		24581010062AD	1	*
U0302	-	MX25L1606EM2I-12G		24681009160AS	1	*
U0302	9R2481025700S	DSP3 ROM SUB ASSY		-	1	*
U0303	24681008960AS	A3V56S40GTP-60		24681008960AS	1	
U0401	24581010063AD	ADSP-21487KSWZ-4B(3071-4)		24581010063AD	1	*
U0402	-	MX25L1606EM2I-12G		24681009160AS	1	*
U0402	9R2481030200S	DSP4 ROM SUB ASSY		-	1	*
U0403	24681008960AS	A3V56S40GTP-60		24681008960AS	1	
U0602	nsp	MX25L25635FMI-10G		24681009260AS	1	*
U0603	23681012650AS	NCP380HMU21AATBG		23681012650AS	1	
U0607	23671011050AS	MFI337S3959 IP0D COPROCESSOR 2.0C CLASS6		23671011050AS	1	
U0608-0611	231810089509S	EX3AV		231810089509S	4	
U1000	23681014050AS	PCM9211		23681014050AS	1	
U1004,1005	23681016350AS	LC89091JA		23681016350AS	2	*
U1201	23681011960AS	5M570ZF256C5N		23681011960AS	1	
U1202	23171011751AS	NJM2845DL1-18		23171011751AS	1	
U1203	236810083506S	CS2100-10-CZZR		236810083506S	1	
U1205	236810012504S	FCXO-05B(24.576MHz)		236810012504S	1	
U1206	14181010150AS	TXC 8W(25.000MHZ)		14181010150AS	1	*
U1901,1902	231810089509S	EX3AV		231810089509S	2	
U1903	00D2623436907	TC74VHC244FT		00D2623436907	1	
U1904	23381001250AS	SN74AHC04PWR		23381001250AS	1	*
U1905	23171011750AS	NJM2845DL1-33		23171011750AS	1	
U1906	231810089509S	EX3AV		231810089509S	1	
U2000	23681012760AS	ADV7850KBCZ-5		23681012760AS	1	
U2101	-	R5F5210ABDFP		24181004160AS	1	
U2101	9R2431019900S	SUB CPU SUB ASSY(AVRX5200)		-	1	*
U2400	23381001350AS	SN74CBT3251PWR		23381001350AS	1	*
U2401	23681015960AS	MN8647771		23681015960AS	1	*
U2601	23681015960AS	MN8647771		23681015960AS	1	*
U2800	23681016160AS	AD55058Z-0(ADV8003-8B)		23681016160AS	1	
U2801	-	MX25L12835FMI-10G		24681008460AS	1	
U2801	9R2481025900S	GUI ROM SUB ASSY(AVRX5200E3/E2)	E3, E2	-	1	*
U2801	9R2481025901S	GUI ROM SUB ASSY(AVRX5200E1C)	E1C	-	1	*
U3000,3001	24681020160AS	A3R12E40CBF-8E		24681020160AS	2	
U3200	26381020260AS	EPM570F256C4N		26381020260AS	1	*
U3401	23681015960AS	MN8647771		23681015960AS	1	*
U3600	231810089509S	EX3AV		231810089509S	1	
U3601	23681013550AS	NCP380HMUAJAATBG		23681013550AS	1	
U3603-3606	231810089509S	EX3AV		231810089509S	4	
U5001	-	R5F56108VNFP		24181003860AS	1	*
U5001	9R2431019800S	MAIN CPU SUB ASSY(AVRX5200)	E3, E2	-	1	*
U5001	9R2431019801S	MAIN CPU SUB ASSY(AVRX5200W/E1C)	E1C	-	1	*
U5002	24681009350AS	R1EX24256BSA0I		24681009350AS	1	*
U5003	23981007450AS	PST8448(SC-82AB)		23981007450AS	1	
U5004	23171011750AS	NJM2845DL1-33		23171011750AS	1	
<b>RESISTOR GROUP</b>						
R0102	nsp	RM73B--472JT+1005		00D2473010900	1	
R0103	nsp	RM73B--0R0KT+1005		00D2473001906	1	
R0105-0108	nsp	RM73B--330JT +1005		00D2473004987	4	
R0109,0110	nsp	RM73B--472JT+1005		00D2473010900	2	
R0111	nsp	RM73B--470JT +1005		00D2473005928	1	
R0113	nsp	RM73B--330JT +1005		00D2473004987	1	
R0117	nsp	RM73B--470JT +1005		00D2473005928	1	
R0118	nsp	RM73B--472JT+1005		00D2473010900	1	
R0123	nsp	RM73B--472JT+1005		00D2473010900	1	
R0124,0125	nsp	RM73B--472JT (1608) +1608		00D2472009909	2	
R0126	nsp	RM73B--472JT+1005		00D2473010900	1	
R0128-0130	nsp	RM73B--330JT +1005		00D2473004987	3	
R0141	nsp	MNR04=472(1005X4)		126210007557S	1	
R0143-0146	nsp	MNR04=330(1005X4)		126210002538S	4	
R0149	nsp	MNR04=820(1005X4)		126210003531S	1	
R0150	nsp	MNR04=330(1005X4)		126210002538S	1	

REF No.	Part No.	Part Name	Remarks	Q'ty	New	Ver
R0151	nsp	MNR04=472(1005X4)		126210007557S	1	
R0152	nsp	MNR04=103(1005X4)		126210008536S	1	
R0153	nsp	RM73B--472JT+1005		00D2473010900	1	
R0155_0156	nsp	MNR04=472(1005X4)		126210007557S	2	
R0157-0160	nsp	MNR04=100(1005X4)		126210001511S	4	
R0162-0168	nsp	RM73B--820JT		00D2473005986	7	
R0169,0170	nsp	RM73B--100JT		00D2473003962	2	
R0175-0178	nsp	MNR04=560(1005X4)		126210002590S	4	
R0179,0180	nsp	MNR04=330(1005X4)		126210002538S	2	
R0181-0183	nsp	RM73B--472JT+1005		00D2473010900	3	
R0184	nsp	MNR04=330(1005X4)		126210002538S	1	
R0185	nsp	RM73B--330JT+1005		00D2473004987	1	
R0186	nsp	RM73B--560JT		00D2473005944	1	
R0187	nsp	RM73B--820JT		00D2473005986	1	
R0189	nsp	RM73B--820JT		00D2473005986	1	
R0202	nsp	RM73B--472JT+1005		00D2473010900	1	
R0203	nsp	RM73B--OR0KT+1005		00D2473001906	1	
R0205_0206	nsp	RM73B--330JT+1005		00D2473004987	2	
R0207	nsp	RM73B--472JT (1608) +1608		00D2472009909	1	
R0208	nsp	RM73B--330JT+1005		00D2473004987	1	
R0209_0210	nsp	RM73B--472JT+1005		00D2473010900	2	
R0211	nsp	RM73B--470JT+1005		00D2473005928	1	
R0213	nsp	RM73B--330JT+1005		00D2473004987	1	
R0216	nsp	RM73B--472JT+1005		00D2473010900	1	
R0217	nsp	RM73B--470JT+1005		00D2473005928	1	
R0218	nsp	RM73B--472JT+1005		00D2473010900	1	
R0223	nsp	RM73B--472JT+1005		00D2473010900	1	
R0224-0227	nsp	RM73B--330JT+1005		00D2473004987	4	
R0228	nsp	RM73B--472JT (1608) +1608		00D2472009909	1	
R0241	nsp	MNR04=472(1005X4)		126210007557S	1	
R0243-0246	nsp	MNR04=330(1005X4)		126210002538S	4	
R0247_0248	nsp	RM73B--472JT+1005		00D2473010900	2	
R0250	nsp	MNR04=330(1005X4)		126210002538S	1	
R0251	nsp	MNR04=472(1005X4)		126210007557S	1	
R0252	nsp	MNR04=103(1005X4)		126210008536S	1	
R0253	nsp	RM73B--472JT+1005		00D2473010900	1	
R0255	nsp	RM73B--472JT+1005		00D2473010900	1	
R0256	nsp	MNR04=472(1005X4)		126210007557S	1	
R0257-0260	nsp	MNR04=100(1005X4)		126210001511S	4	
R0262-0266	nsp	RM73B--330JT+1005		00D2473004987	5	
R0268	nsp	RM73B--330JT+1005		00D2473004987	1	
R0269_0270	nsp	RM73B--100JT		00D2473003962	2	
R0273	nsp	MNR04=101(1005X4)		126210003555S	1	
R0275-0278	nsp	MNR04=560(1005X4)		126210002590S	4	
R0279_0280	nsp	MNR04=330(1005X4)		126210002538S	2	
R0281	nsp	RM73B--472JT+1005		00D2473010900	1	
R0284	nsp	MNR04=330(1005X4)		126210002538S	1	
R0285	nsp	RM73B--330JT+1005		00D2473004987	1	
R0288-0290	nsp	RM73B--330JT+1005		00D2473004987	3	
R0291	nsp	RM73B--560JT		00D2473005944	1	
R0292_0293	nsp	RM73B--820JT		00D2473005986	2	
R0302	nsp	RM73B--472JT+1005		00D2473010900	1	
R0303	nsp	RM73B--OR0KT+1005		00D2473001906	1	
R0305_0306	nsp	RM73B--330JT+1005		00D2473004987	2	
R0307	nsp	RM73B--472JT+1005		00D2473010900	1	
R0308	nsp	RM73B--330JT+1005		00D2473004987	1	
R0309_0310	nsp	RM73B--472JT+1005		00D2473010900	2	
R0311	nsp	RM73B--470JT+1005		00D2473005928	1	
R0313	nsp	RM73B--330JT+1005		00D2473004987	1	
R0316	nsp	RM73B--330JT+1005		00D2473004987	1	
R0317	nsp	RM73B--470JT+1005		00D2473005928	1	
R0318	nsp	RM73B--472JT+1005		00D2473010900	1	
R0321-0323	nsp	RM73B--472JT+1005		00D2473010900	3	
R0324-0328	nsp	RM73B--330JT+1005		00D2473004987	5	
R0330_0331	nsp	RM73B--330JT+1005		00D2473004987	2	
R0341	nsp	MNR04=472(1005X4)		126210007557S	1	
R0343-0346	nsp	MNR04=330(1005X4)		126210002538S	4	
R0349_0350	nsp	MNR04=330(1005X4)		126210002538S	2	
R0351	nsp	MNR04=472(1005X4)		126210007557S	1	
R0352	nsp	MNR04=103(1005X4)		126210008536S	1	
R0353	nsp	RM73B--472JT+1005		00D2473010900	1	
R0355	nsp	RM73B--472JT+1005		00D2473010900	1	
R0356	nsp	MNR04=472(1005X4)		126210007557S	1	
R0357-0360	nsp	MNR04=100(1005X4)		126210001511S	4	
R0361	nsp	RM73B--330JT+1005		00D2473004987	1	
R0363_0364	nsp	RM73B--330JT+1005		00D2473004987	2	
R0365_0366	nsp	RM73B--100JT		00D2473003962	2	
R0375-0378	nsp	MNR04=560(1005X4)		126210002590S	4	
R0379	nsp	RM73B--560JT		00D2473005944	1	
R0380	nsp	RM73B--820JT		00D2473005986	1	
R0381	nsp	RM73B--472JT+1005		00D2473010900	1	
R0382	nsp	RM73B--820JT		00D2473005986	1	
R0402	nsp	RM73B--472JT+1005		00D2473010900	1	
R0403	nsp	RM73B--OR0KT+1005		00D2473001906	1	
R0405_0406	nsp	RM73B--330JT+1005		00D2473004987	2	
R0407	nsp	RM73B--472JT+1005		00D2473010900	1	
R0408	nsp	RM73B--330JT+1005		00D2473004987	1	
R0409_0410	nsp	RM73B--472JT+1005		00D2473010900	2	
R0411	nsp	RM73B--470JT+1005		00D2473005928	1	
R0413	nsp	RM73B--330JT+1005		00D2473004987	1	
R0416	nsp	RM73B--330JT+1005		00D2473004987	1	
R0417	nsp	RM73B--470JT+1005		00D2473005928	1	
R0418	nsp	RM73B--472JT+1005		00D2473010900	1	
R0421-0423	nsp	RM73B--472JT+1005		00D2473010900	3	
R0424-0431	nsp	RM73B--330JT+1005		00D2473004987	8	
R0441	nsp	MNR04=472(1005X4)		126210007557S	1	
R0443-0446	nsp	MNR04=330(1005X4)		126210002538S	4	
R0449_0450	nsp	MNR04=330(1005X4)		126210002538S	2	
R0451	nsp	MNR04=472(1005X4)		126210007557S	1	
R0452	nsp	MNR04=103(1005X4)		126210008536S	1	
R0453	nsp	RM73B--472JT+1005		00D2473010900	1	
R0455	nsp	RM73B--472JT+1005		00D2473010900	1	
R0456	nsp	MNR04=472(1005X4)		126210007557S	1	
R0457-0460	nsp	MNR04=100(1005X4)		126210001511S	4	
R0461	nsp	RM73B--330JT+1005		00D2473004987	1	
R0463_0464	nsp	RM73B--330JT+1005		00D2473004987	2	

REF No.	Part No.	Part Name	Remarks	Q'ty	New	Ver
R0465,0466	nsp	RM73B--100JT		00D2473003962	2	
R0475-0478	nsp	MNR04=560(1005X4)		126210002590S	4	
R0479	nsp	RM73B--560JT		00D2473005944	1	
R0481	nsp	RM73B--472JT+1005		00D2473010900	1	
R0482,0483	nsp	RM73B--820JT		00D2473005986	2	
R0602-0604	nsp	RM73B--OR0KT+1005		00D2473001906	3	
R0611	nsp	RM73B--103JT+1005		00D2473010984	1	
R0612	nsp	RM73B--OR0KT+1005		00D2473001906	1	
R0615,0616	nsp	RM73B--OR0KT+1005		00D2473001906	2	
R0623-0626	nsp	RM73B--OR0KT+1005		00D2473001906	4	
R0632	nsp	RM73B--100JT		00D2473003962	1	
R0645	nsp	MNR04=330(1005X4)		126210002538S	1	
R0646	nsp	RM73B--103JT+1005		00D2473010984	1	
R0648	nsp	RM73B--470JT+1005		00D2473005928	1	
R0649,0650	nsp	RM73B--103JT+1005		00D2473010984	2	
R0651-0654	nsp	RM73B--OR0KT+1005		00D2473001906	4	
R0655,0656	nsp	RM73B--103JT+1005		00D2473010984	2	
R0657	nsp	RM73B--OR0KT+1005		00D2473001906	1	
R0658	nsp	MNR04=101(1005X4)		126210003555S	1	
R0659,0660	nsp	RM73B--101JT+1005		00D2473006901	2	
R0663,0664	nsp	RM73B--472JT+1005		00D2473010900	2	
R0665	nsp	RM73B--155KT +1608		00D2472015906	1	
R0666	nsp	RM73B--154DT(1608)		00D2472038925	1	
R0667	nsp	RM73B--304DT(1608)		00D2472038996	1	
R0670	nsp	RM73B--473JT+1005		00D2473012940	1	
R0671	nsp	RM73B--100JT		00D2473003962	1	
R0672	nsp	RM73B--105JT +1608		00D2472014965	1	
R0673	nsp	RM73B--154DT(1608)		00D2472038925	1	
R0674	nsp	RM73B--124DT(1608)		00D2472038909	1	
R0677	nsp	RM73B--473JT+1005		00D2473012940	1	
R0678	nsp	RM73B--100JT		00D2473003962	1	
R0679,0680	nsp	RM73B--154DT(1608)		00D2472038925	2	
R0681	nsp	RM73B--104DT(1608)		00D2472037984	1	
R0684	nsp	RM73B--473JT+1005		00D2473012940	1	
R0685	nsp	RM73B--100JT		00D2473003962	1	
R0686	nsp	RM73B--684JT +1608		00D2472014923	1	
R0687	nsp	RM73B--154DT(1608)		00D2472038925	1	
R0688	nsp	RM73B--473DT(1608)		00D2472037900	1	
R0691	nsp	RM73B--473JT+1005		00D2473012940	1	
R0692	nsp	RM73B--100JT		00D2473003962	1	
R0695	nsp	RM73B--OR0KT+1005		00D2473001906	1	
R0698	nsp	RM73B--OR0KT +1608		00D2472018903	1	
R0703-0705	nsp	RM73B--OR0KT+1005		00D2473001906	3	
R0706-0709	nsp	RM73B--103JT+1005		00D2473010984	4	
R0710	nsp	RM73B--OR0KT+1005		00D2473001906	1	
R0712	nsp	RM73B--OR0KT+1005		00D2473001906	1	
R0715-0722	nsp	RM73B--470JT+1005		00D2473005928	8	
R1000	nsp	RM73B--681JT +1608		00D2472007901	1	
R1001	nsp	RM73B--473JT+1005		00D2473012940	1	
R1002	nsp	RM73B--101JT+1005		00D2473006901	1	
R1004	nsp	RM73B--OR0KT+1005		00D2473001906	1	
R1006	nsp	RM73B--OR0KT+1005		00D2473001906	1	
R1021,1022	nsp	RM73B--103JT+1005		00D2473010984	2	
R1023	nsp	RM73B--330JT+1005		00D2473004987	1	
R1024,1025	nsp	RM73B--103JT+1005		00D2473010984	2	
R1026	nsp	RM73B--332JT		00D2473009966	1	
R1027	nsp	RM73B--472JT+1005		00D2473010900	1	
R1028,1029	nsp	RM73B--101JT+1005		00D2473006901	2	
R1030-1035	nsp	RM73B--330JT+1005		00D2473004987	6	
R1036-1039	nsp	MNR04=330(1005X4)		126210002538S	4	
R1201,1202	nsp	RM73B--330JT+1005		00D2473004987	2	
R1203	nsp	MNR04=472(1005X4)		126210007557S	1	
R1205	nsp	RM73B--101JT+1005		00D2473006901	1	
R1206-1210	nsp	RM73B--330JT+1005		00D2473004987	5	
R1211	nsp	RM73B--101JT+1005		00D2473006901	1	
R1212	nsp	RM73B--OR0KT+1005		00D2473001906	1	
R1214-1221	nsp	RM73B--330JT+1005		00D2473004987	8	
R1223-1225	nsp	RM73B--101JT+1005		00D2473006901	3	
R1227	nsp	RM73B--103JT+1005		00D2473010984	1	
R1228	nsp	RM73B--102JT		00D2473008941	1	
R1229-1231	nsp	RM73B--103JT+1005		00D2473010984	3	
R1234	nsp	RM73B--103JT+1005		00D2473010984	1	
R1236	nsp	RM73B--103JT+1005		00D2473010984	1	
R1237	nsp	MNR04=330(1005X4)		126210002538S	1	
R1238,1239	nsp	MNR04=101(1005X4)		126210003555S	2	
R1243	nsp	RM73B--101JT+1005		00D2473006901	1	
R1246-1254	nsp	MNR04=101(1005X4)		126210003555S	9	
R1255-1257	nsp	RM73B--101JT+1005		00D2473006901	3	
R1259	nsp	RM73B--101JT+1005		00D2473006901	1	
R1261,1262	nsp	RM73B--101JT+1005		00D2473006901	2	
R1263	nsp	MNR04=101(1005X4)		126210003555S	1	
R1265-1268	nsp	RM73B--101JT+1005		00D2473006901	4	
R1271,1272	nsp	RM73B--101JT+1005		00D2473006901	2	
R1273	nsp	RM73B--103JT+1005		00D2473010984	1	
R1274	nsp	RM73B--330JT+1005		00D2473004987	1	
R1275	nsp	RM73B--101JT+1005		00D2473006901	1	
R1276,1277	nsp	RM73B--220JT+1005		00D2473004945	2	
R1901	nsp	RM73B--473JT+1005		00D2473012940	1	
R1904	nsp	RM73B--154DT(1608)		00D2472038925	1	
R1905	nsp	RM73B--473DT(1608)		00D2472037900	1	
R1906	nsp	RM73B--684JT +1608		00D2472014923	1	
R1907	nsp	RM73B--OR0KT+1005		00D2473001906	1	
R1908	nsp	RM73B--330JT+1005		00D2473004987	1	
R1909	nsp	RM73B--472JT+1005		00D2473010900	1	
R1910	nsp	RM73B--OR0KT+1005		00D2473001906	1	
R1911,1912	nsp	RM73B--100JT		00D2473003962	2	
R1913	nsp	RM73B--473JT+1005		00D2473012940	1	
R1916-1918	nsp	RM73B--154DT(1608)		00D2472038925	3	
R1921	nsp	RM73B--103JT+1005		00D2473010984	1	
R1922	nsp	RM73B--332JT		00D2473009966	1	
R1926,1927	nsp	RM73B--105KT +1005		00D2473015963	2	
R1928,1929	nsp	RM73B--470JT+1005		00D2473005928	2	
R1930,1931	nsp	RM73B--152JT +1608		00D2472007985	2	
R1932	nsp	RM73B--100JT		00D2473003962	1	
R1933	nsp	RM73B--473JT+1005		00D2473012940	1	
R1936-1938	nsp	RM73B--154DT(1608)		00D2472038925	3	

REF No.	Part No.	Part Name	Remarks	Q'ty	New	Ver
R2000-2003	nsp	RM73B--471DT(1608)	122350001547S	4		
R2014,2015	nsp	RM73B--103JT +1005	00D2473010984	2		
R2016	nsp	RM73B--472JT+1005	00D2473010900	1		
R2017-2020	nsp	RM73B--151DT(1608)	00D2472032976	4		
R2021	nsp	RM73B--472JT+1005	00D2473010900	1		
R2022-2025	nsp	RM73B--331DT(1608)	122350001530S	4		
R2026,2027	nsp	RM73B--103JT +1005	00D2473010984	2		
R2031	nsp	MNR04=100(1005X4)	126210001511S	1		
R2032,2033	nsp	RM73B--103JT +1005	00D2473010984	2		
R2034	nsp	RM73B--102JT	00D2473008941	1		
R2039,2040	nsp	RM73B--473JT+1005	00D2473012940	2		
R2041,2042	nsp	RM73B--330JT +1005	00D2473004987	2		
R2050,2051	nsp	MNR04=472(1005X4)	126210007557S	2		
R2052	nsp	RM73B--OROKT+1005	00D2473001906	1		
R2053	nsp	MNR04=472(1005X4)	126210007557S	1		
R2054	nsp	MNR04=473(1005X4)	126210009591S	1		
R2057,2058	nsp	MNR04=473(1005X4)	126210009591S	2		
R2059-2061	nsp	MNR04=472(1005X4)	126210007557S	3		
R2062-2064	nsp	RM73B--473JT+1005	00D2473012940	3		
R2065	nsp	RM73B--222JT	00D2473009924	1		
R2069	nsp	RM73B--471DT(1608)	122350001547S	1		
R2071	nsp	RM73B--103JT +1005	00D2473010984	1		
R2075,2076	nsp	RM73B--OROKT+1005	00D2473001906	2		
R2077	nsp	RM73B--103JT +1005	00D2473010984	1		
R2078,2079	nsp	RM73B--472JT+1005	00D2473010900	2		
R2083-2085	nsp	RM73B--472JT+1005	00D2473010900	3		
R2101-2103	nsp	RM73B--330JT +1005	00D2473004987	3		
R2104	nsp	RM73B--103JT +1005	00D2473010984	1		
R2107	nsp	RM73B--103JT +1005	00D2473010984	1		
R2108-2110	nsp	RM73B--330JT +1005	00D2473004987	3		
R2111	nsp	RM73B--473JT+1005	00D2473012940	1		
R2112	nsp	MNR04=330(1005X4)	126210002538S	1		
R2113	nsp	RM73B--103JT +1005	00D2473010984	1		
R2114	nsp	RM73B--330JT +1005	00D2473004987	1		
R2115,2116	nsp	RM73B--100JT	00D2473003962	2		
R2117,2118	nsp	RM73B--473JT+1005	00D2473012940	2		
R2119-2122	nsp	RM73B--330JT +1005	00D2473004987	4		
R2123,2124	nsp	RM73B--100JT	00D2473003962	2		
R2126	nsp	RM73B--473JT+1005	00D2473012940	1		
R2128,2129	nsp	RM73B--473JT+1005	00D2473012940	2		
R2132	nsp	RM73B--472JT+1005	00D2473010900	1		
R2133	nsp	RM73B--105KT +1005	00D2473015963	1		
R2137	nsp	RM73B--473JT+1005	00D2473012940	1		
R2138	nsp	RM73B--105KT +1005	00D2473015963	1		
R2139	nsp	RM73B--224JT	00D2473014906	1		
R2140	nsp	RM73B--104JT	00D2473013923	1		
R2142	nsp	RM73B--330JT +1005	00D2473004987	1		
R2143	nsp	RM73B--103JT +1005	00D2473010984	1		
R2144,2145	nsp	RM73B--472JT+1005	00D2473010900	2		
R2146	nsp	RM73B--330JT +1005	00D2473004987	1		
R2147	nsp	RM73B--472JT+1005	00D2473010900	1		
R2148,2149	nsp	MNR04=330(1005X4)	126210002538S	2		
R2150,2151	nsp	RM73B--103JT +1005	00D2473010984	2		
R2152	nsp	RM73B--473JT+1005	00D2473012940	1		
R2153,2154	nsp	RM73B--103JT +1005	00D2473010984	2		
R2155-2157	nsp	RM73B--473JT+1005	00D2473012940	3		
R2158	nsp	RM73B--223JT	00D2473011967	1		
R2400-2402	nsp	RM73B--102JT	00D2473008941	3		
R2403	nsp	MNR02=000(1005X2)	12625000450AS	1		
R2404-2406	nsp	RM73B--103JT +1005	00D2473010984	3		
R2407	11341002150AS	EXC24CH900U	11341002150AS	1	*	
R2408-2410	nsp	RM73B--473JT+1005	00D2473012940	3		
R2411	nsp	RM73B--OROKT+1005	00D2473001906	1		
R2412-2414	nsp	RM73B--473JT+1005	00D2473012940	3		
R2415	nsp	RM73B--OROKT+1005	00D2473001906	1		
R2416	nsp	RM73B--470JT +1005	00D2473005928	1		
R2417-2419	nsp	RM73B--473JT+1005	00D2473012940	3		
R2420,2421	nsp	RM73B--103JT +1005	00D2473010984	2		
R2423	nsp	MNR02=000(1005X2)	12625000450AS	1		
R2424	nsp	RM73B--OROKT +1608	00D2472018903	1		
R2425,2426	nsp	RM73B--OROKT+1005	00D2473001906	2		
R2427	nsp	RM73B--OROKT +1608	00D2472018903	1		
R2428,2429	nsp	RM73B--OROKT+1005	00D2473001906	2		
R2430	nsp	RM73B--OROKT +1608	00D2472018903	1		
R2431,2432	nsp	RM73B--OROKT+1005	00D2473001906	2		
R2433	nsp	MNR02=000(1005X2)	12625000450AS	1		
R2435	nsp	RM73B--103JT +1005	00D2473010984	1		
R2436-2438	nsp	RM73B--473JT+1005	00D2473012940	3		
R2439	nsp	RM73B--OROKT+1005	00D2473001906	1		
R2440	nsp	RM73B--103JT +1005	00D2473010984	1		
R2446	nsp	RM73B--103JT +1005	00D2473010984	1		
R2447	nsp	RM73B--473JT+1005	00D2473012940	1		
R2448	nsp	RM73B--751JT +1005	00D2473008912	1		
R2449	nsp	RM73B--332JT	00D2473009966	1		
R2450-2452	nsp	RM73B--472JT+1005	00D2473010900	3		
R2453	nsp	RM73B--OROKT+1005	00D2473001906	1		
R2455	nsp	RM73B--105JT +1608	00D2472014965	1		
R2458	nsp	RM73B--103JT +1005	00D2473010984	1		
R2460,2461	nsp	RM73B--470JT +1005	00D2473005928	2		
R2462	nsp	RM73B--102JT	00D2473008941	1		
R2470	nsp	RM73B--103JT +1005	00D2473010984	1		
R2475-2478	nsp	RM73B--182JT	00D2473009908	4		
R2480,2481	nsp	RM73B--511DT(1608)	00D2472034903	2		
R2494	nsp	RM73B--OROKT+1005	00D2473001906	1		
R2602	nsp	RM73B--103JT +1005	00D2473010984	1		
R2604	nsp	RM73B--473JT+1005	00D2473012940	1		
R2605	nsp	RM73B--103JT +1005	00D2473010984	1		
R2606,2607	nsp	RM73B--473JT+1005	00D2473012940	2		
R2608,2609	nsp	RM73B--103JT +1005	00D2473010984	2		
R2610,2611	nsp	RM73B--102JT	00D2473008941	2		
R2612-2614	nsp	RM73B--103JT +1005	00D2473010984	3		
R2615-2618	nsp	RM73B--473JT+1005	00D2473012940	4		
R2619	nsp	RM73B--OROKT +1608	00D2472018903	1		
R2620,2621	nsp	RM73B--OROKT+1005	00D2473001906	2		
R2622	nsp	RM73B--OROKT +1608	00D2472018903	1		
R2623,2624	nsp	RM73B--OROKT+1005	00D2473001906	2		

REF No.	Part No.	Part Name	Remarks	Q'ty	New	Ver
R2625	nsp	RM73B--473JT+1005	00D2473012940	1		
R2626	nsp	RM73B--OROKT+1005	00D2473001906	1		
R2628	nsp	RM73B--105JT +1608	00D2472014965	1		
R2630,2631	nsp	RM73B--470JT +1005	00D2473005928	2		
R2632,2633	nsp	RM73B--102JT	00D2473008941	2		
R2634-2636	nsp	RM73B--103JT +1005	00D2473010984	3		
R2637,2638	nsp	RM73B--182JT	00D2473009908	2		
R2639	nsp	RM73B--473JT+1005	00D2473012940	1		
R2640,2641	nsp	RM73B--182JT	00D2473009908	2		
R2642,2643	nsp	RM73B--511DT(1608)	00D2472034903	2		
R2644	nsp	RM73B--103JT +1005	00D2473010984	1		
R2654	nsp	RM73B--103JT +1005	00D2473010984	1		
R2655,2656	nsp	RM73B--473JT+1005	00D2473012940	2		
R2659	nsp	RM73B--OROKT +1608	00D2472018903	1		
R2662,2663	nsp	RM73B--OROKT+1005	00D2473001906	2		
R2664	nsp	RM73B--473JT+1005	00D2473012940	1		
R2669	nsp	RM73B--103JT +1005	00D2473010984	1		
R2670,2671	nsp	RM73B--473JT+1005	00D2473012940	2		
R2672	nsp	RM73B--OROKT +1608	00D2472018903	1		
R2673	nsp	RM73B--473JT+1005	00D2473012940	1		
R2674,2675	nsp	RM73B--OROKT+1005	00D2473001906	2		
R2689	nsp	RM73B--102JT	00D2473008941	1		
R2804-2810	nsp	MNR04=100(1005X4)	126210001511S	7		
R2811,2812	nsp	RM73B--100JT	00D2473003962	2		
R2821	nsp	MNR04=470(1005X4)	126210002576S	1		
R2822,2823	nsp	RM73B--470JT +1005	00D2473005928	2		
R2824-2828	nsp	MNR04=470(1005X4)	126210002576S	5		
R2829,2830	nsp	RM73B--470JT +1005	00D2473005928	2		
R2831-2839	nsp	MNR04=470(1005X4)	126210002576S	9		
R2840,2841	nsp	RM73B--470JT +1005	00D2473005928	2		
R2843	nsp	RM73B--470JT +1005	00D2473005928	1		
R2847	nsp	RM73B--330JT +1005	00D2473004987	1		
R2848	nsp	RM73B--103JT +1005	00D2473010984	1		
R2849	nsp	RM73B--470JT +1005	00D2473005928	1		
R2850	nsp	RM73B--OROKT+1005	00D2473001906	1		
R2851,2852	nsp	RM73B--102DT(1608)	00D2472034974	2		
R2856	nsp	RM73B--471DT(1608)	122350001547S	1		
R2858	nsp	RM73B--471DT(1608)	122350001547S	1		
R2861	nsp	RM73B--472JT+1005	00D2473010900	1		
R2866	nsp	RM73B--272DT(1608)	00D2472035960	1		
R2867	nsp	RM73B--181DT(1608)	00D2472032992	1		
R2868	nsp	RM73B--272DT(1608)	00D2472035960	1		
R2869	nsp	RM73B--181DT(1608)	00D2472032992	1		
R2870-2872	nsp	RM73B--330JT +1005	00D2473004987	3		
R2875	nsp	RM73B--102JT	00D2473008941	1		
R2877	nsp	RM73B--103JT +1005	00D2473010984	1		
R2879,2880	nsp	RM73B--103JT +1005	00D2473010984	2		
R2883	nsp	RM73B--472JT+1005	00D2473010900	1		
R2884	nsp	RM73B--470JT +1005	00D2473005928	1		
R2888,2889	nsp	RM73B--472JT+1005	00D2473010900	2		
R2898,2899	nsp	MNR04=472(1005X4)	126210007557S	2		
R2900	nsp	RM73B--472JT+1005	00D2473010900	1		
R2914	nsp	RM73B--472JT+1005	00D2473010900	1		
R3014,3015	nsp	RM73B--103JT +1005	00D2473010984	2		
R3016,3017	nsp	RM73B--102DT(1608)	00D2472034974	2		
R3200,3201	nsp	MNR04=100(1005X4)	126210001511S	2		
R3202	nsp	RM73B--220JT+1005	00D2473004945	1		
R3203-3207	nsp	MNR04=100(1005X4)	126210001511S	5		
R3208	nsp	MNR04=220(1005X4)	126210001597S	1		
R3209	nsp	RM73B--220JT+1005	00D2473004945	1		
R3210-3213	nsp	MNR04=100(1005X4)	126210001511S	4		
R3214	nsp	RM73B--470JT +1005	00D2473005928	1		
R3215,3216	nsp	RM73B--220JT+1005	00D2473004945	2		
R3217	nsp	RM73B--OROKT +2125	00D2470018905	1		
R3218	nsp	MNR04=100(1005X4)	126210001511S	1		
R3219	nsp	RM73B--OROKT +1608	00D2472018903	1		
R3220,3221	nsp	RM73B--220JT+1005	00D2473004945	2		
R3224-3228	nsp	RM73B--100JT	00D2473003962	5		
R3408,3409	nsp	RM73B--103JT +1005	00D2473010984	2		
R3411	nsp	RM73B--102JT	00D2473008941	1		
R3412	nsp	RM73B--103JT +1005	00D2473010984	1		
R3413	nsp	RM73B--100JT +1608	00D2472002964	1		
R3414	nsp	RM73B--473JT+1005	00D2473012940	1		
R3415-3417	nsp	RM73B--100JT +1608	00D2472002964	3		
R3418	nsp	RM73B--105JT +1608	00D2472014965	1		
R3419,3420	nsp	RM73B--473JT+1005	00D2473012940	2		
R3421	nsp	RM73B--100JT +1608	00D2472002964	1		
R3422	nsp	RM73B--103JT +1005	00D2473010984	1		
R3423	nsp	RM73B--473JT+1005	00D2473012940	1		
R3424	nsp	RM73B--OROKT+1005	00D2473001906	1		
R3425	nsp	RM73B--470JT +1005	00D2473005928	1		
R3426	nsp	RM73B--100JT +1608	00D2472002964	1		
R3427	nsp	RM73B--470JT +1005	00D2473005928	1		
R3428	nsp	RM73B--473JT+1005	00D2473012940	1		
R3429-3432	nsp	RM73B--470JT +1005	00D2473005928	4		
R3433-3437	nsp	MNR04=470(1005X4)	126210002576S	5		
R3438,3439	nsp	RM73B--103JT +1005	00D2473010984	2		
R3440	nsp	MNR04=470(1005X4)	126210002576S	1		
R3441,3442	nsp	RM73B--100JT +1608	00D2472002964	2		
R3443	nsp	RM73B--820JT	00D2473005986	1		
R3445,3446	nsp	RM73B--511DT(1608)	00D2472034903	2		
R3449	nsp	RM73B--101JT+1005	00D2473006901	1		
R3450	nsp	MNR02=000(1005X2)	12625000450AS	1		
R3451	11341002150AS	EXC24CH900U	11341002150AS	1	*	
R3452	nsp	MNR02=000(1005X2)	12625000450AS	1		
R3453	11341002150AS	EXC24CH900U	11341002150AS	1	*	
R3454	nsp	RM73B--224JT	00D2473014906	1		
R3455-3458	nsp	RM73B--OROKT+1005	00D2473001906	4		
R3459	nsp	RM73B--273JT	00D2473011983	1		
R3460	nsp	MNR04=820(1005X4)	126210003531S	1		
R3461,3462	nsp	RM73B--182JT	00D2473009908	2		
R3463-3466	nsp	MNR02=000(1005X2)	12625000450AS	4		
R3467	nsp	RM73B--122JT +1005	00D2473008967	1		
R3468,3469	nsp	RM73B--182JT	00D2473009908	2		
R3470	nsp	MNR04=101(1005X4)	126210003555S	1		
R3471	nsp	RM73B--103JT +1005	00D2473010984	1		



REF No.	Part No.	Part Name	Remarks	Q'ty	New	Ver
R3472	nsp	RM73B--104JT	00D2473013923	1		
R3473	nsp	RM73B--332JT	00D2473009966	1		
R3474,3475	nsp	RM73B--103JT +1005	00D2473010984	2		
R3476	nsp	MNR04=820(1005X4)	126210003531S	1		
R3477,3478	nsp	RM73B--0R0KT+1005	00D2473001906	2		
R3479	nsp	MNR04=820(1005X4)	126210003531S	1		
R3480	nsp	MNR04=100(1005X4)	126210001511S	1		
R3481	nsp	RM73B--510DT(1608)	00D2472031977	1		
R3482	nsp	MNR04=820(1005X4)	126210003531S	1		
R3483	nsp	RM73B--820JT	00D2473005986	1		
R3484	nsp	RM73B--510DT(1608)	00D2472031977	1		
R3485	nsp	RM73B--103JT +1005	00D2473010984	1		
R3486	nsp	RM73B--101JT+1005	00D2473006901	1		
R3600	nsp	RM73B--473JT+1005	00D2473012940	1		
R3601,3602	nsp	RM73B--103JT +1005	00D2473010984	2		
R3603	nsp	RM73B--473JT+1005	00D2473012940	1		
R3607	nsp	RM73B--473JT+1005	00D2473012940	1		
R3608	nsp	RM73B--103JT +1005	00D2473010984	1		
R3609	nsp	RM73B--0R0KT+1005	00D2473001906	1		
R3618	nsp	RM73B--473JT +1608	00D2472011942	1		
R3619	nsp	RM73B--332JT	00D2473009966	1		
R3620	nsp	RM73B--154DT(1608)	00D2472038925	1		
R3621	nsp	RM73B--473DT(1608)	00D2472037900	1		
R3626	nsp	RM73B--154DT(1608)	00D2472038925	1		
R3627	nsp	RM73B--124DT(1608)	00D2472038909	1		
R3628	nsp	RM73B--684JT +1608	00D2472014923	1		
R3631	nsp	RM73B--105JT +1608	00D2472014965	1		
R3632-3634	nsp	RM73B--473JT+1005	00D2473012940	3		
R3641	nsp	RM73B--154DT(1608)	00D2472038925	1		
R3642	nsp	RM73B--474DT(1608)	00D2472039940	1		
R3643	nsp	RM73B--0R0KT +1608	00D2472018903	1		
R3644	nsp	RM73B--154DT(1608)	00D2472038925	1		
R3645	nsp	RM73B--474DT(1608)	00D2472039940	1		
R3646	nsp	RM73B--0R0KT +1608	00D2472018903	1		
R3647	nsp	RM73B--154DT(1608)	00D2472038925	1		
R3648	nsp	RM73B--474DT(1608)	00D2472039940	1		
R3649	nsp	RM73B--0R0KT +1608	00D2472018903	1		
R3650-3652	nsp	RM73B--434DT(1608)	00D2472039937	3		
R3653-3656	nsp	RM73B--100JT	00D2473003962	4		
R3659	nsp	RM73B--100JT	00D2473003962	1		
R5000	nsp	RM73B--102JT	00D2473008941	1		
R5005	nsp	MNR04=103(1005X4)	126210008536S	1		
R5008	nsp	MNR04=103(1005X4)	126210008536S	1		
R5009	nsp	MNR04=330(1005X4)	126210002538S	1		
R5010,5011	nsp	RM73B--102JT	00D2473008941	2		
R5012	nsp	RM73B--103JT +1005	00D2473010984	1		
R5014	nsp	RM73B--0R0KT +1608	00D2472018903	1		
R5015,5016	nsp	RM73B--330JT +1005	00D2473004987	2		
R5017	nsp	MNR04=330(1005X4)	126210002538S	1		
R5018	nsp	RM73B--472JT+1005	00D2473010900	1		
R5020	nsp	RM73B--472JT+1005	00D2473010900	1		
R5021	nsp	RM73B--103JT +1005	00D2473010984	1		
R5022	nsp	MNR04=472(1005X4)	126210007557S	1		
R5023,5024	nsp	RM73B--330JT +1005	00D2473004987	2		
R5025	nsp	RM73B--472JT+1005	00D2473010900	1		
R5026	nsp	MNR04=330(1005X4)	126210002538S	1		
R5028	nsp	RM73B--330JT +1005	00D2473004987	1		
R5029	nsp	RM73B--103JT +1005	00D2473010984	1		
R5030-5033	nsp	RM73B--330JT +1005	00D2473004987	4		
R5034,5035	nsp	RM73B--472JT+1005	00D2473010900	2		
R5036-5042	nsp	RM73B--330JT +1005	00D2473004987	7		
R5043	nsp	MNR04=330(1005X4)	126210002538S	1		
R5044-5046	nsp	RM73B--330JT +1005	00D2473004987	3		
R5047-5053	nsp	RM73B--105KT +1005	00D2473015963	7		
R5054	nsp	RM73B--472JT+1005	00D2473010900	1		
R5055	nsp	RM73B--103JT +1005	00D2473010984	1		
R5056,5057	nsp	RM73B--101JT+1005	00D2473006901	2		
R5058	nsp	RM73B--332JT	00D2473009966	1		
R5059-5063	nsp	RM73B--101JT+1005	00D2473006901	5		
R5064	nsp	RM73B--103JT +1005	00D2473010984	1		
R5065	nsp	RM73B--104JT	00D2473013923	1		
R5066,5067	nsp	RM73B--103JT +1005	00D2473010984	2		
R5068	nsp	RM73B--472JT+1005	00D2473010900	1		
R5069	nsp	RM73B--473JT+1005	00D2473012940	1		
R5070	nsp	RM73B--104JT	00D2473013923	1		
R5071	nsp	RM73B--101JT+1005	00D2473006901	1		
R5072-5074	nsp	RM73B--472JT+1005	00D2473010900	3		
R5075	nsp	RM73B--0R0KT +1608	00D2472018903	1		
R5076	nsp	RM73B--103JT +1005	00D2473010984	1		
R5077	nsp	RM73B--472JT+1005	00D2473010900	1		
R5080,5081	nsp	RM73B--103JT +1005	00D2473010984	2		
R5082	nsp	RM73B--332JT	00D2473009966	1		
R5083,5084	nsp	RM73B--472JT+1005	00D2473010900	2		
R6000	nsp	MNR04=101(1005X4)	126210003555S	1		
<b>CAPACITORS GROUP</b>						
C0105	nsp	CK73B1H102KT +1005	00D2575006993	1		
C0106	nsp	CK73B1A104KT +1005	00D2575008933	1		
C0107	nsp	CK73B1H102KT +1005	00D2575006993	1		
C0108	nsp	CK73B1A104KT +1005	00D2575008933	1		
C0109	nsp	CK73B1H102KT +1005	00D2575006993	1		
C0110	nsp	CK73B1A104KT +1005	00D2575008933	1		
C0114	nsp	CK73B1H102KT +1005	00D2575006993	1		
C0115	nsp	CK73B1A104KT +1005	00D2575008933	1		
C0117	nsp	CK73B1A104KT +1005	00D2575008933	1		
C0118	nsp	CK73B1H102KT +1005	00D2575006993	1		
C0119	nsp	CK73B1A104KT +1005	00D2575008933	1		
C0120	nsp	CK73B1H102KT +1005	00D2575006993	1		
C0121	nsp	CK73B1A104KT +1005	00D2575008933	1		
C0122	nsp	CK73B1H102KT +1005	00D2575006993	1		
C0124	nsp	CK73B1H102KT +1005	00D2575006993	1		
C0125	nsp	CK73B1A104KT +1005	00D2575008933	1		
C0129	nsp	CK73B1A104KT +1005	00D2575008933	1		
C0130,0131	nsp	CK73B1H102KT +1005	00D2575006993	2		
C0132	nsp	CK73B1A104KT +1005	00D2575008933	1		
C0135	nsp	CK73B1A104KT +1005	00D2575008933	1		
C0136	nsp	CK73B1H102KT +1005	00D2575006993	1		



REF No.	Part No.	Part Name	Remarks	Q'ty	New	Ver
C0413,0414	nsp	CK73B1A104KT +1005		00D2575008933	2	
C0415	nsp	CK73B1H102KT +1005		00D2575006993	1	
C0416	nsp	CK73B1A104KT +1005		00D2575008933	1	
C0417	nsp	CK73B1H102KT +1005		00D2575006993	1	
C0418	nsp	CK73B1A104KT +1005		00D2575008933	1	
C0419,0420	nsp	CK73B1H102KT +1005		00D2575006993	2	
C0421,0422	nsp	CK73B1A104KT +1005		00D2575008933	2	
C0423	nsp	CK73B1H102KT +1005		00D2575006993	1	
C0425	nsp	CK73B1A104KT +1005		00D2575008933	1	
C0426	nsp	CK73B1H102KT +1005		00D2575006993	1	
C0428	nsp	CK73B1A104KT +1005		00D2575008933	1	
C0429,0430	nsp	CK73B1H102KT +1005		00D2575006993	2	
C0431,0432	nsp	CK73B1A104KT +1005		00D2575008933	2	
C0433	nsp	CK73B1H102KT +1005		00D2575006993	1	
C0434	nsp	CK73B1A104KT +1005		00D2575008933	1	
C0435	nsp	CK73B1H102KT +1005		00D2575006993	1	
C0436	nsp	CK73B1A104KT +1005		00D2575008933	1	
C0437-0439	nsp	CK73B1H102KT +1005		00D2575006993	3	
C0440	nsp	CK73B1A104KT +1005		00D2575008933	1	
C0441	nsp	CK73B1H102KT +1005		00D2575006993	1	
C0442	nsp	CK73B1A104KT +1005		00D2575008933	1	
C0443,0444	nsp	CK73B1H102KT +1005		00D2575006993	2	
C0445	nsp	CK73B1A104KT +1005		00D2575008933	1	
C0446	nsp	CK73B1H102KT +1005		00D2575006993	1	
C0447-0450	nsp	CK73B1A104KT +1005		00D2575008933	4	
C0451,0452	nsp	CK73B1H102KT +1005		00D2575006993	2	
C0453,0454	nsp	CK73B1A104KT +1005		00D2575008933	2	
C0455	nsp	CK73B1H102KT +1005		00D2575006993	1	
C0456	nsp	CK73B1A104KT +1005		00D2575008933	1	
C0457,0458	nsp	CK73B1H102KT +1005		00D2575006993	2	
C0609	nsp	CK73B1E103KT(1005)		00D2575008946	1	
C0610	nsp	CK73B1A104KT +1005		00D2575008933	1	
C0612,0613	nsp	CK73B1A104KT +1005		00D2575008933	2	
C0616	nsp	CK73B1H102KT +1005		00D2575006993	1	
C0617,0618	nsp	CK73B1A104KT +1005		00D2575008933	2	
C0619	nsp	CK73B1H102KT +1005		00D2575006993	1	
C0620-0623	nsp	CK73X5R0J106MT(2125)		132450038507S	4	
C0624	nsp	CK73B1A104KT +1005		00D2575008933	1	
C0625,0626	nsp	CK73B1H102KT +1005		00D2575006993	2	
C0627	nsp	CK73B1A104KT +1005		00D2575008933	1	
C0629	nsp	CC73CH1H100DT +1005		00D2575002926	1	
C0630,0631	nsp	CK73X5R0J106MT(2125)		132450038507S	2	
C0632	nsp	CK73B1A104KT +1005		00D2575008933	1	
C0633	nsp	CK73B1E103KT(1005)		00D2575008946	1	
C0634	nsp	CK73X5R0J106MT(2125)		132450038507S	1	
C0637	nsp	CK73B1A104KT +1005		00D2575008933	1	
C0638	nsp	CK73B1H102KT +1005		00D2575006993	1	
C0639	nsp	CK73B1A104KT +1005		00D2575008933	1	
C0641	nsp	CC73CH1H100DT +1005		00D2575002926	1	
C0642,0643	nsp	CK73X5R0J106MT(2125)		132450038507S	2	
C0644	nsp	CK73B1A104KT +1005		00D2575008933	1	
C0645	nsp	CK73B1E103KT(1005)		00D2575008946	1	
C0646	nsp	CK73X5R0J106MT(2125)		132450038507S	1	
C0649	nsp	CK73B1A104KT +1005		00D2575008933	1	
C0650	nsp	CK73B1H102KT +1005		00D2575006993	1	
C0651	nsp	CK73B1A104KT +1005		00D2575008933	1	
C0653	nsp	CC73CH1H100DT +1005		00D2575002926	1	
C0654,0655	nsp	CK73X5R0J106MT(2125)		132450038507S	2	
C0656	nsp	CK73B1A104KT +1005		00D2575008933	1	
C0657	nsp	CK73B1E103KT(1005)		00D2575008946	1	
C0658	nsp	CK73X5R0J106MT(2125)		132450038507S	1	
C0661	nsp	CK73B1A104KT +1005		00D2575008933	1	
C0662	nsp	CK73B1H102KT +1005		00D2575006993	1	
C0663	nsp	CK73B1A104KT +1005		00D2575008933	1	
C0665	nsp	CC73CH1H100DT +1005		00D2575002926	1	
C0666,0667	nsp	CK73X5R0J106MT(2125)		132450038507S	2	
C0668	nsp	CK73B1A104KT +1005		00D2575008933	1	
C0669	nsp	CK73B1E103KT(1005)		00D2575008946	1	
C0670	nsp	CK73X5R0J106MT(2125)		132450038507S	1	
C0673	nsp	CK73B1A104KT +1005		00D2575008933	1	
C0675	nsp	CK73B1E223KT +1608		00D2570516909	1	
C1000	nsp	CK73B1E683KT(1608) +1608		00D2570518907	1	
C1001	nsp	CK73B1H472KT +1608		00D2570510934	1	
C1009,1010	nsp	CK73B1A104KT +1005		00D2575008933	2	
C1011	nsp	CK73X5R0J106MT(2125)		132450038507S	1	
C1012,1013	nsp	CK73B1A104KT +1005		00D2575008933	2	
C1014,1015	nsp	CK73B1E223KT +1608		00D2570516909	2	
C1016	nsp	CK73X5R0J106MT(2125)		132450038507S	1	
C1018	nsp	CK73B1A104KT +1005		00D2575008933	1	
C1022-1024	nsp	CK73B1A104KT +1005		00D2575008933	3	
C1025	nsp	CK73X5R0J106MT(2125)		132450038507S	1	
C1201	nsp	CK73B0J475KT +1608		00D2570522906	1	
C1202	nsp	CK73B1A104KT +1005		00D2575008933	1	
C1203	nsp	CK73B1H102KT +1005		00D2575006993	1	
C1204-1208	nsp	CK73B1A104KT +1005		00D2575008933	5	
C1209	nsp	CK73B0J475KT +1608		00D2570522906	1	
C1210-1212	nsp	CK73B1A104KT +1005		00D2575008933	3	
C1213	nsp	CK73B1H102KT +1005		00D2575006993	1	
C1214-1216	nsp	CK73B1A104KT +1005		00D2575008933	3	
C1217,1218	nsp	CK73B1H102KT +1005		00D2575006993	2	
C1219	nsp	CK73B0J475KT +1608		00D2570522906	1	
C1220	nsp	CK73B1A104KT +1005		00D2575008933	1	
C1221,1222	nsp	CK73B1H102KT +1005		00D2575006993	2	
C1225	nsp	CK73B1H102KT +1005		00D2575006993	1	
C1226	nsp	CK73B1A104KT +1005		00D2575008933	1	
C1227-1229	nsp	CK73B1H102KT +1005		00D2575006993	3	
C1230	nsp	CC73CH1H101JT +1005		00D2575004966	1	
C1231	nsp	CK73B1H102KT +1005		00D2575006993	1	
C1232	nsp	CK73B1A104KT +1005		00D2575008933	1	
C1813	00D2544601934	CE67W0J101MT(P.CAP) +REF		00D2544601934	1	
C1817	nsp	CK73B1A104KT +1005		00D2575008933	1	
C1818	nsp	CK73B0J475KT +1608		00D2570522906	1	
C1819	nsp	CK73B1A104KT +1005		00D2575008933	1	
C1820	nsp	CK73B0J475KT +1608		00D2570522906	1	
C1901	nsp	CK73B1A104KT +1005		00D2575008933	1	
C1904	nsp	CK73X5R0J106MT(2125)		132450038507S	1	

REF No.	Part No.	Part Name	Remarks	Q'ty	New	Ver
C1905	nsp	CK73B1E103KT(1005)		00D2575008946	1	
C1906	nsp	CK73B1A104KT +1005		00D2575008933	1	
C1907,1908	nsp	CK73X5R0J106MT(2125)		132450038507S	2	
C1909	nsp	CC73CH1H100DT +1005		00D2575002926	1	
C1910	nsp	CK73B1A104KT +1005		00D2575008933	1	
C1911	nsp	CK73B1H102KT +1005		00D2575006993	1	
C1912,1913	nsp	CK73B1A104KT +1005		00D2575008933	2	
C1916	nsp	CK73X5R0J106MT(2125)		132450038507S	1	
C1917	nsp	CK73B1E103KT(1005)		00D2575008946	1	
C1918	nsp	CK73B1A104KT +1005		00D2575008933	1	
C1919,1920	nsp	CK73X5R0J106MT(2125)		132450038507S	2	
C1921	nsp	CC73CH1H100DT +1005		00D2575002926	1	
C1922	nsp	CK73B1A104KT +1005		00D2575008933	1	
C1923	nsp	CK73B1H102KT +1005		00D2575006993	1	
C1924	nsp	CK73B0J475KT +1608		00D2570522906	1	
C1927	nsp	CK73B1E104KT +1608		00D2570516954	1	
C1928	nsp	CK73X5R0J106MT(2125)		132450038507S	1	
C1931-1933	nsp	CK73B1H102KT +1608		00D2570509929	3	
C1936	nsp	CK73B1A104KT +1005		00D2575008933	1	
C1937	nsp	CK73B1H102KT +1005		00D2575006993	1	
C1938,1939	nsp	CK73B1H102KT +1608		00D2570509929	2	
C1940	nsp	CK73B1A104KT +1005		00D2575008933	1	
C1943	nsp	CK73X5R0J106MT(2125)		132450038507S	1	
C1944	nsp	CK73B1E103KT(1005)		00D2575008946	1	
C1945	nsp	CK73B1A104KT +1005		00D2575008933	1	
C1946,1947	nsp	CK73X5R0J106MT(2125)		132450038507S	2	
C1948	nsp	CC73CH1H100DT +1005		00D2575002926	1	
C1949	nsp	CK73B1A104KT +1005		00D2575008933	1	
C1950	nsp	CK73B1H102KT +1005		00D2575006993	1	
C1951-1953	nsp	CK73B1H102KT +1608		00D2570509929	3	
C2000-2002	nsp	CK73B1A104KT +1005		00D2575008933	3	
C2003	nsp	CK73B1H102KT +1005		00D2575006993	1	
C2004-2007	nsp	CK73B1A104KT +1005		00D2575008933	4	
C2010	nsp	CK73B1H102KT +1005		00D2575006993	1	
C2012-2022	nsp	CK73B1A104KT +1005		00D2575008933	11	
C2023	nsp	CK73B1H102KT +1005		00D2575006993	1	
C2024-2027	nsp	CK73B1A104KT +1005		00D2575008933	4	
C2028	nsp	CK73B1H102KT +1005		00D2575006993	1	
C2029,2030	nsp	CK73B1A104KT +1005		00D2575008933	2	
C2031,2032	nsp	CK73B1H102KT +1005		00D2575006993	2	
C2033,2034	nsp	CK73B1A104KT +1005		00D2575008933	2	
C2035	nsp	CK73B1H102KT +1005		00D2575006993	1	
C2036	nsp	CK73B1A104KT +1005		00D2575008933	1	
C2037	nsp	CK73B1H102KT +1005		00D2575006993	1	
C2038-2040	nsp	CK73B1A104KT +1005		00D2575008933	3	
C2041,2042	nsp	CK73B1H102KT +1005		00D2575006993	2	
C2043-2045	nsp	CK73B1A104KT +1005		00D2575008933	3	
C2046	nsp	CK73B0J475KT +1608		00D2570522906	1	
C2047	nsp	CK73B1H102KT +1005		00D2575006993	1	
C2048-2050	nsp	CK73B1A104KT +1005		00D2575008933	3	
C2051	nsp	CK73B0J475KT +1608		00D2570522906	1	
C2052	nsp	CK73B1H102KT +1005		00D2575006993	1	
C2053,2054	nsp	CK73B1A104KT +1005		00D2575008933	2	
C2055	nsp	CK73B1H102KT +1005		00D2575006993	1	
C2056	nsp	CK73B1A104KT +1005		00D2575008933	1	
C2057	nsp	CK73B1H102KT +1005		00D2575006993	1	
C2058	nsp	CK73B1A104KT +1005		00D2575008933	1	
C2059,2060	nsp	CK73B1H102KT +1005		00D2575006993	2	
C2061,2062	nsp	CK73B1A104KT +1005		00D2575008933	2	
C2063,2064	nsp	CK73B1H102KT +1005		00D2575006993	2	
C2066	nsp	CK73B1A104KT +1005		00D2575008933	1	
C2067	nsp	CK73B1H102KT +1005		00D2575006993	1	
C2068	nsp	CK73B0J475KT +1608		00D2570522906	1	
C2069,2070	nsp	CK73B1A104KT +1005		00D2575008933	2	
C2071	nsp	CK73B1H102KT +1005		00D2575006993	1	
C2072,2073	nsp	CK73B1A104KT +1005		00D2575008933	2	
C2074	nsp	CK73B1H102KT +1005		00D2575006993	1	
C2075	nsp	CK73B1A104KT +1005		00D2575008933	1	
C2076	nsp	CK73B1H102KT +1005		00D2575006993	1	
C2077	nsp	CK73B0J475KT +1608		00D2570522906	1	
C2078	nsp	CK73B1A104KT +1005		00D2575008933	1	
C2079	nsp	CK73B1H102KT +1005		00D2575006993	1	
C2080	nsp	CK73B1A104KT +1005		00D2575008933	1	
C2081	nsp	CK73B1H102KT +1005		00D2575006993	1	
C2082,2083	nsp	CK73B1A104KT +1005		00D2575008933	2	
C2084	nsp	CK73B1H102KT +1005		00D2575006993	1	
C2085-2091	nsp	CK73B1A104KT +1005		00D2575008933	7	
C2092	nsp	CK73B1H102KT +1005		00D2575006993	1	
C2093,2094	nsp	CK73B1A104KT +1005		00D2575008933	2	
C2095-2105	nsp	CK73B1H102KT +1005		00D2575006993	11	
C2106	nsp	CK73B0J475KT +1608		00D2570522906	1	
C2107	nsp	CK73B1H102KT +1005		00D2575006993	1	
C2108	nsp	CK73B0J475KT +1608		00D2570522906	1	
C2109	nsp	CK73B1H102KT +1005		00D2575006993	1	
C2110	nsp	CK73B1A104KT +1005		00D2575008933	1	
C2111	nsp	CK73B1H102KT +1005		00D2575006993	1	
C2112	nsp	CK73B0J475KT +1608		00D2570522906	1	
C2113-2116	nsp	CK73B1H102KT +1005		00D2575006993	4	
C2117	nsp	CK73B0J475KT +1608		00D2570522906	1	
C2118	nsp	CK73B1H102KT +1005		00D2575006993	1	
C2119	nsp	CK73B0J475KT +1608		00D2570522906	1	
C2120	nsp	CK73B1H102KT +1005		00D2575006993	1	
C2121	nsp	CK73B1A104KT +1005		00D2575008933	1	
C2122	nsp	CK73B1H102KT +1005		00D2575006993	1	
C2123	nsp	CK73B1A104KT +1005		00D2575008933	1	
C2124,2125	nsp	CK73B1H102KT +1005		00D2575006993	2	
C2127	nsp	CK73B1H102KT +1005		00D2575006993	1	
C2128-2131	nsp	CK73B0J475KT +1608		00D2570522906	4	
C2132	nsp	CK73B1E104KT +1608		00D2570516954	1	
C2136	nsp	CC73CH1H8R0DT +1608		00D2570503909	1	
C2137	nsp	CC73CH1H100DT +1608		00D2570503925	1	
C2138	nsp	CK73B1A105KT +1608		00D2570521907	1	
C2139,2140	nsp	CK73B1A104KT +1005		00D2575008933	2	
C2181,2182	nsp	CC73CH1H6R0DT +1608		00D2570502984	2	
C2183	nsp	CK73B1A104KT +1005		00D2575008933	1	
C2184	nsp	CK73B1H102KT +1005		00D2575006993	1	

REF No.	Part No.	Part Name	Remarks	Q'ty	New	Ver
C2185	nsp	CK73B1A104KT +1005		00D2575008933	1	
C2186	nsp	CK73B1H102KT +1005		00D2575006993	1	
C2187	nsp	CK73B1A104KT +1005		00D2575008933	1	
C2188	nsp	CK73B1H102KT +1005		00D2575006993	1	
C2189	nsp	CK73B0J475KT +1608		00D2570522906	1	
C2191,2192	nsp	CK73B1A104KT +1005		00D2575008933	2	
C2193	nsp	CK73B1H221KT +1005		00D2575006919	1	
C2194,2195	nsp	CK73B1A104KT +1005		00D2575008933	2	
C2400-2402	nsp	CK73B1A104KT +1005		00D2575008933	3	
C2403	nsp	CK73B0J475KT +1608		00D2570522906	1	
C2404-2409	nsp	CK73B1A104KT +1005		00D2575008933	6	
C2411	nsp	CK73B1A104KT +1005		00D2575008933	1	
C2412	nsp	CC73CH1H120JT +1608		00D2570503941	1	
C2413	nsp	CC73CH1H100DT +1608		00D2570503925	1	
C2414-2417	nsp	CK73B1A104KT +1005		00D2575008933	4	
C2418	nsp	CK73B1A105KT +1608		00D2570521907	1	
C2419	nsp	CK73B1H102KT +1005		00D2575006993	1	
C2420	nsp	CK73B1A104KT +1005		00D2575008933	1	
C2421-2423	nsp	CK73B1A105KT +1608		00D2570521907	3	
C2424-2438	nsp	CK73B1A104KT +1005		00D2575008933	15	
C2446	nsp	CK73B0J475KT +1608		00D2570522906	1	
C2452	nsp	CK73B0J475KT +1608		00D2570522906	1	
C2454	nsp	CK73B1A104KT +1005		00D2575008933	1	
C2459	nsp	CK73B0J475KT +1608		00D2570522906	1	
C2461	nsp	CK73B1A104KT +1005		00D2575008933	1	
C2465	nsp	CK73B0J475KT +1608		00D2570522906	1	
C2468	nsp	CK73B0J475KT +1608		00D2570522906	1	
C2471-2480	nsp	CK73B0J475KT +1608		00D2570522906	10	
C2481-2491	nsp	CK73B1A104KT +1005		00D2575008933	11	
C2600,2601	nsp	CK73B1A104KT +1005		00D2575008933	2	
C2604-2612	nsp	CK73B1A104KT +1005		00D2575008933	9	
C2613	nsp	CC73CH1H120JT +1608		00D2570503941	1	
C2614	nsp	CC73CH1H100DT +1608		00D2570503925	1	
C2615-2621	nsp	CK73B1A104KT +1005		00D2575008933	7	
C2622	nsp	CK73B1H102KT +1005		00D2575006993	1	
C2623-2643	nsp	CK73B1A104KT +1005		00D2575008933	21	
C2651	nsp	CK73B0J475KT +1608		00D2570522906	1	
C2652	nsp	CK73B1A104KT +1005		00D2575008933	1	
C2657	nsp	CK73B0J475KT +1608		00D2570522906	1	
C2658	nsp	CK73B1A104KT +1005		00D2575008933	1	
C2664	nsp	CK73B0J475KT +1608		00D2570522906	1	
C2665	nsp	CK73B1A105KT +1608		00D2570521907	1	
C2670	nsp	CK73B0J475KT +1608		00D2570522906	1	
C2673	nsp	CK73B0J475KT +1608		00D2570522906	1	
C2676-2684	nsp	CK73B0J475KT +1608		00D2570522906	9	
C2685	nsp	CK73B1A104KT +1005		00D2575008933	1	
C2686,2687	nsp	CK73B0J475KT +1608		00D2570522906	2	
C2688,2689	nsp	CK73B1A105KT +1608		00D2570521907	2	
C2690	nsp	CK73B1A104KT +1005		00D2575008933	1	
C2691	nsp	CK73B1A105KT +1608		00D2570521907	1	
C2805,2806	nsp	CK73B1A104KT +1005		00D2575008933	2	
C2807	nsp	CK73B0J475KT +1608		00D2570522906	1	
C2808-2811	nsp	CK73B1A104KT +1005		00D2575008933	4	
C2812	nsp	CK73B0J475KT +1608		00D2570522906	1	
C2813-2824	nsp	CK73B1A104KT +1005		00D2575008933	12	
C2825-2832	nsp	CK73B1E103KT(1005)		00D2575008946	8	
C2833	nsp	CK73B0J475KT +1608		00D2570522906	1	
C2834	nsp	CK73B1A104KT +1005		00D2575008933	1	
C2835	nsp	CK73B1E103KT(1005)		00D2575008946	1	
C2838	nsp	CK73B0J475KT +1608		00D2570522906	1	
C2842,2843	nsp	CK73B1A104KT +1005		00D2575008933	2	
C2845	nsp	CK73B1E103KT(1005)		00D2575008946	1	
C2847	nsp	CK73B1A104KT +1005		00D2575008933	1	
C2849,2850	nsp	CK73B1E103KT(1005)		00D2575008946	2	
C2851-2853	nsp	CK73B0J475KT +1608		00D2570522906	3	
C2854	nsp	CK73B1A104KT +1005		00D2575008933	1	
C2855	nsp	CK73B0J475KT +1608		00D2570522906	1	
C2856	nsp	CK73B1E103KT(1005)		00D2575008946	1	
C2857-2859	nsp	CK73B1A104KT +1005		00D2575008933	3	
C2860,2861	nsp	CK73B1E103KT(1005)		00D2575008946	2	
C2863	nsp	CK73B0J475KT +1608		00D2570522906	1	
C2864	nsp	CK73B1A104KT +1005		00D2575008933	1	
C2865	nsp	CK73B1E103KT(1005)		00D2575008946	1	
C2866	nsp	CK73B1A104KT +1005		00D2575008933	1	
C2869,2870	nsp	CK73B0J475KT +1608		00D2570522906	2	
C2871-2873	nsp	CK73B1A104KT +1005		00D2575008933	3	
C2874,2875	nsp	CK73B1E103KT(1005)		00D2575008946	2	
C2876	nsp	CK73B1H102KT +1005		00D2575006993	1	
C2877,2878	nsp	CK73B1A104KT +1005		00D2575008933	2	
C2879,2880	nsp	CK73B1E103KT(1005)		00D2575008946	2	
C2881	nsp	CK73B1H102KT +1005		00D2575006993	1	
C2883	nsp	CC73CH1H330JT +1005		00D2575003941	1	
C2891	nsp	CK73B0J475KT +1608		00D2570522906	1	
C2892	nsp	CK73B1A104KT +1005		00D2575008933	1	
C2893	nsp	CK73B0J475KT +1608		00D2570522906	1	
C2894,2895	nsp	CK73B1A104KT +1005		00D2575008933	2	
C2896	nsp	CK73B1E103KT(1005)		00D2575008946	1	
C2897	nsp	CK73B1A154KT +1608		00D2570520908	1	
C2898	nsp	CK73B1H123KT +1608		00D2570501914	1	
C2899	nsp	CK73B1A154KT +1608		00D2570520908	1	
C2900	nsp	CK73B1H123KT +1608		00D2570501914	1	
C2901	nsp	CK73B1A104KT +1005		00D2575008933	1	
C2902	nsp	CK73B1E103KT(1005)		00D2575008946	1	
C2904	nsp	CK73B1A104KT +1005		00D2575008933	1	
C2905	nsp	CK73B1E103KT(1005)		00D2575008946	1	
C2906	nsp	CK73B1A104KT +1005		00D2575008933	1	
C2907	nsp	CK73B1E103KT(1005)		00D2575008946	1	
C2909	nsp	CK73B1E103KT(1005)		00D2575008946	1	
C2911	nsp	CK73B0J475KT +1608		00D2570522906	1	
C2912	nsp	CK73B1E103KT(1005)		00D2575008946	1	
C2914	nsp	CK73B1A104KT +1005		00D2575008933	1	
C2916	nsp	CC73CH1H8RODT +1608		00D2570503909	1	
C2917	nsp	CC73CH1H100DT +1608		00D2570503925	1	
C2918,2919	nsp	CK73B1E103KT(1005)		00D2575008946	2	
C3000	nsp	CK73X5R0J106MT(2125)		132450038507S	1	
C3001-3016	nsp	CK73B1A104KT +1005		00D2575008933	16	

REF No.	Part No.	Part Name	Remarks	Q'ty	New	Ver
C3017-3024	nsp	CK73B1H102KT +1005		00D2575006993	8	
C3025	nsp	CK73X5R0J106MT(2125)		132450038507S	1	
C3026-3041	nsp	CK73B1A104KT +1005		00D2575008933	16	
C3042-3049	nsp	CK73B1H102KT +1005		00D2575006993	8	
C3050	nsp	CK73B1A104KT +1005		00D2575008933	1	
C3052	nsp	CK73B1A105KT +1608		00D2570521907	1	
C3200	nsp	CK73B0J475KT +1608		00D2570522906	1	
C3201	nsp	CK73B1A104KT +1005		00D2575008933	1	
C3202	nsp	CK73B1H102KT +1005		00D2575006993	1	
C3203-3207	nsp	CK73B1A104KT +1005		00D2575008933	5	
C3209	nsp	CK73B1A104KT +1005		00D2575008933	1	
C3211	nsp	CK73B1A104KT +1005		00D2575008933	1	
C3213-3215	nsp	CK73B1A104KT +1005		00D2575008933	3	
C3216-3221	nsp	CK73B1H102KT +1005		00D2575006993	6	
C3400-3403	nsp	CK73B0J475KT +1608		00D2570522906	4	
C3404,3405	nsp	CK73B1H102KT +1005		00D2575006993	2	
C3406	nsp	CK73B0J475KT +1608		00D2570522906	1	
C3410	nsp	CK73B0J475KT +1608		00D2570522906	1	
C3413	nsp	CK73B0J475KT +1608		00D2570522906	1	
C3416	nsp	CK73B0J475KT +1608		00D2570522906	1	
C3419-3421	nsp	CK73B0J475KT +1608		00D2570522906	3	
C3434	nsp	CC73CH1H120JT +1608		00D2570503941	1	
C3435	nsp	CC73CH1H100DT +1608		00D2570503925	1	
C3436-3447	nsp	CK73B1A104KT +1005		00D2575008933	12	
C3448,3449	nsp	CK73B1H102KT +1005		00D2575006993	2	
C3450	nsp	CK73B1A104KT +1005		00D2575008933	1	
C3451,3452	nsp	CK73B1H102KT +1005		00D2575006993	2	
C3453-3470	nsp	CK73B1A104KT +1005		00D2575008933	18	
C3471	nsp	CK73B1A105KT +1608		00D2570521907	1	
C3472,3473	nsp	CK73B1A104KT +1005		00D2575008933	2	
C3476	nsp	CK73B1A105KT +1608		00D2570521907	1	
C3477	nsp	CK73B1A104KT +1005		00D2575008933	1	
C3478	nsp	CK73B1A105KT +1608		00D2570521907	1	
C3479	nsp	CK73B1A104KT +1005		00D2575008933	1	
C3480	nsp	CK73B1A105KT +1608		00D2570521907	1	
C3481-3483	nsp	CK73B1A104KT +1005		00D2575008933	3	
C3484-3486	nsp	CK73B1H102KT +1005		00D2575006993	3	
C3488	nsp	CK73B1A104KT +1005		00D2575008933	1	
C3489	nsp	CK73B1A105KT +1608		00D2570521907	1	
C3492	nsp	CK73B1A105KT +1608		00D2570521907	1	
C3494	nsp	CK73B1A105KT +1608		00D2570521907	1	
C3497-3499	nsp	CK73B0J475KT +1608		00D2570522906	3	
C3505	nsp	CK73B1A104KT +1005		00D2575008933	1	
C3600-3603	nsp	CK73B1A104KT +1005		00D2575008933	4	
C3605,3606	nsp	CK73B1A105KT +1608		00D2570521907	2	
C3612	nsp	CK73X5R0J106MT(2125)		132450038507S	1	
C3613	nsp	CK73B1A104KT +1005		00D2575008933	1	
C3614	nsp	CK73B1H102KT +1005		00D2575006993	1	
C3615	nsp	CK73X5R0J106MT(2125)		132450038507S	1	
C3616	nsp	CK73B1E103KT(1005)		00D2575008946	1	
C3619	nsp	CK73B1E103KT(1005)		00D2575008946	1	
C3620	nsp	CK73B1A104KT +1005		00D2575008933	1	
C3623	nsp	CK73B1A104KT +1005		00D2575008933	1	
C3624	nsp	CK73X5R0J106MT(2125)		132450038507S	1	
C3627	nsp	CK73X5R0J106MT(2125)		132450038507S	1	
C3629	nsp	CK73X5R0J106MT(2125)		132450038507S	1	
C3631	nsp	CK73B1A104KT +1005		00D2575008933	1	
C3633	nsp	CK73X5R0J106MT(2125)		132450038507S	1	
C3634	nsp	CC73CH1H100DT +1005		00D2575002926	1	
C3637	nsp	CC73CH1H100DT +1005		00D2575002926	1	
C3642	nsp	CK73B1A104KT +1005		00D2575008933	1	
C3645	nsp	CK73B1A104KT +1005		00D2575008933	1	
C3646	nsp	CK73B1H102KT +1005		00D2575006993	1	
C3649	nsp	CK73B1H102KT +1005		00D2575006993	1	
C3650-3652	nsp	CK73B1A104KT +1005		00D2575008933	3	
C3659-3661	nsp	CK73X5R0J106MT(2125)		132450038507S	3	
C3662-3664	nsp	CK73B1E103KT(1005)		00D2575008946	3	
C3665-3667	nsp	CK73B1A104KT +1005		00D2575008933	3	
C3668-3673	nsp	CK73X5R0J106MT(2125)		132450038507S	6	
C3674-3676	nsp	CC73CH1H100DT +1005		00D2575002926	3	
C3679-3681	nsp	CK73B1A104KT +1005		00D2575008933	3	
C3682-3684	nsp	CK73B1H102KT +1005		00D2575006993	3	
C3700,3701	nsp	CK73B0J475KT +1608		00D2570522906	2	
C5001	nsp	CK73B1H102KT +1005		00D2575006993	1	
C5002,5003	nsp	CK73B1A104KT +1005		00D2575008933	2	
C5004	nsp	CK73B1H102KT +1005		00D2575006993	1	
C5005	nsp	CK73B0J475KT +1608		00D2570522906	1	
C5006-5008	nsp	CK73B1H102KT +1005		00D2575006993	3	
C5009,5010	nsp	CK73B1A104KT +1005		00D2575008933	2	
C5011,5012	nsp	CC73CH1H8RODT +1608		00D2570503909	2	
C5013-5024	nsp	CK73B1A104KT +1005		00D2575008933	12	
C5025	nsp	CK73B1H153KT +1608		00D2570501927	1	
C5026-5028	nsp	CK73B1A104KT +1005		00D2575008933	3	
C5029	nsp	CK73B1A105KT +1608		00D2570521907	1	
C5030	nsp	CK73B1H102KT +1005		00D2575006993	1	
C5031	nsp	CK73B0J475KT +1608		00D2570522906	1	
C5032	nsp	CK73B1A104KT +1005		00D2575008933	1	
C5034	nsp	CK73B1A104KT +1005		00D2575008933	1	
C5036	nsp	CK73B1E104KT +1608		00D2570516954	1	
C5037	nsp	CK73X5R0J106MT(2125)		132450038507S	1	
C9507,9508	00D2544601934	CE67W0J101MT(P.CAP) +REF		00D2544601934	2	
C9510-9513	00D2544601934	CE67W0J101MT(P.CAP) +REF		00D2544601934	4	
<b>OTHER PARTS GROUP</b>						
B0602	nsp	M3 SCREW TERMINAL H=7		44431050800AD	1	*
B1801	nsp	M3 SCREW TERMINAL		00D2051034007	1	
L0101-0104	13235007050AS	EMIFIL(NFM18PS105ROJ3D)		13235007050AS	4	*
L0106	13235007050AS	EMIFIL(NFM18PS105ROJ3D)		13235007050AS	1	*
L0201-0204	13235007050AS	EMIFIL(NFM18PS105ROJ3D)		13235007050AS	4	*
L0206	13235007050AS	EMIFIL(NFM18PS105ROJ3D)		13235007050AS	1	*
L0301-0304	13235007050AS	EMIFIL(NFM18PS105ROJ3D)		13235007050AS	4	*
L0306	13235007050AS	EMIFIL(NFM18PS105ROJ3D)		13235007050AS	1	*
L0401-0404	13235007050AS	EMIFIL(NFM18PS105ROJ3D)		13235007050AS	4	*
L0406	13235007050AS	EMIFIL(NFM18PS105ROJ3D)		13235007050AS	1	*
L0601,0602	113410001506S	DLW21SN900HQ2L		113410001506S	2	
L0603	nsp	E.FIL(BLM21PG221SN1)+2125		00D2350147909	1	
L0605	nsp	E.FIL(BLM21PG221SN1)+2125		00D2350147909	1	

REF No.	Part No.	Part Name	Remarks	Q'ty	New	Ver
L0607	nsp	E.FIL(BLM21PG221SN1)+2125		00D2350147909	1	
L0609	nsp	E.FIL(BLM21PG221SN1)+2125		00D2350147909	1	
L0611	nsp	E.FIL(BLM21PG221SN1)+2125		00D2350147909	1	
L0613	nsp	E.FIL(BLM21PG221SN1)+2125		00D2350147909	1	
L0615	nsp	E.FIL(BLM21PG221SN1)+2125		00D2350147909	1	
L0617	nsp	E.FIL(BLM21PG221SN1)+2125		00D2350147909	1	
L1201	nsp	CHIP EMIFIL(11A121) +1608		00D2350130903	1	
L1801-1805	nsp	E.FIL(BLM21PG221SN1)+2125		00D2350147909	5	
L1901	nsp	E.FIL(BLM21PG221SN1)+2125		00D2350147909	1	
L1903-1905	nsp	E.FIL(BLM21PG221SN1)+2125		00D2350147909	3	
L1907-1909	nsp	E.FIL(BLM21PG221SN1)+2125		00D2350147909	3	
L1911,1912	nsp	E.FIL(BLM21PG221SN1)+2125		00D2350147909	2	
L2000-2012	nsp	E.FIL(BLM21PG221SN1)+2125		00D2350147909	13	
L2400-2407	nsp	E.FIL(BLM21PG221SN1)+2125		00D2350147909	8	
L2600-2607	nsp	E.FIL(BLM21PG221SN1)+2125		00D2350147909	8	
L2801-2808	nsp	E.FIL(BLM21PG221SN1)+2125		00D2350147909	8	
L2810	nsp	E.FIL(BLM21PG221SN1)+2125		00D2350147909	1	
L2812,2813	nsp	E.FIL(BLM21PG221SN1)+2125		00D2350147909	2	
L2815-2817	nsp	E.FIL(BLM21PG221SN1)+2125		00D2350147909	3	
L3000	nsp	E.FIL(BLM21PG221SN1)+2125		00D2350147909	1	
L3400-3406	nsp	E.FIL(BLM21PG221SN1)+2125		00D2350147909	7	
L3408	nsp	E.FIL(BLM21PG221SN1)+2125		00D2350147909	1	
L3600	nsp	E.FIL(BLM21PG221SN1)+2125		00D2350147909	1	
L3602	nsp	E.FIL(BLM21PG221SN1)+2125		00D2350147909	1	
L3606	nsp	E.FIL(BLM21PG221SN1)+2125		00D2350147909	1	
L3608	nsp	E.FIL(BLM21PG221SN1)+2125		00D2350147909	1	
L3614	nsp	E.FIL(BLM21PG221SN1)+2125		00D2350147909	1	
L3616	nsp	E.FIL(BLM21PG221SN1)+2125		00D2350147909	1	
L3618	nsp	E.FIL(BLM21PG221SN1)+2125		00D2350147909	1	
L3620	nsp	E.FIL(BLM21PG221SN1)+2125		00D2350147909	1	
L3622	nsp	E.FIL(BLM21PG221SN1)+2125		00D2350147909	1	
L3624	nsp	E.FIL(BLM21PG221SN1)+2125		00D2350147909	1	
L3626	nsp	E.FIL(BLM21PG221SN1)+2125		00D2350147909	1	
L5001	nsp	E.FIL(BLM21PG221SN1)+2125		00D2350147909	1	
N0601	64301022520AS	RJ45-CONN (RJ051-FD08M3B1A15)		64301022520AS	1	
N0602	nsp	B5B-PH-K-S (LF)(SN)		00MYJ06006250	1	
N0603	nsp	B5B-PH-K-S (LF)(SN)		00MYJ06006250	1	
N0606	nsp	7P FFC BASE(9610SC)		00D2051343950	1	
N0607,0608	nsp	64P(S1210-64SXX-S01-XX)		64501020150AS	2	*
N0609	nsp	7P FFC BASE(9610SC)		00D2051343950	1	
N1001	nsp	33P SOCKET(C125Z2)		645010057093S	1	
N1804	nsp	33P SOCKET(C125Z2)		645010057093S	1	
N1805	nsp	21P SOCKET(C125Z2)		645010057055S	1	
N1807	nsp	19P FFC BASE(9610SC)		00D2051313951	1	
N1808	nsp	BASE POST 6P S6B-EH NICHATSU		00MYP06011860	1	
N2400-2402	64401030161AS	A0D7ABAR1990		64401030161AS	3	*
N2600,2601	64401030161AS	A0D7ABAR1990		64401030161AS	2	*
N2603	64401030161AS	A0D7ABAR1990		64401030161AS	1	*
N2700	64401030161AS	A0D7ABAR1990		64401030161AS	1	*
N2800	nsp	7P FFC BASE(9610SC)		00D2051343950	1	
N3401,3402	64401030161AS	A0D7ABAR1990		64401030161AS	2	*
N3403	nsp	25P FFC.BASE(9610SCA +REF		00D2051313906	1	
N5003	nsp	17P SOCKET(C125Z2)		645010057031S	1	
N5004	nsp	19P SOCKET(C125Z2)		645010057048S	1	
N5007	nsp	40FMN-BMTTR-A-TBT(LF)(SN)		645010076506S	1	
N5010	64401030161AS	A0D7ABAR1990		64401030161AS	1	*
S0601	00D2121204903	SLIDE SW(SSSS820201)		00D2121204903	1	
X2000	14181006950AS	TXC 7V(27MHZ)		14181006950AS	1	
X2101	14181006550AS	TXC 7V(12MHZ)		14181006550AS	1	
X2400	14181006950AS	TXC 7V(27MHZ)		14181006950AS	1	
X2601	14181006950AS	TXC 7V(27MHZ)		14181006950AS	1	
X2800	14181006950AS	TXC 7V(27MHZ)		14181006950AS	1	
X3400	14181006950AS	TXC 7V(27MHZ)		14181006950AS	1	
X5001	14181006550AS	TXC 7V(12MHZ)		14181006550AS	1	
Z0001	nsp	STYLE PIN		00D2050452017	1	

## EXPLODED

※Parts indicated by "nsp"on this table cannot be supplied

※The ꝑ NOTE:The symbols in the column Remarks indicate the following destinations.

E3 : U.S.A. & Canada model E2 : Europe model E1C : China model E1 : Asia model JP : Japan model  
BK : Black model SP : Premium Silver model

REF No	Part No.	Part Name	Remarks	Q'ty	New	Ver
A	9U-310150	DIGITAL PCB	E3(CX870 model)	8U-310150	1	*
A	9U-310150A	DIGITAL PCB	E2(CX870 model)	8U-310150	1	*
A	9U-310150B	DIGITAL PCB	E1C	8U-310150	1	*
B	9U-210163	AUDIO/VIDEO PCB	E3	8U-210163-1	1	*
B	9U-210163A	AUDIO/VIDEO PCB	E2	8U-210163-1	1	*
B	9U-210163B	AUDIO/VIDEO PCB	E1C	8U-210163-1	1	*
B-1	-	DAC PCB		8U-210163-2	1	*
B-2	-	HDMI USB FRONT PCB		8U-210163-5	1	*
B-4	-	CONNECTOR-1 PCB		8U-210163-3	1	*
B-5	-	CONNECTOR-2 PCB		8U-210163-4	1	*
B-6	-	CONNECTOR-3 PCB		8U-210163-6	1	*
B-8	-	CONNECTOR-5 PCB		8U-210163-9	1	*
C	nsp	SPEAKER PCB		8U-110156-1	1	*
C-1	-	FLD PCB		8U-110156-4	1	*
C-2	-	HP PCB		8U-110156-5	1	*
C-3	-	HL SPEAKER PCB		8U-110156-6	1	*
D	nsp	AMP PCB		8U-110157-1	9	*
D-1	-	R-AMP CONNECT PCB		8U-110157-4	1	*
D-2	-	L-AMP CONNECT PCB		8U-110157-5	1	*
D-3	-	SMPS PCB		8U-110157-6	1	*
D-4	-	232C POHNO PCB		8U-110157-7	1	*
D-5	-	RADI_PROTDET2 PCB		8U-110157-8	1	*
D-6	-	RADI_PROTDET1 PCB		8U-110157-9	1	*
E	9U-310201	CX870 CONNECT PCB	CX870 model only	8U-310201-1	1	*
E-1	-	Bluetooth PCB	CX870 model only	8U-310201-2	1	*
1	nsp	MAIN CHASSIS		44131008110AD	1	*
2	nsp	TRANS RADIATOR BASE		44431033010AD	1	*
3	40751003500AD	FOOT		40751003500AD	4	*
4	nsp	RUBBER PAD		00D4610385001	4	*
5	nsp	BRACKET POWER		444310195007D	1	*
! 6	68501001400AS	FAN(AS8025L12)		68501001400AS	2	*
7	nsp	FAN BRACKET		44431033410AD	4	*
! 8	10101023100AS	POWER TRANS(X5200E3)	E3	10101023100AS	1	*
! 8	10101023101AS	POWER TRANS(X5200E2)	E2	10101023101AS	1	*
! 8	10101023102AS	POWER TRANS(X5200E1C)	E1C	10101023102AS	1	*
9	nsp	TRANS LABEL		54411039100AD	1	*
10	nsp	RUBBER SHEET		00D4610866009	4	*
11	40231043500AD	FRONT PANEL	E3	40231043500AD	1	*
11	40231043501AD	FRONT PANEL	BKE2	40231043501AD	1	*
11	40231043502AD	FRONT PANEL	SP	40231043502AD	1	*
12	42141003400AD	DENON BADGE	E3	42141003400AD	1	*
12	42141002300AD	DENON BADGE	BKE2	42141002300AD	1	*
12	42141002301AD	DENON BADGE	SP	42141002301AD	1	*
13	42131003300AD	IN-COMMAND BADGE	E3	42131003300AD	1	*
14	44351008110AD	INNER PANEL	BK	44351008110AD	1	*
14	44351008111AD	INNER PANEL	SP	44351008111AD	1	*
15	41151030400AD	POWER KNOB	BK	41151030400AD	1	*
15	41151030401AD	POWER KNOB	SP	41151030401AD	1	*
16	41151030502AD	ENTER BUTTON	E3	41151030502AD	1	*
16	41151030500AD	ENTER BUTTON	BKE2	41151030500AD	1	*
16	41151030501AD	ENTER BUTTON	SP	41151030501AD	1	*
17	42351003500AD	POWER LENS		42351003500AD	1	*
18	41651012800AD	WINDOW		41651012800AD	1	*
19	42251005822AD	DOOR SHEET	E3	42251005822AD	1	*
19	42251005820AD	DOOR SHEET	BKE2	42251005820AD	1	*
19	42251005821AD	DOOR SHEET	SP	42251005821AD	1	*
20	43601004800AD	DOOR CUSHION		43601004800AD	2	*
21	41531004300AD	DOOR	BK	41531004300AD	1	*
21	41531004301AD	DOOR	SP	41531004301AD	1	*
22	41751002300AD	DOOR INNER	BK	41751002300AD	1	*
22	41751002301AD	DOOR INNER	SP	41751002301AD	1	*
23	nsp	MAGNET DOOR SR7005 A332		457010003008M	1	*
24	nsp	EARTH PLATE DOOR		44631007700AD	1	*
25	nsp	GEAR DAMPER(058-E)		47401005100AS	1	*
26	nsp	VOLUME PLATE		44431034000AD	1	*
27	nsp	FRONT BRACKET		44431050100AD	1	*
28	nsp	FFC GUARD		45151015510AD	1	*
29	nsp	PUSH RIVET		00D4790003038	2	*
30	45151015300AD	KNOB (M) SPACER		45151015300AD	1	*
31	45151015410AD	KNOB (F) SPACER		45151015410AD	1	*
32	41201011810AD	KNOB (M) ASSY	BK	41201011810AD	1	*
32	41201011811AD	KNOB (M) ASSY	SP	41201011811AD	1	*
33	41201011910AD	KNOB (F) ASSY	BK	41201011910AD	1	*
33	41201011911AD	KNOB (F) ASSY	SP	41201011911AD	1	*
34	nsp	DOOR HOLDER A		45451005000AD	1	*
36	nsp	DOOR CAP		41331004300AD	1	*
★37	nsp	POP LABEL	E3	54411038900AD	1	*
★37	nsp	POP LABEL	E2	54411042700AD	1	*
★37	nsp	POP LABEL	E1C	54411042800AD	1	*
★38	nsp	SPOTIFY LABEL	E3,E2	54411222000AD	1	*
★39	nsp	SP RIVET	E2,E1C	45551010000AD	22	*
40	nsp	GASKET NLCG-050100		44801002607AS	40	*
★41	nsp	ALUMINUM TAPE		00D4141010007	200	*
42	nsp	RUBBER FOAM		47101020200AD	1	*
43	nsp	RUBBER FOAM		47101020201AD	1	*
★44	nsp	FERRITE CORE GRFC-4		11701001502AS	1	*
45	nsp	RADIATOR		44731007001AD	1	*
46	nsp	RADIATOR (B)		44741007500AD	1	*
47	nsp	RADIATOR BRACKET (L)		44431032800AD	1	*
48	nsp	RADIATOR BRACKET (R)		44431032900AD	1	*
49	nsp	BACK PANEL	E3	40631014010AD	1	*
49	nsp	BACK PANEL	E2	40631014011AD	1	*



REF No	Part No.	Part Name	Remarks		Q'ty	New	Ver
49	nsp	BACK PANEL	E1C	40631014012AD	1	*	
50	18301004000AS	HD RADIO MODULE(UMH-AVR)	E3	18301004000AS	1	*	
51	nsp	CARD SPACER(L=10)		00D4122814028	6		
52	nsp	PWB BRACKET (FRONT/CNT)		44431033100AD	1	*	
53	nsp	CARD SPACER (L=6)		00D4122814044	1		
54	nsp	SMPS HOLDER		44431033300AD	1	*	
55	nsp	SMPS COVER		44431033200AD	1	*	
56	nsp	Terminal PHONO		48801000200AM	1		
★57	nsp	WIRE CLAMPER		00D4458004007	9		
★58	nsp	SPEAKER LABEL		54411039000AD	1	*	
59	-	CX870 MODULE		18901010100AS	1	*	
L-59	9R1891003300D	CX870 MODULE ASSY(5200E3)	E3(CX870 model)	-	1	*	
L-59	9R1891003301D	CX870 MODULE ASSY(5200E2)	E2(CX870 model)	-	1	*	
L-59	9R1891003302D	CX870 MODULE ASSY(5200E1C)	E1C(CX870 model)	-	1	*	2
60	nsp	GASKET NLCG-050050		44801002606AS	90		
★61	nsp	EARTH PLATE A		44431051000AD	1	*	
★62	nsp	EARTH PLATE B		44431051100AD	1	*	
63	40331009510AD	TOP COVER	BK	40331009510AD	1	*	
63	40331009511AD	TOP COVER	SP	40331009511AD	1	*	
64	nsp	RUBBER FOAM		00D4611012043	1		
★65	nsp	CORD HOLDER (L50)		0RD4450048016	1		
66	20305004200AS	KCQ60A06		20305004200AS	1		
67	nsp	HEAT SINK(SMPS)		44731010100AD	1	*	
★81	60605030100AS	FFC 25P(AC+AL)300mm 1.0mm		60605030100AS	1	*	
★82	60605016105AS	FFC 40P 225mm 1.0mm		60605016105AS	1	*	
★83	nsp	5P 400mm PH-PH(USB)		61205049401AS	1	*	
★84	60605016107AS	FFC 19P 150mm 1.0mm		60605016107AS	1	*	
★85	60605016200AS	FFC 13P 80mm 1.25mm	E3	60605016200AS	1		
★86	60605016201AS	FFC 33P 130mm 1.25mm		60605016201AS	1		
★87	nsp	11P 130mm PH-PH		61205063000AS	1	*	
★88	nsp	12P 350mm PH-PH		61205048801AS	1	*	
★89	nsp	8P 180mm PH-PH		61205049001AS	1	*	
★90	nsp	10P 280mm PH-PH		61205048901AS	1	*	
★91	nsp	6P 250mm EH-EH		61205062900AS	1	*	
★92	nsp	5P EH-EH 5PCS CORD ASSY		61401000900AS	1	*	
★93	nsp	5P EH-EH 4PCS CORD ASSY		61401001000AS	1	*	
★94	nsp	1P CONTACT ASS		61205063400AS	1	*	
101	nsp	3X6 CBTS(S)-B		0RD4737015005	53		
102	nsp	SCREW-B		00M51280308U0	40		
103	nsp	3X32 CBTS-S (B)		0RD4737033003	8		
104	nsp	4X8 TP SCREW		0RD4770312008	4		
105	nsp	B.H.TAPPED EJ330106		00M51280310U0	6		
106	nsp	SCREW		00M51270310U0	65		
107	nsp	SCREW		00M51280312U0	3		
108	nsp	3X16 CPTS(B) SW W		0RD4770153021	19		
109	nsp	3X5 CBS		0RD4713302017	1		
110	nsp	4X8 CBTS(B)-B-3P	BK	0RD4738064000	6		
110	nsp	4X8 CBTS(B)-N-3P	SP	0RD4738064013	6		
111	nsp	3X8 CFTS(S)-B		0RD4737003017	1		
112	nsp	3X10 CBTS(S)-Z		0RD4737005002	1		

## PACKING

※Parts indicated by "nsp"on this table cannot be supplied.

※The parts listed b NOTE:The symbols in the column Remarks indicate the following destinations.

E3 : U.S.A. & Canada model E2 : Europe model E1C : China model E1 : Asia model JP : Japan model  
BK : Black model SP : Premium Silver model

REF No.	Part No.	Part Name	Remarks	Q'ty	New	Ver
P1	nsp	CABINET SHEET		00D5040192106	1	
P2	53361022900AD	CUSHION ASSY		53361022900AD	1	*
! P3	-	CUSHION TOP		-	1	*
! P4	-	CUSHION BOTTOM		-	1	*
P5	30701016200AD	RC-1193		30701016200AD	1	*
P6	nsp	BATTERY (SUM3X2) EASTPOWER		69105000400AS	1	
! P7	61105010000AS	AC CORD SET (E3 WHT)	E3	61105010000AS	1	*
! P7	61105010100AS	AC CORD SET (E2 WHT)	E2	61105010100AS	1	*
! P7	61105010200AS	AC CORD SET (E1C WHT)	E1C	61105010200AS	1	*
P8	nsp	POLY COVER		00D5050038072	1	
P9	32401000800AD	MIC AUDYSSEY ACM1HB		32401000800AD	1	
P10	nsp	WI-FI ANTENNA FLY SHEET		54311038300AS	1	*
P11	nsp	ENVELOPE (ZIPPER B7)		53551005900AS	1	*
P12	42911002000AS	MIC STAND		42911002000AS	1	*
P13	nsp	ENVELOPE (ZIPPER A5 HOLE)		53551005900AS	1	*
P14	35201030700AD	INST. MANUAL (E3 CD-ROM)	E3	35201030700AD	1	*
P14	35201030800AD	INST. MANUAL (E2-1 CD-ROM)	E2	35201030800AD	1	*
P14	35201031000AD	INST. MANUAL (E1C CD-ROM)	E1C	35201031000AD	1	*
P15	54111114300AD	GETTING STARTED E3	E3	54111114300AD	1	*
P15	54111114400AD	GETTING STARTED E2	E2	54111114400AD	1	*
P15	54111114500AD	GETTING STARTED E1C	E1C	54111114500AD	1	*
P16	nsp	ENVELOPE (ZIPPER A4 CAUTION)		535510049008S	1	
P17	nsp	SAFETY INSTRUCTIONS (E3)	E3	54311035910AD	1	*
P17	nsp	SAFETY INSTRUCTIONS (E2)	E2	54311037410AD	1	*
P17	nsp	SAFETY INSTRUCTIONS (E1C)	E1C	54311038100AD	1	*
P18	nsp	NOTES ON RADIO		54311036010AD	1	*
P19	nsp	WARRANTY DE COMMON	E3	54311000350AD	1	
P20	nsp	SERVICE CONTRACT SHEET	E3	54311020400AD	1	
P21	11601005100AS	AM LOOP ANTENNA		11601005100AS	1	*
P22	11601005200AS	FM ANTENNA ASSY		11601005200AS	1	*
P23	54311032100AD	SP CABLE LABEL		54311032100AD	1	*
P24	nsp	CAUTION SHEET	E1C	54311025200AD	1	
P25	nsp	WARRANTY FOR CHINA DENON	E1C	8W5431016500D	1	
P26	nsp	ANTENNA ISOLATOR	E1C	18901004900AS	1	
P27	53121041103AD	CARTON CASE	E3	53121041103AD	1	*
P27	53121041101AD	CARTON CASE	E2	53121041101AD	1	*
P27	53121041102AD	CARTON CASE	E1C	53121041102AD	1	*
P28	nsp	CONT LABEL SUB ASSY	E3	8W5451027500D	1	
P28	nsp	CONT LABEL SUB ASSY	E2	8W5451027501D	1	
P28	nsp	CONT LABEL SUB ASSY	E1C	8W5451027502D	1	
P29	nsp	LABEL FOR PKG SG	SP	544110091014M	2	
★P30	nsp	CLEAR LABEL(44X12 T0.05)	E3,E1C	00M32AK861900	1	
P31	nsp	MAC ADDRESS SUB ASSY		8W5441032100S	1	
★P32	nsp	LICENSE SUB ASSY	E3	8W5441042300D	0.5	
★P32	nsp	LICENSE SUB ASSY	E2,E1C	8W5441042301D	0.5	
P33	nsp	AUDYSSEY MIC LABEL		54411042410AS	1	*
★P34	nsp	ANTENNA LABEL		54411042500AS	1	*
★P35	nsp	FM ANTENNA LABEL		54411221400AS	1	*
★P36	nsp	MIC STAND FLY SHEET		54311039300AD	1	*
P37	11601005400AS	WI-FI ANTENNA(RFDPA870900SBAB801)		11601005400AS	2	*

## CX870 CONNECT PCB ASS'Y

※Parts indicated by "nsp" on this table cannot be supplied.

※The parts listed b NOTE: The symbols in the column Remarks indicate the following destinations.

E3 : U.S.A. & Canada model E2 : Europe model E1C : China model E1 : Asia model JP : Japan model  
BK : Black model SP : Premium Silver model

REF No.	Part No.	Part Name	Remarks	Q'ty	New	Ver
<b>SEMICONDUCTORS GROUP</b>						
U0001	23181020250AS	BD00HA3WEFJ-E2		23181020250AS	1	*
U0002	00MHC012405KY	TC7SGU04FE(TE85L F		00MHC012405KY	1	
U0003	18901010200AS	BT MODULE(IBT-06)		18901010200AS	1	*
U0902	23681012650AS	NCP380HMU21AATBG		23681012650AS	1	
U0903	231810089509S	EX3AV		231810089509S	1	
<b>RESISTOR GROUP</b>						
R0001	nsp	RM73B--393JT +1608		00D2472011926	1	
R0002	nsp	RM73B--113JT +1608		00D2472009996	1	
R0003	nsp	RM73B--103JT +1005		00D2473010984	1	
R0004	nsp	RM73B--106KT +1608		00D2472017904	1	
R0005	nsp	RM73B--824JT +1608		00D2472014949	1	
R0006.0007	nsp	RM73B--103JT +1005		00D2473010984	2	
R0902-0905	nsp	RM73B--0R0KT +1608		00D2472018903	4	
R0915	nsp	RM73B--103JT +1005		00D2473010984	1	
R0963	nsp	RM73B--0R0KT+1005		00D2473001906	1	
R0964.0965	nsp	RM73B--103JT +1005		00D2473010984	2	
R0968-0971	nsp	RM73B--0R0KT+1005		00D2473001906	4	
R0972.0973	nsp	RM73B--0R0KT +2125		00D2470018905	2	
R0974	nsp	RM73B--103JT +1005		00D2473010984	1	
R0975	nsp	RM73B--0R0KT+1005		00D2473001906	1	
R0980-0982	nsp	PRB3T4=0R0(1005X4)		126250001502S	3	
R3603	nsp	RM73B--473JT+1005		00D2473012940	1	
R3626	nsp	RM73B--154DT(1608)		00D2472038925	1	
R3627	nsp	RM73B--124DT(1608)		00D2472038909	1	
R3631	nsp	RM73B--514JT +1608		00D2472013995	1	
R3659	nsp	RM73B--100JT		00D2473003962	1	
R9039.9040	nsp	RM73B--0R0KT +1608		00D2472018903	2	
<b>CAPACITORS GROUP</b>						
C0001	nsp	CK73X5R0J106MT(2125)		132450038507S	1	
C0002.0003	nsp	CK73B1A105KT +1608		00D2570521907	2	
C0004	nsp	CC73CH1H220JT +1608		00D2570504908	1	
C0005-0007	nsp	CK73B1A104KT +1005		00D2575008933	3	
C0008	nsp	CC73CH1H220JT +1608		00D2570504908	1	
C0020	nsp	CK73B1H102KT +1608		00D2570509929	1	
C0901	nsp	CK73X5R0J106MT(2125)		132450038507S	1	
C0907	nsp	CK73B1A104KT +1005		00D2575008933	1	
C0930	nsp	CK73B1A104KT +1005		00D2575008933	1	
C0951-0954	nsp	CK73X5R0J106MT(2125)		132450038507S	4	
C0996-0999	nsp	CK73B1A104KT +1005		00D2575008933	4	
C3603	nsp	CK73B1A104KT +1005		00D2575008933	1	
C3615	nsp	CK73X5R0J106MT(2125)		132450038507S	1	
C3619	nsp	CK73B1E103KT(1005)		00D2575008946	1	
C3623	nsp	CK73B1A104KT +1005		00D2575008933	1	
C3627	nsp	CK73X5R0J106MT(2125)		132450038507S	1	
C3633	nsp	CK73X5R0J106MT(2125)		132450038507S	1	
C3637	nsp	CC73CH1H100DT +1005		00D2575002926	1	
C3645	nsp	CK73B1A104KT +1005		00D2575008933	1	
C3649	nsp	CK73B1H102KT +1005		00D2575006993	1	
<b>OTHER PARTS GROUP</b>						
B0901.0902	nsp	M3 SCREW TERMINAL H=4.5		44431034300AD	2	*
L0001.0002	nsp	E.FIL(BLM21PG221SN1)+2125		00D2350147909	2	
L0901.0902	nsp	E.FIL(BLM21PG221SN1)+2125		00D2350147909	2	
L3601	nsp	E.FIL(BLM21PG221SN1)+2125		00D2350147909	1	
L3606	nsp	E.FIL(BLM21PG221SN1)+2125		00D2350147909	1	
N0001	nsp	B11B-PH-K-S (LF)(SN)		00MYJ06006310	1	
N0901	nsp	S11B-PH-K-S (LF)(SN)		00MYJ06006510	1	
N0902	nsp	120P(14 5046 120 645 829+)		64501020350AS	1	
N0903	nsp	S6B-PH-K-S (LF)(SN)		00MYJ06006460	1	
N0904	nsp	S5B-PH-K-S (LF)(SN)		00MYJ06006450	1	
N0905.0906	nsp	64P(S1262-64SVB-S02-1R)		64501020250AS	2	*
X0001	00MJX0000246Y	TFX-02(32.768kHz)		00MJX0000246Y	1	