



V22910

DENON

Hi-Fi Component

SERVICE MANUAL

MODEL DCD-425 MODEL DCD-335

STEREO CD PLAYER

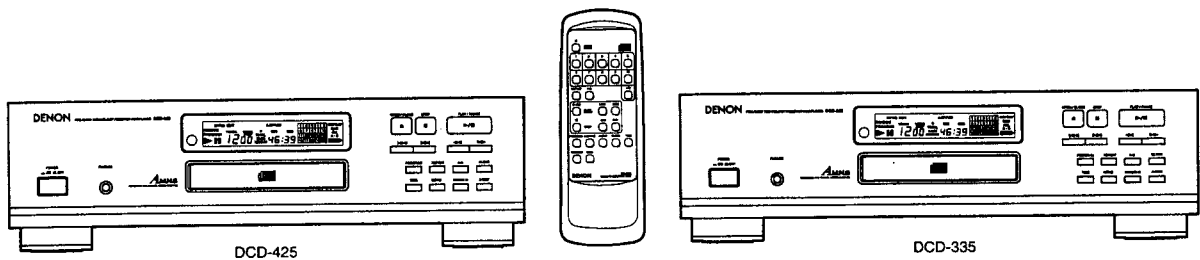

— CONTENTS —

OPERATING INSTRUCTIONS	2-8
SPECIFICATIONS	8
NOTE FOR HANDLING OF LASER PICK-UP	9-11
DISASSEMBLY	12,13
ADJUSTMENT	14,15
SEMICONDUCTORS	16-20
PRINTED WIRING BOARD	21
NOTE FOR PARTS LIST	22
PRINTED WIRING BOARD PARTS LIST	22,23
PARTS LIST OF EXPLODED VIEW	24
EXPLODED VIEW OF CHASSIS AND CABINET	25
EXPLODED VIEW OF CD MECHANISM	26
PARTS LIST OF CD MECHANISM	26
BLOCK DIAGRAM	27
WIRING DIAGRAM	28
PARTS LIST OF ACCESSORIES AND PACKING VIEW	29
SCHEMATIC DIAGRAM	31

• Some illustration using in this service manual is slightly different from the actual set.

NIPPON COLUMBIA CO., LTD.

OPERATING INSTRUCTIONS

IMPORTANT TO SAFETY

WARNING:
TO PREVENT FIRE OR SHOCK HAZARD, DO NOT EXPOSE THIS APPLIANCE TO RAIN OR MOISTURE.

CAUTION:

- Handle the power supply cord carefully. Do not damage or deform the power supply cord. If it is damaged or deformed, the electric shock or malfunction may occur. When removing it from the cord, be sure to remove by holding the plug attachment and not by pulling the cord.
- Do not open the top cover. In order to prevent electric shock, do not open the top cover. If problems occur, contact your **DEMON DEALER**.
- Do not place anything inside. Do not place metal objects or spill liquid inside the CD Player. Electric shock or malfunction may result.

Please, record and retain the Model name and serial number of your set shown on the rating label.
Model No. DCD-425 Serial No. _____

CAUTION
 RISK OF ELECTRIC SHOCK
 DO NOT OPEN

CAUTION
 TO REDUCE THE RISK OF ELECTRIC SHOCK, DO NOT REMOVE COVER (OR BACK). NO USER SERVICEABLE PARTS INSIDE. REFER SERVICING TO QUALIFIED SERVICE PERSONNEL.

The lightning flash with arrowhead symbol, within an equilateral triangle, is intended to alert the user to the presence of uninsulated "dangerous voltage" within the product's enclosure that may be of sufficient magnitude to constitute a risk of electric shock to persons.

The exclamation point within an equilateral triangle is intended to alert the user to the presence of important operating and maintenance (servicing) instructions in the literature accompanying the appliance.

• FOR U.S.A. & CANADA MODEL ONLY

CAUTION
TO PREVENT ELECTRIC SHOCK DO NOT USE THIS (POLARIZED) PLUG WITH AN EXTENSION CORD, RECEPTACLE OR OTHER OUTLET UNLESS THE BLADES CAN BE FULLY INSERTED TO PREVENT BLADE EXPOSURE.

NOTE:

This CD player uses the semiconductor laser. To allow you to enjoy music at a stable operation, it is recommended to use this in a room of 6°C (43°F) ~ 35°C (95°F).

LABELS (for U.S.A. model only)

CERTIFICATION
THIS PRODUCT COMPLIES WITH DHSIS RULES 21 CFR SUBCHAPTER J APPLICABLE AT DATE OF MANUFACTURE.

CAUTION:

USE OF CONTROLS OR ADJUSTMENTS OR PERFORMANCE OF PROCEDURES OTHER THAN THOSE SPECIFIED HEREIN MAY RESULT IN HAZARDOUS RADIATION EXPOSURE.

THE CONTRACTOR/USER/PLAYER SHOULD NOT BE ADJUSTED OR REPAIRED BY ANYONE EXCEPT PROPERLY QUALIFIED SERVICE PERSONNEL.

NOTE:
The unit may cause interference to radio and television reception if you do not operate it in strict accordance with this OPERATING INSTRUCTIONS.

This unit complies with Class B computing device rules in accordance with the specifications in Sub-part J or Part 15 of the FCC Rules, which are designed to provide reasonable protection against such interference in a residential installation. If the unit does cause interference to any radio or television reception, try to reduce it by one or more of the following means:

- Turn the other unit to improve reception
- Move the unit
- Move this unit away from others
- Plug this unit respectively into a different AC outlet







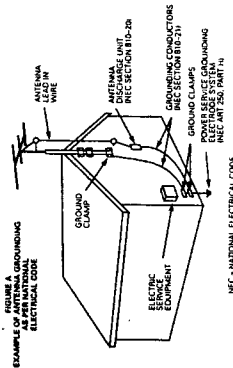

* This is in accordance with Section 15.338 of the FCC Rules.

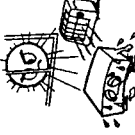
SAFETY INSTRUCTIONS

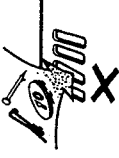
- Read Instructions** - All the safety and operating instructions should be read before the appliance is operated.
- Retain Instructions** - The safety and operating instructions should be retained for future reference.
- Heed Warnings** - All warnings on the appliance and in the operating instructions should be adhered to.
- Follow Instructions** - All operating and use instructions should be followed.
- Water and Moisture** - The appliance should not be used near water, for example, near a bathtub, washbowl, kitchen sink, laundry tub, in a wet basement, or near a swimming pool, and the like.
- Carts and Stands** - The appliance should be used only with a cart or stand that is recommended by the manufacturer.
- Appliance and cart combination** should be moved with care. Quick stops, excessive force, and uneven surfaces may cause the appliance and cart combination to overturn.
- Wall or Ceiling Mounting** - The appliance should be mounted to a wall or ceiling only as recommended by the manufacturer.
- Ventilation** - The appliance should be situated so that its location or position does not interfere with its proper ventilation. For example, the appliance should not be situated on a bed, sofa, rug, or similar surface that may block the ventilation openings; or, placed in a built-in installation, such as a bookcase or cabinet that may impede the flow of air through the ventilation openings.
- Heat** - The appliance should be situated away from heat sources such as radiators, heat registers, stoves, or other appliances (including amplifiers) that produce heat.
- Power Sources** - The appliance should be connected to a power supply only of the type described in the operating instructions or as marked on the appliance.
- Grounding or Polarization** - Precautions should be taken so that the grounding or polarization means of an appliance is not defeated.
- Cleaning** - The appliance should be cleaned only as recommended by the manufacturer.
- Power Lines** - An outdoor antenna should be located away from power lines.
- Outdoor Antenna Grounding** - If an outside antenna is connected to the receiver, be sure the antenna system is grounded so as to provide some protection against voltage surges and built-up static charges. Article 810 of the National Electrical Code, ANSI/NFPA 70, provides information with regard to proper grounding of the mast and supporting structure, grounding of the lead-in wire to an antenna-discharge unit, size of grounding conductors, location of antenna-discharge unit, connection to grounding electrodes, and requirements for the grounding electrode. See Figure A.
- Nonuse Periods** - The power cord of the appliance should be unplugged from the outlet when left unused for a long period of time.
- Object and Liquid Entry** - Care should be taken so that objects do not fall and liquids are not spilled into the enclosure through openings.
- Damage Requiring Service** - The appliance should be serviced by qualified service personnel when:
 - The power-supply cord or the plug has been damaged, or
 - Objects have fallen, or liquid has been spilled into the appliance; or
 - The appliance has been exposed to rain, or
 - The appliance does not appear to operate normally or exhibits a marked change in performance, or
 - The appliance has been dropped, or the enclosure damaged.
- Servicing** - The user should not attempt to service the appliance beyond that described in the operating instructions. All other servicing should be referred to qualified service personnel.

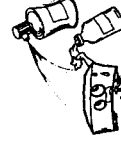

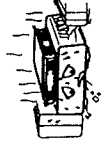
NOTE ON USE / OBSERVATIONS RELATIVES A L'UTILISATION / NOTAS SOBRE EL USO

 <ul style="list-style-type: none"> • Avoid high temperatures. Allow for sufficient heat dispersion when installed on a rack. • Eviter des températures élevées. Tenir compte d'une dispersion de chaleur suffisante lors de l'installation sur une étagère. • Evite altas temperaturas. Permite la suficiente dispersión del calor cuando está instalado en la consola. 	 <ul style="list-style-type: none"> • Keep the set free from moisture, water, and dust. • Protéger l'appareil contre l'humidité, l'eau et la poussière. • Mantenga el equipo libre de humedad, agua y polvo. 	 <ul style="list-style-type: none"> • Do not let foreign objects in the set. • Ne pas laisser des objets étrangers dans l'appareil. • No deje objetos extraños dentro del equipo.
 <ul style="list-style-type: none"> • Unplug the power cord when not using the set for long periods of time. • Débrancher le cordon d'alimentation lorsque l'appareil n'est pas utilisé pendant de longues périodes. • Desconecte el cordón de energía cuando no utilice el equipo por mucho tiempo. 	 <ul style="list-style-type: none"> • Do not let insecticides, benzene, and thinner come in contact with the set. • Ne pas mettre en contact des insecticides, du benzène et un diluant avec l'appareil. • No permita el contacto de insecticidas, gasolina y diluyentes con el equipo. 	 <ul style="list-style-type: none"> • Never disassemble or modify the set in any way. • Ne jamais démonter ou modifier l'appareil d'une manière ou d'une autre. • Nunca desarme o modifique el equipo de ninguna manera.
 <ul style="list-style-type: none"> • Handle the power cord carefully. Hold the plug when unplugging the cord. • Manipuler le cordon d'alimentation avec précaution. Tenir la prise lors du débranchement du cordon. • Maneje el cordón de energía con cuidado. Sostenga el enchufe cuando desconecte el cordón de energía. 	 <p>*If for sets with ventilation holes.</p> <ul style="list-style-type: none"> • Do not obstruct the ventilation holes. • Ne pas obstruer les trous de ventilation. • No obstruya los orificios de ventilación. 	 <ul style="list-style-type: none"> • This compact disc player is capable of playing discs which have the mark at right. • During track selection, during search and when the player sustains a strong impact, the disc's rotational speed changes, greatly, causing a small noise to be emitted. This is not a malfunction of the player. • If the CD player is operated while an FM or AM broadcast is being received, there may be noise in the FM or AM reception. Please switch the power to the CD player off at such times. • The DCD-425 has a broad dynamic range. Please exercise caution when turning up the volume on the amplifier in cases when the playback volume is low. If the volume is turned up too high, it could damage the speakers. • Do not use any discs but exclusive audio discs with this CD player.

Thank you for purchasing this DENON Compact Disc Player. Please read the operating instructions thoroughly in order to acquaint yourself with the CD player and achieve maximum satisfaction from it.

— TABLE OF CONTENTS —

FEATURES 5
 CAUTIONS DURING USE 5
 NAMES AND FUNCTIONS OF PARTS 6-8
 CONNECTION 8
 OPENING AND CLOSING THE DISC HOLDER AND LOADING A DISC 8
 NORMAL CD PLAYBACK 9
 ADVANCED CD PLAYBACK 9-12
 PLAYBACK USING THE REMOTE CONTROL UNIT 12-13
 TIMER-CONTROLLED PLAYBACK 14
 THE COMPACT DISC 14
 INSTALLATION PRECAUTIONS 14
 TROUBLESHOOTING 15
 SPECIFICATIONS 15

Please check to make sure the following items are included with the main unit in the carton:

- (1) Operating Instructions 1
- (2) Connection Card 1
- (3) Remote Control Unit RC-262 1
- (4) R03 AAA Dry Cell Battery 2

IMPORTANT

(CANADIAN MODEL ONLY)

This digital apparatus does not exceed the Class B limits for radio noise emissions from digital apparatus set out in the Radio Interference Regulations of the Canadian Department of Communication.

FEATURES

The DCD-425 is CD Player, equipped with DENON's unique A.M.N.S (Advanced Multilevel Noise Shaping) for eliminating sound quality deterioration in PCM playback system in order to faithfully recreate the sound field. In addition, the compact disc player has a high performance This model uses carefully selected components to provide high performance and sound field recreation with rich musical expression.

(1) **A.M.N.S (Advanced Multilevel Noise Shaping)**
 The use of DENON's unique system for preventing zero cross distortion, the main factor in loss of sound quality in the PCM playback section, plus multilevel noise shaping (A/D/A converters with superior resolution, offers reproduction of the original sound field with rich musical expression.

(2) **High performance digital filter**
 The DCD-425 uses high precision 8-times oversampling digital filter.

(3) **Simple Playback of 8cm CD Singles**
 8cm CD singles can be played without using an adaptor.

(4) **Programming of up to 20 tracks**
 All of the tracks on a CD can be programmed to play in any order.

(5) **Wireless Remote Control Accessory**
 In addition to general operations such as Play, Stop and Pause, this remote control unit enables direct selection, direct programming, and other functions. Use of the remote control unit adds greatly to the operating ease of the DCD-425, enhancing its outstanding features.

(6) **Synchronized Recording Function**
 Connect the SYNCHRO jack with a DENON cassette deck which is equipped with a SYNCHRO jack, then make a synchronized recording.

CAUTIONS DURING USE

- This compact disc player is capable of playing discs which have the mark at right.
- During track selection, during search and when the player sustains a strong impact, the disc's rotational speed changes, greatly, causing a small noise to be emitted. This is not a malfunction of the player.
- If the CD player is operated while an FM or AM broadcast is being received, there may be noise in the FM or AM reception. Please switch the power to the CD player off at such times.
- The DCD-425 has a broad dynamic range. Please exercise caution when turning up the volume on the amplifier in cases when the playback volume is low. If the volume is turned up too high, it could damage the speakers.
- Do not use any discs but exclusive audio discs with this CD player.



- Placing this player or its connection cords near a TV or other audio device could cause a humming sound to be emitted. If this occurs, relocate the player or reroute the connection cords.
- Be sure to remove the disc from the player before moving it. The disc could be damaged if left in the player while it is being moved.
- Do not place any object in the tray in the position where the disc is loaded, or open and close the tray with anything inside. Foreign objects in the tray could damage the play mechanism.
- Do not move the player from a cold place to a warm place suddenly. If the player is cold when brought into a warm room, condensation could form, preventing proper operation of the player. If condensation does form on the player when it is brought into a warm room, wait at least 30 minutes before use.

NAMES AND FUNCTIONS OF PARTS

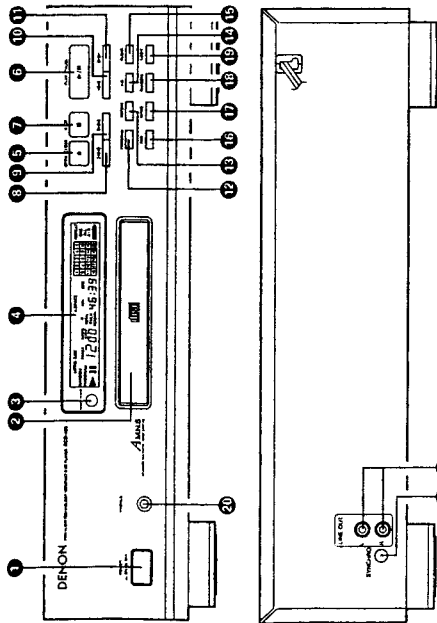

- 1 **Power Switch (POWER)**
 - When the power is turned on, "1.00" appears on the TRACK NO display, and if no disc is loaded, "00:00" appears on the digital display.
 - If the power is turned on with a disc already loaded, the total number of tracks on the disc is displayed on the TRACK NO display, the total time is displayed on the TIME display, the numbers on the music calendar light up to the number of tracks on the disc, and playback begins.
 - Whenever the power switch is in the OFF state, the apparatus is still connected to AC line voltage. Please be sure to unplug the cord when you leave home for, say, a vacation.
- 2 **Disc Holder**
 - Place the disc on the disc holder with the label facing up.
 - Use the OPEN/CLOSE button (▲) (6) to open and close the disc holder.
 - The disc holder may also be closed by pressing the PLAY/PAUSE button (▶/||) (6).
- 3 **Remote Control Sensor (REMOTE SENSOR)**
 - This sensor receives the infrared light transmitted from the wireless remote control unit.
 - For remote control, point the supplied remote control unit RC-262 towards this sensor.
 - When a signal is transmitted from the remote control unit, the remote control indicator in the display (4) will light up briefly.
- 4 **Display**
 - The digital display is divided into sections, such as displays for track number, playback time and calendar, as shown below.
- 5 **Open/Close Button (▲) OPEN/CLOSE**
 - The disc holder is opened and closed by pressing this button.
 - Press this button once to open the disc holder, and once again to close it.
 - When the disc holder is closed with a disc loaded, the disc will rotate for a couple of seconds while the disc contents are read. The number of tracks and total playback time on the disc are then displayed on the digital display (4).
- 6 **Play/Pause Button (▶/||) PLAY/PAUSE**
 - Press this button to start playback of a disc.
 - When this button is pressed, (E) is displayed, and the track number being played is displayed together with the elapsed playback time of the track.
 - Tracks are shown on the calendar display. Once a track has been played, the corresponding track number goes out on the calendar display.
- 7 **Stop Button (■) STOP**
 - Press this button to stop playback.
 - The disc will stop rotating, and the number of tracks and total playing time of the disc are displayed on the TRACK NO and TIME displays, respectively.
 - In case programmed playback is engaged when this button is pressed, the number of tracks and total playing time of the program are displayed.
- 8 **Automatic Search Reverse Button (◀◀◀)**
 - Press this button to return to the beginning of the present track. Press again to return to other tracks.
 - By pressing the button a number of times, the pickup will move back the corresponding number of tracks.
- 9 **Automatic Search Forward Button (▶▶▶)**
 - Press this button to move the pickup forward to the beginning of the next track. Press again to move ahead to other tracks.
 - By pressing the button a number of times, the pickup will advance the corresponding number of tracks.
- 10 **Manual Search Reverse Button (◀◀)**
 - Press this button during playback for fast reverse search. As long as the button is kept pressed, music signals are played back faster than normal.
 - Pressing this button when the pause mode is engaged, you can quickly reverse the pickup to a desired position. Three times faster compared to manual reverse search during playback. During this time, no sound is heard.
- 11 **Manual Search Forward Button (▶▶)**
 - Press this button during playback for fast forward search. As long as the button is kept pressed, music signals are played back faster than normal.
 - Pressing this button when the pause mode is engaged, you can quickly forward the pickup to a desired position. Three times faster compared to manual forward search during playback. During this time, no sound is heard.
- 12 **Program Button (PROGRAM)**
 - Press this button when you want to enter tracks for programmed playback. (Refer to page 10, for details.)
- 13 **Repeat Button (REPEAT)**
 - Press this button once to repeat playback of all tracks.
 - When this button is pressed once, [REPEAT ALL] lights on the display and all tracks on the disc or in a program will be repeatedly played back.
 - Press this button twice to repeat one track only.
 - When this button is pressed twice, [REPEAT ONE] lights on the display and the track currently playing is repeated.
 - Press the button once more to disengage the repeat function.
- 14 **A-B Repeat Button (A-B)**
 - Press this button for repeat playback between a designated starting point (A) and at ending point (B).
 - (Refer to page 10 for details.)
- 15 **Clear Button (CLEAR)**
 - Press this button to clear the last track from the program.
- 16 **Time Mode Button (TIME)**
 - This button is used to select the desired indication on the TIME display. The indication on this display will change each time the button is pressed.
 - Normally, the elapsed playback time of the current track is displayed.
 - Pressing the button once, [EACH REMAIN] is displayed and the remaining time of the current track is displayed.
 - Pressing the button once more, [TOTAL REMAIN] is displayed, and total playing time of remaining tracks is displayed. However, when programmed play is in progress, the total remaining time of the program is displayed.
 - Press the button once again to return to the normal display of the elapsed playback time of the current track.
- 17 **Intro Scan Button (INTRO)**
 - Press this button to play only the first 10 seconds of each track in order.
- 18 **Random Play Button (RANDOM)**
 - Press this button to play the tracks on the disc in random order.
- 19 **Auto Edit Button (A. EDIT)**
 - The tracks on a CD are automatically split into two halves, Side A and Side B, like an analog disc, with the division at the piece between tracks which is closest to 1/2 the total playing time, and with the tracks remaining in the same order.
 - When this button is pressed in the stop mode, the total playing time for the first half and the track numbers on the calendar are displayed for approximately 2 seconds. Next, the same is done for the second half, after which the unit is automatically set to the pause mode at the beginning of the first track. When the PLAY/PAUSE button (▶/||) is pressed, playback begins, and the unit is automatically set to the pause mode at the beginning of the first track of the second half, which was previously displayed. When the PLAY/PAUSE button (▶/||) is pressed again, playback begins, and the unit is automatically set to the stop mode at the end of the last track on the disc.
 - This function will only work for discs with a total of 20 tracks or less. Also, when this function is used the mode is automatically set to the program mode, so direct search is not possible.
 - The auto edit function is cleared when the STOP button (■) is pressed.
 - The data for the total playing time recorded on the disc and the actual total playing time of the tracks differ, so there may be a difference between the time displayed in the stop mode (the total playing time) and the total of the times of the first and second halves in the auto edit mode (about 2 seconds).
- 20 **Headphones Jack (PHONES)**
 - For private listening, you can connect your headphones to this jack. (Headphones are sold separately.)
- 21 **Output Terminal (LINE OUT)**
 - Connect these jacks to the input jacks on your amplifier. (Refer to page 8 for details on the connections.)

- 1 **Power Switch (POWER)**
 - When the power is turned on, "1.00" appears on the TRACK NO display, and if no disc is loaded, "00:00" appears on the digital display.
 - If the power is turned on with a disc already loaded, the total number of tracks on the disc is displayed on the TRACK NO display, the total time is displayed on the TIME display, the numbers on the music calendar light up to the number of tracks on the disc, and playback begins.
 - Whenever the power switch is in the OFF state, the apparatus is still connected to AC line voltage. Please be sure to unplug the cord when you leave home for, say, a vacation.
- 2 **Disc Holder**
 - Place the disc on the disc holder with the label facing up.
 - Use the OPEN/CLOSE button (▲) (6) to open and close the disc holder.
 - The disc holder may also be closed by pressing the PLAY/PAUSE button (▶/||) (6).
- 3 **Remote Control Sensor (REMOTE SENSOR)**
 - This sensor receives the infrared light transmitted from the wireless remote control unit.
 - For remote control, point the supplied remote control unit RC-262 towards this sensor.
 - When a signal is transmitted from the remote control unit, the remote control indicator in the display (4) will light up briefly.
- 4 **Display**
 - The digital display is divided into sections, such as displays for track number, playback time and calendar, as shown below.
- 5 **Open/Close Button (▲) OPEN/CLOSE**
 - The disc holder is opened and closed by pressing this button.
 - Press this button once to open the disc holder, and once again to close it.
 - When the disc holder is closed with a disc loaded, the disc will rotate for a couple of seconds while the disc contents are read. The number of tracks and total playback time on the disc are then displayed on the digital display (4).
- 6 **Play/Pause Button (▶/||) PLAY/PAUSE**
 - Press this button to start playback of a disc.
 - When this button is pressed, (E) is displayed, and the track number being played is displayed together with the elapsed playback time of the track.
 - Tracks are shown on the calendar display. Once a track has been played, the corresponding track number goes out on the calendar display.
- 7 **Stop Button (■) STOP**
 - Press this button to stop playback.
 - The disc will stop rotating, and the number of tracks and total playing time of the disc are displayed on the TRACK NO and TIME displays, respectively.
 - In case programmed playback is engaged when this button is pressed, the number of tracks and total playing time of the program are displayed.
- 8 **Automatic Search Reverse Button (◀◀◀)**
 - Press this button to return to the beginning of the present track. Press again to return to other tracks.
 - By pressing the button a number of times, the pickup will move back the corresponding number of tracks.
- 9 **Automatic Search Forward Button (▶▶▶)**
 - Press this button to move the pickup forward to the beginning of the next track. Press again to move ahead to other tracks.
 - By pressing the button a number of times, the pickup will advance the corresponding number of tracks.
- 10 **Manual Search Reverse Button (◀◀)**
 - Press this button during playback for fast reverse search. As long as the button is kept pressed, music signals are played back faster than normal.
 - Pressing this button when the pause mode is engaged, you can quickly reverse the pickup to a desired position. Three times faster compared to manual reverse search during playback. During this time, no sound is heard.
- 11 **Manual Search Forward Button (▶▶)**
 - Press this button during playback for fast forward search. As long as the button is kept pressed, music signals are played back faster than normal.
 - Pressing this button when the pause mode is engaged, you can quickly forward the pickup to a desired position. Three times faster compared to manual forward search during playback. During this time, no sound is heard.
- 12 **Program Button (PROGRAM)**
 - Press this button when you want to enter tracks for programmed playback. (Refer to page 10, for details.)
- 13 **Repeat Button (REPEAT)**
 - Press this button once to repeat playback of all tracks.
 - When this button is pressed once, [REPEAT ALL] lights on the display and all tracks on the disc or in a program will be repeatedly played back.
 - Press this button twice to repeat one track only.
 - When this button is pressed twice, [REPEAT ONE] lights on the display and the track currently playing is repeated.
 - Press the button once more to disengage the repeat function.
- 14 **A-B Repeat Button (A-B)**
 - Press this button for repeat playback between a designated starting point (A) and at ending point (B).
 - (Refer to page 10 for details.)
- 15 **Clear Button (CLEAR)**
 - Press this button to clear the last track from the program.
- 16 **Time Mode Button (TIME)**
 - This button is used to select the desired indication on the TIME display. The indication on this display will change each time the button is pressed.
 - Normally, the elapsed playback time of the current track is displayed.
 - Pressing the button once, [EACH REMAIN] is displayed and the remaining time of the current track is displayed.
 - Pressing the button once more, [TOTAL REMAIN] is displayed, and total playing time of remaining tracks is displayed. However, when programmed play is in progress, the total remaining time of the program is displayed.
 - Press the button once again to return to the normal display of the elapsed playback time of the current track.
- 17 **Intro Scan Button (INTRO)**
 - Press this button to play only the first 10 seconds of each track in order.
- 18 **Random Play Button (RANDOM)**
 - Press this button to play the tracks on the disc in random order.
- 19 **Auto Edit Button (A. EDIT)**
 - The tracks on a CD are automatically split into two halves, Side A and Side B, like an analog disc, with the division at the piece between tracks which is closest to 1/2 the total playing time, and with the tracks remaining in the same order.
 - When this button is pressed in the stop mode, the total playing time for the first half and the track numbers on the calendar are displayed for approximately 2 seconds. Next, the same is done for the second half, after which the unit is automatically set to the pause mode at the beginning of the first track. When the PLAY/PAUSE button (▶/||) is pressed, playback begins, and the unit is automatically set to the pause mode at the beginning of the first track of the second half, which was previously displayed. When the PLAY/PAUSE button (▶/||) is pressed again, playback begins, and the unit is automatically set to the stop mode at the end of the last track on the disc.
 - This function will only work for discs with a total of 20 tracks or less. Also, when this function is used the mode is automatically set to the program mode, so direct search is not possible.
 - The auto edit function is cleared when the STOP button (■) is pressed.
 - The data for the total playing time recorded on the disc and the actual total playing time of the tracks differ, so there may be a difference between the time displayed in the stop mode (the total playing time) and the total of the times of the first and second halves in the auto edit mode (about 2 seconds).
- 20 **Headphones Jack (PHONES)**
 - For private listening, you can connect your headphones to this jack. (Headphones are sold separately.)
- 21 **Output Terminal (LINE OUT)**
 - Connect these jacks to the input jacks on your amplifier. (Refer to page 8 for details on the connections.)

OPENING AND CLOSING THE DISC HOLDER AND LOADING A DISC

Opening and closing the disc holder (This operation only works while the power is on.)
1. Press the power switch (POWER) to turn on the power.
2. Press the OPEN/CLOSE button (▲).

- How to load a disc**
- Make sure the disc holder is completely open.
 - Hold the disc by the edges and place it on the disc tray. (Do not touch the signal surface, i.e., the glossy side.)
 - When using 12 cm. diameter discs, make sure the outer edge matches the tray guide circumference (Fig. 1), and when using CD singles (8 cm. diameter) match the outer edge with the inner tray guide circumference. (Fig. 2)
 - Press the OPEN/CLOSE button (▲) to close the disc holder.
 - When the disc holder is closed, the disc is read and after a few seconds the number of tracks and total playing time are displayed on the TRACK NO. and TIME displays, respectively.
 - When the disc holder is open and a disc is loaded, you may also press the PLAY/PAUSE button (▶/II) to close the disc holder. (If the PLAY/PAUSE button (▶/II) is pressed, playback will start immediately upon the disc contents having been read.)

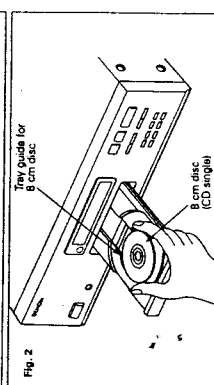
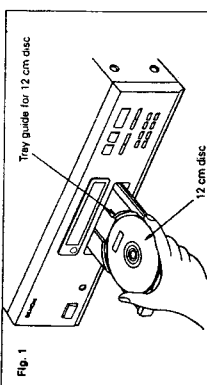

Caution:

- If your finger should get caught in the disc holder when it closes, press the OPEN/CLOSE button (▲).
- Do not place any foreign objects on the disc tray, and do not place more than one disc on the tray at a time. Otherwise malfunction may occur.
- Do not push in the disc tray manually when the power is off as this may cause malfunction and damage the CD player.

NORMAL CD PLAYBACK

(1) Starting Playback

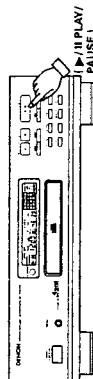

1. Press the power switch (POWER) to turn on the power.
2. Load the disc you want to play.
- When the disc holder is closed, the disc is read and the number of tracks and total playing time of the disc are displayed.
3. Press the PLAY/PAUSE button (▶/II).

(2) Stopping Playback



1. Press the STOP button (■).
- When all tracks have been played on a disc, playback will stop by itself.

Precautions:

- If no disc has been loaded or the disc has been placed upside down, all indicators will light.
- When the information on the disc cannot be read correctly, for example due to dust or dirt on the disc, the indicators will read as shown below. In this case, only the OPEN/CLOSE button (▲) will be worked.

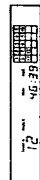

ADVANCED CD PLAYBACK

(1) Playing a specific track Direct Search (Remote control only) (Number buttons)

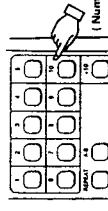

- Use the number buttons and the +10 button to input the number of the desired track.
- For example, to play track number 4, press [4], and to play track number 12, press [+10] and [2]. Playback will begin from that track.

(2) Advancing to the next track Automatic Search (Number buttons)

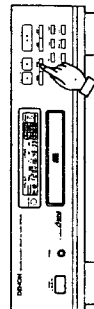

- Press the automatic search forward button (▶) during playback.
- The pickup will advance to the beginning of the next track and playback will continue. Pressing the button several times will forward the pickup the corresponding number tracks.

(3) Returning to the beginning of the current track during playback Automatic Search (Number buttons)

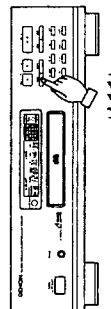

- Press the automatic search reverse button (◀) during playback.
- The pickup will return to the beginning of the current track and playback will continue. Pressing the button several times will return the pickup the corresponding number tracks.

- (4) Playing specific tracks in a specific order Programmed Play
- Programming must be done while the player is stopped.
 - With this function, you can choose any of the tracks on the disc and program them to play in any order.
 - Programming is possible with the disc holder open.
 - Up to 20 tracks can be programmed.
 - The programmed tracks are shown on the calendar.

(5) Programming with remote control unit

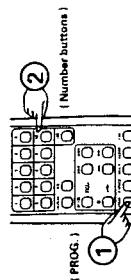

- Press the PROGRAM button (PROG.) so that the [PROGRAM] indicator lights, then use the number buttons and the +10 button of the remote control unit to program the tracks.
- For example, to program tracks 3, 12, and 7, press [PROG.] [3] [+10] [7] and [7].
- The corresponding track number lights on the calendar each time a track is programmed, the track number is displayed on the TRACK NO. display, the number of tracks programmed is displayed on the STEP display and the total playing time of the programmed tracks is displayed on the TIME display. A few seconds after the last track has been programmed, the first programmed track number is displayed on the TRACK NO. display.

22 SYNCHRO Jack (SYNCHRO)

- To make a synchronized recording, this jack must be connected to the SYNCHRO jack of the deck with a connection cord (See Page 8 for connections)

Continuous Button Operation
If the automatic search reverse button (◀) or the automatic search forward button (▶) are held in, the function of that button will be repeated.

CONNECTION

- (1) Connecting the Output Terminal (LINE OUT)
Use the included pin cords to connect the left (L) and right (R) output terminal (LINE OUT) of the DCD-425 to the CD, AUX, or TAPE PLAY left (L) and right (R) input jacks of the amplifier.

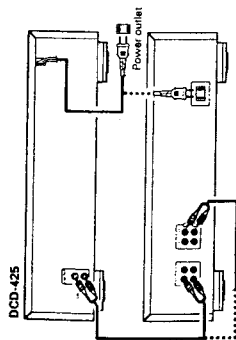

Connection Precautions

- Before proceeding with connections or disconnections of cables and power cords, be sure to turn all system components off.
- Ensure that all cables are connected properly to the L (left) and R (right) jacks.
- Insert plugs fully into the terminals.
- Connect the output jacks to the amplifier CD, AUX or TAPE PLAY input jacks.

(2) SYNCHRO Jack Connections

Connect the SYNCHRO jack with a DENON cassette deck which is equipped with a SYNCHRO jack, then make a synchronized recording. Use the connection cord supplied with the cassette deck. To make use of this function, also connect the output jacks and make the settings so that a recording can be made from the CD player to the cassette deck.

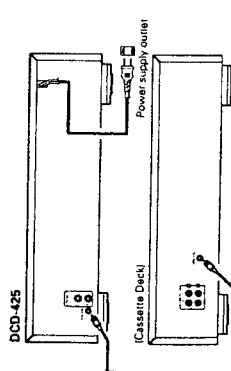

2 Programming with the button of main unit

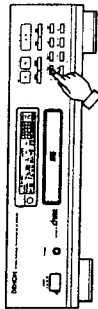

1. Press one of the automatic search buttons (1, 2, 3, 4, 5) to display the desired track number.
2. Press the PROGRAM button.
3. The corresponding track number, lights on the calendar, the track number programmed is displayed on the STEP display and the total playing time of the programmed on the TIME display.
4. Press the automatic search buttons (1, 2, 3, 4, 5) again, select another track, and press the PROGRAM button.
5. The operations in 3 can be repeated to program up to 20 tracks.

3 Checking the programmed tracks (Remote control only)

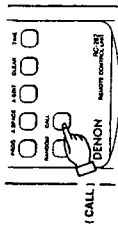

- Press the CALL button.
- The programmed tracks are displayed in order on the TRACK NO. display each time the CALL button is pressed.

4 Playing the programmed tracks

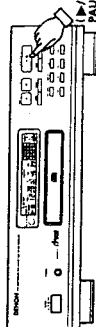

- Press the PLAY/PAUSE button (▶/||) to play the tracks in the programmed order.

5 Clearing the program

- The entire program is cleared when the STOP button (■) is pressed while the player is stopped. The program is also cleared when the OPEN/CLOSE button (⏏) is pressed.
- If the CLEAR button is pressed while the player is stopped, the last programmed track is cleared.

NOTES

- Direct search is not possible during programmed play.
- Programming is possible with the disc holder open. Track numbers greater than the number of tracks recorded on the disc can be programmed, but will be automatically cleared before playback begins.
- The remaining time per track will only be displayed for track numbers 1 through 20.
- The total program time and remaining program time are not displayed if track's greater than track number 20 are programmed.

6 Repeating playback

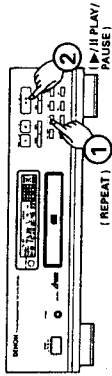

1. Press the REPEAT button once.
2. Press the PLAY/PAUSE button (▶/||).
3. Pressing the REPEAT button once, [REPEAT ALL] is displayed.
4. Steps 1 and 2 above may be reversed.
5. To cancel repeat playback of all tracks, press the REPEAT button twice more.
6. Pressing the REPEAT button once during programmed playback, playback of the tracks entered into the memory will be repeated.
7. Repeating a single track
 1. Press the REPEAT button twice.
 2. Press one of the automatic search buttons (1, 2, 3, 4, 5), until the desired track number is displayed.
 3. Press the PLAY/PAUSE button (▶/||).
 4. Steps 1 and 2 above may be reversed.
 5. To cancel the repeating a single track, press the REPEAT button once more.
8. Repeating playback of a desired interval
 1. Start playback and press the A-B button when you reach the starting point of the interval. The [A-B] indicator starts blinking.
 2. Continue playback or advance the pickup using the automatic search forward button (▶) or manual search forward button (▶) until the ending point is reached. Then press A-B button once more. The [A-B] indicator will light.
 3. The pickup will now return to the starting point and repeat playback of the selected interval.
 4. This interval will be repeated until the A-B repeat mode is cancelled by pressing the A-B repeat button. The [A-B] indicator goes nor random playback.

7 Pausing playback at any point

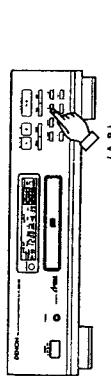

- Press the PAUSE button (||) to temporarily halt and then continued from the same point in the track.
- 1. Press the PLAY/PAUSE button (▶/||) during playback.
- 2. To continue playback, press the PLAY/PAUSE button (▶/||) once more.

8 Audible quick search

- Using this function, you can cue to a desired point within a track, either the forward or reverse direction.
- Release the manual search button (◀ or ▶) when the desired point has been reached. Normal playback then continues.

Manual Search Forward

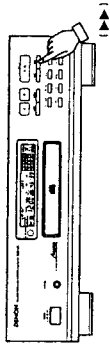

1. Press the manual search forward button (▶) during playback. Playback of the track is sped up.
- As a reference, the current track number and elapsed playback time within the track are displayed.
- Manual search forward is approximately three times faster when engaged during the pause state compared to playback. In this case, no sound is heard however.
- If the manual search forward button (▶) is kept pressed after the end of the final track on the disc is reached, [J] is displayed and manual search stops. To return to another point, press the manual search reverse button (◀) until [J] disappears.
- If the manual search forward button (▶) is kept pressed during the programmed playback or random playback and the end of the current track is reached, the next programmed track or the next selected track is searched and the function is continued.

Manual Search in Reverse



1. Press the manual search reverse button (◀) during playback. Reverse playback of the track is sped up.
- As a reference, the current track number and elapsed playback time within the track are displayed.
- Manual search in reverse is approximately three times faster when engaged during the pause state compared to playback. In this case, no sound is heard however.
- If the manual search reverse button (◀) is kept pressed after the beginning of the first track on the disc is reached, [L] is displayed and manual search stops. To return to another point, press the manual search forward button (▶) until [L] disappears.
- If the manual search reverse button (◀) is pressed during the programmed playback or random playback and the beginning of the current track is reached, the manual search mode is canceled and normal playback is started.

9 Inserting blanks between tracks

- This is convenient feature that will insert 4-second blanks between tracks, which can be used when recording compact discs on tape.

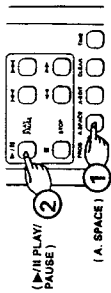

1. Pressing the auto space button (A SPACE) will cause the [A SPACE] indicator to light.
2. When a track has been played to its end, a 4-second silence is made before the next track starts playing.
3. Press the auto space button (A SPACE) again to cancel the function.

10 Searching and Pausing at the Beginning of the Track

- **With Direct Search (Remote control only)**
 - In this case, the set pauses at the beginning of the track found with the direct search operation.

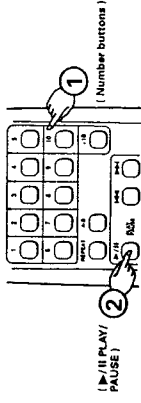

1. Press the number button(s) for the desired track.
2. To start playback, press the PLAY/PAUSE button (▶/||) once more.

With Program Search

- Press the PLAY/PAUSE button (▶/||) after the program search operation is completed. The set will pause at the beginning of the first programmed track.

11 Playing in Random Order

- With this function, the tracks recorded on the disc can be played in a completely random order.



- When the RANDOM button is pressed, the [RANDOM] indicator lights and random play begins automatically.
- If the RANDOM button is pressed when tracks have been programmed, only the programmed tracks will be played, in random order.
- If the RANDOM button is pressed when the repeat function is set, the tracks will be played through once in random order, then played through again in a different order, etc.
- During random play, all of the tracks on the disc are displayed rapidly on the TRACK NO. display, and the track which will be played next cannot be known until playback starts.

REMOTE CONTROL UNIT RC-262

- With the CD player in the stop or pause condition, starting a synchronized recording at the cassette deck side will automatically cause the CD player to start playing. (This is synchronized play.)
- The remote control indicator of the display will blink during synchronized play.

NOTE

- Synchronized play is also possible in the program mode.
- The repeat mode is cancelled when synchronized play is started.
- Except for the STOP, PLAY, TIME and A.SPACE buttons, the buttons will not operate during synchronized play.
- To use this function in the AUTO EDIT condition, use the longer tape than total playing time of the disc.
- In the play condition, even if you start a synchronized recording at the cassette deck side, CD player will not synchronize with the cassette deck and the cassette deck becomes synchronized pause condition. In this case push the STOP button of the cassette deck, set the CD player in the stop or pause condition and start a synchronized recording at the cassette deck side again.
- For further details, see the owner's manual for the cassette deck that has been connected.

- The remaining time in the total mode cannot be displayed during random play.
- If the RANDOM button is pressed when in the auto edit mode, the auto edit mode is cleared.

(12) Playing only the beginning of every track

- Pressing the intro scan play button (INTRO), the beginning of each track is played back 10 seconds from the first track.
- If the intro scan play button (INTRO) is pressed during the playback, the beginning of each track is played back 10 seconds from the current track of the next track.

(13) Synchronized Recording Function

- Connecting the SYNCHRO jack with a DENON cassette deck which is equipped with a SYNCHRO jack will allow synchronized recordings to be made.
- To use this function, be sure to connect the SYNCHRO jacks as well as the output terminal (LINE OUT). (See Page 8 for connections.) Then, load a disc.

PLAYBACK USING THE REMOTE CONTROL UNIT

The accessory RC-262 remote control unit can be used to control the CD player from a convenient distance.

(1) Inserting the dry cell batteries

1. Remove the battery cover on the back of the remote control unit.

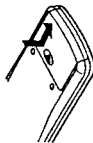

2. Insert two R03 (standard size AAA) dry cell batteries with correct polarity as indicated inside the battery compartment.

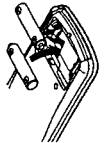

3. Replace the battery cover.

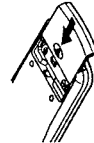

Notes on the Batteries

- The remote control unit uses standard size AAA dry cell batteries.
- The batteries will need to be replaced approximately once a year. Replacement may be necessary earlier depending on how much the remote control unit is used.
- If in less than a year from the time new batteries were inserted, the remote control fails to operate the CD player from a near-by position, it is time to replace the batteries.

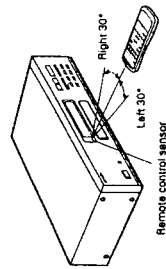

Remote control sensor

Checking Programmed Contents
By pressing the CALL button on the remote control unit, programmed contents will be displayed. Tracks entered into the memory will be displayed starting from the first track entered, and will advance one step at a time each time the CALL button is pressed.

Notes on Operation

- Do not press identical buttons on the CD player and remote control unit simultaneously as this may cause malfunction.
- The remote control unit may be difficult to operate if the remote control sensor is exposed to strong light, such as direct sunlight or light from fluorescent lamps, or if there are obstacles between the remote control unit and the sensor.
- **Direct track selection**
Using the track number buttons (1 - 10, +10), tracks can be directly assigned for playback.

Track selection while programming (Programming must be done while the player is stopped)

- Press the PROGRAM button (PROG) and then the track numbers you wish to enter into the memory.
Example: PROG, - 3 - + 10 & 1 - 5 ...
(Tracks 3, 11, 5 and so on are entered into the memory)

Correct use of the track number buttons

- Direct selection of single-digit tracks is easy by just pressing the desired track number button. For tracks with numbers from 11 and on, first press the +10 button and then a single-digit button. E.g., to select track 22, press the +10 button twice and then press the 2 button.

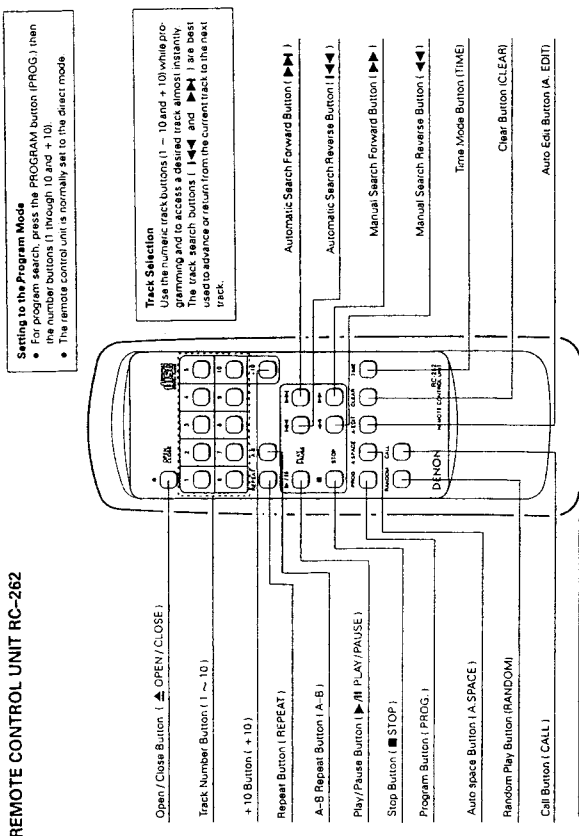

Sending to the Program Mode

- For program search, press the PROGRAM button (PROG) then the number buttons (1 through 10 and +10) to the desired mode.
- The remote control unit is normally sent to the direct mode.

Track Selection

Use the numeric track buttons (1 - 10 and +10) while programming and to access a desired track almost instantly. The track search buttons (1 - 10 and +10) will return to the next track to advance or return from the current track to the next track.

TIMER-CONTROLLED PLAYBACK

■ Connection

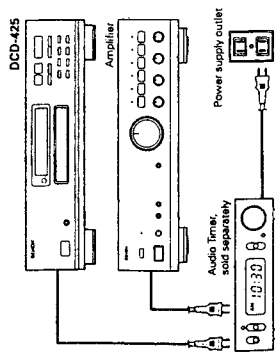

- Operation**
1. Turn on the power of all system components.
 2. Set the input selector on the amplifier to correspond to the inputs the CD player is connected to.
 3. Make sure a disc has been loaded in the disc holder.
 4. Check the time on the timer and then set the desired turn-on time.
 5. Turn the audio timer ON.
Power is turned off automatically in all components connected to the timer.
 6. When the preset turn-on time is reached, power is turned on in the system components, and CD playback starts from the first track.

THE COMPACT DISC

1. **Precautions on handling compact discs**
 - Do not allow fingerprints, oil or dust on the surface of the compact disc. If the signal surface is dirty, wipe it off with a soft, dry cloth. Wipe in circular motions from the center and out.
 - Do not use water, benzene, thinner, record sprays, electrostatic proof chemicals, or silicone-treated cloth to clean discs.
 - Always use care when handling discs to prevent damaging the surface, in particular when removing a disc from the case and re-turning it.
 - Do not bend compact discs.
 - Do not apply heat to compact discs.
 - Do not enlarge the hole in the center of the disc.
 - Do not write on the disc and do not attach any labels.
 - Condensation will form on the disc surface if it is brought into a warm room from a cold area, such as outdoors during winter. Wait until the condensation disappears. Never dry discs with hair dryers, etc.

2. **Precautions on storage**
 - After playing a disc, always return it to its case.
 - Keep discs in the cases when they are not to be played. This will protect them from dust and dirt and prolong their service life.
 - Do not store discs in the following places:
 - 1) Places exposed to direct sunlight for a considerable time.
 - 2) Places subject to accumulation of dust or high humidity.
 - 3) Places exposed to high temperatures, such as close to heater outlets.

INSTALLATION PRECAUTIONS

The CD player uses a microcomputer for controlling internal electronic circuits. In the event that the player is used while a near-by tuner or TV is turned on, although unlikely, interference could occur either in the sound from the tuner or the picture of the TV. To avoid this, please take the following precautions.

- Keep the CD player as far away from the tuner or TV set as possible.
- Keep the power cable and connecting cable of the CD player separate from the antenna wires of the tuner and TV.
- Interference is particularly likely to occur when an indoor antenna or a 300-Ω/ohms feeder cable is used. Thus, use of an outdoor antenna and 75-Ω/ohms coaxial cable is strongly recommended.

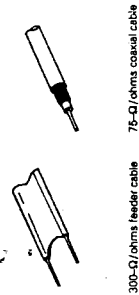

300-Ω/ohms feeder cable

75-Ω/ohms coaxial cable

TROUBLESHOOTING

If the CD player does not seem to be functioning properly, check the following:

- Disc holder does not open or close.
 - A specific section of the disc will not play. See page 14
 - Is the disc dirty or scratched? See page 14
- Disc is not playing.
 - Programmed playback does not work. See page 14
 - Have programming been properly done? See page 9, 10 and 13
- Remote control does not work.
 - Incorrect operation when buttons on the remote control are pressed. See page 9, 10 and 13
 - Is the remote control unit being operated too far from the CD player? See page 12
 - Are there obstacles blocking the ray? See page 12
 - Is the remote control sensor exposed to strong light? See page 12
 - Are the batteries exhausted? See page 12

SPECIFICATIONS

AUDIO

- Number of Channels: 2 channels
- Frequency Response: 2 ~ 20,000 Hz
- Dynamic Range: 95 dB
- Signal-to-noise Ratio: 103 dB
- Harmonic Distortion: 0.006% (1kHz)
- Separation: 92 dB (1 kHz)
- Wow and Flutter: Below measurable limit: (±0.001% W, peak)
- Output Voltage: 2.0 V fixed

DISCS

- Compact Disc format
- Voltage and frequency is shown on rating label
- Power Consumption: 11 W
- Dimensions: 434 (W) x 126 (H) x 265 (D) mm
- Weight: (17-3/32" x 4-5/8" x 9-27/32") 3.8 kg (8 lbs 6 oz)

FUNCTIONS AND DISPLAY

- Functions: Automatic search, programmed playback, repeat playback, manual search, auto space, time mode, auto edit, random, intro scan, Track number, time, music calendar, and engaged modes and engaged modes
- Display: Headphones jack
- Others: RC-252
- REMOTE CONTROL UNIT: Infrared pulse system
- Power Supply: 3 V DC, two R03 (standard size AAA) dry cell batteries
- External Dimensions: 57 (W) x 165 (H) x 17 (D) mm (2-1/4" x 6-1/2" x 43/64")
- Weight: 90 g (3.2 oz) including batteries
- SUPPLIED ACCESSORIES: Pin-plug connection cord

* Design and specifications are subject to change without notice in the course of product improvement.

NOTE FOR HANDLING OF LASER PICK-UP

Description of the Components

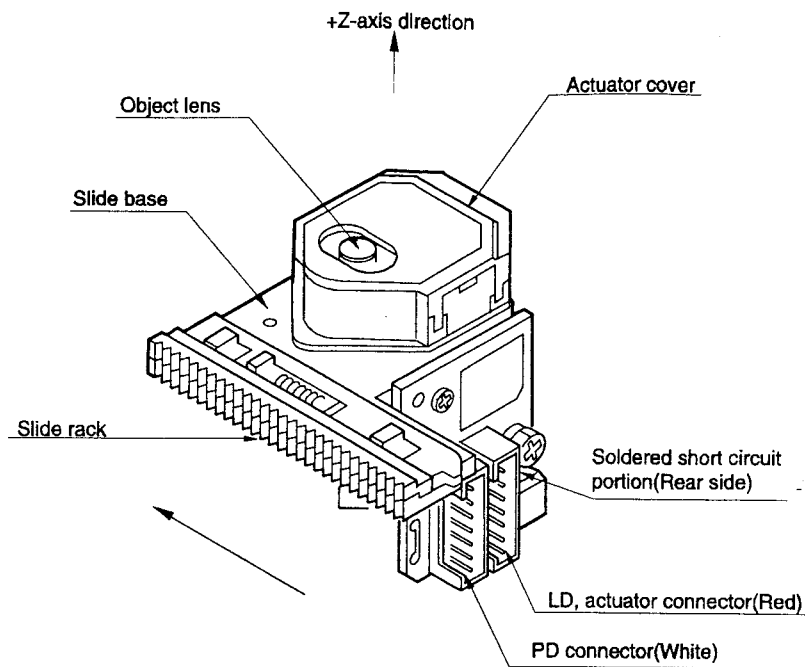

Label

1. Serial number

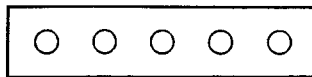

This denotes the serial number used for quality control in the manufacturing plant.

Note: The numbers of figures in English numerals may be changed.

2. Label

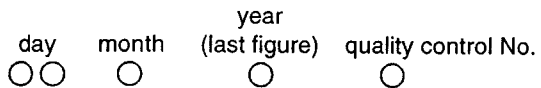
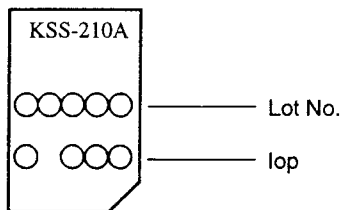

but Oct. Nov. and Dec. are expressed by alphabetical letters of X, Y and Z.

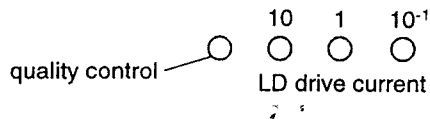

3. Position of the labels

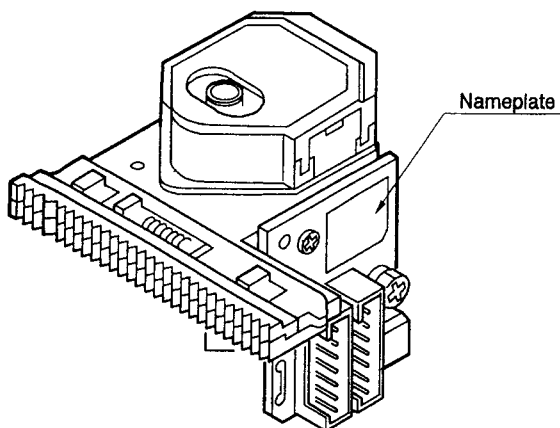

Notes:

- The expressed unit is by mA, with omission of the decimal point as for example, 56.5mA will be expressed as 565, but the head of English letter means the control in the manufacturing plant.

Electrical Pin Connection

1. PD connector (JAPAN SOLDERLESS TERMINAL MFG CO. LTD "PH series" 8 pin)

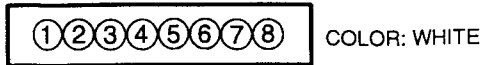

Pin No.	PD element
①	F
②	E
③	K
④	GND
⑤	A
⑥	B
⑦	C
⑧	D

PD Circuit Diagram

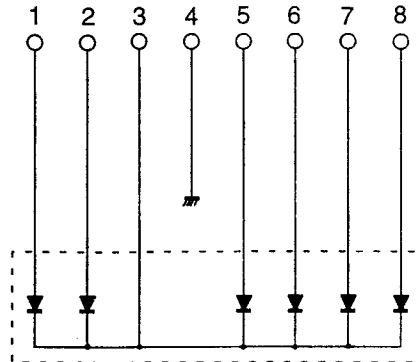

2. Actuator and LD connector (JAPAN SOLDERLESS TERMINAL MFG CO. LTD "PH series" 8 pin)

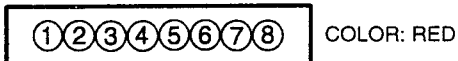

Pin No.	Description
①	Laser
②	GND
③	monitor
④	reference
⑤	Fo (-)
⑥	Tr (+)
⑦	Tr (-)
⑧	Fo (+)

LD Actuator Circuit Diagram

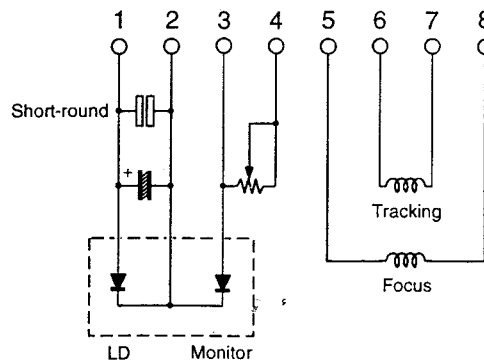

CAUTION

When replacing Pick-up section, connect red connector cord to PD connector (white) of Pick-up section, and white connector cord to LD connector (red) of Pick-up section.

Cautions for Handling the Laser Pick-up

The laser pick-up KSS-210A is assembled and precisely adjusted using a sophisticated manufacturing process in our plant. Do not disassemble or attempt to readjust it. Please keep the following instructions carefully in handling pick-up.

1. Handle with Care

- (1) Storage
Do not store the pick-up in dusty, high-temperature or high-humidity environments.
- (2) Please take care for preventing from shock by falling down or careless handling.

2. Laser Diode (LD)

- (1) Protect your eyes
The laser beam may damage the human eye, since the intensity of the focused spot may reach 7×10^3 W/cm² even if the intensity at the objective lens is 400 μ W maximm. As the light beam spreads after focused through the objective lens, it does not effect you in the place as far as more than 30 cms. However, do not look at the laser light beam either through the objective lens directly nor another lens or a mirror.
- (2) Poison of As
Since the LD chip contains As (Arsenic), as GaAs + GaAlAs, as known as the poison, although the poison is relatively weak, in comparing with others, e.g. As₂O₃, AsCl₃ etc., and the amount is small, avoid putting the chip in acid or an alkali solution, heating it over 200 °C or putting it into your mouth.
- (3) Avoid surge current or electrostatic discharge
The LD may be damaged or deteriorated by its own strong light if a large current is supplied to it, even if only a short pulse.
Make sure that there is no surge current in the LD driving circuit by switches or else. Be careful to handle pick-up as it may be damaged in a moment by human electrostatic discharge. The pins of the LD are short-circuited by solder for protection during shipment.
For safety handling of an LD, grounding the human body, measuring equipments and jig is strongly recommended. And still it is further desirable to make use of mat on the platform and floor for handling the LD.
To open the short circuit, remove the soldering quickly with a soldering iron whose matal part is grounded.
The temperature of the soldering iron should be less than 320 °C (30W).

3. Actuator

- (1) The performance of the actuator may be effected if magnetic material is located nearby, since the actuator has a strong magnetic circuit. Do not permit dust to enter through the clearance of the cover.
- (2) Cleaning the lens
It may change the specifications by attaching dust or ash on the object lens. Clean the lens with a cleaning paper dampened with a little water, not pressing lens with so much strength by the cleaning paper.

4. Metal Bearing

As the metal bearing of Cu-compound sintered alloy is impregnated with FROIL946P (by the Kanto Kasei Kogyo), never fail to supply the bushing with the same lubricant at the time of replacing the pick-up.

5. Handling

Please handle the laser pick-up with holding the slide base. (rosin molded part).
When either a part of human body or some other things may happen to touch directly with the circuit part of P.W.Board, it may cause deterioration, take careful attention in handling this base.

6. Deterioration

When difficulty occurs either in focus or tracking adjustment nor able to adjust the focus or tracking, it seems that the laser pick-up is deteriorated. In these cases, check a value of laser diode current and give a decision for deterioration.

7. Fundamental Deterioration Decision of Laser Pick-up

- (1) If a voltage value in between +5V and Q101(Emitter) of the Main Unit, the value of laser diode current "iop" can be found by a formula

$$\text{"iop 1"} = \frac{V1}{22}$$
- (2) If an "iop" exceeds $\pm 10\%$ compared with the IOP indication on the laser pick-up nameplate, there is a fair chance for deterioration when it is checked under a circumambient temperature 23 °C.
- (3) When the circumambient temperature changes ± 10 °C, "iop 1" will change $\pm 5\%$. The "iop 1" will also be changed by the passage of time.
- (4) In case of the above conditions taking into consideration and performed the adjustment in proper way, if the HF level at TP4 (RF) on Main Unit, and in between GND4 becomes 1V or lesser values; or a jitter occurs great, the laser pick-up may be deteriorated.

DISASSEMBLY

(To reassemble reverse disassembly)

1. Top Cover

- 1) Remove 9 screws (A) on the left, right and rear side.
- 2) Detach the Top Cover in the arrow direction.

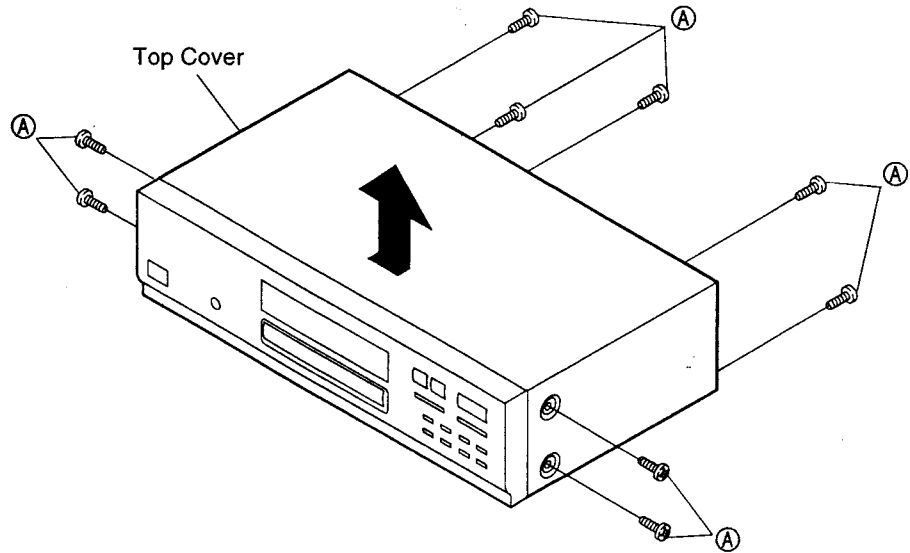

2. Front Panel

- 1) Disconnect a connector connecting with the PO S/W & H/P P.W.B. Unit, and 2 wires connecting with the PO S/W & H/P P.W.B. Unit and Front P.W.B. Unit.
- 2) Remove 5 screws (B) and a screw (C).
- 3) Undo 2 Hooks and detach Front panel in the arrow direction.

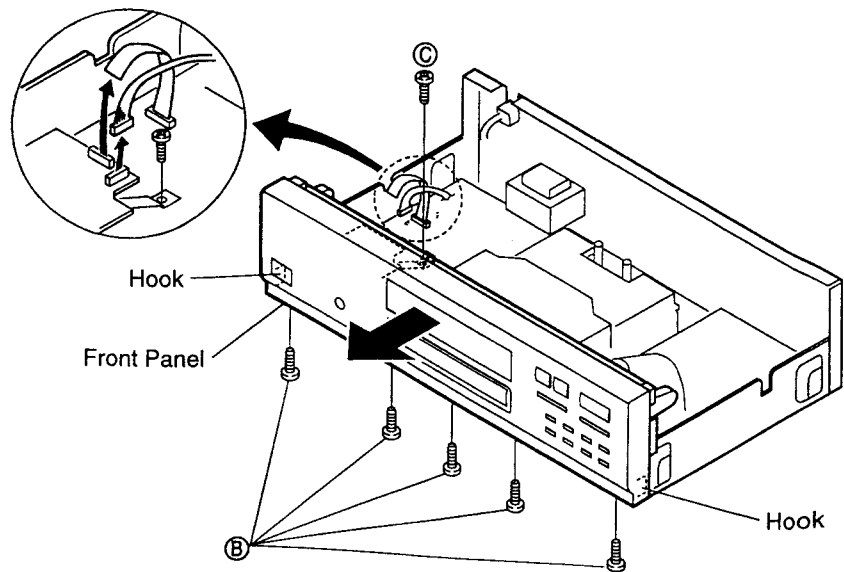

3. CD Mechanism

Remove 4 screws ④ and detach the CD mechanism in the arrow direction.

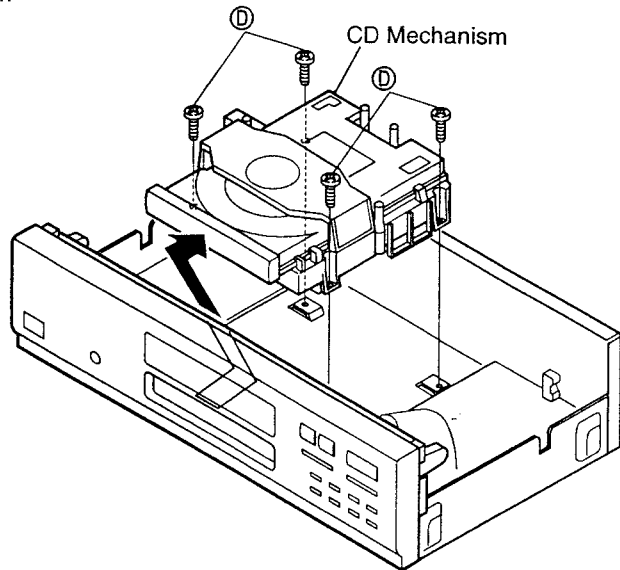

4. Rear Panel

- 1) Remove 2 screws ⑤ and 5 screws ⑥.
- 2) Remove the Cord Bush.
- 3) Unfasten 3 hooks and detach the Rear Panel in the arrow direction.

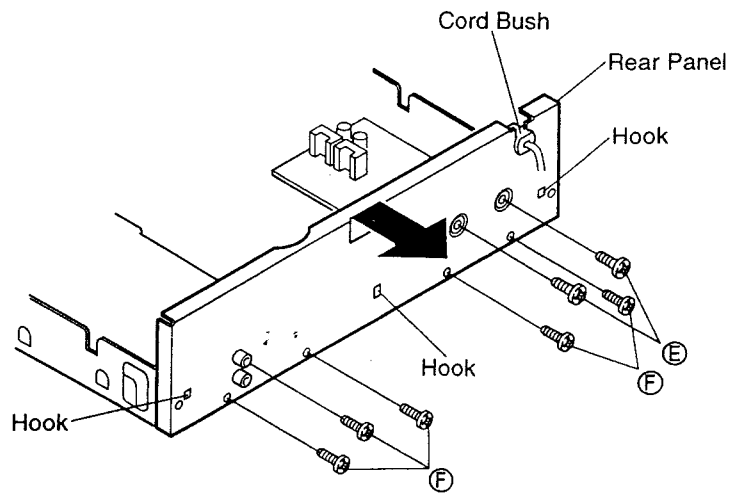

ADJUSTMENT

1. Adjustment method

(1) Necessary equipment for adjustment

1. Dual trace oscilloscope
2. Reference disc TOMITA YASUKO (CA-1094 or CA-1094A)
3. Oscillator (10 Hz ~ 10 kHz, 0 ~ 3 Vp-p)
4. Frequency counter (readable no less than 5 kHz)
5. Lissajous jig

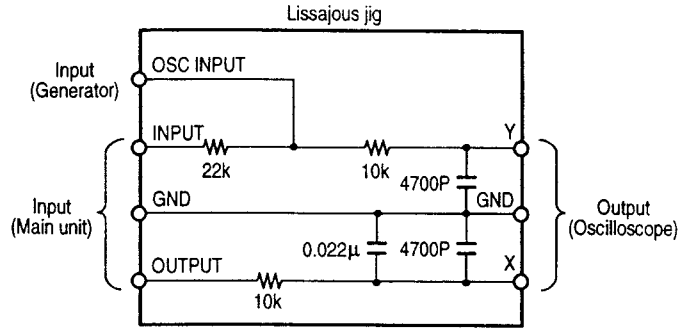

(2) Location

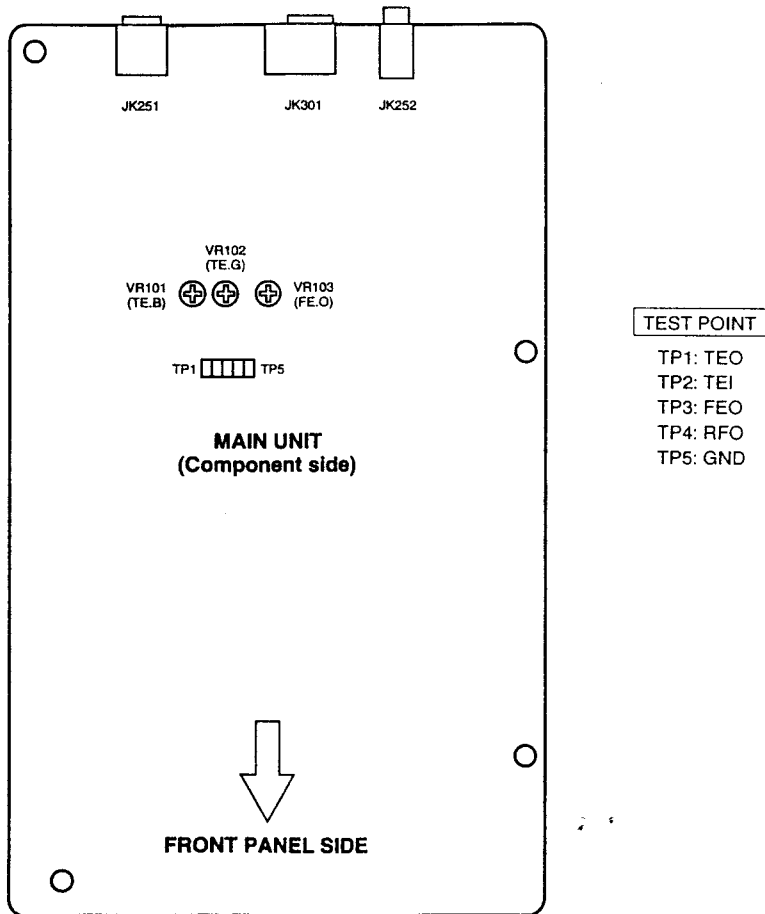

(3) Preset

1.	Preset VR101 to 103.	
2.	Step.	<ol style="list-style-type: none"> 1. Focus offset 2. Tracking offset 3. Tracking gain

Adjustment Disc: CA-1094 or CA-1094A

1. Focus offset Adjustment

1. Connect an oscilloscope to TP3 (FEO) and TP5 (GND).
2. Insert the disc and set the unit in stop mode.
3. Adjust VR103 so as a DC voltage value on the scope becomes 0 V.

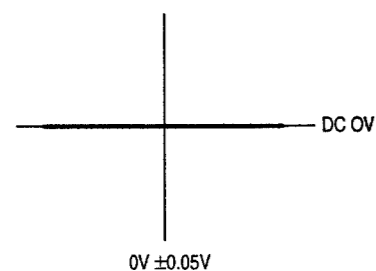

2. Tracking offset Adjustment

1. Connect an oscilloscope to TP1 (TEO) and TP5 (GND).
2. Insert the disc and set the unit in play mode.
3. Set VR102 fully counterclockwise.
4. Adjust VR101 and obtain a waveform on the scope becomes A = B.

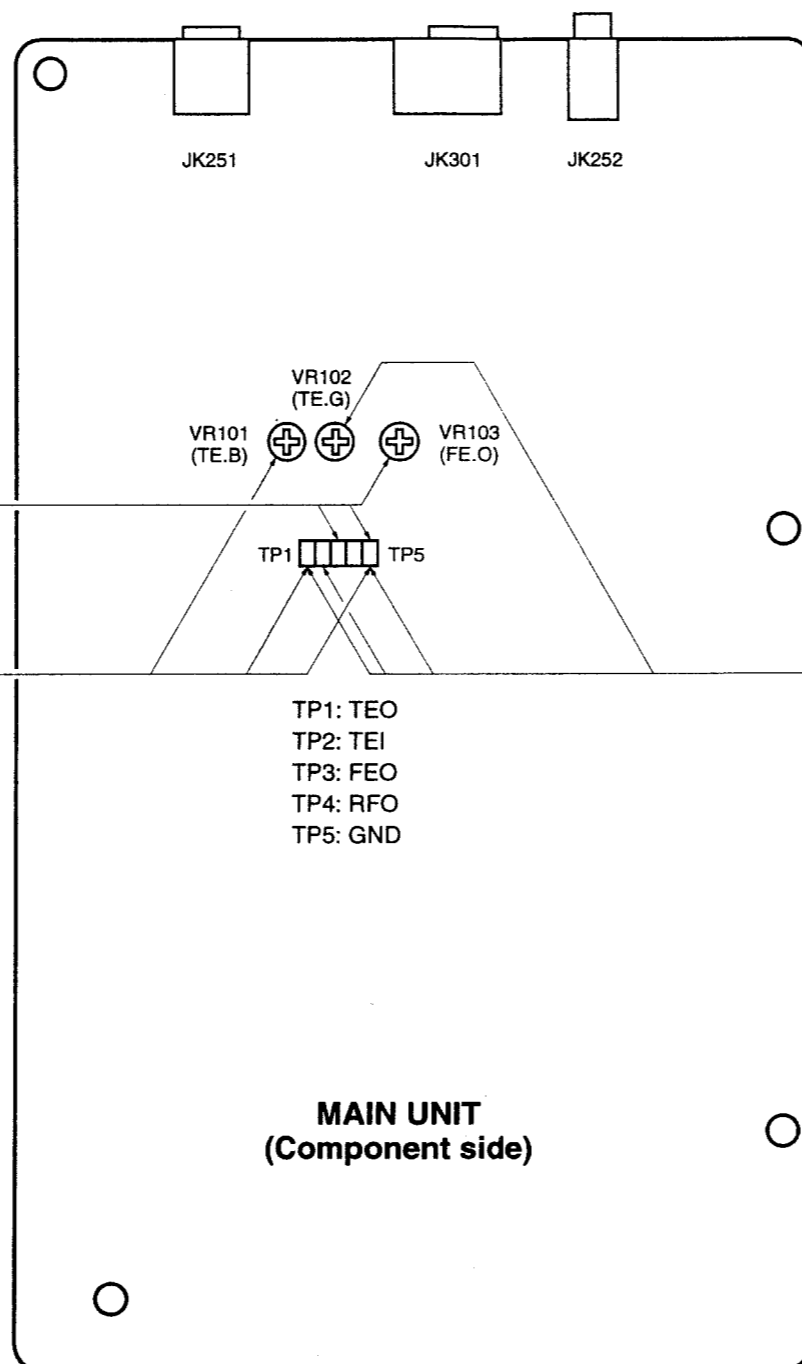
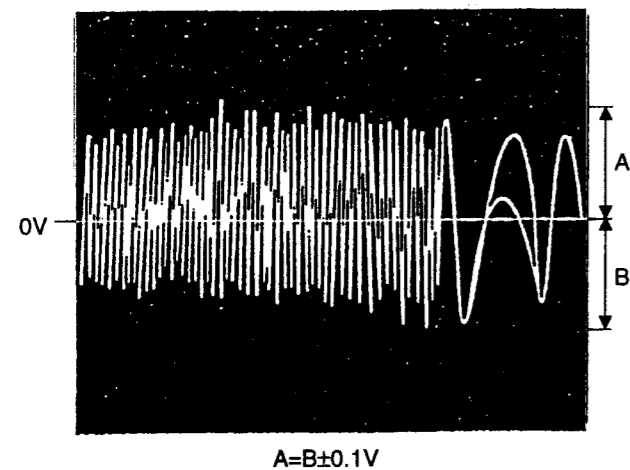

3. Tracking Gain Adjustment

1. Connect INPUT terminal of Lissajous jig and TP2 (TEI).
2. Connect OUTPUT terminal of Lissajous jig and TP1 (TEO).
3. Connect GND terminal of Lissajous jig and TP5 (GND).
4. Connect OSC INPUT terminal of Lissajous jig and output terminal of generator.
5. Connect GND terminal of Lissajous jig and GND terminal of generator.
6. Connect X, Y terminals of Lissajous jig and X, Y terminals of oscilloscope.
7. Connect GND terminal of Lissajous jig and GND terminal of oscilloscope.
8. Adjust the generator so as to obtain a frequency 1,100 Hz, output 5.0 Vp-p.
9. Load the disc and set the unit in play mode.
10. Adjust VR102 to obtain a waveform on the scope as indicated the following figures.

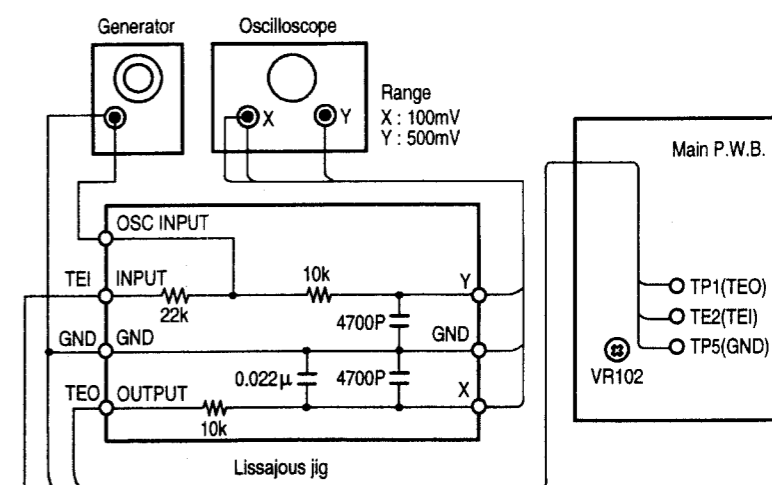

Tracking Gain Waveform

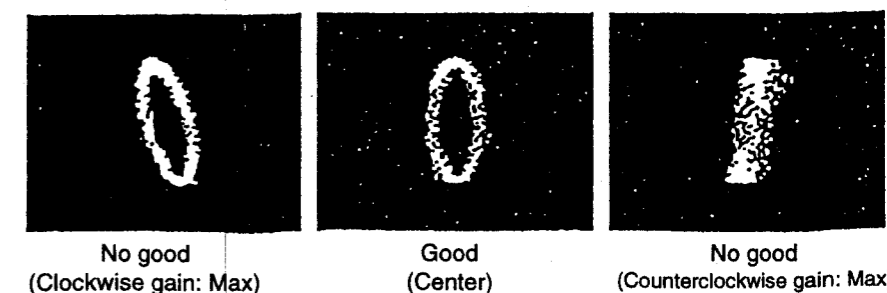

SEMICONDUCTORS

IC's

CXP82316-372Q (IC801)

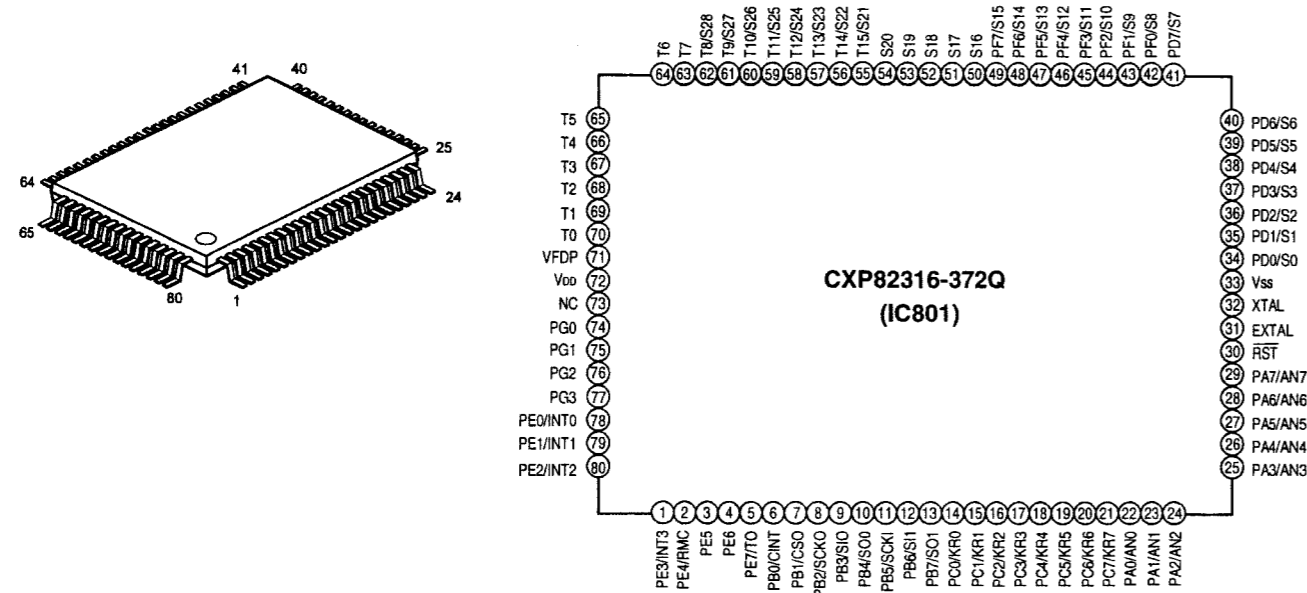

CXP82316-372Q Terminal Function

Pin No.	Port Name	Function Name	I/O	Ini	Function
1	PE3/INT3		I	—	Connect to V _{DD} .
2	PE4/RMC	RMC	I	—	Input signal from remote control.
3	PE5		I	—	Connect to V _{DD} .
4	PE6	XLAT	O	—	Output signal.
5	PE7/T0		O	—	Not used (Open).
6	PB0/CINT		O	—	Not used (Open).
7	PB1/CSO		O	—	Not used (Open).
8	PB2/SCKO	CLK	O	—	Serial clock (CH0) input/output signal.
9	PB3/SIO		O	—	Not used.
10	PB4/SO0	DATA	O	—	Serial output (CH0) output signal.
11	PB5/SCKI	SQCK	I/O	—	Serial clock (CH1) input/output signal.
12	PB6/SI1	SUBQ	I	—	Serial data (CH1) input signal.
13	PB7/SO1		O	—	Not used (Open).
14	PC0/KR0	KEYIN 0	I	L	Key return input signal when scanning key by FDP segment signal.
15	PC1/KR1	KEYIN 1	I	L	Key return input signal when scanning key by FDP segment signal.
16	PC2/KR2	KEYIN 2	I	L	Key return input signal when scanning key by FDP segment signal.
17	PC3/KR3		O	—	Not used (Open).
18	PC4/KR4		O	—	Not used (Open).
19	PC5/KR5		O	—	Not used (Open).
20	PC6/KR6		O	—	Not used (Open).
21	PC7/KR7		O	—	Not used (Open).
22	PA0/ANO	SENS	I	L	Sense input signal from A/D converter.
23	PA1/ANI	OPEN	O	—	OPEN output signal for CD mechanism drive.
24	PA2/AN2	CLOSE	O	—	CLOSE output signal for CD mechanism drive.
25	PA3/AN3	FOK	I	L	FOK input signal.
26	PA4/AN4	LDON	O	—	Laser control output signal.
27	PA5/AN5	MUTE	O	—	MUTE output signal.
28	PA6/AN6	XRST	O	L	Not used (Open).
29	PA7/AN7		O	L	Not used (Open).
30	RST	RST	I/O	—	Reset signal (L: system reset).

Pin No.	Port Name	Function Name	I/O	Ini	Function
31	EXTAL	XTAL L1	I	—	X'tal connecting terminal for system clock oscillation.
32	XTAL	XTAL L0	O	—	X'tal connecting terminal for system clock oscillation.
33	VSS		—	—	Ground.
34	PD0/S0		O	—	Not used (Open).
35	PD1/S1		O	—	Not used (Open).
36	PD2/S2		O	—	Not used (Open).
37	PD3/S3	P21	O	—	Segment signal output terminal for FDP.
38	PD4/S4	P20	O	—	Segment signal output terminal for FDP.
39	PD5/S5	P19	O	—	Segment signal output terminal for FDP.
40	PD6/S6	P18	O	—	Segment signal output terminal for FDP.
41	PD7/S7	P17	O	—	Segment signal output terminal for FDP.
42	PF0/S8	P16	O	—	Segment signal output terminal for FDP.
43	PF1/S9	P15	O	—	Segment signal output terminal for FDP.
44	PF2/S10	P14	O	—	Segment signal output terminal for FDP.
45	PF3/S11	P13	O	—	Segment signal output terminal for FDP.
46	PF4/S12	P12	O	—	Segment signal output terminal for FDP.
47	PF5/S13	P11	O	—	Segment signal output terminal for FDP.
48	PF6/S14	P10	O	—	Segment signal output terminal for FDP.
49	PF7/S15	P9	O	—	Segment signal output terminal for FDP.
50	S16	P8/Scan 5	O	—	Segment signal output terminal for FDP, scan key signal.
51	S17	P7/Scan 4	O	—	Segment signal output terminal for FDP, scan key signal.
52	S18	P6/Scan 3	O	—	Segment signal output terminal for FDP, scan key signal.
53	S19	P5/Scan 2	O	—	Segment signal output terminal for FDP, scan key signal.
54	S20	P4/Scan 1	O	—	Segment signal output terminal for FDP, scan key signal.
55	T15/S21	P3	O	—	Segment signal output terminal for FDP.
56	T14/S22	P2	O	—	Segment signal output terminal for FDP.
57	T13/S23	P1	O	—	Segment signal output terminal for FDP.
58	T12/S24		O	—	Not used (Open).
59	T11/S25		O	—	Not used (Open).
60	T10/S26		O	—	Not used (Open).
61	T9/S27		O	—	Not used (Open).
62	T8/S28		O	—	Not used (Open).
63	T7		O	—	Not used (Open).
64	T6	1G	O	—	Timing signal output terminal for FDP.
65	T5	2G	O	—	Timing signal output terminal for FDP.
66	T4	3G	O	—	Timing signal output terminal for FDP.
67	T3	4G	O	—	Timing signal output terminal for FDP.
68	T2	5G	O	—	Timing signal output terminal for FDP.
69	T1	6G	O	—	Timing signal output terminal for FDP.
70	T0	7G	O	—	Timing signal output terminal for FDP.
71	VFDP	VFDP	—	—	-24V power supply terminal for FDP when specified built-in resistance by mask option.
72	VDD	VDD	—	—	+5V power supply terminal.
73	NC		—	—	NC terminal, normally connect to V _{DD} .
74	PG0		I	L	Not used (Connect to GND).
75	PG1		I	L	Not used (Connect to GND).
76	PG2	CDP S2 P	O	H	System control output signal from CDP.
77	PG3	CDP S1 P	I	—	System control input signal to Deck.
78	PE0/INT0	SCOR	I	L	Input signal for read sub-Q.
79	PE1/INT1	OP/SW	I	H	Open switch terminal.
80	PE2/INT2	CL/SW	I	H	Close switch terminal.

CXD2500BQ (IC201)

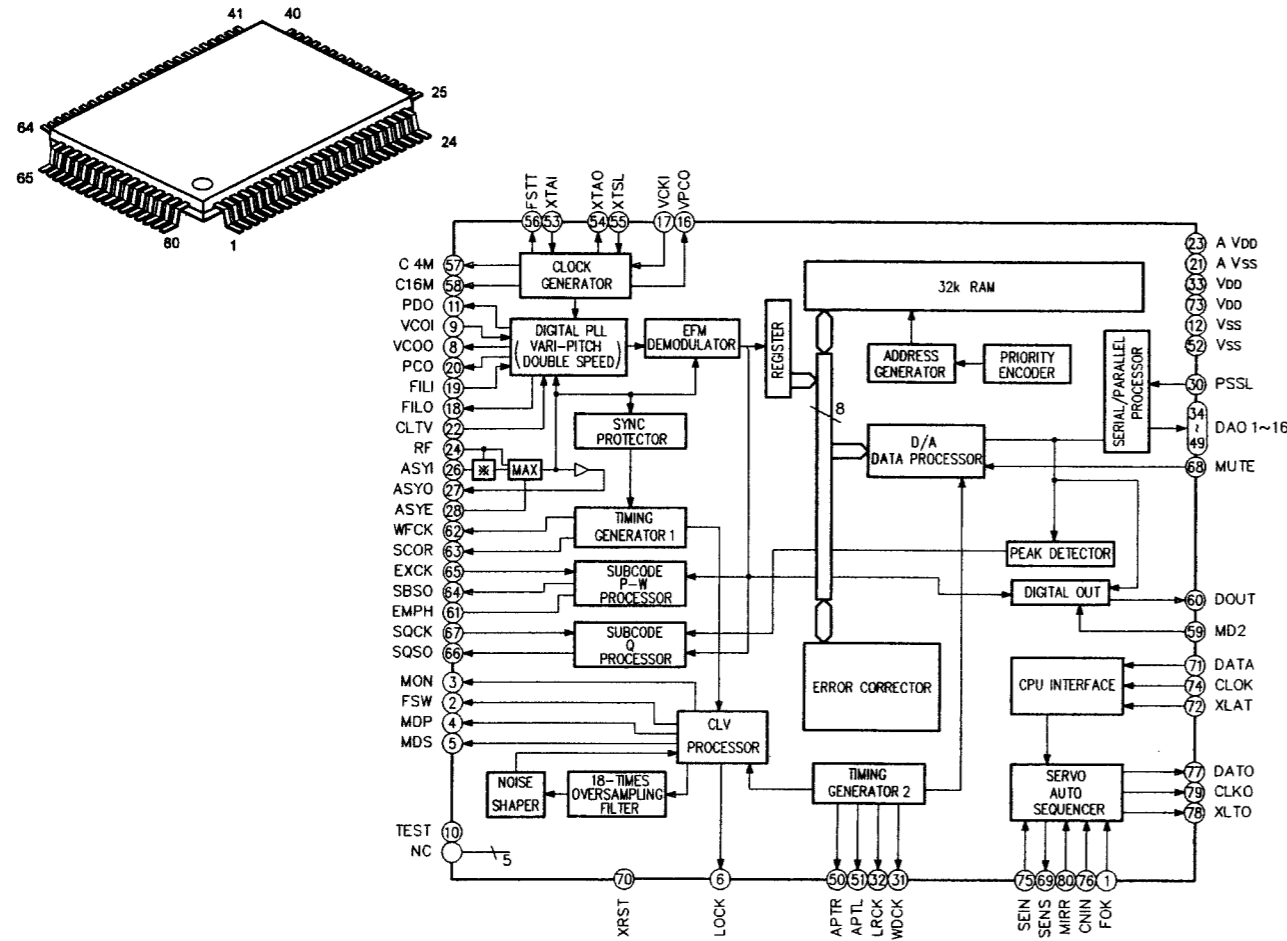

CXD2500BQ Terminal Function

Pin No.	Symbol	I/O	Function
1	FOK	I	Input terminal for OK focussing. Use for Servo-autosequencer.
2	FSW	O	Output to shift output filter for spindle motor.
3	MON	O	ON/OFF control output for spindle motor.
4	MDP	O	Servo control for spindle motor.
5	MDS	O	Servo control for spindle motor.
6	LOCK	O	Sampling GFS by 460 Hz and if it is "H", outputs "H"; if it is continuously "L" 8 times, outputs "L".
7	NC	—	
8	VCOO	O	Oscillation circuit output for analog EFM PLL.
9	VCOI	I	Oscillation circuit input for analog EFM PLL, f _{lock} = 8.6436MHz
10	TEST	I	TEST terminal. Normally GND.
11	PDO	O	Charge pump output for analog EFM PLL.
12	Vss		GND.
13	NC	—	
14	NC	—	
15	NC	—	
16	VPCO	O	Charge pump output for variable pitch PLL.
17	VCKI	I	Clock input from external VCO for variable pitch. f _c center = 16.9344MHz.
18	FILO	O	Filter output for master PLL. (slave=digital PLL)
19	FILI	I	Filter input for master PLL.
20	PCO	O	Charge pump output for master PLL.
21	AVss		Analog GND.
22	CLTV	I	VCO control voltage input for master.
23	AVDD		Analog power supply (+5V).
24	RF	I	EFM signal input.
25	BIAS	I	Asymmetry circuit constant current input.

Pin No.	Symbol	I/O	Function
26	ASYI	I	Asymmetry compare voltage input.
27	ASYO	O	EFM full swing output. (L: Vss, H: VDD)
28	ASYE	I	L: Asymmetry circuit OFF, H: Asymmetry circuit ON.
29	NC	—	
30	PSSL	I	Audio data output mode shifting input. L: Serial output, H: Parallel output.
31	WDCK	O	D/A Interface for 48-bit slot. Word-clock f=2 Fs.
32	LRCK	O	D/A Interface for 48-bit slot. LR-clock f=Fs.
33	VDD		Power supply (+5V)
34	DA16	O	At PSSL=1 for DA16 (MBS) output; PSSL=0 for serial data of 48-bit slot. (2s'COMP, MSB first).
35	DA15	O	At PSSL=1 for DA15 output; PSSL=0 for bit clock of 48-bit slot.
36	DA14	O	At PSSL=1 for DA14 output; PSSL=0 for serial data of 64-bit slot. (2S'COMP, LSB first).
37	DA13	O	At PSSL=1 for DA13 output; PSSL=0 for bit clock of 64-bit slot.
38	DA12	O	At PSSL=1 for DA12 output; PSSL=0 for LR clock of 64-bit slot.
39	DA11	O	At PSSL=1 for DA11 output; PSSL=0 for GTOP output.
40	DA10	O	At PSSL=1 for DA10 output; PSSL=0 for XUGF output.
41	DA09	O	At PSSL=1 for DA9 output; PSSL=0 for XPLCK output.
42	DA08	O	At PSSL=1 for DA8 output; PSSL=0 for GFS output.
43	DA07	O	At PSSL=1 for DA7 output; PSSL=0 for RFCK output.
44	DA06	O	At PSSL=1 for DA6 output; PSSL=0 for C2P0 output.
45	DA05	O	At PSSL=1 for DA5 output; PSSL=0 for XRAOF output.
46	DA04	O	At PSSL=1 for DA4 output; PSSL=0 for MNT3 output.
47	DA03	O	At PSSL=1 for DA3 output; PSSL=0 for MNT2 output.
48	DA02	O	At PSSL=1 for DA2 output; PSSL=0 for MNT1 output.
49	DA01	O	At PSSL=1 for DA1 output; PSSL=0 for MNT0 output.
50	APTR	O	Control output for aperture compensation. In H for R-ch.
51	APTL	O	Control output for aperture compensation. In H for L-ch.
52	Vss		GND
53	XTAI	I	X'tal oscillation circuit input of 16.9344MHz or 33.8688MHz.
54	XTAO	O	X'tal oscillation circuit output of 16.9344MHz.
55	XTSL	I	Selection input terminal of X'tal. "L" for 16.9344MHz; H for 33.8688MHz.
56	FSTT	O	2/3 Dividing output of 53 and 54 terminal, no change by variable pitch.
57	C4M	O	4.2336MHz output. When variable pitched changes simultaneously.
58	C16M	O	16.9344MHz output. When variable pitched changes simultaneously.
59	MD2	I	Digital-out ON/OFF control. ON at H; OFF at L.
60	DOUT	O	Digital-out output terminal.
61	EMPH	O	When emphasized playback disc, output H; otherwise outputs L.
62	WFCK	O	WFCK (Write Flame Clock) output.
63	SCOR	O	Outputs H when detecting sub code sync S0 or S1.
64	SBSO	O	Serial output of Sub P-W.
65	EXCK	I	Clock input for SBSO read-out.
66	SQSO	O	Sub Q 80-bit and PCM peak level data 16-bit output.
67	SQCK	I	Clock input for SQSO read-out.
68	MUTE	I	H: Mute, L: Release.
69	SENS	—	SENS output. Outputs to CPU.
70	XRST	I	System reset input. Resets at L.
71	DATA	I	Input of serial data from CPU.
72	XLAT	I	Input of latch from CPU. Latches serial data at falling.
73	VDD		Power supply (+5V).
74	CLOK	I	Serial data transfer clock input from CPU.
75	SEIN	I	SENS input from SSP.
76	CNIN	I	Count signal input of track jump number.
77	DATO	O	Serial data output to SSP.
78	XLTO	O	Serial data latch output to SSP. Latches at falling.
79	CLKO	O	Serial data transfer clock output to SSP.
80	MIRR	I	Mirror signal input. Use for track jump over 16 tracks by autosequencer.

CXA1372AQ (IC102)

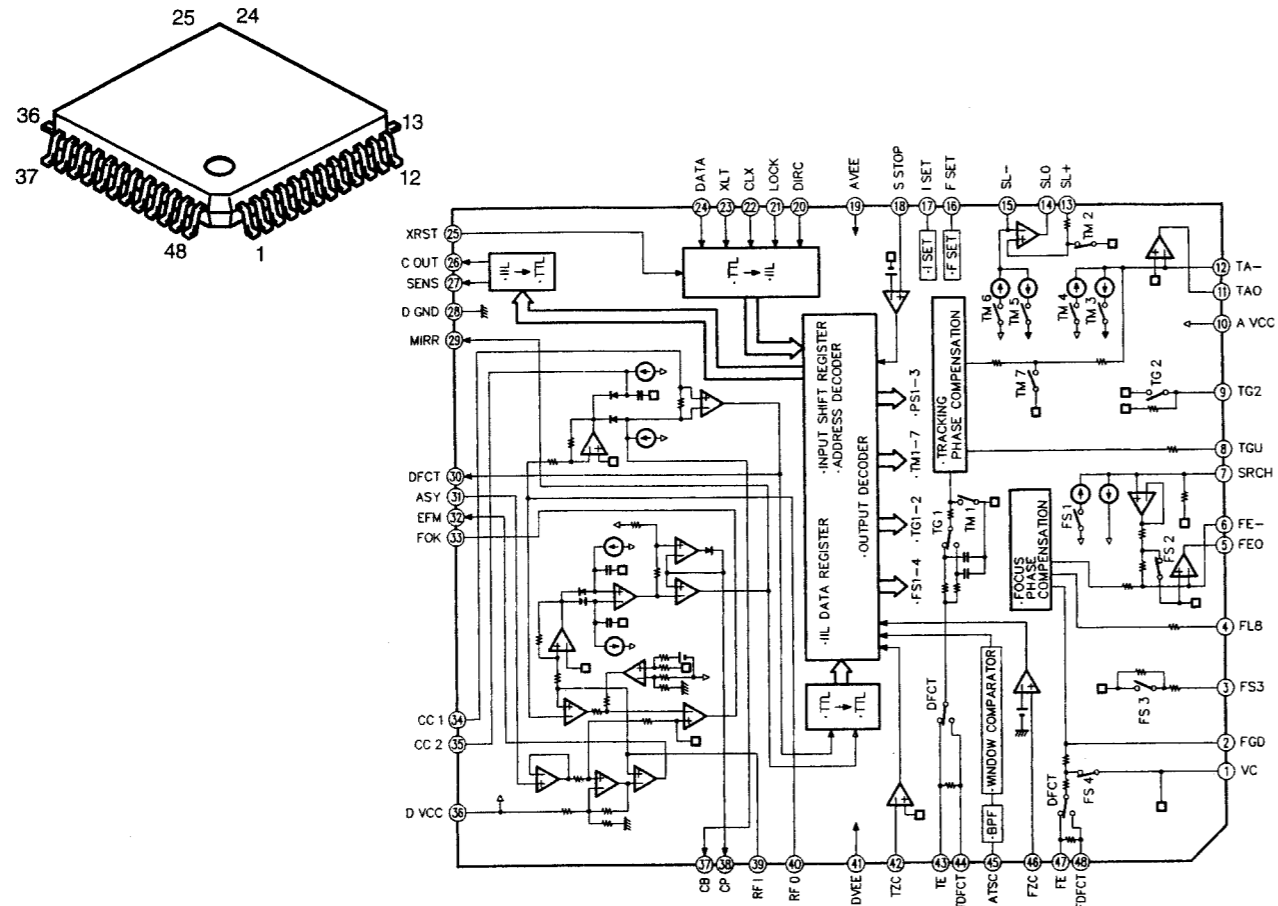

CXA1571M (IC101)

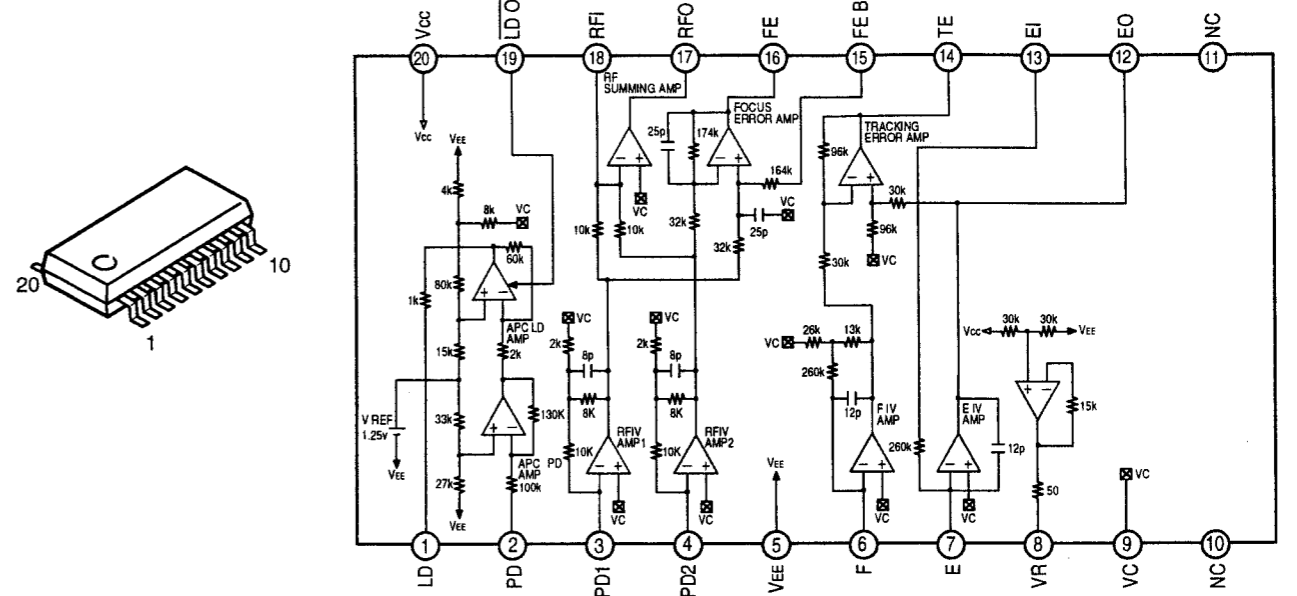

NJM4558DD (IC103, 302, 303)

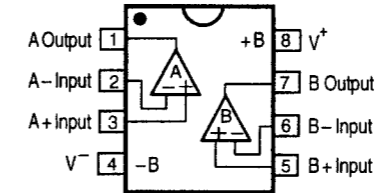
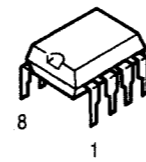

NJM4560D (IC304)

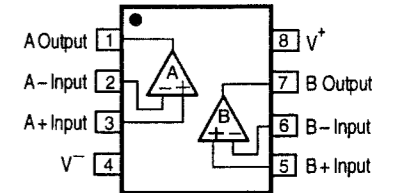
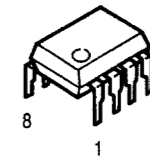

PCM1712U (IC301)

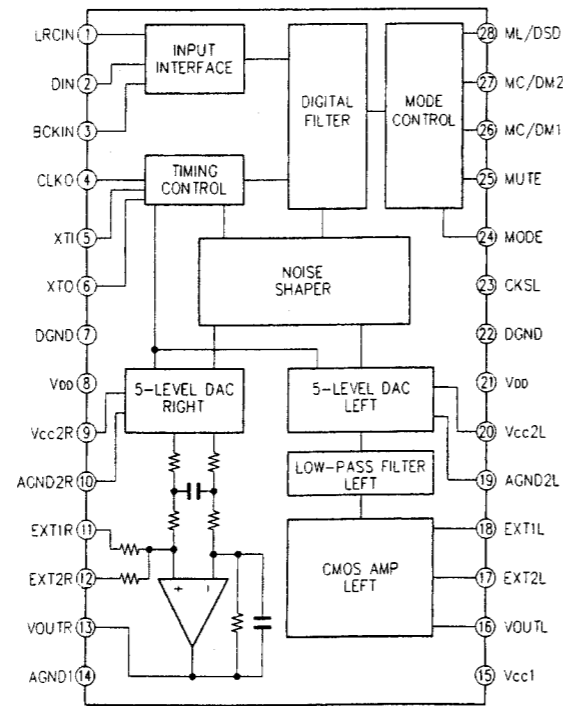
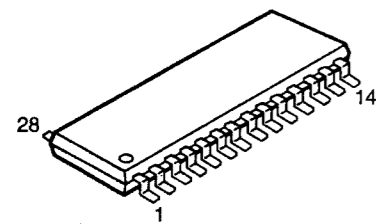

GL7805 (IC502)
GL7808 (IC501)

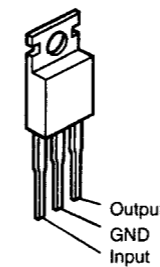

KIA7042P (IC802)

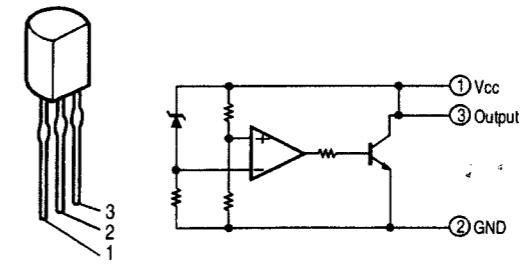

GL7905 (IC505)

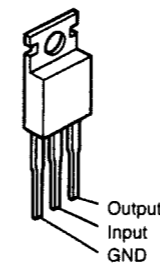

NJM7908FA (IC504)

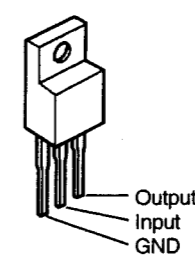

IC PROTECTOR
ICP-N15 (IC503, 506)

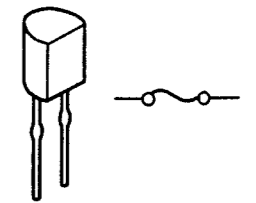

● TRANSISTORS

DTA144WS (PNP)
DTC114ES } (NPN)
DTC343TS

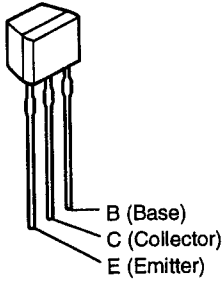

PNP Type
DTA WS Series

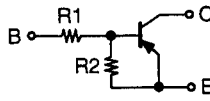

	R1	R2
DTA144WS	47 kohm	22 kohm

NPN Type
DTC ES/TS Series

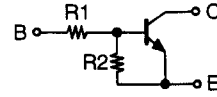

	R1	R2
DTC114ES	10 kohm	10 kohm
DTC343TS	4.7 kohm	—

KTA1266 (Y)

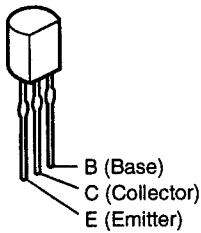

KTA1273 (Y)
KTC3205 (Y)

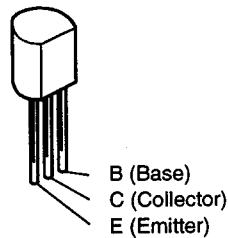

● DIODES

IN4002A

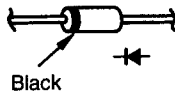

IN4148M

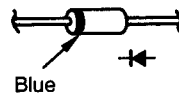

MTZJ5.1B
MTZJ5.6B
MTZJ24B

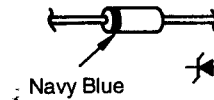

● REMOTE SENSOR

SBX8025L (RM851)

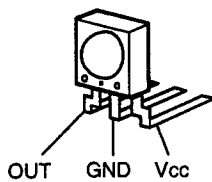

● FL TUBE

SVA-7MM03 (FL851)

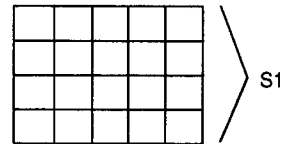
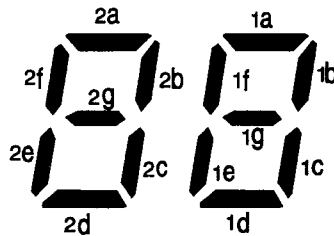
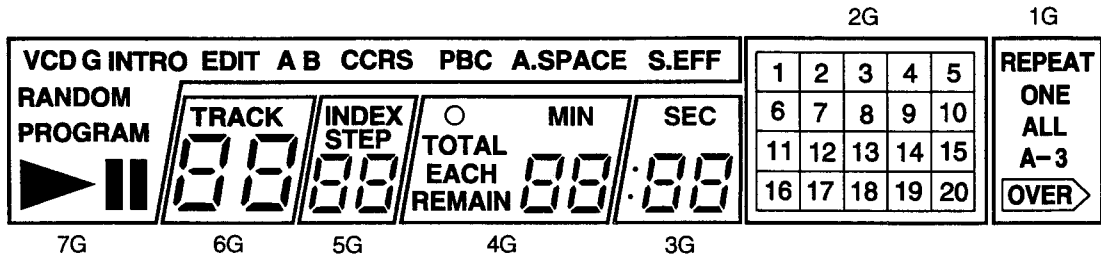
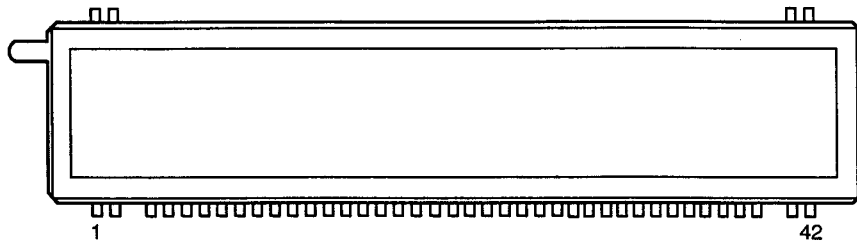

(3G--6G)

PIN CONNECTION

Pin No.	1	2	3	4	5	6	7	8	9	10	11	12	13	14	15	16	17	18	19	20	21	22	23	24
Connection	F1	F1	NP	NX	7G	6G	5G	4G	3G	2G	1G	NX	NX	NX	NX	NX	NX	P1	P2	P3	P4	P5	P6	P7

Pin No.	25	26	27	28	29	30	31	32	33	34	35	36	37	38	39	40	41	42
Connection	P8	P9	P10	P11	P12	P13	P14	P15	P16	P17	P18	P19	P20	P21	NX	NP	F2	F2

Note 1) F1, F2 ----- Filament
 2) NP----- No pin
 3) NX----- No connection
 4) P1~P21----- Anode pin
 5) 1G~17G ----- Grid

ANODE CONNECTION

	7G	6G	5G	4G	3G	2G	1G
P1	▶	1a	1a	1a	1a	1	REPEAT
P2	II	1b	1b	1b	1b	2	ONE
P3	PROGRAM	1c	1c	1c	1c	3	ALL
P4	RANDOM	1d	1d	1d	1d	4	A -
P5	INTRO	1e	1e	1e	1e	5	B
P6		1f	1f	1f	1f	6	OVER
P7	EDIT	1g	1g	1g	1g	7	
P8	A	TRACK	INDEX	MIN	SEC	8	
P9	B	2a	2a	2a	2a	9	
P10		2b	2b	2b	2b	10	
P11		2c	2c	2c	2c	11	
P12	A.SPACE	2d	2d	2d	2d	12	
P13	V	2e	2e	2e	2e	13	
P14	CD	2f	2f	2f	2f	14	
P15	G	2g	2g	2g	2g	15	
P16	CCRS		STEP	TOTAL	:	16	
P17	PBC			EACH		17	
P18	S.EFF			REMAIN		18	
P19				○		19	
P20						20	
P21						S1	

PRINTED WIRING BOARD

1 2 3 4 5 6 7 8

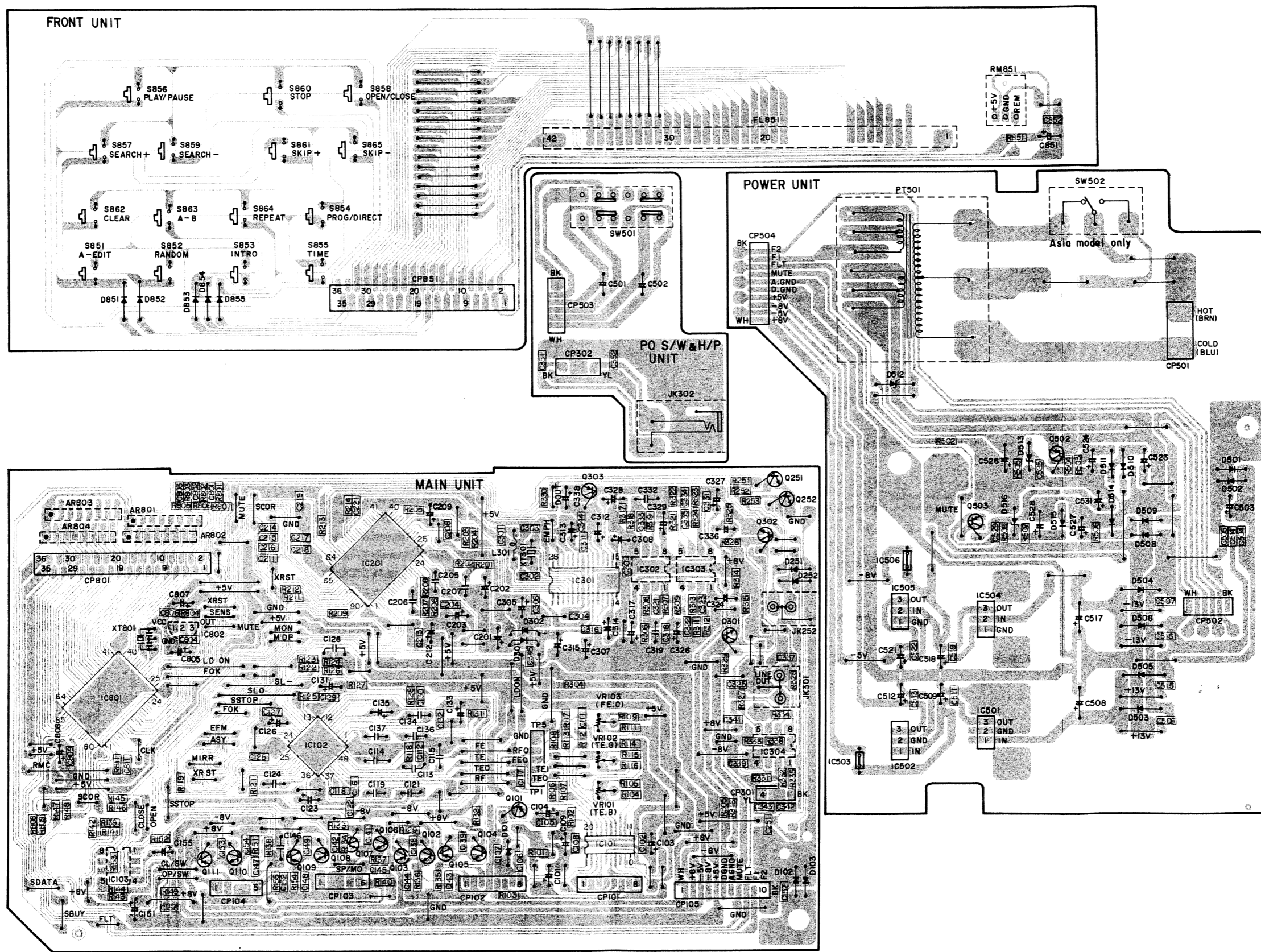

A
B
C
D
E

NOTE FOR PARTS LIST

- Part indicated with the mark "⊙" are not always in stock and possibly to take a long period of time for supplying, or in some case supplying of part may be refused.
- When ordering of part, clearly indicate "1" and "1" (l) to avoid mis-supplying.
- Ordering part without stating its part number can not be supplied.
- Part indicated with the mark "★" is not illustrated in the exploded view.
- Not including Carbon Film ±5%, 1/4W Type in the P.W.Board parts list. (Refer to the Schematic Diagram for those parts.)

WARNING:

Parts marked with this symbol  have critical characteristics. Use ONLY replacement parts recommended by the manufacturer.

● **Resistors**

Ex.: **RN** 14K **2E** 182 **G** **FR**
 Type Shape Power Resist- Allowable Error Others
 and performance ance error

RD : Carbon	2B : 1/8W	F : ±1%	P : Pulse-resistant type
RC : Composition	2E : 1/4W	G : ±2%	NL : Low noise type
RS : Metal oxide film	2H : 1/2W	J : ±5%	NB : Non-burning type
RW : Winding	3A : 1W	K : ±10%	FR : Fuse-resistor
RN : Metal film	3D : 2W	M : ±20%	F : Lead wire forming
RK : Metal mixture	3F : 3W		
	3H : 5W		

* **Resistance**
 $\overset{1}{\uparrow} \text{R} \overset{2}{\uparrow} \Rightarrow 1800 \text{ ohm} = 1.8 \text{ kohm}$
 Indicates number of zeros after effective number.
 2-digit effective number.
 • Units: ohm

$\overset{1}{\uparrow} \text{R} \overset{2}{\uparrow} \Rightarrow 1.2 \text{ ohm}$
 1-digit effective number.
 2-digit effective number, decimal point indicated by R.
 • Units: ohm

● **Capacitors**

Ex.: **CE** 04W **1H** 2R2 **M** **BP**
 Type Shape Dielectric Capacity Allowable Error Others
 and performance strength error

CE : Aluminum foil electrolytic	0J : 6.3V	F : ±1%	HS : High stability type
CA : Aluminum solid electrolytic	1A : 10V	G : ±2%	BP : Non-polar type
CS : Tantalum electrolytic	1C : 16V	J : ±5%	HR : Ripple-resistant type
CO : Film	1E : 25V	K : ±10%	DL : For change and discharge frequency
CK : Ceramic	1V : 35V	M : ±20%	HF : For assuring high frequency
CC : Ceramic	1H : 50V	Z : +80%	U : UL part
CP : Oil	2A : 100V	-20%	C : CSA part
CM : Mica	2B : 125V	P : +100%	W : UL-CSA type
CF : Metallized	2C : 160V	-0%	F : Lead wire forming
CH : Metallized	2D : 200V	C : ±0.25pF	
	2E : 250V	D : ±0.5pF	
	2H : 500V	= : Others	
	2J : 630V		

* **Capacity (electrolyte only)**
 $\overset{2}{\uparrow} \overset{2}{\uparrow} \overset{2}{\uparrow} \Rightarrow 2200\mu\text{F}$
 Indicates number of zeros after effective number.
 2-digit effective number.
 • Units: μF .

$\overset{2}{\uparrow} \text{R} \overset{2}{\uparrow} \Rightarrow 2.2\mu\text{F}$
 1-digit effective number.
 2-digit effective number, decimal point indicated by R.
 • Units: μF .

* **Capacity (except electrolyte)**
 $\overset{2}{\uparrow} \overset{2}{\uparrow} \overset{1}{\uparrow} \Rightarrow 2200\text{pF} = 0.0022\mu\text{F}$
 (More than 2) — Indicates number of zeros after effective number.
 2-digit effective number.
 • Units: pF.

$\overset{2}{\uparrow} \overset{2}{\uparrow} \overset{1}{\uparrow} \Rightarrow 220\text{pF}$
 (0 or 1) — Indicates number of zeros after effective number.
 2-digit effective number.
 • Units: pF.

• When the dielectric strength is indicated in AC, "AC" is included after the dielectric strength value.

PRINTED WIRING BOARD PARTS LIST MAIN UNIT ASS'Y

Ref. No.	Part No.	Part Name	Remarks
SEMICONDUCTORS GROUP			
IC101	960 0058 107	IC CXA1571M	
IC102	960 0058 204	IC CXA1372AQ	
IC103	265 0030 004	IC NJM4558DD	
IC201	262 1819 005	IC CXD2500BQ	
IC301	960 0058 301	IC PCM1712U	
IC302,303	265 0030 004	IC NJM4558DD	
IC304	263 0118 001	IC NJM4560D	
IC501	DCD 2150 416	IC GL7808	
IC502	DCD 2150 415	IC GL7805	
IC503	268 0073 905	IC protector ICP-N15	
IC504	263 0503 001	IC NJM7908FA	
IC505	960 0058 505	IC GL7905	
IC506	268 0073 905	IC protector ICP-N15	
IC801	960 0061 107	IC CXP82316-363Q	
IC802	DCD 2150 425	IC KIA7042P	
Q101	960 0005 105	Transistor KTA1266Y	
Q102	960 0010 705	Transistor KTC3205Y	
Q103	960 0010 501	Transistor KTA1273Y	
Q104	960 0010 705	Transistor KTC3205Y	
Q105	960 0010 501	Transistor KTA1273Y	
Q106	960 0010 705	Transistor KTC3205Y	
Q107	960 0010 501	Transistor KTA1273Y	
Q108	960 0010 705	Transistor KTC3205Y	
Q109	960 0010 501	Transistor KTA1273Y	
Q110	960 0010 705	Transistor KTC3205Y	
Q111	960 0010 501	Transistor KTA1273Y	
Q251,252	269 0020 906	Transistor DTC114ES	
Q301,302	S87 2990 550	Transistor DTC343TS	
Q303	269 0016 907	Transistor DTA144WS	
Q502,503	960 0005 105	Transistor KTA1266Y	
D101~103	276 0375 002	Diode 1N4148M	
D251,252	9H3 0000 251	Zener diode MTZJ5.6B	
D301,302	276 0375 002	Diode 1N4148M	
D501,502	276 0375 002	Diode 1N4148M	
D503~506	960 0058 709	Diode 1N4002A	
D508~511	276 0375 002	Diode 1N4148M	
D512	LA1 00C0 032	Zener diode MTZJ5.1B	
D513	9H3 0000 410	Zener diode MTZJ24B	
D514,515	276 0375 002	Diode 1N4148M	
RESISTORS GROUP (Not included carbon film ±5% 1/4W and chip type resistor)			
VR101,102	960 0057 700	Semi fixed 10kohm-B	
VR103	DCD 2150 408	Semi fixed 4.7kohm-B	
CAPACITORS GROUP (Not included ceramic chip type capacitor)			
C101	254 4254 938	Electrolytic 47 $\mu\text{F}/16\text{V}$	CE04W1C470M
C103,104	254 4252 037	Electrolytic 100 $\mu\text{F}/10\text{V}$	CE04W1A101M
C109	254 4252 037	Electrolytic 100 $\mu\text{F}/10\text{V}$	CE04W1A101M
C113	255 4223 988	Film 0.033 $\mu\text{F}/50\text{V}$	CQ92M1H333J(MRZ)
C114	255 4212 096	Film 0.1 $\mu\text{F}/50\text{V}$	CQ92M1H104J(MRZ)
C115	255 4199 070	Film 0.01 $\mu\text{F}/50\text{V}$	CQ92M1H103J
C119	255 4199 070	Film 0.01 $\mu\text{F}/50\text{V}$	CQ92M1H103J
C121	255 4199 070	Film 0.01 $\mu\text{F}/50\text{V}$	CQ92M1H103J
C123	254 4252 037	Electrolytic 100 $\mu\text{F}/10\text{V}$	CE04W1A101M
C124	255 4223 988	Film 0.033 $\mu\text{F}/50\text{V}$	CQ92M1H333J(MRZ)
C126	254 4252 037	Electrolytic 100 $\mu\text{F}/10\text{V}$	CE04W1A101M
C128	255 4199 070	Film 0.01 $\mu\text{F}/50\text{V}$	CQ92M1H103J
C131	254 4254 912	Electrolytic 22 $\mu\text{F}/16\text{V}$	CE04W1C220M
C133	254 4252 037	Electrolytic 100 $\mu\text{F}/10\text{V}$	CE04W1A101M
C134	255 4212 096	Film 0.1 $\mu\text{F}/50\text{V}$	CQ92M1H104J(MRZ)
C135	254 4260 074	Electrolytic 4.7 $\mu\text{F}/50\text{V}$	CE04W1H4R7M
C136	255 4223 988	Film 0.033 $\mu\text{F}/50\text{V}$	CQ92M1H333J(MRZ)
C137	255 4212 096	Film 0.1 $\mu\text{F}/50\text{V}$	CQ92M1H104J(MRZ)
C146	255 1134 009	Film 0.0022 $\mu\text{F}/50\text{V}$	CQ92M1H222J
C151	254 4254 941	Electrolytic 100 $\mu\text{F}/16\text{V}$	CE04W1C101M
C155	254 4254 941	Electrolytic 100 $\mu\text{F}/16\text{V}$	CE04W1C101M
C201,202	254 4260 016	Electrolytic 0.22 $\mu\text{F}/50\text{V}$	CW04W1HR22M
C203	254 4252 037	Electrolytic 100 $\mu\text{F}/10\text{V}$	CE04W1A101M
C205	255 1251 908	Film 0.0015 $\mu\text{F}/50\text{V}$	CQ92M1H152J(MRZ)
C206	255 4212 054	Film 0.047 $\mu\text{F}/50\text{V}$	CQ92M1H473J(MRZ)
C207	255 4199 070	Film 0.01 $\mu\text{F}/50\text{V}$	CQ92M1H103J
C209	254 4252 037	Electrolytic 100 $\mu\text{F}/10\text{V}$	CE04W1A101M
C212	254 4252 037	Electrolytic 100 $\mu\text{F}/10\text{V}$	CE04W1A101M
C305	254 4252 037	Electrolytic 100 $\mu\text{F}/10\text{V}$	CE04W1A101M
C307	254 4260 087	Electrolytic 10 $\mu\text{F}/50\text{V}$	CE04W1H100M
C308	254 4252 037	Electrolytic 100 $\mu\text{F}/10\text{V}$	CE04W1A101M
C312,313	254 4260 087	Electrolytic 10 $\mu\text{F}/50\text{V}$	CE04W1H100M
C314	254 4260 074	Electrolytic 4.7 $\mu\text{F}/50\text{V}$	CE04W1H4R7M
C315	254 4252 066	Electrolytic 470 $\mu\text{F}/10\text{V}$	CE04W1A471M
C317	254 4254 941	Electrolytic 100 $\mu\text{F}/16\text{V}$	CE04W1C101M

Ref. No.	Part No.	Part Name	Remarks
C319	255 1251 924	Film 0.0027 μ F/50V	CQ92M1H272J(MRZ)
C324	254 4260 074	Electrolytic 4.7 μ F/50V	CE04W1H4R7M
C326,327	254 4254 491	Electrolytic 100 μ F/16V	CE04W1C101M
C328	254 4260 074	Electrolytic 4.7 μ F/50V	CE04W1H4R7M
C329	254 4254 491	Electrolytic 100 μ F/16V	CE04W1C101M
C332	255 1251 924	Film 0.0027 μ F/50V	CQ92M1H272J(MRZ)
C336	254 4260 074	Electrolytic 4.7 μ F/50V	CE04W1H4R7M
C338	254 4260 087	Electrolytic 10 μ F/50V	CE04W1H100M
C501,502	254 3056 001	Electrolytic 0.47 μ F/50V	CE04D1HR47MBP
C503	254 4260 045	Electrolytic 1 μ F/50V	CE04W1H010M
C508	254 4256 091	Electrolytic 2200 μ F/25V	CE04W1E222M
C509	254 4254 941	Electrolytic 100 μ F/16V	CE04W1C101M
C512	254 4252 037	Electrolytic 100 μ F/10V	CE04W1A101M
C517	254 4256 091	Electrolytic 2200 μ F/25V	CE04W1E222M
C518	254 4254 941	Electrolytic 100 μ F/16V	CE04W1C101M
C521	254 4252 037	Electrolytic 100 μ F/10V	CE04W1A101M
C523,524	254 4258 057	Electrolytic 100 μ F/35V	CE04W1V101M
C526	254 4258 057	Electrolytic 100 μ F/35V	CE04W1V101M
C527	254 4260 087	Electrolytic 10 μ F/50V	CE04W1H100M
C528	254 4256 059	Electrolytic 220 μ F/25V	CE04W1E221M
C531	254 4260 087	Electrolytic 10 μ F/50V	CE04W1H100M
C805	254 4260 045	Electrolytic 1 μ F/50V	CE04W1H010M
C807,808	254 4252 037	Electrolytic 100 μ F/10V	CE04W1A101M
C851	254 4299 964	Electrolytic 47 μ F/16V	CE04W1C470M
OTHER PARTS GROUP			
XT301	960 0038 004	Crystal 16.9344MHz	CST4.19MGW
XT801	399 0107 007	Resonator 4.19MGW	
JK252	960 0004 407	Jack D3.5	HEADPHONE
JK301	960 0057 807	2P RCA jack	
JK302	960 0059 009	Jack D6.5	
L301	960 0007 365	Inductor 1 μ H	
FL851	960 0058 408	FL tube SVA-07MM03	
S851-865	DCD 2150 426	Tact switch	
SW501	960 0058 903	Push switch	POWER
Δ SW502	960 0062 407	Slide switch	Asia model only
Δ FT501	960 0061 505	Power transformer	Europe and U.K. models
Δ FT501	960 0061 204	Power transformer	U.S.A. and Canada models
Δ FT501	960 0060 302	Power transformer	Asia model
CP501	960 0058 602	2P connector	
CP504	960 0058 615	10P connector	
CP801	960 0057 904	36P FPC connector	

PARTS LIST OF EXPLODED VIEW CHASSIS AND CABINET

Ref. No.	Part No.	Part Name	Remarks	Q'ty	Ref. No.	Part No.	Part Name	Remarks	Q'ty
1	960 0056 808	Display window		1	L1	—	Caution label	Europe model	1
2	960 0056 905	Power button		1	L2	—	Preset label	Asis model	1
3	960 0056 109	Front panel	DCD-425	1	L3	—	Serial No. label		1
3	960 0062 009	Front panel	DCD-335	1	L4	—	Date code label	U.S.A. and Canada models	1
4	—	Power sw P.W.B. Ass'y		1	L5	—	Label, Korea	Asia model	1
5	DCD 2150 911	Center plate		1					
6	960 0056 701	Tray cover		1		960 0061 408	P.W.B. unit total Ass'y	Europe and U.K. models	1
7	960 0056 206	Main chassis		1		960 0061 000	P.W.B. unit total Ass'y	U.S.A. and Canada models	1
8	960 0059 106	Mecha Ass'y		1		960 0060 205	P.W.B. unit total Ass'y	Asia model	1
9	—	Power P.W.B. Ass'y		1					
10	960 0061 602	Rear panel	DCD-425 Europe model	1					
10	960 0062 106	Rear panel	DCD-335 Europe model	1					
10	960 0061 806	Rear panel	U.K. model	1					
10	960 0060 506	Rear panel	U.S.A. and Canada models	1					
10	960 0060 001	Rear panel	Asia model	1					
△	DCD 2150 206	AC cord stopper		1					
△	960 0034 707	AC cord	Europe and Asia models	1					
△	960 0061 708	AC cord	U.K. model	1					
△	960 0060 409	AC cord	U.S.A. and Canada models	1					
13	960 0056 604	Top cover		1					
14	DCD 2150 215	PWB supporter		2					
15	960 0057 001	Function button		1					
16	—	Front P.W.B. Ass'y		1					
17	960 0056 002	Flat cable		1					
18	960 0056 507	Cushion		4					
19	960 0056 400	Foot	Front	2					
20	960 0060 603	Foot	Rear	2					
21	—	Main P.W.B. Ass'y		1					
22	—	Cushion	P.W.B.	1					
24	DCD 2150 912	Plate		1					
25	960 0058 602	2P connector	CP501	1					
△	960 0061 505	Power transformer	Europe and U.K. models	1					
△	960 0061 204	Power transformer	U.S.A. and Canada models	1					
△	960 0060 002	Power transformer	Asia model	1					
27	960 0058 615	10P connector	CP504	1					
29	960 0057 807	2P RCA jack	JK301	1					
30	960 0004 407	Jack D3.5	JK252	1					
31	960 0057 904	36P FPC connector	CP801	1					
32	960 0050 105	Remocon senser	RM851	1					
33	960 0058 408	FL tube SVA-07MM03	FL851	1					
34	960 0058 903	Push switch	SW501	1					
35	960 0059 009	Jack D6.5	JK302	1					
S1	DCD 2150 901	3x6 tapp screw		5					
S2	960 9000 211	3x15 tapp screw		2					
S3	DCD 2150 903	3x8 special screw		12					
S4	DCD 2150 904	3x8 special screw	Except Asis model	19					
S4	DCD 2150 904	3x8 special screw	Asis model	21					
S5	DCD 2150 906	3x10 special screw		7					
S6	960 9000 169	4x8 special screw		2					
S7	DCD 2150 908	3x8 w/screw		1					
S8	960 9002 316	3x8 special w/screw		2					

EXPLODED VIEW OF CHASSIS AND CABINET

1 2 3 4 5 6 7 8

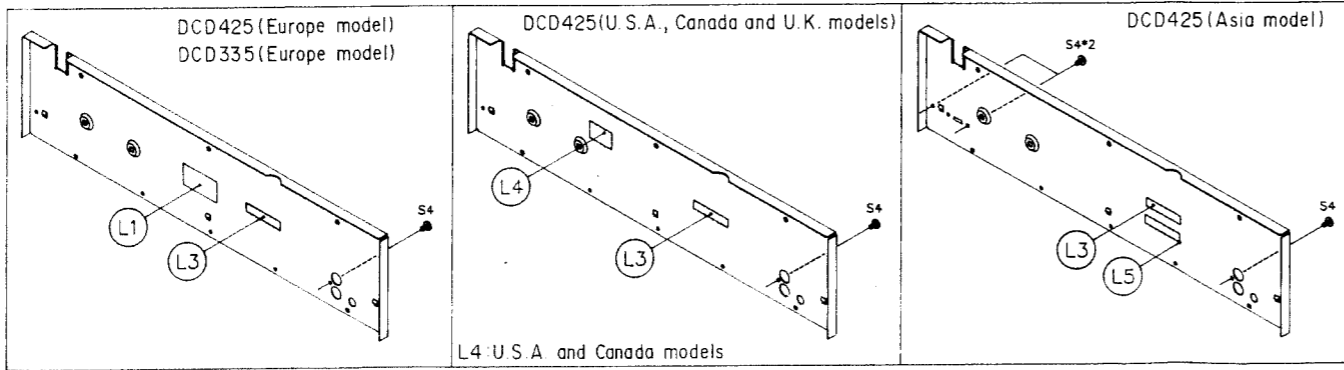
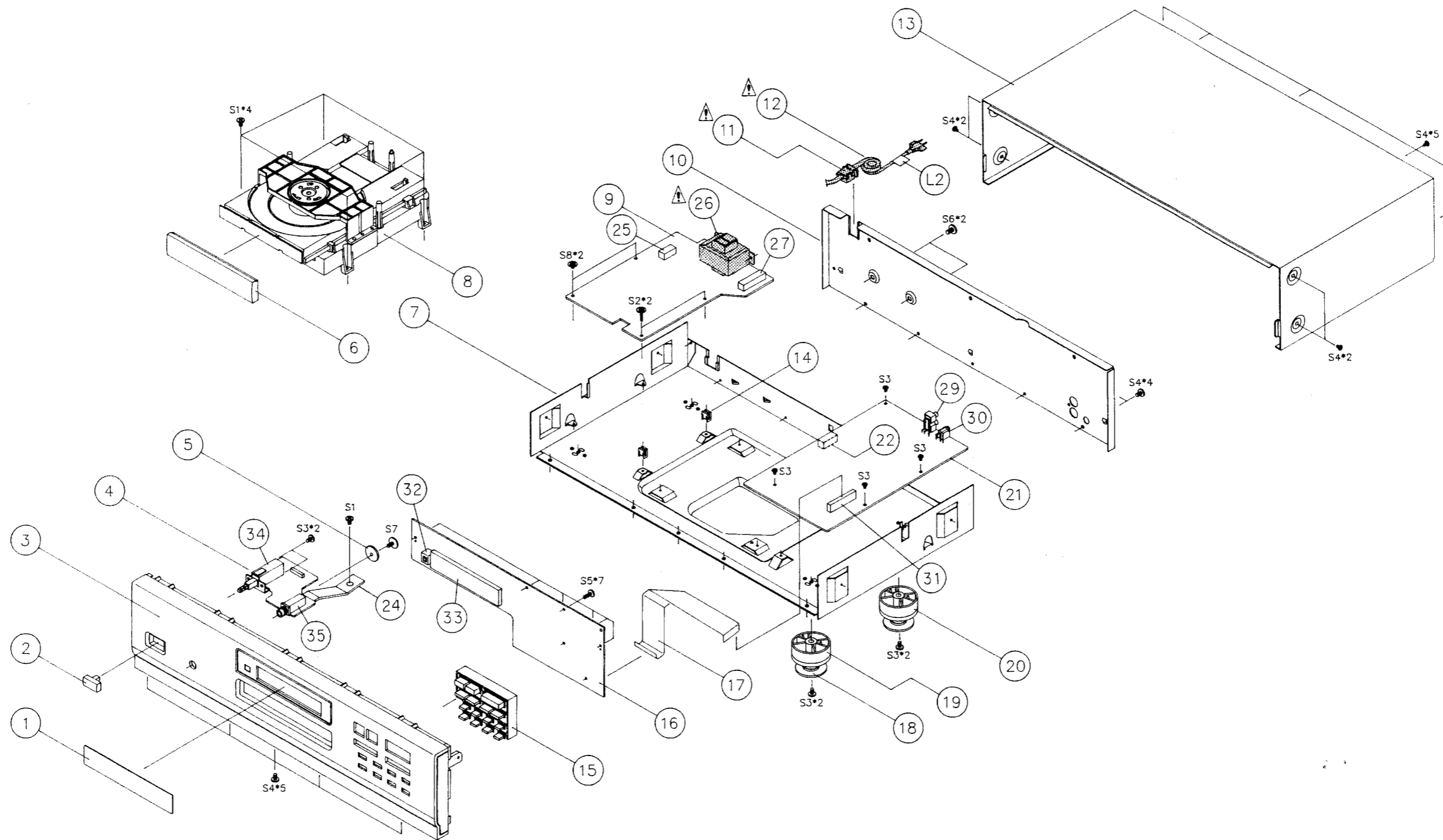

A
B
C
D
E

EXPLODED VIEW OF CD MECANISM

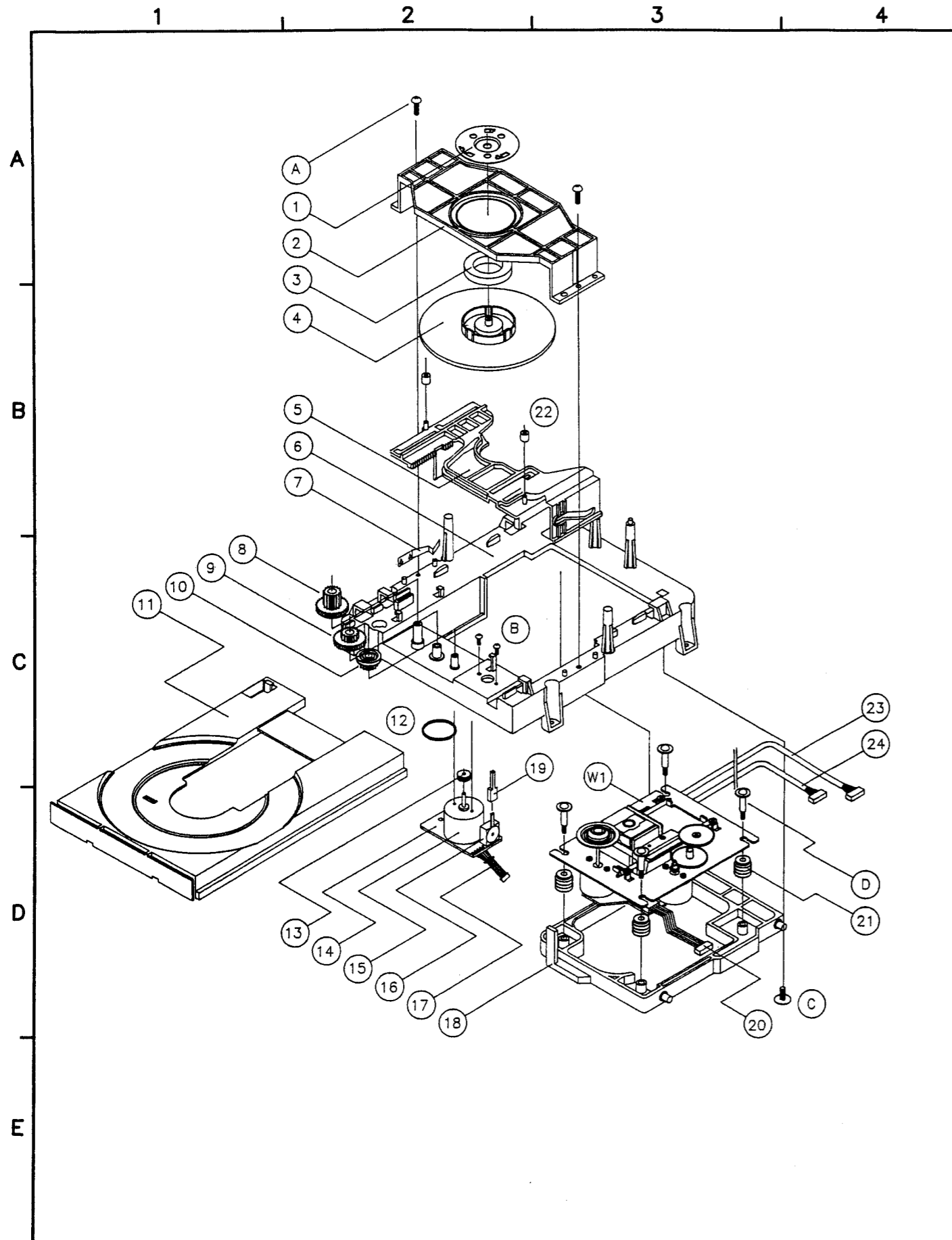

PARTS LIST OF CD MECHANISM

Ref. No.	Part No.	Part Name	Remarks	Q'ty
1	DCD 2150 311	Clamper plate		1
2	DCD 2150 315	Flapper		1
3	960 0059 708	Magnet core		1
4	960 0059 601	Disc clamper		1
5	960 0059 504	Guide frame		1
6	960 0059 407	Mecha base		1
7	DCD 2150 316	Rack spring		1
8	DCD 2150 308	Load gear		1
9	DCD 2150 305	Center gear		1
10	DCD 2150 306	Pully gear		1
11	960 0059 300	Tray		1
12	DCD 2150 314	Belt		1
13	DCD 2150 310	Motor pulley		1
14	DCD 2150 323	Motor P.W.B. Ass'y		1
15	DCD 2150 322	DC motor		1
16	960 0041 703	Leaf switch		1
17	960 0045 110	5P wire		1
18	DCD 2150 303	Feed frame		1
19	DCD 2150 309	Switch holder		1
20	960 0045 107	6P wire		1
21	DCD 2150 312	Insulator		4
22	DCD 2150 330	Rubber stopper		2
23	960 0045 217	SH connector Ass'y		1
24	960 0059 203	SH connector Ass'y		1
A	DCD 2150 319	3x10 screw		2
B	960 9002 332	2.6x5 screw		2
C	DCD 2150 321	3x8 screw		1
D	960 9002 329	Mecha screw		4
W1	960 0038 703	Feed mecha Ass'y	KSM2101ADM	1
	499 0171 003	Optical pickup	KSS210A	1

BLOCK DIAGRAM

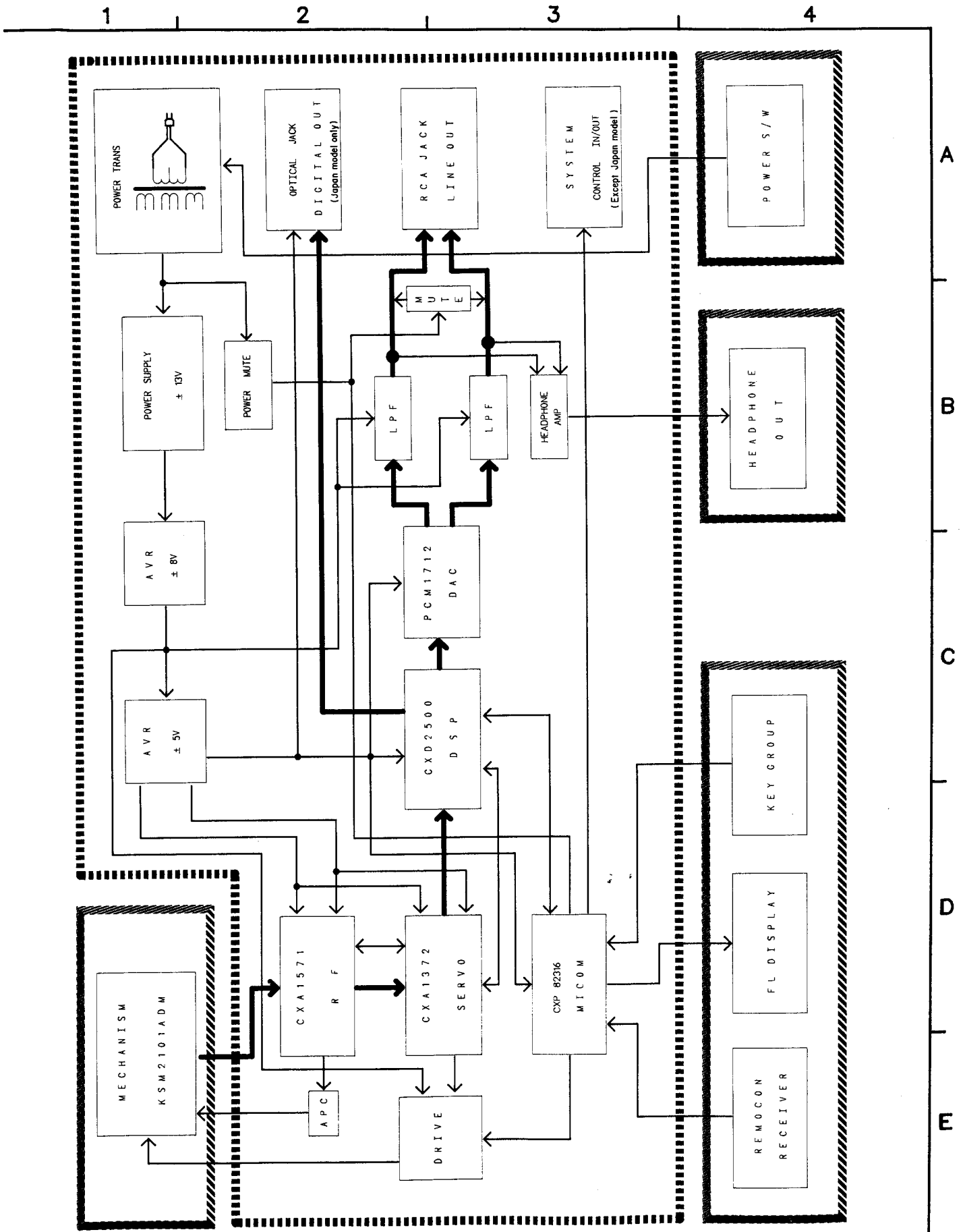

WIRING DIAGRAM

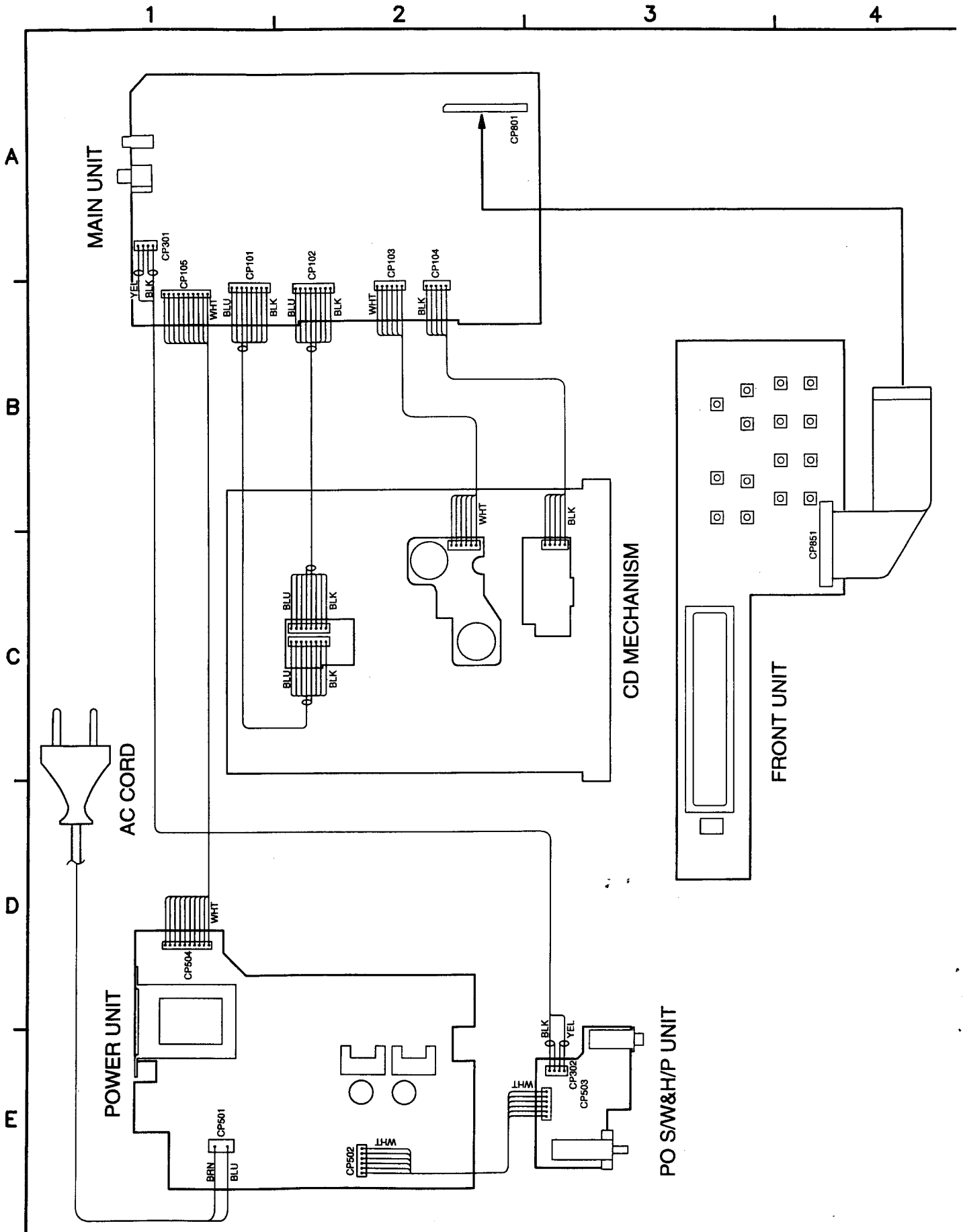

PARTS LIST OF ACCESSORIES AND PACKING VIEW

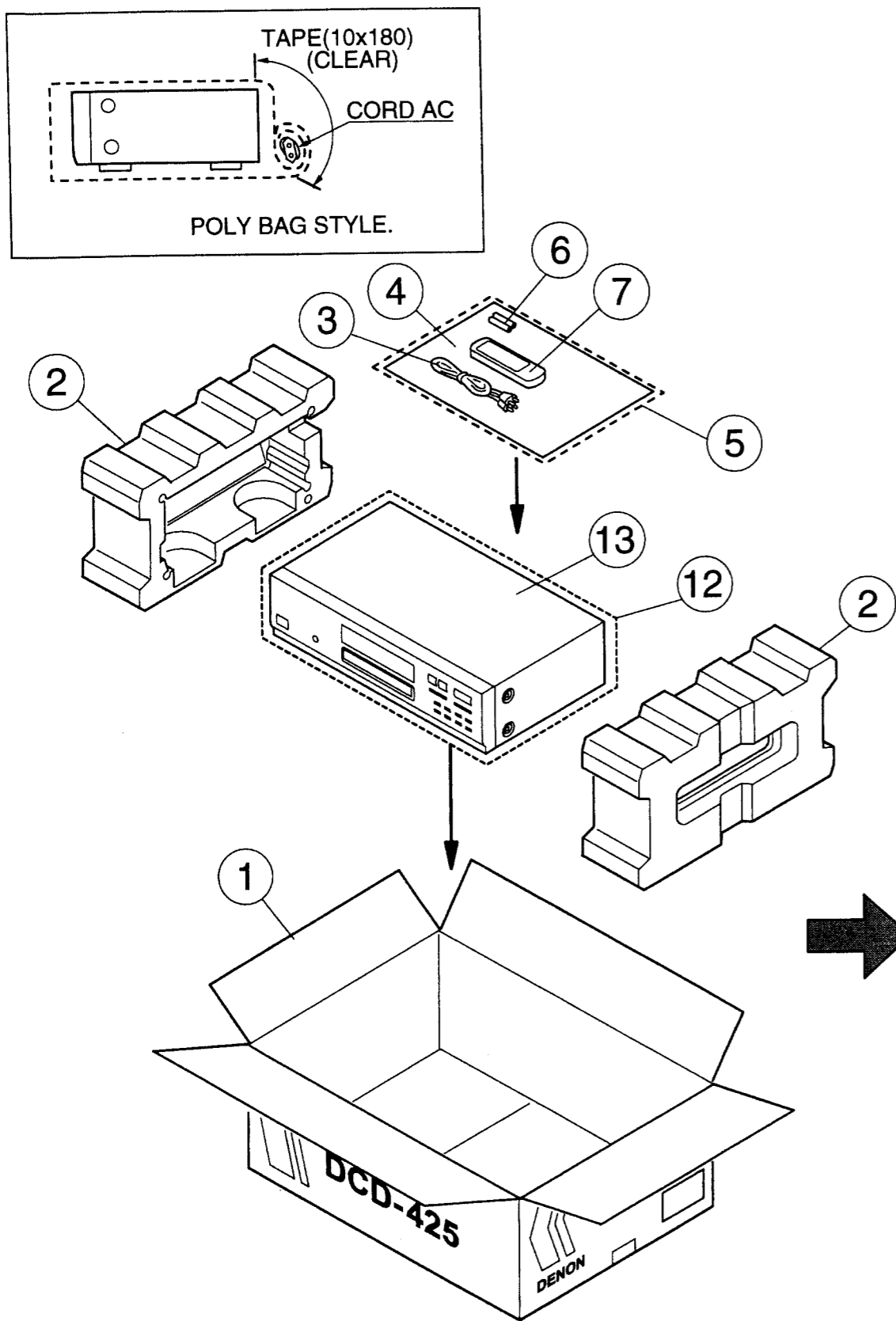

PARTS LIST

Ref. No.	Part No.	Part Name	Remarks	Q'ty	Ref. No.	Part No.	Part Name	Remarks	Q'ty
1	960 0060 904	Carton box	DCD-425 Except Asia model	1	9	—	Card, Envelope	U.S.A. model	1
1	960 0060 807	Carton box	Asia model	1	10	—	Card, Warranty	U.S.A. model	1
1	960 0062 300	Carton box	DCD-335	1	11	—	Card, Registration	U.S.A. model	1
2	960 0057 506	Cushion		1s	12	—	Poly bag set		1
3	960 0031 108	RCA cord		1	13	—	Set		1
4	960 0061 301	Inst. manual	Europe model	1	14	—	Label, UPC	U.S.A. and Canada models	1
4	960 0061 903	Inst. manual	U.K. model	1	15	—	Label, Control		2
4	960 0060 700	Inst. manual	U.S.A. and Canada models	1	16	—	Label, Korea	Asia model	1
4	960 0060 108	Inst. manual	Asia model	1					
5	505 0099 024	Poly bag	260x380	1					
6	—	Battery, R03NE(1.5V) AAA	DCD-425 only	2					
7	960 0057 302	Remote controller	DCD-425 only	1					

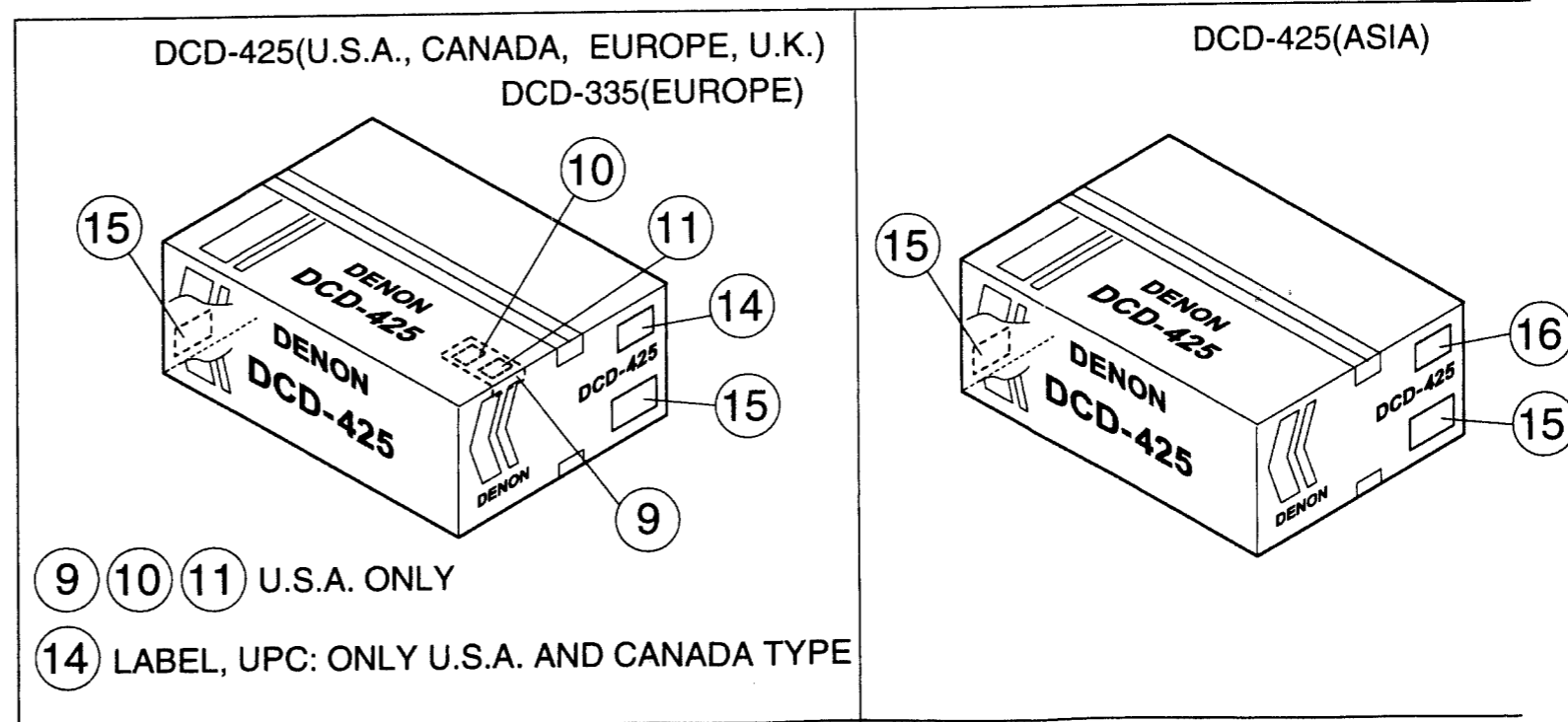

NOTE:

SCHEMATIC DIAGRAM

1

2

3

4

5

6

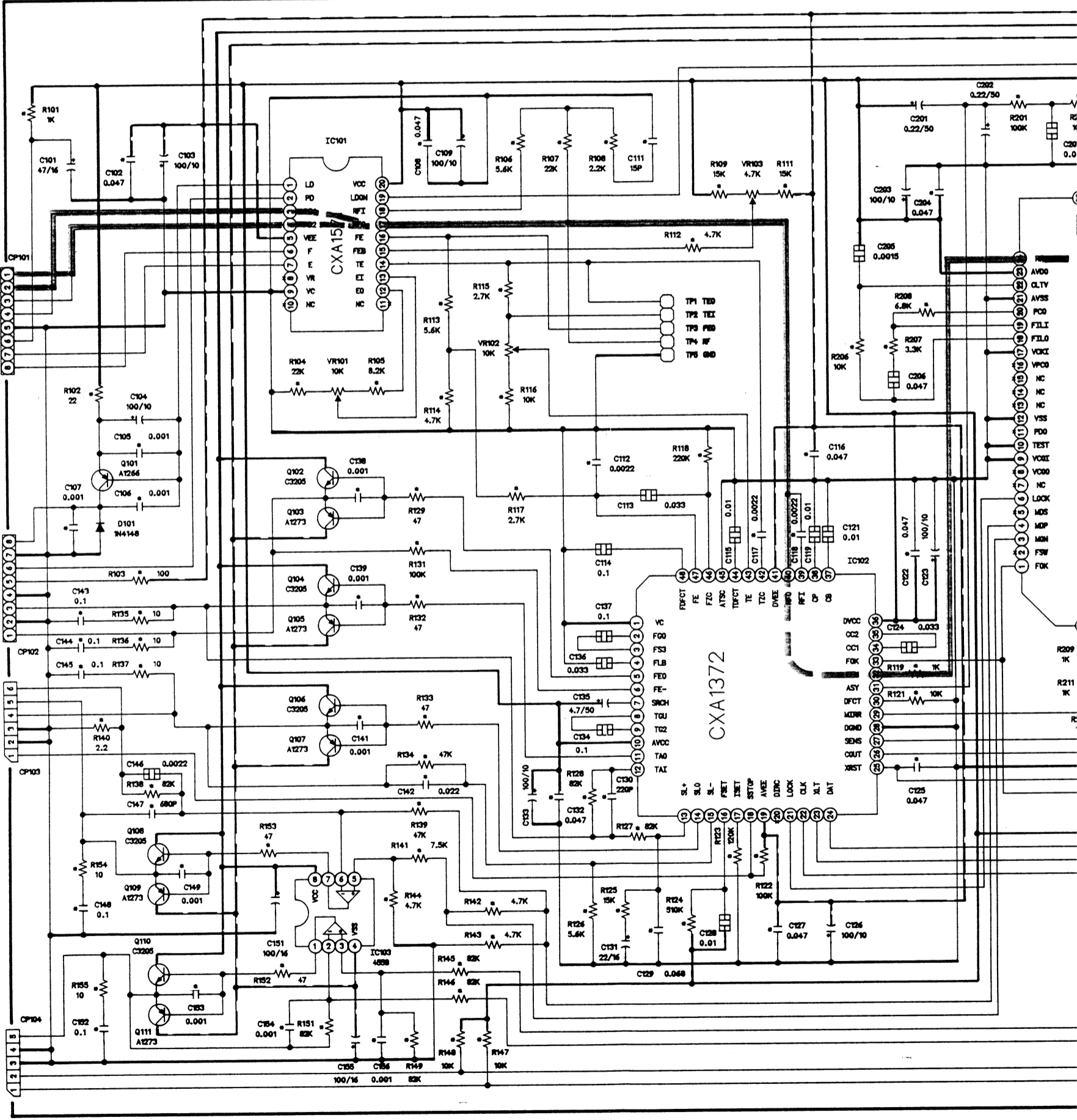
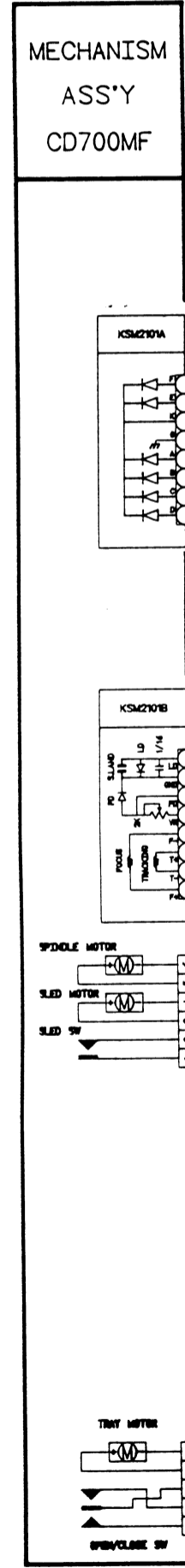
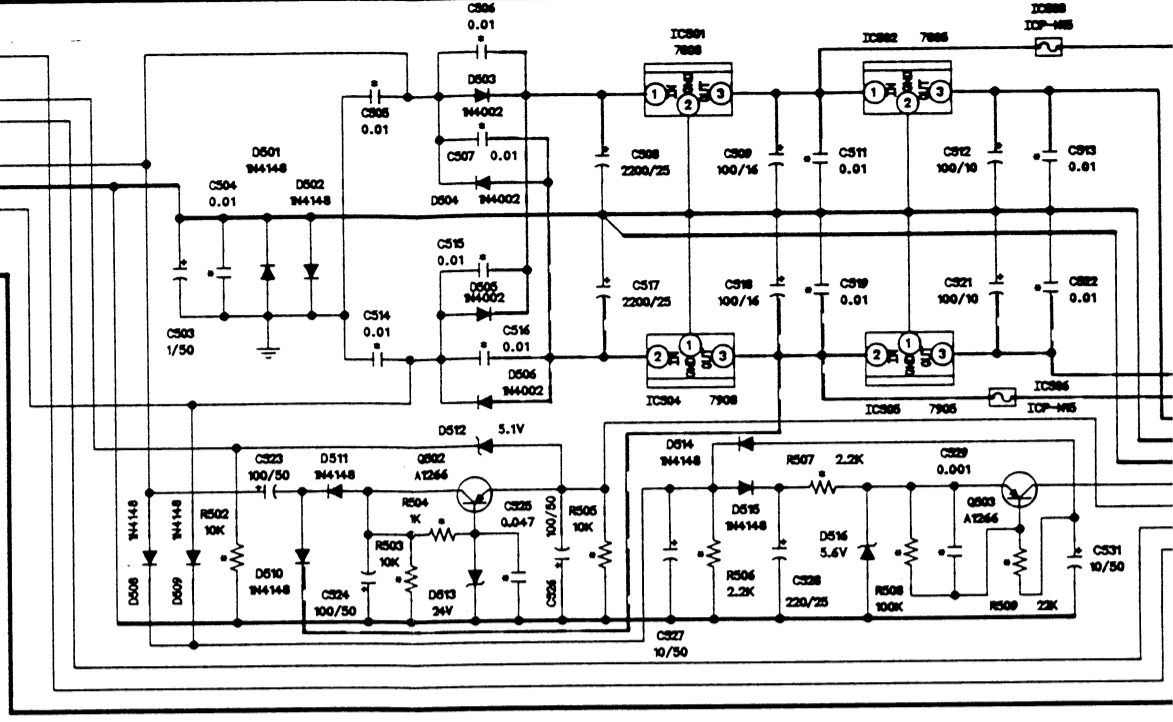
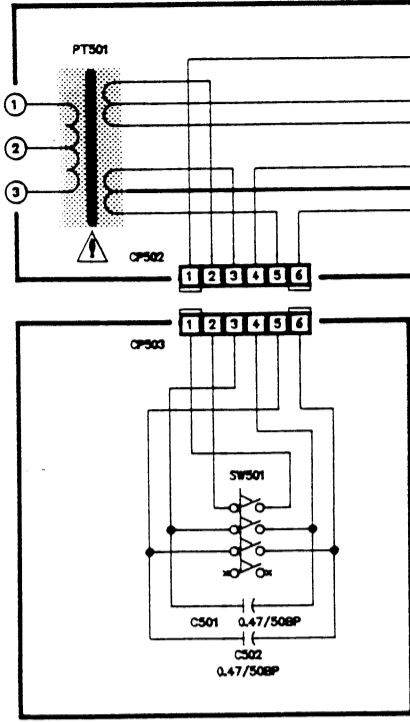
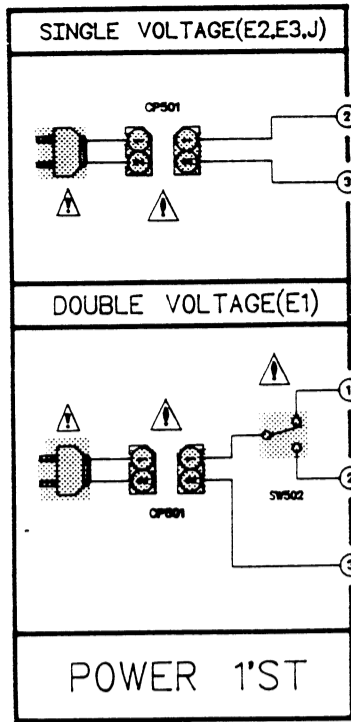

NOTES
 ALL RESISTANCE VALUES IN OHM. k=1,000 OHM, M=1,000,000 OHM
 ALL CAPACITANCE VALUES IN MICRO FARAD. P=MICRO-MICRO FARAD
 EACH VOLTAGE AND CURRENT ARE MEASURED AT NO SIGNAL INPUT CONDITION.
 CIRCUIT AND PARTS ARE SUBJECT TO CHANGE WITHOUT PRIOR NOTICE.

WARNING:
 Parts marked with this symbol have critical characteristics. Use ONLY replacement parts recommended by the manufacturer.

CAUTION:
 Before returning the unit to the customer, make sure you make either (1) leakage current check or (2) a line to chassis resistance check. If the leakage current exceeds 0.5 milliamperes, or if the resistance from chassis to either side of the power cord is less than 240 kohms, the unit is defective.

WARNING:
 DO NOT return the unit to the customer until the problem is located and corrected.

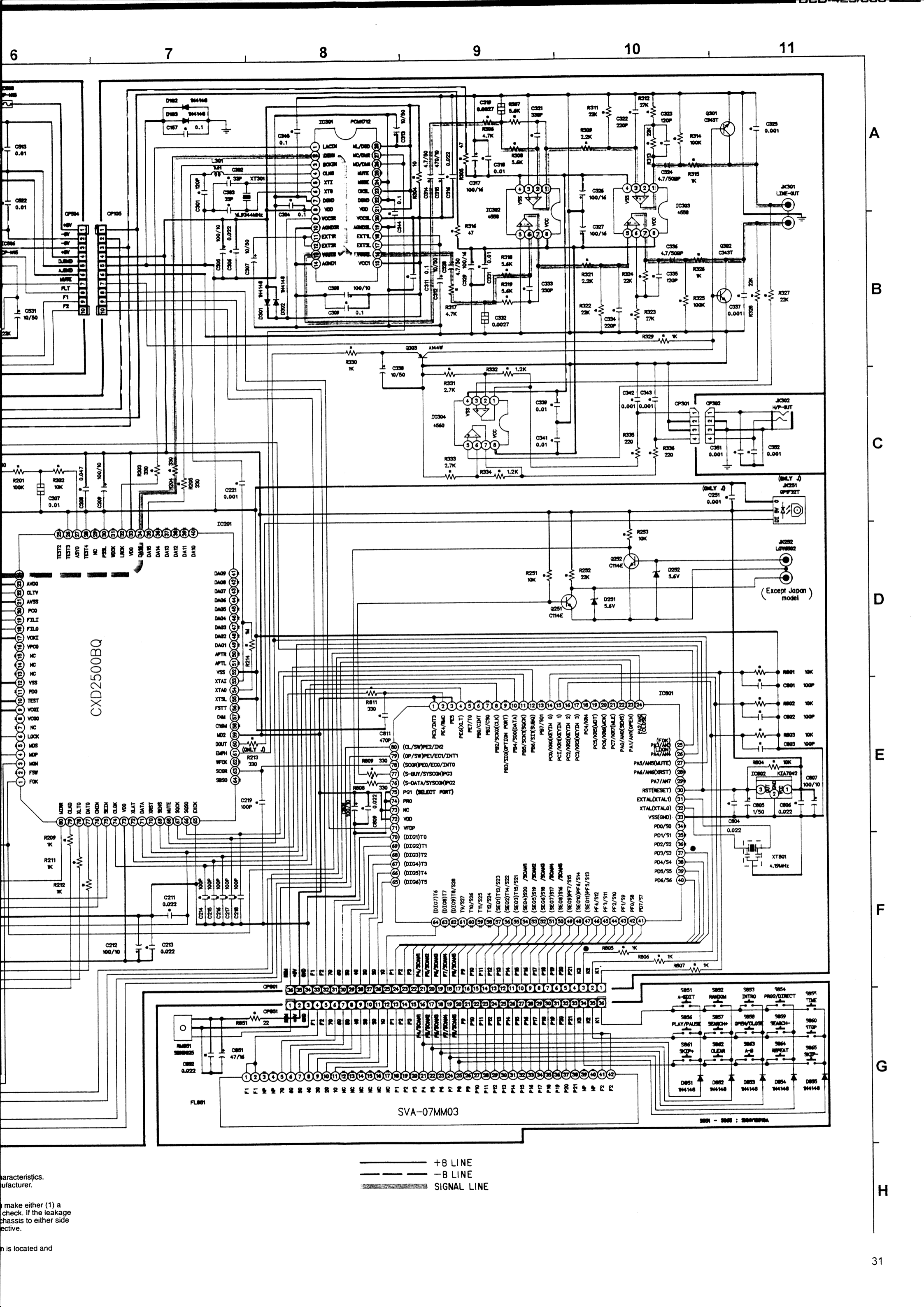

CXD2500BQ

SVA-07MM03

— +B LINE
 - - - -B LINE
 SIGNAL LINE

Characteristics.
 manufacturer.
 make either (1) a
 check. If the leakage
 chassis to either side
 effective.

is located and

A
 B
 C
 D
 E
 F
 G
 H