

DENON

Hi-Fi Component

FOR EUROPE AND U.K. MODELS

SERVICE MANUAL

MODEL DCD-715

MODEL DCD-615

STEREO CD PLAYER

For Service Manuals Contact
MAURITRON TECHNICAL SERVICES
8 Cherry Tree Rd, Chinnor
Oxon OX9 4QY
Tel: 01844-351694 Fax: 01344-352554
Email: enquiries@mauritron.co.uk

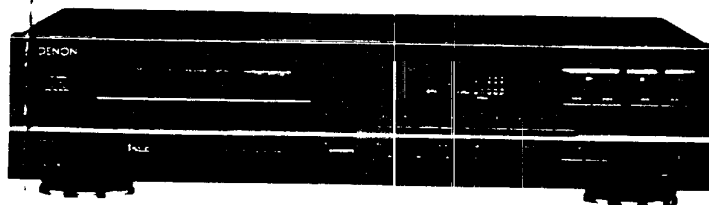

(Photo : DCD-715)

— TABLE OF CONTENTS —

OPERATING INSTRUCTIONS	2 - 7
SPECIFICATIONS	8
NOTE FOR HANDLING OF LASER PICK-UP	9, 10
DISASSEMBLY	11
ADJUSTMENT	12 - 15
HEAT RUN MODE FUNCTION	16
IC TERMINAL FUNCTION	17 - 20
PARTS LIST OF P.W.BOARD	21
PARTS LIST OF PACKING & ACCESSORIES	22
PARTS LIST OF EXPLODED VIEW (Europe and U.K.)	22
EXPLODED VIEW	23
PARTS LIST OF FG-74 MECHANISM UNIT	24
EXPLODED VIEW OF FG-74 MECHANISM UNIT	24
P.W.BOARD	25
WIRING DIAGRAM	26
SEMICONDUCTORS	27, 28
SCHEMATIC DIAGRAM	29, 30

NIPPON COLUMBIA CO., LTD.

FRONT PANEL
FRONTPLATTE
Panneau AVANT
Pannello FRONTALE

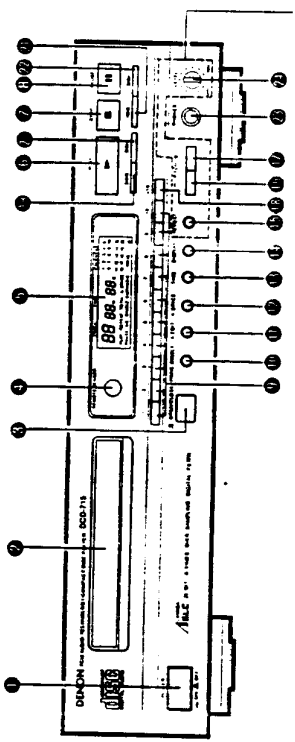

DCD-715 only
our best
DCD-715 set
sold with DCD-715
sold with DCD-715
sold with DCD-715
sold with DCD-715
sold with DCD-715

REAR PANEL
RUCKWAND
Panneau ARRIERE
IL PANNELLO POSTERIORE

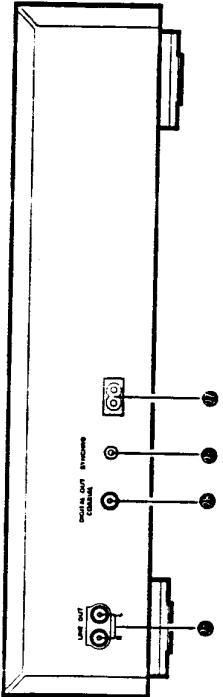

Thank you for purchasing this DENON Compact Disc Player. Please read the operating instructions thoroughly in order to acquaint yourself with the CD player and achieve maximum satisfaction from it.

— TABLE OF CONTENTS —

FEATURES 5
 NAMES AND FUNCTIONS OF PARTS 6, 7
 CONNECTION AND CLOSING THE DISC HOLDER AND LOADING A DISC 7, 8
 NORMAL CD PLAYBACK 8
 ADVANCED CD PLAYBACK 9
 TIMER CONTROLLED PLAYBACK 9 - 11
 THE COMPACT DISC 11
 PLAYBACK USING THE REMOTE CONTROL UNIT 12, 13
 INSTALLATION PRECAUTIONS 14
 TROUBLESHOOTING 14

Please check to make sure the following items are included with the main unit in the carton:
 (1) Operating Instructions 1
 (2) Connection Cord 1
 (3) Remote Control Unit RC-241 1
 (4) R603AAA Dry Cell Battery 2
 (5) AC Cord 1

FEATURES

The DCD-715/615 Compact Disc Player incorporates DENON's Super Linear Converter which prevents deterioration of sound quality in PCM playback systems. This assures accurate reproduction of the digital signals recorded on compact discs no matter whether they are pure studio recordings or "live" performance recordings. All parts making up this CD player have selected with the greatest care in order to produce high quality realistic playback of the full musical content on compact discs.

- (1) Double Super Linear Converter
 The use of Denon's unique system and D/A converters with excellent resolution to prevent zero cross distortion, the main cause of reduced sound quality in the PCM playback system, make for sound field reproduction with rich musical expression.
- (2) High Performance Digital Filter
 The DCD-715/615 uses independent D/A converters for the left and right channels and an 8x oversampling high precision digital filter to bring out the best of the analog filter and offer clear, crisp sound.
- (3) Simple Playback of 8cm CD Singles
 8cm CD singles can be played without using an adaptor.
- (4) Wireless Remote Control Accessory
 In addition to general operations such as Play, Stop and Pause, this remote control unit enables direct selection, direct programming, and other functions. Use of the remote control unit adds greatly to the operating ease of the DCD-715/615, enhancing its outstanding features.
- (5) Synchronised Recording Function
 Connect the SYNCHRO jacks with a DENON cassette deck which is equipped with a SYNCHRO jack, then make a synchronised recording.

For Service Manuals Contact
 MAURITRON TECHNICAL SERVICES
 8 Cherry Tree Rd. Chinnor
 Oxon OX9 4QY
 Tel: 01844-351694 Fax: 01844-352554
 Email: enquiries@mauritron.co.uk

NAMES AND FUNCTIONS OF PARTS

- 1 Power Switch (POWER)**
 - When the power is turned on, "1:00" appears on the TRACK NO. display and if no disc is loaded, "00000" appears on the digital display.
 - If the power is turned on with a disc already loaded, the number of tracks on the disc is displayed on the TRACK NO. display, the total time is displayed on the TIME display, and the numbers on the music-calendar light go up to the number of tracks on the disc, and playback begins.
 - Whenever the power switch is in the OFF state the apparatus is still connected on AC line voltage. Please be sure to unplug the cord when you leave home for safety's sake.
- 2 Disc Holder**
 - Place the disc on the disc holder with the label facing up.
 - Use the open/close button (▶ OPEN/CLOSE) to open and close the disc holder.
 - The disc holder may also be closed by pressing the play button (▶ PLAY) or pause button (⏸ PAUSE).
- 3 Open/Close Button (▶ OPEN/CLOSE)**
 - The disc holder is opened and closed by pressing this button.
 - When the disc holder is open, the disc holder and disc will rotate for a couple of seconds while the disc contents are read. The number of tracks and total playback time on the disc are then displayed on the digital display.
- 4 Remote Control Sensor (REMOTE SENSOR)**
 - The sensor receives the infrared light transmitted from the wireless remote control unit.
 - For remote control, point the supplied remote control unit RC 241 towards this sensor.
 - When a signal is transmitted from the remote control unit, the remote control indicator in the display will light up briefly.
- 5 Display**
 - The digital display is divided into sections, such as displays for track number, playback time and calendar, as shown below.

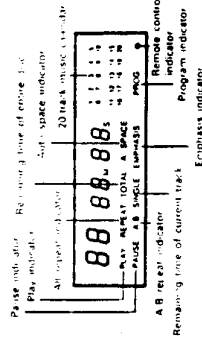

- 6 Play Button (▶ PLAY)**
 - Press this button to start playback of a disc.
 - When this button is pressed, [PLAY] is displayed, and the track number being played is displayed together with the elapsed playback time of the track.
 - Tracks are shown on the calendar display. Once a track has been played, the corresponding track number goes out on the calendar display.

- 7 Stop Button (■ STOP)**
 - Press this button to stop playback.
 - The disc will stop rotating, and the number of tracks and total playing time of the disc are displayed on the TRACK NO. and TIME displays respectively.
 - In case programmed playback is engaged when this button is pressed, the number of tracks and total playing time of the program are displayed.
- 8 Pause Button (⏸ PAUSE)**
 - Press this button to stop playback temporarily.
 - If this button is pressed during playback, playback is stopped temporarily, the [PAUSE] indicator goes out and the [PAUSE] indicator lights.
 - Press this button or the play button (▶ PLAY) again to continue playback.
- 9 Number Buttons (1, 2, 3, 4, 5, 6, 7, 8, 9 and 10)**
 - Use these buttons for the direct search and program memory functions.
 - For direct search, press, for example, button [4]. If you want to hear track number 4, for track number 4, press [4] then [▶]. To program tracks, press the PROG/DIRECT button to set to the program mode.
- 10 Program Button (PROG/DIRECT)**
 - Press this button when you want to enter tracks for programmed playback. (Refer to page 3, 10 for details.)
- 11 Auto Edit Button (A EDIT)**
 - The tracks on a CD are automatically split into two halves, Side A and Side B, like an analog disc, with the division at the place between tracks which is closest to 1/2 the total playing time, and with the tracks remaining in the same order.
 - When this button is pressed in the stop mode, the total playing time for the first half and the track numbers on the calendar are displayed for approximately 2 seconds. Next, the same is done for the second half. After that, the unit is automatically set to the pause mode. At the beginning of the first track, playback begins, and the unit is automatically set to the pause mode at the beginning of the first track of the second half which was previously displayed. When the PLAY or PAUSE button is pressed again, playback begins, and the unit is automatically set to the stop mode at the end of the last track on the disc.
 - This function will only work for discs with a total of 20 tracks or less. Also, when this function is used, the mode is automatically set to the program mode, so direct search is not possible.
 - The auto edit function is cleared when the STOP button is pressed.
 - The disc for the total playing time recorded on the disc and the actual total playing time of the tracks differ, so there may be a difference between the time displayed in the stop mode (the total playing time) and the total of the times of the first and second halves in the auto edit mode (about 2 seconds).

- 12 Auto Space Button (A SPACE)**
 - Pressing this button will cause the [A SPACE] indicator to light and a blank space of approximately 4 seconds is inserted between tracks during CD playback. Pressing this button more than once during CD playback will cancel the Auto Space feature.
 - When one of the track search buttons ([4] or [▶]) is pressed, the Auto Space function will not operate.
 - The Auto Space function will operate during normal playback as well as programmed playback.
 - Although 4 second blanks are inserted between tracks, this additional time is not reflected by the indication on the time remaining display or time display when the Auto Edit function is engaged.
- 13 Time Mode Button (TIME)**
 - This button is used to select the desired indication on the TIME display. The indication on this display will change each time the button is pressed.
 - Normally, the elapsed playback time of the current track is displayed. Pressing the button once, [SING.] is displayed and the remaining time of the track is displayed.
 - Pressing once more, [TOTAL] is displayed, and total playing time of remaining tracks is displayed. However, when programmed play is in progress, the total remaining time of the program is displayed.
 - Press the button once again to return to the normal display of the elapsed playback time of the current track.
- 14 Display Button (DISPLAY)**
 - Press this button to turn off (or turn on) the display.
 - One press of this button during play will turn off the display, in conditions other than the play mode, only the track number will be displayed.
 - Pressing the button once more will provide a return to the regular display.
- 15 Repeat Button (REPEAT) (DCD-715 only)**
 - Press this button to repeat playback of all tracks.
 - When this button is pressed, [REPEAT] lights on the display and all tracks on the disc or in a program will be repeatedly played back. Press this button once more to disengage the Repeat All function.
- 16 Pitch - Button (PTCH -) (DCD-715 only)**
 - Press this button to slow down the playing speed. (Refer to Page 11.)
- 17 Pitch + Button (PTCH +) (DCD-715 only)**
 - Press this button to make the playing speed faster. (Refer to Page 11.)
- 18 +10 Button (+10)**
 - Use it together with the number buttons. For example, to select track number 15, press [15] then [10].
 - Track number 33, press [33] three times, then press [10].
- 19 Automatic Search Reverse Button ([44])**
 - Press this button to return the pickup to the beginning of the present track. Press again to return to other tracks.
 - By pressing the button a number of times, the pickup will move back the corresponding number of tracks.
- 20 Automatic Search Forward Button ([▶▶])**
 - Press this button to move the pickup forward to the beginning of the next track. Press again to move ahead to other tracks.
 - By pressing the button a number of times, the pickup will advance the corresponding number of tracks.

- 21 Manual Search Reverse Button (◀)**
 - Press this button to start playback for fast reverse search. As long as the button is kept pressed, music signals are played back faster than normal.
 - Pressing this button when the pause mode is engaged, you can quickly reverse the pickup to a desired position, three times faster compared to manual reverse search during playback. During this time, no sound is heard.
- 22 Manual Search Forward Button (▶▶)**
 - Press this button during playback for fast forward search. As long as the button is kept pressed, music signals are played back faster than normal.
 - Pressing this button when the pause mode is engaged, you can quickly forward the pickup to a desired position, three times faster compared to manual forward search during playback. During this time, no sound is heard.
- 23 Headphones Jack (PHONES)**
 - For private listening, you can connect your headphones to this jack. Do not raise the volume level too much when listening through headphones. (Headphones are sold separately.)
- 24 Volume Control (PHONES LEVEL) (DCD-715 only)**
 - Use this to adjust the output level of the headphones.
- 25 Output Terminal (LINE OUT)**
 - Connect these jacks to the input jacks on your amplifier. (Refer to page 7 for details on the connections.)
- 26 SYNCHRO Jack**
 - To make a synchronized recording, this jack must be connected to the SYNCHRO output of the deck with a connection cord. (See Page 8 for connections.)
- 27 AC INLET**
 - Connect the included AC cord here.
- 28 Digital Output Jack (COAXIAL)**
 - This jack outputs digital data.
 - We recommend using a 75-ohm pin cord (available in stores) for connections.

Continuous Button Operation
If the automatic search reverse button or the automatic search forward button or the +10 button are held in, the function of that button will be repeated.

CONNECTION

- 1) Connecting the Output Terminal (LINE OUT)**
Use the included pin cords to connect the left (L) and right (R) channels (LINE OUT) of the DCD-715/615 to the CD, AUX, or TAPE PLAY (L) and right (R) input jacks of the amplifier.

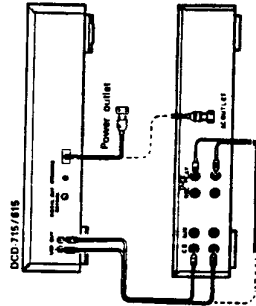

OPENING AND CLOSING THE DISC HOLDER AND LOADING A DISC

- Opening and closing the disc holder (This operation only works when the power is on)
- 1 Press the power switch (POWER) to turn on the power.
 - 2 Press the open/close button (OPEN/CLOSE)

How to load a disc

- Make sure the disc holder is completely open
- Hold the disc by the edges and place it on the disc tray (Do not touch the signal surface, i.e. the shiny side)
- When using 12 cm diameter discs, make sure the tray guide matches the tray guide circumference (Fig. 1) and the outer edge of CD singles (8 cm diameter) match the outer edge with the inner tray guide circumference (Fig. 2)
- Press the open/close button (OPEN/CLOSE) to close the disc holder.
- When the disc holder is closed, the disc is read and after a few seconds the TRACK NO and TIME displays, respectively, are displayed on the TRACK NO and TIME displays, respectively.
- When the disc holder is open and a disc is loaded, you may also press the play (▶ PLAY) or pause (⏸ PAUSE) button to play back will start immediately upon the disc contents having been read)

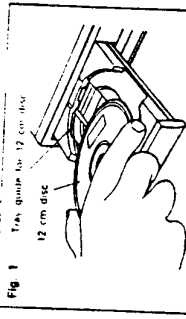

Fig. 1 Tray guide for 12 cm disc

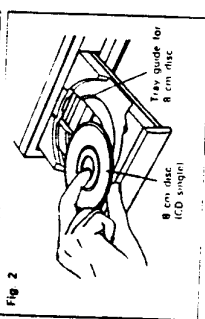

Fig. 2

Caution

- If your finger should get caught in the disc holder when it closes, press the open/close button (OPEN/CLOSE)
- Do not place any foreign object on the disc tray, and do not place more than one disc on the tray at a time. Otherwise malfunction may occur.
- Do not push in the disc tray manually when the power is off as this may cause malfunction and damage the CD player.

- Connection Precautions**
- Before proceeding with connections or disconnections of cables and power cords, be sure to turn all system components off
 - Ensure that all cables are connected properly to the left and right jacks.
 - Insert plugs fully into the terminals.
 - Connect the output jacks to the amplifier, CD, AUX or TAPE PLAY input jacks

(2) SYNCHRO Jack Connections

Connect the SYNCHRO jack with a DENON cassette deck which is equipped with a SYNCHRO jack, then make a synchronous recording. Use the connection cord supplied with the cassette deck.

To make use of this function, also connect the output jacks and make the settings so that a recording can be made from the CD player to the cassette deck.

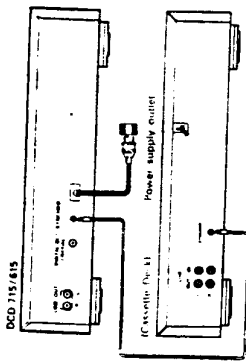

- (3) Connecting the Digital Output Jack (COAXIAL)
- Use a 75 ohm pin cord to connect the digital output jack (COAXIAL) of the DCD-715/615 to the digital input jack (COAXIAL) on a digital processor or D/A unit, available in stores.

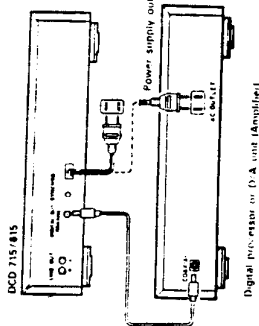

Digital processor to D/A unit (Amplifier)

NORMAL CD PLAYBACK

(1) Starting Playback

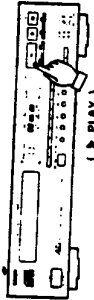

- 1 Press the power switch (POWER) to turn on the power.
- 2 Load the disc you want to play.
- 3 Press the play button (▶ PLAY)

(2) Stopping Playback

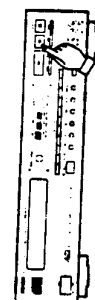

- 1 Press the stop button (■ STOP).
- When all tracks have been played on a disc, playback will stop by itself.

Precautions:

- If no disc has been loaded or the disc has been placed upside down, all indicators will light.
- When the information on the disc cannot be read correctly, for example due to dust or dirt on the disc, the indicator will read as shown below. Nothing will be shown on the TRACK NO. and TIME displays, and it may take quite a while to read the disc.

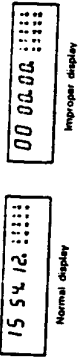

ADVANCED CD PLAYBACK

(1) Playing a Specific Track

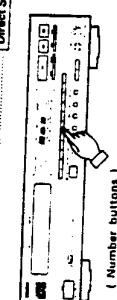

- Use the number buttons and the +10 button to input the number of the play track.
- For example, to play track number 4, press [4], and to play track number 12, press [10] and [2]. Playback will begin from that track.

(2) Advancing to the next track during playback

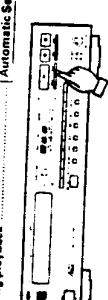

- Press the Automatic search forward button (▶▶▶) during playback.
- The pickup will advance to the beginning of the next track and playback will continue. Pressing the button several times will forward the pickup the corresponding number tracks.

(3) Returning to the beginning of the current track during playback

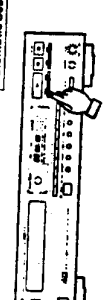

- Press the Automatic search reverse button (◀◀◀) during playback.
- The pickup will return to the beginning of the current track and playback will continue. Pressing the button several times will return the pickup the corresponding number tracks.

(4) Playing Specific Tracks in a Specific Order

- With this function, you can choose any of the tracks on the disc and program them to play in any order.
- Programming is possible with the disc holder open.
- Up to 20 tracks can be programmed.
- The programmed tracks are shown on the calendar.

(1) Programming

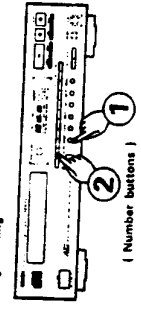

- Press the PROG/DIRECT button so that the [PROG] indicator lights, then use the number buttons and the +10 button to program the tracks.
- For example, to program tracks 3, 12, and 7, press [PROG/DIRECT], [3], [10], [2], and [7].
- The corresponding track number lights on the calendar each time a track is programmed, the track number is displayed on the TRACK NO. display, and the total playing time of the programmed tracks is displayed on the TIME display. A few seconds after the last track has been programmed, the total number of tracks programmed is displayed on the TRACK NO. display, and the total playing time of the programmed tracks is displayed on the TIME display.

(2) Checking the Programmed Tracks

(Remote control only)

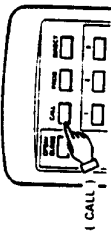

- Press the CALL button
- The programmed tracks are displayed in order on the TRACK NO. display each time the CALL button is pressed

(3) Playing the Programmed Tracks

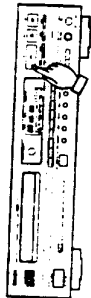

- Press the (▶) PLAY button to play the tracks in the program order.

(4) Clearing the Program

- The entire program is cleared when the PROG. DIRECT button is pressed. The program is also cleared when the (◀) OPEN/CLOSE button is pressed
- If the PROG. DIRECT button is pressed during programmed play, the program is cleared and playback continues normally through to the last track on the disc

NOTES

- If programming is done in the play or pause mode, the track currently playing is programmed at the last position. Other tracks can be added to the program, but will not be of programmed tracks and the playing time will not be affected.
- Direct search is not possible during programmed play if the number buttons are pressed; that track is added to the end of the program.
- Track numbering is possible with the disc holder open, recorded on the disc before the disc is closed, but will be automatically cleared before playback begins.
- The remaining time per track will only be displayed for track numbers 1 through 20.
- The remaining time and remaining program time are not displayed if tracks greater than track number 20 are programmed.

(5) Repeating playback

(DCD-615 remote control only)

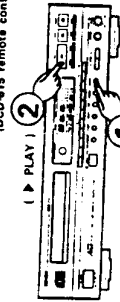

- Press the repeat button (REPEAT)
 - Press the play button (▶) PLAY
- To cancel/repeat playback of all tracks, press the repeat button (REPEAT) once more
 - Steps 1 and 2 above may be reversed
 - To cancel/repeat playback of all tracks, press the repeat button (REPEAT) once more
 - Pressing the repeat button (REPEAT) during programmed playback of the tracks entered into the memory will be repeated

(6) Pausing playback at any point

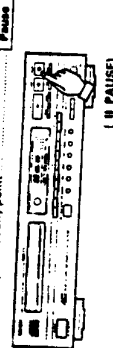

- Playback can be temporarily halted and then continued from the same point in the track
- Press the pause button (|| PAUSE) during playback
- To continue playback, press the play button (▶) PLAY or the pause button (|| PAUSE) once more

(7) Audible quick search

- Using this function, you can cue to a desired point within a track, enter in the forward or reverse direction
- Release the manual search button (◀◀ or ▶▶) when the desired point has been reached. Normal playback then continues

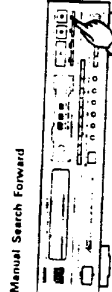

- Press the manual search forward button (▶▶) during play back. Playback of the track is sped up
- As a reference, the current track number and elapsed playback time within the track are displayed
- Manual search forward is approximately three times faster when engaged during the pause state compared to playback
- In this case, no sound is heard while compared to playback
- If the manual search forward button (▶▶) is kept pressed after the end of the final track on the disc is reached, (JJ) is displayed and manual search stops. To return to another point, press the manual search reverse button (◀◀) until (JJ) disappears

(2) Manual Search in Reverse

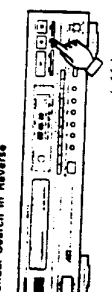

- Press the manual search reverse button (◀◀) during playback. Reverse playback of the track is sped up
- As a reference, the current track number and elapsed playback time within the track are displayed
- Manual search in reverse is approximately three times faster when engaged during the pause state compared to playback
- In this case, no sound is heard however.
- If the manual search reverse button (◀◀) is kept pressed after the beginning of the first track on the disc is reached, (LL) is displayed and manual search stops. To return to another point, press the manual search forward button (▶▶) until (LL) disappears.

(8) Inserting blanks between tracks

- This is convenient feature that will insert 4-second blanks between tracks, which can be used when recording compact discs on tape.

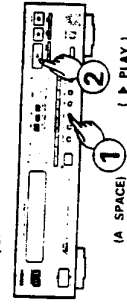

- Pressing the auto space button (A SPACE) will cause the (A SPACE) indicator to light
- Press the play button (▶) PLAY to start playback. Made before the next track starts playing, a 4-second silence is inserted
- Press the auto space button (A SPACE) again to cancel the function

(9) Searching and Pausing at the Beginning of the Track

- With Direct Search
 - In this case, the set pauses at the beginning of the track found with the direct search operation

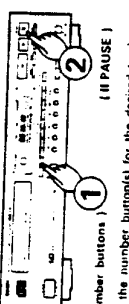

- With Program Search
 - Press the (|| PAUSE) button after the program search operation is completed. The set will pause at the beginning of the first programmed track

(10) Changing the Speed of Playback

- Playback can be speeded up or slowed down.

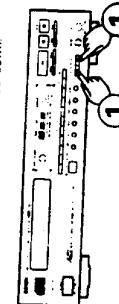

- Press the PITCH - or PITCH + button during the play or pause mode to change the speed of playback
- When one of the PITCH buttons is pressed, the amount of the speed change appears on the TIME display. The amount of change is 2 seconds. The speed can be changed in steps of 0.1% from -2.0% to +2.0%.
- Press the PLAY button (▶) PLAY during playback with a different speed. When the speed is cancelled if the stop mode is set during playback at a different speed.

NOTES

- No data is output from the digital output jack (COAXIAL) during playback with a different speed. If you want to output data, press the PLAY button (▶) PLAY to return to normal speed playback
- The pitch speed changes when the speed is changed. The time display changes and the playback time remaining accurate during playback with a different speed
- A maximum of 1 second is required to return to normal speed when the PLAY button (▶) PLAY is pressed during playback with a different speed. During this time, only the OPEN/CLOSE (◀) OPEN/CLOSE and STOP buttons (■) STOP will function.

TIMER-CONTROLLED PLAYBACK

- Operation**
- Turn on the power of all system components
 - Set the input selector on the amplifier to correspond to the inputs the CD player is connected to
 - Make sure a disc has been loaded in the disc holder
 - Check the time on the timer and then set the desired turn-on time on the timer and then set the desired Power is turned off automatically in all components connected to the timer
 - When the preset turn-on time is reached, power is turned on in the system components, and CD playback starts from the first track
 - Connection

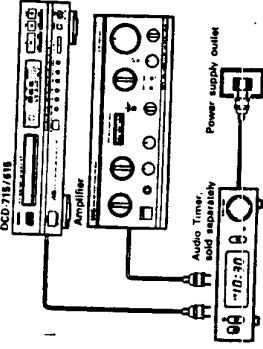

(2) Checking the Programmed Tracks

(Remote control only)



- Press the CALL button
- The programmed tracks are displayed in order on the TRACK NO. display each time the CALL button is pressed

(3) Playing the Programmed Tracks



- Press the (▶) PLAY button to play the tracks in the program order.

(4) Clearing the Program

- The entire program is cleared when the PROG. DIRECT button is pressed. The program is also cleared when the (◀) OPEN/CLOSE button is pressed
- If the PROG. DIRECT button is pressed during programmed play, the program is cleared and playback continues normally through to the last track on the disc

NOTES

- If programming is done in the play or pause mode, the track currently playing is programmed at the last position. Other tracks can be added to the program, but will not be of programmed tracks and the playing time will not be affected.
- Direct search is not possible during programmed play if the number buttons are pressed; that track is added to the end of the program.
- Track numbering is possible with the disc holder open, recorded on the disc before the disc is closed, but will be automatically cleared before playback begins.
- The remaining time per track will only be displayed for track numbers 1 through 20.
- The remaining time and remaining program time are not displayed if tracks greater than track number 20 are programmed.

(5) Repeating playback

(DCD-615 remote control only)

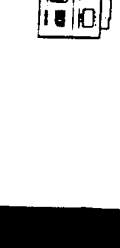

- Press the repeat button (REPEAT)
 - Press the play button (▶) PLAY
- To cancel/repeat playback of all tracks, press the repeat button (REPEAT) once more
 - Steps 1 and 2 above may be reversed
 - To cancel/repeat playback of all tracks, press the repeat button (REPEAT) once more
 - Pressing the repeat button (REPEAT) during programmed playback of the tracks entered into the memory will be repeated

THE COMPACT DISC

- Precautions on handling compact discs**
 - Do not touch the surface of the compact disc. If the surface of the disc is contaminated, clean it with a soft, dry cloth. Wipe in circular motions from the center and out.
 - Do not use water, benzene, thinner, retard sprays, etc. (resin, alcohol, chemicals, or silicone treated cloth to clean discs).
 - Use care when handling discs to prevent damaging the surface. Wipe until the condensation disappears and then dry.
 - Do not bend compact discs.
 - Do not apply heat to compact discs.
 - Do not write on the disc and do not attach any labels.
 - Condensation will form on the disc surface if it is brought into a warm room from a cold area, such as outdoors.
 - Never dry discs with hair dryers, etc.
- Precautions on storage**
 - After playing a disc, always return it to its case.
 - Keep discs in their case until they are not to be played. This will protect them from dust and dirt and prolong their service life.
 - Do not store discs in the following places
 - Places exposed to direct sunlight for a considerable time.
 - Places subject to accumulation of dust or high humidity.
 - Places exposed to high temperatures, such as close to heater ducts.

PLAYBACK USING THE REMOTE CONTROL UNIT

The accessory RC 241 remote control unit can be used to control the CD player from a convenient distance.

- Inserting the dry cell batteries
 - Remove the battery cover on the back of the remote control unit.



- Insert two R03 (standard size AAA) dry cell batteries with correct polarity as indicated inside the battery compartment.



- Replace the battery cover.



REMOTE CONTROL UNIT RC-241

Notes on the Batteries

- The remote control unit uses standard size AAA dry cell batteries.
- The batteries will need to be replaced approximately once a year. Replacement may be necessary earlier, depending on how much the remote control unit is used.
- If, in less than a year from the time new batteries were inserted, the remote control fails to operate the CD player from standby position, it is time to replace the batteries.
- Insert the battery cover in the correct polarity diagram inside the battery compartment. The polarity terminals (+) and (-) terminals are properly aligned.
- Batteries are prone to damage and leakage. Therefore:
 - Do not combine new batteries with used ones.
 - Do not combine different types of batteries.
 - Do not jumper opposite poles of the batteries.
 - Do not touch the terminals or the battery cover with your fingers. They may cause skin irritation or burn.
 - If the remote control unit is to be used for a long period of time, remove the batteries from the battery compartment if the batteries have leaked, remove any traces of battery fluid from the battery compartment, wiping thoroughly with a dry cloth. Then insert new batteries.

(2) Directions for Use

- Operate the remote control unit while pointing it towards the remote control sensor on the CD player (see below).
- When a remote control signal is received, the remote control indicator on front of the CD player lights briefly.
- The remote control unit can be used at a distance up to 8 meters (26 feet) from the CD player. This distance decreases if there are obstacles in the signal path or when the remote control unit is operated at an angle from the remote control sensor.
- The buttons on the remote control unit have identical functions with those on the CD player.
- However, the following functions cannot be remote controlled: Power ON/OFF

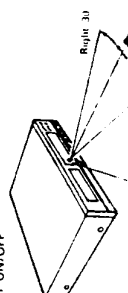

Notes on Operation

- Do not press identical buttons on the CD player and remote control unit simultaneously as this may cause malfunction.
- The remote control unit may be difficult to operate if the remote control sensor is exposed to strong light, such as direct sunlight or light from fluorescent lamps, or if there are obstacles between the remote control unit and the sensor.
- Direct track selection: Press the track number buttons (1 - 10, +10) directly assigned for playback.
- Track selection while programming: Press the program button (PROG) and then the track numbers you wish to program into the memory. Example: PROG, 1, 5 and 30 are entered into the memory. (Tracks 3, 11, 5 and 30 are entered into the memory).
- Memorized tracks are erased by pressing the Direct button (DIRECT).
- Correct use of the track number buttons: Direct selection of single digit tracks is easy by just pressing the desired track number button. For tracks with numbers more than one digit, first press the +10 button and then a single digit button. For example, to select track 22, press the +10 button twice and then press the 2 button.

Setting to the Program Mode

- For program search, press the PROG button.
- Then the number buttons (1 through 10 and +10).
- The remote control unit is normally set to the direct mode.

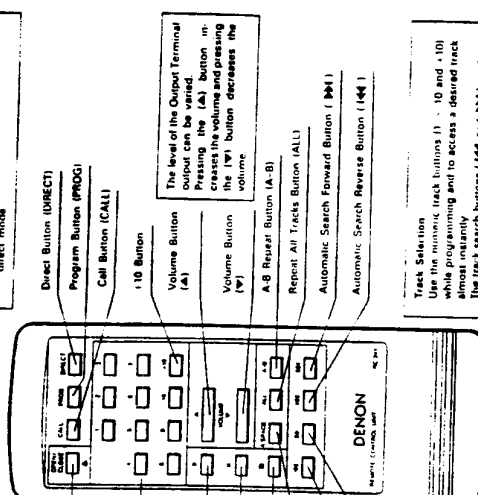

Track Selection

Use the numeric track buttons (1 - 10 and +10) while programming and to access a desired track almost instantly.

The track search buttons (▶ and ◀) are best for advance or return from the current track to the next track.

A-B Repeat Button (A-B)

- Repeating playback of a desired interval**
- Start playback and press the A-B button when you reach the starting point of the interval. The [A-B] indicator starts blinking.
 - Continue playback or advance the pickup using the Automatic search forward button (▶) or manual search forward button (▶) until the ending point is reached. Then press the A-B button once more. The [A-B] indicator will light.
- The pickup will now return to the starting point and repeat playback of the selected interval.
 - This interval will be repeated until the A-B repeat mode is cancelled by pressing the A-B repeat button. The [A-B] indicator goes out.
 - A-B repeat playback is not possible during programmed playback.

For Service Manuals Contact
MAURITON TECHNICAL SERVICES
 8 Cherry Tree Rd, Chinnor
 Oxon OX4 4QY
 Tel: 01844-351634 Fax: 01844-352554
 Email: enquiries@mauriton.co.uk

INSTALLATION PRECAUTIONS

The CD player uses a microcomputer for controlling internal electronic circuits. In the event that the player is used while a near by tuner or TV is turned on, although unlikely, interference could occur either in the sound from the tuner or the picture of the TV. To avoid this, please take the following precautions where possible.

- Keep the CD player as far away from the tuner or TV set as possible.
- Keep the power cable and connecting cable of the CD player separate from the antenna wires of the tuner and TV.
- Interference is particularly likely to occur when an indoor antenna or a 300 ohm feeder cable is used. Thus, use of an outdoor antenna and 75 ohm coaxial cable is strongly recommended.



300 ohm feeder cable



75 ohm coaxial cable

TROUBLESHOOTING

If the CD player does not seem to be functioning properly, check the following:

- Disc holder does not open or close
 - Is the power on?
- When a disc is loaded, 00 00 00 is displayed
 - Is the disc loaded properly? See page 8
- When the play button (▶ PLAY) is pressed, playback does not start
 - Is the disc dirty or scratched? See page 12
- There is no sound, or it is distorted
 - Is the output cord properly connected to the amplifier? See page 7
 - Have the amplifier controls been set correctly?

- A specific section of the disc will not play
 - Is the disc dirty or scratched? See page 12
- Programmed playback does not work
 - Have programming been properly done? See pages 9, 10 and 12
- Incorrect operation when buttons on the remote control are pressed
 - Is the remote control unit being operated too far from the CD player? See page 12
 - Are there obstacles blocking the ray? See page 12
 - Is the remote control sensor exposed to strong light? See page 12
 - Are the batteries exhausted?

For Service Manuals Contact
MAURITRON TECHNICAL SERVICES
8 Cherry Tree Rd, Chinnor
Oxon OX9 4QY
Tel: 01844 892554
E-mail: service@mauritron.co.uk

SPECIFICATIONS

AUDIO

	DCD-715	DCD-615
No. of Channels:	2 channels	
Frequency Response:	2 - 20,000 Hz	
Dynamic Range:	98 dB	
Signal-to-noise Ratio:	107 dB	106 dB
Harmonic Distortion:	0.003% (1 kHz)	0.003% (1 kHz)
Separation:	103 dB (1 kHz)	100 dB (1 kHz)
Wow & Flutter:	Below measurable limit: (± 0.001% W.peak)	
Output Voltage:	0.2 - 2.0 V	

DISCS

Compact Disc format

GENERAL CHARACTERISTICS

Power Supply:	50 Hz, ~ 230 V
Power Consumption:	10W
Dimensions:	434 (17-3/32") W x 105 (4-1/8") H x 280 (11-1/32") D mm
Weight:	3.8 kg

FUNCTIONS AND DISPLAY

Functions:	Automatic search, programmed playback, repeat playback, manual search, auto space, time mode, auto edit,
Display:	Track number, time, music calendar, emphasis feature and engaged modes
Others	Headphones jack

REMOTE CONTROL UNIT

Remote Control System:	RC-241 Infrared pulse system
Power Supply:	3 V DC; two R03 (standard size AAA) dry cell batteries
External Dimensions:	56 (2-13/64") W x 154 (6-1/16") H x 17 (43/64") D mm
Weight:	100 g (including batteries)

* Design and specifications are subject to change without notice in the course of product improvement.

For Service Manuals Contact
 MAURITRON TECHNICAL SERVICES
 8 Cherry Tree Rd, Chinnor
 Oxon OX9 4QY
 Tel: 01844-351694 Fax: 01844-352554
 Email: enquiries@mauritron.co.uk

NOTE FOR HANDLING OF LASER PICK-UP

DESCRIPTION OF THE COMPONENTS

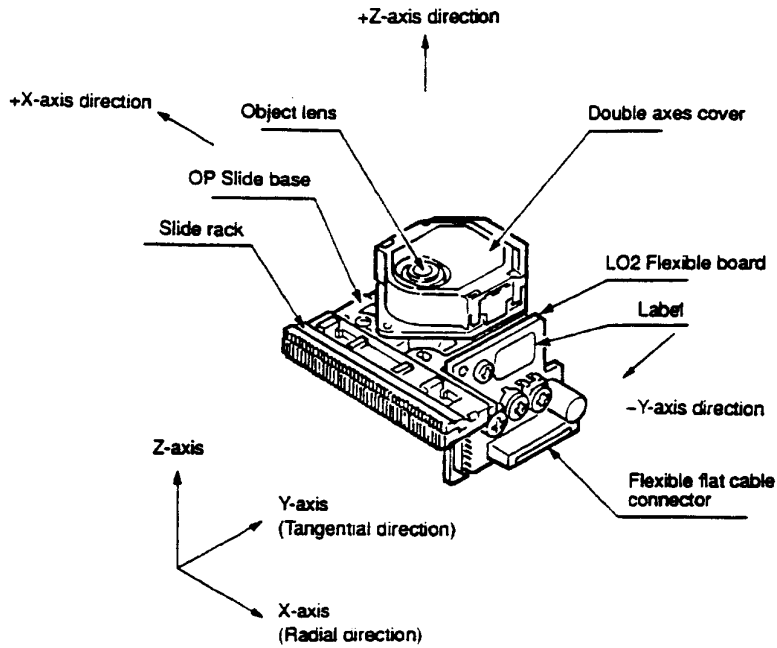

LABEL

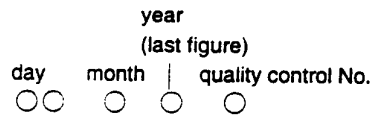
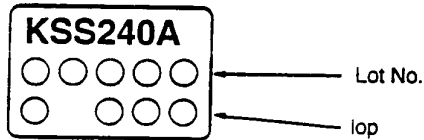

but Oct. Nov. and Dec. are expressed by alphabetical letters of X, Y and Z.

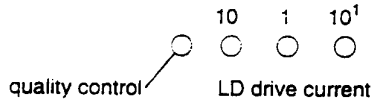

PIN CONNECTOR

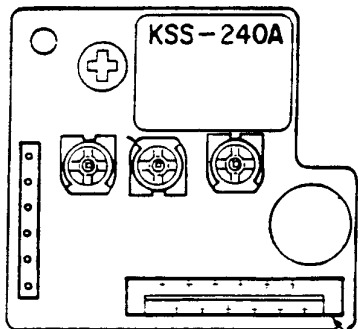

1 3 5 7 9 11
2 4 6 8 10 12

Flexible flat cable connector

The expressed unit is by mA, with omission of the decimal point as for example, 56.5mA will be expressed as 565, but the head of English letter means the control in the manufacturing plant.

Pin No.	Description	Input/Output	Pin No.	Description	Input/Output
1	VC (+2.5V)	OUT	7	Vcc (+5V)	IN
2	TE (TRK ER signal)	OUT	8	LDC (LD Control)	IN
3	FE (FCS ER signal)	OUT	9	FCS+ (Double axes)	IN
4	FZC (FZC signal)	OUT	10	TRK+ (Double axes)	IN
5	RF (RF signal)	OUT	11	TRK- (Double axes)	IN
6	GND	IN	12	FCS- (Double axes)	IN

Caution for Handling the Laser Pick-up

The laser pick-up KSS-240A is assembled and precisely adjusted using a sophisticated manufacturing process in our plant. Do not disassemble or attempt to readjust it. Please keep the following instructions carefully in handling pick-up.

1. Handle with Care

(1) Storage

Do not store the pick-up in dusty, high-temperature or high-humidity environments.

(2) Please take care for preventing from shock by falling down or careless handling.

2. Laser Diode (LD)

(1) Protect your eyes

The laser beam may damage the human eye, since the intensity of the focused spot may reach $7 \times 10^3 \text{ W/cm}^2$ even if the intensity at the objective lens is 400 μW maximum. As the light beam spreads after focused through the objective lens, it does not effect you in the place as far as more than 30 cms. However, do not look at the laser light beam either through the objective lens directly nor another lens or a mirror.

(2) Poison of As

Since the LD chip contains As (Arsenic), as GaAs + GaAlAs, as known as the poison, although the poison is relatively weak, in comparing with others, e.g. As₂O₃, AsCl₃ etc., and the amount is small, avoid putting the chip in acid or an alkali solution, heating it over 200°C or putting it into your mouth.

(3) Avoid surge current or electrostatic discharge

The LD may be damaged or deteriorated by its own strong light if a large current is supplied to it, even if only a short pulse.

Make sure that there is no surge current in the LD driving circuit by switches or else. Be careful to handle pick-up as it may be damaged in a moment by human electrostatic discharge. The pins of the LD are short-circuited by solder for protection during shipment.

For safety handling of an LD, grounding the human body, measuring equipments and jig is strongly recommended. And still it is further desirable to make use of mat on the platform and floor for handling the LD.

To open the short-circuit, remove the soldering quickly with a soldering iron whose metal part is grounded.

The temperature of the soldering iron should be less than 320°C (30W).

3. Actuator

(1) The performance of the actuator may be effected if magnetic material is located nearby, since the actuator has a strong magnetic circuit. Do not permit dust to enter through the clearance of the cover.

(2) Cleaning the lens

It may change the specifications by attaching dust or ash on the objective lens. Clean the lens with a cleaning paper dampened with a little water, not pressing lens with so much strength by the cleaning paper.

4. Metal Bearing

As the metal bearing of Cu-compound sintered alloy is impregnated with FROIL946P (*Part No. 529 0054 007), never fail to supply the bushing with the same lubricant at the time of replacing the pick-up.

5. Handling

Please handle the laser pick-up with holding the side base (rosin molded part).

When either a part of human body or some other things may happen to touch directly with the circuit part of P.W.Board, it may cause deterioration, take careful attention in handling this base.

6. Deterioration

As KSS-240 comprises built-in RF Amp and APC circuit, it resists stronger against external electrostatic damages than the former typed pick-up. However, there is possibility of pickup deterioration in the following cases.

(1) Low HF level, or with great numbers of jitters.

(2) Tracking offset (EF Balance) is out of order (Refer to "Confirmation Method of Adjustment" for confirmation on (1) and (2)).

For Service Manuals Contact
MAURITRON TECHNICAL SERVICES
8 Cherry Tree Rd, Chinnor
Oxon OX9 4QY
Tel:- 01844-351694 Fax:- 01844-352554
Email:- enquiries@mauritron.co.uk

DISASSEMBLY

• Top Cover

Remove 4 screws from both sides and 1 screw from Back Panel.

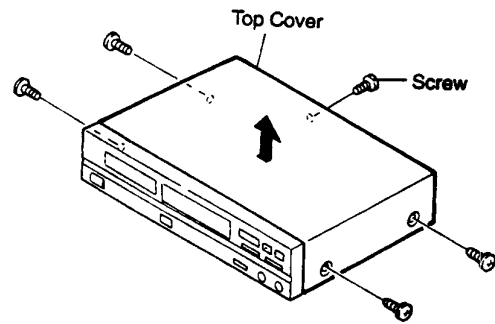

• Front Panel

1. Pull Loader frame frontward, and remove loader panel.
2. Remove 2 front panel upper screws.
3. Undo 2 front panel upper hooks.
4. Pull front panel and undo 3 lower hooks.

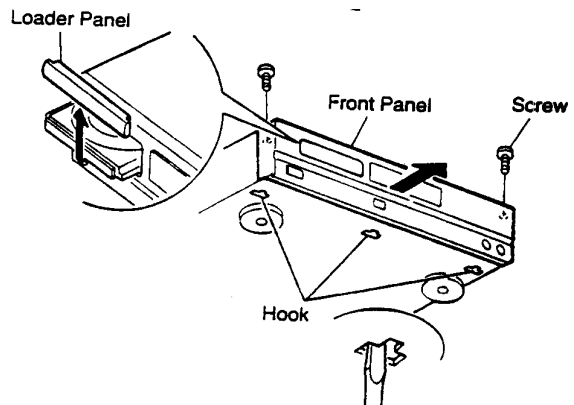

• Mechanism Unit

Remove 4 screws.

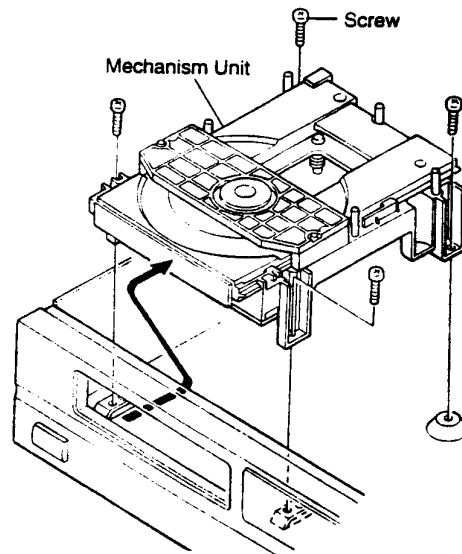

• Clamper

Remove 2 screws.
Pull clamper and undo 4 hooks.

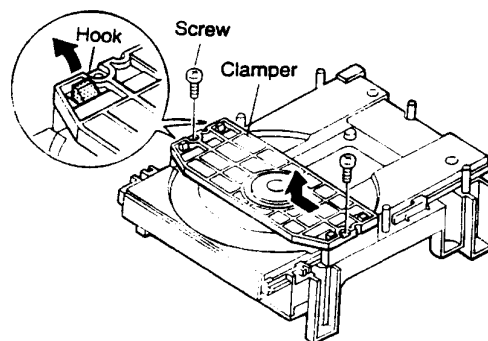

ADJUSTMENT

Microcomputer built in the unit, comprises service program to facilitate servo adjustment by pushing operation button.

1. Start service program

- (1) Turn power switch OFF.
- (2) Shortcircuit pin ③ (SWCL) and ④ pin (SWOP) of connector (TP102) on P.W.B. (Main Unit)
(Caution) Do not touch other pins.
- (3) Turn power switch ON.
(Service program starts, and displays track number 01)

(Caution)

- When service program started normal operation of buttons will be defeated.

2. Service program function

Button	Function	Description
▲ OPEN/CLOSE	Opens or closes the disc holder.	<ul style="list-style-type: none"> ● Opens or closes only when disc is stopped. ● Operate other keys after open or close.
■ STOP	Stops system function.	<ul style="list-style-type: none"> ● Displays track number 01. ● Push when adjustment completed, or do it again.
▶ PLAY	Starts focus servo and disc turns.	<ul style="list-style-type: none"> ● Push when adjust tracking offset. ● When completed, displays track number 02.
PAUSE	Starts focus servo, tracking servo, slide servo, spindle servo.	<ul style="list-style-type: none"> ● When PAUSE button is pushed, starts tracking servo and slide servo. ● When completed, track number 03.
Other button	No normal operation.	<ul style="list-style-type: none"> ● Do not operate buttons other than above. ● If misoperated, immediately turn power switch OFF.

(Caution)

- Do not use remote control during service program mode.

3. Adjustment

- (1) Location

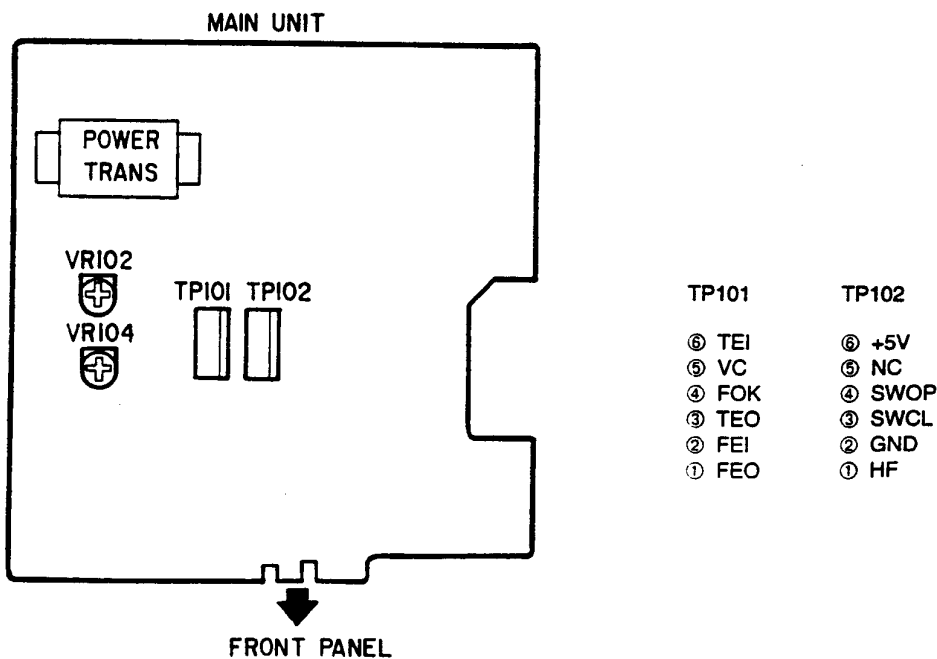

(2) Necessary equipment for adjustment

1. Dual trace oscilloscope
2. Reference disc (CA-1094) or CO-76143
3. Oscillator (10 Hz ~ 10 kHz, 0 ~ 3 Vp-p)
4. Frequency counter (readable no less than 5 KHz)
5. Filter for measurement

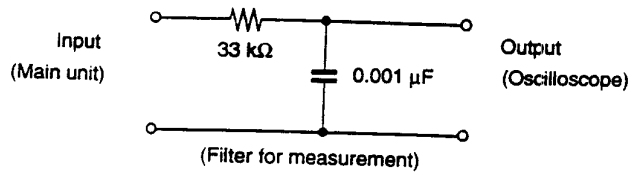

(3) Preset

1.	Start service program.							
2.	Preset VR101, 102 as per right figure.	<table style="margin-left: auto; margin-right: auto;"> <tr> <td>VR102 (F-GAIN)</td> <td></td> <td>12 O'clock</td> </tr> <tr> <td>VR104 (TR-GAIN)</td> <td></td> <td>12 O'clock</td> </tr> </table>	VR102 (F-GAIN)		12 O'clock	VR104 (TR-GAIN)		12 O'clock
VR102 (F-GAIN)		12 O'clock						
VR104 (TR-GAIN)		12 O'clock						
3.	Step.	<ol style="list-style-type: none"> 1. Focus gain (VR102) 2. Tracking gain (VR104) 						

4. Focus gain

Connection

Oscillator	Counter	Oscilloscope		Adjust (Volume)	Check (Oscilloscope)	Step
		V	H			
<ul style="list-style-type: none"> ● CA-1094 930 Hz 2 Vp-p (±0.1 V) ● CO-76143 710 Hz 1 Vp-p (±0.1V) 	<ul style="list-style-type: none"> ● CA-1094 930 Hz ● CO-76143 710 Hz 			VR102	<p>Y axis</p> <p>X axis</p> <p>Phase 90° Waveform not right</p> <p>Y axis</p> <p>X axis</p>	<ol style="list-style-type: none"> 1. Push PAUSE . (Displays track number 03) 2. Connect oscillator. 3. Set oscillator to 930 Hz/2 Vp-p or 710Hz/1Vp-p. 4. Switch oscilloscope input to X-Y mode. 5. Adjust VR102 [F-GAIN] to symmetrize Lissajous figures to X-Y axes.

5. Tracking gain

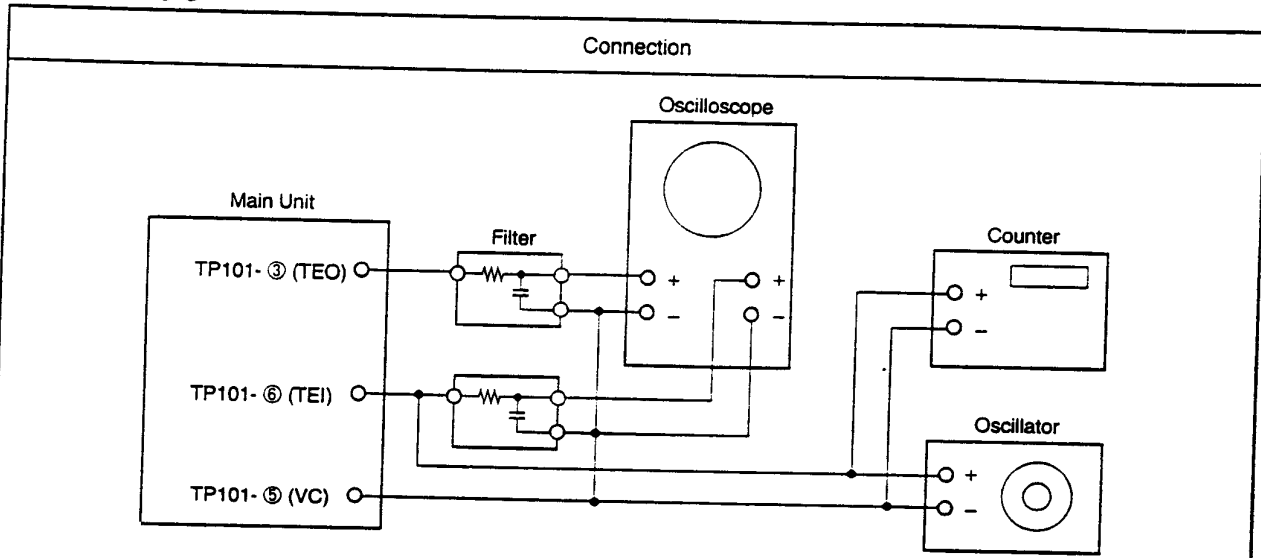

• Caution: Connect oscillator after **|| PAUSE** pushed and servo function started.

Oscillator	Counter	Oscilloscope		Adjust (Volume)	Check (Oscilloscope)	Step
		V	H			
<ul style="list-style-type: none"> CA-1094 3.0 kHz 0.8 Vp-p (±0.1V) <i>0.27V_{rms}</i> CO-76143 1.9 kHz 3Vp-p (±0.1V) 	<ul style="list-style-type: none"> CA-1094 3.0 kHz CO-76143 1.9 kHz 	<ul style="list-style-type: none"> DC range X-Y mode 		VR104	Y axis X axis Phase 90° Waveform not right Y axis X axis	<ol style="list-style-type: none"> Push PAUSE. (Displays track number 03) Connect oscillator. Set oscillator to 3.0 kHz/0.8 Vp-p or 1.9kHz /3Vp-p. Switch oscilloscope input to X-Y mode. Adjust VR104 [TR-GAIN] to symmetrize Lissajous figures to X-Y axes.

For Service Manuals Contact
 MAURITRON TECHNICAL SERVICES
 8 Cherry Tree Rd, Channon
 Oxon OX9 4QY
 Tel:- 01844-351694 Fax:- 01844-352554
 Email:- enquiries@mauritron.co.uk

6. Tracking offset (E/F Balance)

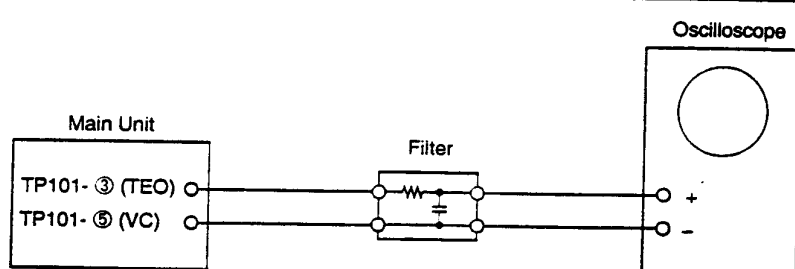
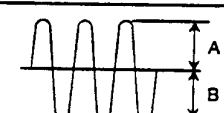
Connection			
			
Oscilloscope		Check	Step
V	H	(Oscilloscope)	
0.1v/div	1-2 ms/div	 $\frac{A - B}{A + B} < 20\%$	<ol style="list-style-type: none"> 1. Push ▲ OPEN/CLOSE and load disc holder reference disk. 2. Push ▲ OPEN/CLOSE and close disc holder. 3. Push ▶ PLAY to turn disc. (Displays track number 02) 4. Short (+)(-) of oscilloscope and check the base line. 5. Confirm that upper and lower amplitude of the waveform is symmetric against 0V.

7. HF level

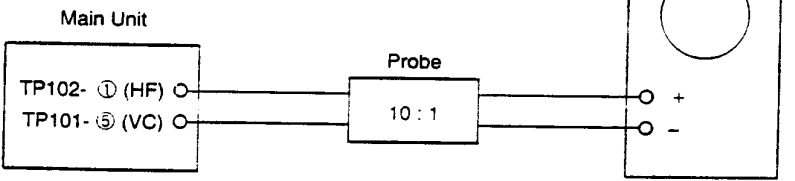
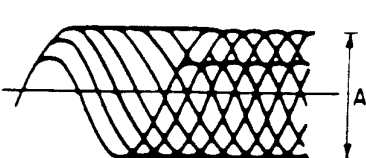
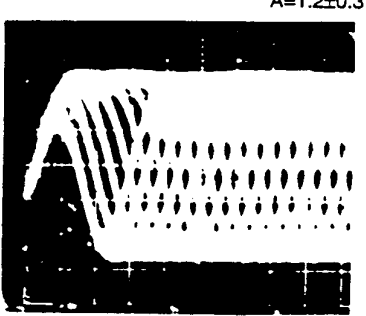
Connection			
			
Oscilloscope		Check	Step
V	H	(Oscilloscope)	
50mv/div or 20mV/div	0.2μ/div or 0.5μ/div	 <p style="text-align: center;">$A = 1.2 \pm 0.3V_{p-p}$</p> 	<ol style="list-style-type: none"> 1. Push PAUSE. (Displays track number 03) 2. Check HF level of oscilloscope. 3. Confirm that the waveform is in good shape. (◊ pattern in center must be able to discriminate clearly.)
		<ul style="list-style-type: none"> • Set input mode to ALTERNATE or CHOPPER. 	

HEAT RUN MODE FUNCTION

Heat Run Mode

1) To activate

While hold pushing ►►, ◀◀, ►► and ◀◀ keys simultaneously, turn the unit power on. The remote control sensor indicator will light to show that the unit is shifted in Heat Run mode.

Be sure to load the disc previously.

Press the disc holder open/close button (▲ OPEN/CLOSE) to cancel Heat Run mode.

★ This mode functions only for a disc with 21 pieces of music or more. For a disc with 20 pieces of music or lesser, please do not use.

2) Operation

During the Heat Run mode to shift the unit in Play mode makes the unit replays from the first music after opens the loader once and re-closes it when finish playing the last track (comes into lead out).

Hereafter, operates open/close of loader, servo on, reading of TOC, and playing repeatedly, and repeats playing the two tracks; the first and the last ones.

3) Error Message

When the system error occurs while in Heat Run mode, the following error message will display on the Track No. indicator and stops operation.

1. E1

At the time of Focus Servo does not activate.

2. E2

When unable to detect synchronous pattern however the disc is in rotating. (GFS does not drive.)

3. E3

No synchronous pattern can be detected while in Play mode. (No GFS drives.)

4. E4

When TOC is unreadable in despite of servo is activated.

5. E5

In case of loader malfunctions. (Unable to turn on the switch.)

6. E6

The inner circle switch of Pick-up does not turn off.

7. E7

The inner circle switch of Pick-up does not turn on.

★ The number of operation up to the stop will be displayed on the minute and second portion of the indicator.

For Service Manuals Contact
MAURITRON TECHNICAL SERVICES
8 Cherry Tree Rd, Chinnor
Oxon OX9 4QY
Tel:- 01844-351694 Fax:- 01844-352554
Email: enquiries@mauriton.co.uk

IC TERMINAL FUNCTION LIST

CXD2500BQ Terminal Function

Terminal No.	Symbol	I/O	Terminal Function
1	FOK	I	Input terminal for OK focussing. Use for Servo-autosequencer.
2	FSW	O	Output to shift time constant of output filter for spindle motor.
3	MON	O	ON/OFF control output for spindle motor.
4	MDP	O	Servo control for spindle motor.
5	MDS	O	Servo control for spindle motor.
6	LOCK	O	Sampling GFS by 460 Hz and if it is "H", delivers "H"; if it is continuously "L" 8 times, delivers "L".
7	NC	—	
8	VCOO	O	Oscillation current output for analog EFM PLL.
9	VCOI	I	Oscillation current output for analog EFM PLL. f LOCK=8.6436MHz.
10	TEST	I	TEST output. Normally GND.
11	PDO	O	Charge pump output for analog EFM PLL.
12	Vss		GND.
13	NC	—	
14	NC	—	
15	NC	—	
16	VPCO	O	Charge pump output for variable pitch PLL.
17	VCKI	O	Clock input from external VCO for variable pitch. fc center=16.9344MHz.
18	FILO	O	Filter output for master PLL. (slave=digital PLL)
19	FILI	I	Filter input for master PLL.
20	PCO	O	Charge pump output for master PLL.
21 ¹	AVss		Analog GND.
22	CLTV	I	Control voltage output for master VCO.
23	AVDD		Analog power supply (+5V).
24	RF	I	EFM signal input.
25	TEST2	I	Put to GND.
26	TEST3	I	Put to GND.
27	ASYO	O	Full swing output for EFM. (L=Vss, H=VDD).
28	TEST4	I	Put to GND.
29	NC	—	
30	PSSL	I	Input to shift output mode of audio data. Serial output at L; parallel output at H.
31	WOCK	O	D/A Interface for 48 bit slot. Word-clock f=2 Fs.
32	LRCK	O	D/A Interface for 48 bit slot. LR-clock f= Fs.
33	VDD		Power supply (+5V).
34	DA16	O	At PSSL=1 for DA16 (MBS) output; PSSL=0 for serial data of 48 bit slot. (2s'COMP, MSB first).
35	DA15	O	At PSSL=1 for DA15 output; PSSL=0 for bit clock of 48 bit slot.
36	DA14	O	At PSSL=1 for DA14 output; PSSL=0 for serial data of 64 bit slot. (2s'COMP, LSB first).
37	DA13	O	At PSSL=1 for DA13 output; PSSL=0 for bit clock of 64 bit slot.
38	DA12	O	At PSSL=1 for DA12 output; PSSL=0 for LR clock of 64 bit slot.
39	DA11	O	At PSSL=1 for DA11 output; PSSL=0 for GTOP output.
40	DA10	O	At PSSL=1 for DA10 output; PSSL=0 for XUGF output.
41	DA09	O	At PSSL=1 for DA09 output; PSSL=0 for XPLCK output.
42	DA08	O	At PSSL=1 for DA08 output; PSSL=0 for GFS output.
43	DA07	O	At PSSL=1 for DA07 output; PSSL=0 for RFCK output.
44	DA06	O	At PSSL=1 for DA06 output; PSSL=0 for C2PO output.
45	DA05	O	At PSSL=1 for DA05 output; PSSL=0 for XRAOF output.
46	DA04	O	At PSSL=1 for DA04 output; PSSL=0 for MNT3 output.
47	DA03	O	At PSSL=1 for DA03 output; PSSL=0 for MNT2 output.
48	DA02	O	At PSSL=1 for DA02 output; PSSL=0 for MNT1 output.
49	DA01	O	At PSSL=1 for DA01 output; PSSL=0 for MNT0 output.
50	APTR	O	Control output for aperture compensation. In H for R-ch.
51	APTL	O	Control output for aperture compensation. In H for L-ch.

Terminal No.	Symbol	I/O	Terminal Function
52	Vss		GND.
53	XTAI	I	X'tal oscillation circuit input. By selecting of mode, f=16.9344MHz or 33.8688MHz.
54	XTAO	O 1.0	X'tal oscillation circuit output. f=16.9344MHz.
55	XTSL	I	Selection input terminal of X'tal. "L" for X'tal 16.9344MHz; "H" for 33.8688MHz.
56	FSTT	O 1.0	2/3 Dividing output of 53 and 54 terminal. No change by variable pitch.
57	C4M	O 1.0	4.2336MHz output. When variable pitched, simultaneously changes.
58	C16M	O 1.0	16.9344MHz output. When variable pitched, simultaneously changes.
59	MD2	I	Digital-out ON/OFF control. ON at H; OFF at L.
60	DOUT	O 1.0	Digital-out output terminal.
61	EMPH	O 1.0	When playback disc emphasized, outputs H; otherwise outputs L.
62	WFCK	O 1.0	WFCK (Write Flame Clock) output.
63	SCOR	O 1.0	Output of subcode sync. S0+S1. H output when either one detected.
64	SBSO	O 1.0	Serial output of Sub P-W.
65	EXCK	I	Clock input for SBSO read-out.
66	SQSO	O 1.0	Output for Sub Q 80 bits and PCM peak level 16 bits.
67	SQCK	I	Clock input for SQSO read-out.
68	MUTE	I	Mute at H; remove mute at L.
69	SENS	— 1,Z,0	SENS output. Outputs to CPU.
70	XRST	I	System reset input. Resets at "L".
71	DATA	I	Input of serial data from CPU.
72	XLAT	I	Input for latch from CPU. Latches serial data at release.
73	Vdd		Power supply (+5V).
74	CLOCK	I	Serial data transfer clock input from CPU.
75	SEIN	I	SENS input from SSP.
76	CNIN	I	Input of tracking pulse.
77	DATO	O 1.0	Serial data output to SSP.
78	XLTO	O 1.0	Serial data latch output to SSP.
79	CLKO	O 1.0	Serial data transfer clock output to SSP.
80	MIRR	I	Mirror signal input. Use for track jump for over 128 tracks, using autosequencer.

CXD2500BQ

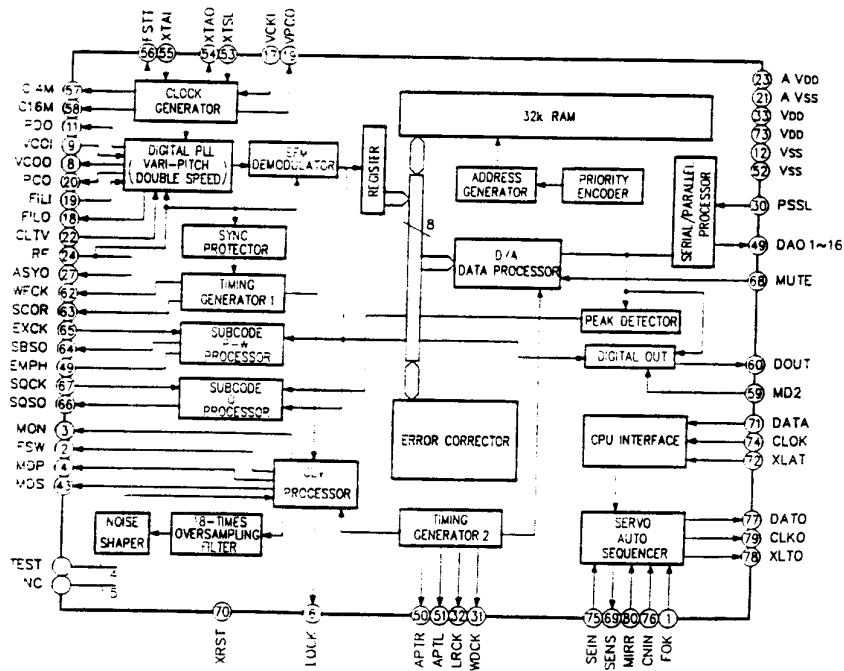

CXA1372S Terminal Function

Terminal No.	Symbol	I/O	Terminal Function
1	TE	I	Tracking error signal input terminal.
2	TDFCT	I	Capacitor connecting terminal for time constant at the time of defect.
3	ATSC	I	Input terminal of ATSC detecting window comparator.
4	FZC	I	Input terminal of focus zero-cross comparator.
5	FE	I	Focus error signal input terminal.
6	DFCT	I	Capacitor connecting terminal for time constant at the time of defect.
7	Vc	I	Mid-point voltage input terminal.
8	FGD	I	In case of reducing higher range gain of focus servo, connect a capacitor between this terminal and terminal number (9).
9	FS3	I	Shifts higher range gain of focus servo by FS3 ON/OFF.
10	FLB	I	Terminal for external time constant to increase lower range of focus servo.
11	FEO	O	Focus drive output.
12	FE-	I	Reverse input terminal for focus amplifier.
13	SRCH	I	Terminal for external time constant to make focus search waveform.
14	TGU	I	Terminal for external time constant to shift higher range gain of tracking.
15	TG2	I	Terminal for external time constant to shift higher range gain of tracking.
17	TAO	O	Tracking drive output.
18	TA-	I	Reverse input terminal for tracking amplifier.
19	SL+	I	Non-reverse input terminal for sled amplifier.
20	SLO	O	Sled drive output.
21	SL-	I	Reverse input terminal for sled amplifier.
22	FSET	I	Terminal to compensate peak in focus/tracking phase.
23	ISET	I	Delivers a current to set the height of focus search, track jump, and sled kick.
24	SSTOP	I	Terminal for limit switch ON/OFF to detect disc innermost circle.
26	DIRC	I	Terminal is used at the time of 1 track jump. A 47 kohm pull up resistor is included.
27	LOCK	I	Reckless drive protection circuit of sled; activates at "L". A 47k ohm pull up resistor is included.
28	CLK	I	Serial data transfer clock input from CPU.
29	XLT	I	Latch input from CPU.
30	DATA	I	Serial data input from CPU.
31	XRST	I	Reset input terminal. Resets at "L".
32	C.OUT	O	Terminal to output signal for track number count.
33	SENS	O	Terminal to output FZC, AS, TZC, SSTOP by command from CPU.
35	MIRR	O	Output terminal for MIRR comparator.
36	DFCT	O	Output terminal for DEFECT comparator.
37	ASY	I	Input terminal for auto-symmetric control.
38	EFM	O	Output terminal for EFM comparator.
39	FOK	O	Output terminal for focus OK (FOK) comparator.
40	CC1	O	DEFECT bottom hold output terminal.
41	CC2	I	Input terminal to input DEFECT bottom hold output by capacitance combination.
43	CB	I	Capacitor connecting terminal for DEFECT bottom hold.
44	CP	I	MIRR hold capacitor connecting terminal. A non-reverse input terminal for MIRR comparator.
45	RFI	I	Input terminal to input RF summing amplifier output by capacitance combination.
46	RFO	O	Output terminal for RF summing amplifier. Check point for eye pattern.
48	TZC	I	Tracking zero-cross comparator input terminal.

CXA1372S

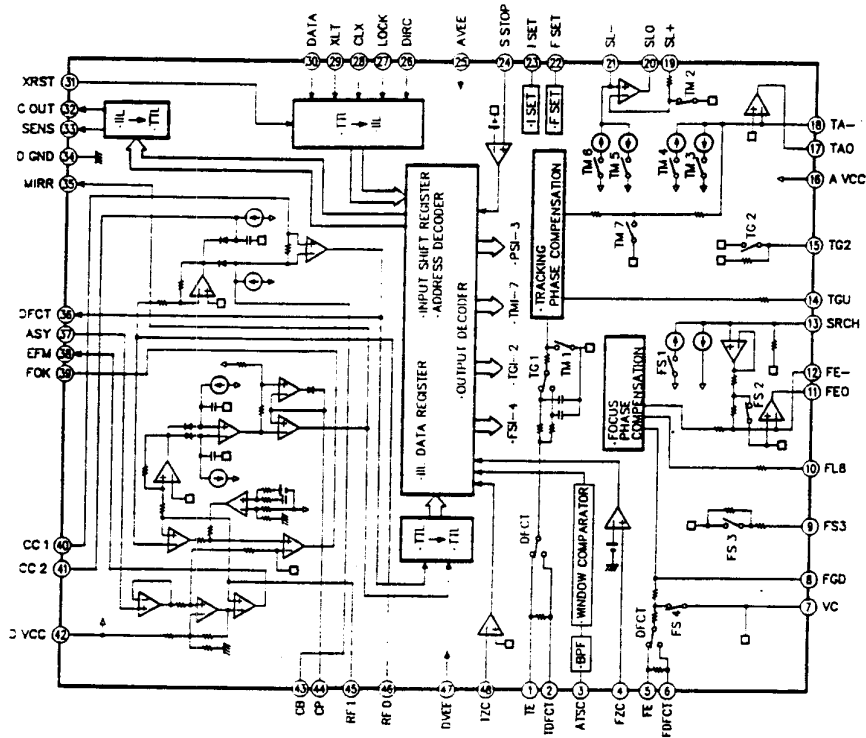

NOTE FOR PARTS LIST

- Part indicated with the mark " * " are not always in stock and possibly to take a long period of time for supplying, or in some case supplying of part may be refused.
- When ordering of part, clearly indicate "1" and "1" (i) to avoid mis-supplying.
- Ordering part without stating its part number can not be supplied.
- Part indicated with the mark "★" is not illustrated in the exploded view.
- Not including Carbon Film ±5%, 1/4W Type in the P.W.Board parts list. (Refer to the Schematic Diagram for those parts.)

WARNING:

Parts marked with this symbol  have critical characteristics. Use ONLY replacement parts recommended by the manufacturer.

● Resistors

Ex.: RN 14K 2E 182 G FR
 Type Shape Power Resistance Allowable error Others

RD : Carbon	2B : 1/8W	F : ±1%	P : Pulse-resistant type
RC : Composition	2E : 1/4W	G : ±2%	NL : Low noise type
RS : Metal oxide film	2H : 1/2W	J : ±5%	NB : Non-burning type
RW : Winding	3A : 1W	K : ±10%	FR : Fuse-resistor
RN : Metal film	3D : 2W	M : ±20%	F : Lead wire forming
RK : Metal mixture	3F : 3W		
	3H : 5W		

● Resistance

1 8 2 = 1800 ohm = 1.8 kohm
 Indicates number of zeros after effective number.
 2-digit effective number.

• Units: ohm

1 R 2 = 1.2 ohm
 1-digit effective number
 2-digit effective number, decimal point indicated by R

• Units: ohm

● Capacity (electrolyte only)

2 2 2 = 2200µF
 Indicates number of zeros after effective number.
 2-digit effective number.

• Units: µF

2 R 2 = 2.2µF
 1-digit effective number
 2-digit effective number, decimal point indicated by R

• Units: µF

● Capacitors

Ex.: CE 04W 1H 2R2 M BP
 Type Shape Dielectric and per- strength Capacity Allowable error Others

CE : Aluminum foil electrolytic	0J : 6.3V	F : ±1%	HS : High stability type
CA : Aluminum solid electrolytic	1A : 10V	G : ±2%	BP : Non-polar type
CS : Tantalum electrolytic	1C : 16V	J : ±5%	HR : Ripple-resistant type
CO : Film	1E : 25V	K : ±10%	DL : For charge and discharge
CK : Ceramic	1V : 35V	M : ±20%	HF : For assuring high frequency
CC : Ceramic	1H : 50V	Z : ±80%	U : UL part
CP : Oil	2A : 100V	- : ±20%	C : CSA part
CM : Mica	2B : 125V	P : ±100%	W : UL-CSA type
CF : Metallized	2C : 160V	- : ±0%	F : Lead wire forming
CH : Metallized	2D : 200V	C : ±0.25pF	
	2E : 250V	D : ±0.5pF	
	2H : 500V	= : Others	
	2J : 630V		

● Capacity (except electrolyte)

2 2 2 = 2200pF = 0.0022µF
 (More than 2) — Indicates number of zeros after effective number.
 2-digit effective number.

• Units: pF

2 2 1 = 220pF
 (0 or 1) — Indicates number of zeros after effective number.
 2-digit effective number.

• Units: pF

• When the dielectric strength is indicated in AC, "AC" is included after the dielectric strength value.

SEMICONDUCTORS

● IC's

BA15218
μPC4570C

For Service Manuals Contact
MAURITRON TECHNICAL SERVICES
8 Cherry Tree Rd, Chinnor
Oxon OX9 4QY
Tel: 01844-351894 Fax: 01844-352554
Email: enquiries@mauritron.co.uk

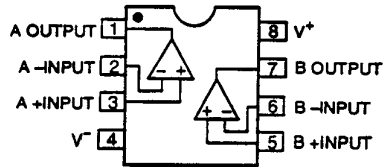
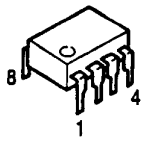

SM5841BP

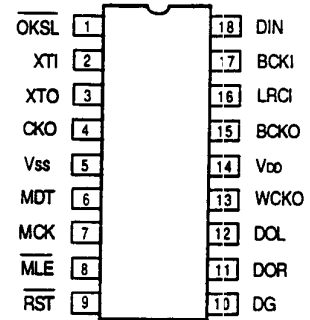
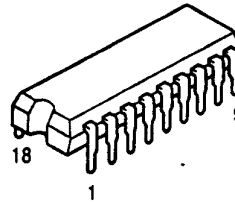

M5290P
PCM61P-L

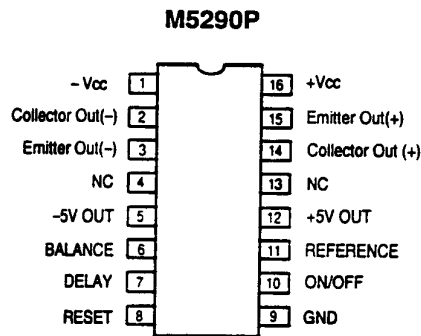
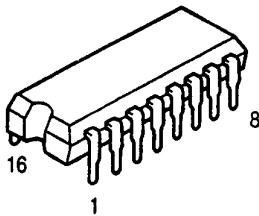

PCM61P-L

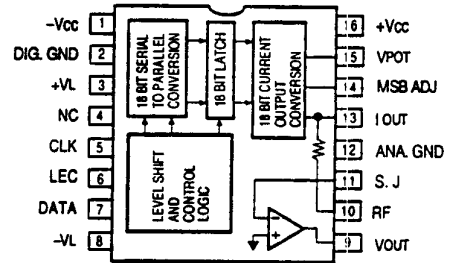

CXA1372S

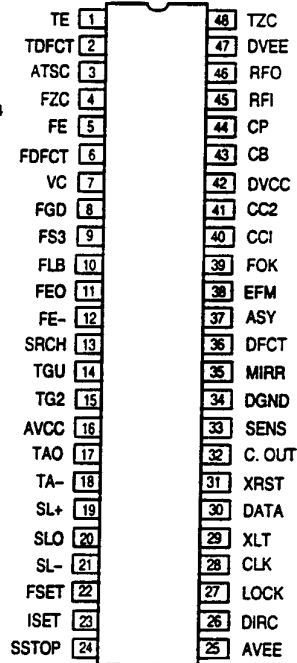
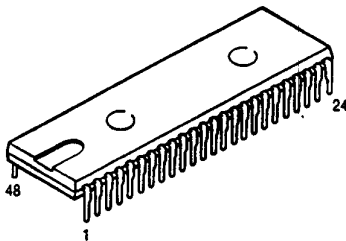

TC74HCU04AP

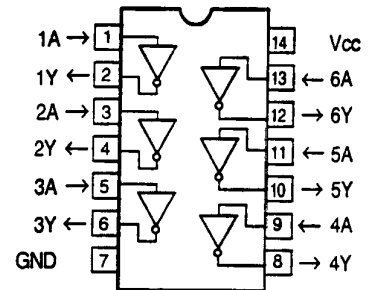
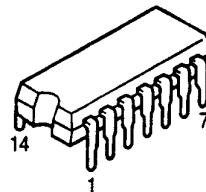

CXD2500BQ
M38172M4-081FP

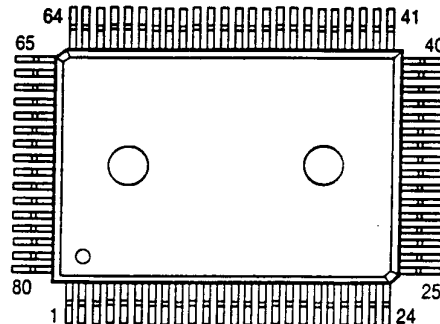

● IC PROTECTOR

ICP-N15T



● DIODE



1SS270A
1SR35



HZS6B-1
HZS7A-1
HZS30-1



For Service Manuals Contact
MAURITRON TECHNICAL SERVICES
8 Cherry Tree Rd, Chinnor
Oxon OX9 4QY
Tel:- 01844-351694 Fax:- 01844-352554
Email:- enquiries@mauritron.co.uk

● TRANSISTORS

2SD1762
2SB1185

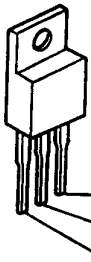

E (Emitter)
C (Collector)
B (Base)

2SD2144
:JC557A/B



ECB

2SA934(Q)
2SC2060(Q)



ECB

DTA124XS(22K-47K)
DTC114ES(10K-10K)

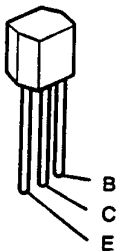

B
C
E

DTA124XS(22K-47K)

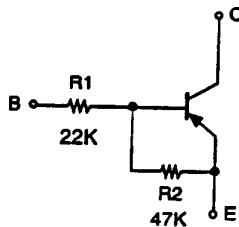

DTC114ES(10K-10K)

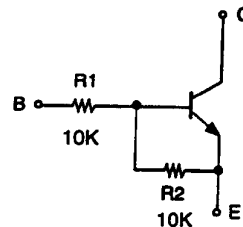

SCHEMATIC DIAGRAM (DCD-615)

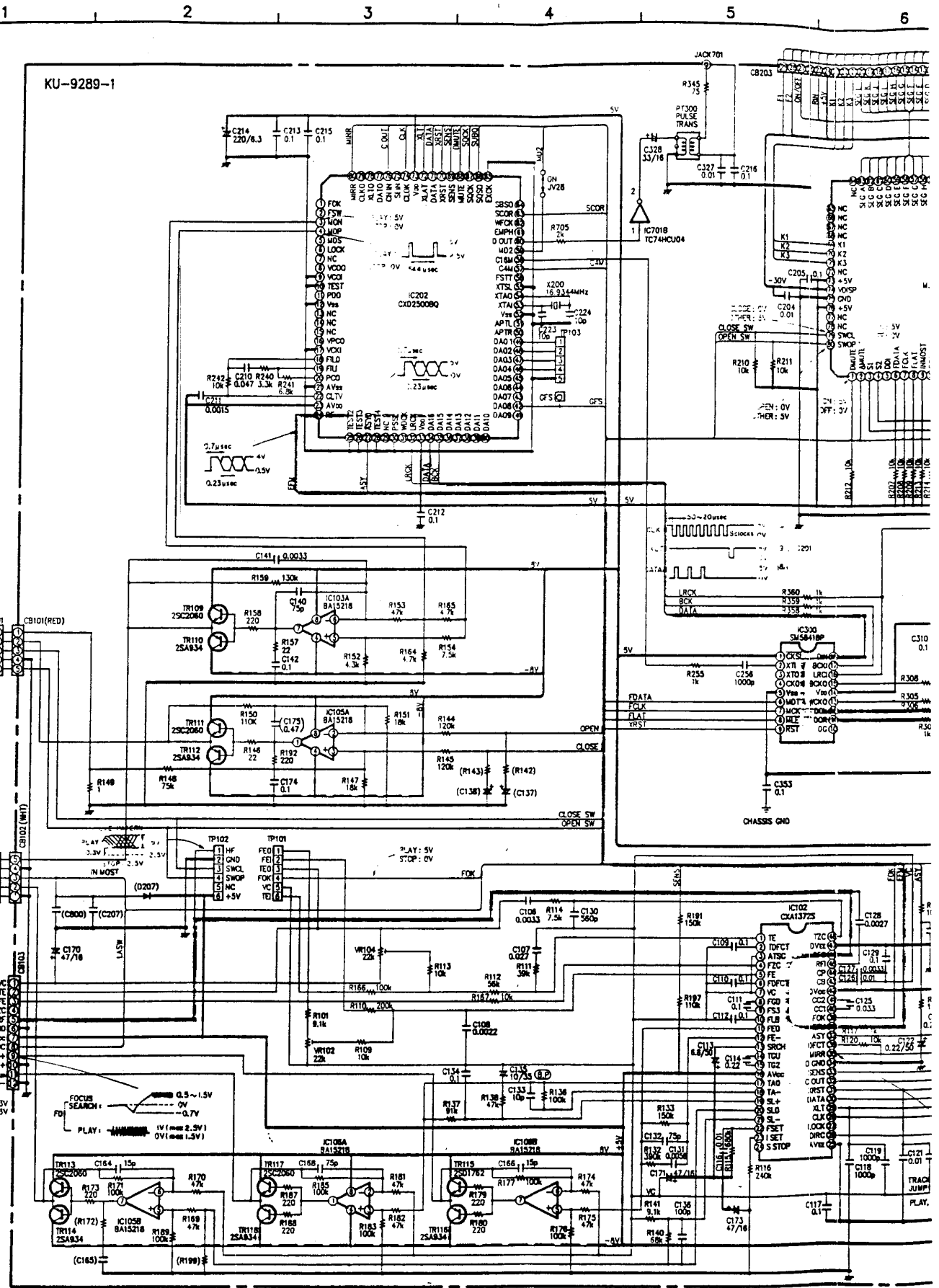

NOTES
 ALL RESISTANCE VALUES IN OHM, K=1,000 OHM, M=1,000,000 OHM
 ALL CAPACITANCE VALUES IN MICRO FARAD, P=MICRO-MICRO FARAD
 EACH VOLTAGE AND CURRENT ARE MEASURED AT NO SIGNAL INPUT CONDITION.
 CIRCUIT AND PARTS ARE SUBJECT TO CHANGE WITHOUT PRIOR NOTICE.

WARNING:
 Parts marked with this symbol  have critical characteristics. Use ONLY replacement parts recommended by the manufacturer.

CAUTION:
 Before returning the unit to the customer, make sure you make either (1) a leakage current check or leakage current exceeds 0.5 millamps, or if the resistance from chassis to either side of the power!

WARNING:
 DO NOT return the unit to the customer until the problem is located and corrected.

NOTES:
 Circuit and parts are subject to change without prior notice.

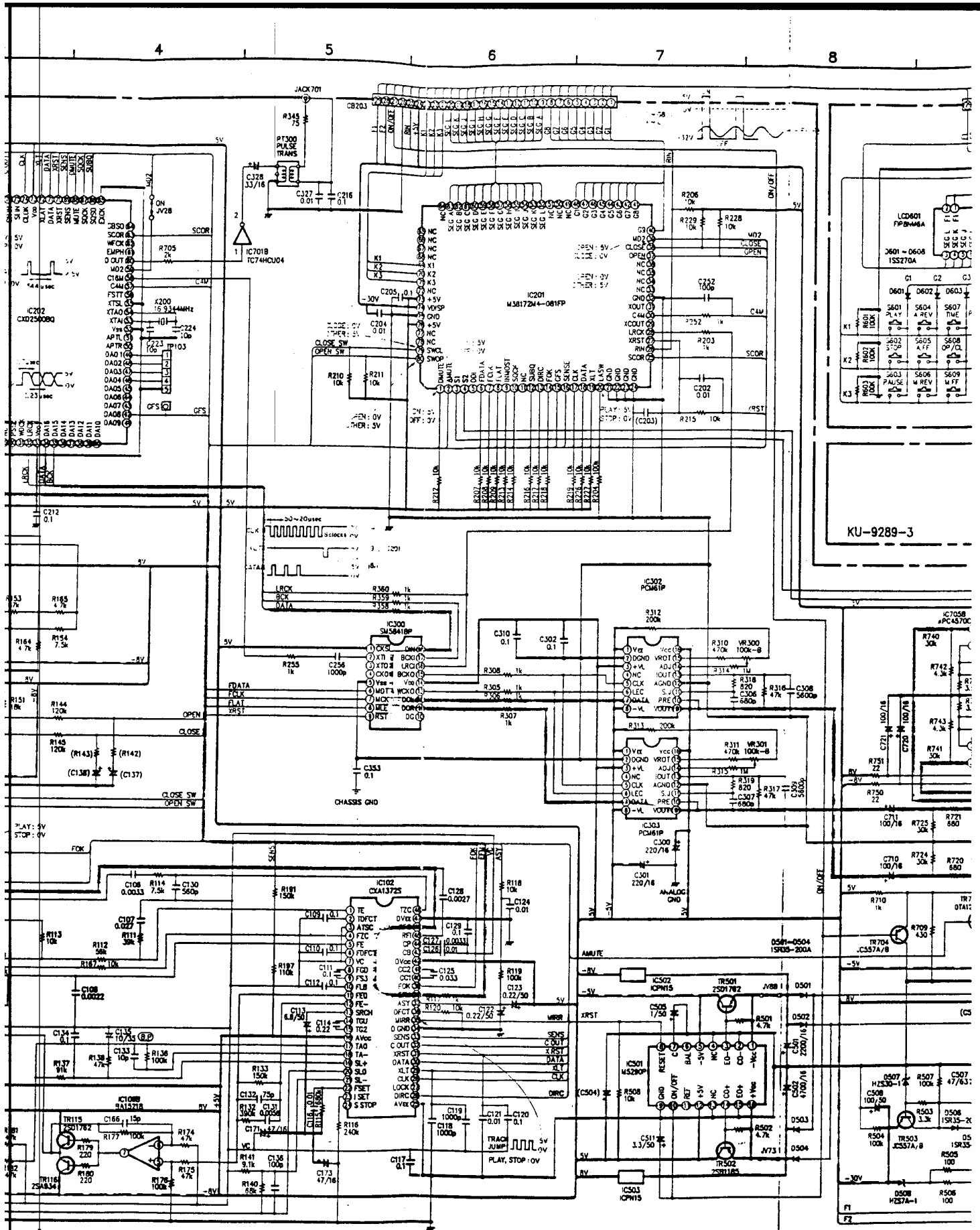

WARNING:
Parts marked with this symbol  have critical characteristics.
Use ONLY replacement parts recommended by the manufacturer.

CAUTION:
Before returning the unit to the customer, make sure you make either (1) a leakage current check or (2) a line to chassis resistance check. If the leakage current exceeds 0.5 millamps, or if the resistance from chassis to either side of the power cord is less than 240 ohms, the unit is defective.

WARNING:
DO NOT return the unit to the customer until the problem is located and corrected.

NOTES:
Circuit and parts are subject to change without prior notice.

CONDITION.

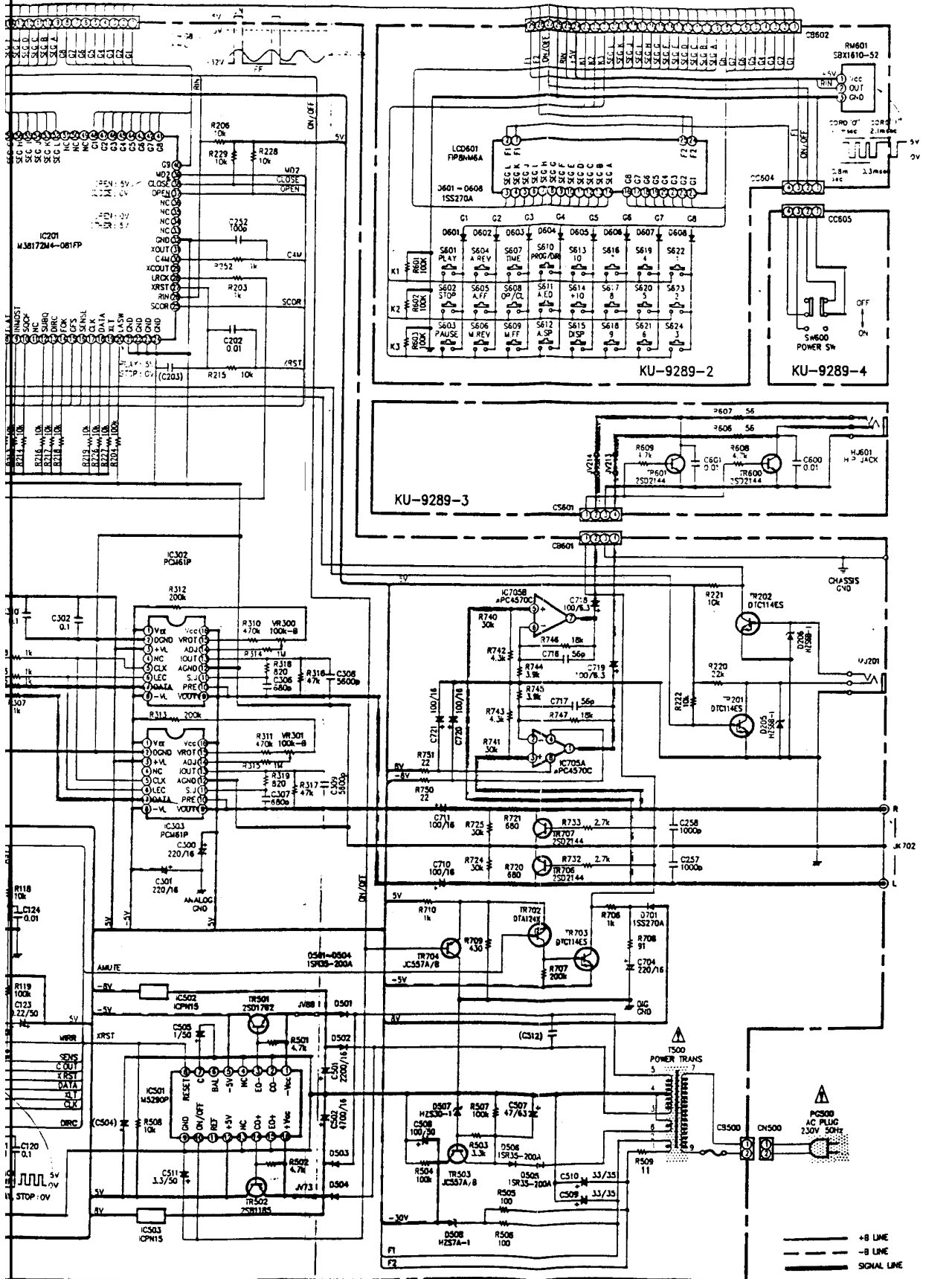

If (2) a line to chassis resistance check, if the reading is less than 240 ohms, the unit is defective.

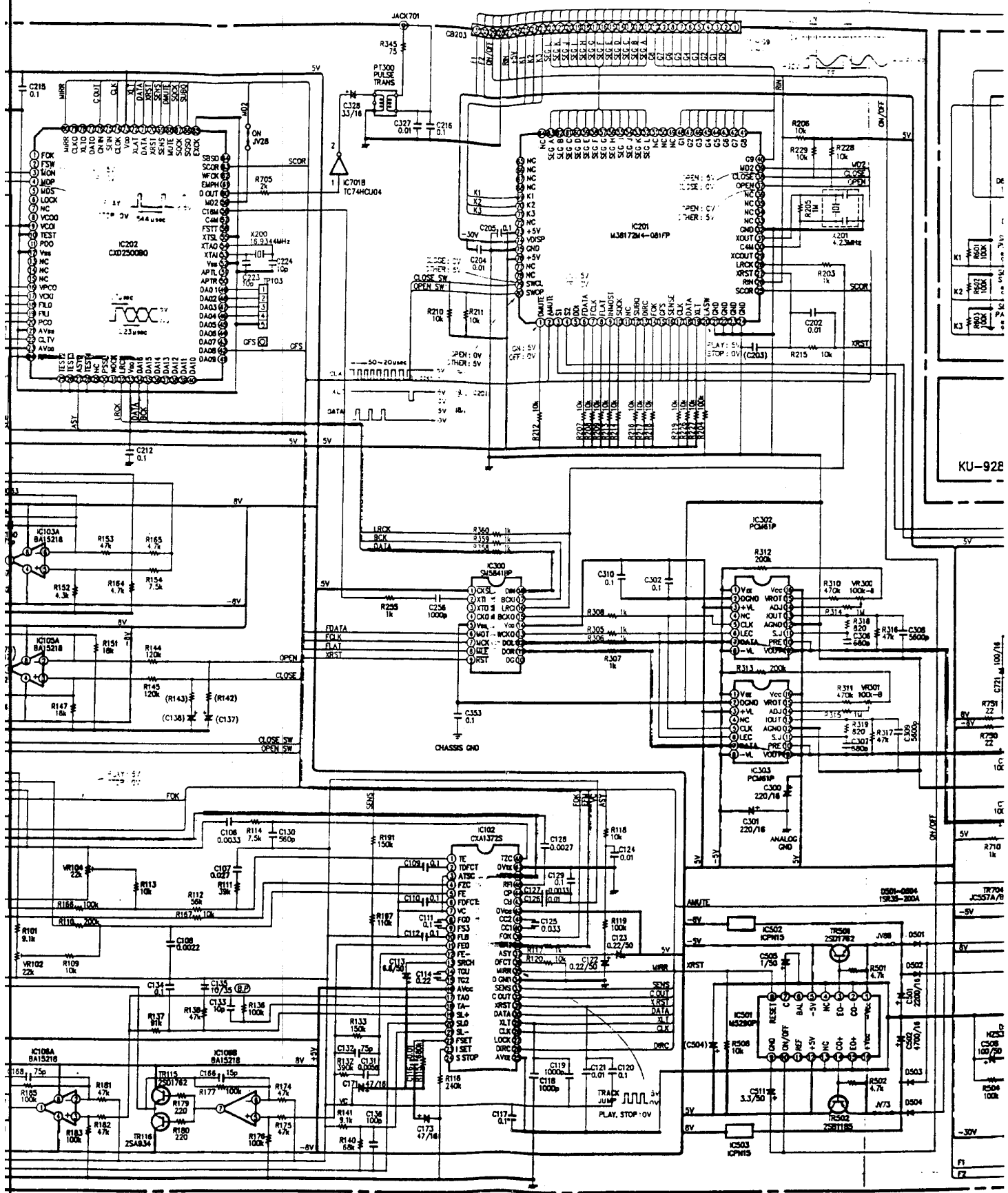

WARNING:
Parts marked with this symbol  have critical characteristics. Use ONLY replacement parts recommended by the manufacturer.

CAUTION:
Before returning the unit to the customer, make sure you make either (1) a leakage current check or (2) a line-to-chassis resistance check. If the leakage current exceeds 0.5 milliamperes, or if the resistance from chassis to other side of the power cord is less than 240 kilohms, the unit is defective.

WARNING:
DO NOT return the unit to the customer until the problem is located and corrected.

NOTES:
Circuit and parts are subject to change without prior notice.

NO
ALL
ALI
EA
CF

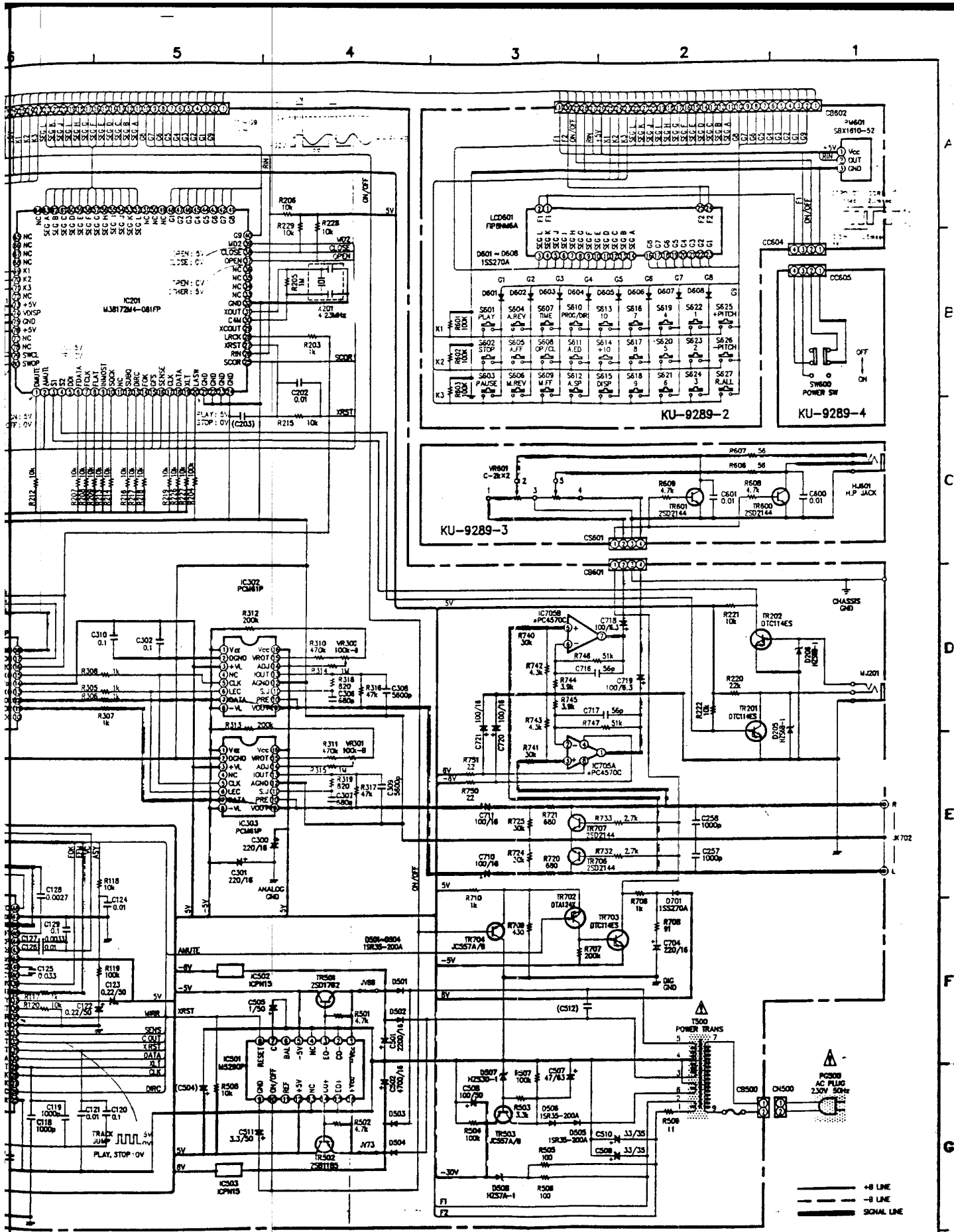

⚠ Symbol have critical characteristics. Use parts recommended by the manufacturer.

Send to the customer, make sure you make either (1) a leakage current check or (2) a line to chassis resistance check. If the line to chassis resistance, or if the resistance from chassis to other side of the power cord is less than 200 ohms, the unit is defective.

Send to the customer until the problem is located and corrected.

Subject to change without prior notice.

NOTES
 ALL RESISTANCE VALUES IN OHM. K=1,000 OHM, M=1,000,000 OHM
 ALL CAPACITANCE VALUES IN MICRO FARAD. P=MICRO-MICRO FARAD
 EACH VOLTAGE AND CURRENT ARE MEASURED AT NO SIGNAL INPUT CONDITION.
 CIRCUIT AND PARTS ARE SUBJECT TO CHANGE WITHOUT PRIOR NOTICE.

WIRING DIAGRAM

1 2 3 4 5 6 7 8

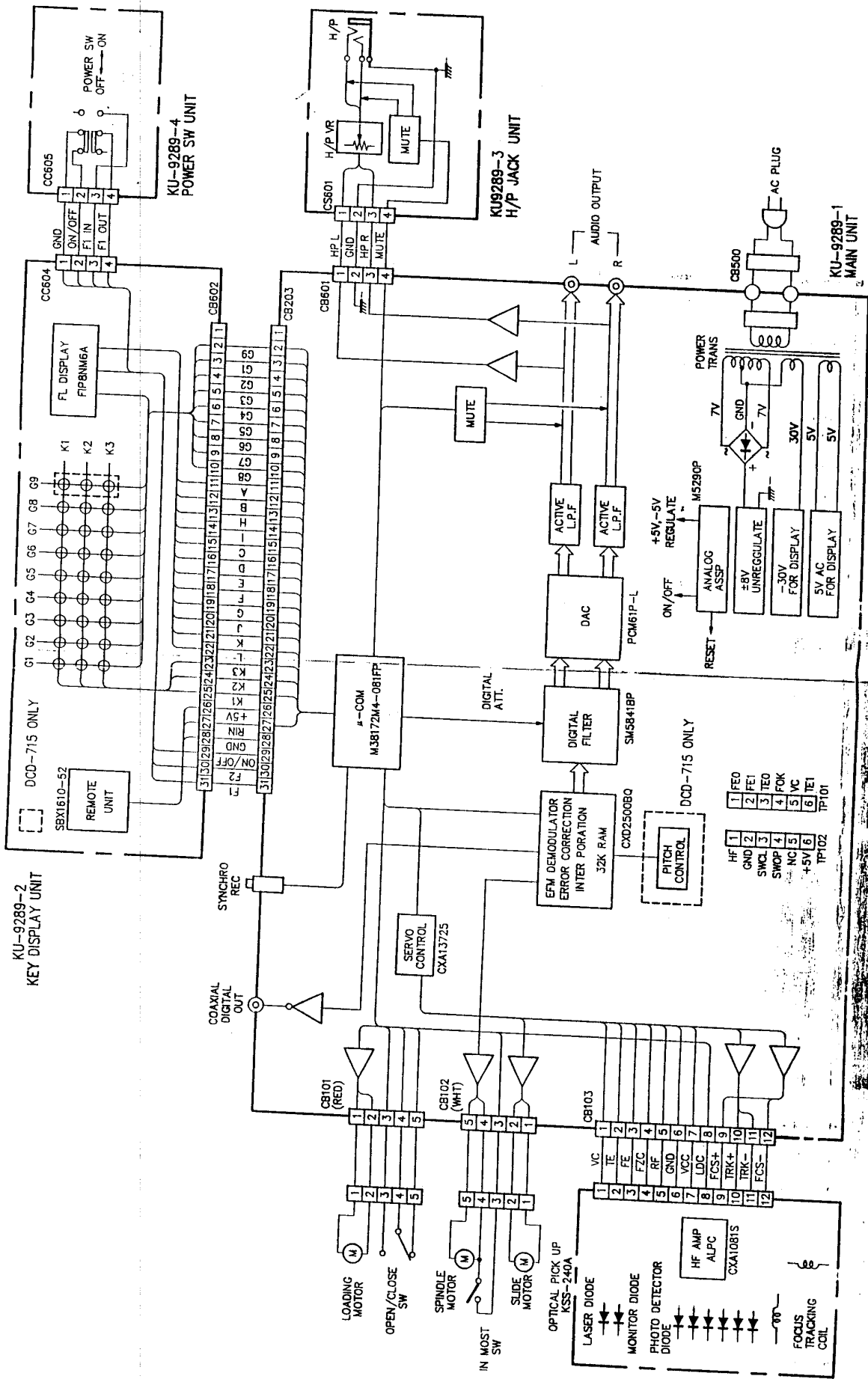

DCD-715 ONLY

1	FEO
2	FEI
3	TEO
4	FOK
5	VC
6	TEI
7	TP101

DCD-715 ONLY

1	HF
2	GND
3	SWOP
4	NC
5	3VC
6	TEI
7	TP102

P.W.BOARD

1 2 3 4 5 6 7 8

KU-9289 [Europe and U.K. Models]

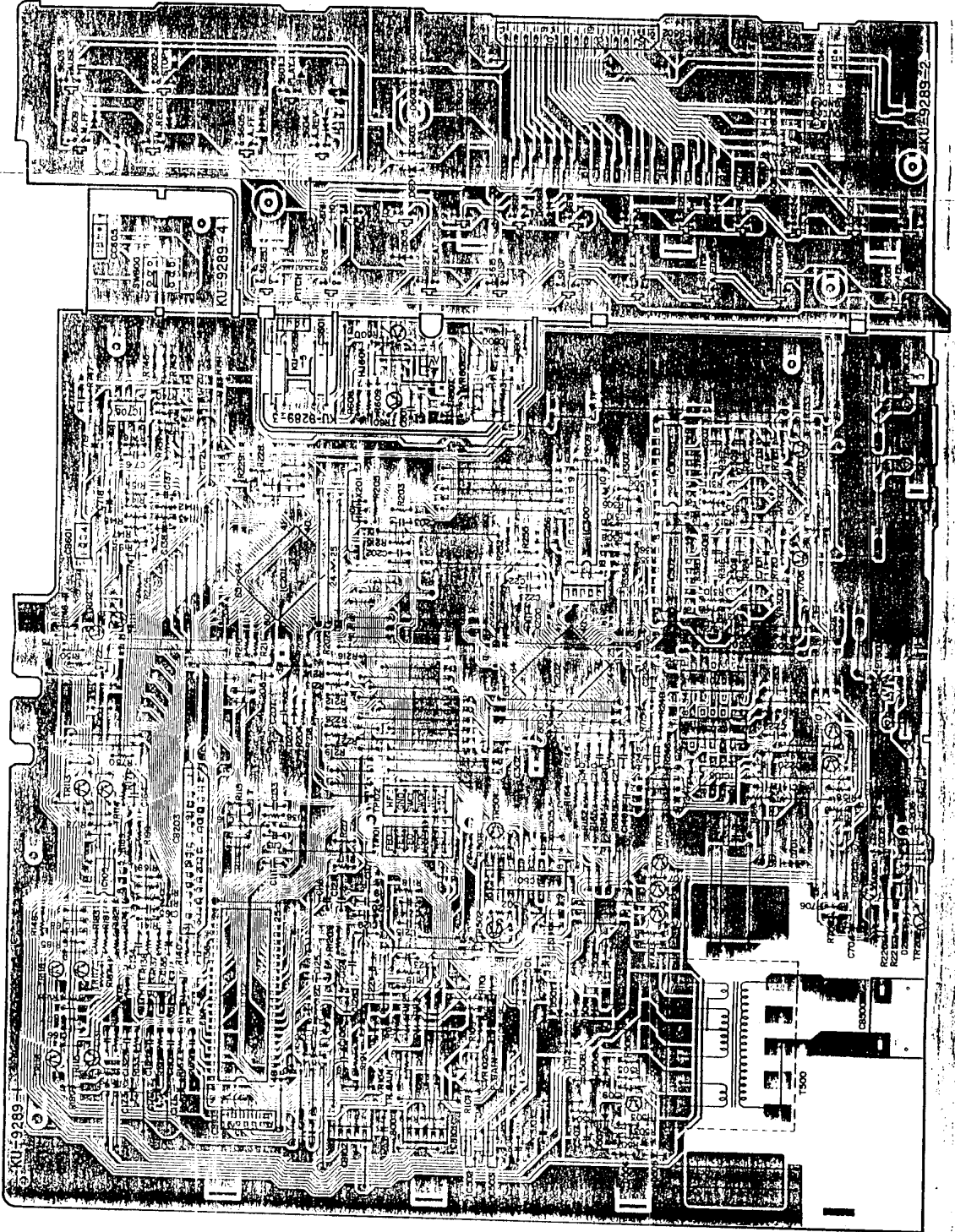

PARTS LIST OF FG-74 MECHANISM UNIT

Ref. No.	Part No.	Part Name	Remarks
2	9KA 90H0 06	FS FIXING SCREW	
3	9KA 90H0 05	FEED SHAFT	
7	9KA 80G0 17	DRIVE GEAR (A)	
8	9KA 80G0 18	DRIVE GEAR (B)	
9	499 0191 009	LASER P.U.	KSS-240A
12	9KS 01W1 47	LEAF SWITCH	
13	9KA 85P0 09	MOTOR P.W.B.	
15	009 0051 001	12P PFC CABLE	
16	443 1069 008	PFC BUSH	
17	9KA 82C2 53	SBB-PH CONNECTOR BASE	
18	9KM 20S0 04	2x4 SCREW	
19	9KA 85G0 26	MECHA. PLATE (FG70)	
20	9KA 85G0 27	MECHA. FRAME (FG70)	
21	9KA 85G0 21	CD TRAY (FG74)	
22	9KA 85G0 04	CLAMPER FRAME	
23	9KA 85G0 22	UD PLATE GEAR (FG70)	
24	9KA 85G0 06	CLAMPER (F)	
25	9KA 85G0 07	RELAY GEAR(A)	
26	9KA 85G0 08	RELAY GEAR(B)	
27	9KA 85G0 09	RELAY GEAR(C)	
28	9KA 85G0 10	GEAR BELT (F)	
29	9KA 85G0 30	DAMPER (FG40)	
30	9KA 85P0 01	CLAMPER PLATE (F)	
31	9KA 85H0 01	SCREW (F)	
34	9KA 82G0 57	MAGNET	
35	9KA 91H0 02	3x8 (H-10) SCREW	
36	9KB 30B0 08	3x8 BAND SCREW	
37	9KM 26B0 04	2.6x4 BAND SCREW	
39	9KA 82G3 08	S59-PH (RED)	
40	9KA 85G0 27	CNV2 (FG70)	
41	9KS 01W1 48	CPCL SWITCH (SSS12)	
42	9KA 85S0 01	SPRING (A) - Yellow	
43	9KA 85S0 02	SPRING (B) - Blue	
44	9KA 85S0 03	SPRING (C) - Natural	
45	9KA 85G0 33	GEAR GUIDE	
46	9KA 85G0 36	TRAY STOPPER	
47	9KB 20B0 05	2.5 BAND (B)	
48	9KS 21W6 04	STW2.1690.4	
50	9KA 85S0 05	HOLD SPRING	
60	9KA 85A0 07	SPINDLE MOTOR ASSY	9KA 90A0 38
61	9KA 85A0 08	FEED MOTOR ASSY	
62	9KA 85A0 06	LOADING MOTOR ASSY	
62-1		MOTOR P.W.B.	

EXPLODED VIEW OF FG-74 MECHANISM UNIT

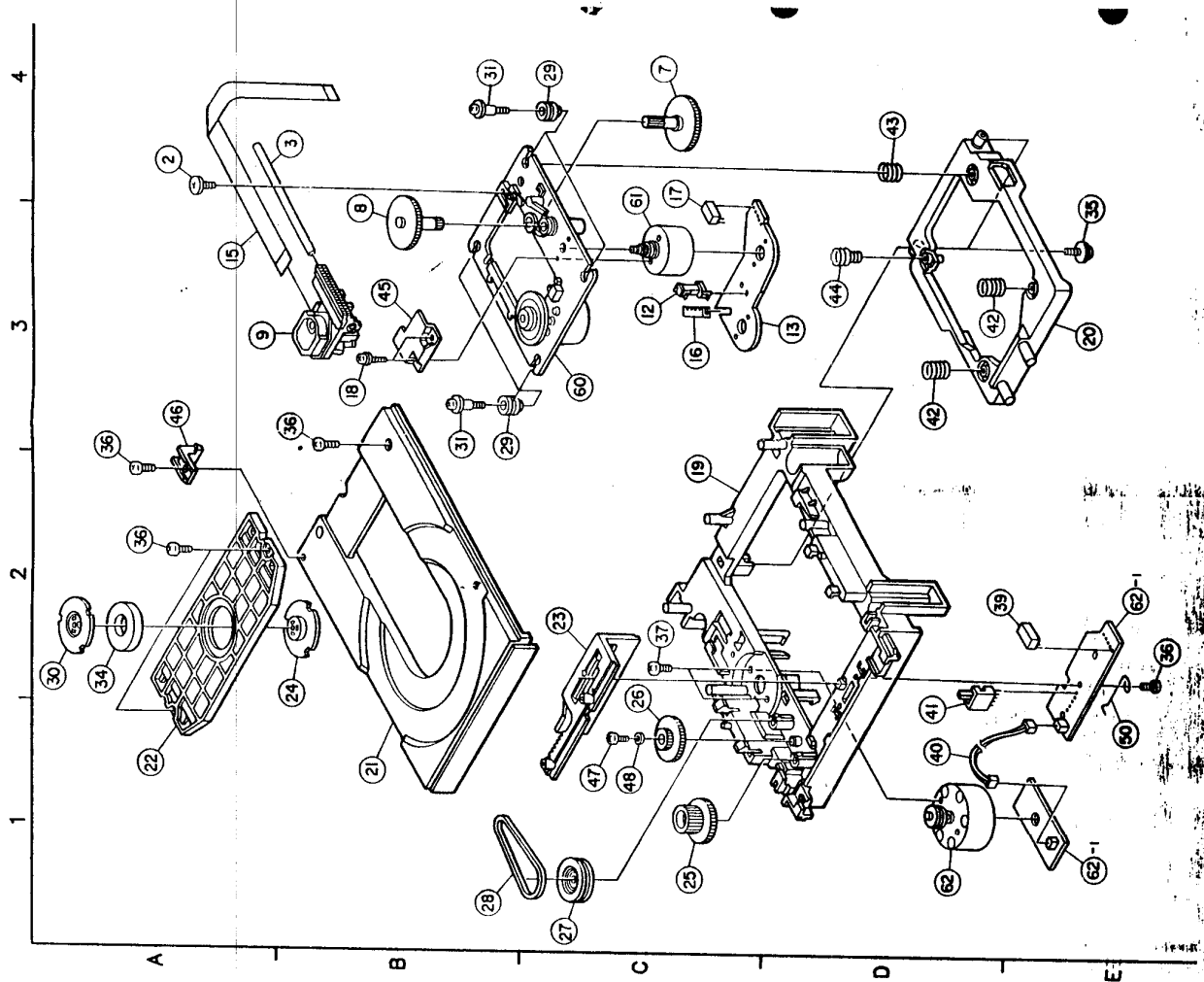

PARTS LIST OF FG-74 MECHANISM UNIT

Ref. No.	Part No.	Part Name	Remarks
2	9KA 9040 06	FS FIXING SCREW	
3	9KA 9040 05	FEED SHAFT	
7	9KA 8030 17	DRIVE GEAR (A)	
8	9KA 8030 18	DRIVE GEAR (B)	
9	499 0191 009	LASER PU	KSS-240A
12	9KS 01W1 47	LEAF SWITCH	
13	9KA 8590 09	MOTOR P.W.B.	
15	009 0051 001	12P FFC CABLE	
16	443 1083 006	FFC BUSH	
17	9KA 8262 53	SEB-PH CONNECTOR BASE	
18	9KM 2050 04	2x4 SCREW	
19	9KA 8530 26	MECHA. PLATE (FG70)	
20	9KA 8530 20	MECHA. FRAME (FG70)	
21	9KA 8530 21	CO TRAY (FG74)	
22	9KA 8530 04	CLAMPER FRAME	
23	9KA 8530 22	LD PLATE GEAR (FG70)	
24	9KA 8530 06	CLAMPER (F)	
25	9KA 8530 07	RELAY GEAR (A)	
26	9KA 8530 08	RELAY GEAR (B)	
27	9KA 8530 09	RELAY GEAR (C)	
28	9KA 8530 10	GEAR BELT (F)	
29	9KA 8530 30	DAMPER (FG40)	
30	9KA 8590 01	CLAMPER PLATE (F)	
31	9KA 8230 57	SCREW (F)	
34	9KA 9110 02	MAGNET	
35	9KB 3050 08	3x8 (M-10) SCREW	
36	9KA 2590 04	3x8 BAND SCREW	
37	9KA 8233 08	2.5x4 BAND SCREW	
39	9KA 8233 08	S5B-PH (RED)	
40	9KA 8530 27	C/W2 (FG70)	
41	9KS 01W1 48	OPTCL SWITCH (KSS12)	
42	9KA 8530 01	SPRING (A) - Yellow	
43	9KA 8530 02	SPRING (B) - Blue	
44	9KA 8530 03	SPRING (C) - natural	
45	9KA 8530 33	GEAR GUIDE	
46	9KA 8530 36	TRAY STOPPER	
47	9KB 2050 05	2x5 BAND (B)	
48	9KS 21W6 04	STV2.1x6x0.4	
50	9KA 8530 05	HOLD SPRING	
60	9KA 8540 07	SPINDLE MOTOR ASSY	
61	9KA 8540 08	FEED MOTOR ASSY	
62	9KA 8540 06	LOADING MOTOR ASSY	
62-1		MOTOR P.W.B.	

EXPLODED VIEW OF FG-74 MECHANISM UNIT

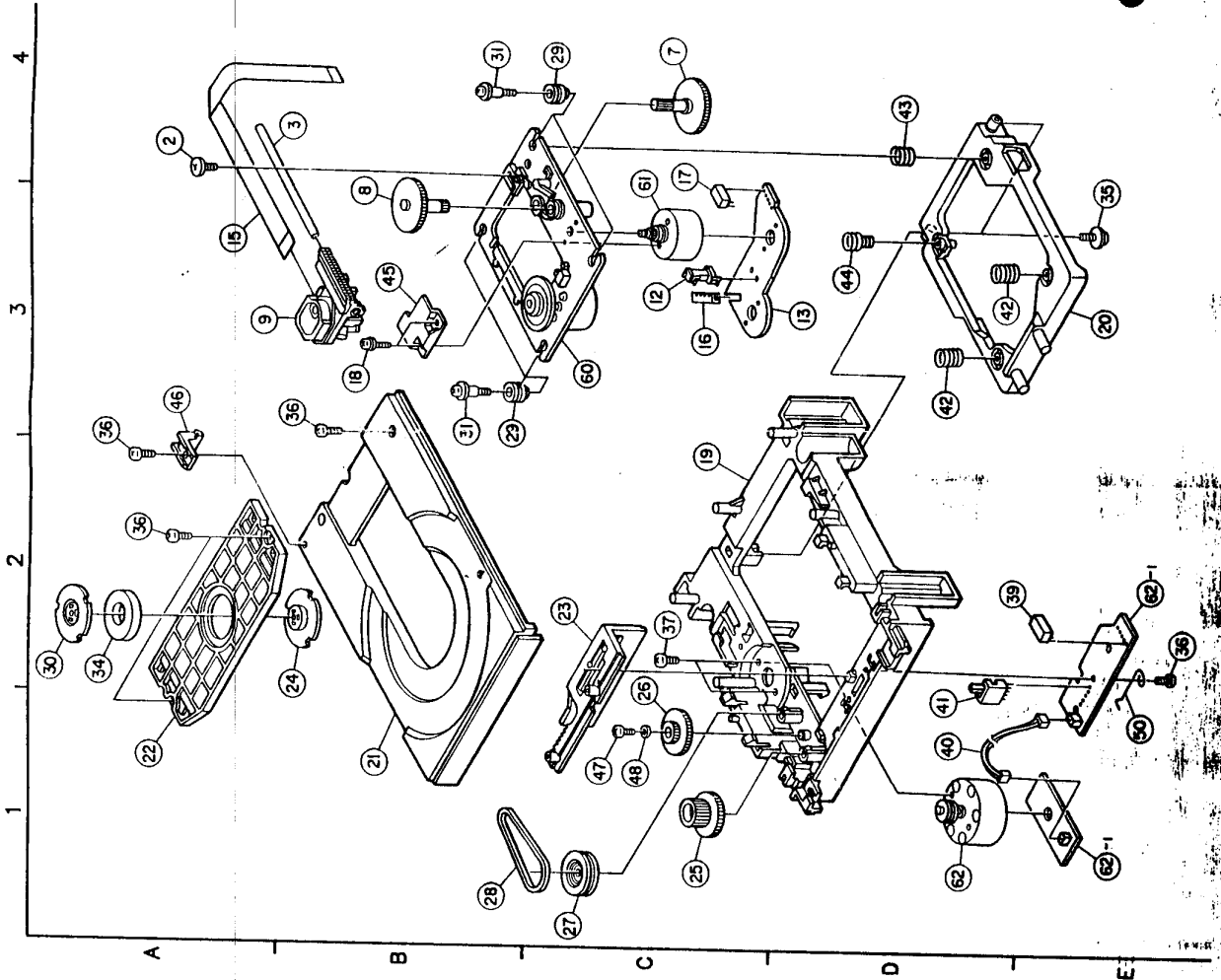

EXPLODED VIEW

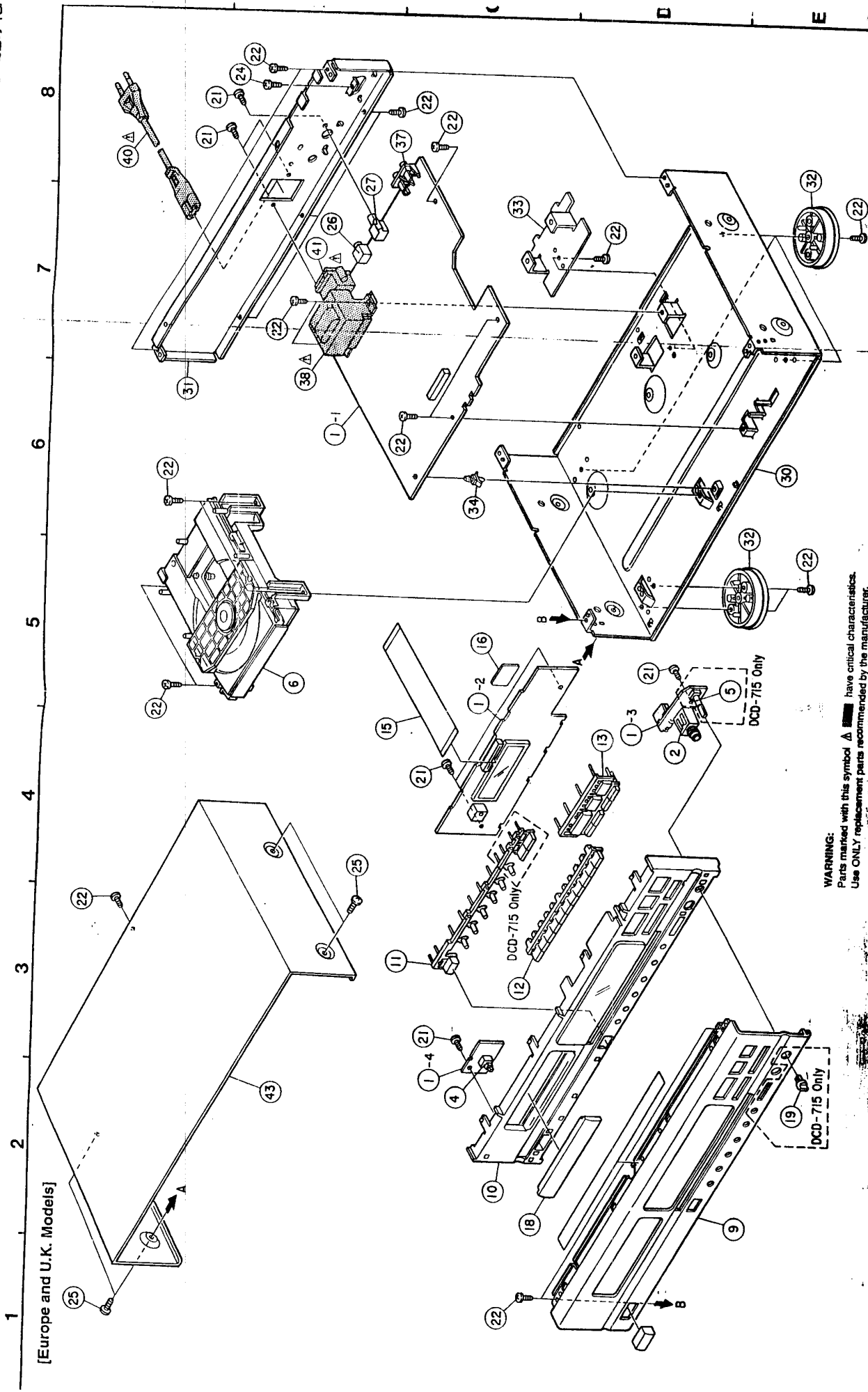

[Europe and U.K. Models]

DCD-715 Only

DCD-715 Only

WARNING:
Parts marked with this symbol  have critical characteristics.
Use ONLY replacement parts recommended by the manufacturer.

PARTS LIST OF PACKING & ACCESSORIES (DCD-715)

[DCD-715 Europe and U.K.Models]

Ref. No.	Part No.	Part Name	Remarks	Q'ty
	505 0131 050	CABINET COVER		1
	503 9223 002	:CUSHION	Europe	2
	502 0856 006	:PAD	U.K.	2
	501 1803 000	:CARTON CASE	Europe	1
	501 1817 012	:CARTON CASE	U.K.	1
	505 9125 009	:POLY COVER	Accessories	1
	511 2636 008	:INST. MANUAL		1
	203 2310 009	2P PIN CORD		1
	499 0243 009	:RC-241 (REMOTE CONTROL UNIT)		1
⚠	206 2108 003	:AC CORD WITH PLUG	Europe	1
⚠	206 2113 001	:AC CORD WITH CONNECTOR	U.K.	1
	513 9111 001	COLOR LABEL (Gold)	(Gold) only	1

For Service Manuals Contact
MAURITRON TECHNICAL SERVICES
 8 Cherry Tree Rd, Chinnor
 Oxon OX9 4QY
 Tel:- 01844-351694 Fax:- 01844-352554
 Email:- enquiries@mauritron.co.uk

(DCD-615)

[Europe and U.K. Models]

Ref. No.	Part No.	Part Name	Remarks	Q'ty
	505 0131 050	CABINET COVER		1
	503 9223 002	:CUSHION	Europe	2
	502 0865 006	:PAD	U.K.	2
	501 1803 013	:CARTON CASE	Europe	1
	501 1817 009	:CARTON CASE	U.K.	1
	505 9125 009	:POLY COVER	Accessories	1
	511 2636 008	:INST. MANUAL		1
	203 2310 009	2P PIN CORD		1
	499 0243 009	:RC-241 (REMOTE CONTROL UNIT)		1
⚠	206 2108 003	:AC CORD WITH PLUG	Europe	1
⚠	206 2113 001	:AC CORD WITH CONNECTOR	U.K.	1
	513 9111 001	COLOR LABEL (Gold)	(Gold) only	1

WARNING:

- Parts marked with " ⚠ " and/or shading have special characteristics important to safety.
- Part indicated with the mark " © " are not always in stock and possibly to take a long period of time for supplying, or in some case supplying of part may be refused.

PARTS LIST OF EXPLODED VIEW

DCD-715 [Europe and U.K. Models]

Ref. No.	Part No.	Part Name	Remarks
1	KU-9289	MAIN UNIT	
1-1		MAIN UNIT	
1-2		DISPLAY / KEY UNIT	
1-3		HEAD PHONE UNIT	
1-4		POWER SWITCH UNIT	
2	204 8364 007	HEAD PHONE JACK	HJ601
3	393 4110 005	FL TUBE (FIP8NM6A)	
4	212 1039 000	1P PUSH SWITCH	SW600
5	211 0661 010	VARIABLE RESISTOR	VR601
6	337 0034 004	CD MECHA. UNIT (FG-74)	
7	122 0187 100	TOP COVER SPACER	
9	144 2389 003	FRONT PANEL	
	144 2389 029	FRONT PANEL	(Gold)
10	146 1510 206	INNER PANEL ASS'Y	
	146 1510 219	INNER PANEL ASS'Y	(Gold)
11	113 1688 109	SERIES KNOB	
	113 1688 125	SERIES KNOB	(Gold)
12	113 9245 214	TENKEY	
	113 9245 227	TENKEY	(Gold)
13	113 1687 100	FUNCTION KNOB	
	113 1687 113	FUNCTION KNOB	(Gold)
15	009 0110 007	31P FFC CORD	
16	461 0864 001	SPACER	
17	113 1689 001	POWER SWITCH KNOB	
	113 1689 014	POWER SWITCH KNOB	(Gold)
18	146 1512 026	LOADER PANEL	
	146 1512 013	LOADER PANEL	(Gold)
19	112 0645 111	HEAD PHONE KNOB	
	112 0645 124	HEAD PHONE KNOB	(Gold)
21	473 7508 017	3x10 CBTS(P)-B	
22	473 7002 021	3x8 CBTS(S)-B	
24	473 7002 005	3x6 CBTS(S)-Z	
25	473 7007 000	4x8 CBTS(S)-B	
	473 4801 005	4x8 CTTS	(Gold)
26	204 8416 007	MINI JACK	MJ201
27	204 8262 002	1P PIN JACK	JK701
30	411 1233 005	:CHASSIS	
31	105 1086 205	:BACK PANEL	
32	104 0228 401	:FOOT ASS'Y	
33	441 1608 107	BOTTOM PLATE	
34	443 1003 009	:P.C.B. SPACER	
37	204 8311 021	2P PIN JACK	JK702
38	233 5964 000	:POWER TRANSFORMER (E2)	
40	206 2108 003	:AC CORD WITH PLUG (E2)	Europe
	206 2113 001	:AC CORD WITH (E2)	U.K.
	206 2113 001	:AC CORD WITH (E2)	U.K.
	206 2113 001	:AC CORD WITH (E2)	U.K.
41	203 2349 009	AC INLET (E2)	
43	102 0424 005	:TOP COVER	
	102 0424 018	:TOP COVER	(Gold)

DCD-615 [Europe and U.K. Models]

Ref. No.	Part No.	Part Name	Remarks
1	KU-9289A	MAIN UNIT	
1-1		MAIN UNIT	
1-2		DISPLAY / KEY UNIT	
1-3		HEAD PHONE UNIT	
1-4		POWER SWITCH UNIT	
2	204 8364 007	HEAD PHONE JACK	HJ601
3	393 4110 005	FL TUBE (FIP8NM6A)	
4	212 1039 000	1P PUSH SWITCH	SW600
6	337 0034 004	CD MECHA. UNIT (FG-74)	
7	122 0187 100	TOP COVER SPACER	
9	144 2389 016	FRONT PANEL	
	144 2389 032	FRONT PANEL	(Gold)
10	146 1510 206	INNER PANEL ASS'Y	
	146 1510 219	INNER PANEL ASS'Y	(Gold)
11	113 1688 112	SERIES KNOB	
	113 1688 138	SERIES KNOB	(Gold)
12	113 9245 214	TENKEY	
	113 9245 227	TENKEY	(Gold)
13	113 1687 100	FUNCTION KNOB	
	113 1687 113	FUNCTION KNOB	(Gold)
15	009 0109 005	29P FFC CORD	
16	461 0864 001	SPACER	
17	113 1689 001	POWER SWITCH KNOB	
	113 1689 014	POWER SWITCH KNOB	(Gold)
18	146 1512 026	LOADER PANEL	
	146 1512 013	LOADER PANEL	(Gold)
21	473 7508 017	3x10 CBTS(P)-B	
22	473 7002 021	3x8 CBTS(S)-B	
24	473 7002 005	3x6 CBTS(S)-Z	
25	473 7007 000	4x8 CBTS(S)-B	
	473 4801 005	4x8 CTTS	(Gold)
26	204 8416 007	MINI JACK	MJ201
30	411 1233 005	:CHASSIS	
31	105 1086 205	:BACK PANEL	
32	104 0228 401	:FOOT ASS'Y	
33	441 1608 107	BOTTOM PLATE	
34	443 1003 009	:P.C.B. SPACER	
37	204 8311 021	2P PIN JACK	JK702
38	233 5964 000	:POWER TRANSFORMER (E2)	
40	206 2108 003	:AC CORD WITH PLUG (E2)	Europe
	206 2113 001	:AC CORD WITH (E2)	U.K.
	206 2113 001	:AC CORD WITH (E2)	U.K.
	206 2113 001	:AC CORD WITH (E2)	U.K.
41	203 2349 009	AC INLET (E2)	
43	102 0424 005	:TOP COVER	
	102 0424 018	:TOP COVER	(Gold)

PARTS LIST OF P.W.BOARD

KU-9289 MAIN UNIT [Europe and U.K. Models]

Ref. No.	Part No.	Part Name	Remarks	Ref. No.	Part No.	Part Name	Remarks
SEMICONDUCTORS GROUP							
IC102	262 1305 001	IC CXA1372S		C126	253 9030 963	Ceramic 0.01μF/25V	CK45=1E103KT
IC103	263 0565 007	IC BA15218		C127	253 9030 934	Ceramic 0.0033μF/25V	CK45=1E272KT
IC105.106	263 0565 007	IC BA15218		C128	253 9031 962	Ceramic 0.0027μF/25V	CK45=1E333KT
IC201	262 1846 007	μ-COMPUTER M38172M4-081FP		C129	253 9036 909	Ceramic 0.1μF/25V	CK45=1E104ZT
IC202	262 1819 005	IC :CXD2500BQ		C130	253 1179 990	Ceramic 560pF/50V	CK45B1H561KT
IC203	262 0824 004	IC :SN74LS624N	(DCD-715 Only)	C131	253 9031 988	Ceramic 0.0056μF/25V	CK45=1E562KT
IC300	262 1761 001	IC SM5841BP		C132	253 4538 910	Ceramic 75pF/50V	CK45SL1H750JT
IC302.303	262 1409 004	IC :PCM61P-L		C133	253 4536 909	Ceramic 10pF/50V	CC45SL1H100DT
IC501	263 0693 005	IC M5290P		C134	256 1034 979	Metalized 0.1μF/50V	CF93A1H104JT
IC502.503	268 0073 905	IC Protector ICP-N15T		C135	254 3055 918	Electrolytic 10μF/35V Bipolar	CE04D1V100MBPT
IC701	262 1265 002	IC TC74HCU04AP		C136	253 4538 949	Ceramic 100pF/50V	CC45SL1H101JT
IC705	262 0864 006	IC μPC4570C		C140	253 4538 910	Ceramic 75pF/50V	CC45SL1H750JT
TR109	237 0195 908	Transistor 2SC2060(Q)TP		C141	253 9030 934	Ceramic 0.0033μF/25V	CK45=1E332KT
TR110	271 0271 907	Transistor 2SA934(Q)TP		C142	253 9039 906	Ceramic 0.1μF/25V	CK45=1E104ZT
TR111	273 0195 908	Transistor 2SC2060(Q)TP		C164	253 4536 941	Ceramic 15pF/50V	CC45SL1H150JT
TR112	271 0271 907	Transistor 2SA934(Q)TP		C166	253 4536 941	Ceramic 15pF/50V	CC45SL1H150JT
TR113	273 0195 908	Transistor 2SC2060(Q)TP		C168	253 4538 910	Ceramic 75pF/50V	CC45SL1H103ZT
TR114	271 0271 907	Transistor 2SA934(Q)TP		C170.171	254 4254 938	Electrolytic 47μF/16V	CE04W1C470MT
TR115	274 0120 002	Transistor 2SD1762(E/F)		C173	254 4254 938	Electrolytic 47μF/16V	CE04W1C470MT
TR116	271 0271 907	Transistor 2SA934(Q)TP		C174	253 9039 906	Ceramic 0.1μF/25V	CK45=1E104ZT
TR117	273 0195 908	Transistor 2SC2060(Q)TP		C202-204	253 1181 904	Ceramic 0.01μF/50V	CK45=1E104ZT
TR118	271 0271 907	Transistor 2SA934(Q)TP		C205	253 9039 906	Ceramic 0.1μF/25V	CK45=1E104ZT
TR201.202	269 0020 906	Transistor DTC114ES (10K-10K)T	Built in resistor	C210	253 9031 904	Ceramic 0.047μF/25V	CK45=1E473KT
TR501	274 0120 002	Transistor 2SD1762(E/F)		C211	253 1180 947	Ceramic 0.0015μF/50V	CK45B1H152KT
TR502	272 0083 004	Transistor 2SB1185(E/F)		C212.213	253 9039 906	Ceramic 0.1μF/25V	CK45=1E104ZT
TR503	271 0387 901	Transistor :JC557 A/B		C214	254 4250 932	Electrolytic 220μF/6.3V	CE04W0J221MT
TR600.601	274 0160 907	Transistor 2SD2144STPU	Built in resistor	C215.216	253 9036 906	Ceramic 0.1μF/25V	CK45=1E104ZT
TR702	269 0014 909	Transistor DTA124XS(22K-47K)T	Built in resistor	C220	254 4260 922	Electrolytic 0.33μF/50V	CE04W1HR33MT
TR703	269 0020 906	Transistor DTC114ES(10K-10K)T	Built in resistor	C222	253 4537 937	Ceramic 36pF/50V	(DCD-715 Only) CC45SL1H360JT
TR704	271 0387 901	Transistor :JC557 A/B		C223.224	253 4536 909	Ceramic 10pF/50V	CC45SL1H100JT
TR706.707	274 0160 907	Transistor 2SD2144STPU		C252	253 4598 949	Ceramic 100pF/50V	CC45SL1H101JT
D205.206	276 0462 902	Zener Diode HZS6B-1TD		C253	253 9039 906	Ceramic 0.1μF/50V	CC45SL1H101JT
D501-506	276 0553 905	Diode 1SR35-200A(T93X)		C256	253 1180 921	Ceramic 0.001μF/50V	(DCD-615 Only) CK45=1E104ZT
D507	276 0483 907	Zener Diode HZS30-1TD		C257.258	253 1180 921	Ceramic 0.001μF/50V	CK45B1H102KT
D508	276 0464 900	Zener Diode HZS7A-1TD		C300.301	254 4254 954	Electrolytic 220μF/16V	CK45B1H102KT
D601-608	276 0432 903	Diode 1SS270A TE		C302	253 9039 906	Ceramic 0.1μF/25V	CE04W1C221MT
D701	276 0432 903	Diode 1SS270A TE		C306.307	253 1180 905	Ceramic 680pF/50V	CK45=1E104ZT
RESISTORS GROUP				C308.309	253 1121 906	Ceramic 0.0056μF/50V	CK45B1H681KT
(Not included Carbon film ±5%, 1/4W Type)				C327	253 1181 904	Ceramic 0.01μF/50V	CK45F1H103ZT
VR102.104	211 6093 954	Adjust 22kohm	V06PB223T	C328	253 4254 925	Electrolytic 33μF/16V	CE04W1C330MT
VR300.301	211 6093 970	Adjust 100kohm	V06PB104T	C501	254 4254 792	Electrolytic 2200μF/16V	CE04W1C222MC
VR601	211 0661 010	Variable 2kohm	V0920P30FC202 (DCD-715 Only)	C502	254 4255 717	Electrolytic 4700μF/16V	CE04W1C472MC
CAPACITORS GROUP				C505	254 4260 948	Electrolytic 1μF/50V	CE04W1H010MT
C102	253 9039 906	Ceramic 0.1μF/25V	CK45=1E104ZT	C507	254 4262 946	Electrolytic 47μF/63V	CE04W1J470MT
C106	253 9030 934	Ceramic 0.0033μF/25V	CK45=1E332KT	C508	254 4261 921	Electrolytic 100μF/50V	CE04W1H101MT
C107	253 9035 926	Ceramic 0.027μF/50V	CF45=1E273KT	C509.510	254 4258 934	Electrolytic 33μF/35V	CE04W1V320MT
C108	253 9030 921	Ceramic 0.0022μF/25V	CK45=1E222KT	C511	254 4260 964	Electrolytic 3.3μF/50V	CE04W1H3R3MT
C109-112	256 1034 979	Metalized 0.1μF/50V	CF93A1H104JT	C600.601	253 1181 904	Ceramic 0.01μF/50V	CK45F1H103ZT
C113	254 4337 910	Electrolytic 6.8μF/50V	CE04W1H6R8MT	C704	254 4254 954	Electrolytic 220μF/16V	CE04W1C221MT
C114	256 1035 910	Metalized 0.22μF/50V	CF93A1H224JT	C710.711	254 4254 941	Electrolytic 100μF/16V	CE04W1C101MT
C116	253 9030 963	Ceramic 0.01μF/25V	CK45=1E103KT	C715	253 1180 921	Ceramic 0.001μF/50V	CK45B1H102KT
C117	253 9039 906	Ceramic 0.1μF/25V	CK45=1E104ZT	C716.717	253 4537 982	Ceramic 56pF/50V	(DCD-715 Only) CC45SL1H560JT
C118.119	253 1180 921	Ceramic 0.001μF/50V	CK45B1H102KT	C718.719	254 4250 929	Electrolytic 100μF/6.3V	CE04W0J101MT
C120	253 9039 906	Ceramic 0.1μF/25V	CK45=1E104ZT	C720.721	254 4254 941	Electrolytic 100μF/16V	CE04W1C101MT
C121	253 1181 904	Ceramic 0.01μF/50V	CK45F1H103ZT				
C122.123	254 4260 919	Electrolytic 0.22μF/50V	CE04W1HR22MT				
C124	253 9030 963	Ceramic 0.01μF/25V	CK45=1E103KT				
C125	253 9030 992	Ceramic 0.033μF/25V	CK45=1E333KT				

Ref. No.	Part No.	Part Name	Remarks
OTHER PARTS			
X200	399 0112 005	:Crystal Resonator	(16.9344MHz)
X201	399 0111 006	Ceramic Resonator CST4.23MGW040	(DCD-715 Only)
RM601	499 0150 008	Remote Sensor	SBX1610-52
PT300	231 8063 009	:Pulse Transa	
HJ601	204 8364 007	Head Phone Jack	
JK701	204 8262 002	1P Pin Jack	(Digital Out)
JK702	204 8311 021	2P Pin Jack	(Line Out)
ML201	204 8416 007	MINI JACK	(SYNCHRO REC)
SW600	212 1039 000	1P Push Switch	(POWER ON-OFF)
LCD601	393 4110 005	FL Tube	(FIP8NM6A)
CB101	205 0321 054	5P Connector Base(Red)	
CB102	205 0343 058	5P Connector Base(KR-PH)	
CB103	205 0892 004	FFC Connector Base(12P)	
CB203	205 0549 001	31P FFC Connector Base	(DCD-715)
CB203	205 0549 027	29P FFC Connector Base	(DCD-615)
CB501	203 2349 009	2P Inlet	
CB601	205 0535 060	4P Connector Base	
CB602	205 0549 001	31P FFC Connector Base	(DCD-715)
CB602	205 0549 027	29P FFC Connector Base	(DCD-615)
CS601	205 0637 007	4P Connector Socket	
TP101,102	205 0190 065	6P NH Connector Base	
A1E00	233 5964 000	Power Transformer (E2)	