

DENON

Hi Fi Component

SERVICE MANUAL

FULLY AUTOMATIC DIRECT DRIVE TURNTABLE SYSTEM

MODEL DP-37F SERIES

U.S. and Canadian models do not include cartridge.



NIPPON COLUMBIA CO., LTD.

TABLE OF CONTENTS

FEATURES	2
SPECIFICATIONS	3
BLOCK DIAGRAM	4
PART NAMES AND FUNCTION	5
ADJUSTMENT METHOD	6~7
EXPLANATION HOW THE LSI QUARTZ PLL MOTOR CONTROL OPERATES	8
PARTS LIST OF P.W. BOARD	9
PARTS LIST OF EXPLODED VIEW	10
EXPLODED VIEW	11
SCHEMATIC DIAGRAM	12
CONNECTIONS OF P.W. BOARD	13
P.W. BOARD OF KU-5280 SERVO CONTROL UNIT	14
P.W. BOARD OF KU-5014 MOTOR DRIVE UNIT	15

FEATURES

1. Microprocessor controlled, contactless servo tonearm

A unique microprocessor controlled, contactless servo tonearm ensures safe, easy to use automatic operation with no deterioration in sound quality.

2. Q-damping method (Dynamic servo tracer)

Low frequency resonance caused by the cartridge compliance and the effective tonearm mass is electronically damped both horizontally and vertically to effectively suppress crosstalk and inter-modulation distortion. The dynamic servo tracer maximizes the performance of the low mass tonearm and results in a record reproduction of excellent sound image with minimum noise and distortion.

3. Low mass straight arm

Having an outstanding tracing ability, this arm maximizes the performance of the high compliance cartridge to the full extent. Even with the most up-to-date high grade records, its tracing ability is excellent.

4. DENON quartz on bi-directional servo

The ultimate in rotational accuracy is realized by the combination of a magnetic pulse detector and a quartz lock, with the addition of a bi-directional servo.

5. Newly developed cartridge

The low mass MM type cartridge DL-65 with an elliptically shaped stylus minimizes tracing distortion and contributes to the clarity of the reproduced sound.

6. Newly developed cartridge (European model only)

A high output MC cartridge with an output voltage comparable to MM cartridges.

The DL-110 is a high output MC cartridge which can be connected directly to the MM position of the amplifier without step-up transformers or head amplifiers.

Note: U.S. & Canadian models do not include cartridge.

SPECIFICATIONS

• Phono motor section

Drive system :	Servo controlled direct drive
Turntable speeds :	33-1/3, 45 rpm
Wow & Flutter :	Below 0.012% wrms (servo system) Below 0.02% wrms (JIS)
S/N ratio :	Over 78 dB (DIN-B)
Rise time :	Normal speed within 2 seconds (at 33-1/3 rpm)
Turntable platter:	Aluminum die-cast; 300 mm diameter
Motor :	Linear drive motor
Speed control system :	Speed servo by frequency detection and phase servo control
Speed deviation :	Below 0.01%
Load characteristics :	0% (80 g stylus force; outermost groove)

• Tonearm section

Arm type :	Dynamically balanced, straight tube tonearm
Effective length :	220 mm
Overhang :	16 mm
Tracking error :	Within 3°
Automatic mechanism :	Electronically controlled, fully automatic
Adjustable stylus force range :	0 ~ 3.0 g (1 scale=0.1 g)
Suitable cartridge weight range :	Approximately 4.0 ~ 9.0 g (including screws, nuts)

• Cartridge section :

Model :	(Asian model) DL-65	(European model) DL-110M
Type :	Moving magnet (MM)	Moving coil (MC)
Output voltage :	2.5mV	1.8mV
Frequency response :	20 Hz ~ 30 kHz	20 Hz ~ 45 kHz
Tracking force :	1.8 ± 0.3 g	1.8 ± 0.3 g

• General

Power supply :	50/60 Hz, Voltage is shown on rating label
Power consumption :	Approx. 8W
Dimensions :	434 (W) x 145 (H) x 410 (D) mm 17 (W) x 5.7 (H) x 16.1 (D) in
Weight :	Approx. 7.0 kg Approx. 15 lb

• U.S. and Canadian models do not include cartridge.

Above specifications and outward appearance may be altered in future for improvement.

WARNING:

1. Component parts

Parts marked with  and/or shading in this service manual have special characteristics important to safety. Be sure to use the specified parts for replacement.

2. Leakage current

Before returning the appliance to customer, test the leakage current when the power plug is connected. Use a calibrated (with an error of not more than 5%) leakage current tester and measure the leakage current from any exposed metal to the earth ground. Reverse the power plug polarity and test the above again.

Any current measured MUST NOT EXCEED 0.5 milliamps. Corrective measure must be taken if it exceeds the limit.

BLOCK DIAGRAM

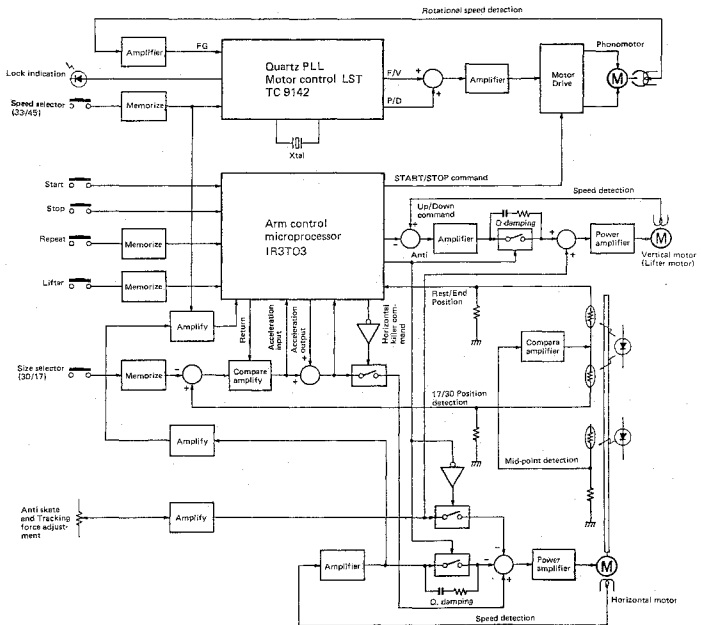

PART NAMES AND FUNCTION

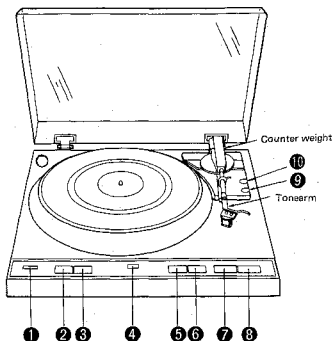

1 Power switch POWER

This turns the power supply on and off. Push the button down until it locks. When turning the power off, press the button until the lock is disengaged. Be sure to return the tonearm to the arm rest and hold it in with the clamp.

2 Record size selector switch SIZE

Before playing a record, press the button corresponding to its record size.
For 30 cm (12 inch) records, the (30) indicator will light.
For 17 cm (7 inch) records, the (17) indicator will light.

3 Speed selector switch SPEED

Before playing a record, press the button corresponding to its record speed.
The (33) indicator will light for 33 1/3 rpm records.
The (45) indicator will light for 45 rpm records.

4 Lock indicator LOCK

The lamp will light when the turntable reaches a nominal r.p.m. speed in the Play mode.

5 Arm lifter switch UP-LIFTER

Press this button to raise or lower the tonearm during play, or when playing records manually. The "UP" indicator will light up.

6 Repeat switch REPEAT-ON

Press this button for playing the same record repeatedly the "ON" indicator will light up.

7 Start switch START

Press this button to start records automatically.

8 Stop switch STOP

Press this button to stop a record during play.

9 Tracking force adjustment knob TRACKING

This knob is used to adjust the tracking force and anti-skating amount.

10 Q-damping adjustment knob Q-DAMPING

ADJUSTMENT METHOD

• PHONO MOTOR ADJUSTMENT

1. Off-set adjustment

- 1) Set the X-axis and Y-axis sensitivity of the oscilloscope to 100mV/cm by using a 10:1 probe.
- 2) Connect the X-axis terminal of the probe with TP-203 on the motor drive base board and the Y-axis terminal of the probe with TP-204. Use pin No. 8 as the ground.
- 3) Connect pin No. 5 and pin No. 8 and make a low resistance circuit on the input terminal.
- 4) Stop the rotor at the maximum position of the X-axis amplitude of the Lissajous' figure of the oscilloscope while turning the motor by hand.
- 5) Set the maximum amplitude at the X-axis by adjusting VR-201.
 $A = A'$
- 6) Stop the rotor at the maximum position of the Y-axis amplitude of the Lissajous' figure.
- 7) Set the maximum amplitude at the Y-axis by adjusting VR-202.
 $B = B'$
- 8) Adjust the center of the circle to $\pm 50\text{mV}$.

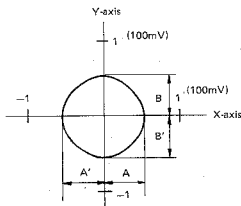

- 9) Disconnect pin No. 5 and pin No. 8 after adjustment.

2. Amplitude adjustment

- 1) Check the X-axis and Y-axis sensitivity of the oscilloscope by using $\pm 5\text{V}$ power supply.
- 2) Remove the arm from the arm rest and remove the turntable. Then, turn the motor with full speed.
- 3) Set the amplitude of the X-axis and Y-axis of the Lissajous' figure to 15 VP-P by adjusting VR-203 and VR-204. Make sure that there is no voltage difference between the X-axis and the Y-axis.

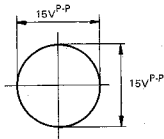

3. Center adjustment

- 1) Adjust the X-axis and Y-axis sensitivity of the oscilloscope to 2V/cm.
- 2) Set the amplitude of the X-axis and Y-axis of the Lissajous' figure to exactly the same point from the center by adjusting VR-205 and VR-206. After the adjustment, the amplitude should be as shown in the figure below.

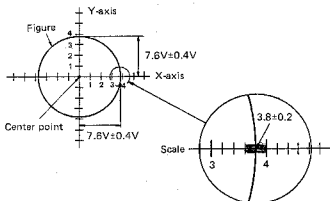

4. Adjusting the head gap

Adjust, so that the gap between the turntable magnetic coating surface and the detection head is 0.18 mm.

5. Checking the 33 r.p.m. and 45 r.p.m. locks

From now on, use test point TP-1 of the servo control circuit board as the earth reference point of the measuring instrument.

- 1) Connect an oscilloscope to test point TP-6.
- 2) Make sure to check that the voltage of TP-6 at normal speed is approximately 2.2 V.

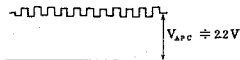

• ADJUSTING THE ARM CONTROL SECTION

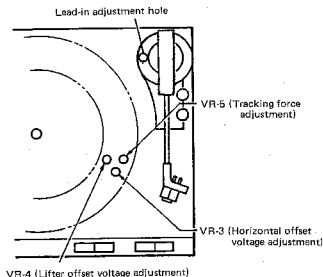

1. Adjusting the horizontal OP amp. offset voltage

- 1) Fix the tonearm to the arm rest and connect the oscilloscope to TP-3.
- 2) Set the lifter switch to the UP condition.
- 3) Turn VR-3 and adjust to $0V \pm 0.01V$.

2. Adjusting the lifter OP amp. offset voltage

- 1) Fix the tonearm to the arm rest and connect the oscilloscope to TP-4.
- 2) Set the lifter switch to the DOWN condition.
- 3) After about 7 seconds, adjust to $0V \pm 0.01V$ by turning VR-4.

3. Adjusting the tracking force

- 1) Turn the power supply switch OFF.
- 2) Take the arm off the arm rest. Rotate the balance weight so that the tonearm becomes parallel to the turntable surface when let go.
- 3) Return the arm to the arm rest and turn the power supply switch ON.
- 4) Wait seven seconds after the arm has lowered. Place the cartridge stylus tip onto a stylus force gauge and set the tracking force adjustment knob to 1.8g. (Note) At this time, the stylus tip height should be adjusted so that it is about the same height as during play.
- 5) Turn VR-5 and adjust, so that the stylus force gauge reads 1.8 g. (Turn VR slows.)

4. Adjusting the 30 cm lead-in position

- 1) Place a 30 cm record on the turntable and set the record size selector switch to "30". (Note) Keep the bottom cover closed.
- 2) Move the arm so that the stylus tip is at approximately the 30 cm lead-in position. Insert a small flat-headed screwdriver into the lead-in adjustment hole; move the arm back and forth and fit the screw driver into the groove of the cam inside gently.

- 3) After turning the screwdriver, pull it out once. Press the start switch and adjust so that the stylus position stops at the 30 cm head-in position.

(Note) The 30 cm head-in adjustments cannot be performed unless the stylus tip position is approximately in the 30 cm lead-in position. In addition, if the screwdriver is left inserted, the arm will not move.

5. Adjusting the 17 cm lead-in position

Adjust as necessary, such as when parts of the sensor section have been replaced.

However, the following procedures should only be used when a discrepancy is found for the 17 cm lead-in position, after the 30 cm lead-in position has been adjusted.

- 1) Set the record size selector to 17 cm.
- 2) By continuously pressing the start switch, the arm will move over and stop. At this time, check now many millimeters, toward the inside or outside, the stylus tip deviates from the required 17 cm lead-in position.
- 3) Take off the bottom cover of the cabinet and check the adjustment scale position of the shutter. (One adjustment scale corresponds to a stylus tip movement of 0.5 mm.)
- 4) Untighten the screw holding the sub shutter and place a small flat-headed screwdriver into the slot of the shutter. When the stylus position is toward the inside, compared to the required position, move the sub shutter toward the right of the scale; when the stylus position is toward the outside, move the sub shutter toward the left. When completed, tentatively tighten the screw holding the sub shutter.
- 5) After the adjustments are made, press the start switch and check whether or not the stylus stops at the 17 cm lead-in position.
- 6) If the stylus stops at the required position, then tighten the sub shutter screw.

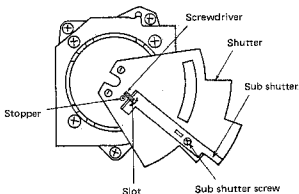

**EXPLANATION HOW THE LSI QUARTZ
PLL MOTOR CONTROL OPERATES**

○ **LSI motor control ... TC9142P**
(33 r.p.m. is set as the standard speed)

- Due to C-MOS construction, handle this IC with extreme care.
- V_{IH} (min.) ... $0.7 \times V_{CC} = 3.5 \text{ V}$
- V_{IL} (max.) ... $0.3 \times V_{CC} = 1.5 \text{ V}$
- In terminals 4, 5, 10, and 11, pull-up resistors are built in.

Terminal 1 : GND

Terminal 2 : OSC OUT (7.68 MHz)

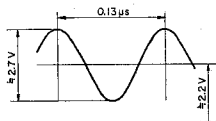

Terminal 3 : OSC IN (7.68 MHz)

Terminal 4 : Internal frequency divider ratio switch
and 5 Terminals 4 and 5 determine the frequency dividing ratio of the internal frequency divider.

Terminal 6 : FG input

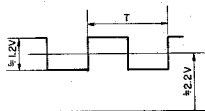

$$T = 1.8 \text{ ms (33 rpm)}$$

$$= 1.33 \text{ ms (45 rpm)}$$

Terminal 7 : APC output (TP-6)
Phase control system output of the motor



Same in either 33 rpm or 45 rpm

Terminal 8 : AFC output
Speed (frequency) control system output of the motor



Same in either 33 rpm or 45 rpm

Terminal 10: 33/45 rpm switch input
L ... 33-1/3 rpm
H ... 45 rpm

Terminal 11: PLAY/STOP input
L ... PLAY
H ... STOP

Terminal 12: Lock detector output
Within locking range ... H
Outside locking range ... L

Terminal 14: Reference frequency input (CR IN)
Connected to terminal 15

Terminal 15: Reference frequency output (CP OUT)
In accordance with the ratio set by terminals 4 and 5, the divided frequency output is obtained.
 $7.68 \times 10^6 \div 4 = 1.92 \text{ MHz (center value)}$
(When terminal 4: H and terminal 5: L)

Terminal 16: Line voltage (V_{CC})
 $V_{CC}: 5 \text{ V} \pm 0.25 \text{ V}$

PARTS LIST OF P.W. BOARD

KU-5260 SERVO CONTROL UNIT

Ref. No.	Part No.	Part Name	Remarks
SEMICONDUCTOR GROUP			
IC4, 5	2620057004	HD7473P	
IC9	2620276005	HD140668P	
IC1	2630271003	TC9142P	
IC2	2630174003	IR3T03	
IC3, 8	2630257001	M5218P	
IC6, 12	2630237005	LA6358	
IC7	2630198005	NJM4556D	
IC10	2630147001	μ PC78M05H	
IC11	2630160004	μ PC7905H	
TR3, 8	2710102005	2SA1015(Y)	
TR1, 2	2730198002	2SC1815(Y)	
4~7			
9~15			
11~5	2760049008	1S2076	
10~17			
D6~9	2780237001	RV06	
TH1	2760311008	THERMISTOR	(1K Ω)
LED1~6	3939219008	GL5EG23	
LED7~9	3939041001	LN81RP-HL	
CDS1, 2	3939053002	CDS	
CDS3	3939053028	CDS (10~15K Ω)	
RESISTOR GROUP			
R15	2410173004	RD14B2H331J	Carbon film 330 Ω 1/4W Variable resistor
VR1, 2	2118024015	V16V20K8502	5K Ω B
VR3~5	2116000073	V08PB203	20K Ω B
CAPACITOR GROUP			
C15, 18, 19 21, 24, 27 3, 50	2531004007	CK45B1H102K	Ceramic 1000PF 50V
C4, 8, 32 35, 36, 38 40, 42, 44 51, 101, 102 107, 108	2531027000	CK45F1H104Z	0.1 μ F 50V
C10, 11	2533603008	CC45SL1H100D	10PF 50V
C12	2533611003	CC45SL1H220J	22PF 50V
C53, 57	2533627000	CC45SL1H101J	100PF 50V
C1, 5 54	2533637003	CC45SL1H271J	270PF 50V
C59 103, 117 C2, 3, 6 14, 17, 20 23, 59, 60 113 C7, 16, 26 33, 37, 48	2544145005 2544146004	CE04W1HR47= CE04W1H010=	Electrolytic 0.47 μ F 50V 1 μ F 50V
	2544132005	CE04W1C100=	10 μ F 16V

Ref. No.	Part No.	Part Name	Remarks
C9	2544128006	CE04W1A220=	22 μ F 10V
C30	2544129005	CE04W1A470=	47 μ F 10V
C29, 31 34, 63	2544130007	CE04W1C101=	100 μ F 16V
C45	2544080005	CE04W=1E102M	1000 μ F 25V
C43	2544086009	CE04W1E222M	2200 μ F 25V Film
C46, 47 58, 105	2551072006	CQ93M1H103K	0.01 μ F 50V
C61	2551121025	CQ93M1H103J	0.01 μ F 50V
C13	2551121096	CQ93M1H393J	0.039 μ F 50V
C52	2551122008	CQ93M1H473J	0.047 μ F 50V
C55, 116	2551122024	CQ93M1H683J	0.068 μ F 50V
OTHER PARTS GROUP			
S1~6	2129218001	TACT SW	
S7	2129180003	PUSH SW	
X1	3989037001	CRYSTAL	7.68 MHZ
	4178028101	HEAT SINK	
	4428030108	VOLUME BRACKET	
*	4428164003	SWITCH BRACKET	
	4438811207	LED HOLDER	
	4438568107	LED HOLDER	

• The carbon resistors rated at 1/4W are not listed herein.

KU-5014 MOTOR DRIVE UNIT

Ref. No.	Part No.	Part Name	Remarks
SEMICONDUCTOR GROUP			
IC201	2630257001	M5218P	
H201, 202	2680042004	H-300A	ORG, PINK
TR202, 204	2710105002	2SA966 (Y)	
TR201, 203	2730201009	2SC2236 (Y)	
D201, 203	2780049008	1S2076	
TH201, 202	2780311008	THERMISTOR (1K Ω)	
RESISTOR GROUP			
VR203, 204	2116000031	V08PB 102 (1K Ω)	
VR201, 202	2116000073	V08PB203 (20K Ω)	
205, 206			
CAPACITOR GROUP			
C205	2531027000	CK45F1H104Z	0.1 μ F 50V
C202	2544015009	CE04W1C100=	10 μ F 16V
C203, 204	2551072006	CQ93M1H103K	0.01 μ F 50V

• The carbon resistors rated at 1/4W are not listed herein.

Remarks symbols in the parts list refer to the following countries and areas.

EA: Australia	E1: Multiple voltage model
EK: United Kingdom	E2: European continent
EU: U.S.A.	EC: Canada

PARTS LIST OF EXPLODED VIEW

Ref. No.	Part No.	Part Name	Remarks
1	4713303016	3x6 CBS	
2	4711303018	3x6 CPS	
3	4751003006	3W	
4	4438545201	COLLER	
5	4638225004	SPRING	
6	4711810019	2x3 CPS	
7	4338241100	SHUTTER	
8	3418025205	MAGNET ASS'Y	
9	4761003009	3E RING	
10	4751005004	4W	
11	3158451003	FRICTION WASHER	
12	4248019202	ADJUST CAM	
13	4733808012	3x12 CBRTS (1)	
14	23989013215	COIL ASS'Y	
15	4338175108	YOKE (A) ASS'Y	
16	3158712108	LATERAL WEIGHT	
17	4744304000	3x3 BSS (D)	
18	4730308012	3x12 CBRTS (1)	
19	4428030108	VOLUME BRACKET	
20	1128085029	VOLUME KNOB	
21	4756133007	14N	
22	3158896215	TOPE ARM ASS'Y	
23	3158899018	BALANCE WEIGHT ASS'Y	
24	3158853037	HEAD SHELL ASS'Y	
25	DL-0065	PICK UP CARTRIDGE	EA, EK, E1
	DL-110M	PICK UP CARTRIDGE	E2
26	4713809003	3x25 CBS	
27	4731806003	3x20 CPTS (1)	
28	2178081030	MOTOR ASS'Y	
29	KU-5060*1	OUTPUT P.C.B.	
30	KU-5060*2	LEAD IN LED P.C.B.	
31	4730355018	3x10 CBRTS	
32	4418846014	WASHER	
33	4418163101	HEAD SUPPORT	
34	3918423008	MAGNETIC HEAD	
35	4700009019	3x6 CPS. W	
36	4730309019	3x16 CBRTS (1)	
37	1468167209	FRAME ASS'Y	E2, EA, EU, EC, EK
	1468167212	FRAME ASS'Y	E1
38	4732309017	3x16 CFTS (1)	
39	4218217306	REC. TURNTABLE	
40	4218288005	RUBBER SHEET	
41	4725207016	2.7x13 COWS	
42	1089099004	BOTTOM COVER	
43	4751106042	WASHER	
44	1048091119	INSULATOR ASS'Y	
45	1048091106	INSULATOR ASS'Y	
46	KU-5260	SERVO CONTROL UNIT	
47	KU-5260*4	POWER SW P.C.B.	
48	4428162209	FIXING BASE	
49	1138184305	KNOB (A)	
50	1138185207	KNOB (B)	
51	4438158096	COLLAR	

Ref. No.	Part No.	Part Name	Remarks
52	1298010005	CUSHION RUBBER	
53	2339045213	POWER TRANS	E2, EA, EK
	2339048112	POWER TRANS	EU
	2339046212	POWER TRANS	E1
	2339072219	POWER TRANS	EU
54	1018416300	CABINET ASS'Y	
55	4148201000	SHEET	
56	1038288302	CONTROL FRAME	
57	1038260109	PANEL FRAME	
58	1468151118	DUST COVER ASS'Y	
59	4628023009	BUSHING	
60	4018041015	HINGE	
61	MD-3802	BUSHING	
	MD-2942H	CORD BUSH	EA only
62	2062002031	AC CORD	E2
	2062019006	AC CORD	EC, EU
	2062010028	AC CORD	E1
	2062024006	AC CORD	EK
	2006019307	AS-3P AC CORD	EA
63	EP-7376	CORD BUSH	
64	2033642103	OUTPUT CORD ASS'Y	
	2031640000	OUTPUT CORD ASS'Y	EU only
65	4338243001	SUB SHUTTER	
66	4733811009	3x25 CBRTS (2)	
67	4428184003	SWITCH BRACKET	
68	1138188002	KNOB	
69	4318086000	FRICTION SHEET	
71	3158911116	ARM REST ASS'Y	
72	EP-4772	CORD HOLDER	
73	4438813001	SPACER	
74	4148181007	SHILD SHEET	
75	4712306014	3x12 CFS	
76	4730304014	3x8 CBRTS (1)	
77	2123815033	VOLTAGE SELECTOR	E1
79	4730204017	2.6x8 CBRTS (1)	E1

WARNING:

Parts marked with  and/or shading have special characteristics important to safety. Be sure to use the specified parts for replacement.

PACKING AND ACCESSORIES GROUP

Ref. No.	Part No.	Part Name	Remarks
	5038056006	PACKING ASS'Y	
	5038056005	PACKING (L)	
	5038057004	PACKING (R)	
	5298006002	45 ADAPTOR	
	5118289007	INSTRUCTION MANUAL	
	2033687007	PLUG ADAPTOR	E1
	3158847001	SHELL ACCESSORY ASS'Y	EU, EC
	5018836017	CARTON CASE	
	5028151004	BOTTOM PLATE	
	5028121005	PROTECTION PLATE	
	5028152003	UPPER PLATE	
	5058006006	ENVELOPE	80x100
	5298041106	OVERHANG GAUGE	

EXPLODED VIEW

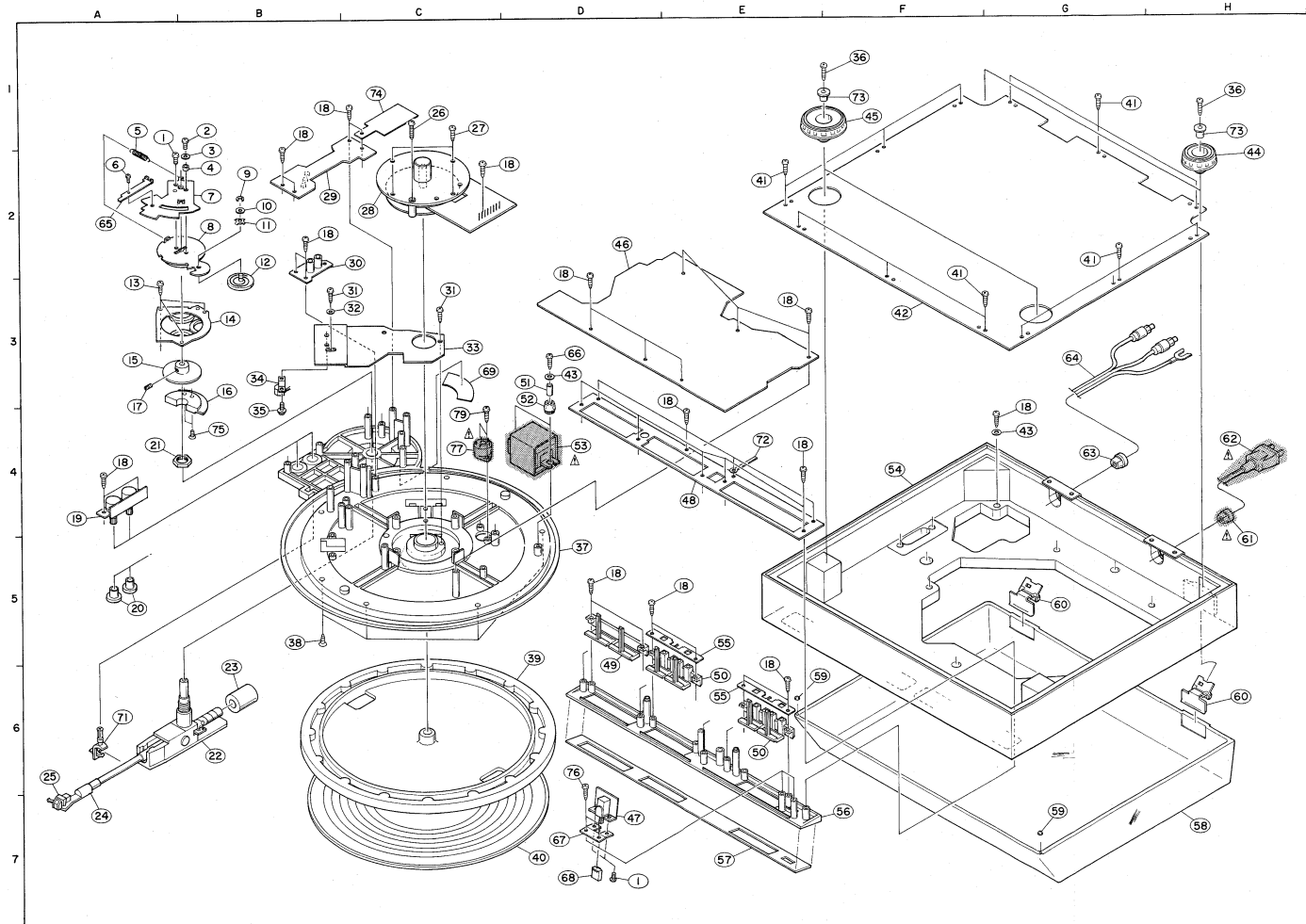

SCHEMATIC DIAGRAM

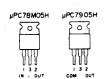
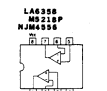
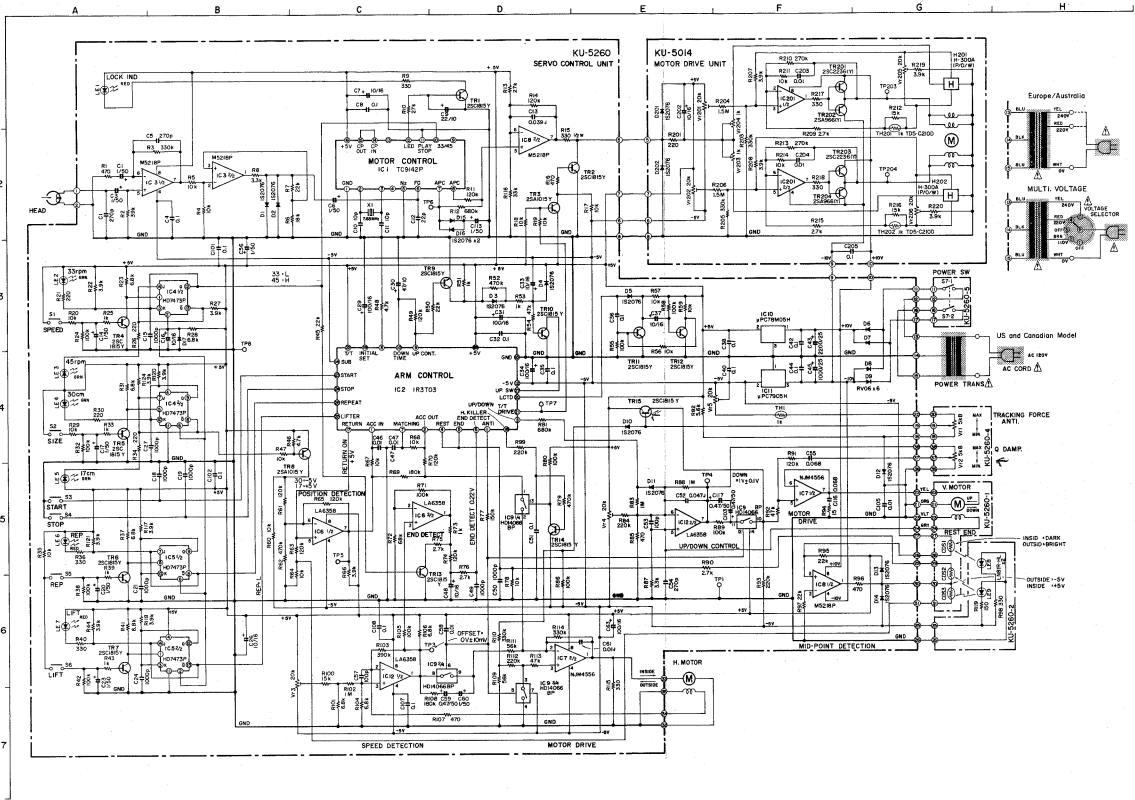

28A966
28A105
28C1115
28C2235

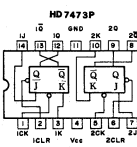
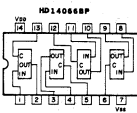
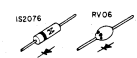

- Note:**
- Resistance shall be 1/4W unless otherwise specified and the unit is Ω.
 - The unit of capacitor is μF, P is pF unless otherwise specified.
 - This circuit diagram shows the basic circuit. It is subject to change for the purpose of improvement.
 - Parts marked with Δ are of importance in respect to the safety, use the specified type without fail.

CONNECTIONS OF P.W. BOARD

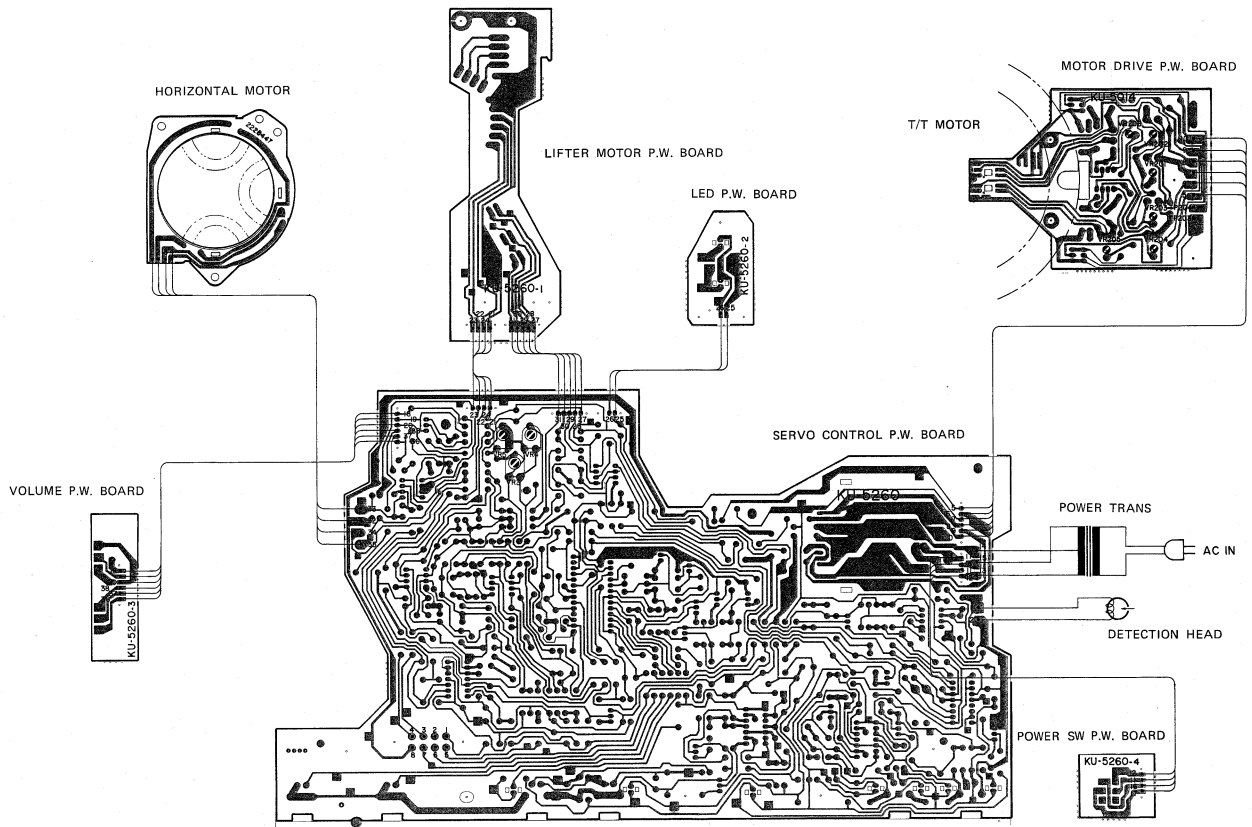

P.W. BOARD OF KU-5260 SERVO CONTROL UNIT

